

ENDC

26A-n41A												
BW (MHz)	SCS (kHz)	Modulation		RB allocation	RB Size	RB Offset	Conducted Output Power					
							512004 (2 560.02 MHz)		520002 (2 600.01 MHz)		528000 (2 640.00 MHz)	
							(dB m)	(W)	(dB m)	(W)	(dB m)	(W)
30	30	DFT-S OFDM	BPSK	Inner_1RB	1	1	22.67	0.185	23.30	0.214	22.92	0.196
			QPSK	Left	1	1	22.59	0.182	23.21	0.209	22.99	0.199
			BPSK	Inner_1RB	1	271	22.76	0.189	23.07	0.203	22.78	0.190
			QPSK	Right	1	271	22.71	0.187	23.05	0.202	22.71	0.187
2A-n77A-Low Band												
BW (MHz)	SCS (kHz)	Modulation		RB allocation	RB Size	RB Offset	Conducted Output Power					
							630668 (3 460.02 MHz)		633334 (3 500.01 MHz)		636000 (3 540.00 MHz)	
							(dB m)	(W)	(dB m)	(W)	(dB m)	(W)
20	30	DFT-S OFDM	BPSK	Inner_1RB	1	1	23.15	0.207	23.12	0.205	23.02	0.200
			QPSK	Left	1	1	23.18	0.208	23.07	0.203	23.07	0.203
			BPSK	Inner_1RB	1	271	23.06	0.202	23.01	0.200	23.15	0.207
			QPSK	Right	1	271	23.09	0.204	23.03	0.201	23.11	0.205
5A-n77A-Low Band												
BW (MHz)	SCS (kHz)	Modulation		RB allocation	RB Size	RB Offset	Conducted Output Power					
							630668 (3 460.02 MHz)		633334 (3 500.01 MHz)		636000 (3 540.00 MHz)	
							(dB m)	(W)	(dB m)	(W)	(dB m)	(W)
20	30	DFT-S OFDM	BPSK	Inner_1RB	1	1	23.34	0.216	23.55	0.226	23.39	0.218
			QPSK	Left	1	1	23.37	0.217	23.44	0.221	23.43	0.220
			BPSK	Inner_1RB	1	271	23.27	0.212	23.31	0.214	23.41	0.219
			QPSK	Right	1	271	23.35	0.216	23.39	0.218	23.35	0.216

13A-n77A-Low Band												
BW (MHz)	SCS (kHz)	Modulation		RB allocation	RB Size	RB Offset	Conducted Output Power					
							630668 (3 460.02 MHz)		633334 (3 500.01 MHz)		636000 (3 540.00 MHz)	
							(dB m)	(W)	(dB m)	(W)	(dB m)	(W)
20	30	DFT-S OFDM	BPSK	Inner_1RB	1	1	23.15	0.207	23.14	0.206	23.33	0.215
			QPSK	Left	1	1	23.19	0.208	23.15	0.207	23.15	0.207
			BPSK	Inner_1RB	1	271	23.16	0.207	23.07	0.203	23.17	0.207
			QPSK	Right	1	271	23.07	0.203	23.05	0.202	23.05	0.202
41A-n77A-Low Band												
BW (MHz)	SCS (kHz)	Modulation		RB allocation	RB Size	RB Offset	Conducted Output Power					
							630668 (3 460.02 MHz)		633334 (3 500.01 MHz)		636000 (3 540.00 MHz)	
							(dB m)	(W)	(dB m)	(W)	(dB m)	(W)
20	30	DFT-S OFDM	BPSK	Inner_1RB	1	1	23.03	0.201	23.16	0.207	23.19	0.208
			QPSK	Left	1	1	23.15	0.207	23.18	0.208	23.20	0.209
			BPSK	Inner_1RB	1	271	23.11	0.205	23.06	0.202	23.05	0.202
			QPSK	Right	1	271	23.09	0.204	23.11	0.205	23.08	0.203
66A-n77A-Low Band												
BW (MHz)	SCS (kHz)	Modulation		RB allocation	RB Size	RB Offset	Conducted Output Power					
							630668 (3 460.02 MHz)		633334 (3 500.01 MHz)		636000 (3 540.00 MHz)	
							(dB m)	(W)	(dB m)	(W)	(dB m)	(W)
20	30	DFT-S OFDM	BPSK	Inner_1RB	1	1	23.26	0.212	23.01	0.200	23.14	0.206
			QPSK	Left	1	1	23.24	0.211	22.98	0.199	22.94	0.197
			BPSK	Inner_1RB	1	271	23.08	0.203	23.19	0.208	22.98	0.199
			QPSK	Right	1	271	23.17	0.207	23.13	0.206	23.09	0.204

2A-n78A-Low Band												
BW (MHz)	SCS (kHz)	Modulation	RB allocation	RB Size	RB Offset	Conducted Output Power						
						630668 (3 460.02 MHz)		633334 (3 500.01 MHz)		636000 (3 540.00 MHz)		
						(dB m)	(W)	(dB m)	(W)	(dB m)	(W)	
20	30	DFT-S OFDM	BPSK	Inner_1RB	1	1	23.11	0.205	23.21	0.209	22.98	0.199
			QPSK	Left	1	1	23.01	0.200	23.19	0.208	23.15	0.207
			BPSK	Inner_1RB	1	49	23.05	0.202	23.15	0.207	23.15	0.207
			QPSK	Right	1	49	23.12	0.205	23.17	0.207	23.01	0.200
5A-n78A-Low Band												
BW (MHz)	SCS (kHz)	Modulation	RB allocation	RB Size	RB Offset	Conducted Output Power						
						630668 (3 460.02 MHz)		633334 (3 500.01 MHz)		636000 (3 540.00 MHz)		
						(dB m)	(W)	(dB m)	(W)	(dB m)	(W)	
20	30	DFT-S OFDM	BPSK	Inner_1RB	1	1	23.15	0.207	23.47	0.222	23.15	0.207
			QPSK	Left	1	1	23.25	0.211	23.43	0.220	23.21	0.209
			BPSK	Inner_1RB	1	49	23.17	0.207	23.15	0.207	23.25	0.211
			QPSK	Right	1	49	23.11	0.205	23.23	0.210	23.08	0.203
7A-n78A-Low Band												
BW (MHz)	SCS (kHz)	Modulation	RB allocation	RB Size	RB Offset	Conducted Output Power						
						630668 (3 460.02 MHz)		633334 (3 500.01 MHz)		636000 (3 540.00 MHz)		
						(dB m)	(W)	(dB m)	(W)	(dB m)	(W)	
20	30	DFT-S OFDM	BPSK	Inner_1RB	1	1	23.08	0.203	23.33	0.215	23.17	0.207
			QPSK	Left	1	1	23.15	0.207	23.31	0.214	23.20	0.209
			BPSK	Inner_1RB	1	49	23.22	0.210	23.05	0.202	23.24	0.211
			QPSK	Right	1	49	23.29	0.213	23.15	0.207	23.21	0.209
12A-n78A-Low Band												
BW (MHz)	SCS (kHz)	Modulation	RB allocation	RB Size	RB Offset	Conducted Output Power						
						630668 (3 460.02 MHz)		633334 (3 500.01 MHz)		636000 (3 540.00 MHz)		
						(dB m)	(W)	(dB m)	(W)	(dB m)	(W)	
20	30	DFT-S OFDM	BPSK	Inner_1RB	1	1	23.09	0.204	23.25	0.211	23.08	0.203
			QPSK	Left	1	1	23.11	0.205	23.22	0.210	23.19	0.208
			BPSK	Inner_1RB	1	49	23.18	0.208	23.19	0.208	23.21	0.209
			QPSK	Right	1	49	23.21	0.209	23.14	0.206	23.16	0.207
26A-n78A-Low Band												
BW (MHz)	SCS (kHz)	Modulation	RB allocation	RB Size	RB Offset	Conducted Output Power						
						630668 (3 460.02 MHz)		633334 (3 500.01 MHz)		636000 (3 540.00 MHz)		
						(dB m)	(W)	(dB m)	(W)	(dB m)	(W)	
20	30	DFT-S OFDM	BPSK	Inner_1RB	1	1	23.25	0.211	23.12	0.205	23.04	0.201
			QPSK	Left	1	1	23.15	0.207	23.09	0.204	23.05	0.202
			BPSK	Inner_1RB	1	49	22.98	0.199	23.03	0.201	23.11	0.205
			QPSK	Right	1	49	23.01	0.200	23.11	0.205	23.13	0.206
41A-n78A-Low Band												
BW (MHz)	SCS (kHz)	Modulation	RB allocation	RB Size	RB Offset	Conducted Output Power						
						630668 (3 460.02 MHz)		633334 (3 500.01 MHz)		636000 (3 540.00 MHz)		
						(dB m)	(W)	(dB m)	(W)	(dB m)	(W)	
20	30	DFT-S OFDM	BPSK	Inner_1RB	1	1	22.79	0.190	23.15	0.207	23.24	0.211
			QPSK	Left	1	1	22.99	0.199	23.03	0.201	23.21	0.209
			BPSK	Inner_1RB	1	49	23.01	0.200	23.05	0.202	23.05	0.202
			QPSK	Right	1	49	23.11	0.205	23.14	0.206	23.08	0.203
66A-n78A-Low Band												
BW (MHz)	SCS (kHz)	Modulation	RB allocation	RB Size	RB Offset	Conducted Output Power						
						630668 (3 460.02 MHz)		633334 (3 500.01 MHz)		636000 (3 540.00 MHz)		
						(dB m)	(W)	(dB m)	(W)	(dB m)	(W)	
20	30	DFT-S OFDM	BPSK	Inner_1RB	1	1	23.18	0.208	23.29	0.213	23.11	0.205
			QPSK	Left	1	1	23.20	0.209	23.21	0.209	23.14	0.206
			BPSK	Inner_1RB	1	49	23.19	0.208	23.17	0.207	23.15	0.207
			QPSK	Right	1	49	23.08	0.203	23.13	0.206	23.19	0.208

2A-n77A-High Band												
BW (MHz)	SCS (kHz)	Modulation		RB allocation	RB Size	RB Offset	Conducted Output Power					
							647334 (3 710.01 MHz)		656000 (3 840.00 MHz)		664666 (3 969.99 MHz)	
							(dB m)	(W)	(dB m)	(W)	(dB m)	(W)
20	30	DFT-S OFDM	BPSK	Inner_1RB	1	1	23.01	0.200	22.89	0.195	22.91	0.195
			QPSK	Left	1	1	22.86	0.193	22.75	0.188	22.75	0.188
			BPSK	Inner_1RB	1	49	22.71	0.187	22.81	0.191	22.65	0.184
			QPSK	Right	1	49	22.69	0.186	22.77	0.189	22.46	0.176
5A-n77A-High Band												
BW (MHz)	SCS (kHz)	Modulation		RB allocation	RB Size	RB Offset	Conducted Output Power					
							647334 (3 710.01 MHz)		656000 (3 840.00 MHz)		664666 (3 969.99 MHz)	
							(dB m)	(W)	(dB m)	(W)	(dB m)	(W)
20	30	DFT-S OFDM	BPSK	Inner_1RB	1	1	23.29	0.213	22.95	0.197	22.69	0.186
			QPSK	Left	1	1	23.18	0.208	22.91	0.195	22.69	0.186
			BPSK	Inner_1RB	1	49	23.15	0.207	22.99	0.199	22.68	0.185
			QPSK	Right	1	49	23.05	0.202	22.81	0.191	22.61	0.182
13A-n77A-High Band												
BW (MHz)	SCS (kHz)	Modulation		RB allocation	RB Size	RB Offset	Conducted Output Power					
							647334 (3 710.01 MHz)		656000 (3 840.00 MHz)		664666 (3 969.99 MHz)	
							(dB m)	(W)	(dB m)	(W)	(dB m)	(W)
20	30	DFT-S OFDM	BPSK	Inner_1RB	1	1	22.98	0.199	22.94	0.197	22.93	0.196
			QPSK	Left	1	1	22.92	0.196	22.84	0.192	22.79	0.190
			BPSK	Inner_1RB	1	49	22.95	0.197	22.90	0.195	22.74	0.188
			QPSK	Right	1	49	22.90	0.195	22.90	0.195	22.73	0.187
41A-n77A-High Band												
BW (MHz)	SCS (kHz)	Modulation		RB allocation	RB Size	RB Offset	Conducted Output Power					
							647334 (3 710.01 MHz)		656000 (3 840.00 MHz)		664666 (3 969.99 MHz)	
							(dB m)	(W)	(dB m)	(W)	(dB m)	(W)
20	30	DFT-S OFDM	BPSK	Inner_1RB	1	1	23.09	0.204	22.78	0.190	22.95	0.197
			QPSK	Left	1	1	23.04	0.201	22.76	0.189	22.76	0.189
			BPSK	Inner_1RB	1	49	22.97	0.198	22.97	0.198	22.97	0.198
			QPSK	Right	1	49	22.92	0.196	22.98	0.199	22.90	0.195
66A-n77A-High Band												
BW (MHz)	SCS (kHz)	Modulation		RB allocation	RB Size	RB Offset	Conducted Output Power					
							647334 (3 710.01 MHz)		656000 (3 840.00 MHz)		664666 (3 969.99 MHz)	
							(dB m)	(W)	(dB m)	(W)	(dB m)	(W)
20	30	DFT-S OFDM	BPSK	Inner_1RB	1	1	23.05	0.202	22.90	0.195	22.77	0.189
			QPSK	Left	1	1	23.01	0.200	22.82	0.191	22.71	0.187
			BPSK	Inner_1RB	1	49	22.65	0.184	22.88	0.194	22.69	0.186
			QPSK	Right	1	49	22.71	0.187	22.81	0.191	22.99	0.199

2A-n78A-High Band												
BW (MHz)	SCS (kHz)	Modulation		RB allocation	RB Size	RB Offset	Conducted Output Power					
							647334 (3 710.01 MHz)		650000 (3 750.00 MHz)		652666 (3 789.99 MHz)	
							(dB m)	(W)	(dB m)	(W)	(dB m)	(W)
20	30	DFT-S OFDM	BPSK	Inner_1RB	1	1	22.88	0.194	22.66	0.185	22.61	0.182
			QPSK	Left	1	1	22.79	0.190	22.35	0.172	22.50	0.178
			BPSK	Inner_1RB	1	49	22.61	0.182	22.52	0.179	22.51	0.178
			QPSK	Right	1	49	22.71	0.187	22.41	0.174	22.35	0.172
5A-n78A-High Band												
BW (MHz)	SCS (kHz)	Modulation		RB allocation	RB Size	RB Offset	Conducted Output Power					
							647334 (3 710.01 MHz)		650000 (3 750.00 MHz)		652666 (3 789.99 MHz)	
							(dB m)	(W)	(dB m)	(W)	(dB m)	(W)
20	30	DFT-S OFDM	BPSK	Inner_1RB	1	1	22.95	0.197	22.81	0.191	22.85	0.193
			QPSK	Left	1	1	22.91	0.195	22.77	0.189	22.71	0.187
			BPSK	Inner_1RB	1	49	22.75	0.188	22.85	0.193	22.88	0.194
			QPSK	Right	1	49	22.79	0.190	22.84	0.192	22.75	0.188
7A-n78A-High Band												
BW (MHz)	SCS (kHz)	Modulation		RB allocation	RB Size	RB Offset	Conducted Output Power					
							647334 (3 710.01 MHz)		650000 (3 750.00 MHz)		652666 (3 789.99 MHz)	
							(dB m)	(W)	(dB m)	(W)	(dB m)	(W)
20	30	DFT-S OFDM	BPSK	Inner_1RB	1	1	22.86	0.193	22.75	0.188	22.95	0.197
			QPSK	Left	1	1	22.75	0.188	22.77	0.189	22.77	0.189
			BPSK	Inner_1RB	1	49	22.71	0.187	22.85	0.193	22.61	0.182
			QPSK	Right	1	49	22.85	0.193	22.52	0.179	22.52	0.179
12A-n78A-High Band												
BW (MHz)	SCS (kHz)	Modulation		RB allocation	RB Size	RB Offset	Conducted Output Power					
							647334 (3 710.01 MHz)		650000 (3 750.00 MHz)		652666 (3 789.99 MHz)	
							(dB m)	(W)	(dB m)	(W)	(dB m)	(W)
20	30	DFT-S OFDM	BPSK	Inner_1RB	1	1	22.75	0.188	22.85	0.193	22.55	0.180
			QPSK	Left	1	1	22.70	0.186	22.75	0.188	22.65	0.184
			BPSK	Inner_1RB	1	49	22.75	0.188	22.61	0.182	22.61	0.182
			QPSK	Right	1	49	22.71	0.187	22.69	0.186	22.58	0.181
26A-n78A-High Band												
BW (MHz)	SCS (kHz)	Modulation		RB allocation	RB Size	RB Offset	Conducted Output Power					
							647334 (3 710.01 MHz)		650000 (3 750.00 MHz)		652666 (3 789.99 MHz)	
							(dB m)	(W)	(dB m)	(W)	(dB m)	(W)
20	30	DFT-S OFDM	BPSK	Inner_1RB	1	1	22.72	0.187	22.93	0.196	22.45	0.176
			QPSK	Left	1	1	22.57	0.181	22.73	0.187	22.52	0.179
			BPSK	Inner_1RB	1	49	22.79	0.190	22.73	0.187	22.44	0.175
			QPSK	Right	1	49	22.65	0.184	22.62	0.183	22.51	0.178
41A-n78A-High Band												
BW (MHz)	SCS (kHz)	Modulation		RB allocation	RB Size	RB Offset	Conducted Output Power					
							647334 (3 710.01 MHz)		650000 (3 750.00 MHz)		652666 (3 789.99 MHz)	
							(dB m)	(W)	(dB m)	(W)	(dB m)	(W)
20	30	DFT-S OFDM	BPSK	Inner_1RB	1	1	22.78	0.190	22.81	0.191	22.46	0.176
			QPSK	Left	1	1	22.65	0.184	22.73	0.187	22.45	0.176
			BPSK	Inner_1RB	1	49	22.51	0.178	22.71	0.187	22.71	0.187
			QPSK	Right	1	49	22.71	0.187	22.61	0.182	22.55	0.180
66A-n78A-High Band												
BW (MHz)	SCS (kHz)	Modulation		RB allocation	RB Size	RB Offset	Conducted Output Power					
							647334 (3 710.01 MHz)		650000 (3 750.00 MHz)		652666 (3 789.99 MHz)	
							(dB m)	(W)	(dB m)	(W)	(dB m)	(W)
20	30	DFT-S OFDM	BPSK	Inner_1RB	1	1	22.65	0.184	22.55	0.180	22.82	0.191
			QPSK	Left	1	1	22.61	0.182	22.52	0.179	22.61	0.182
			BPSK	Inner_1RB	1	49	22.55	0.180	22.45	0.176	22.55	0.180
			QPSK	Right	1	49	22.44	0.175	22.41	0.174	22.41	0.174

Note ;

The ENDC combination were compared at the bandwidth of the worst output of the SA mode.

4. Occupied Bandwidth

4.1. Limit

CFR 47, Section FCC §2.1049.

4.2. Test Procedure

The test follows section 5.4.4 of ANSI C63.26-2015.

- a. The spectrum analyzer center frequency is set to the nominal EUT channel center frequency. The frequency span for the spectrum analyzer shall be set wide enough to capture all modulation. products including the emission skirts (typically a span of $1.5 \times \text{OBW}$ is sufficient).
- b. The nominal IF filter 3 dB bandwidth (RBW) shall be in the range of 1 % to 5 % of the anticipated OBW, and the VBW shall be set $\geq 3 \times \text{RBW}$.
- c. Set the reference level of the instrument as required to prevent the signal amplitude from exceeding the maximum spectrum analyzer input mixer level for linear operation. See guidance provided in 4.2.3.
- d. Set the detection mode to peak, and the trace mode to max-hold.
- e. If the instrument does not have a 99 % OBW function, recover the trace data points and sum directly in linear power terms. Place the recovered amplitude data points, beginning at the lowest frequency, in a running sum until 0.5 % of the total is reached. Record that frequency as the lower OBW frequency. Repeat the process until 99.5 % of the total is reached and record that frequency as the upper OBW frequency. The 99 % power OBW can be determined by computing the difference these two frequencies.
- f. The OBW shall be reported and plot(s) of the measuring instrument display shall be provided with the test report. The frequency and amplitude axis and scale shall be clearly labeled. Tabular data can be reported in addition to the plot(s).

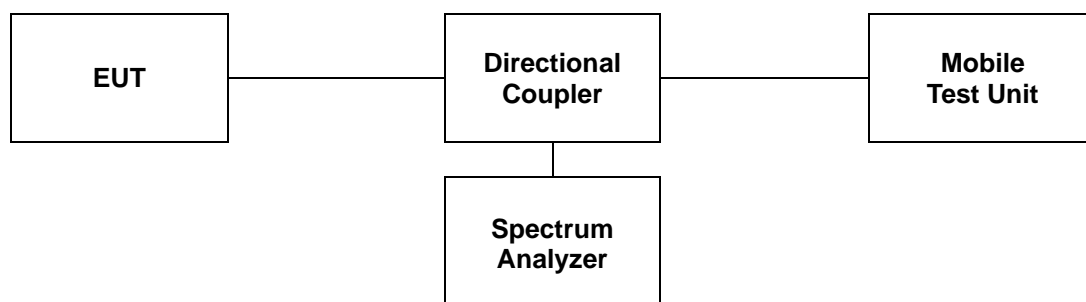

4.3 Test Results

Ambient temperature : (23 ± 1) °C
 Relative humidity : 47 % R.H.

Band	SCS (kHz)	BW (MHz)	Frequency (MHz)	Occupied Bandwidth (MHz)				
				DFT-S-OFDM BPSK	DFT-S-OFDM QPSK	DFT-S-OFDM 16QAM	CP-OFDM QPSK	CP-OFDM 16QAM
41	30	20	2 592.99	17.902	17.862	17.942	18.222	18.302
		30		26.793	26.853	26.853	27.512	27.512
		40		35.884	35.804	35.804	37.962	37.962
		50		45.754	45.754	45.754	47.552	47.552
		60		57.902	57.782	58.022	58.142	58.022
		70		64.336	64.336	64.336	67.413	67.552
		80		77.203	77.043	77.203	77.682	77.682
		90		86.673	86.853	86.853	87.393	87.572
		100		96.503	96.503	96.503	97.502	97.502
Band	SCS (kHz)	BW (MHz)	Frequency (MHz)	Occupied Bandwidth (MHz)				
				DFT-S-OFDM BPSK	DFT-S-OFDM QPSK	DFT-S-OFDM 16QAM	CP-OFDM QPSK	CP-OFDM 16QAM
77/78 Low-Band	30	20	3 500.01	17.862	17.902	17.902	18.222	18.222
		30		26.853	26.853	26.853	27.572	27.512
		40		35.804	35.724	35.804	37.962	37.962
		50		45.754	45.754	45.754	47.453	47.552
		60		58.022	58.022	58.142	58.022	58.022
		70		64.476	64.336	64.476	67.692	67.692
		80		77.203	77.043	77.203	77.682	77.682
		90		86.853	86.673	86.853	87.572	87.572
		100		96.304	96.503	96.304	96.503	97.702
Band	SCS (kHz)	BW (MHz)	Frequency (MHz)	Occupied Bandwidth (MHz)				
				DFT-S-OFDM BPSK	DFT-S-OFDM QPSK	DFT-S-OFDM 16QAM	CP-OFDM QPSK	CP-OFDM 16QAM
77/78 High-Band	30	20	3 840.00	17.862	17.862	17.902	18.262	18.182
		30		26.793	26.853	26.793	27.572	27.512
		40		35.804	35.804	35.804	37.802	37.962
		50		45.654	45.754	45.654	47.453	47.453
		60		58.142	58.022	58.022	57.902	58.022
		70		64.476	64.336	64.476	67.692	67.692
		80		77.043	77.203	77.043	77.522	77.682
		90		86.853	86.673	87.033	87.752	87.572
		100		96.304	96.503	96.304	97.702	97.702

- Test plots

NR band 41

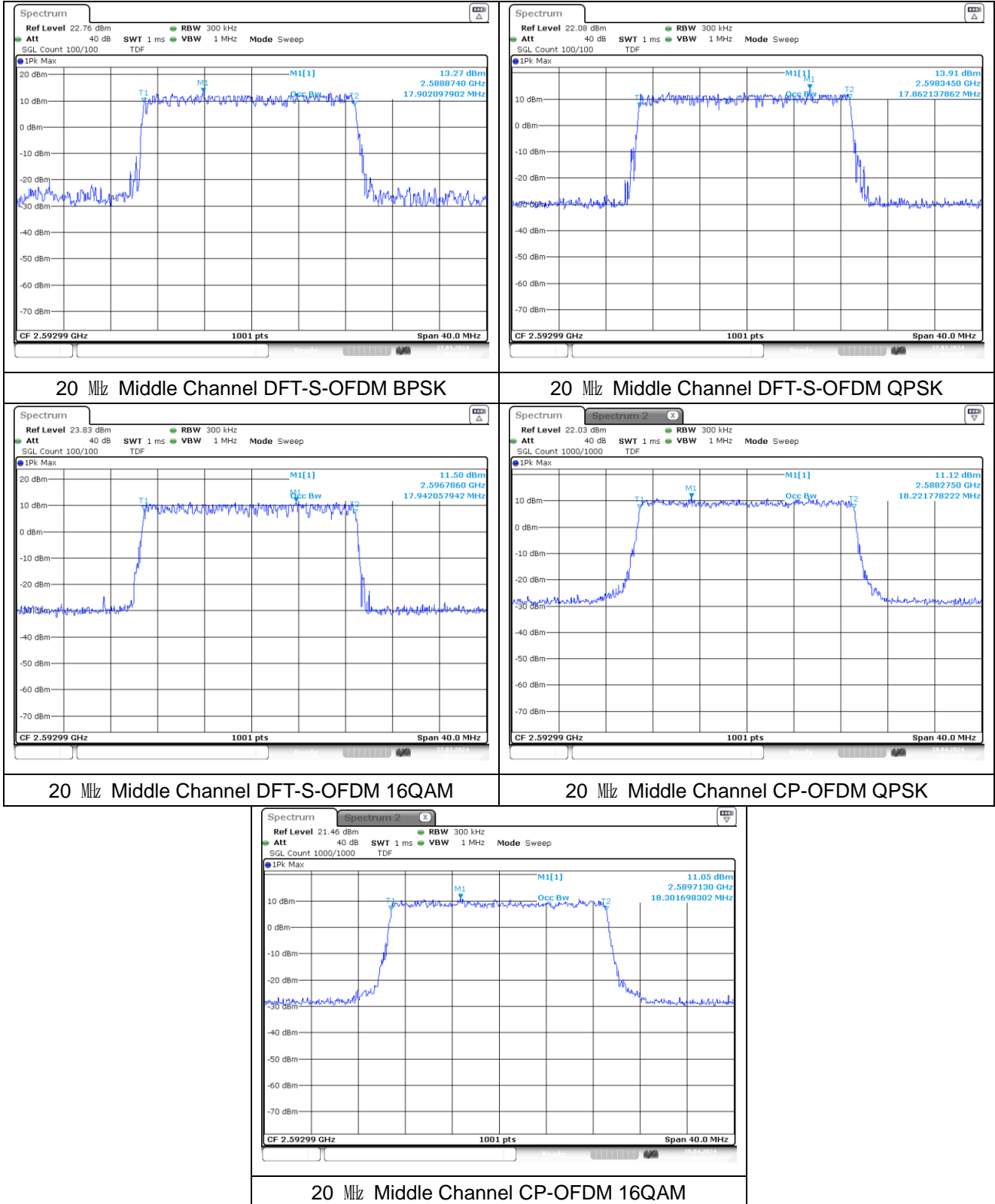

NR band 41

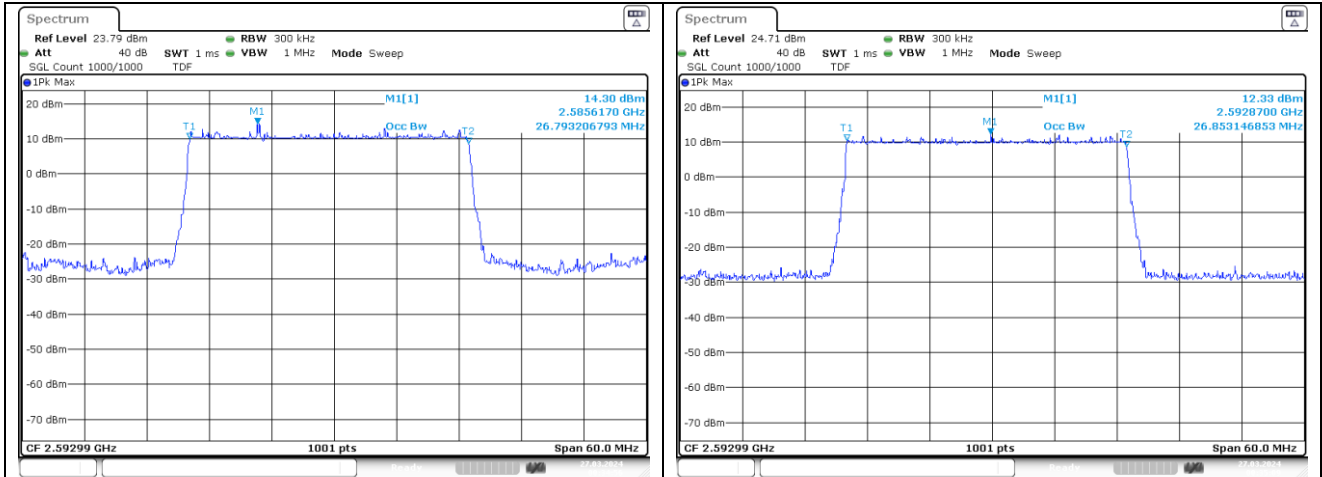

30 MHz Middle Channel DFT-S-OFDM BPSK

30 MHz Middle Channel DFT-S-OFDM QPSK

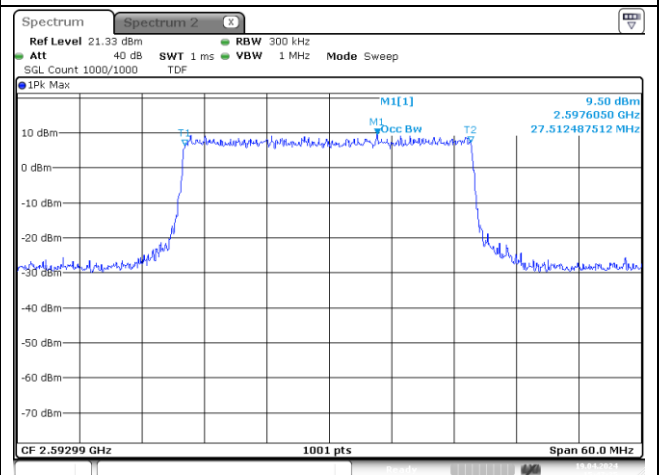
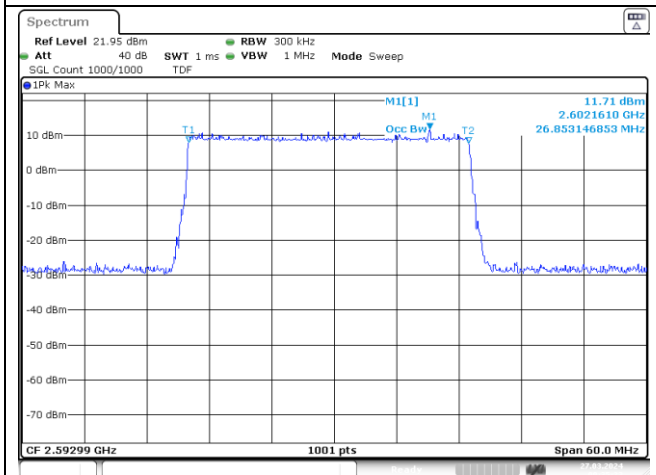

30 MHz Middle Channel DFT-S-OFDM 16QAM

30 MHz Middle Channel CP-OFDM QPSK

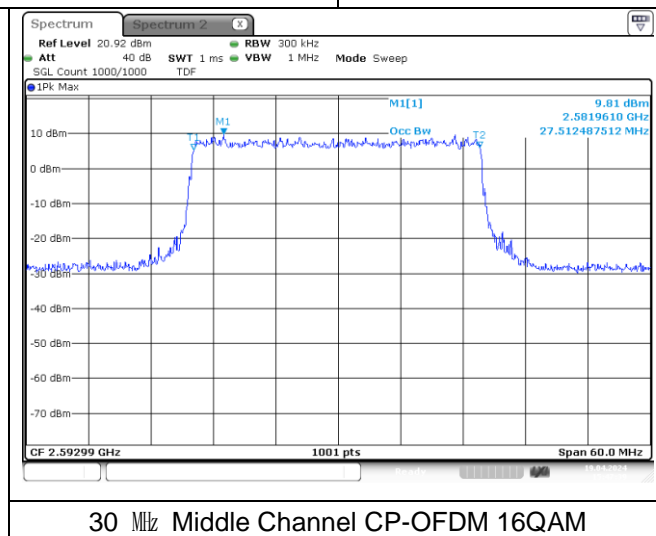

30 MHz Middle Channel CP-OFDM 16QAM

NR band 41

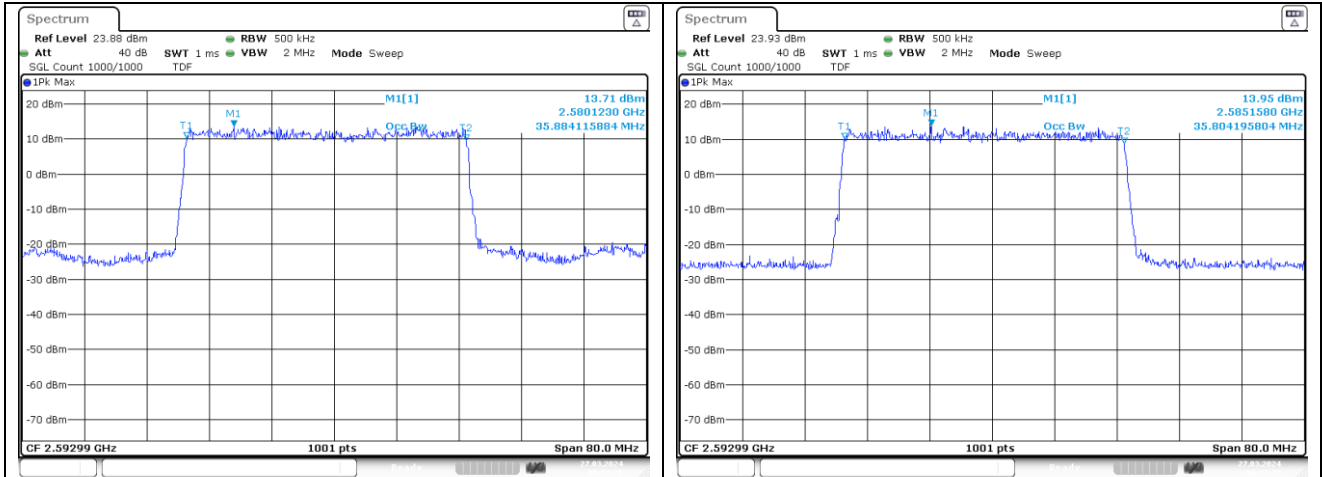

40 MHz Middle Channel DFT-S-OFDM BPSK

40 MHz Middle Channel DFT-S-OFDM QPSK

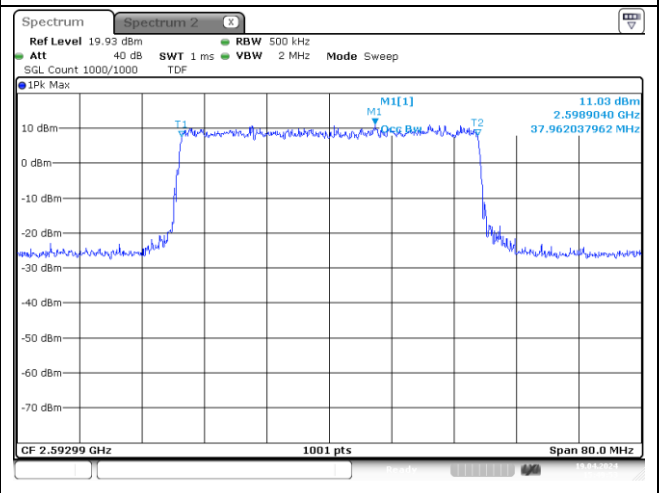
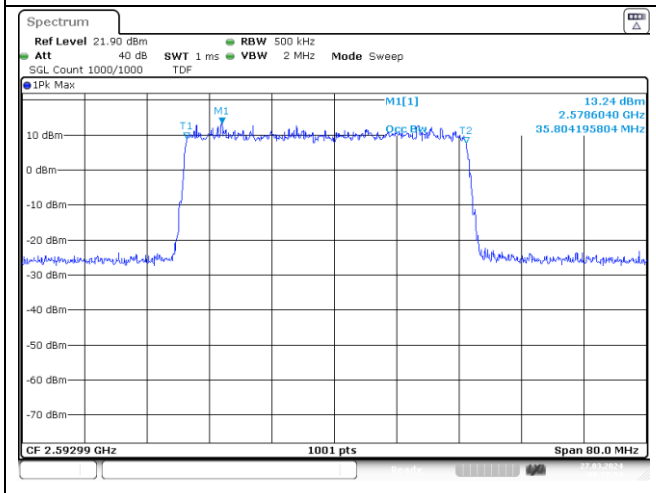

40 MHz Middle Channel DFT-S-OFDM 16QAM

40 MHz Middle Channel CP-OFDM QPSK

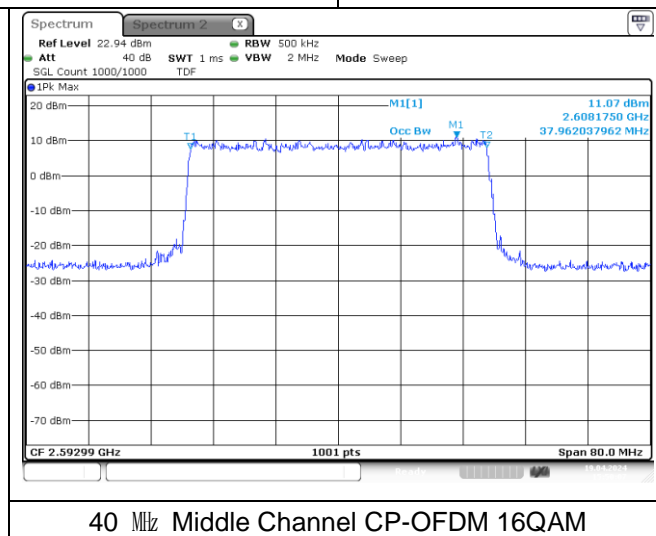

40 MHz Middle Channel CP-OFDM 16QAM

NR band 41

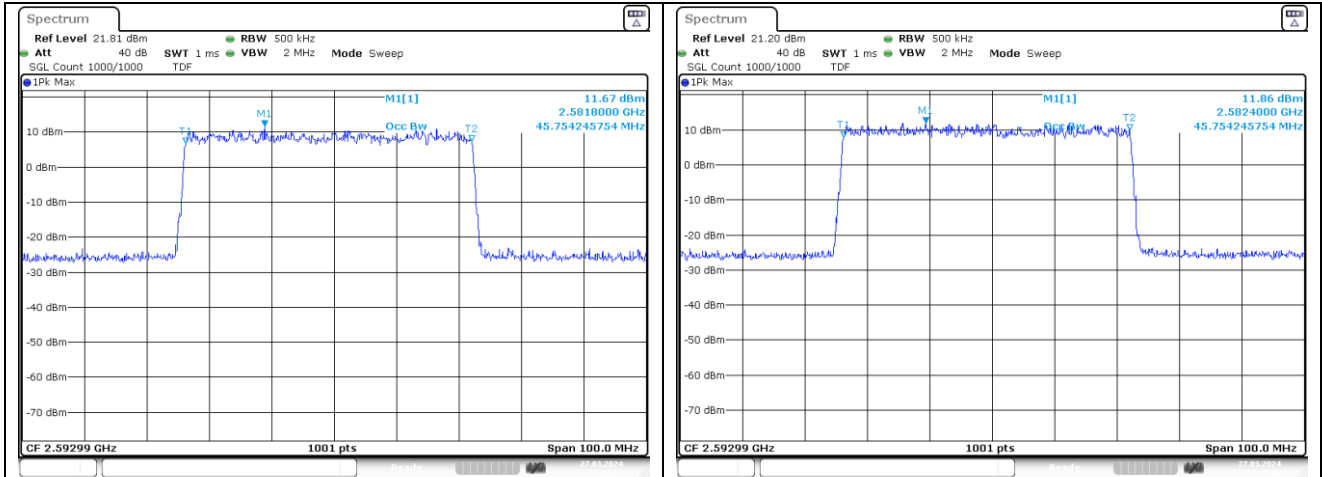

50 MHz Middle Channel DFT-S-OFDM BPSK

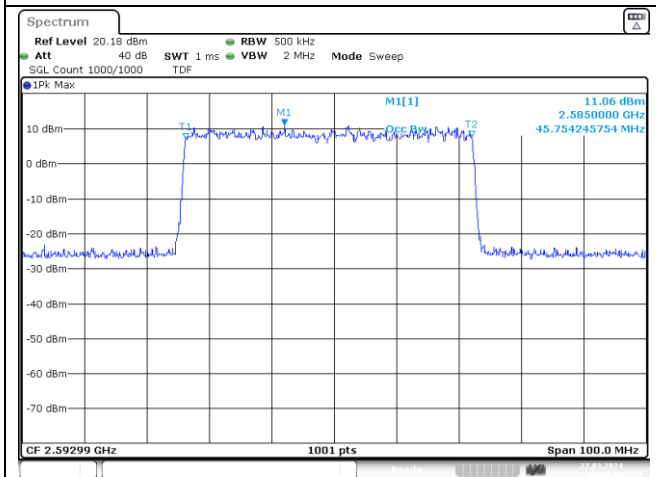

50 MHz Middle Channel DFT-S-OFDM QPSK

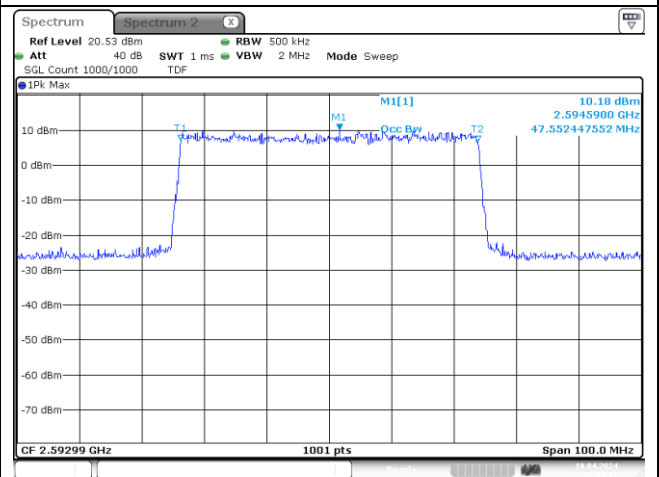

50 MHz Middle Channel DFT-S-OFDM 16QAM

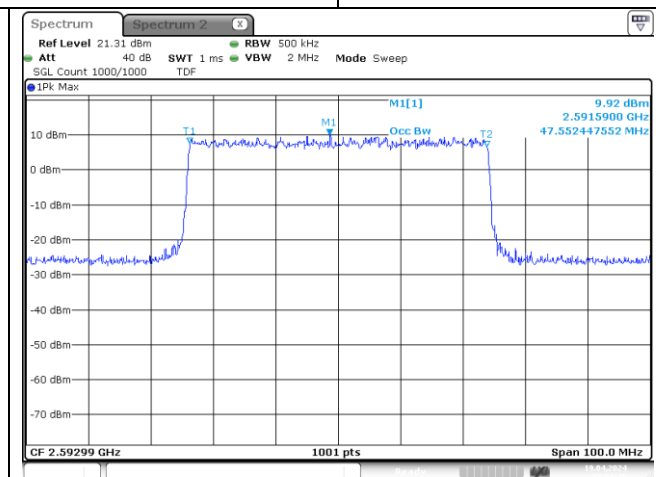

50 MHz Middle Channel CP-OFDM QPSK

50 MHz Middle Channel CP-OFDM 16QAM

NR band 41

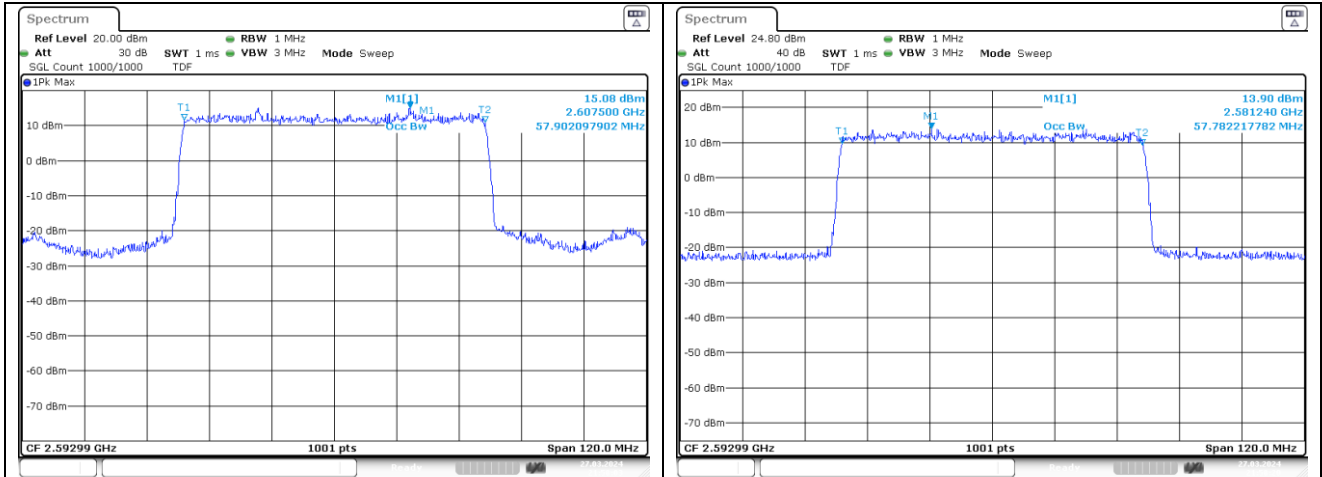

60 MHz Middle Channel DFT-S-OFDM BPSK

60 MHz Middle Channel DFT-S-OFDM QPSK

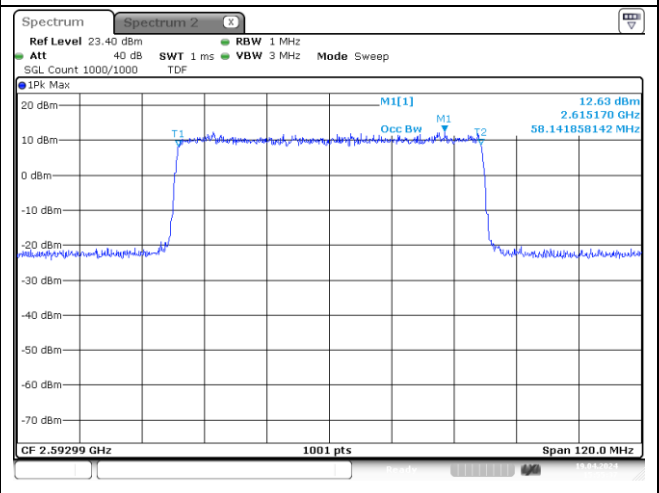
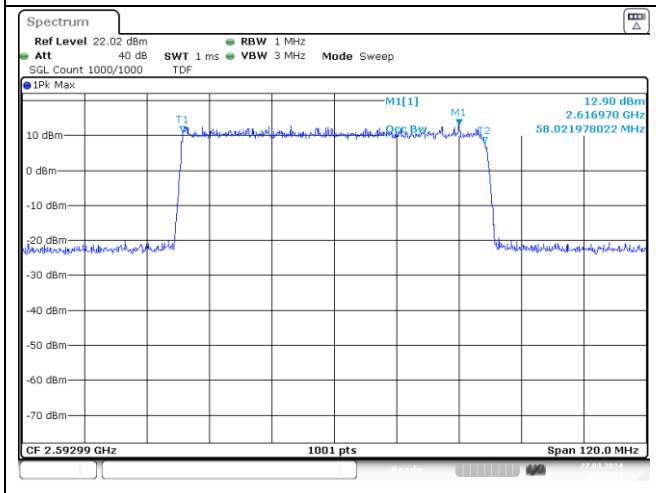

60 MHz Middle Channel DFT-S-OFDM 16QAM

60 MHz Middle Channel CP-OFDM QPSK

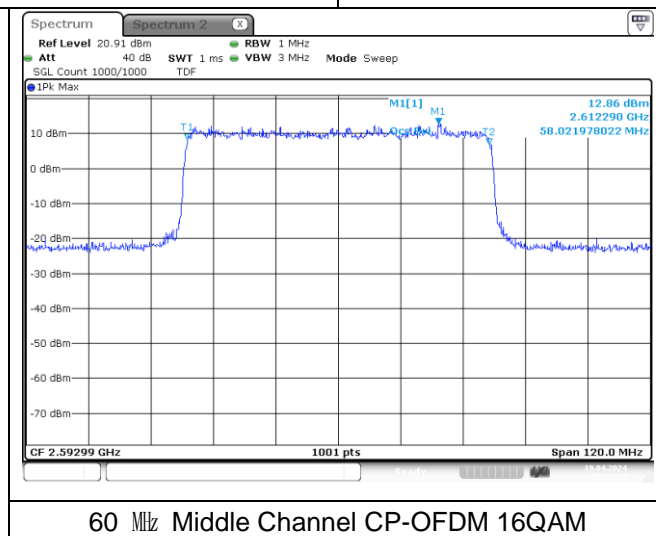

60 MHz Middle Channel CP-OFDM 16QAM

NR band 41

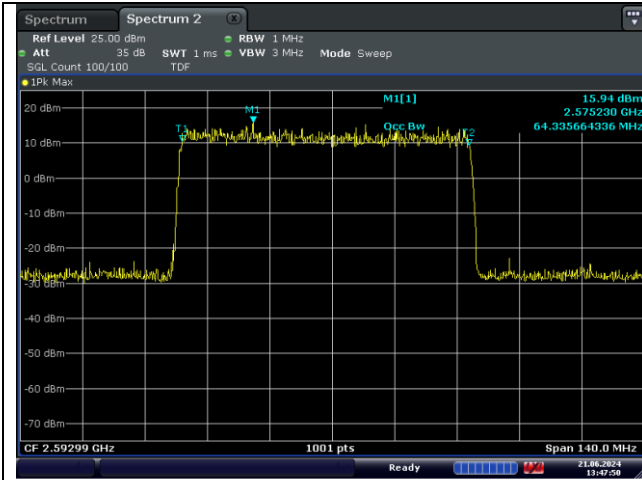

70 MHz Middle Channel DFT-S-OFDM BPSK

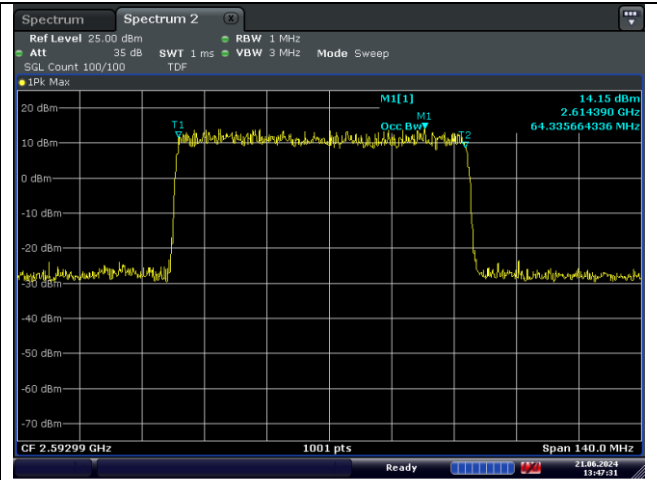

70 MHz Middle Channel DFT-S-OFDM QPSK

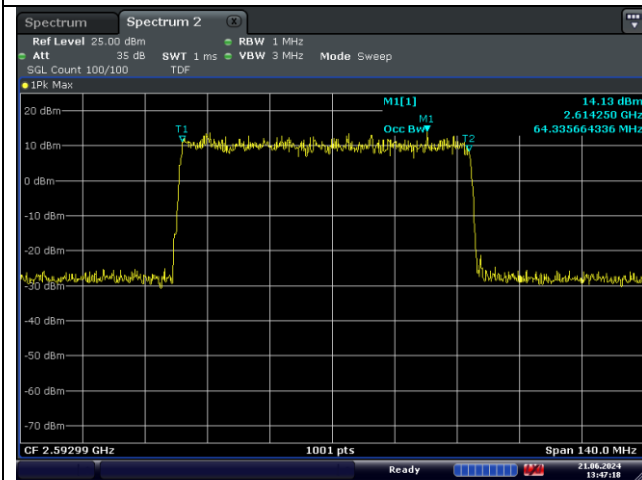

70 MHz Middle Channel DFT-S-OFDM 16QAM

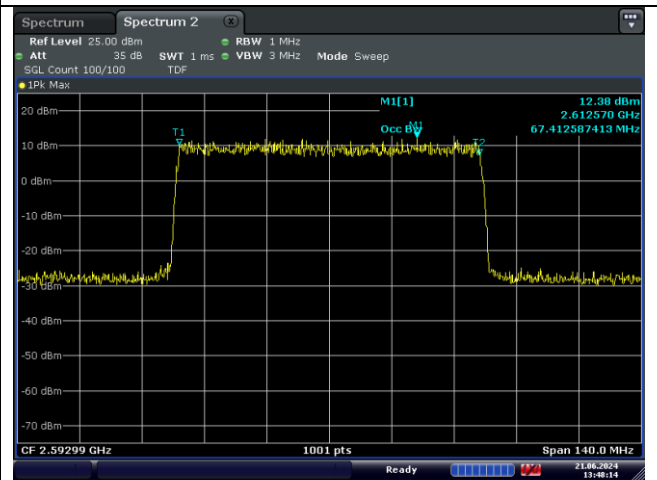

70 MHz Middle Channel CP-OFDM QPSK

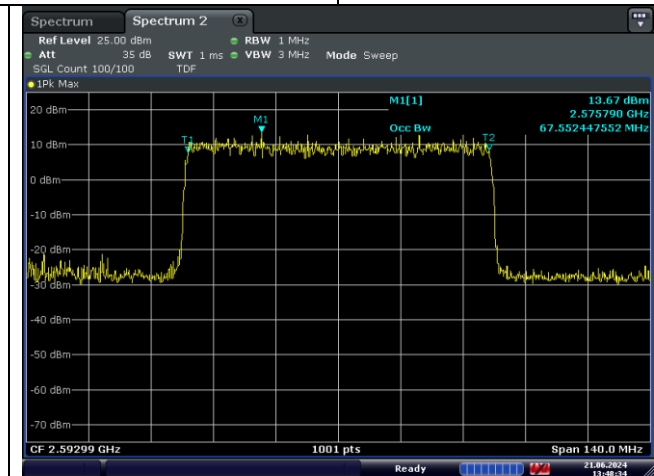

70 MHz Middle Channel CP-OFDM 16QAM

NR band 41

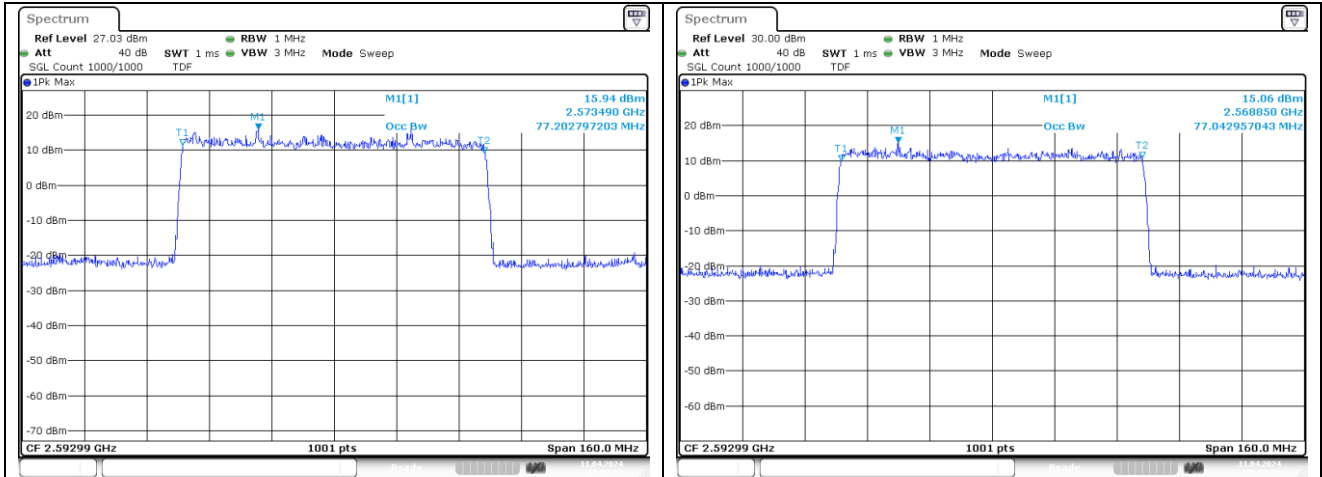

80 MHz Middle Channel DFT-S-OFDM BPSK

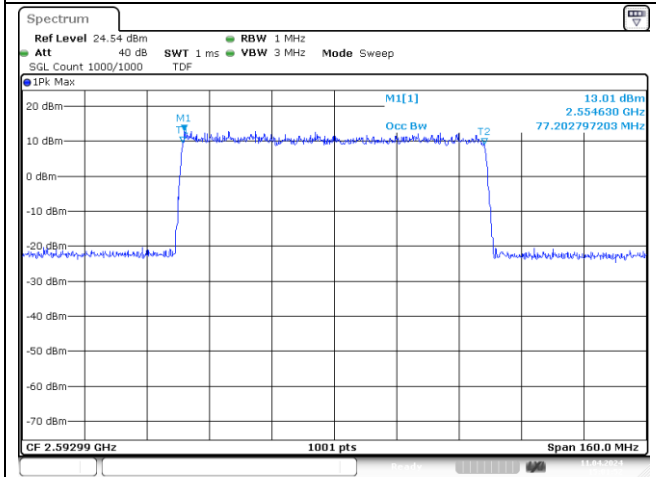

80 MHz Middle Channel DFT-S-OFDM QPSK

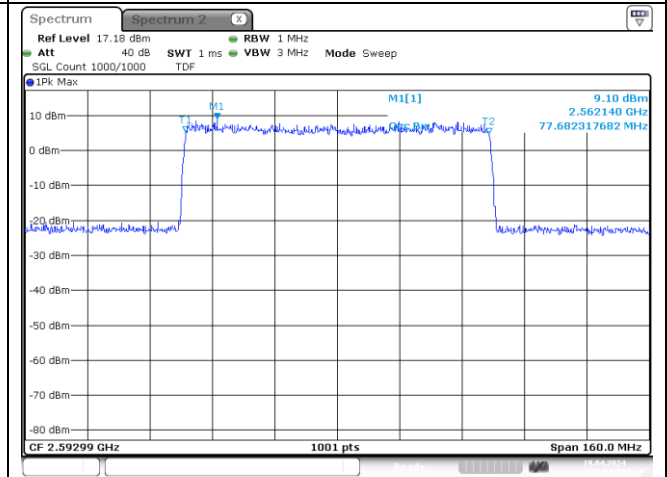

80 MHz Middle Channel DFT-S-OFDM 16QAM

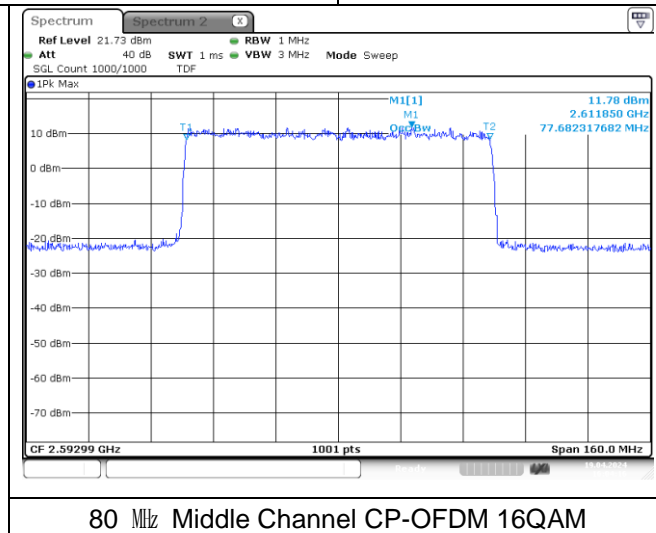

80 MHz Middle Channel CP-OFDM QPSK

80 MHz Middle Channel CP-OFDM 16QAM

NR band 41

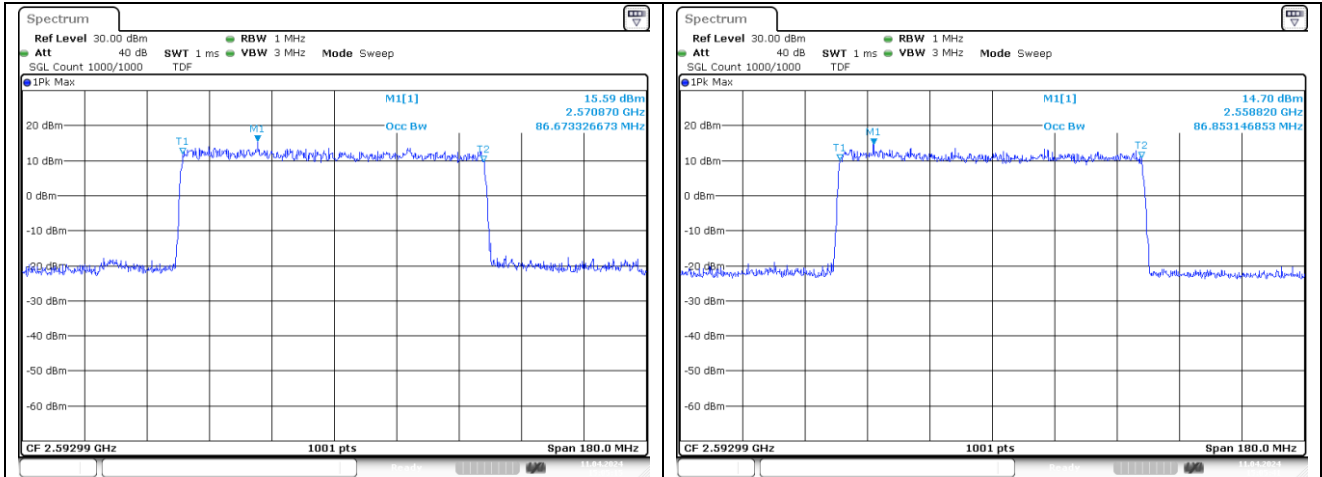

90 MHz Middle Channel DFT-S-OFDM BPSK

90 MHz Middle Channel DFT-S-OFDM QPSK

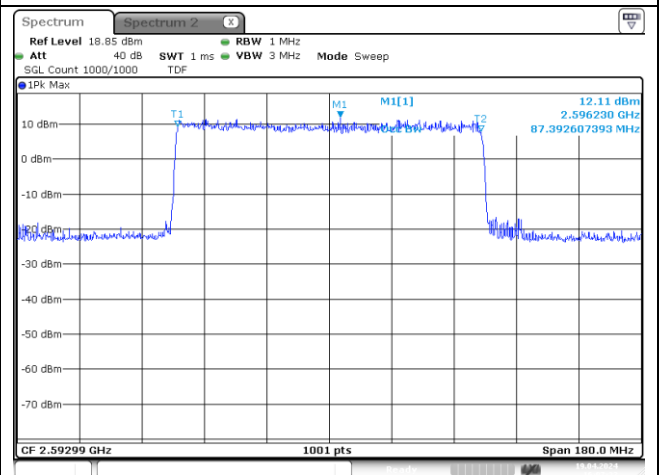
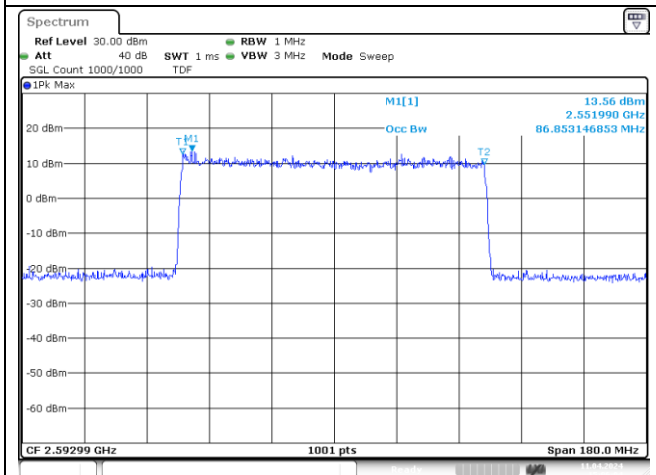

90 MHz Middle Channel DFT-S-OFDM 16QAM

90 MHz Middle Channel CP-OFDM QPSK

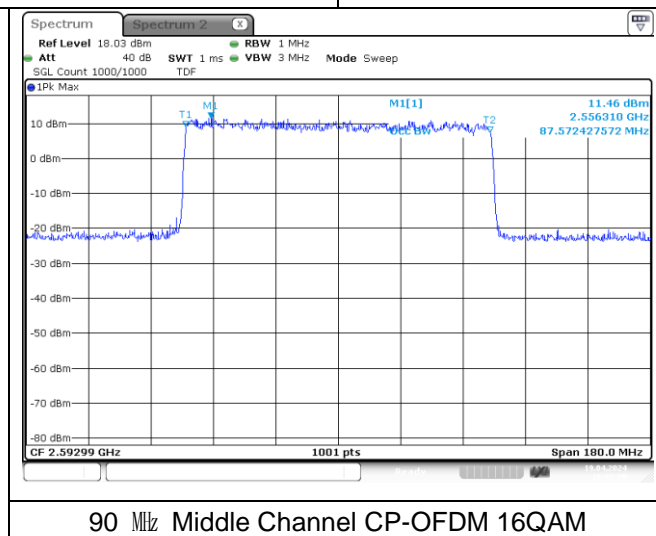

90 MHz Middle Channel CP-OFDM 16QAM

NR band 41

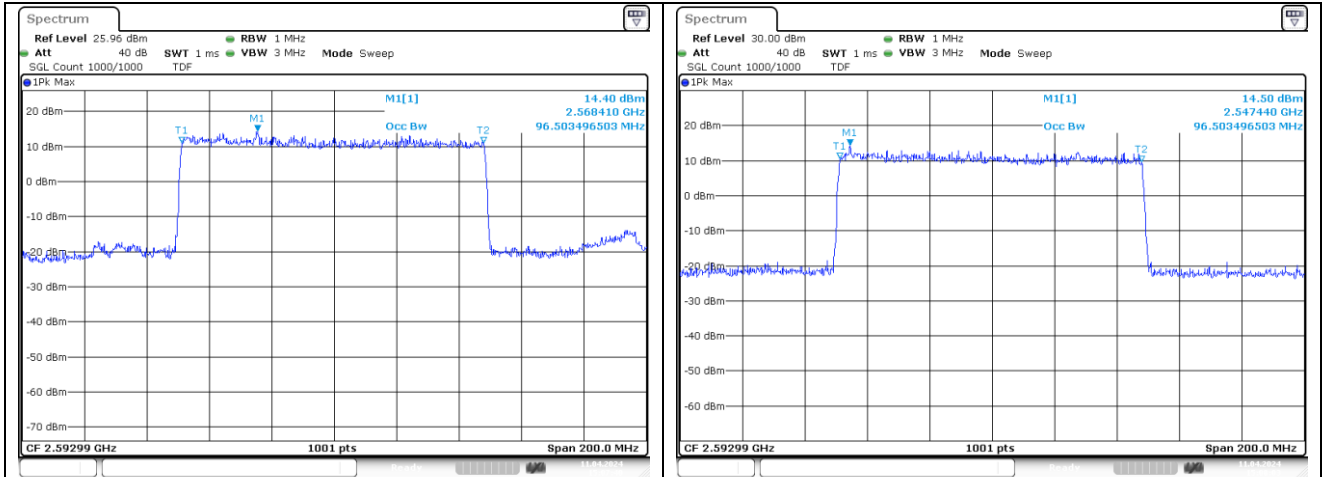

100 MHz Middle Channel DFT-S-OFDM BPSK

100 MHz Middle Channel DFT-S-OFDM QPSK

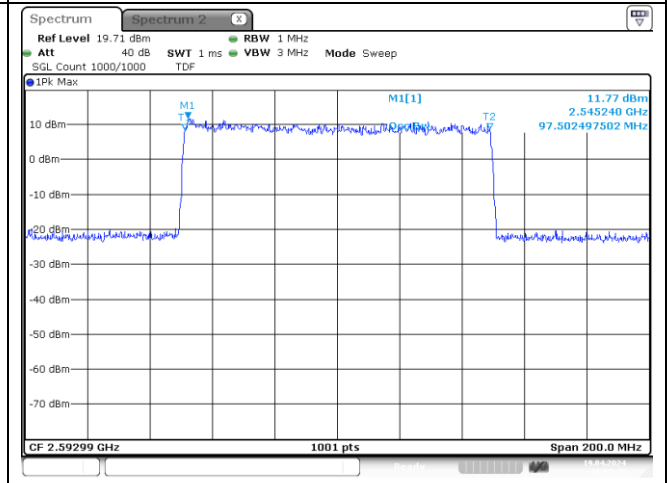
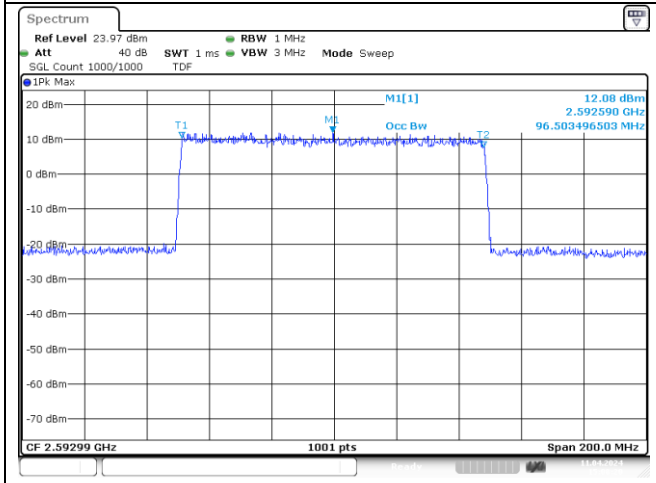

100 MHz Middle Channel DFT-S-OFDM 16QAM

100 MHz Middle Channel CP-OFDM QPSK

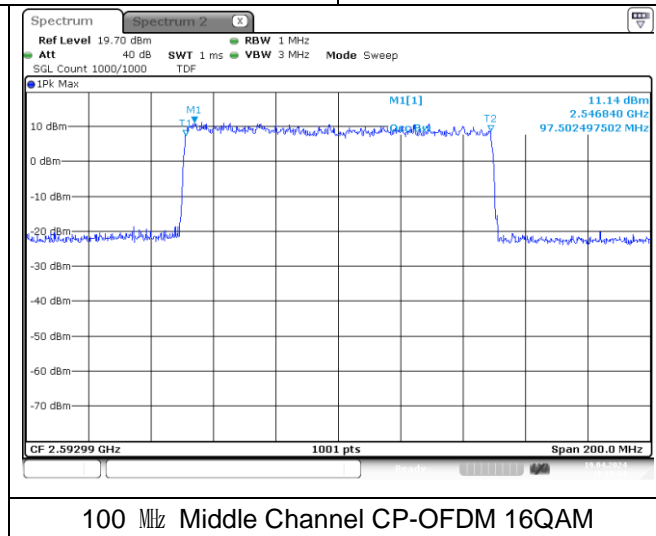

100 MHz Middle Channel CP-OFDM 16QAM

NR band 7778_Low Band

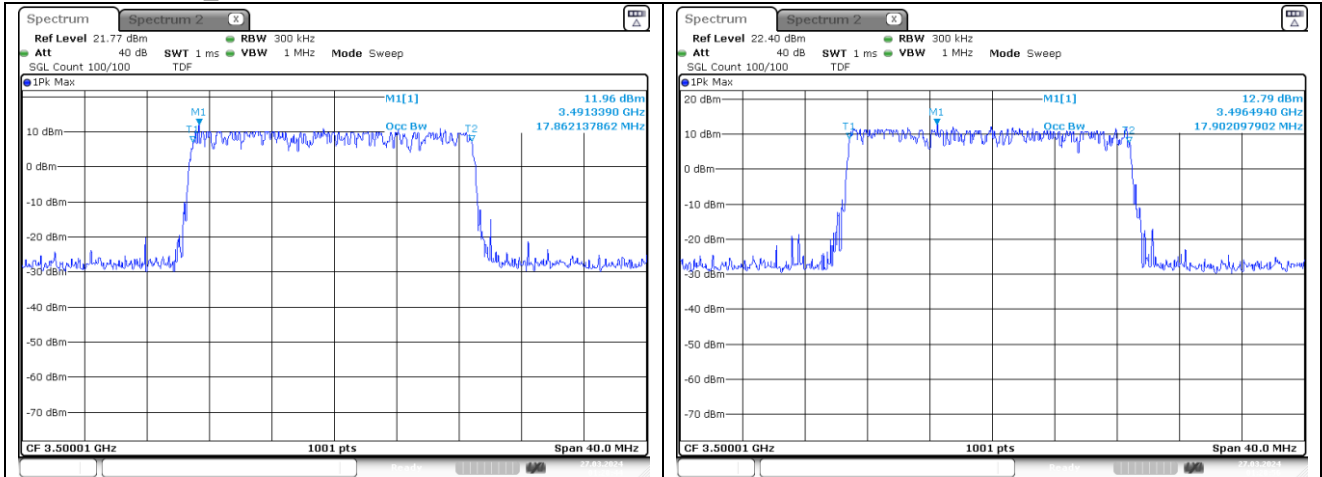

20 MHz Middle Channel DFT-S-OFDM BPSK

20 MHz Middle Channel DFT-S-OFDM QPSK

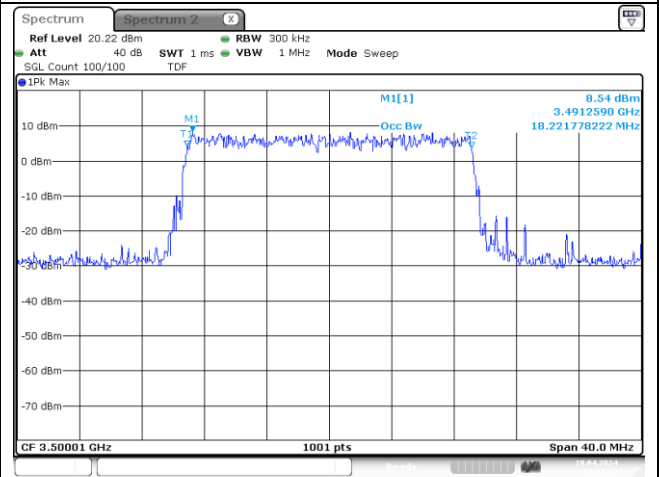
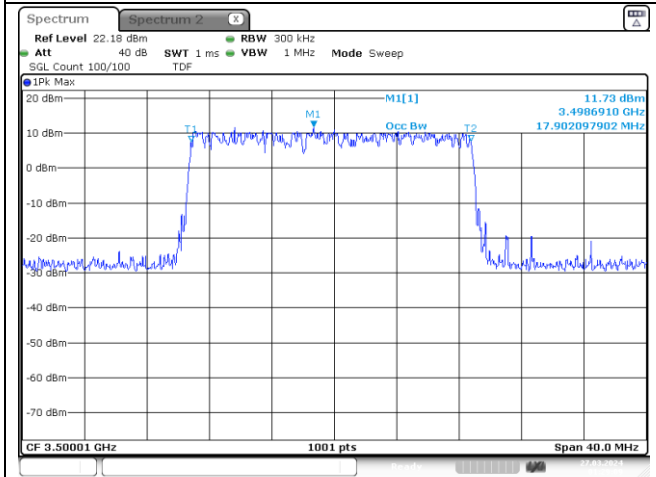

20 MHz Middle Channel DFT-S-OFDM 16QAM

20 MHz Middle Channel CP-OFDM QPSK

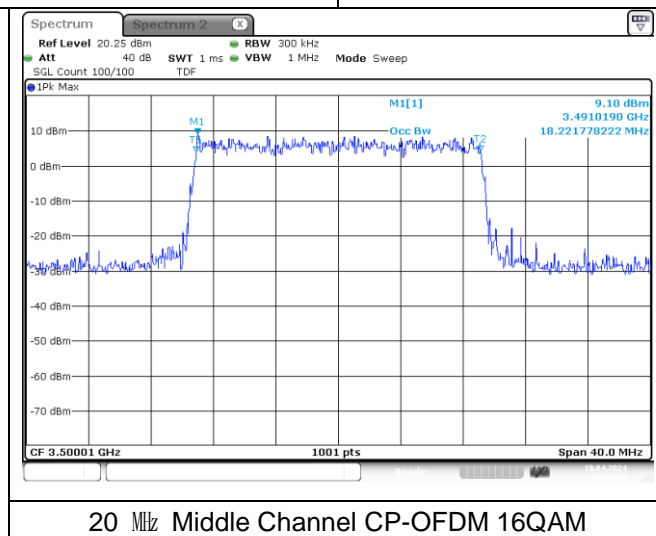

20 MHz Middle Channel CP-OFDM 16QAM

NR band 7778_Low Band

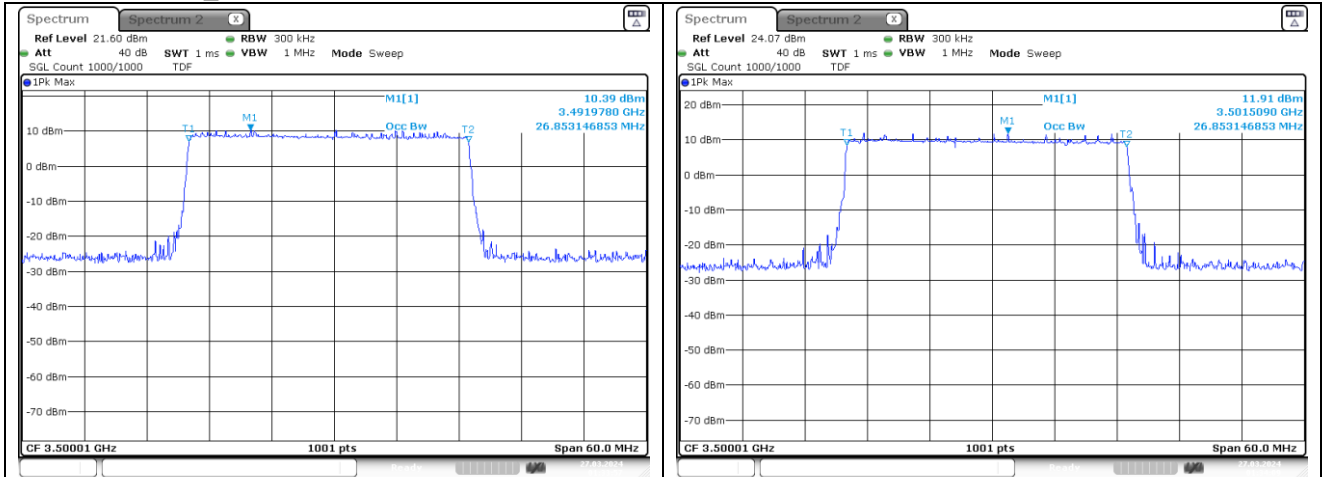

30 MHz Middle Channel DFT-S-OFDM BPSK

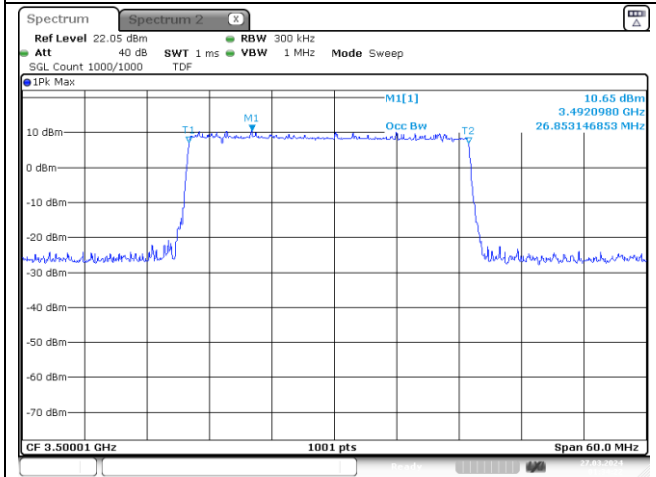

30 MHz Middle Channel DFT-S-OFDM QPSK

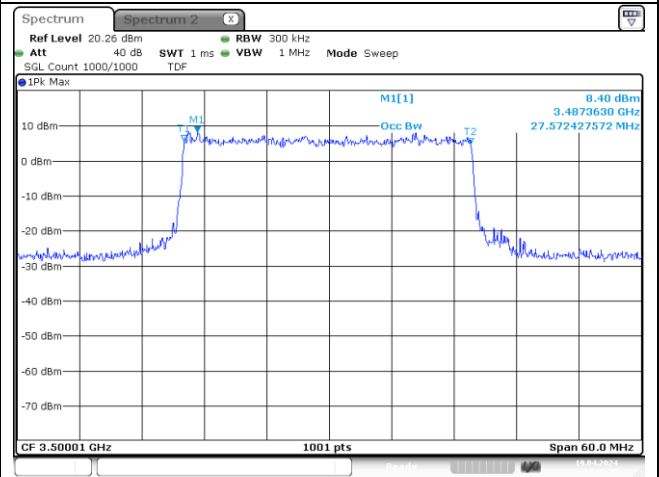

30 MHz Middle Channel DFT-S-OFDM 16QAM

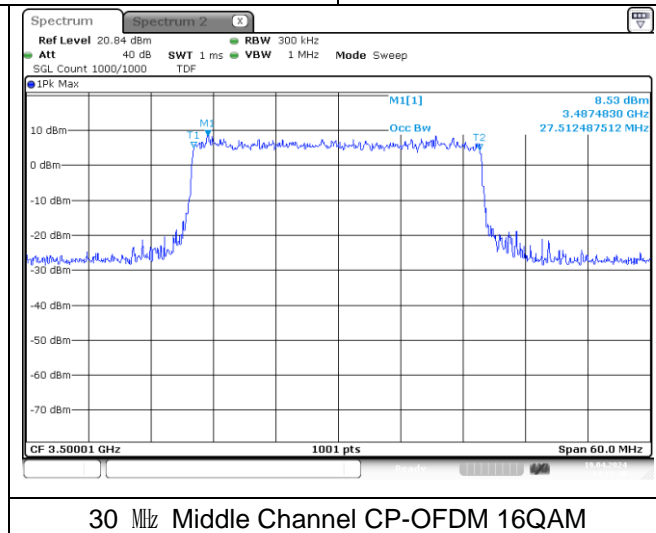

30 MHz Middle Channel CP-OFDM QPSK

30 MHz Middle Channel CP-OFDM 16QAM

NR band 77/78_Low Band

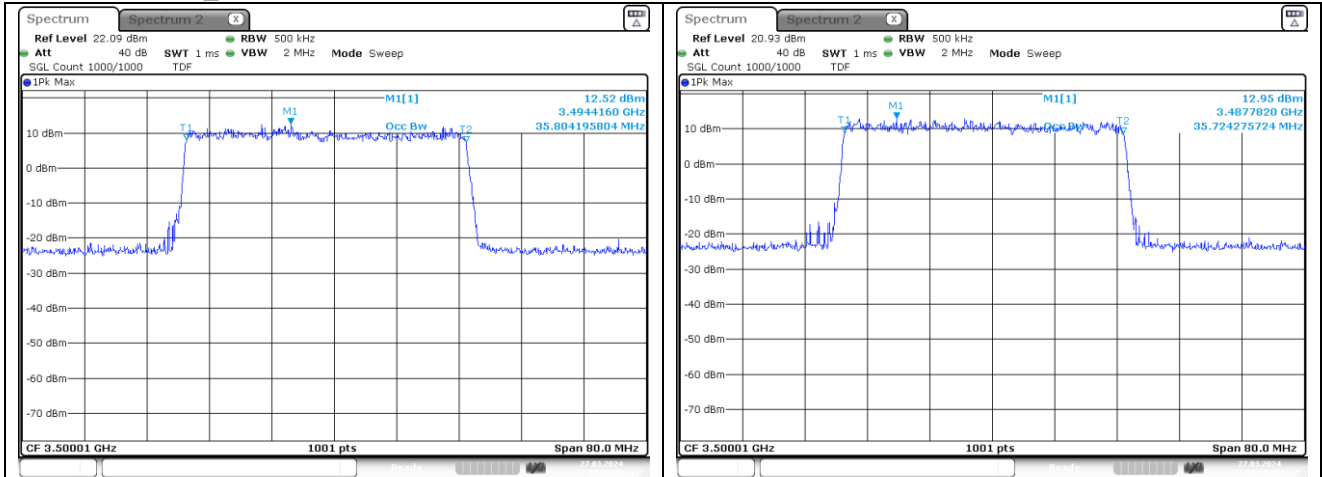

40 MHz Middle Channel DFT-S-OFDM BPSK

40 MHz Middle Channel DFT-S-OFDM QPSK

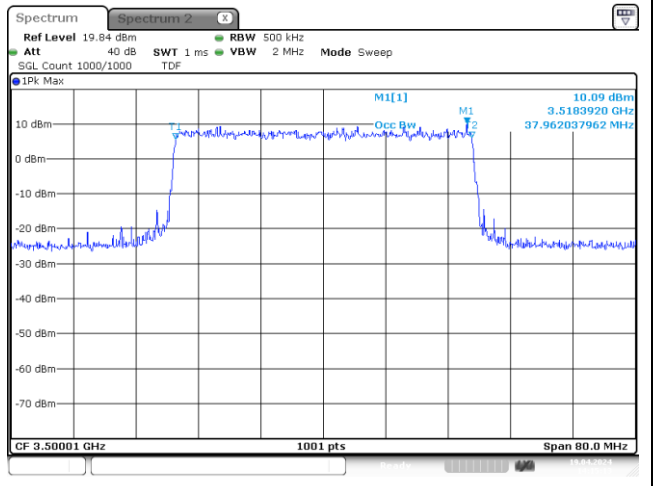
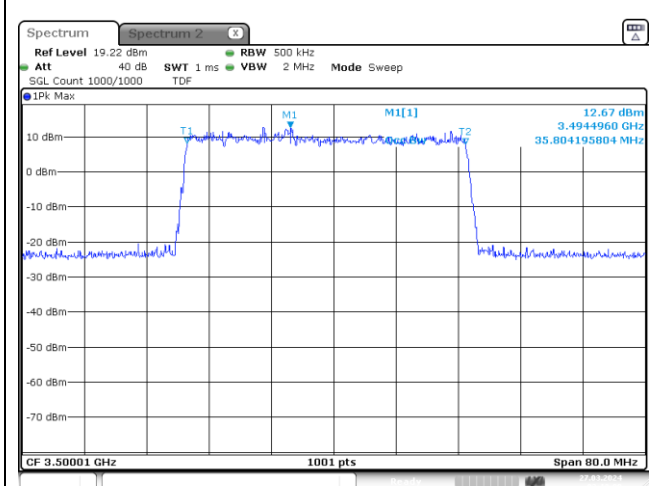

40 MHz Middle Channel DFT-S-OFDM 16QAM

40 MHz Middle Channel CP-OFDM QPSK

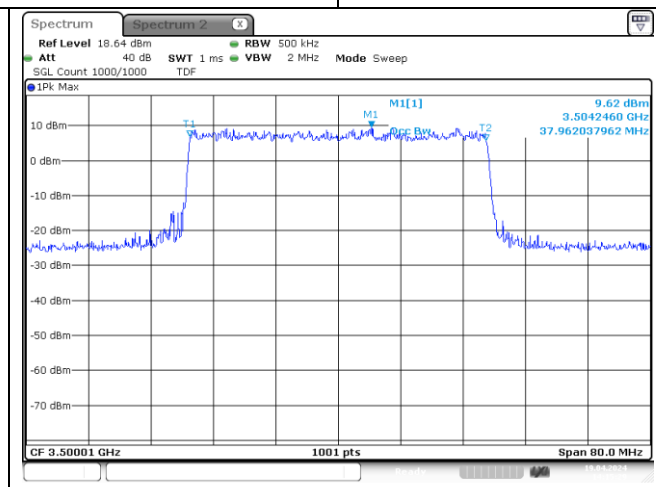

40 MHz Middle Channel CP-OFDM 16QAM

NR band 77/78_Low Band

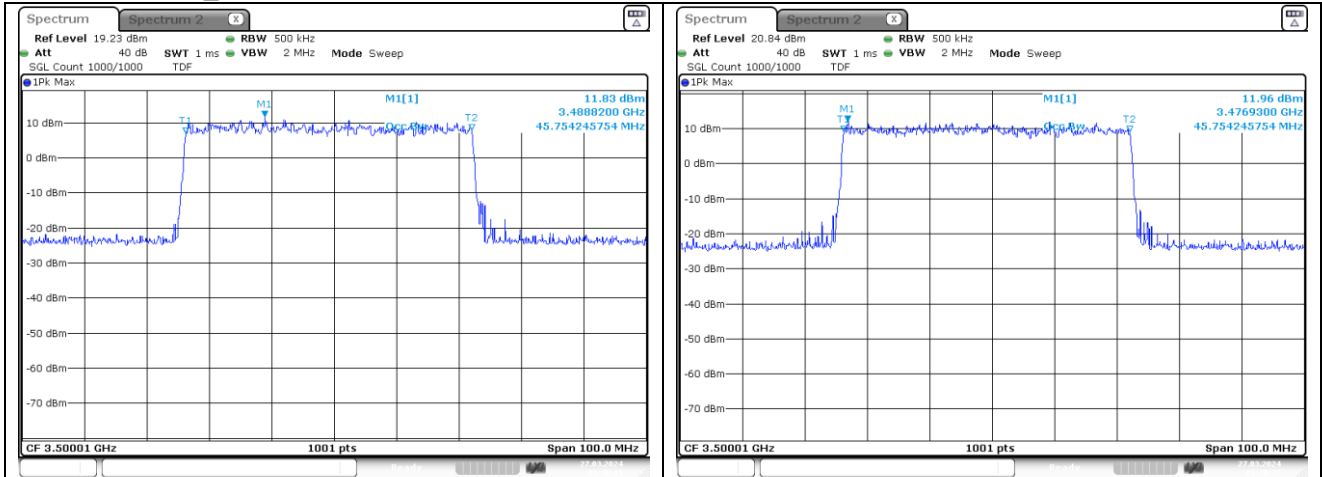

50 MHz Middle Channel DFT-S-OFDM BPSK

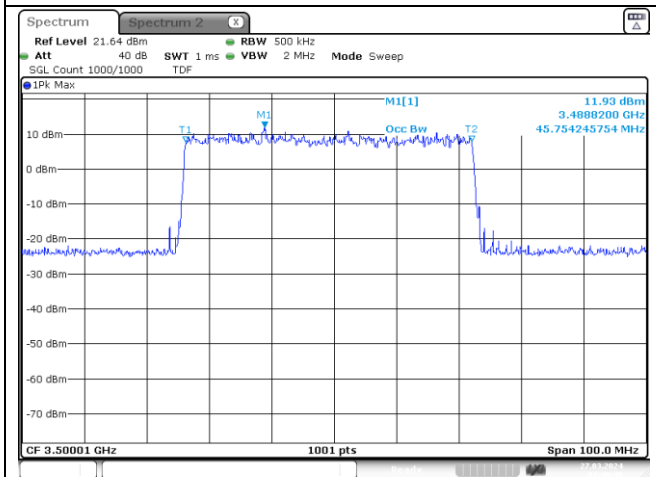

50 MHz Middle Channel DFT-S-OFDM QPSK

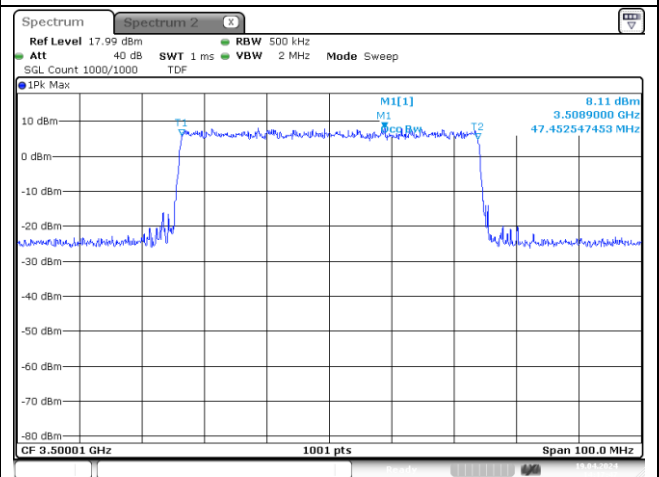

50 MHz Middle Channel DFT-S-OFDM 16QAM

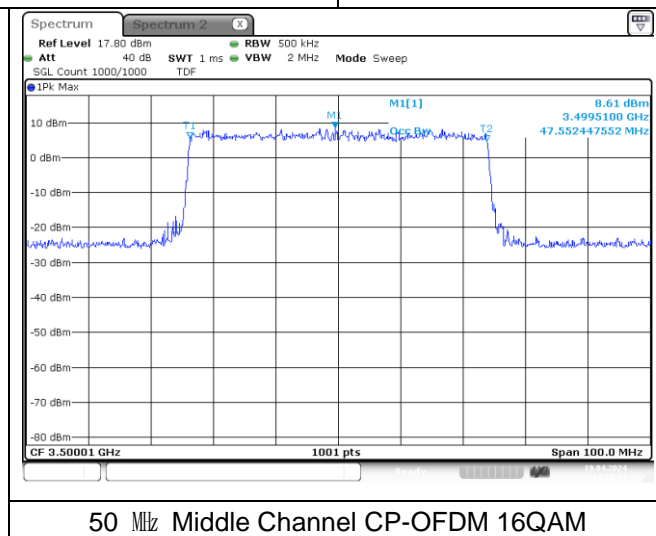

50 MHz Middle Channel CP-OFDM QPSK

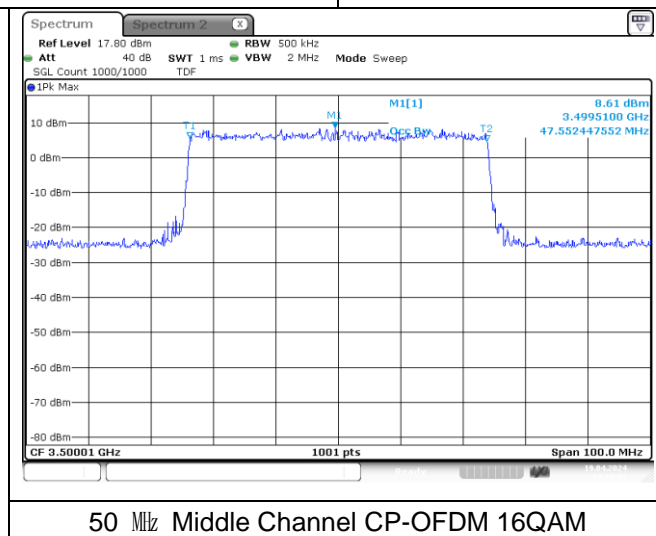

50 MHz Middle Channel CP-OFDM 16QAM

NR band 77/78_Low Band

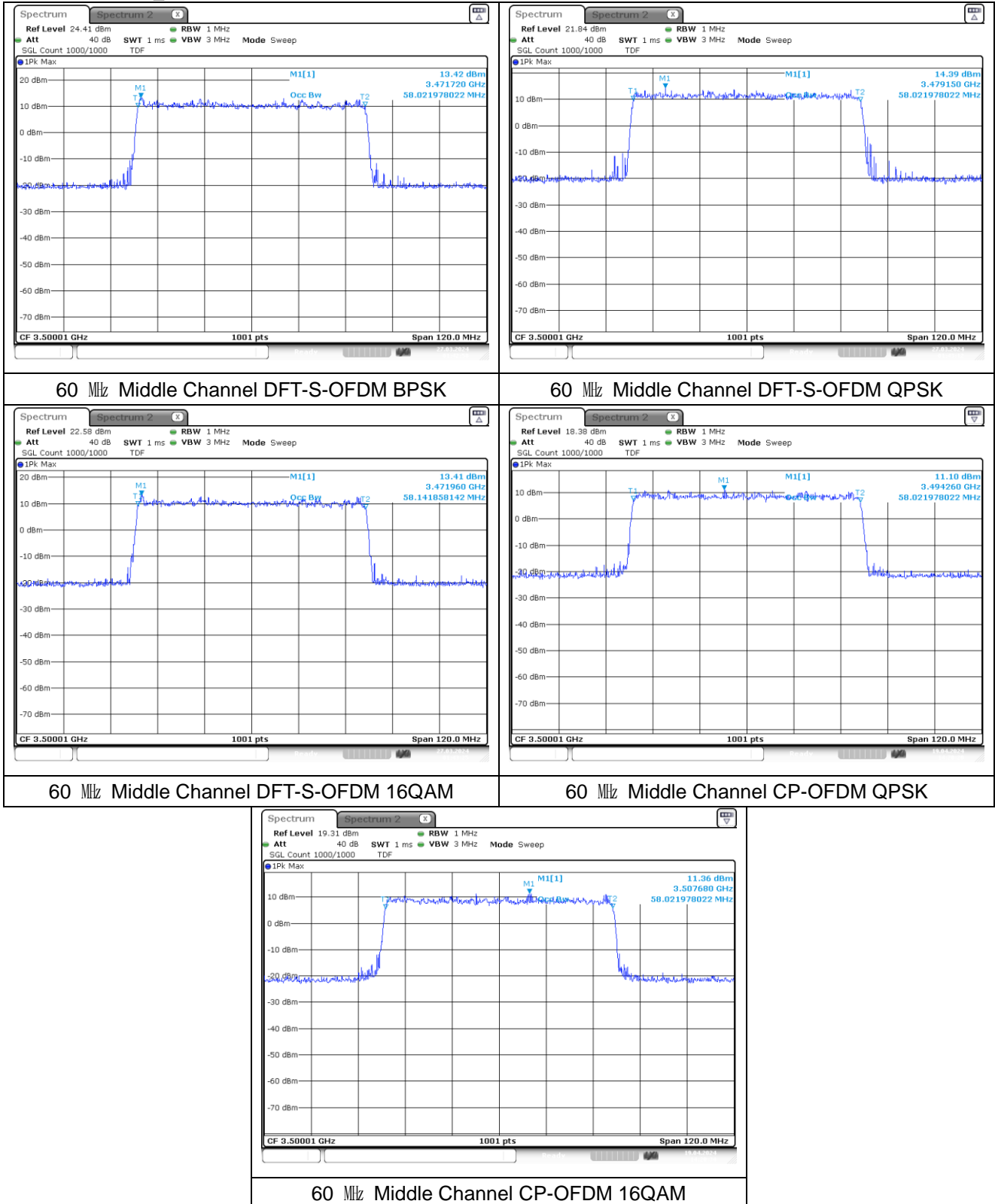

NR band 77/78_Low Band

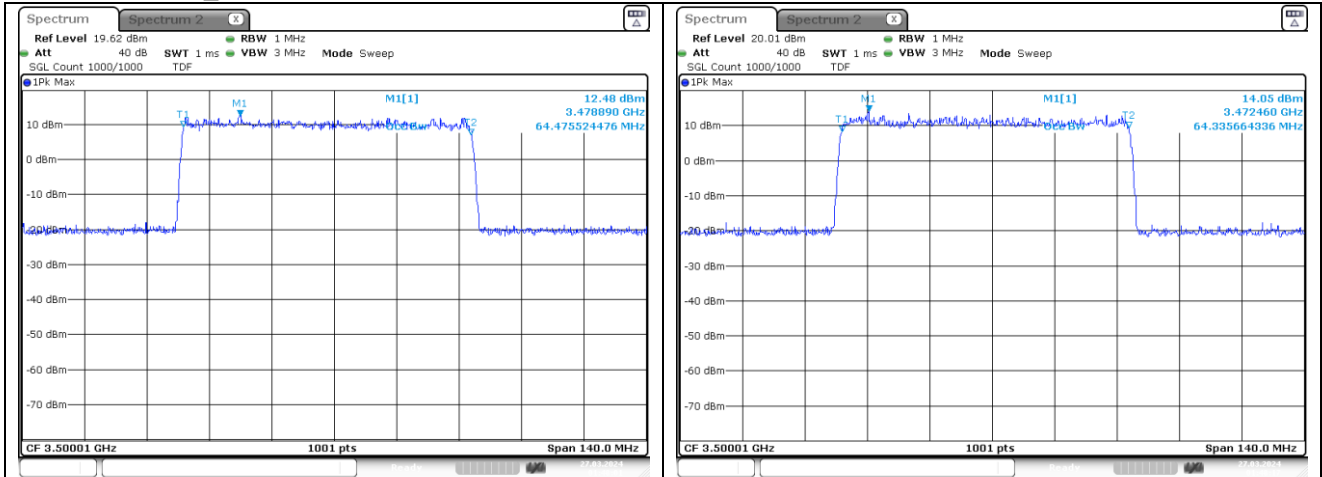

70 MHz Middle Channel DFT-S-OFDM BPSK

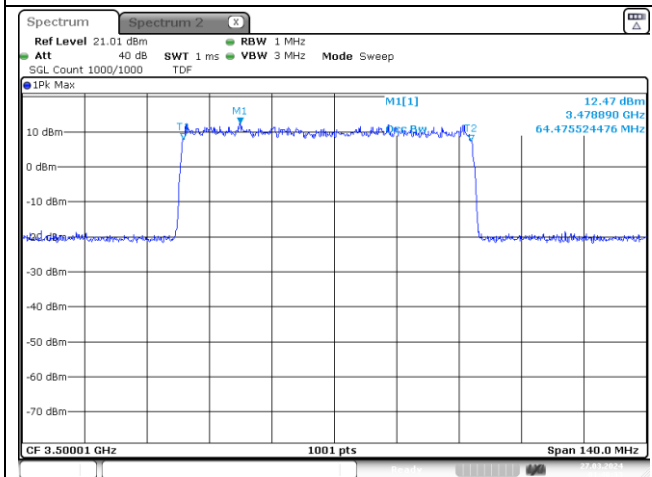

70 MHz Middle Channel DFT-S-OFDM QPSK

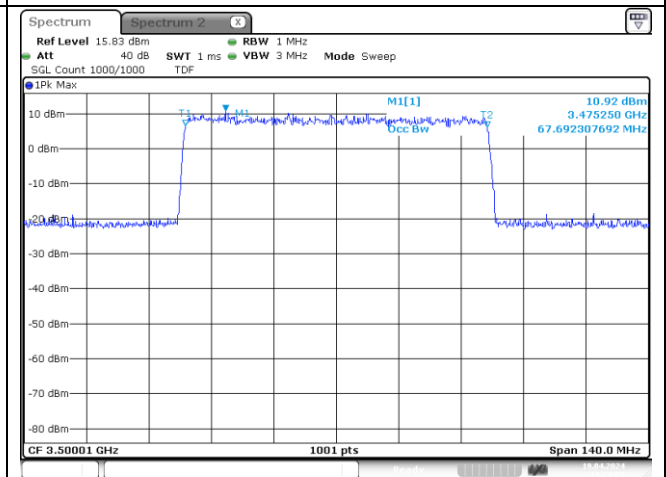

70 MHz Middle Channel DFT-S-OFDM 16QAM

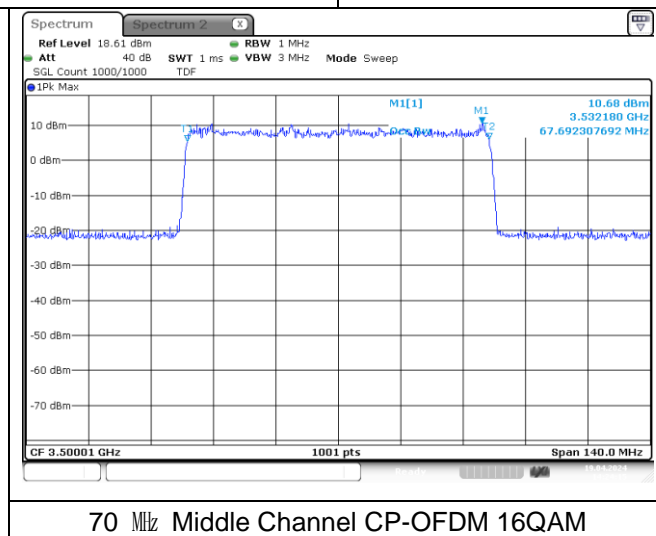

70 MHz Middle Channel CP-OFDM QPSK

70 MHz Middle Channel CP-OFDM 16QAM

NR band 77/78_Low Band

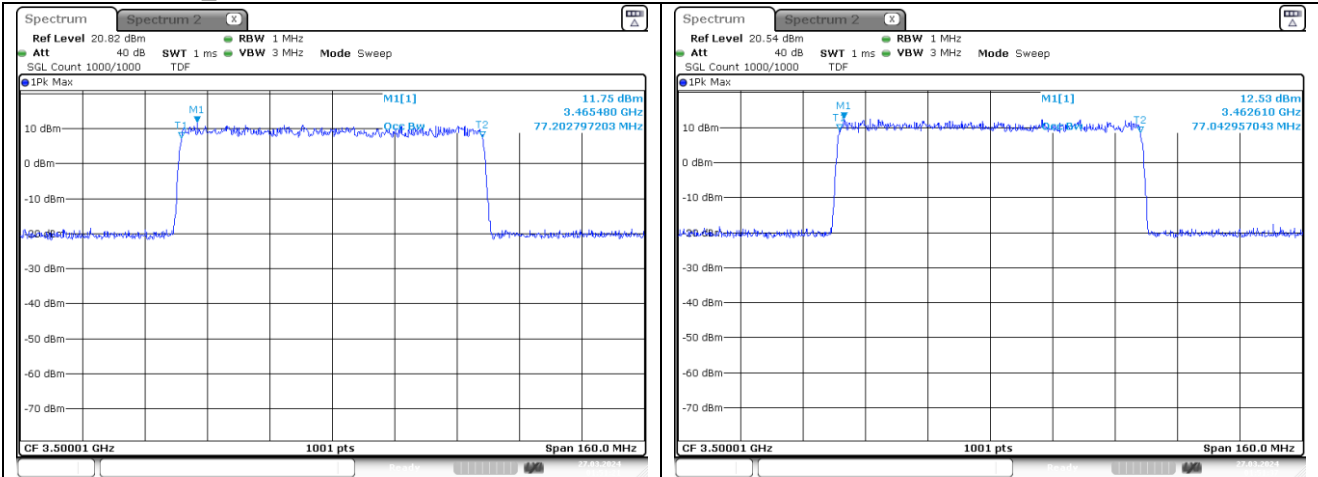

80 MHz Middle Channel DFT-S-OFDM BPSK

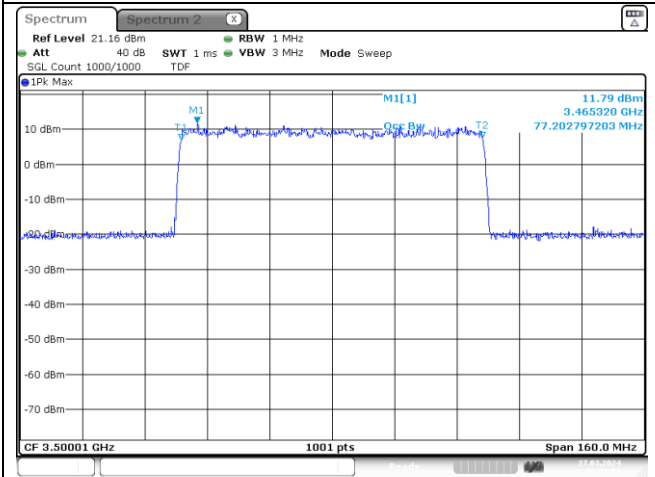

80 MHz Middle Channel DFT-S-OFDM QPSK

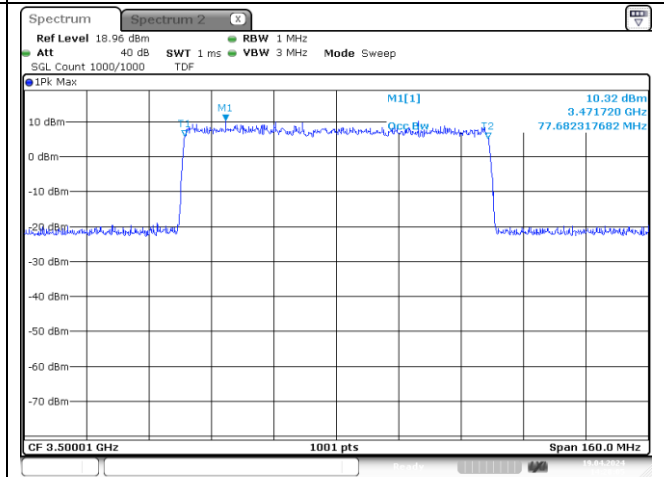

80 MHz Middle Channel DFT-S-OFDM 16QAM

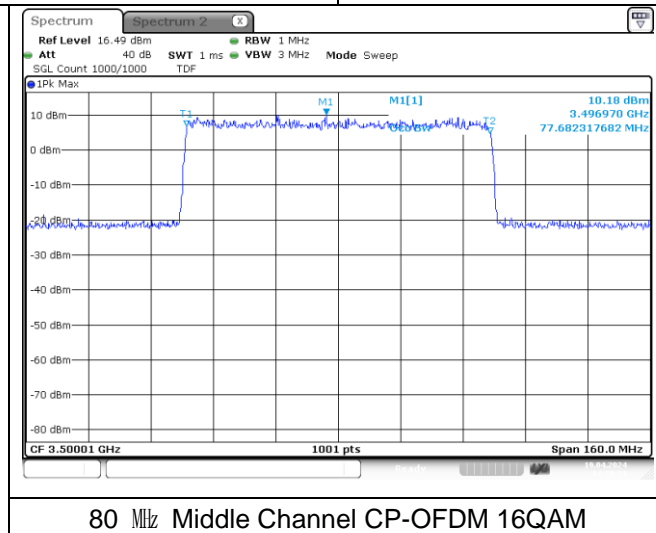

80 MHz Middle Channel CP-OFDM QPSK

80 MHz Middle Channel CP-OFDM 16QAM

NR band 77/78_Low Band

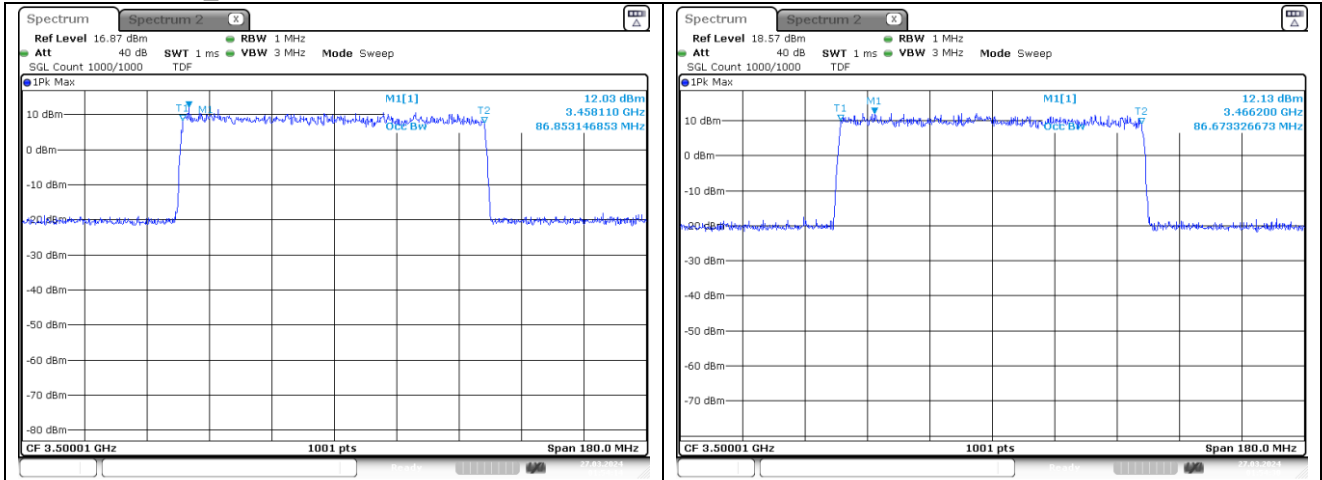

90 MHz Middle Channel DFT-S-OFDM BPSK

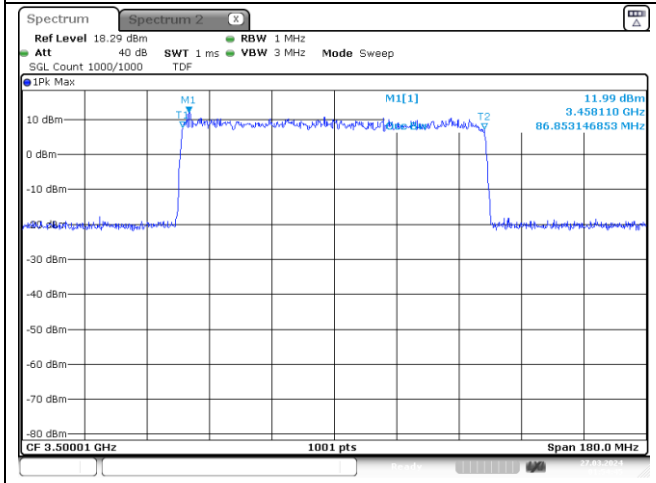

90 MHz Middle Channel DFT-S-OFDM QPSK

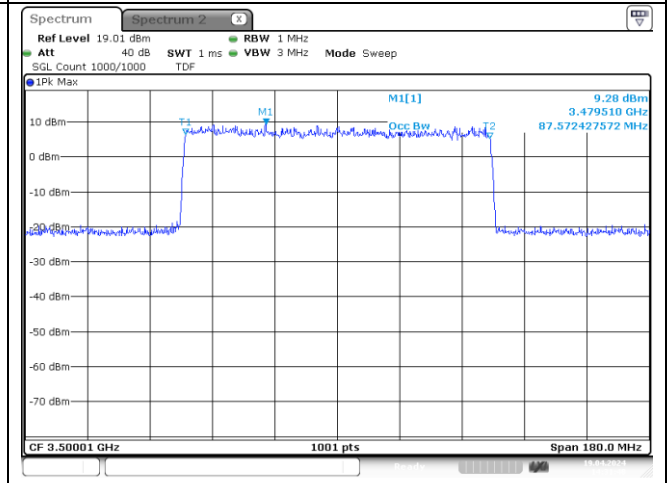

90 MHz Middle Channel DFT-S-OFDM 16QAM

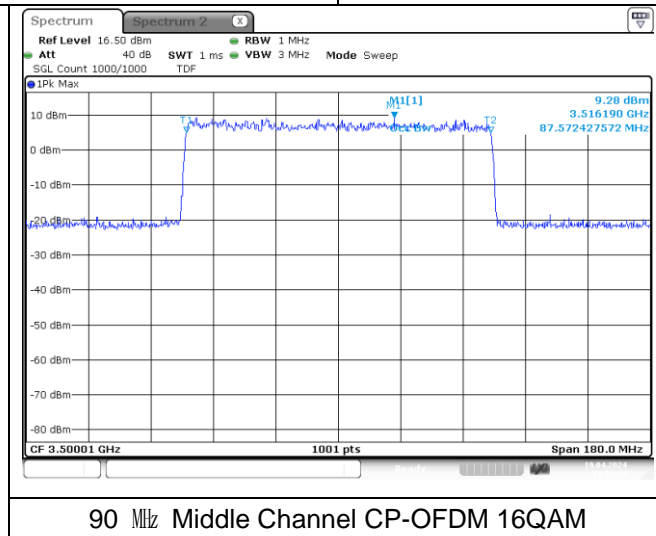

90 MHz Middle Channel CP-OFDM QPSK

NR band 7778_Low Band

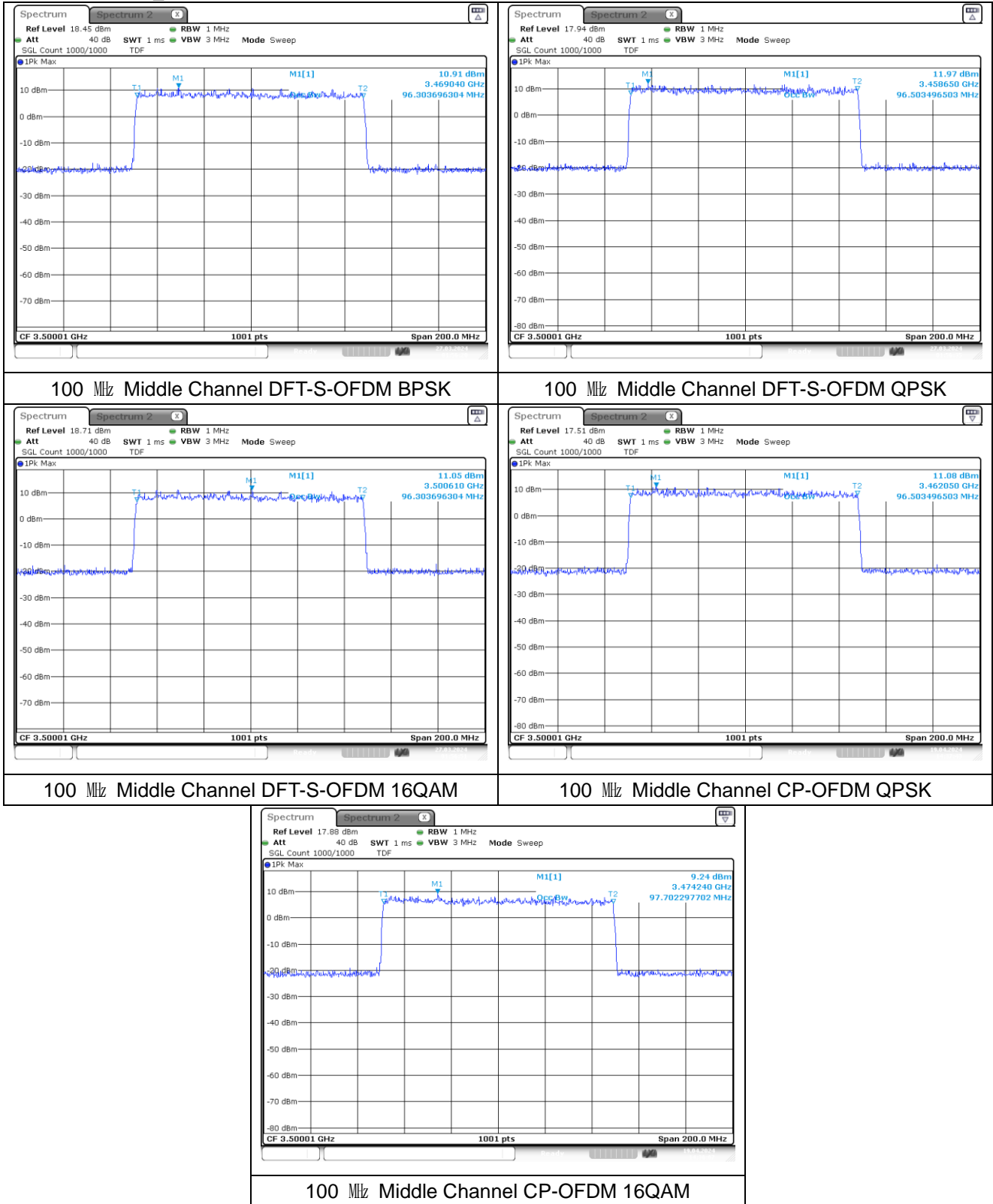

NR band 77/78_High Band

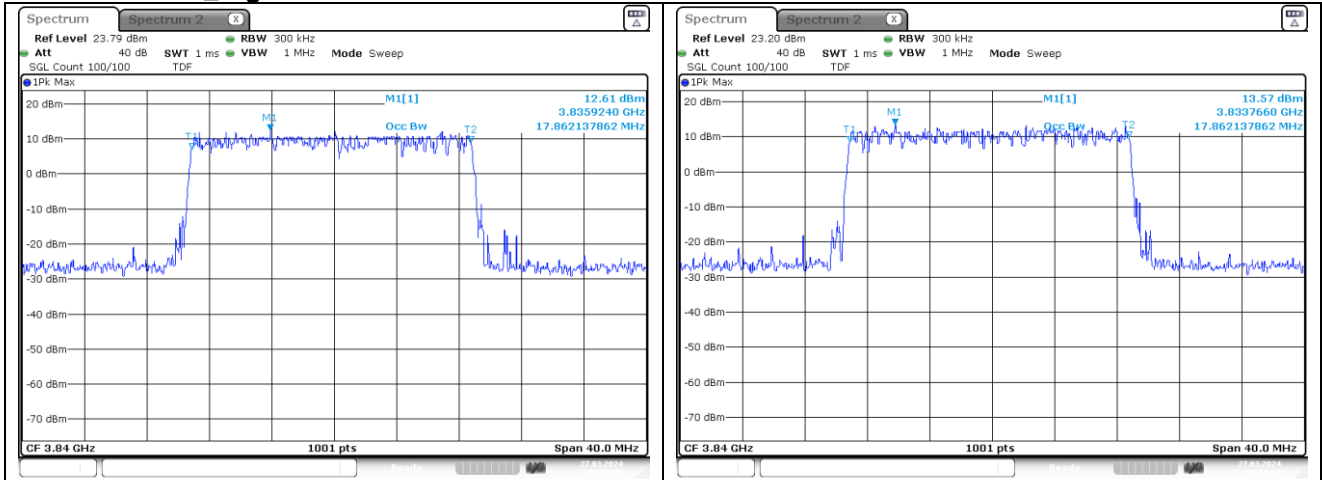

20 MHz Middle Channel DFT-S-OFDM BPSK

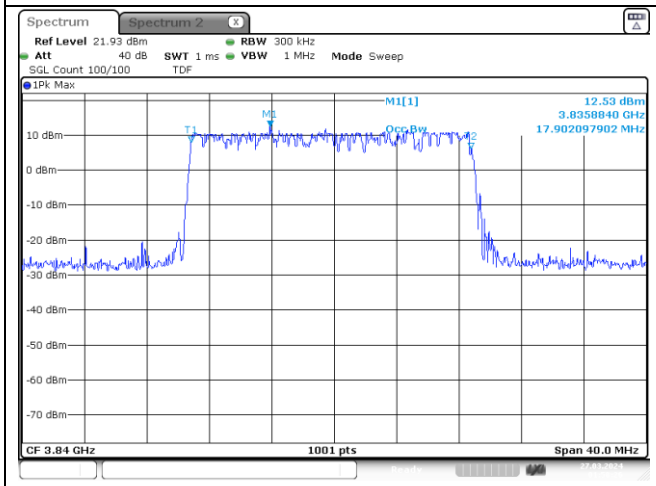

20 MHz Middle Channel DFT-S-OFDM QPSK

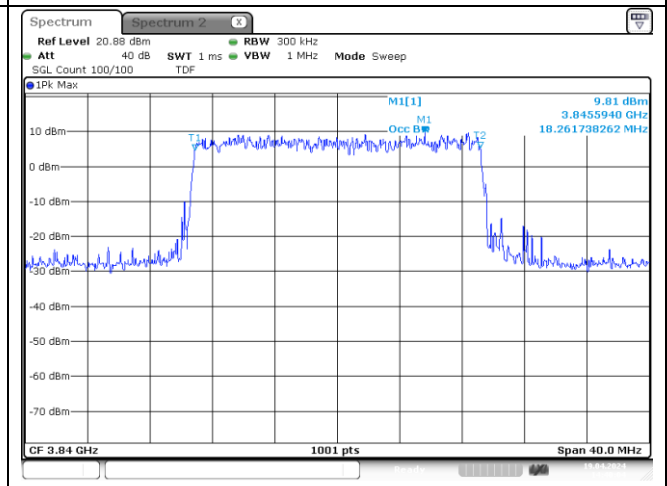

20 MHz Middle Channel DFT-S-OFDM 16QAM

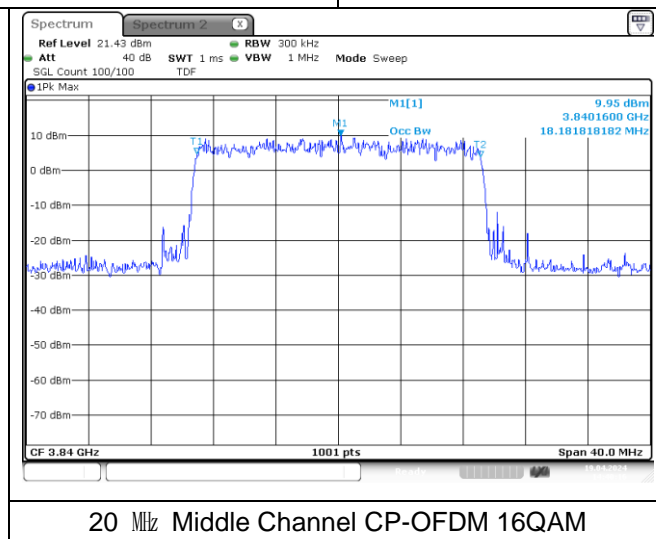

20 MHz Middle Channel CP-OFDM QPSK

20 MHz Middle Channel CP-OFDM 16QAM

NR band 77/78_High Band

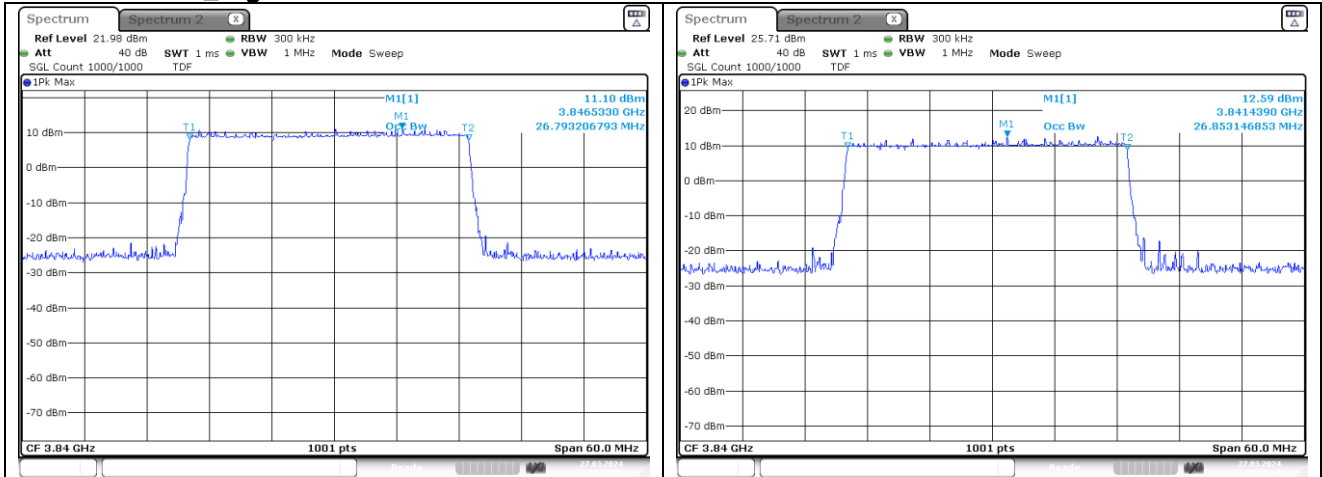

30 MHz Middle Channel DFT-S-OFDM BPSK

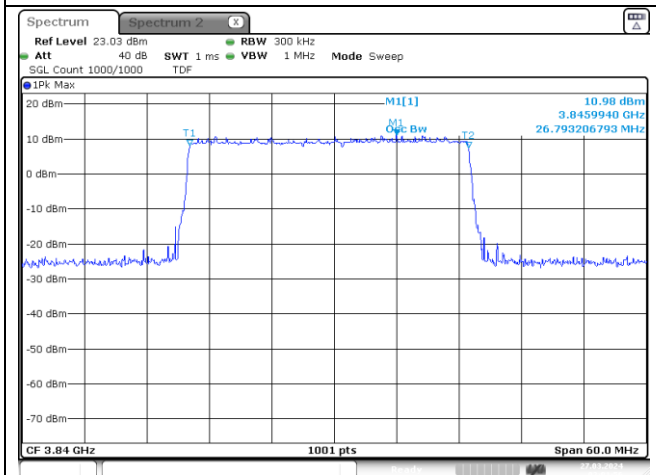

30 MHz Middle Channel DFT-S-OFDM QPSK

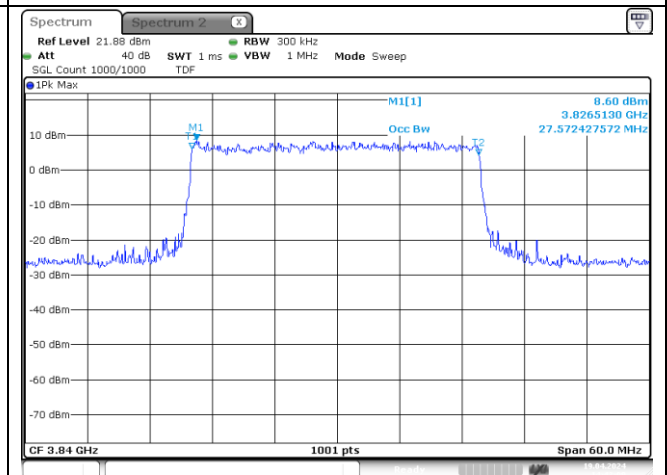

30 MHz Middle Channel DFT-S-OFDM 16QAM

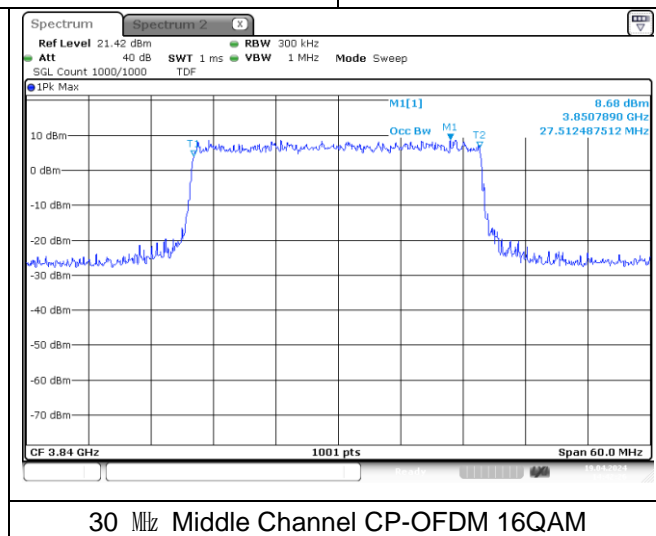

30 MHz Middle Channel CP-OFDM QPSK

30 MHz Middle Channel CP-OFDM 16QAM

NR band 7778_High Band

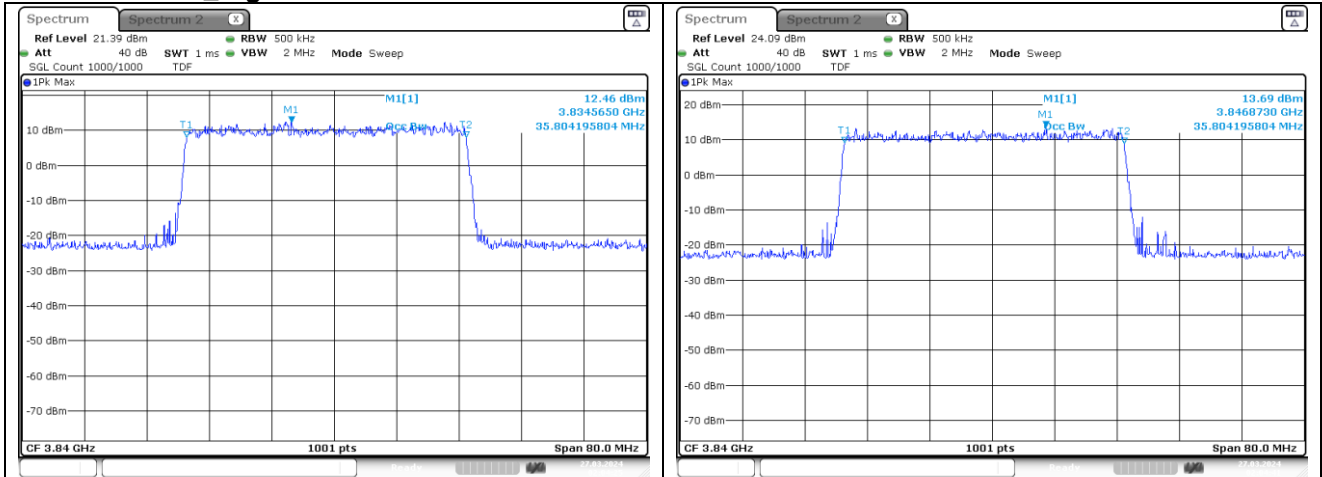

40 MHz Middle Channel DFT-S-OFDM BPSK

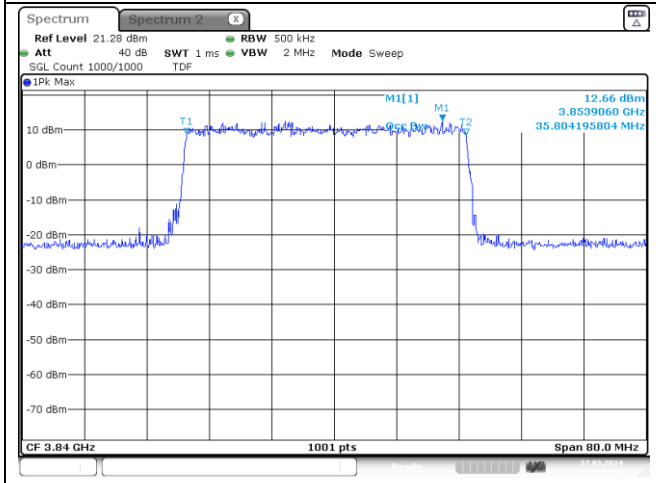

40 MHz Middle Channel DFT-S-OFDM QPSK

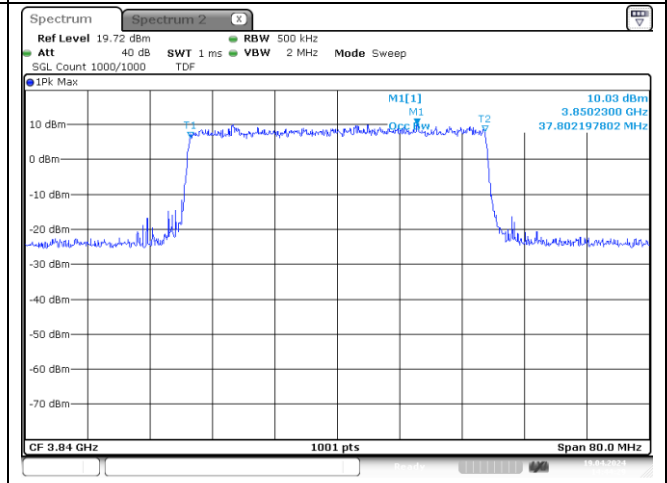

40 MHz Middle Channel DFT-S-OFDM 16QAM

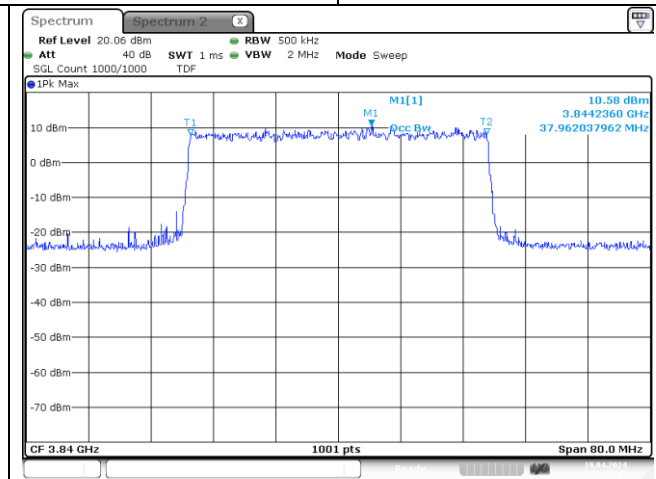

40 MHz Middle Channel CP-OFDM QPSK



40 MHz Middle Channel CP-OFDM 16QAM