

TEST REPORT

of

FCC Part 22 Subpart H and Part 24 Subpart E
RSS-132 Issue 3, RSS-133 Issue 6 and
RSS-Gen Issue 4

FCC ID: YZP-BK1000
IC Certification: 7414C-BK1000

Equipment Under Test : Telematics Modem
Model Name : LTD-BK1000
Variant Model Name : LG Innotek Co., Ltd.
Applicant : LG Innotek Co., Ltd.
Manufacturer : 2017.03.06
Date of Test(s) : 2017.03.21 ~ 2017.04.05
Date of Issue : 2017.04.20

In the configuration tested, the EUT complied with the standards specified above.

Tested By:



Youngmin Park

Date:

2017.04.20

Technical
Manager:



Hyunchoe You

Date:

2017.04.20

The results shown in this test report refer only to the sample(s) tested unless otherwise stated. This test report cannot be reproduced, except in full, without prior written permission of the Company.

TABLE OF CONTENTS

	Page
1. General Information -----	3
2. RF Radiated Output Power & Spurious Radiated Emission -----	7
3. Conducted Output Power -----	14
4. Occupied Bandwidth -----	16
5. Peak-Average Ratio -----	26
6. Spurious Emissions at Antenna Terminal -----	32
7. Band Edge -----	38
8. Frequency Stability -----	42

The results shown in this test report refer only to the sample(s) tested unless otherwise stated. This test report cannot be reproduced, except in full, without prior written permission of the Company.

1. General information

1.1. Testing laboratory

SGS Korea Co., Ltd. (Gunpo Laboratory)

- Wireless Div. 2FL, 10-2, LS-ro 182beon-gil, Gunpo-si, Gyeonggi-do, Korea, 15807

All SGS services are rendered in accordance with the applicable SGS conditions of service available on request and accessible at <http://www.sgs.com/en/Terms-and-Conditions.aspx>.

Telephone : +82 31 688 0901

FAX : +82 31 688 0921

1.2. Details of applicant

Applicant : LG Innotek Co., Ltd.

Address : 55, Hanyangdaehak-ro, Sangnok-gu, Ansan-si, Gyeonggido, 15588, Rep. of KOREA

Contact Person : Kuk, Yong-Ha

Phone No. : +82 31 436 6981

1.3. Description of EUT

Kind of Product	Telematics Modem
Model Name	LTD-BK1000
Power Supply	DC 4 V
Rated Power	WCDMA Band 2, 5: 24 dB m LTE Band 2, 4, 5, 17: 23 dB m
Frequency Range	WCDMA Band 2: 1 850 MHz ~ 1 910 MHz WCDMA Band 5: 824 MHz ~ 849 MHz LTE Band 2: 1 850 MHz ~ 1 910 MHz LTE Band 4: 1 710 MHz ~ 1 755 MHz LTE Band 5: 824 MHz ~ 849 MHz LTE Band 17: 704 MHz ~ 716 MHz
Emission Designator	WCDMA Band 2: 4M14F9W WCDMA Band 5: 4M17F9W LTE Band 2 (5 MHz): 4M52G7D (QPSK) / 4M53W7D (16QAM) LTE Band 2 (10 MHz): 8M94G7D (QPSK) / 8M97W7D (16QAM) LTE Band 2 (15 MHz): 13M46G7D (QPSK) / 13M46W7D (16QAM) LTE Band 2 (20 MHz): 17M95G7D (QPSK) / 18M00W7D (16QAM) LTE Band 4 (5 MHz): 4M53G7D (QPSK) / 4M52W7D (16QAM) LTE Band 4 (10 MHz): 8M91G7D (QPSK) / 8M94W7D (16QAM) LTE Band 4 (15 MHz): 13M46G7D (QPSK) / 13M46W7D (16QAM) LTE Band 4 (20 MHz): 17M95G7D (QPSK) / 17M89W7D (16QAM) LTE Band 5 (1.4 MHz): 1M10G7D (QPSK) / 1M10W7D (16QAM) LTE Band 5 (3 MHz): 2M69G7D (QPSK) / 2M69W7D (16QAM) LTE Band 5 (5 MHz): 4M53G7D (QPSK) / 4M52W7D (16QAM) LTE Band 5 (10 MHz): 8M97G7D (QPSK) / 8M94W7D (16QAM) LTE Band 17 (5 MHz): 4M52G7D (QPSK) / 4M52W7D (16QAM) LTE Band 17 (10 MHz): 8M94G7D (QPSK) / 8M94W7D (16QAM)
H/W Version	R0.5
S/W Version	01D_CAN

The results shown in this test report refer only to the sample(s) tested unless otherwise stated. This test report cannot be reproduced, except in full, without prior written permission of the Company.

SGS Korea Co., Ltd. (Gunpo Laboratory) 4, LS-ro 182beon-gil, Gunpo-si, Gyeonggi-do, Korea, 15807 <http://www.sgsgroup.kr>

1.4. Test equipment list

Equipment	Manufacturer	Model	S/N	Cal. Date	Cal. Interval	Cal. Due
Signal Generator	Agilent	E8257D	MY51501169	Jul. 07, 2016	Annual	Jul. 07, 2017
Spectrum Analyzer	R&S	FSV30	101004	Jun. 24, 2016	Annual	Jun. 24, 2017
Mobile Test Unit	R&S	CMW500	144035	Feb. 22, 2017	Annual	Feb. 22, 2018
Power Meter	Anritsu	ML2495A	1223004	Jun. 10, 2016	Annual	Jun. 10, 2017
Power Sensor	Anritsu	MA2411B	1207272	Jun. 10, 2016	Annual	Jun. 10, 2017
Directional Coupler	KRYTAR	152613	140972	Jun. 07, 2016	Annual	Jun. 07, 2017
High Pass Filter	Wainwright Instrument GmbH	WHKX10-900-1000-18000-40SS	7	Mar. 30, 2017	Annual	Mar. 30, 2018
High Pass Filter	Wainwright Instrument GmbH	WHK3.0/18G-10SS	344	Jun. 03, 2016	Annual	Jun. 03, 2017
High Pass Filter	Wainwright Instrument GmbH	WHKX2.2/12.75G-10SS	8	Mar. 30, 2017	Annual	Mar. 30, 2018
High Pass Filter	Wainwright Instrument GmbH	WHKX1.5/15G-6SS	4	Jun. 18, 2016	Annual	Jun. 18, 2017
DC Power Supply	Agilent	U8002A	MY50020026	Dec. 14, 2016	Annual	Dec. 14, 2017
Preamplifier	H.P.	8447F	2944A03909	Aug. 11, 2016	Annual	Aug. 11, 2017
Preamplifier	R&S	SCU 18	10117	Apr. 07, 2016	Annual	Apr. 07, 2017
Preamplifier	MITEQ Inc.	JS44-18004000-35-8P	1546891	May 12, 2016	Annual	May 12, 2017
Test Receiver	R&S	ESU26	100109	Feb. 17, 2017	Annual	Feb. 17, 2018
Bilog Antenna	Schwarzbeck Mess-Elektronik	VULB9163	396	Jun. 18, 2015	Biennial	Jun. 18, 2017
Horn Antenna	R&S	HF906	100326	Feb. 01, 2016	Biennial	Feb. 01, 2018
Horn Antenna	Schwarzbeck Mess-Elektronik	BBHA 9170	BBHA9170223	Aug. 25, 2016	Biennial	Aug. 25, 2018
Antenna Mast	Innco systems GmbH	MA4640-XP-ET	MA4640/536/38330516/L	N.C.R.	N/A	N.C.R.
Turn Table	Innco systems GmbH	DS 1200 S	N/A	N.C.R.	N/A	N.C.R.
Controller	Innco systems GmbH	CONTROLLER CO3000-4P	CO3000/963/38330516/L	N.C.R.	N/A	N.C.R.
Anechoic Chamber	SY Corporation	L x W x H (9.6 m x 6.4 m x 6.4 m)	N/A	N.C.R.	N/A	N.C.R.

Remark:

The equipment calibrated during the test period was used after finished the calibration.

► Support equipment

Description	Manufacturer	Model	Serial Number
N/A	-	-	-

The results shown in this test report refer only to the sample(s) tested unless otherwise stated. This test report cannot be reproduced, except in full, without prior written permission of the Company.

1.5. Summary of test results

The EUT has been tested according to the following specifications:

APPLIED STANDARD: FCC Part 2, 22 and 24 / IC Part RSS-132 Issue 3, RSS-133 Issue 6 and RSS-Gen Issue 4			
Section in FCC Part	Section in IC Part	Test Item	Result
§2.1046 §22.913(a)(2) §24.232(c)	RSS-132 Issue 3 5.4 RSS-133 Issue 6 6.4	RF Radiated Output Power	Complied
§2.1053 §22.917(a) §24.238(a)	RSS-132 Issue 3 5.5 RSS-133 Issue 6 6.5	Spurious Radiated Emission	Complied
§2.1046	RSS-Gen Issue 4 6.12	Conducted Output Power	Complied
§2.1049	RSS-Gen Issue 4 6.6	Occupied Bandwidth	Complied
§24.232(d)	RSS-132 Issue 3 5.4 RSS-133 Issue 6 6.4	Peak-Average Ratio	Complied
§2.1051 §22.917(a) §24.238(a)	RSS-132 Issue 3 5.5 RSS-133 Issue 6 6.5	Spurious Emission at Antenna Terminal	Complied
§22.917(a) §24.238(a)	RSS-132 Issue 3 5.5 RSS-133 Issue 6 6.5	Band Edge	Complied
§2.1055 §22.355 §24.235	RSS-Gen Issue 4 6.11 RSS-132 Issue 3 5.3 RSS-133 Issue 6 6.3	Frequency Stability	Complied

The results shown in this test report refer only to the sample(s) tested unless otherwise stated. This test report cannot be reproduced, except in full, without prior written permission of the Company.

1.6. Test report revision

Revision	Report number	Date of Issue	Description
0	F690501/RF-RTL010984	2017.04.10	Initial
1	F690501/RF-RTL010984-1	2017.04.20	Added test results for Frequency Stability up to 70°C

1.7. Sample calculation for offset

Where relevant, the following sample calculation is provided:

1.7.1. Conducted test

Offset value (dB) = Directional Coupler (dB) + Cable loss (dB)

1.7.2. Radiation test

E.R.P. & E.I.R.P. = [S.G level + Amp.] (dB m) - Cable loss (dB) + Ant. gain (dB d/dB i)

The results shown in this test report refer only to the sample(s) tested unless otherwise stated. This test report cannot be reproduced, except in full, without prior written permission of the Company.

SGS Korea Co., Ltd. (Gunpo Laboratory) 4, LS-ro 182beon-gil, Gunpo-si, Gyeonggi-do, Korea, 15807 <http://www.sgsgroup.kr>

2. RF radiated output power & spurious radiated emission

2.1. Test setup

The diagram below shows the test setup that is utilized to make the measurements for emission from 30 MHz to 1 GHz Emissions.

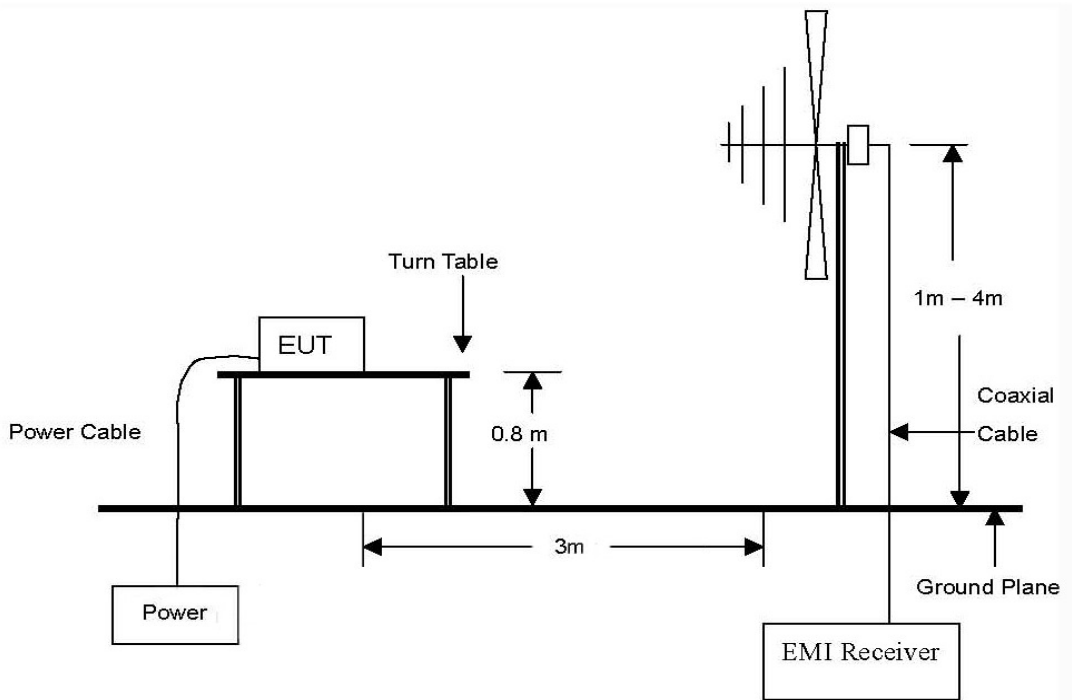

The diagram below shows the test setup that is utilized to make the measurements for emission from 1 GHz to 20 GHz Emissions.

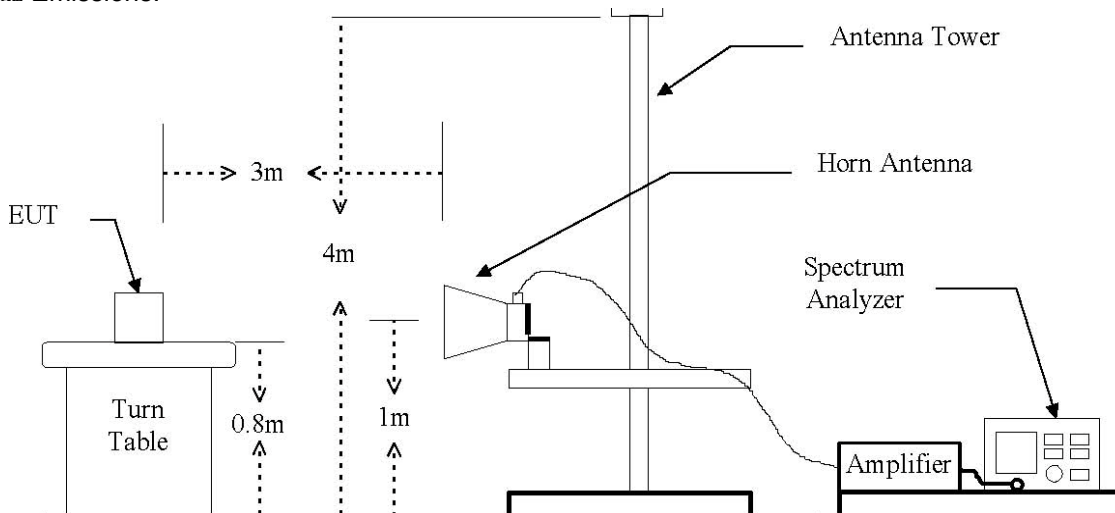

The results shown in this test report refer only to the sample(s) tested unless otherwise stated. This test report cannot be reproduced, except in full, without prior written permission of the Company.

The diagram below shows the test setup for substituted method.

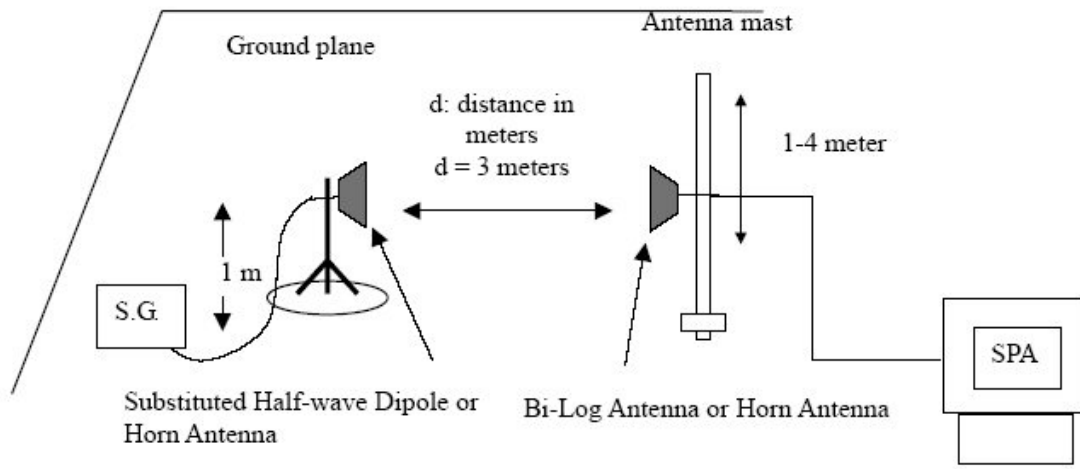

2.2. Limit

2.2.1. Limit of radiated output power

FCC

- §22.913(a)(2), the ERP of mobile transmitters and auxiliary test transmitters must not exceed 7 watts.

- §24.232(c), mobile and portable stations are limited to 2 watts EIRP and the equipment must employ a means for limiting power to the minimum necessary for successful communications.

IC

- RSS-132 Issue 3

5.4, the transmitter output power shall be measured in terms of average power. The equivalent isotropically radiated power (e.i.r.p.) for mobile equipment shall not exceed 11.5 watts. Refer to SRSP-503 for base station e.i.r.p. limits.

- RSS-133 Issue 6

6.4, the equivalent isotropically radiated power (e.i.r.p.) for transmitters shall not exceed the limits given in SRSP-510. Moreover, base station transmitters operating in the band 1 930-1 995 MHz shall not have output power exceeding 100 watts.

The results shown in this test report refer only to the sample(s) tested unless otherwise stated. This test report cannot be reproduced, except in full, without prior written permission of the Company.

2.2.2. Limit of spurious radiated emission

FCC

- §22.917(a), the power of any emission outside of the authorized operating frequency ranges must be attenuated below the transmitting power (P) by a factor of at least $43 + 10 \log(P)$ dB.

- §24.238(a), the power of any emission outside of the authorized operating frequency ranges must be attenuated below the transmitting power (P) by a factor of at least $43 + 10 \log(P)$ dB.

IC

- RSS-132 Issue 3

5.5, Mobile and base station equipment shall comply with the limits in (i) and (ii) below.

(i) In the first 1.0 MHz band immediately outside and adjacent to each of the sub-bands specified in Section 5.1, the power of emissions per any 1 % of the occupied bandwidth shall be attenuated (in dB) below the transmitter output power P (dBW) by at least $43 + 10 \log_{10} p$ (watts).

(ii) After the first 1.0 MHz immediately outside and adjacent to each of the sub-bands, the power of emissions in any 100 kHz bandwidth shall be attenuated (in dB) below the transmitter output power P (dBW) by at least $43 + 10 \log_{10} p$ (watts). If the measurement is performed using 1 % of the occupied bandwidth, power integration over 100 kHz is required.

- RSS-133 Issue 6

6.5, Equipment shall comply with the limits in (i) and (ii) below.

(i) In the 1.0 MHz bands immediately outside and adjacent to the equipment's operating frequency block, the emission power per any 1 % of the emission bandwidth shall be attenuated (in dB) below the transmitter output power P (dBW) by at least $43 + 10 \log_{10} p$ (watts).

(ii) After the first 1.0 MHz, the emission power in any 1 MHz bandwidth shall be attenuated (in dB) below the transmitter output power P (dBW) by at least $43 + 10 \log_{10} p$ (watts). If the measurement is performed using 1 % of the emission bandwidth, power integration over 1.0 MHz is required.

The results shown in this test report refer only to the sample(s) tested unless otherwise stated. This test report cannot be reproduced, except in full, without prior written permission of the Company.

2.3. Test procedure: Based on ANSI/TIA 603C: 2004

1. On a test site, the EUT shall be placed at 80 cm height on a turn table, and in the position close to normal use as declared by the applicant.
2. The test antenna shall be oriented initially for vertical polarization located 3 m from EUT to correspond to the fundamental frequency of the transmitter.
3. The output of the test antenna shall be connected to the measuring receiver and the peak detector is used for the measurement.
4. The maximized power level is recorded using the spectrum analyzer "Channel Power" function with the integration band set to the emissions occupied bandwidth, RBW = 1-5 % of the OBW (not to exceed 1 MHz), VBW $\geq 3 \times$ RBW, Detector = RMS, sweep time = auto, trace average at least 100 traces in power averaging (i.e., RMS) mode, per the guidelines of KDB 971168 D01 v02r02.
5. Radiated spurious emissions measurement method was set as follows:
RBW = 100 kHz for emissions below 1 GHz and 1 MHz for emissions above 1 GHz, VBW $\geq 3 \times$ RBW, Detector = Peak, trace mode = max hold, per the guidelines of KDB 971168 D01 v02r02.
6. The transmitter shall be switched on, the measuring receiver shall be tuned to the frequency of the transmitter under test.
7. The test antenna shall be raised and lowered through the specified range of height until the maximum signal level is detected by the measuring receiver.
8. The transmitter shall be rotated through 360° in the horizontal plane, until the maximum signal level is detected by the measuring receiver.
9. The test antenna shall be raised and lowered again through the specified range of height until the maximum signal level is detected by the measuring receiver.
10. The maximum signal level detected by the measuring receiver shall be noted.
11. The EUT was replaced by half-wave dipole (1 GHz below) or horn antenna (1 GHz above) connected to a signal generator.
12. In necessary, the input attenuator setting on the measuring receiver shall be adjusted in order to increase the sensitivity of the measuring receiver.
13. The test antenna shall be raised and lowered through the specified range of height to ensure that the maximum signal is received.
14. The input signal to the substitution antenna shall be adjusted to the level that produces a level detected by the measuring receiver, which is equal to the level noted while the transmitter radiated power was measured, corrected for the change of input attenuator setting of the measuring receiver.
15. The input level to the substitution antenna shall be recorded as power level in dBm, corrected for any change of input attenuator setting of the measuring receiver.
16. The measurement shall be repeated with the test antenna and the substitution antenna orientated for horizontal polarization.

The results shown in this test report refer only to the sample(s) tested unless otherwise stated. This test report cannot be reproduced, except in full, without prior written permission of the Company.

2.4. Test result for RF radiated output power

Ambient temperature : (23 ± 1) °C
 Relative humidity : 47 % R.H.

WCDMA Band 2

Frequency (MHz)	Ant. Pol. (H/V)	S.G level + Amp. (dB m)	Cable loss (dB)	Ant. gain (dB i)	E.I.R.P.	
					(dB m)	(mW)
1 852.4	V	24.24	4.33	8.54	28.45	699.84
1 852.4	H	21.51	4.33	8.54	25.72	373.25
1 880.0	V	20.29	4.34	8.63	24.58	287.08
1 880.0	H	23.23	4.34	8.63	27.52	564.94
1 907.6	V	21.34	4.36	8.62	25.60	363.08
1 907.6	H	23.83	4.36	8.62	28.09	644.17

WCDMA Band 5

Frequency (MHz)	Ant. Pol. (H/V)	S.G level + Amp. (dB m)	Cable loss (dB)	Ant. gain (dB d)	E.R.P.	
					(dB m)	(mW)
826.4	V	28.42	3.31	-5.18	19.93	98.40
826.4	H	31.09	3.31	-5.18	22.60	181.97
836.6	V	29.33	3.45	-5.14	20.74	118.58
836.6	H	31.52	3.45	-5.14	22.93	196.34
846.6	V	29.08	3.51	-4.25	21.32	135.52
846.6	H	31.12	3.51	-4.25	23.36	216.77

Remark:

1. E.R.P. & E.I.R.P. = [S.G level + Amp.] (dB m) - Cable loss (dB) + Ant. gain (dB d/dB i)

The results shown in this test report refer only to the sample(s) tested unless otherwise stated. This test report cannot be reproduced, except in full, without prior written permission of the Company.

2.5. Spurious radiated emission

- Measured output Power : 28.45 dB m = 0.699 8 W
- Modulation Signal : WCDMA Band 2
- Distance : 3 meters
- Limit : $43 + 10\log_{10}(W) = 41.45$ dB c

Frequency (MHz)	Ant. Pol. (H/V)	S.G level + Amp. (dB m)	Cable loss (dB)	Ant. gain (dB i)	E.I.R.P. (dB m)	dB c	Margin (dB)
Low Channel (1 852.4 MHz)							
3 706.10	V	-49.81	5.99	9.07	-46.73	75.18	33.73
3 706.30	H	-43.22	5.99	9.07	-40.14	68.59	27.14
5 557.69	V	-50.63	7.53	10.64	-47.52	75.97	34.52
5 559.56	H	-49.98	7.53	10.64	-46.87	75.32	33.87
7 410.22	V	-49.69	9.26	12.01	-46.94	75.39	33.94
Middle Channel (1 880.0 MHz)							
3 786.39	V	-48.11	6.39	9.15	-45.35	73.80	32.35
3 787.67	H	-49.83	6.40	9.15	-47.08	75.53	34.08
5 643.85	V	-51.47	7.66	10.93	-48.20	76.65	35.20
5 637.36	H	-49.06	7.64	10.89	-45.81	74.26	32.81
7 522.74	V	-51.90	9.06	11.83	-49.13	77.58	36.13
High Channel (1 907.6 MHz)							
3 813.15	V	-40.03	6.50	9.15	-37.38	65.83	24.38
3 813.90	H	-49.12	6.50	9.15	-46.47	74.92	33.47
5 720.86	V	-49.30	7.85	11.27	-45.88	74.33	32.88
5 719.78	H	-49.71	7.85	11.27	-46.29	74.74	33.29
7 626.57	V	-49.92	9.05	11.75	-47.22	75.67	34.22

The results shown in this test report refer only to the sample(s) tested unless otherwise stated. This test report cannot be reproduced, except in full, without prior written permission of the Company.

- Measured output Power : 23.36 dB m = 0.216 8 W
- Modulation Signal : WCDMA Band 5
- Distance : 3 meters
- Limit : $43 + 10\log_{10}(W) = 36.36$ dB c

Frequency (MHz)	Ant. Pol. (H/V)	S.G level + Amp. (dB m)	Cable loss (dB)	Ant. gain (dB i)	E.I.R.P. (dB m)	dB c	Margin (dB)
Low Channel (826.4 MHz)							
1 650.95	H	-53.84	4.01	6.01	-51.84	75.20	38.84
Middle Channel (836.6 MHz)							
1 673.88	H	-56.31	4.06	6.18	-54.19	77.55	41.19
High Channel (846.6 MHz)							
1 694.81	H	-55.58	4.11	6.34	-53.35	76.71	40.35

Remark:

1. E.R.P. & E.I.R.P. = S.G level (dB m) - Cable loss (dB) + Ant. gain (dB d/dB i)

The results shown in this test report refer only to the sample(s) tested unless otherwise stated. This test report cannot be reproduced, except in full, without prior written permission of the Company.

SGS Korea Co., Ltd. (Gunpo Laboratory) 4, LS-ro 182beon-gil, Gunpo-si, Gyeonggi-do, Korea, 15807 <http://www.sgsgroup.kr>

3. Conducted Output Power

3.1. Limit

CFR 47, Section FCC §2.1046 and IC RSS-Gen Issue 4 6.12.

3.2. Test Procedure

Output power shall be measured at the RF output terminals for all configurations.

1. The RF output of the transmitter was connected to the input of the mobile test unit in order to establish communication with the EUT.
2. The EUT was set up for the max. Output power with pseudo random data modulation by using mobile test unit parameters.
3. The measurement performed using a wideband RF power meter.
4. This EUT was tested under all configurations and the highest power was investigated and reported.

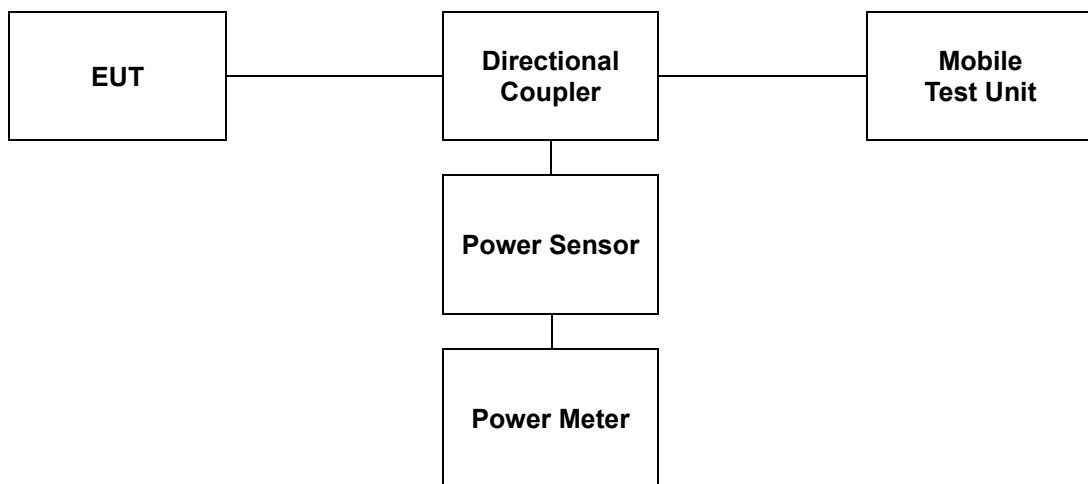

The results shown in this test report refer only to the sample(s) tested unless otherwise stated. This test report cannot be reproduced, except in full, without prior written permission of the Company.

3.3. Test Result

Ambient temperature : (23 ± 1) °C

Relative humidity : 47 % R.H.

- WCDMA Band 2

Band	3GPP Release version	Channel		9262	9400	9538	
		Frequency (MHz)		1 852.4	1 880.0	1 907.6	
2	99	WCDMA	RMC	25.05	24.96	25.03	
	5	HSDPA	Subtest 1	24.98	24.91	24.95	
	5		Subtest 2	24.92	24.88	24.88	
	5		Subtest 3	24.48	24.45	24.49	
	5		Subtest 4	24.43	24.39	24.43	
	6	HSUPA	Subtest 1	24.97	24.90	24.90	
	6		Subtest 2	23.12	23.11	23.05	
	6		Subtest 3	23.91	23.97	23.94	
	6		Subtest 4	23.07	23.07	23.09	
	6		Subtest 5	24.94	24.98	24.91	
	HSPA+				23.14	23.36	23.47

- WCDMA Band 5

Band	3GPP Release version	Channel		4132	4182	4233	
		Frequency (MHz)		826.4	836.6	846.6	
5	99	WCDMA	RMC	24.49	24.46	24.41	
	5	HSDPA	Subtest 1	24.20	24.03	24.02	
	5		Subtest 2	24.17	24.12	24.11	
	5		Subtest 3	23.51	23.51	23.59	
	5		Subtest 4	23.54	23.51	23.57	
	6	HSUPA	Subtest 1	24.28	24.26	24.40	
	6		Subtest 2	22.51	22.51	22.54	
	6		Subtest 3	23.40	23.44	23.47	
	6		Subtest 4	22.51	22.53	22.50	
	6		Subtest 5	24.18	24.20	24.18	
	HSPA+				22.92	22.91	22.90

The results shown in this test report refer only to the sample(s) tested unless otherwise stated. This test report cannot be reproduced, except in full, without prior written permission of the Company.

4. Occupied Bandwidth

4.1. Limit

CFR 47, Section FCC §2.1049 and IC RSS-Gen Issue 4 6.6.

4.2. Test Procedure

FCC

The test follows section 4.2 of FCC KDB Publication 971168 D01 v02r02.

1. Set span = 2 – 5 x OBW.
2. Set resolution bandwidth (RBW) = 1 – 5 % of OBW.
3. Set video bandwidth (VBW) $\geq 3 \times$ RBW.
4. Detector = Peak.
5. Trace mode = Max hold.
6. Use the 99 % power bandwidth function of the spectrum analyzer (if available) and report the measured bandwidth.

IC

The span of the analyzer shall be set to capture all products of the modulation process, including the emission skirts.

The resolution bandwidth (RBW) shall be in the range of 1 % to 5 % of the occupied bandwidth (OBW) and video bandwidth (VBW) shall be approximately 3 x RBW. Detector = sampling, Trace mode = max hold.

The trace data points are recovered and are directly summed in linear power level terms. The recovered amplitude data points, beginning at the lowest frequency, are placed in a running sum until 0.5 % of the total is reached and that frequency recorded. The process is repeated for the highest frequency data points (starting at the highest frequency, at the right side of the span, and going down in frequency).

This frequency is then recorded.

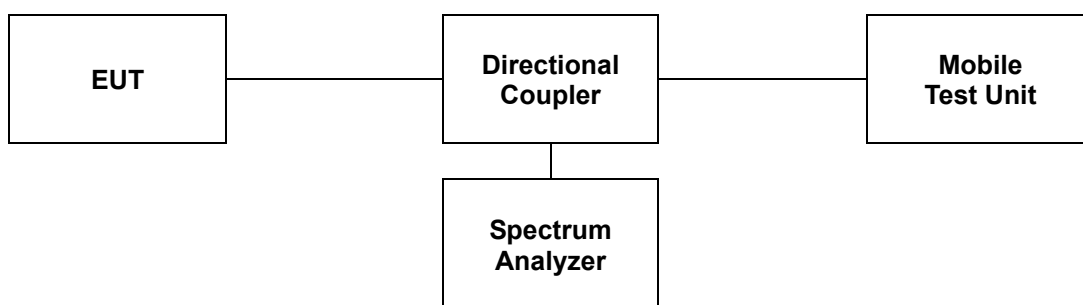

The results shown in this test report refer only to the sample(s) tested unless otherwise stated. This test report cannot be reproduced, except in full, without prior written permission of the Company.

4.3 Test Results

Ambient temperature : (23 ± 1) °C
 Relative humidity : 47 % R.H.

- WCDMA

Band	Mode	Frequency (MHz)	Occupied Bandwidth (MHz)	
			FCC	IC
2	RMC	1 852.4	4.12	4.12
		1 880.0	4.12	4.11
		1 907.6	4.14	4.14
5	RMC	826.4	4.14	4.15
		836.6	4.14	4.14
		846.6	4.17	4.14

The results shown in this test report refer only to the sample(s) tested unless otherwise stated. This test report cannot be reproduced, except in full, without prior written permission of the Company.

FCC

WCDMA Band 2 Low Channel

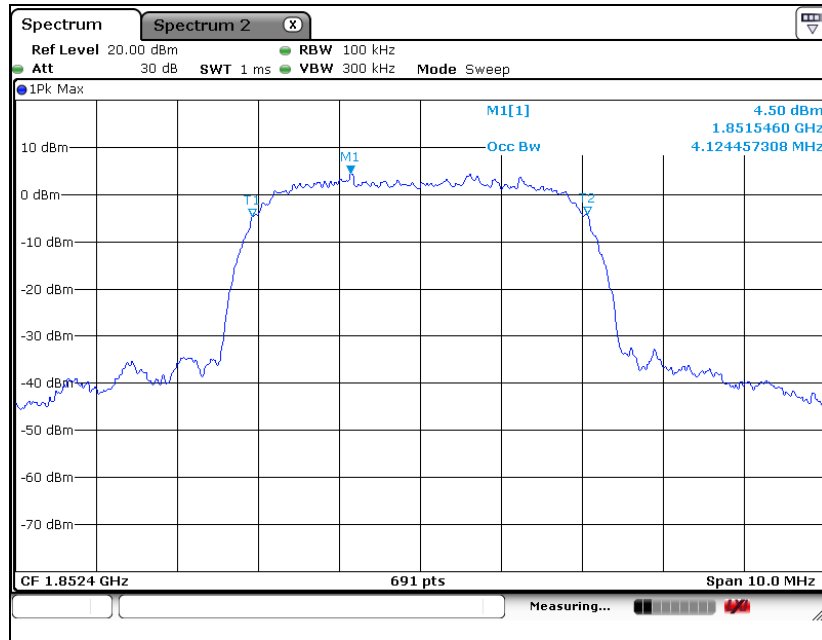

Middle Channel

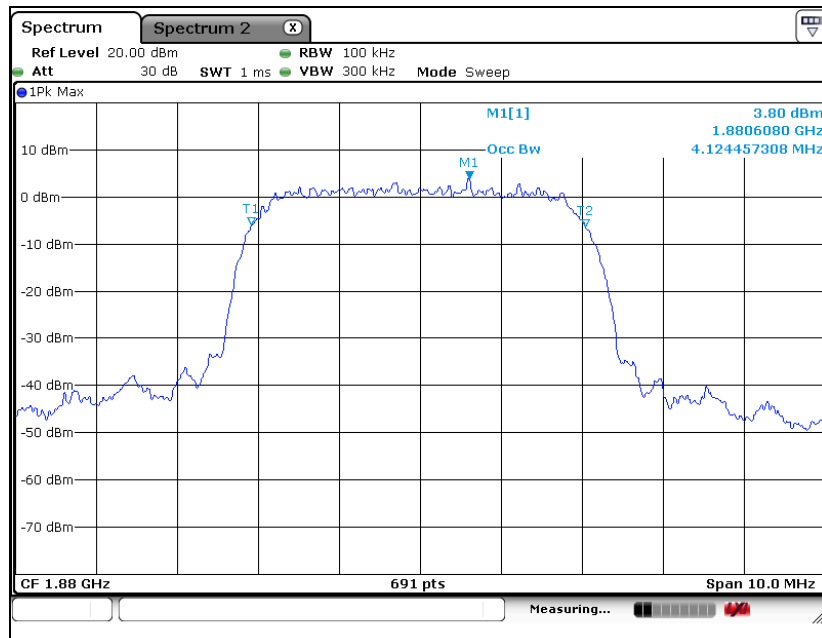

The results shown in this test report refer only to the sample(s) tested unless otherwise stated. This test report cannot be reproduced, except in full, without prior written permission of the Company.

High Channel

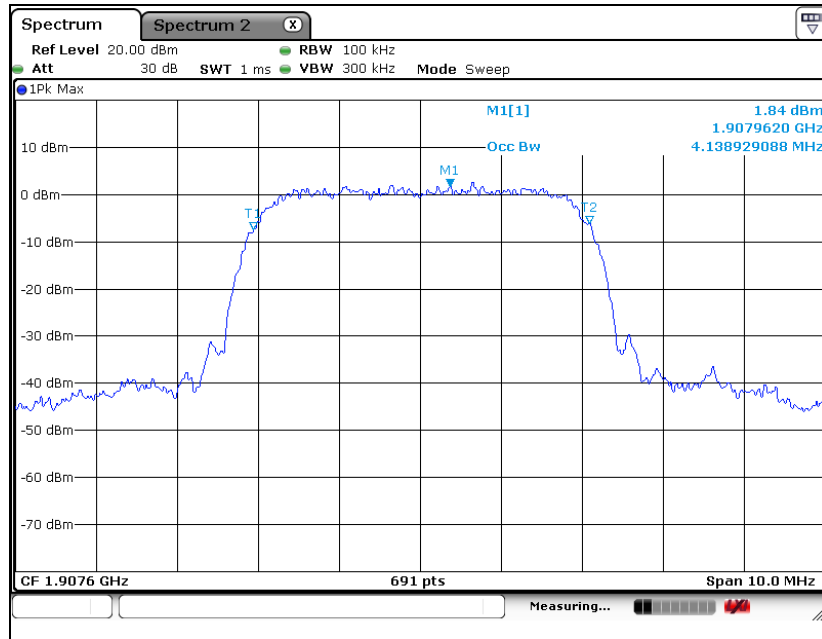

The results shown in this test report refer only to the sample(s) tested unless otherwise stated. This test report cannot be reproduced, except in full, without prior written permission of the Company.

WCDMA Band 5
Low Channel

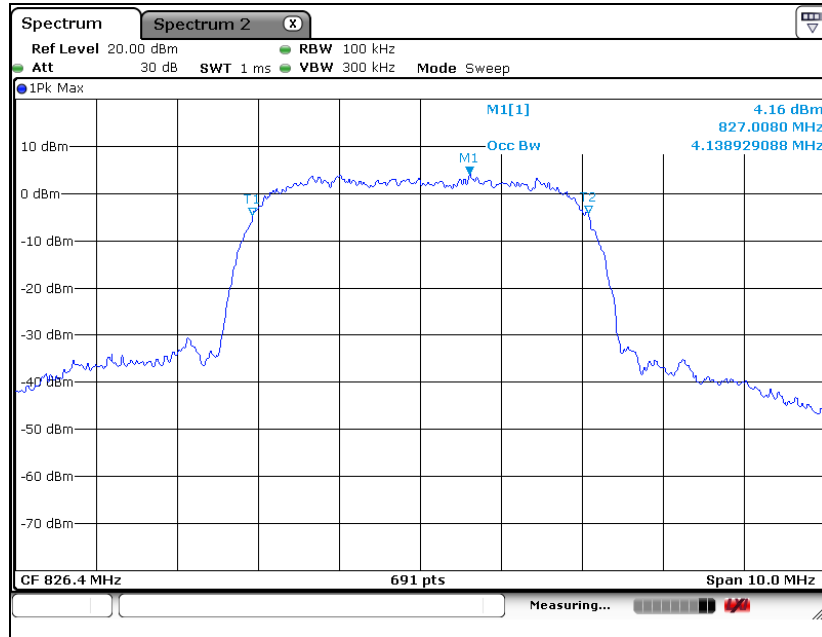

Middle Channel

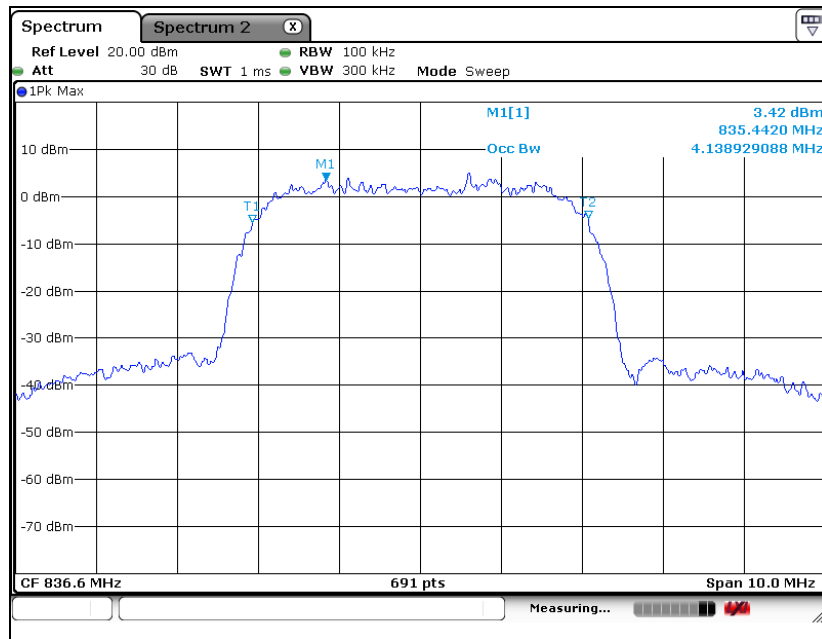

The results shown in this test report refer only to the sample(s) tested unless otherwise stated. This test report cannot be reproduced, except in full, without prior written permission of the Company.

High Channel

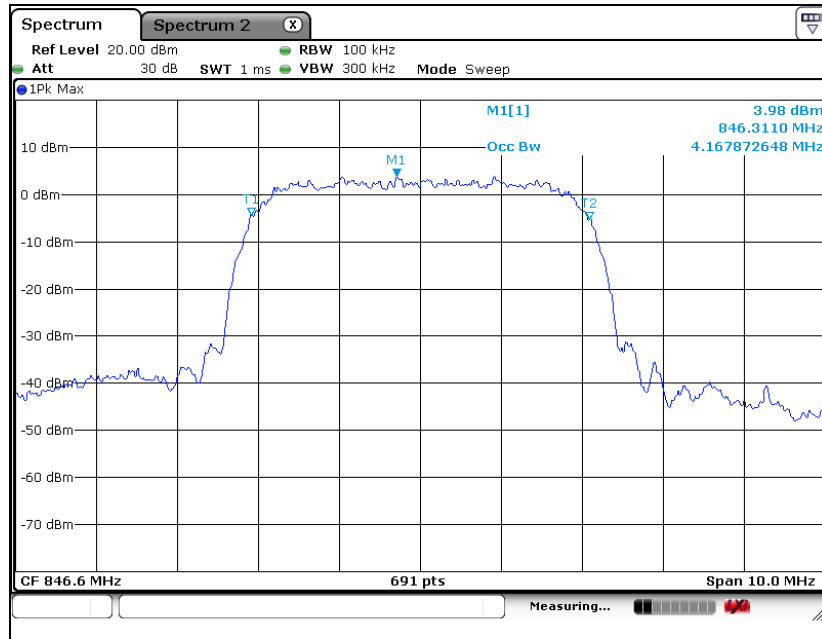

The results shown in this test report refer only to the sample(s) tested unless otherwise stated. This test report cannot be reproduced, except in full, without prior written permission of the Company.

IC

WCDMA Band 2 Low Channel

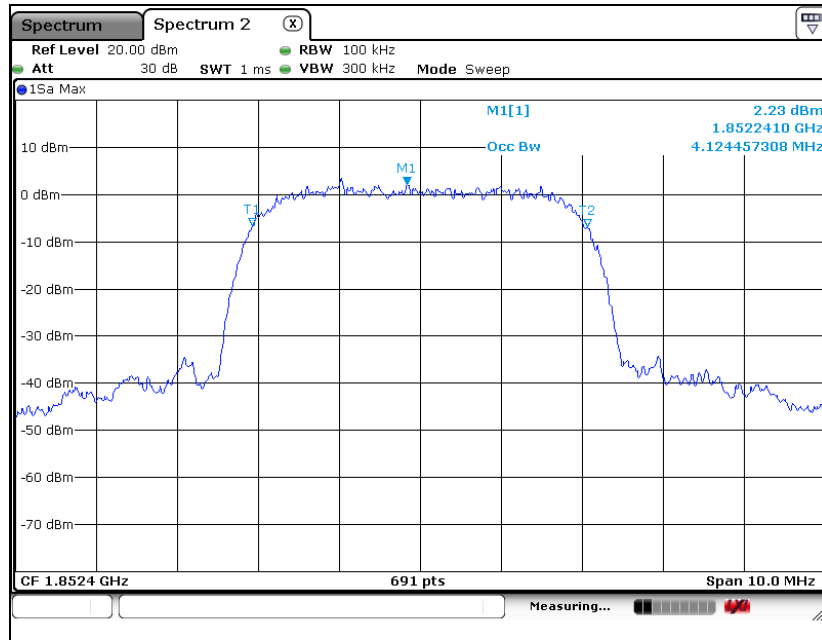

Middle Channel

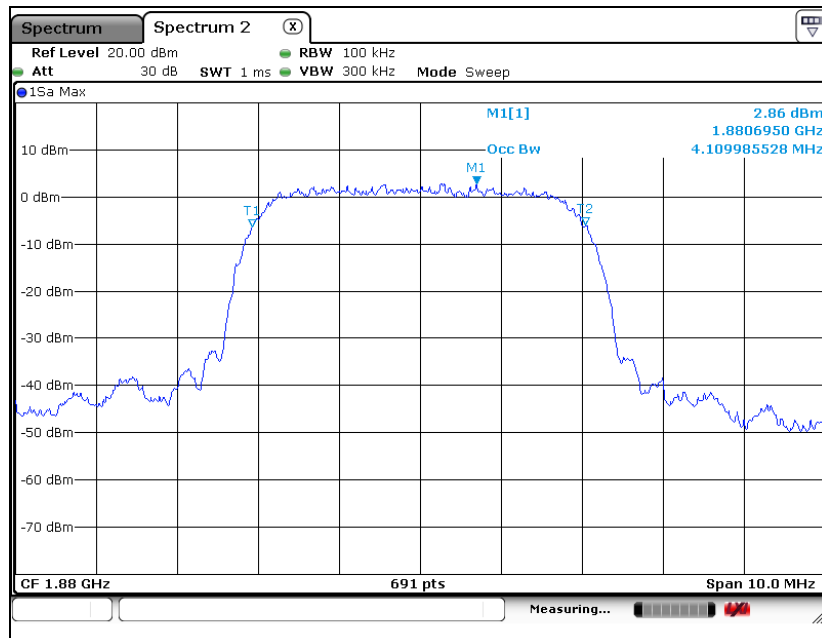

The results shown in this test report refer only to the sample(s) tested unless otherwise stated. This test report cannot be reproduced, except in full, without prior written permission of the Company.

High Channel

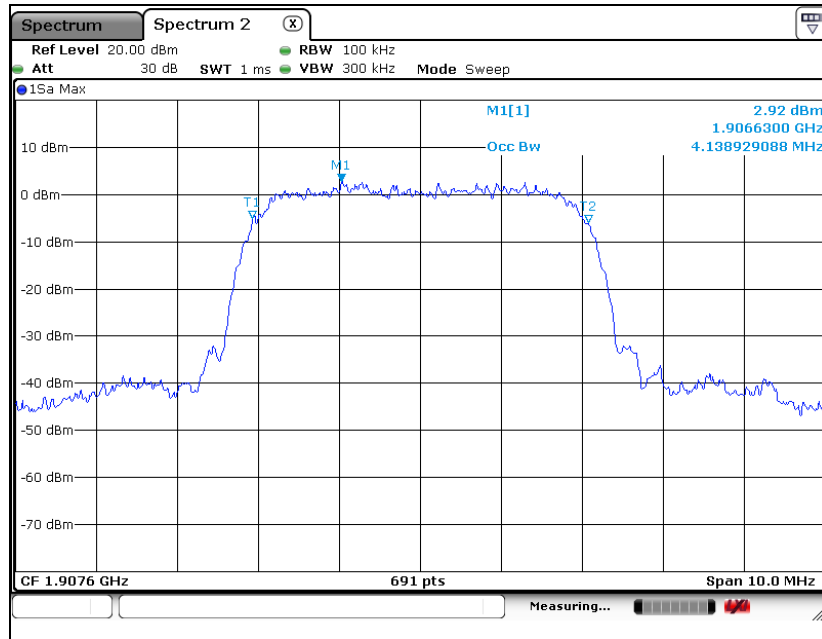

The results shown in this test report refer only to the sample(s) tested unless otherwise stated. This test report cannot be reproduced, except in full, without prior written permission of the Company.

WCDMA Band 5 Low Channel

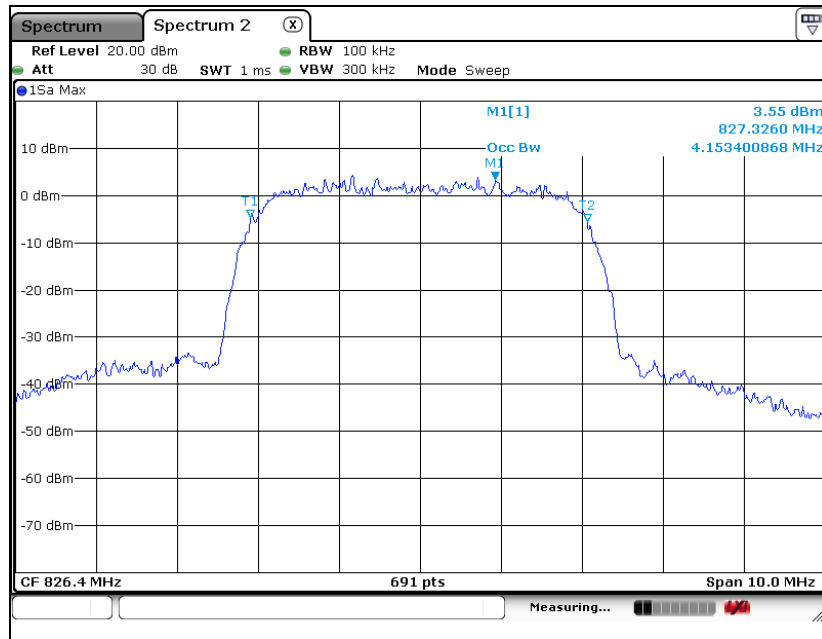

Middle Channel

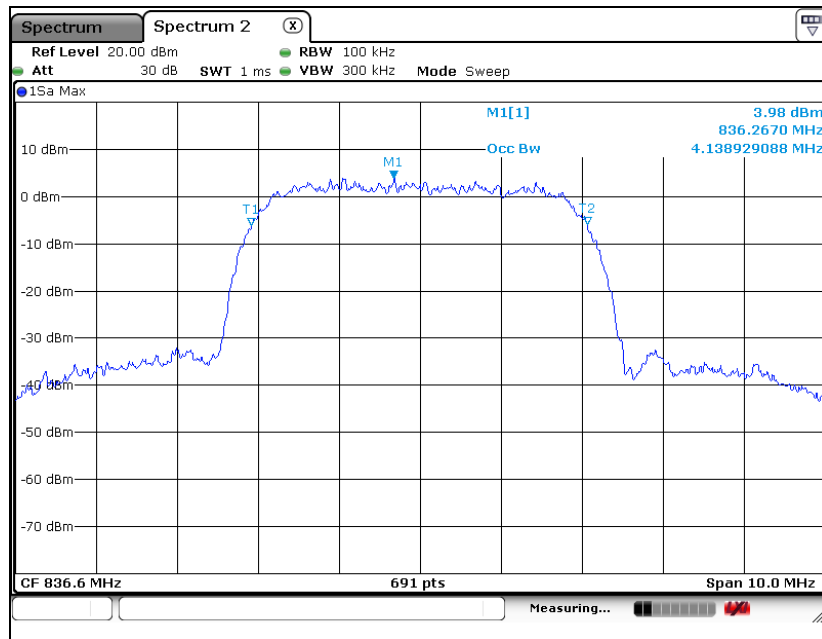

The results shown in this test report refer only to the sample(s) tested unless otherwise stated. This test report cannot be reproduced, except in full, without prior written permission of the Company.

High Channel

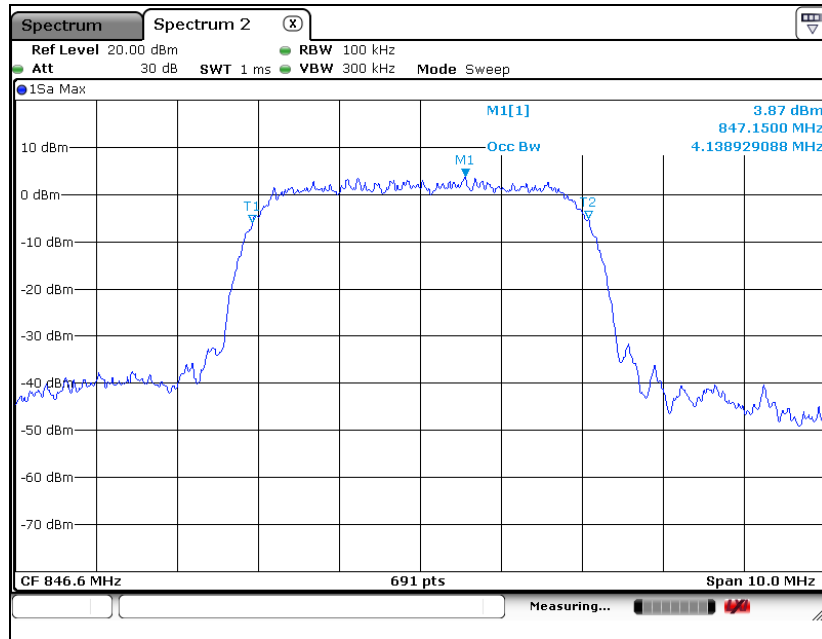

The results shown in this test report refer only to the sample(s) tested unless otherwise stated. This test report cannot be reproduced, except in full, without prior written permission of the Company.

5. Peak-Average Ratio

5.1. Limit

FCC

- §24.232(d), power measurements for transmissions by stations authorized under this section may be made either in accordance with a Commission-approved average power technique or in compliance with paragraph (e) of this section. In both instances, equipment employed must be authorized in accordance with the provisions of §24.51. In measuring transmissions in this band using an average power technique, the peak-to-average ratio (PAR) of the transmission may not exceed 13 dB.

IC

- RSS-132 Issue 3

5.4, the peak-to-average power ratio (PAPR) of the transmitter shall not exceed 13 dB for more than 0.1 % of the time using a signal corresponding to the highest PAPR during periods of continuous transmission.

- RSS-133 Issue 6

6.4, the transmitter's peak-to-average power ratio (PAPR) shall not exceed 13 dB for more than 0.1 % of the time using a signal corresponding to the highest PAPR during periods of continuous transmission.

5.2. Test Procedure

The test follows section 5.7.1 of FCC KDB Publication 971168 D01 v02r02.

1. Refer to instrument's analyzer instruction manual for details on how to use the power statistics/CCDF function.
2. Set resolution/measurement bandwidth \geq signal's occupied bandwidth.
3. Set the number of counts to a value that stabilizes the measured CCDF curve.
4. Set the measurement interval as follows:
 - a) for continuous transmissions, set to 1 ms.
 - b) for burst transmissions, employ an external trigger that is synchronized with the EUT burst timing sequence, or use the internal burst trigger with a trigger level that allows the burst to stabilize and set the measurement interval to a time that is less than or equal to the burst duration.
5. Record the maximum PAPR level associated with a probability of 0.1 %.

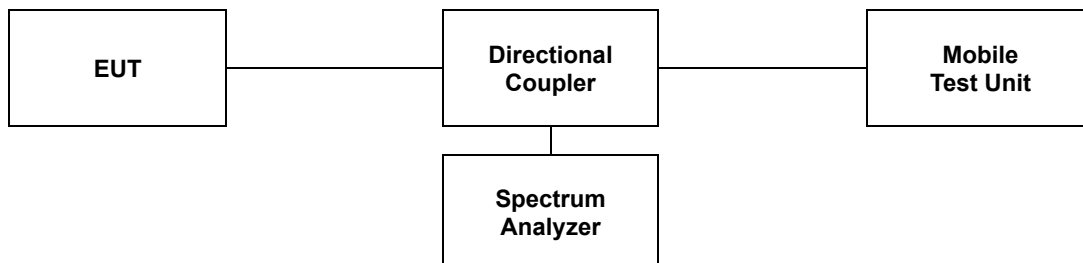

The results shown in this test report refer only to the sample(s) tested unless otherwise stated. This test report cannot be reproduced, except in full, without prior written permission of the Company.

5.3 Test Results

Ambient temperature : (23 ± 1) °C
 Relative humidity : 47 % R.H.

- WCDMA

Band	Mode	Frequency (MHz)	PAR (dB)
2	RMC	1 852.4	2.75
		1 880.0	2.99
		1 907.6	3.16
5	RMC	826.4	2.84
		836.6	2.55
		846.6	3.04

The results shown in this test report refer only to the sample(s) tested unless otherwise stated. This test report cannot be reproduced, except in full, without prior written permission of the Company.

WCDMA Band 2
Low Channel

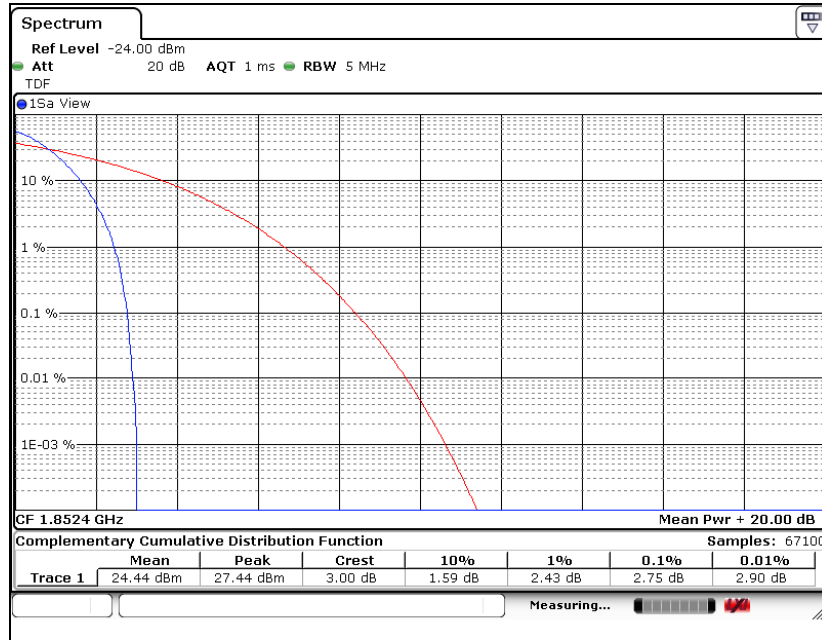

Middle Channel

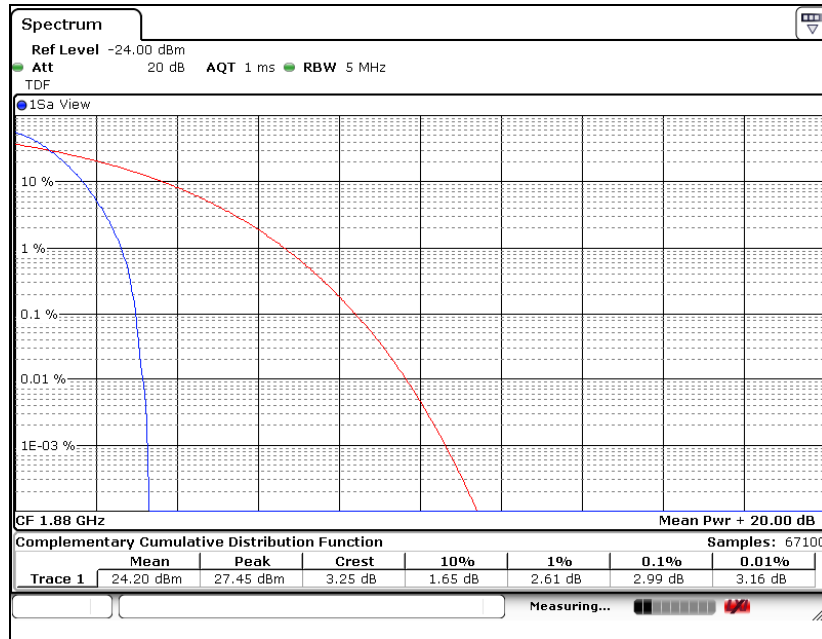

The results shown in this test report refer only to the sample(s) tested unless otherwise stated. This test report cannot be reproduced, except in full, without prior written permission of the Company.

High Channel

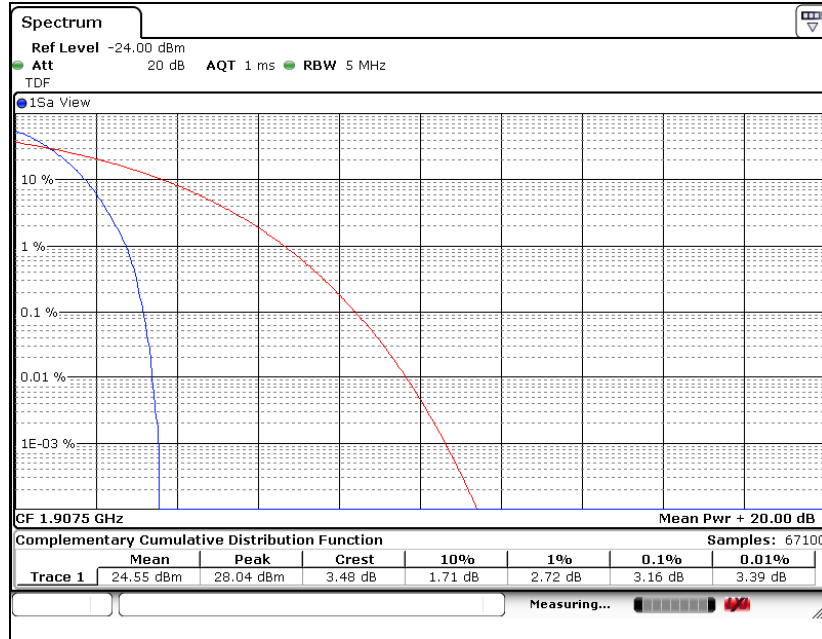

The results shown in this test report refer only to the sample(s) tested unless otherwise stated. This test report cannot be reproduced, except in full, without prior written permission of the Company.

WCDMA Band 5
Low Channel

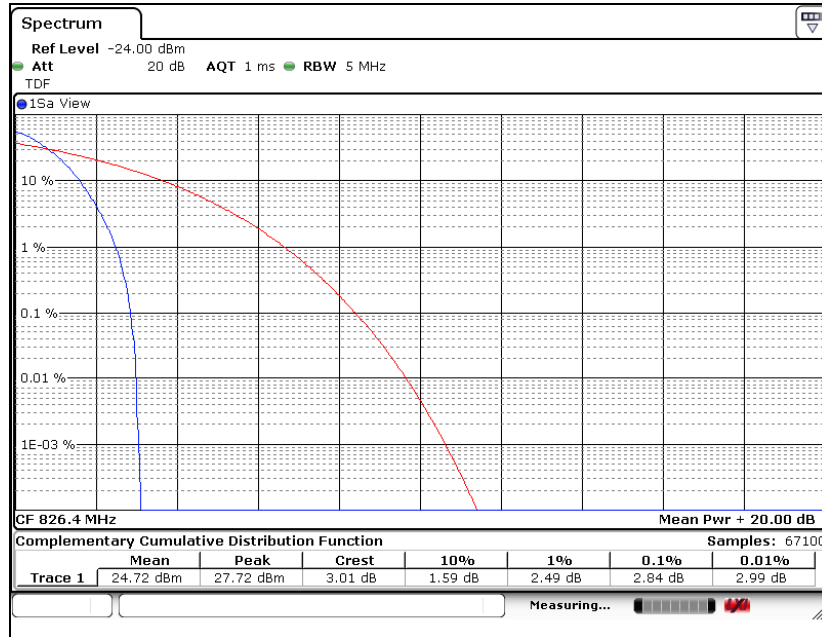

Middle Channel

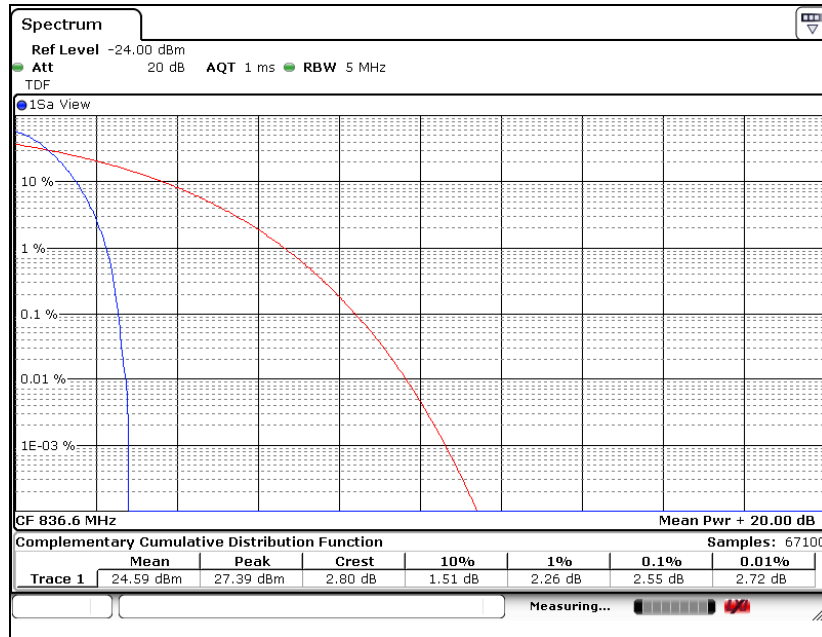

The results shown in this test report refer only to the sample(s) tested unless otherwise stated. This test report cannot be reproduced, except in full, without prior written permission of the Company.

High Channel

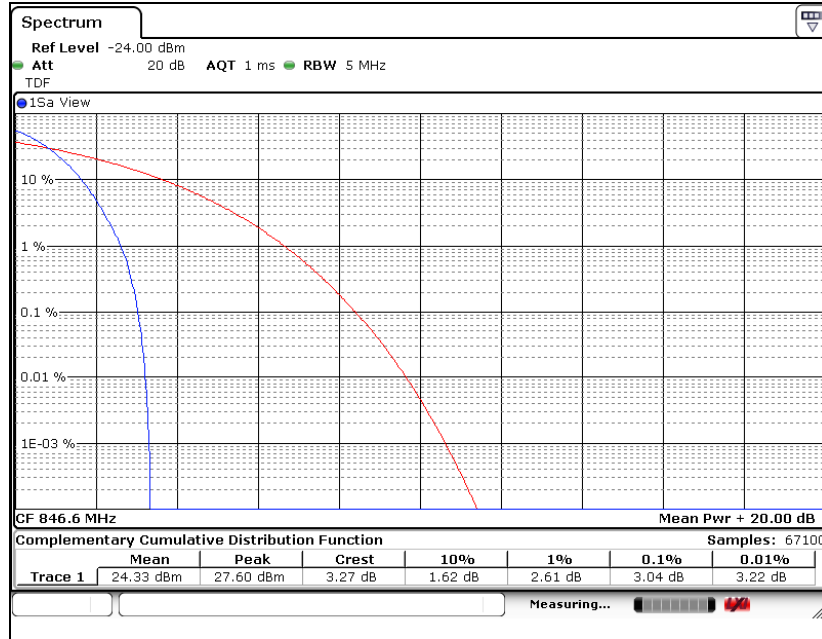

The results shown in this test report refer only to the sample(s) tested unless otherwise stated. This test report cannot be reproduced, except in full, without prior written permission of the Company.

6. Spurious Emissions at Antenna Terminal

6.1. Limit

FCC

- §22.917(a), the power of any emission outside of the authorized operating frequency ranges must be attenuated below the transmitting power (P) by a factor of at least $43 + 10 \log(P)$ dB.

- §24.238(a), the power of any emission outside of the authorized operating frequency ranges must be attenuated below the transmitting power (P) by a factor of at least $43 + 10 \log(P)$ dB.

IC

- RSS-132 Issue 3

5.5, Mobile and base station equipment shall comply with the limits in (i) and (ii) below.

(i) In the first 1.0 MHz band immediately outside and adjacent to each of the sub-bands specified in Section 5.1, the power of emissions per any 1 % of the occupied bandwidth shall be attenuated (in dB) below the transmitter output power P (dBW) by at least $43 + 10 \log_{10} p$ (watts).

(ii) After the first 1.0 MHz immediately outside and adjacent to each of the sub-bands, the power of emissions in any 100 kHz bandwidth shall be attenuated (in dB) below the transmitter output power P (dB W) by at least $43 + 10 \log_{10} p$ (watts). If the measurement is performed using 1 % of the occupied bandwidth, power integration over 100 kHz is required.

- RSS-133 Issue 6

6.5, Equipment shall comply with the limits in (i) and (ii) below.

(i) In the 1.0 MHz bands immediately outside and adjacent to the equipment's operating frequency block, the emission power per any 1 % of the emission bandwidth shall be attenuated (in dB) below the transmitter output power P (dBW) by at least $43 + 10 \log_{10} p$ (watts).

(ii) After the first 1.0 MHz, the emission power in any 1 MHz bandwidth shall be attenuated (in dB) below the transmitter output power P (dBW) by at least $43 + 10 \log_{10} p$ (watts). If the measurement is performed using 1 % of the emission bandwidth, power integration over 1.0 MHz is required.

The results shown in this test report refer only to the sample(s) tested unless otherwise stated. This test report cannot be reproduced, except in full, without prior written permission of the Company.

SGS Korea Co., Ltd. (Gunpo Laboratory) 4, LS-ro 182beon-gil, Gunpo-si, Gyeonggi-do, Korea, 15807 <http://www.sgsgroup.kr>

RTT5041-20(2015.10.01)(3)

Tel. +82 31 428 5700 / Fax. +82 31 427 2370

A4(210 mm x 297 mm)

6.2. Test Procedure

The test follows section 6.0 of FCC KDB Publication 971168 D01 v02r02.

1. Start frequency was set to 30 MHz and stop frequency was set to at least 10* the fundamental frequency.
2. Detector = Peak.
3. Trace mode = Max hold.
4. Sweep time = Auto couple.
5. The trace was allowed to stabilize.
6. Please see notes below for RBW and VBW settings.
7. For plots showing conducted spurious emissions from 30 MHz to 20 GHz, all path loss of wide frequency range was investigated and compensated to spectrum analyzer as correction factor.

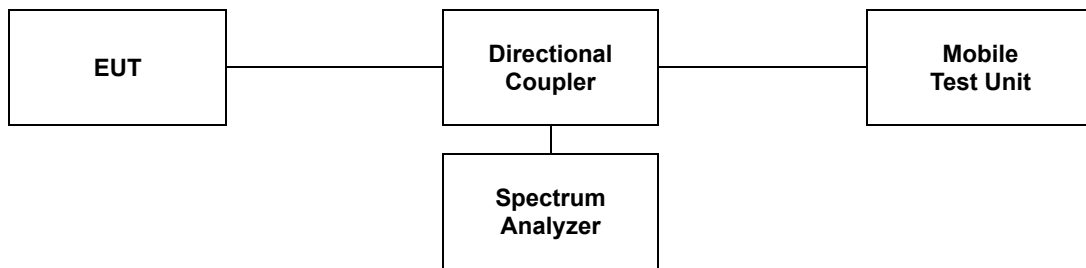

Notes;

Compliance with the applicable limits is based on the use of measurement instrumentation employing a resolution bandwidth of 100 kHz or greater for frequencies less than 1 GHz and frequencies greater than 1 GHz. However, in the 1 MHz bands immediately outside and adjacent to the frequency block a resolution bandwidth of at least one percent of the emission bandwidth of the fundamental emission of the transmitter may be employed. The emission bandwidth is defined as the width of the signal between two point, one below the carrier center frequency and one above the carrier center frequency, outside of which all emission are attenuated at least 26 dB below the transmitter power.

The results shown in this test report refer only to the sample(s) tested unless otherwise stated. This test report cannot be reproduced, except in full, without prior written permission of the Company.

6.3. Test Results

Ambient temperature : (23 ± 1) °C
 Relative humidity : 47 % R.H.

Please refer to the following plots.

WCDMA Band 2 Low Channel

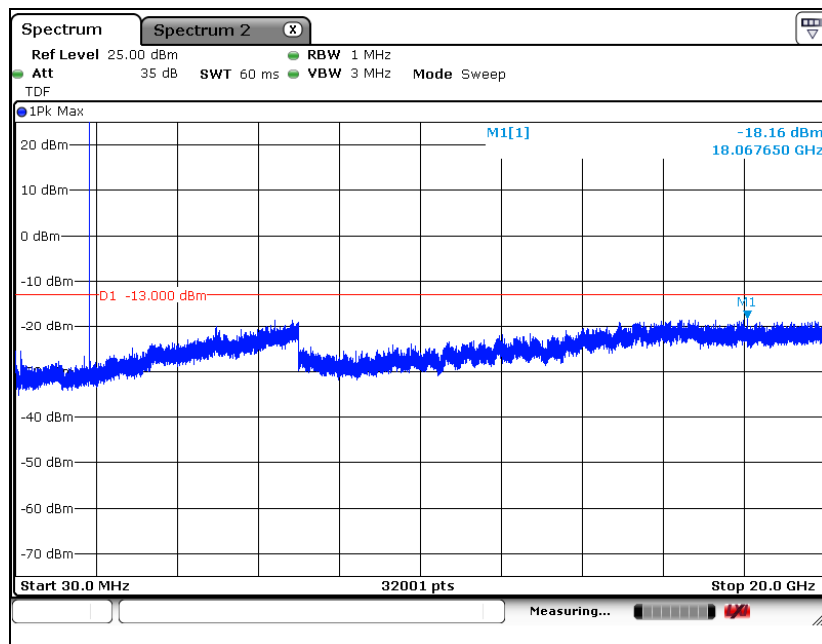

Middle Channel

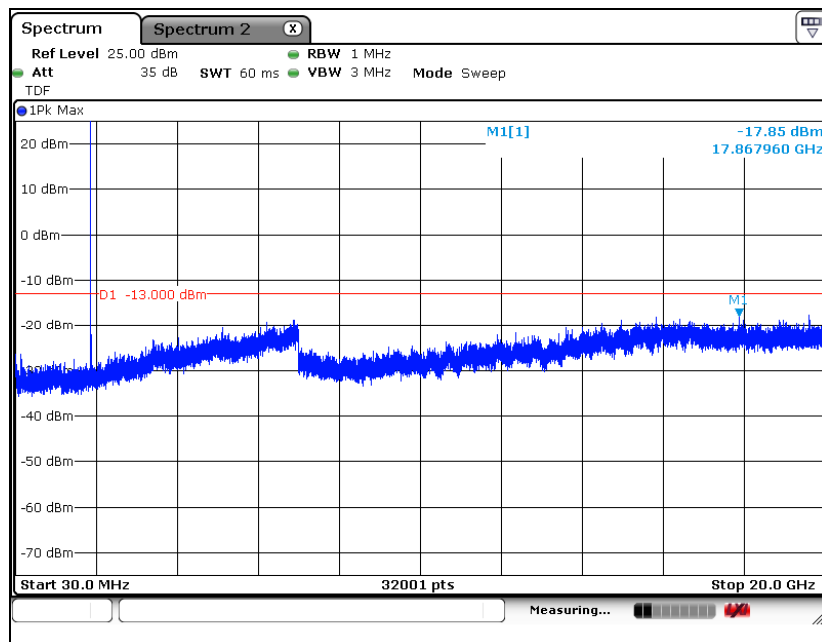

The results shown in this test report refer only to the sample(s) tested unless otherwise stated. This test report cannot be reproduced, except in full, without prior written permission of the Company.

High Channel

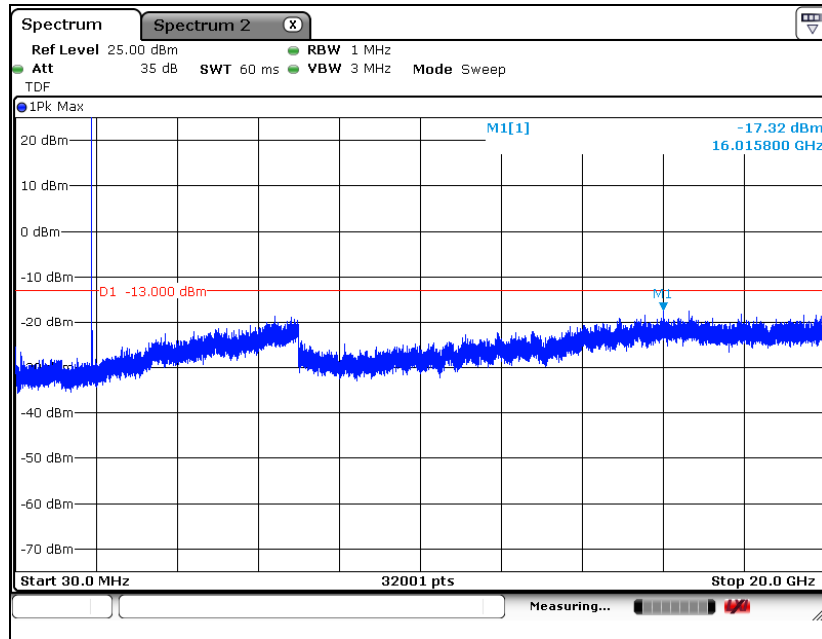

The results shown in this test report refer only to the sample(s) tested unless otherwise stated. This test report cannot be reproduced, except in full, without prior written permission of the Company.

WCDMA Band 5
Low Channel

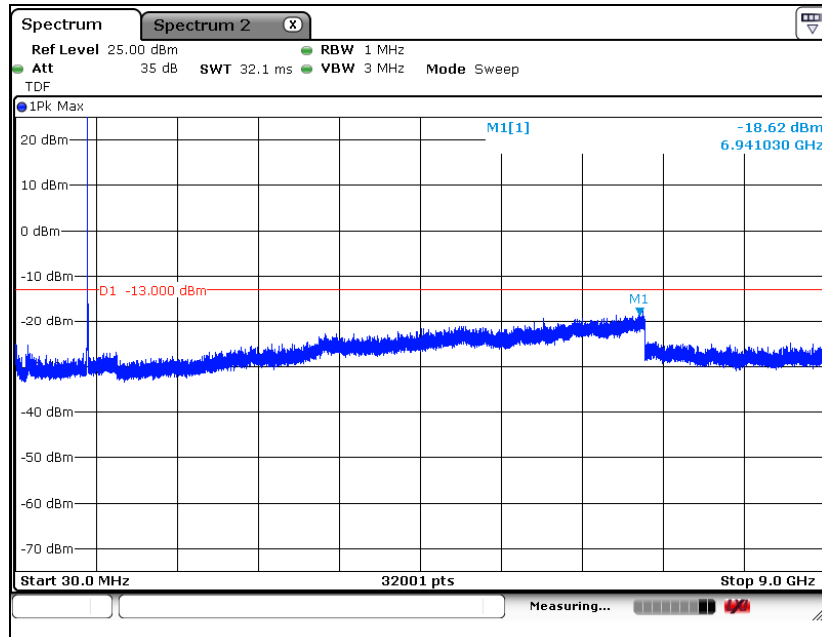

Middle Channel

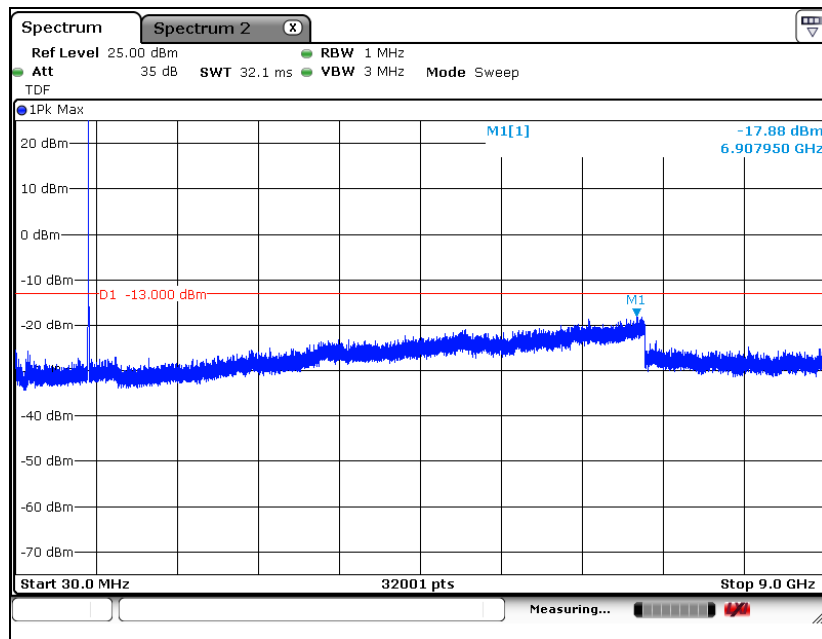

The results shown in this test report refer only to the sample(s) tested unless otherwise stated. This test report cannot be reproduced, except in full, without prior written permission of the Company.

High Channel

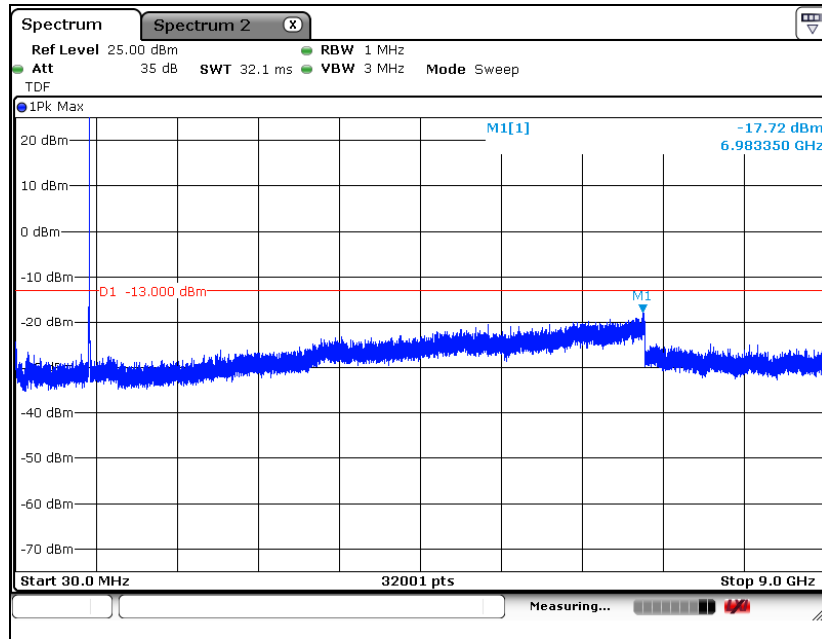

The results shown in this test report refer only to the sample(s) tested unless otherwise stated. This test report cannot be reproduced, except in full, without prior written permission of the Company.

7. Band Edge

7.1. Limit

FCC

- §22.917(a), the power of any emission outside of the authorized operating frequency ranges must be attenuated below the transmitting power (P) by a factor of at least $43 + 10 \log(P)$ dB.

- §24.238(a), the power of any emission outside of the authorized operating frequency ranges must be attenuated below the transmitting power (P) by a factor of at least $43 + 10 \log(P)$ dB.

IC

- RSS-132 Issue 3

5.5, Mobile and base station equipment shall comply with the limits in (i) and (ii) below.

(i) In the first 1.0 MHz band immediately outside and adjacent to each of the sub-bands specified in Section 5.1, the power of emissions per any 1 % of the occupied bandwidth shall be attenuated (in dB) below the transmitter output power P (dBW) by at least $43 + 10 \log_{10} p$ (watts).

(ii) After the first 1.0 MHz immediately outside and adjacent to each of the sub-bands, the power of emissions in any 100 kHz bandwidth shall be attenuated (in dB) below the transmitter output power P (dB W) by at least $43 + 10 \log_{10} p$ (watts). If the measurement is performed using 1 % of the occupied bandwidth, power integration over 100 kHz is required.

- RSS-133 Issue 6

6.5, Equipment shall comply with the limits in (i) and (ii) below.

(i) In the 1.0 MHz bands immediately outside and adjacent to the equipment's operating frequency block, the emission power per any 1 % of the emission bandwidth shall be attenuated (in dB) below the transmitter output power P (dBW) by at least $43 + 10 \log_{10} p$ (watts).

(ii) After the first 1.0 MHz, the emission power in any 1 MHz bandwidth shall be attenuated (in dB) below the transmitter output power P (dBW) by at least $43 + 10 \log_{10} p$ (watts). If the measurement is performed using 1 % of the emission bandwidth, power integration over 1.0 MHz is required.

The results shown in this test report refer only to the sample(s) tested unless otherwise stated. This test report cannot be reproduced, except in full, without prior written permission of the Company.

7.2. Test Procedure

The test follows section 6.0 of FCC KDB Publication 971168 D01 v02r02.

1. Span was set large enough so as to capture all out of band emissions near the band edge.
2. RBW $\geq 1\%$ of OBW
3. VBW $\geq 3 \times$ RBW.
4. Detector = RMS.
5. Trace mode = Trace average.
6. Sweep time = Auto.
7. The trace was allowed to stabilize.
8. All path loss of frequency range was investigated and compensated to spectrum analyzer as correction factor.

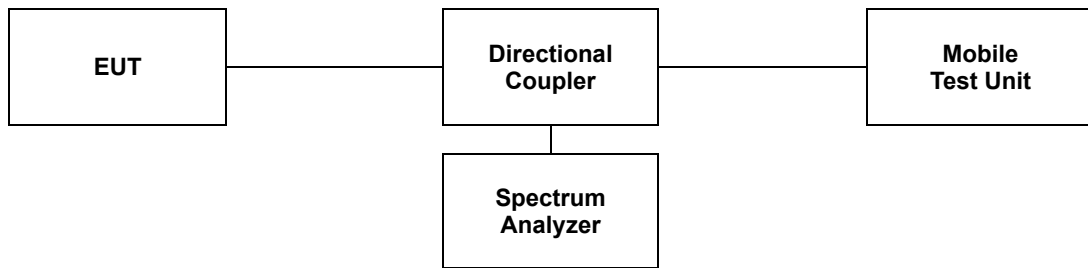

The results shown in this test report refer only to the sample(s) tested unless otherwise stated. This test report cannot be reproduced, except in full, without prior written permission of the Company.

7.3. Test Results

Ambient temperature : (23 ± 1) °C
 Relative humidity : 47 % R.H.

Please refer to the following plots.

WCDMA Band 2 Low Channel

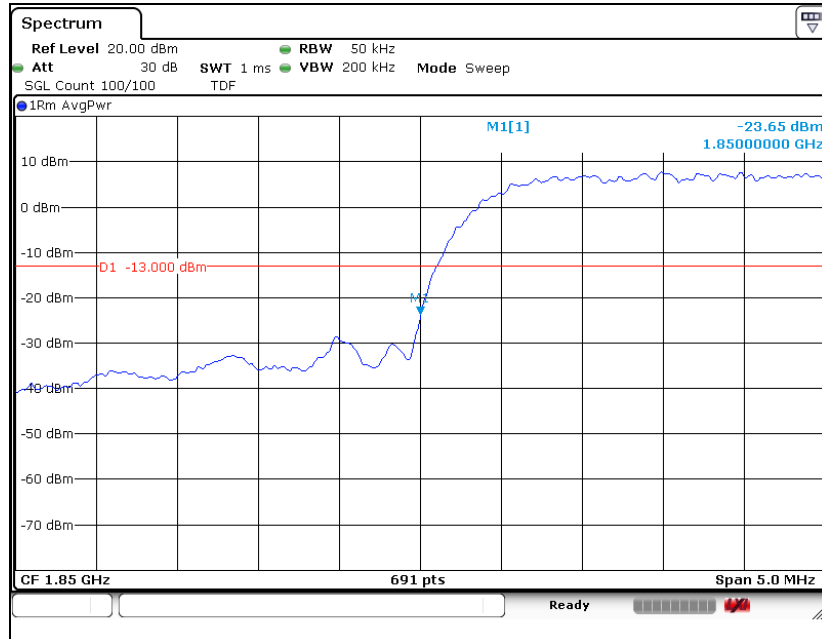

High Channel

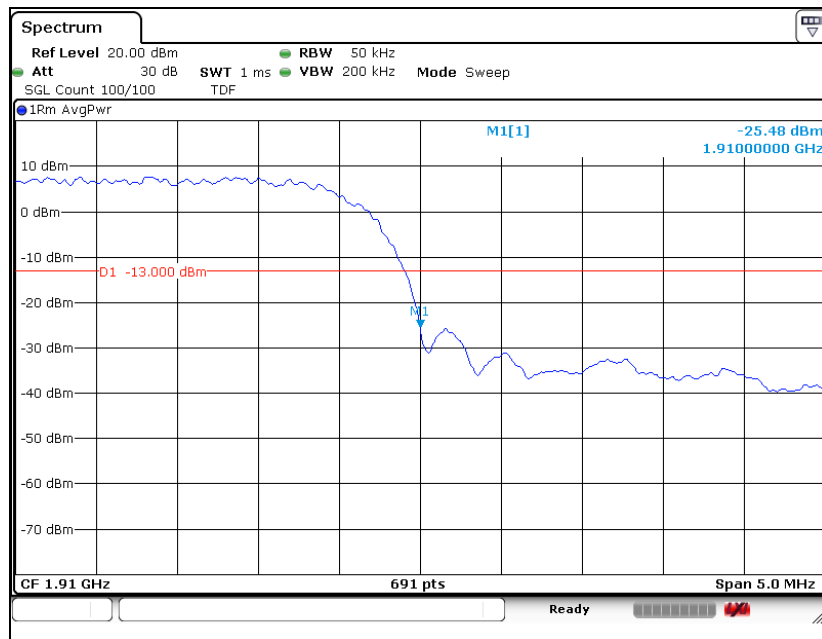

The results shown in this test report refer only to the sample(s) tested unless otherwise stated. This test report cannot be reproduced, except in full, without prior written permission of the Company.

WCDMA Band 5
Low Channel

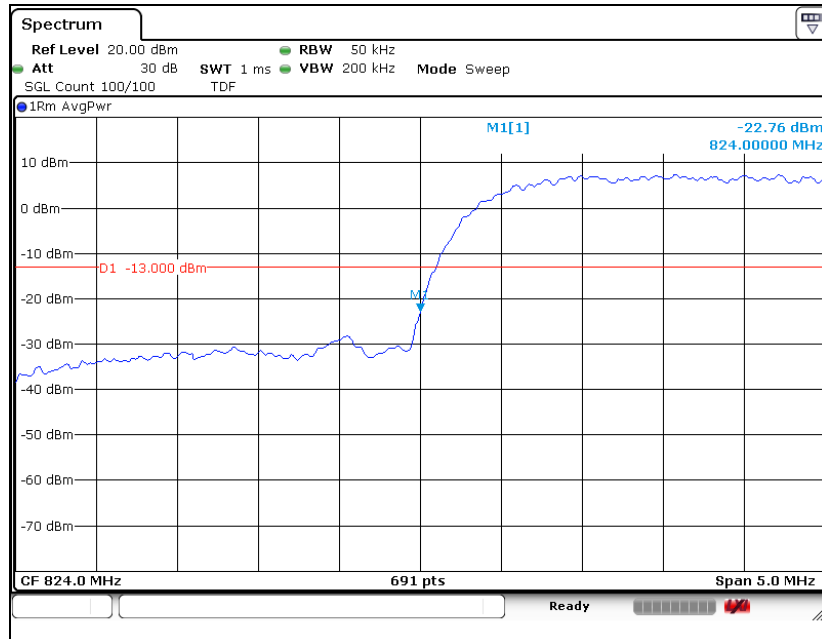

High Channel

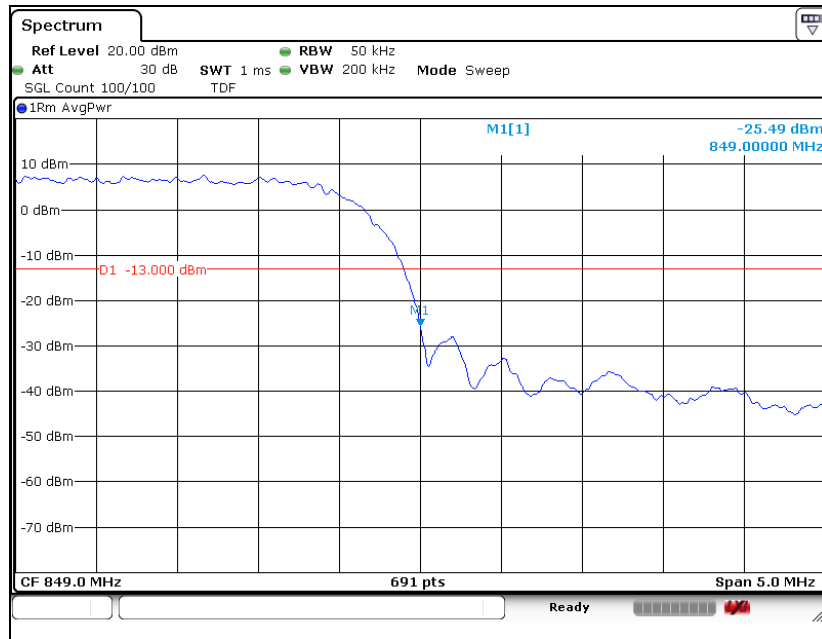

The results shown in this test report refer only to the sample(s) tested unless otherwise stated. This test report cannot be reproduced, except in full, without prior written permission of the Company.

8. Frequency Stability

8.1. Limit

FCC

- § 2.1055 (a), § 2.1055 (d) & following:

- §22.355, the carrier frequency of each transmitter in the Public Mobile Services must be maintained within the tolerances given in Table of this section.

For Mobile devices operating in the 824 to 849 MHz band at a power level less than or equal to 3 Watts, the limit specified in Table C-1 is +/- 2.5 ppm.

- §24.235, the frequency stability shall be sufficient to ensure that the fundamental emission stays within the authorized frequency block.

IC

- RSS-132 Issue 3

5.3, The carrier frequency shall not depart from the reference frequency in excess of ±2.5 ppm for mobile stations and ±1.5 ppm for base stations.

- RSS-133 Issue 6

6.3, the carrier frequency shall not depart from the reference frequency, in excess of ±2.5 ppm for mobile stations and ±1.0 ppm for base stations.

8.2. Test Procedure

1. Frequency Stability vs. Temperature: The equipment under test was connected to an external DC power supply and the RF output was connected to a Mobile Test Unit via feed-through attenuators.
2. The EUT was placed inside the temperature chamber.
3. After the temperature stabilized for approximately 20 minutes, the frequency output was recorded from Mobile Test Unit.

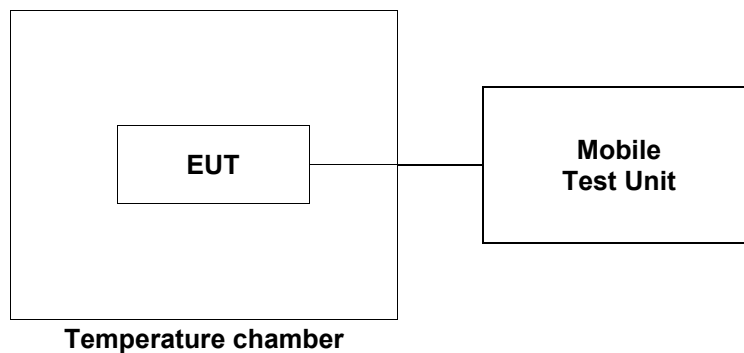

The results shown in this test report refer only to the sample(s) tested unless otherwise stated. This test report cannot be reproduced, except in full, without prior written permission of the Company.

8.3. Test Results

Ambient temperature : (23 ± 1) °C
 Relative humidity : 47 % R.H.

WCDMA Band 2 mode at middle channel

Reference Frequency: 1 880.0 MHz			
Frequency Stability versus Temperature			
Environment Temperature (°C)	Power Supplied (V _{dc})	Frequency Measure with Time Elapse	
		Frequency Error (Hz)	ppm
70	4	3	0.001 6
60		4	0.002 1
50		-1	-0.000 5
40		5	0.002 7
30		5	0.002 7
23		1	0.000 5
10		7	0.003 7
0		-4	-0.002 1
-10		-4	-0.002 1
-20		-7	-0.003 7
-30		2	0.001 1
Frequency Stability versus Power Supply			
Environment Temperature (°C)	Power Supplied (V _{dc})	Frequency Measure with Time Elapse	
		Frequency Error (Hz)	ppm
23	4.6	4	0.002 1
	3.4	6	0.003 2

The results shown in this test report refer only to the sample(s) tested unless otherwise stated. This test report cannot be reproduced, except in full, without prior written permission of the Company.

WCDMA Band 5 mode at middle channel

Reference Frequency: 836.6 MHz			
Frequency Stability versus Temperature			
Environment Temperature (°C)	Power Supplied (V _{dc})	Frequency Measure with Time Elapse	
		Frequency Error (Hz)	ppm
70	4	5	0.006 0
60		-4	-0.004 8
50		4	0.004 8
40		5	0.006 0
30		1	0.001 2
23		-5	-0.006 0
10		-4	-0.004 8
0		6	0.007 2
-10		7	0.008 4
-20		-2	-0.002 4
-30		2	0.002 4
Frequency Stability versus Power Supply			
Environment Temperature (°C)	Power Supplied (V _{dc})	Frequency Measure with Time Elapse	
		Frequency Error (Hz)	ppm
23	4.6	-3	-0.003 6
	3.4	4	0.004 8

- End of the Test Report -

The results shown in this test report refer only to the sample(s) tested unless otherwise stated. This test report cannot be reproduced, except in full, without prior written permission of the Company.