

RF TEST REPORT

Test item : Telematics Modem
Model No. : LTD-BH1000
Order No. : DTNC1506-03175, DTNC1506-03177
Date of receipt : 2015-06-25
Test duration : 2015-06-26 ~ 2015-07-02, 2015-07-28
Date of issue : 2015-07-28
Use of report : FCC & IC Original Grant

Applicant : LG Innotek Co.,Ltd.
978-1, Jangduk-dong, Gwangsan-gu, Gwangju-City, South Korea

Test laboratory : DT&C Co., Ltd.
42, Yurim-ro, 154beon-gil, Cheoin-gu, Yongin-si, Gyeonggi-do, Korea 449-935

Test specification : §22(H), §24(E), RSS-132, RSS-133
Test environment : See appended test report
Test result : Pass Fail

The test results presented in this test report are limited only to the sample supplied by applicant and the use of this test report is inhibited other than its purpose. This test report shall not be reproduced except in full, without the written approval of DT&C Co., Ltd.

Tested by:



Engineer
JaeJin Lee

Reviewed by:



Technical Manager
GeunKi Son

Test Report Version

Test Report No.	Date	Description
DRTFCC1507-0173	Jul. 22, 2015	Initial issue
DRTFCC1507-0173(1)	Jul. 28, 2015	Added the test of Frequency stability

Table of Contents

1. GENERAL INFORMATION	4
2. INTRODUCTION	5
2.1. EUT DESCRIPTION	5
2.2. Support equipment.....	5
2.3. MEASURING INSTRUMENT CALIBRATION.....	5
2.4. TEST FACILITY	5
3. DESCRIPTION OF TESTS.....	6
3.1 ERP & EIRP	6
3.2 PEAK TO AVERAGE RATIO.....	8
3.3 OCCUPIED BANDWIDTH.....	10
3.4 BAND EDGE EMISSIONS AT ANTENNA TERMINAL.....	11
3.5 SPURIOUS AND HARMONIC EMISSIONS AT ANTENNA TERMINAL.....	12
3.6 RADIATED SPURIOUS EMISSIONS	13
3.7 FREQUENCY STABILITY / VARIATION OF AMBIENT TEMPERATURE	14
4. LIST OF TEST EQUIPMENT.....	15
5. SUMMARY OF TEST RESULTS	16
6. SAMPLE CALCULATION	17
7. TEST DATA	18
7.1 CONDUCTED OUTPUT POWER.....	18
7.2 PEAK TO AVERAGE RATIO.....	19
7.3 OCCUPIED BANDWIDTH.....	19
7.4 SPURIOUS AND HARMONIC EMISSIONS AT ANTENNA TERMINAL.....	19
7.5 BAND EDGE.....	19
7.6 EFFECTIVE RADIATED POWER.....	20
7.7 EQUIVALENT ISOTROPIC RADIATED POWER	20
7.8 RADIATED SPURIOUS EMISSIONS	21
7.8.1 RADIATED SPURIOUS EMISSIONS (WCDMA850).....	21
7.8.2 RADIATED SPURIOUS EMISSIONS (HSUPA850)	22
7.8.3 RADIATED SPURIOUS EMISSIONS (WCDMA1900).....	23
7.8.4 RADIATED SPURIOUS EMISSIONS (HSUPA1900)	24
7.9 FREQUENCY STABILITY / VARIATION OF AMBIENT TEMPERATURE	25
7.9.1 FREQUENCY STABILITY (WCDMA850).....	25
7.9.2 FREQUENCY STABILITY (HSUPA850)	26
7.9.3 FREQUENCY STABILITY (WCDMA1900).....	27
7.9.4 FREQUENCY STABILITY (HSUPA1900)	28
8. TEST PLOTS	29
8.1 Peak to Average Ratio.....	29
8.2 Occupied Bandwidth (99 % Bandwidth)	30
8.3 Spurious Emissions at Antenna Terminal	38
8.4 Band Edge	48

1. GENERAL INFORMATION

Applicant Name: LG Innotek Co.,Ltd.

Address: 978-1, Jangduk-dong, Gwangsan-gu, Gwangju-City, South Korea

FCC ID : YZP-BH1000
IC : 7414C-BH1000
FCC Classification : PCS Licensed Transmitter (PCB)
EUT : Telematics Modem
Model Name : LTD-BH1000
Add Model Name : N/A
Supplying power : DC 4 V
Antenna Type : External

Mode	Tx Frequency (MHz)	Emission Designator	Conducted Output Power	
			Max. Power (W)	Max. Power (dBm)
WCDMA850	826.4 ~ 846.6 MHz	4M15F9W	0.254 W	24.04 dBm
HSUPA850	826.4 ~ 846.6 MHz	4M15F9W	0.244 W	23.88 dBm
WCDMA1900	1852.4 ~ 1907.6 MHz	4M15F9W	0.233 W	23.68 dBm
HSUPA1900	1852.4 ~ 1907.6 MHz	4M16F9W	0.232 W	23.65 dBm

2. INTRODUCTION

2.1. EUT DESCRIPTION

The Equipment Under Test(EUT) supports a WCDMA/HSUPA/HSPA+ of Cellular/PCS bands.

2.2. Support equipment

Equipment	Model No.	Serial No.	Manufacturer	Note
-	-	-	-	-
-	-	-	-	-

Note: The above equipment were supported by manufacturer.

2.3. MEASURING INSTRUMENT CALIBRATION

The measuring equipment, which was utilized in performing the tests documented herein, has been calibrated in accordance with the manufacturer's recommendations for utilizing calibration equipment, which is traceable to recognized national standards.

2.4. TEST FACILITY

The 3m test site and conducted measurement facility used to collect the radiated data are located at the 42, Yurim-ro, 154beon-gil, Cheoin-gu, Yongin-si, Gyeonggi-do, Korea 449-935. The site is constructed in conformance with the requirements.

- Semi anechoic chamber registration Number: 165783 (FCC) & 5740A-3 (IC)

3. DESCRIPTION OF TESTS

3.1 ERP & EIRP

(Effective Radiated Power & Equivalent Isotropic Radiated Power)

Test Set-up

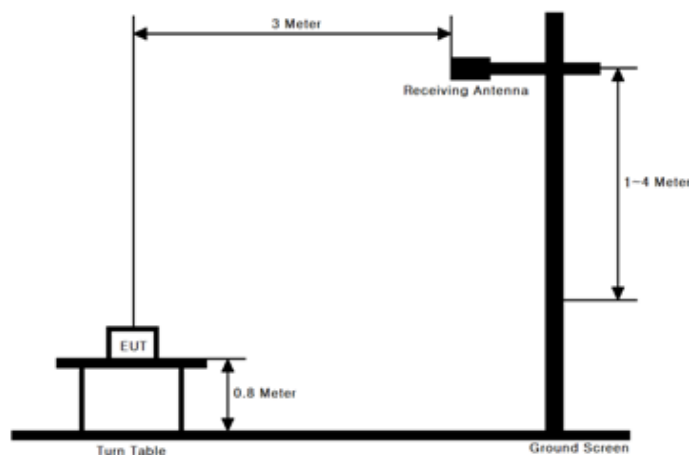

Test Procedure

- ANSI/TIA-603-C-2004 - Section 2.2.17
- KDB971168 v02r02 - Section 5.2.1

These measurements were performed at 3 & 10 m test site. The equipment under test is placed on a non-conductive table 0.8-meters above a turntable which is flush with the ground plane and 3 meters from the receive antenna.

Test setting

1. Set span to at least 1.5 times the OBW.
2. Set RBW = 1 - 5 % of the OBW, not to exceed 1 MHz.
3. Set VBW $\geq 3 \times$ RBW.
4. Set number of points in sweep $\geq 2 \times$ Span / RBW.
5. Sweep time = Auto couple.
6. Detector = RMS (power averaging).
7. If the EUT can be configured to transmit continuously (i.e., burst duty cycle $\geq 98 \%$), then set the trigger to free run.
8. If the EUT cannot be configured to transmit continuously (i.e., burst duty cycle $< 98 \%$), then use a sweep trigger with the level set to enable triggering only on full power bursts and configure the EUT to transmit at full power for the entire duration of each sweep.
Ensure that the sweep time is less than or equal to the transmission burst duration.
9. Trace average at least 100 traces in power averaging (i.e., RMS) mode.
10. Compute the power by integrating the spectrum across the OBW of the signal using the instrument's band power measurement function, with the band limits set equal to the OBW band edges. If the instrument does not have a band power function, then sum the spectrum levels (in linear power units) at intervals equal to the RBW extending across the entire OBW of the spectrum.

The receive antenna height and turntable rotations were adjusted for the highest reading on the receive spectrum analyzer.

A half-wave dipole was substituted in place of the EUT. This dipole antenna was driven by a signal generator and the level of the signal generator was adjusted to obtain the same receive spectrum analyzer reading. The conducted power at the terminal of the substitute antenna is measured.

The ERP/EIRP is calculated using the following formula:

ERP/EIRP = The conducted power at the substitute antenna's terminal [dBm] + Substitute Antenna gain [dBd for ERP , dBi for EIRP]

For readings above 1 GHz, the above procedure is repeated using horn antennas and the difference between the gain of the horn antenna and an isotropic antenna are taken into consideration.

3.2 PEAK TO AVERAGE RATIO

Test set-up

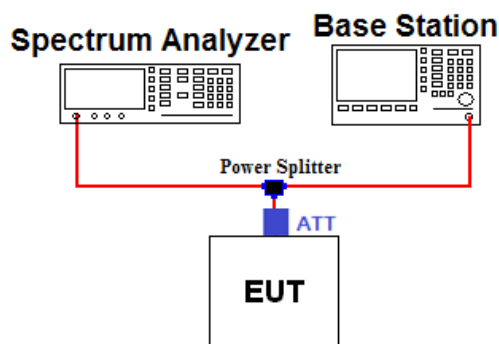

Test Procedure

A peak to average ratio measurement is performed using the following procedure.

■ CCDF Procedure

- KDB971168 v02r02-Section 5.7.1

1. Set resolution/measurement bandwidth \geq signal's occupied bandwidth
2. Set the number of counts to a value that stabilizes the measured CCDF curve
3. Set the measurement interval as follows:
 - 1) For continuous transmissions, set to 1 ms
 - 2) For burst transmissions, employ an external trigger that is synchronized with the EUT burst timing sequence, or use the internal burst trigger with a trigger level that allows the burst to stabilize and set the measurement interval to a time that is less than or equal to the burst duration.
4. Record the maximum PAPR level associated with a probability of 0.1%

■ Alternate Procedure

- KDB971168 v02r02-Section 5.7.2

Use one of the measurement procedures of the peak power and record as P_{Pk} .

Use one of the measurement procedures of the average power and record as P_{Avg} .

Both the peak and average power levels must be expressed in the same logarithmic units (e.g., dBm). Determine the PAPR from:

$$\text{PAPR (dB)} = P_{Pk} \text{ (dBm)} - P_{Avg} \text{ (dBm)}.$$

- Peak Power Measurement

1. Set the RBW \geq OBW
2. Set VBW \geq 3 x RBW
3. Set span \geq 2 x RBW
4. Sweep time = Auto couple
5. Detector = Peak
6. Ensure that the number of measurement points \geq Span / RBW.
7. Trace mode = Max hold
8. Allow trace to fully stabilize.
9. Use the peak marker function to determine the peak amplitude level.

- Average Power Measurement

1. Set span to at least 1.5 times the OBW.
2. Set RBW = 1 - 5% of the OBW, not to exceed 1 MHz.
3. Set VBW \geq 3 x RBW.
4. Set number of points in sweep \geq 2 x Span / RBW.
5. Sweep time = Auto-couple.
6. Detector = RMS (power averaging).
7. If the EUT can be configured to transmit continuously (i.e., burst duty cycle \geq 98%), then set the trigger to free run.
8. If the EUT cannot be configured to transmit continuously (i.e., burst duty cycle $<$ 98 %), then use a sweep trigger with the level set to enable triggering only on full power bursts and configure the EUT to transmit at full power for the entire duration of each sweep. Ensure that the sweep time is less than or equal to the transmission burst duration.
9. Trace average at least 100 traces in power averaging (i.e., RMS) mode.
10. Compute the power by integrating the spectrum across the OBW of the signal using the instrument's band power measurement function, with the band limits set equal to the OBW band edges. If the instrument does not have a band power function, then sum the spectrum levels (in linear power units) at intervals equal to the RBW extending across the entire OBW of the spectrum.

3.3 OCCUPIED BANDWIDTH.

Test set-up

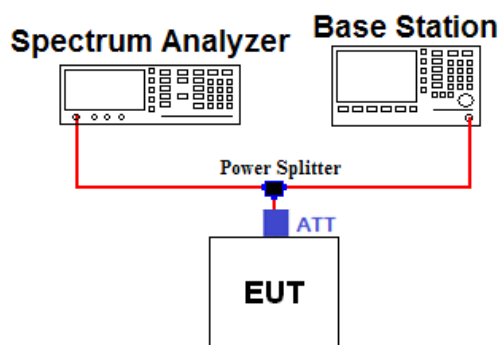

Offset value information

Frequency (MHz)	Offset Value (dB)	Frequency (MHz)	Offset Value (dB)
826.4	19.01	1852.4	19.47
836.6	19.06	1880.0	19.54
846.6	19.08	1907.6	19.56
-	-	-	-

Note. 1: The offset values from EUT to Spectrum analyzer were measured and used for test.
 Offset value = Cable A + Splitter + ATT + Cable B

Test Procedure

- KDB971168 v02r02 - Section 4.2

The occupied bandwidth, that is the frequency bandwidth such that, below its lower and above its upper frequency limits, the mean powers radiated are each equal to 0.5 percent of the total mean power of a given emission.

Test setting

1. The signal analyzer's automatic bandwidth measurement capability was used to perform the 99 % occupied bandwidth and the 26 dB bandwidth. The bandwidth measurement was not influenced by any intermediate power nulls in the fundamental emission.
2. $RBW = 1 \sim 5 \%$ of the expected OBW & $VBW \geq 3 \times RBW$
3. Detector = Peak
4. Trance mode = Max hold
5. Sweep = Auto couple
6. The trace was allowed to stabilize
7. If necessary, step 2 ~ 6 were repeated after changing the RBW such that it would be within $1 \sim 5 \%$ of the 99 % occupied bandwidth observed in step 6.

3.4 BAND EDGE EMISSIONS AT ANTENNA TERMINAL.

Test set-up

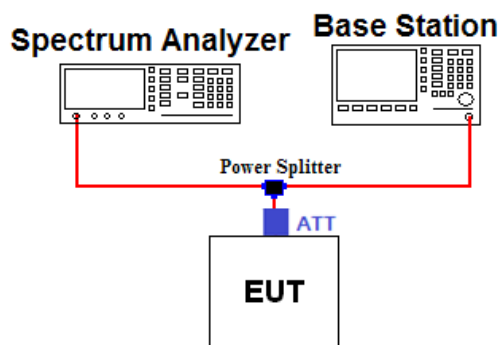

Offset value information

Frequency (MHz)	Offset Value (dB)	Frequency (MHz)	Offset Value (dB)
823.0	19.01	1849.0	19.46
824.0	19.02	1850.0	19.48
849.0	19.12	1910.0	19.57
850.0	19.12	1911.0	19.57
-	-	-	-

Note. 1: The offset value from EUT to Spectrum analyzer was measured and used for test.
 Offset value = Cable A + Splitter + ATT + Cable B

Test Procedure

- KDB971168 v02r02 - Section 6.0

All out of band emissions are measured by means of a calibrated spectrum analyzer. The EUT was setup to maximum output power at its lowest and highest channel with all modulations.

The power of any spurious emission shall be attenuated below the transmitter power (P) by at least $43 + 10 \log(P)$ dB

Test setting

1. Start and stop frequency were set such that the band edge would be placed in the center of the plot
2. Span was set large enough so as to capture all out of band emissions near the band edge
3. RBW ≥ 1 % of the emission
4. VBW $\geq 3 \times$ RBW
5. Detector = RMS & Trace mode = Max hold
6. Sweep time = Auto couple or 1 s for band edge
7. Number of sweep point $\geq 2 \times$ Span / RBW
8. The trace was allowed to stabilize

Note 1: In the 1 MHz bands immediately outside and adjacent to the frequency block a resolution bandwidth of **at least one percent** of the emission bandwidth of the fundamental emission of the transmitter may be employed to demonstrate compliance with the out-of-band emissions limit. The emission bandwidth is defined as the width of the signal between two points, one below the carrier center frequency and one above the carrier center frequency, outside of which all emission are attenuated at least 26 dB below the transmitter power.

3.5 SPURIOUS AND HARMONIC EMISSIONS AT ANTENNA TERMINAL.

Test set-up

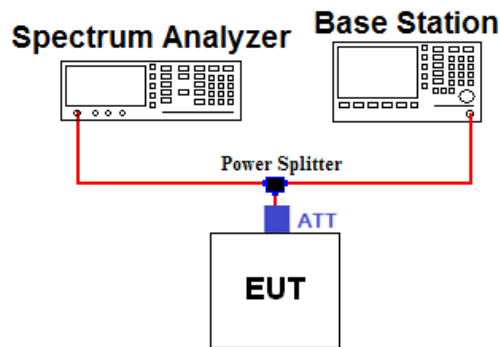

Offset value information

Frequency (MHz)	Offset Value (dB)	Frequency (MHz)	Offset Value (dB)
5000.0	20.74	15000.0	21.80
10000.0	21.39	20000.0	22.78
-	-	-	-

Note. 1: The offset value from EUT to Spectrum analyzer was measured and used for test.
 Offset value = Cable A + Splitter + ATT + Cable B

Test Procedure

- KDB971168 v02r02 - Section 6.0

The level of the carrier and the various conducted spurious and harmonic frequencies is measured by means of a calibrated spectrum analyzer. The EUT was setup to maximum output power at its low, middle, high channel with all bandwidths. The spectrum is scanned from 30 MHz up to a frequency including its 10th harmonic.

The power of any spurious emission shall be attenuated below the transmitter power (P) by at least $43 + 10 \log(P)$ dB

Test setting

1. RBW = 100 KHz or 1 MHz & VBW $\geq 3 \times$ RBW (Refer to Note 1)
2. Detector = RMS & Trace mode = Max hold
3. Sweep time = Auto couple
4. Number of sweep point $\geq 2 \times$ Span / RBW
5. The trace was allowed to stabilize

Note 1: Compliance with these provisions is based on the use of measurement instrumentation employing a resolution bandwidth of 100 kHz or greater for Part 22 and 1 MHz or greater for Part 24.

3.6 RADIATED SPURIOUS EMISSIONS

Test Set-up

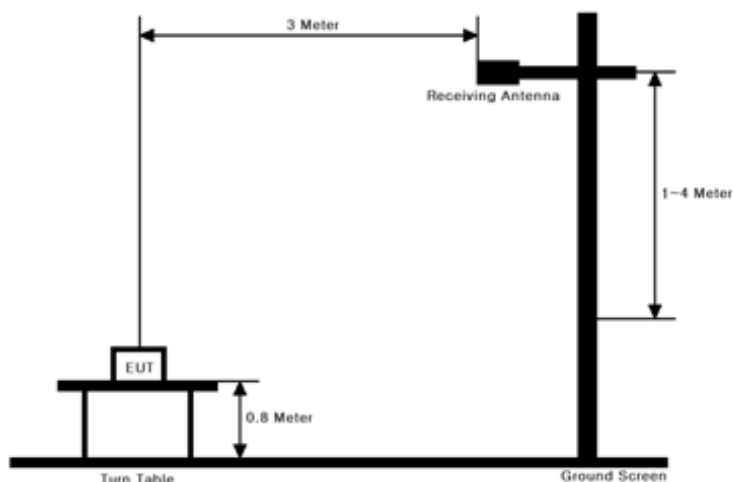

Test Procedure

- **ANSI/TIA-603-C-2004 - Section 2.2.12**
- **KDB971168 v02r02 - Section 5.8**

These measurements were performed at 3 & 10m test site. The equipment under test is placed on a non-conductive table 0.8-meters above a turntable which is flush with the ground plane and 3 meters from the receive antenna.

Test setting

1. RBW = 100 kHz for below 1 GHz and 1 MHz for above 1 GHz & VBW $\geq 3 \times$ RBW
2. Detector = Peak & Trace mode = Max hold
3. Sweep time = Auto couple
4. Number of sweep point $\geq 2 \times$ Span / RBW
5. The trace was allowed to stabilize

The receive antenna height and turntable rotations were adjusted for the highest reading on the receive spectrum analyzer.

For radiated power measurements below 1 GHz, a half-wave dipole was substituted in place of the EUT. This dipole antenna was driven by a signal generator and the level of the signal generator was adjusted to obtain the same spectrum analyzer reading.

For radiated power measurements above 1 GHz, a Horn antenna was substituted in place of the EUT. This Horn antenna was driven by a signal generator and the level of the signal generator was adjusted to obtain the same spectrum analyzer reading. The difference between the gain of the horn and an isotropic antenna are taken into consideration.

This measurement was performed with the EUT oriented in 3 orthogonal axis.

4. LIST OF TEST EQUIPMENT

Type	Manufacturer	Model	Cal.Date (yy/mm/dd)	Next.Cal. Date (yy/mm/dd)	S/N
MXA Signal Analyzer	Agilent Technologies	N9020A	15/01/19	16/01/19	MY46471096
Dynamic Measurement DC Source	Agilent Technologies	66332A	15/01/22	16/01/22	GB37470200
Temp & Humi Test Chamber	SJ Science	SJ-TH-S50	14/10/21	15/10/21	SJ-TH-S50-130930
Signal Generator	Rohde Schwarz	SMF100A	15/06/29	16/06/29	102341
8960 Series 10 Wireless Comms Test Set	Agilent Technologies	E5515C	14/09/12	15/09/12	GB41321164
Power Splitter	Anritsu	K241B	14/10/21	15/10/21	1701061
2W 3dB Attenuator	SMAJK	SMAJK-2-3	14/10/21	15/10/21	3
50W 10dB Attenuator	SMAJK	SMAJK-50-10	14/10/21	15/10/21	2-50-10
Thermohygrometer	BODYCOM	BJ5478	15/02/26	16/02/26	1209
Digital Multimeter	FLUKE	17B	15/04/27	16/04/27	26030065WS
Vector Signal Generator	Rohde Schwarz	SMBV100A	15/01/06	16/01/06	255571
Loop Antenna	Schwarzbeck	FMZB1513	14/04/29	16/04/29	1513-128
TRILOG Broadband Test-Antenna	SCHWARZBECK	VULB 9160	14/04/04	16/04/04	3357
Dipole Antenna	Schwarzbeck	VHA9103	13/10/24	15/10/24	2116
Dipole Antenna	Schwarzbeck	VHA9103	14/04/01	16/04/01	2117
Dipole Antenna	Schwarzbeck	UHA9105	13/10/24	15/10/24	2261
Dipole Antenna	Schwarzbeck	UHA9105	14/04/01	16/04/01	2262
HORN ANT	ETS	3115	15/02/09	17/02/09	00021097
HORN ANT	ETS	3117	14/05/12	16/05/12	140394
HORN ANT	A.H.Systems	SAS-574	15/04/30	17/04/30	154
HORN ANT	ETS-Lindgren	3160-09	13/10/13	15/10/13	00158433
HORN ANT	Custom Microwave, Inc.	CMI/HO28S	13/11/14	15/11/14	Ka100224-1
Low Noise Pre Amplifier	TSJ	MLA-010K01-B01-27	15/04/09	16/04/09	1844538
Amplifier	EMPOWER	BBS3Q7ELU	14/09/12	15/09/12	1020
Amplifier (30dB)	Agilent	8449B	14/11/06	15/11/06	3008A02108
High-pass filter	Wainwright	WHKX12-935-1000-15000-40SS	14/09/11	15/09/11	7
High-pass filter	Wainwright	WHKX12-2580-3000-18000-80SS	14/09/11	15/09/11	3

5. SUMMARY OF TEST RESULTS

FCC Part Section(s)	RSS Section(s)	Parameter	Status Note 1
2.1046	RSS-132 [5.4] RSS-133 [6.4]	Conducted Output Power	C
22.913(a) 24.232(c)	RSS-132 [5.4] [SRSP-503(5.1.3)] RSS-133 [6.4] [SRSP-510(5.1.2)]	Effective Radiated Power Equivalent Isotropic Radiated Power	C
22.917(a) 24.238(a) 2.1049	RSS-Gen [6.6]	Occupied Bandwidth	C
22.917(a) 24.238(a) 2.1051	RSS-132 [5.5] RSS-133 [6.5]	Band Edge Spurious and Harmonic Emissions at Antenna Terminal	C
24.232(d)	RSS-132 [5.4] RSS-133 [6.4]	Peak to Average Ratio	C
22.917(a) 24.238(a) 2.1053	RSS-132 [5.5] RSS-133 [6.5]	Radiated Spurious and Harmonic Emissions	C
22.355 24.235 2.1055	RSS-132 [5.3] RSS-133 [6.3]	Frequency Stability	C
Note 1: C =Comply NC =Not Comply NT =Not Tested NA =Not Applicable			

The sample was tested according to the following specification:
ANSI/TIA/EIA-603-C-2004 and KDB 971168 D01 v02r02

6. SAMPLE CALCULATION

A. Emission Designator

WCDMA850 Emission Designator

Emission Designator = **4M15F9W**
 WCDMA OBW = 4.1455 MHz
 (Measured at the 99.75 % power bandwidth)
 F = Frequency Modulation
 9 = Composite Digital Information
 W = Combination (Audio/Data)

WCDMA1900 Emission Designator

Emission Designator = **4M15F9W**
 WCDMA OBW = 4.1502 MHz
 (Measured at the 99.75 % power bandwidth)
 F = Frequency Modulation
 9 = Composite Digital Information
 W = Combination (Audio/Data)

HSUPA850 Emission Designator

Emission Designator = **4M15F9W**
 HSUPA OBW = 4.1547 MHz
 (Measured at the 99.75 % power bandwidth)
 F = Frequency Modulation
 9 = Composite Digital Information
 W = Combination (Audio/Data)

HSUPA1900 Emission Designator

Emission Designator = **4M16F9W**
 HSUPA OBW = 4.1638 MHz
 (Measured at the 99.75 % power bandwidth)
 F = Frequency Modulation
 9 = Composite Digital Information
 W = Combination (Audio/Data)

B. RADIATED SPURIOUS EMISSIONS Sample Calculation

MODE	Spectrum Reading		EUT Axis	Ant Pol (H/V)	Level(dBm) @ Ant Terminal	TX Ant Gain(dBd)	Result
	Freq.(MHz)	Value (dBm)					(dBm)
WCDMA850	1655.17	-51.39	Z	H	-50.78	6.64	-44.14

RADIATED SPURIOUS EMISSIONS = @ Ant Terminal LEVEL(dBm) + Ant. Gain

- 1) The EUT mounted on a non-conductive turntable is 0.8 meter above test site ground level.
- 2) During the test, the turn table is rotated until the maximum signal is found.
- 3) Record the field strength meter's level.
- 4) Replace the EUT with dipole/Horn antenna that is connected to a calibrated signal generator.
- 5) Increase the signal generator output till the field strength meter's level is equal to the item (3).
- 6) The signal generator output level with Ant. Gain is the rating of RADIATED SPURIOUS EMISSIONS.

7. TEST DATA

7.1 CONDUCTED OUTPUT POWER

A base station simulator was used to establish communication with the EUT. The base station simulator parameters were set to produce the maximum power from the EUT. This device was tested under all configurations and the highest power is reported. Conducted Output Powers of EUT are reported below.

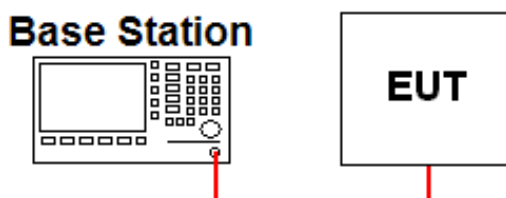

The output power was measured using the Agilent E5515C

• WCDMA / HSDPA / HSUPA

3GPP Release Version	Mode	3GPP 34.121 Subtest	Cellular Band (dBm)			PCS Band (dBm)			3GPP MPR (dB)
			4132	4183	4233	9262	9400	9538	
99	WCDMA	12.2 kbps RMC	23.70	24.04	23.97	23.68	23.64	23.65	-
99		12.2 kbps AMR	23.70	24.03	23.98	23.66	23.64	23.64	-
5	HSDPA	Subtest 1	23.69	23.95	23.88	23.66	23.59	23.60	0
5		Subtest 2	23.68	24.02	23.93	23.68	23.61	23.64	0
5		Subtest 3	23.22	23.50	23.44	23.19	23.16	23.18	0.5
5		Subtest 4	23.21	23.49	23.43	23.19	23.19	23.21	0.5
6	HSUPA	Subtest 1	23.29	23.42	23.38	23.34	22.80	22.89	0
6		Subtest 2	22.14	22.37	22.34	22.27	22.10	22.07	2
6		Subtest 3	22.56	22.71	22.63	22.56	22.39	22.61	1
6		Subtest 4	22.41	22.38	22.36	22.73	22.04	22.51	2
6		Subtest 5	23.61	23.88	23.79	23.65	23.57	23.60	0
7	HSPA+	Subtest 1	22.17	22.36	22.29	22.32	22.15	22.20	-

7.2 PEAK TO AVERAGE RATIO

- Plots of the EUT's Peak- to- Average Ratio are shown in Clause 8.1

7.3 OCCUPIED BANDWIDTH

Band	Channel	Frequency	Test Result (kHz)
WCDMA850	4132	826.4	4142.30
	4183	836.6	4131.90
	4233	846.6	4145.50
HSUPA850	4132	826.4	4154.70
	4183	836.6	4136.40
	4233	846.6	4124.30
WCDMA1900	512	1850.2	4148.10
	661	1880.0	4150.20
	810	1909.8	4147.10
HSUPA1900	9262	1852.4	4163.80
	9400	1880.0	4158.00
	9538	1907.6	4155.00

- Plots of the EUT's Occupied Bandwidth are shown in Clause 8.2

7.4 SPURIOUS AND HARMONIC EMISSIONS AT ANTENNA TERMINAL

- Plots of the EUT's Conducted Spurious Emissions are shown in Clause 8.3

7.5 BAND EDGE

- Plots of the EUT's Band Edge are shown in Clause 8.4

7.6 EFFECTIVE RADIATED POWER

Band	Mode	Maximum Output Power(dBm)	Antenna Gain (dBd)	ERP (dBm)	LIMIT (dBm)
Cellular	WCDMA850	25.50	3.45	28.95	38.45
Cellular	HSUPA850	25.50	3.45	28.95	38.45

Note.
The maximum output power used max target power.
Available max Antenna gain is 5.60 dBi (3.45 dBd) in cellular band of WCDMA, and compliant with MPE requirement.

7.7 EQUIVALENT ISOTROPIC RADIATED POWER

Band	Mode	Maximum Output Power(dBm)	Antenna Gain (dBi)	EIRP (dBm)	LIMIT (dBm)
PCS	WCDMA850	25.50	7.50	33.00	33.01
PCS	HSUPA850	25.50	7.50	33.00	33.01

Note.
The maximum output power used max tune-up power.
Available max Antenna gain is 7.50 dBi in pcs band of WCDMA, and compliant with MPE requirement.

7.8 RADIATED SPURIOUS EMISSIONS

7.8.1 RADIATED SPURIOUS EMISSIONS (WCDMA850)

Channel	Freq. (MHz)	EUT Position (Axis)	POL (H/V)	LEVEL@ ANTENNA TERMINAL (dBm)	Substitute Antenna Gain (dBd)	Correct Generator Level (dBm)	Margin (dB)	Limit (dBm)
4132 (826.4)	1655.17	Z	H	-50.78	6.64	-44.14	31.14	-13.00
	6611.16	Z	H	-53.49	9.53	-43.96	30.96	
	-	-	-	-	-	-	-	
4183 (836.6)	1671.76	Z	H	-53.37	6.66	-46.71	33.71	
	6692.65	Z	H	-54.37	9.53	-44.84	31.84	
	-	-	-	-	-	-	-	
4233 (848.8)	1690.83	Z	H	-54.130	6.68	-47.45	34.45	
	6772.72	Z	H	-54.380	9.54	-44.84	31.84	
	-	-	-	-	-	-	-	

- No other spurious and harmonic emissions were reported greater than listed emissions above table.

NOTES:

This EUT was tested under all configurations and the highest power is reported in WCDMA mode with HSDPA inactive at 12.2 kbps RMC and TPC bits set to "1" and HSUPA mode with 12.2 kbps + HSPA and subtest 5. This EUT was tested with the fully charged battery. Also, we have done x, y, z planes in EUT and horizontal and vertical polarization of detecting antenna.

The worst case data is reported.

7.8.2 RADIATED SPURIOUS EMISSIONS (HSUPA850)

Channel	Freq. (MHz)	EUT Position (Axis)	POL (H/V)	LEVEL@ ANTENNA TERMINAL (dBm)	Substitute Antenna Gain (dBd)	Correct Generator Level (dBm)	Margin (dB)	Limit (dBm)
4132 (826.4)	1655.22	Z	H	-52.34	6.64	-45.70	32.70	-13.00
	6611.20	Z	H	-54.27	9.53	-44.74	31.74	
	-	-	-	-	-	-	-	
4183 (836.6)	1674.96	Z	H	-52.61	6.67	-45.94	32.94	
	6692.91	Z	H	-54.53	9.53	-45.00	32.00	
	-	-	-	-	-	-	-	
4233 (848.8)	1690.75	Z	H	-54.530	6.68	-47.85	34.85	
	6772.72	Z	H	-54.560	9.54	-45.02	32.02	
	-	-	-	-	-	-	-	

- No other spurious and harmonic emissions were reported greater than listed emissions above table.

NOTES:

This EUT was tested under all configurations and the highest power is reported in WCDMA mode with HSDPA inactive at 12.2 kbps RMC and TPC bits set to "1" and HSUPA mode with 12.2 kbps + HSPA and subtest 5. This EUT was tested with the fully charged battery. Also, we have done x, y, z planes in EUT and horizontal and vertical polarization of detecting antenna.

The worst case data is reported.

7.8.3 RADIATED SPURIOUS EMISSIONS (WCDMA1900)

Channel	Freq. (MHz)	EUT Position (Axis)	POL (H/V)	LEVEL@ ANTENNA TERMINAL (dBm)	Substitute Antenna Gain (dBi)	Correct Generator Level (dBm)	Margin (dB)	Limit (dBm)
9262 (1852.4)	3704.77	Y	H	-54.62	9.91	-44.71	31.71	-13.00
	-	-	-	-	-	-	-	
	-	-	-	-	-	-	-	
9400 (1880.0)	3760.06	Y	H	-52.47	9.86	-42.61	29.61	
	-	-	-	-	-	-	-	
	-	-	-	-	-	-	-	
9538 (1907.6)	3815.10	Y	H	-50.150	9.80	-40.35	27.35	
	-	-	-	-	-	-	-	
	-	-	-	-	-	-	-	

- No other spurious and harmonic emissions were reported greater than listed emissions above table.

NOTES:

This EUT was tested under all configurations and the highest power is reported in WCDMA mode with HSDPA inactive at 12.2 kbps RMC and TPC bits set to "1" and HSUPA mode with 12.2 kbps + HSPA and subtest 5. This EUT was tested with the fully charged battery. Also, we have done x, y, z planes in EUT and horizontal and vertical polarization of detecting antenna.

The worst case data is reported.

7.8.4 RADIATED SPURIOUS EMISSIONS (HSUPA1900)

Channel	Freq. (MHz)	EUT Position (Axis)	POL (H/V)	LEVEL@ ANTENNA TERMINAL (dBm)	Substitute Antenna Gain (dBi)	Correct Generator Level (dBm)	Margin (dB)	Limit (dBm)
9262 (1852.4)	3704.75	Y	H	-54.86	9.91	-44.95	31.95	-13.00
	-	-	-	-	-	-	-	
	-	-	-	-	-	-	-	
9400 (1880.0)	3760.02	Y	H	-52.68	9.86	-42.82	29.82	
	-	-	-	-	-	-	-	
	-	-	-	-	-	-	-	
9538 (1907.6)	3815.18	Y	H	-51.410	9.80	-41.61	28.61	
	-	-	-	-	-	-	-	
	-	-	-	-	-	-	-	

- No other spurious and harmonic emissions were reported greater than listed emissions above table.

NOTES:

This EUT was tested under all configurations and the highest power is reported in WCDMA mode with HSDPA inactive at 12.2 kbps RMC and TPC bits set to "1" and HSUPA mode with 12.2 kbps + HSPA and subtest 5. This EUT was tested with the fully charged battery. Also, we have done x, y, z planes in EUT and horizontal and vertical polarization of detecting antenna.

The worst case data is reported.

7.9 FREQUENCY STABILITY / VARIATION OF AMBIENT TEMPERATURE

7.9.1 FREQUENCY STABILITY (WCDMA850)

OPERATING FREQUENCY : 836,600,000_Hz
 CHANNEL : 4183(Mid)
 REFERENCE VOLTAGE : 4.00_V DC
 DEVIATION LIMIT : $\pm 0.00025\%$ or 2.5 ppm (FCC & IC)

VOLTAGE (%)	POWER (V DC)	TEMP (°C)	FREQ (Hz)	Deviation	
				(ppm)	(%)
100%	4.00	+25(Ref)	836,599,981	-0.023	-0.00000227
100%		-30	836,599,991	-0.011	-0.00000108
100%		-20	836,599,984	-0.019	-0.00000191
100%		-10	836,599,995	-0.006	-0.00000060
100%		0	836,600,010	0.012	0.00000120
100%		+10	836,599,986	-0.017	-0.00000167
100%		+20	836,599,988	-0.014	-0.00000143
100%		+30	836,599,989	-0.013	-0.00000131
100%		+40	836,600,008	0.010	0.00000096
100%		+50	836,599,980	-0.024	-0.00000239
115%	4.60	+25	836,599,979	-0.025	-0.00000251
85%	3.40	+25	836,600,011	0.013	0.00000131

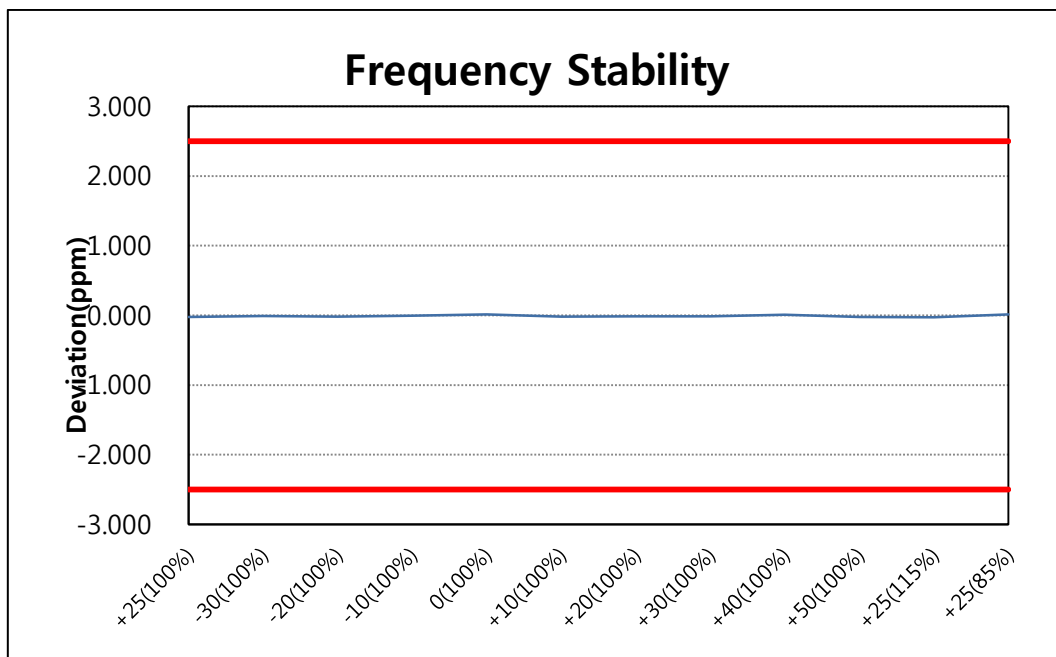

7.9.2 FREQUENCY STABILITY (HSUPA850)

OPERATING FREQUENCY : 836,600,000 Hz
 CHANNEL : 4183(Mid)
 REFERENCE VOLTAGE : 4.00 V DC
 DEVIATION LIMIT : $\pm 0.00025\%$ or 2.5 ppm (FCC & IC)

VOLTAGE (%)	POWER (V DC)	TEMP (°C)	FREQ (Hz)	Deviation	
				(ppm)	(%)
100%	4.00	+25(Ref)	836,599,989	-0.013	-0.00000131
100%		-30	836,599,984	-0.019	-0.00000191
100%		-20	836,599,987	-0.016	-0.00000155
100%		-10	836,599,986	-0.017	-0.00000167
100%		0	836,600,005	0.006	0.00000060
100%		+10	836,600,008	0.010	0.00000096
100%		+20	836,599,986	-0.017	-0.00000167
100%		+30	836,599,981	-0.023	-0.00000227
100%		+40	836,599,990	-0.012	-0.00000120
100%		+50	836,599,983	-0.020	-0.00000203
115%	4.60	+25	836,599,987	-0.016	-0.00000155
85%	3.40	+25	836,599,985	-0.018	-0.00000179

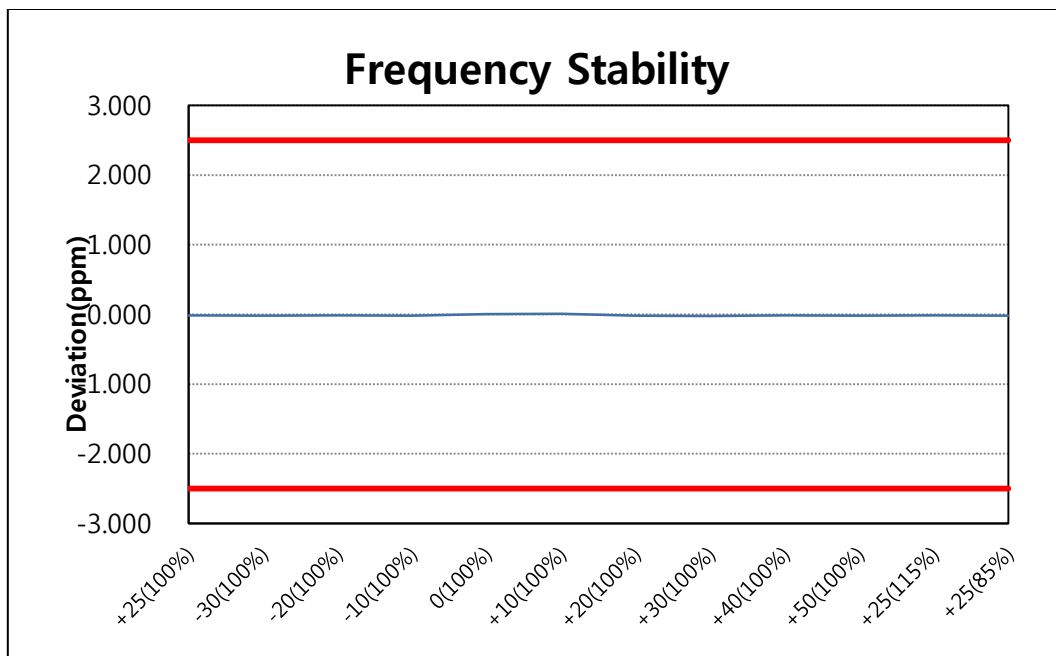

7.9.3 FREQUENCY STABILITY (WCDMA1900)

OPERATING FREQUENCY : 1,880,000,000 Hz
 CHANNEL : 9400(Mid)
 REFERENCE VOLTAGE : 4.00 V DC
 LIMIT : The frequency stability shall be sufficient to ensure that the fundamental emission stays within the authorized frequency block. (FCC)
 ± 0.00025 % or 2.5 ppm (IC)

VOLTAGE (%)	POWER (V DC)	TEMP (°C)	FREQ (Hz)	Deviation	
				(ppm)	(%)
100%	4.00	+25(Ref)	1,880,000,009	0.005	0.00000048
100%		-30	1,880,000,008	0.004	0.00000043
100%		-20	1,879,999,986	-0.007	-0.00000074
100%		-10	1,879,999,973	-0.014	-0.00000144
100%		0	1,879,999,980	-0.011	-0.00000106
100%		+10	1,879,999,984	-0.009	-0.00000085
100%		+20	1,880,000,004	0.002	0.00000021
100%		+30	1,879,999,981	-0.010	-0.00000101
100%		+40	1,879,999,986	-0.007	-0.00000074
100%		+50	1,880,000,012	0.006	0.00000064
115%	4.60	+25	1,879,999,984	-0.009	-0.00000085
85%	3.40	+25	1,880,000,015	0.008	0.00000080

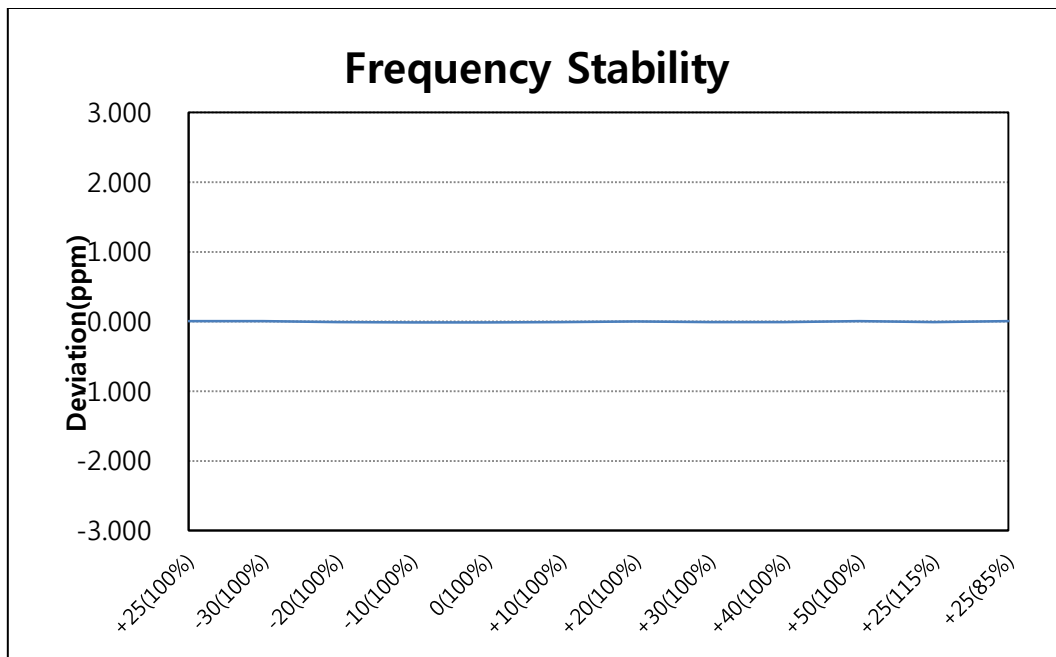

Note. Based on the results of the frequency stability test at the center channel the frequency deviation results measured are very small. as such it is determined that the channels at the band edge would remain inband when the maximum measured frequency deviation noted during the frequency stability tests is applied. therefore the device is determined to remain operating in band over the temperature and voltage range as tested.

7.9.4 FREQUENCY STABILITY (HSUPA1900)

OPERATING FREQUENCY : 1,880,000,000 Hz
 CHANNEL : 9400(Mid)
 REFERENCE VOLTAGE : 4.00 V DC
 LIMIT : The frequency stability shall be sufficient to ensure that the fundamental emission stays within the authorized frequency block. (FCC)
± 0.00025 % or 2.5 ppm (IC)

VOLTAGE (%)	POWER (V DC)	TEMP (°C)	FREQ (Hz)	Deviation	
				(ppm)	(%)
100%	4.00	+25(Ref)	1,879,999,978	-0.012	-0.00000117
100%		-30	1,879,999,988	-0.006	-0.00000064
100%		-20	1,880,000,008	0.004	0.00000043
100%		-10	1,880,000,013	0.007	0.00000069
100%		0	1,879,999,985	-0.008	-0.00000080
100%		+10	1,879,999,981	-0.010	-0.00000101
100%		+20	1,879,999,989	-0.006	-0.00000059
100%		+30	1,880,000,016	0.009	0.00000085
100%		+40	1,880,000,008	0.004	0.00000043
100%		+50	1,879,999,976	-0.013	-0.00000128
115%	4.60	+25	1,879,999,983	-0.009	-0.00000090
85%	3.40	+25	1,880,000,019	0.010	0.00000101

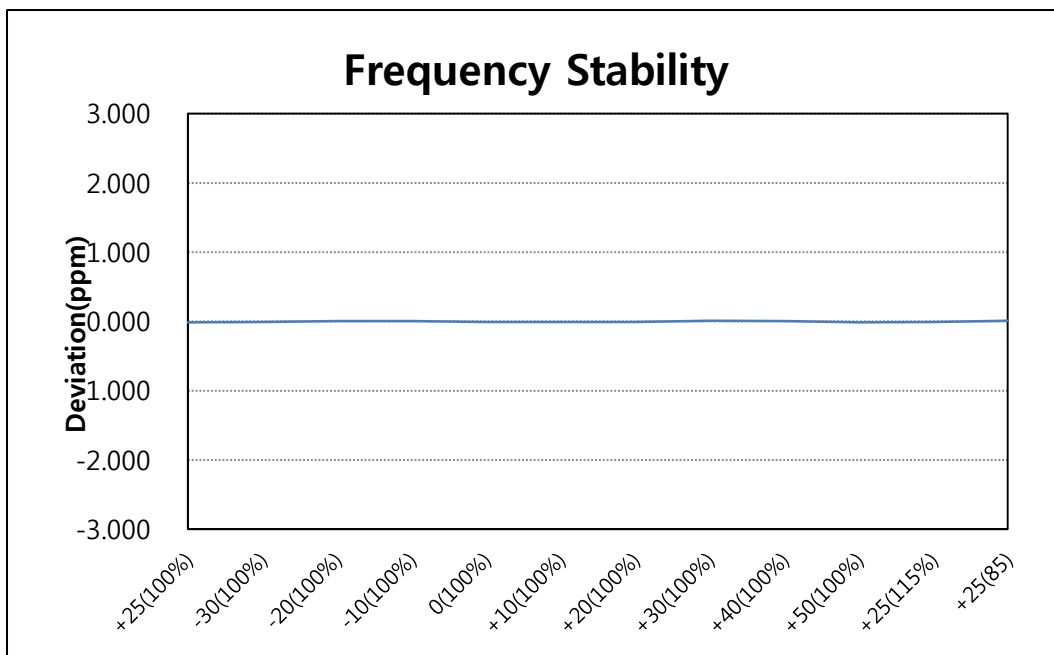

Note. Based on the results of the frequency stability test at the center channel the frequency deviation results measured are very small. as such it is determined that the channels at the band edge would remain inband when the maximum measured frequency deviation noted during the frequency stability tests is applied. therefore the device is determined to remain operating in band over the temperature and voltage range as tested.

8. TEST PLOTS

8.1 Peak to Average Ratio

WCDMA1900 & Channel: 9400

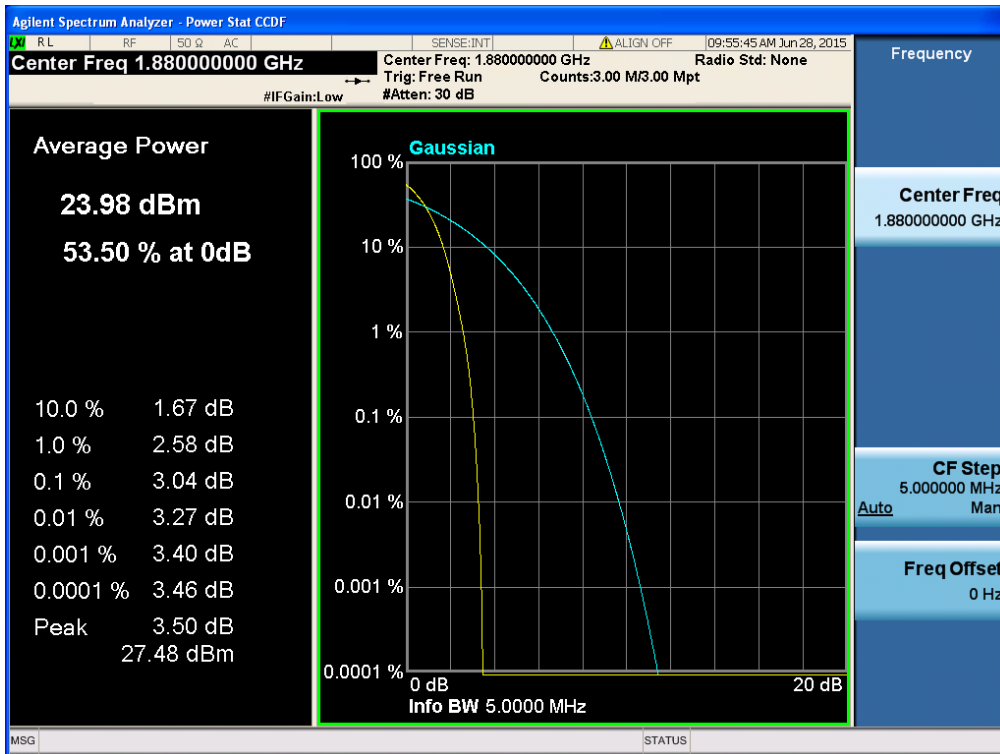

HSUPA1900 & Channel: 9400

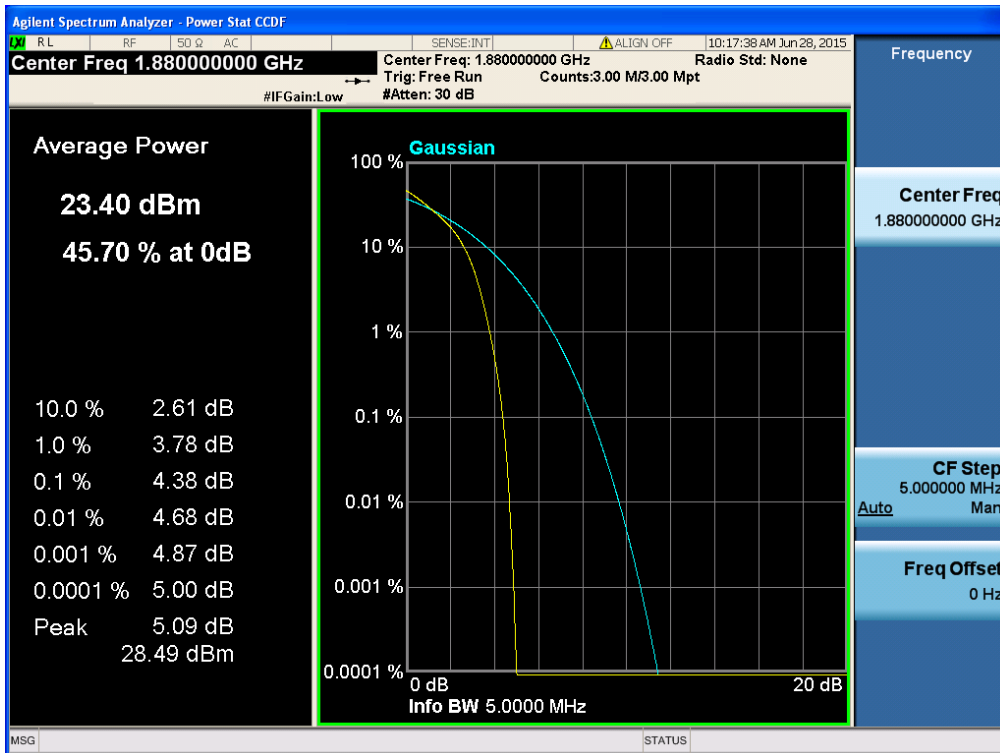

8.2 Occupied Bandwidth (99 % Bandwidth)

WCDMA850 & Channel: 4132

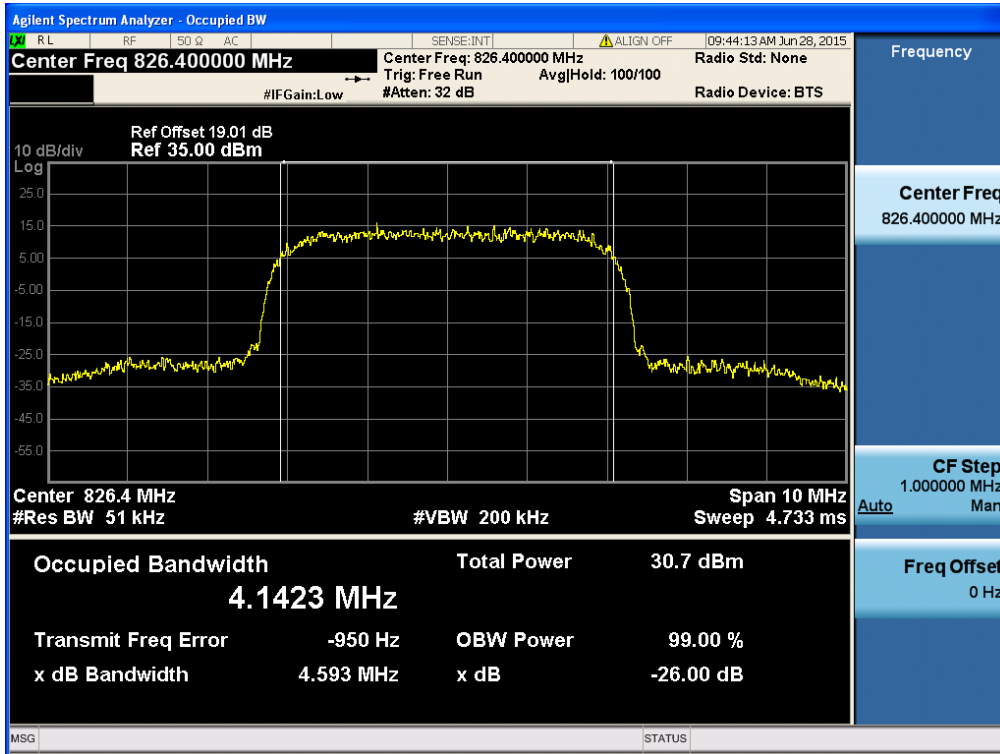

WCDMA850 & Channel: 4183

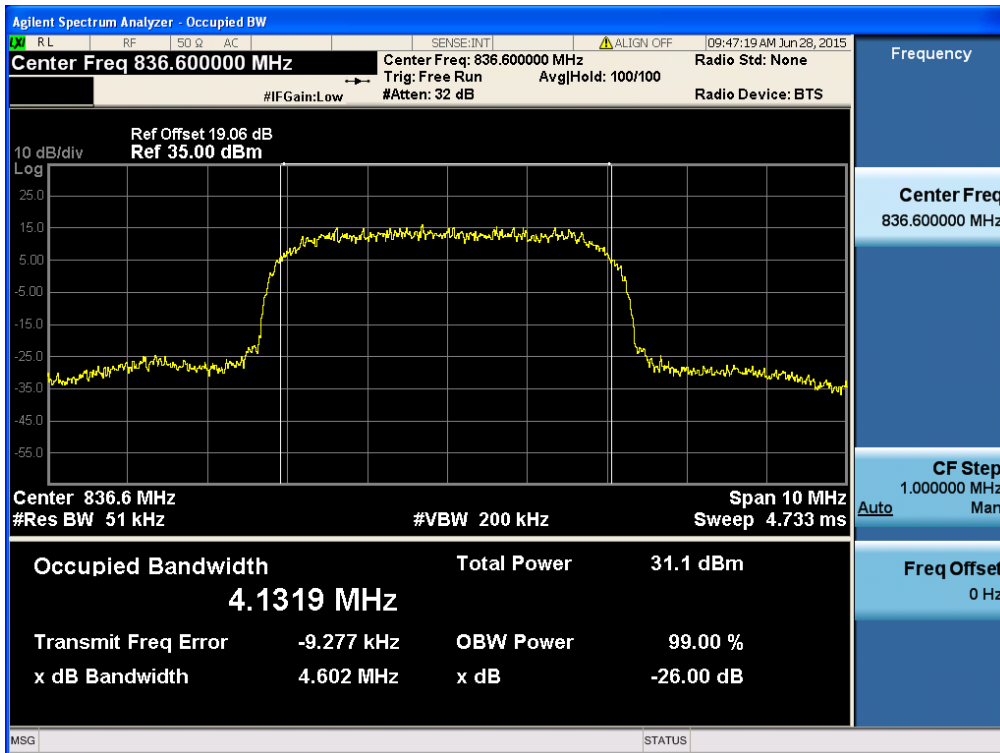

WCDMA850 & Channel: 4233

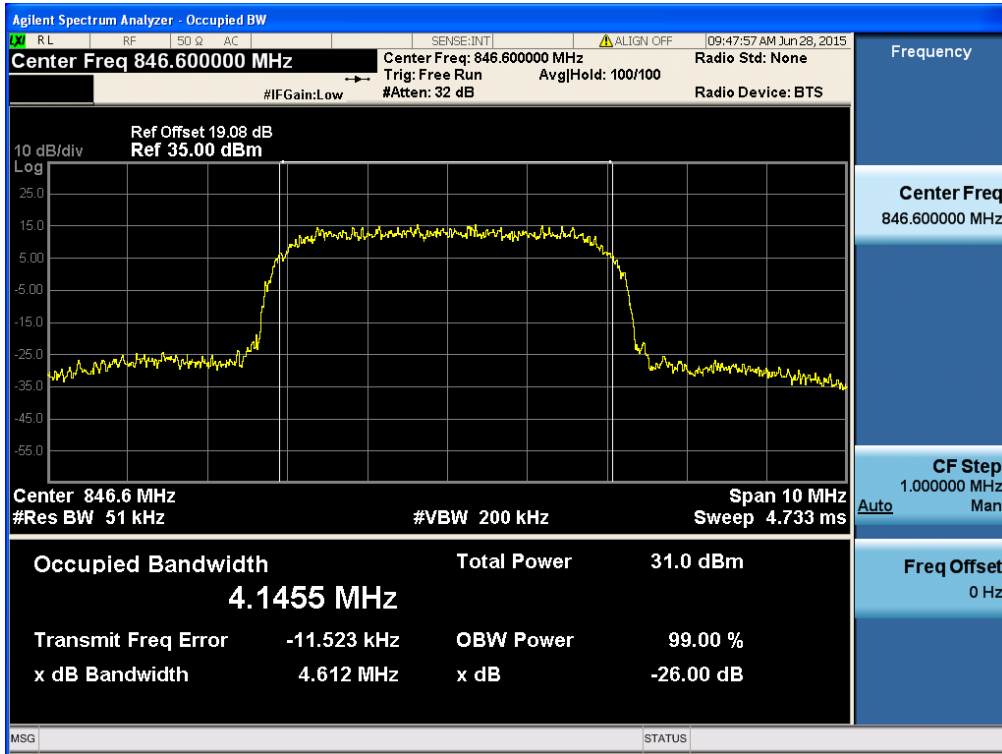

HSUPA850 & Channel: 4132

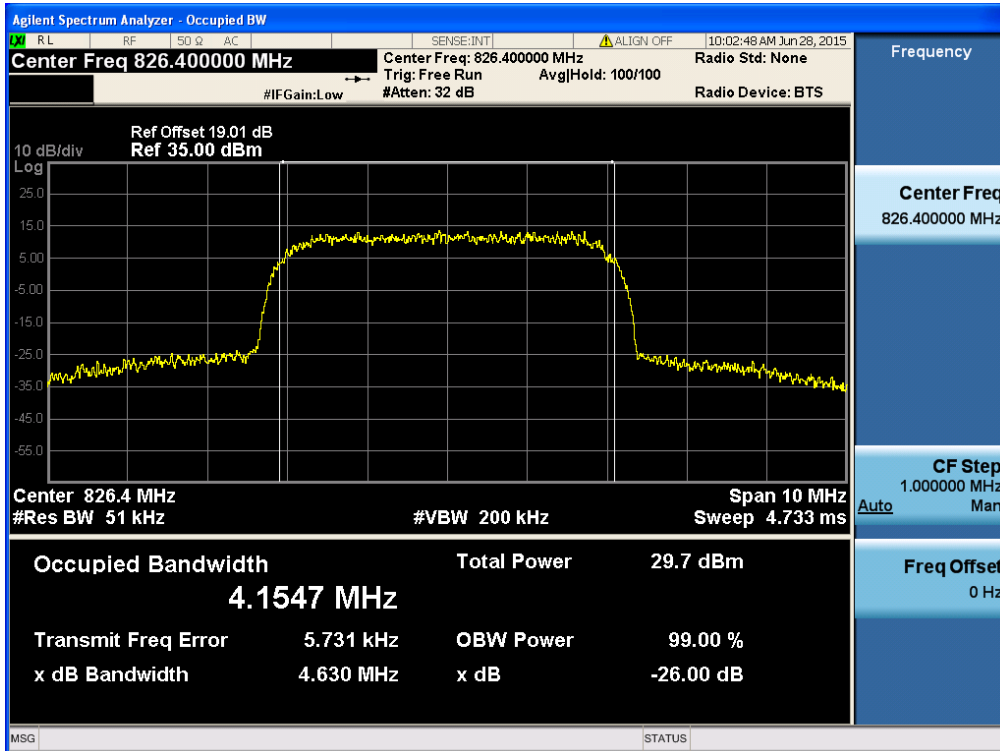

HSUPA850 & Channel: 4183

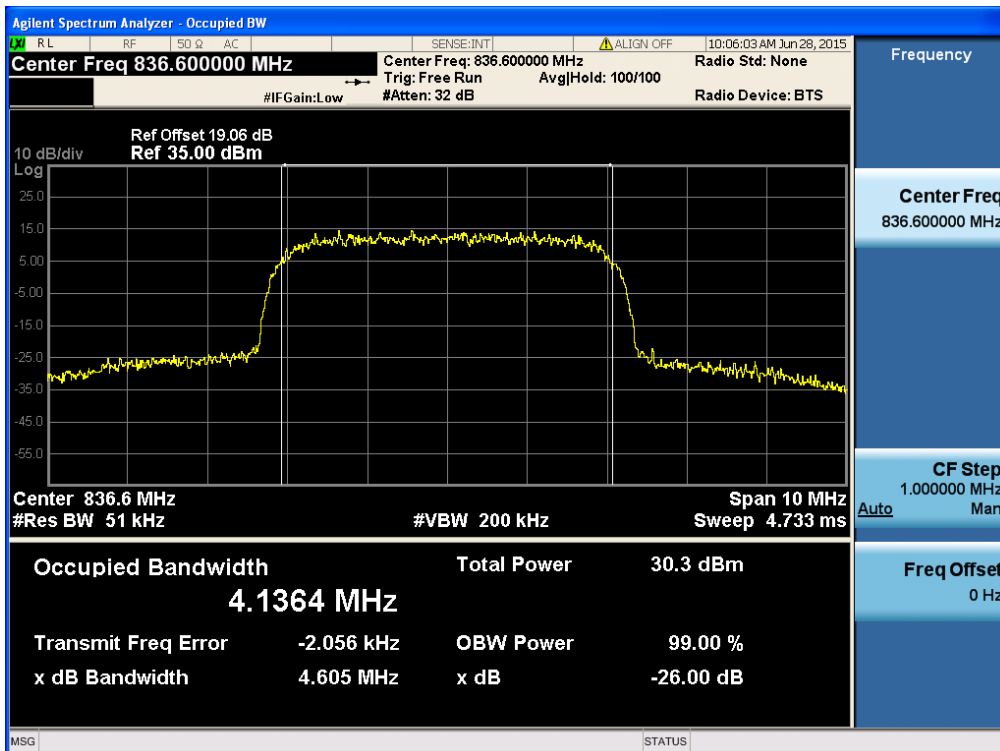

HSUPA850 & Channel: 4233

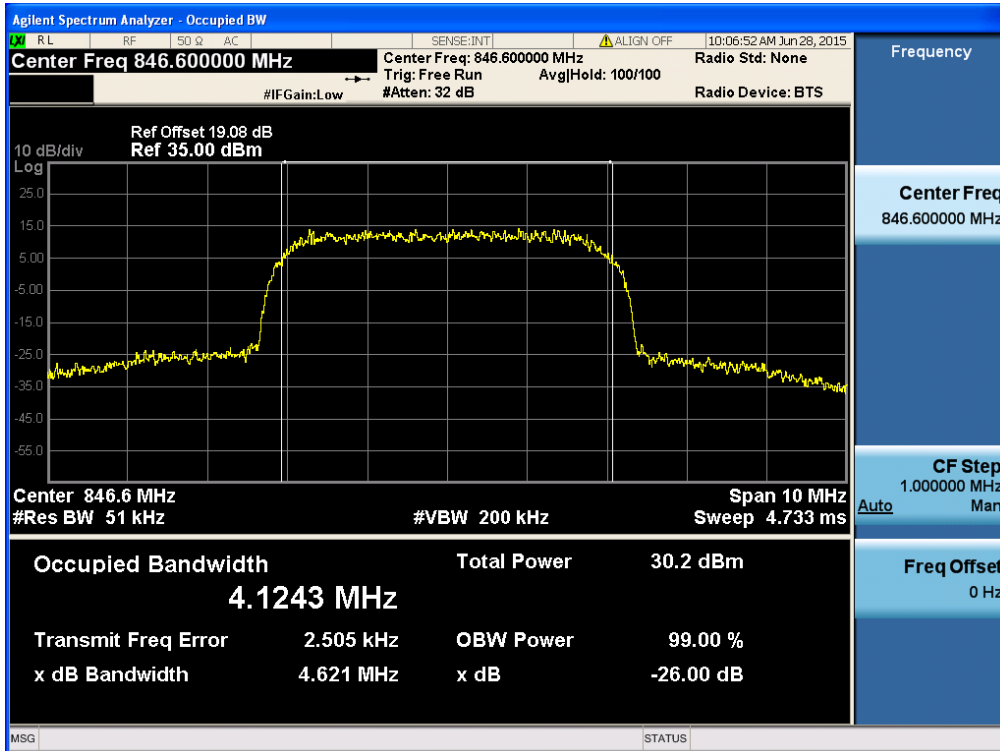

WCDMA1900 & Channel: 9262

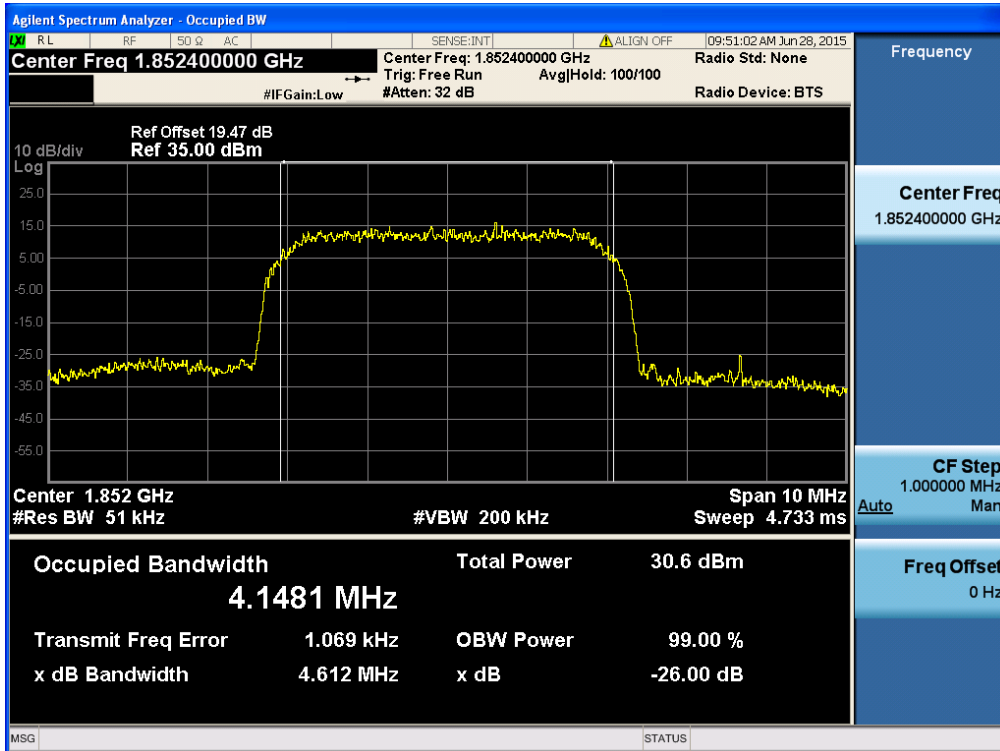

WCDMA1900 & Channel: 9400

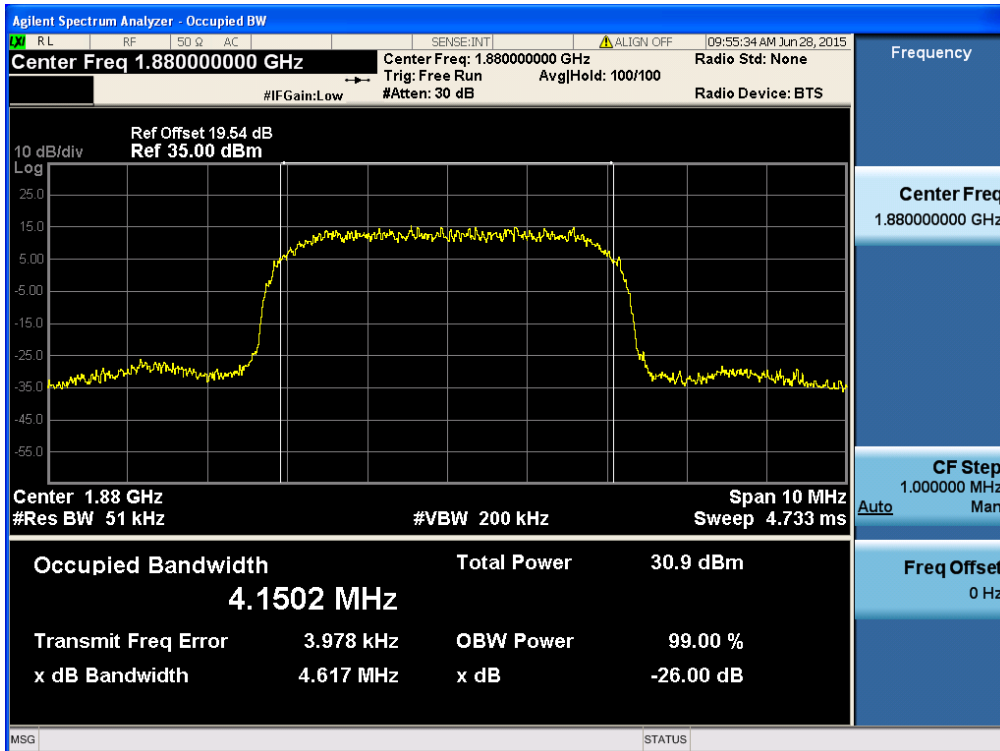

WCDMA1900 & Channel: 9538

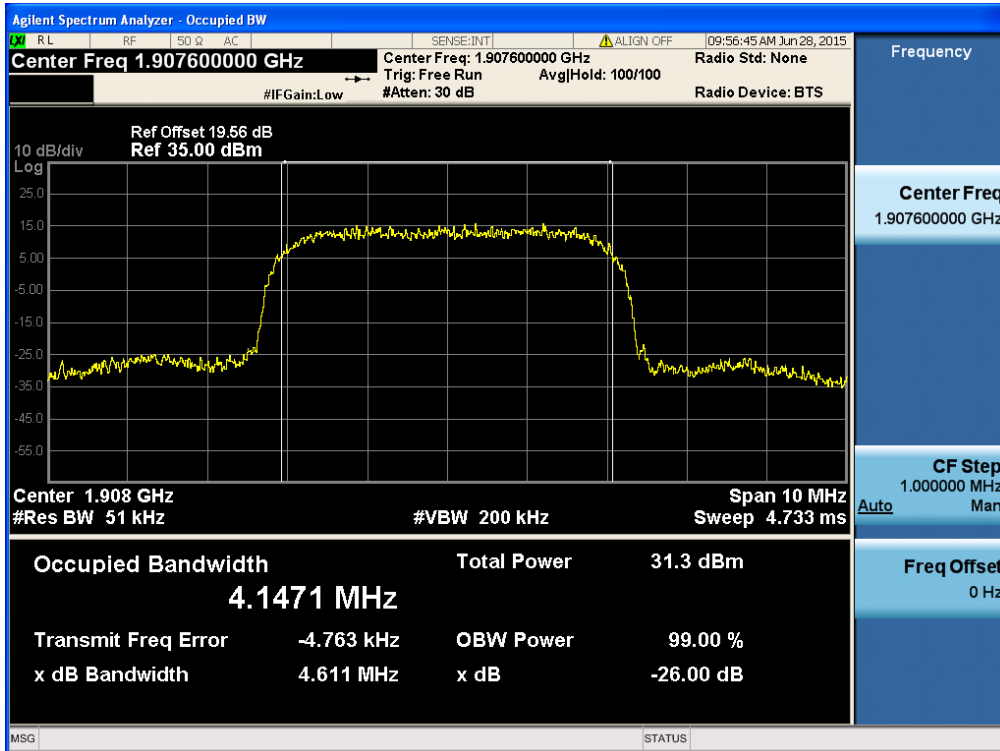

HSUPA1900 & Channel: 9262

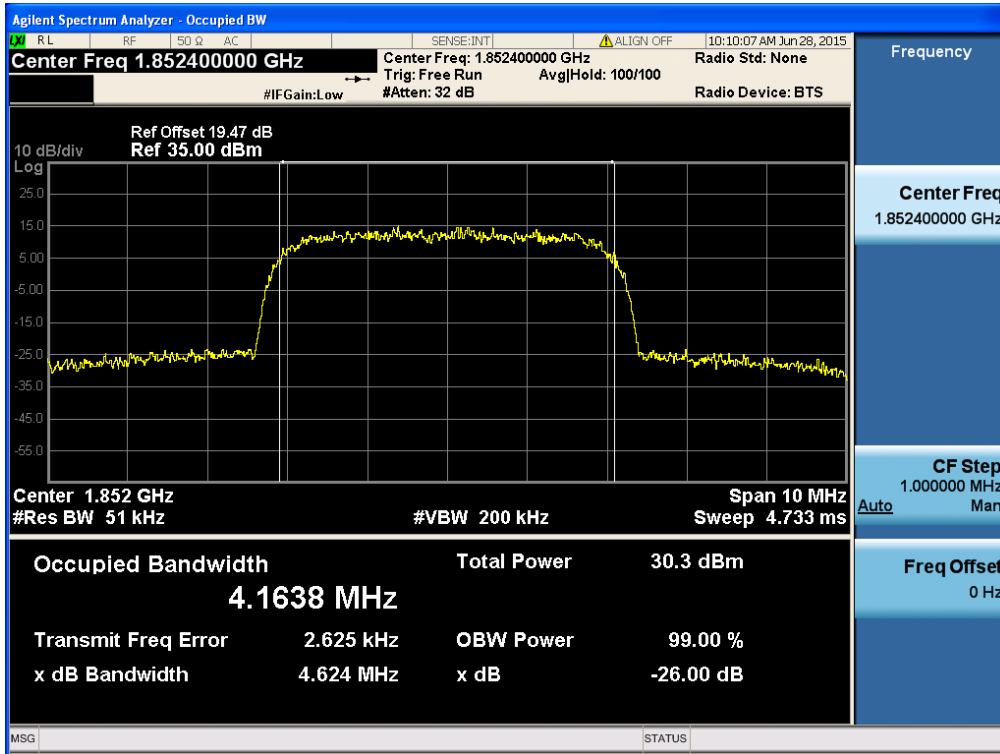

HSUPA1900 & Channel: 9400

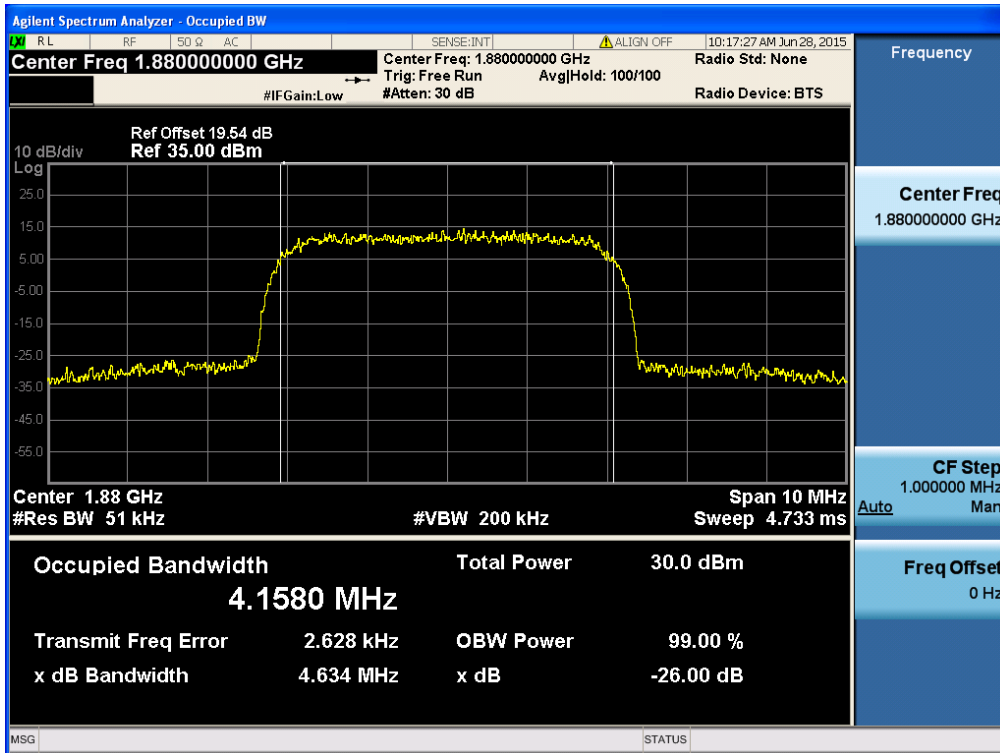

HSUPA1900 & Channel: 9538

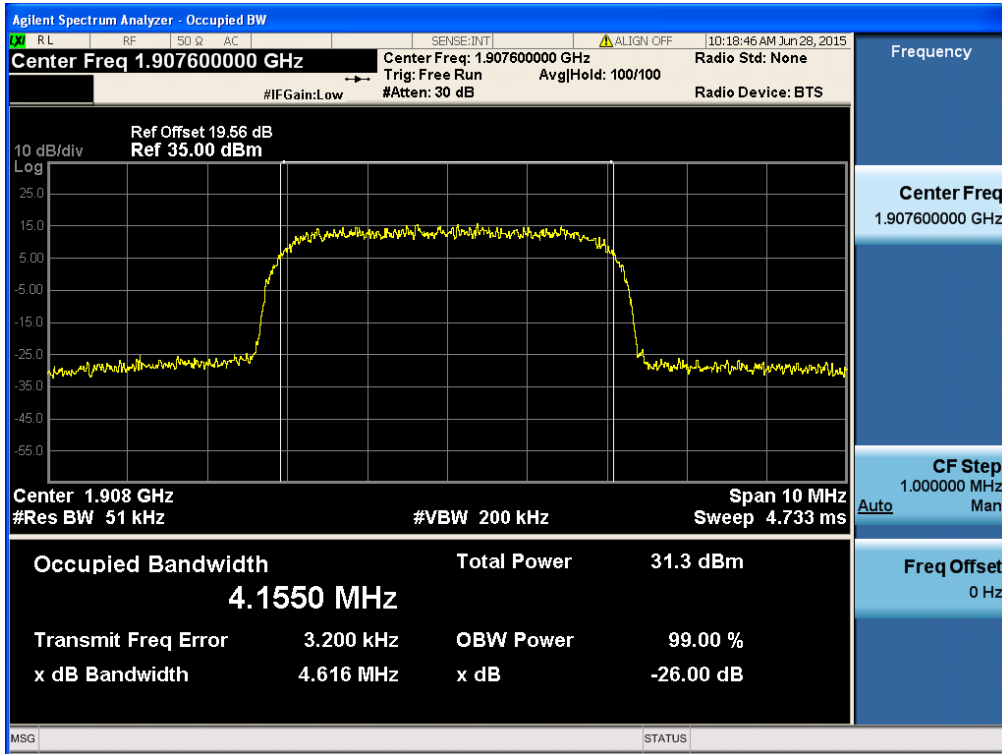

8.3 Spurious Emissions at Antenna Terminal

WCDMA850 & Channel: 4132

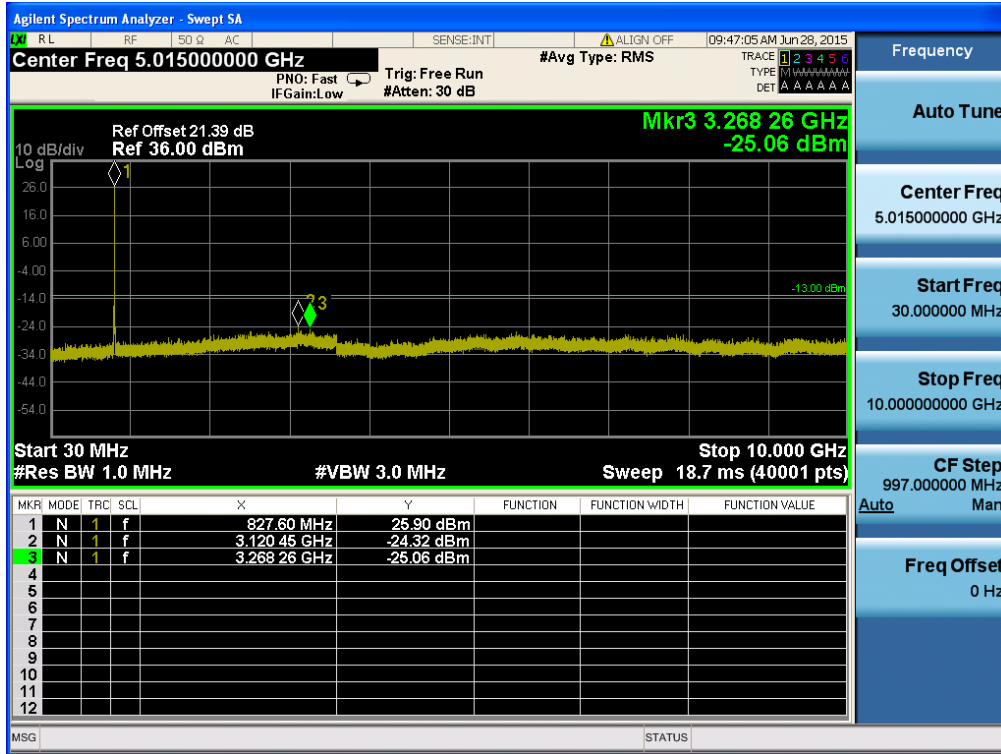

WCDMA850 & Channel: 4183

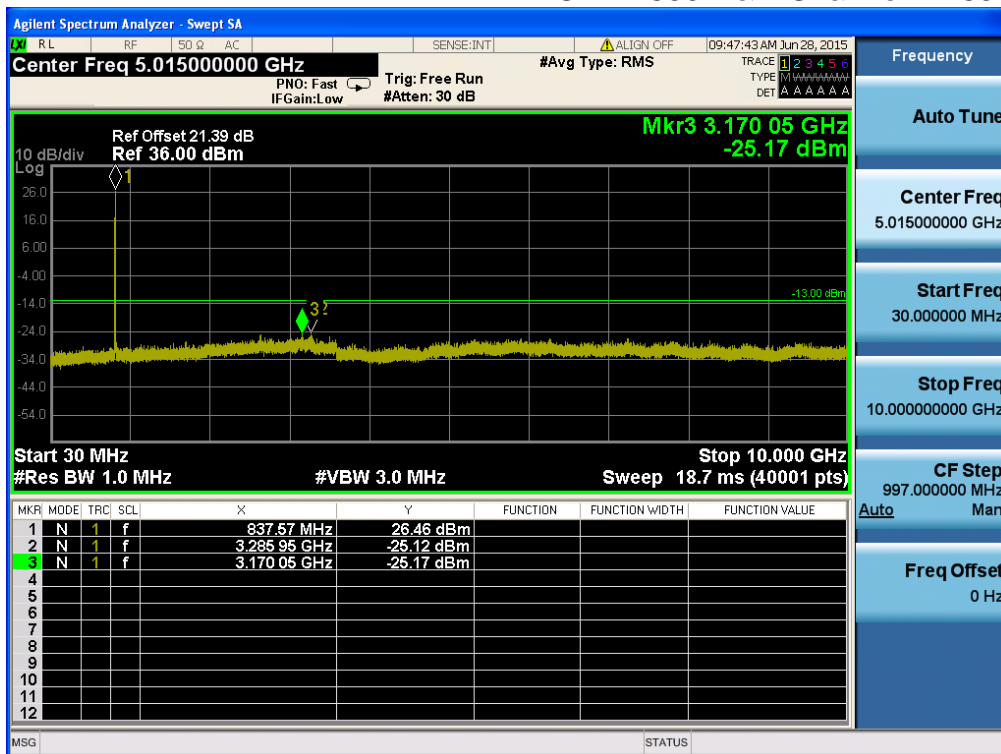

WCDMA850 & Channel: 4233

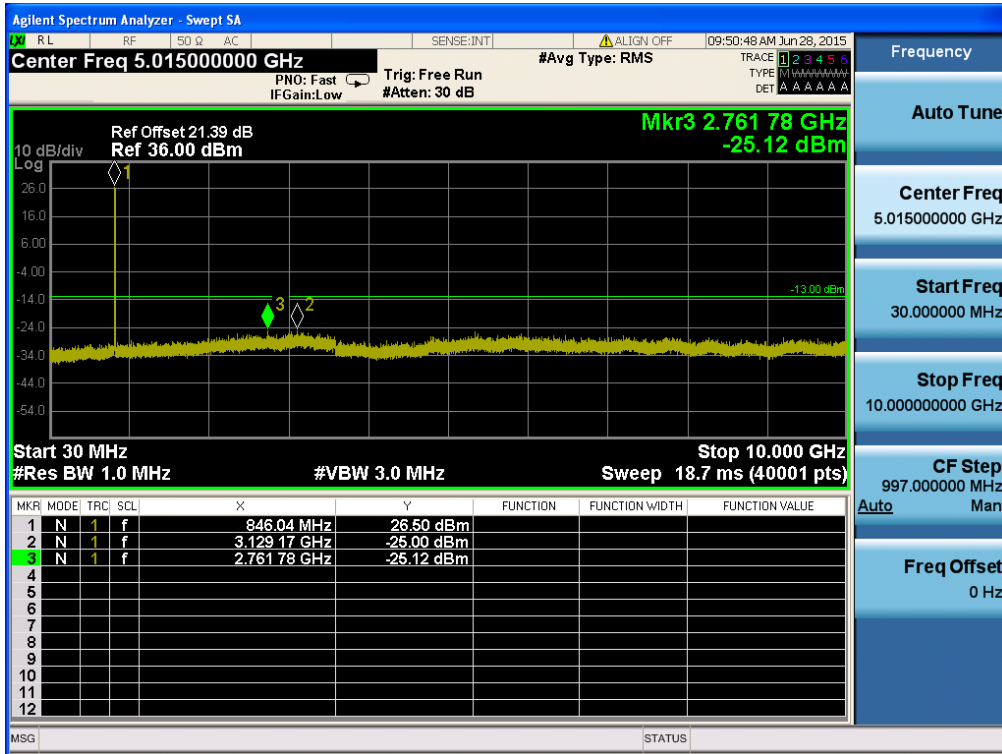

HSUPA850 & Channel: 4132

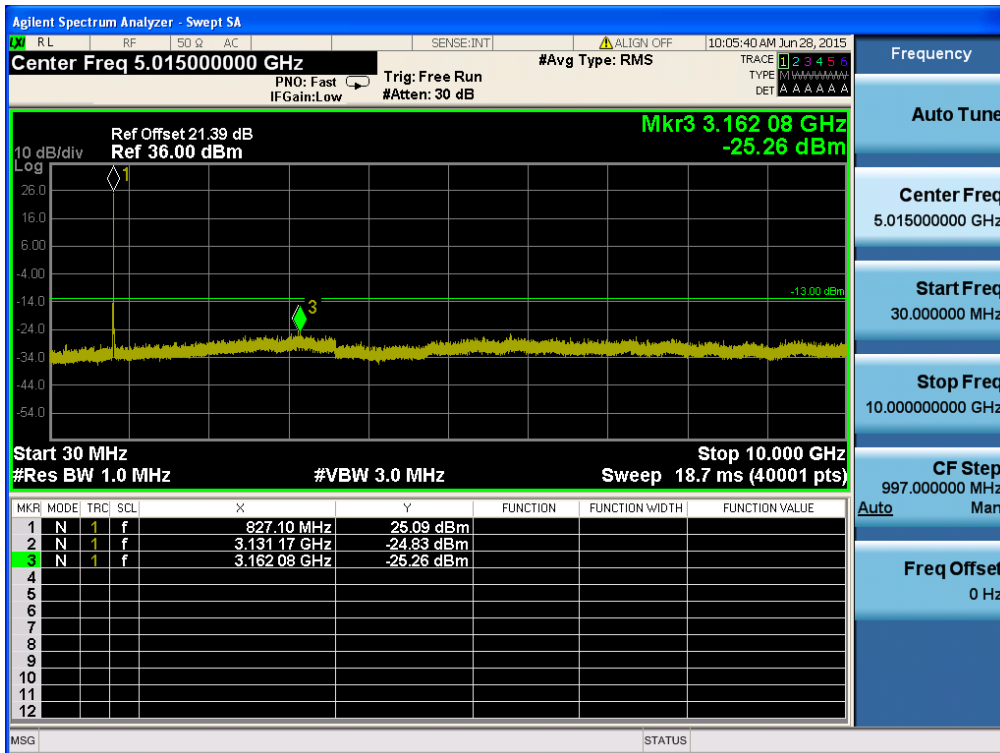

HSUPA850 & Channel: 4183

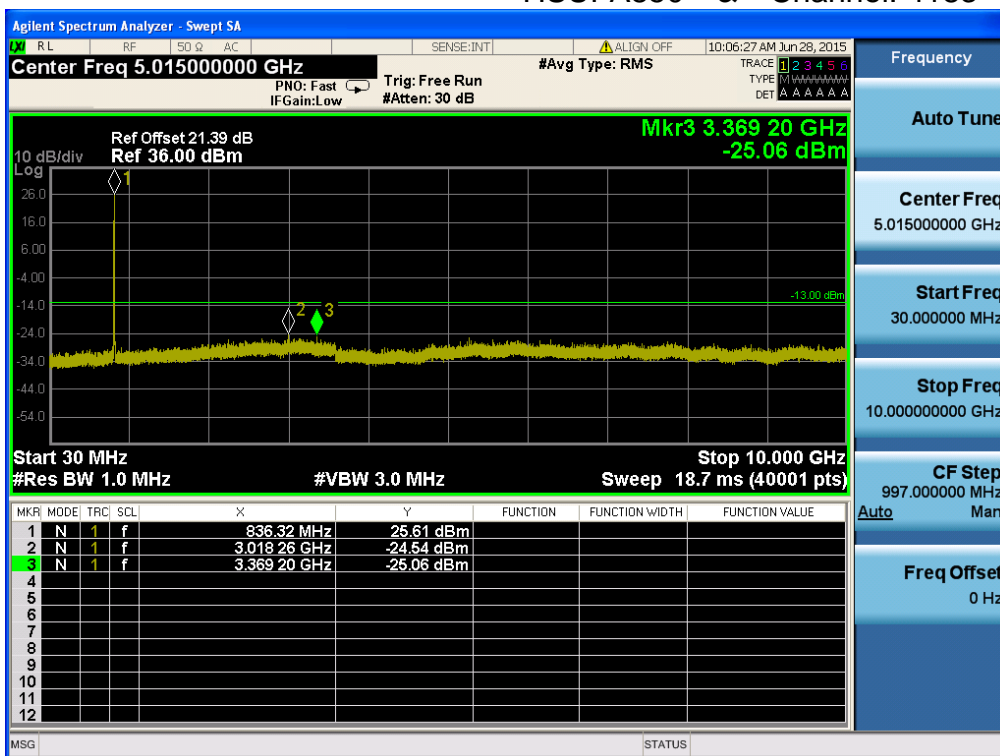

HSUPA850 & Channel: 4233

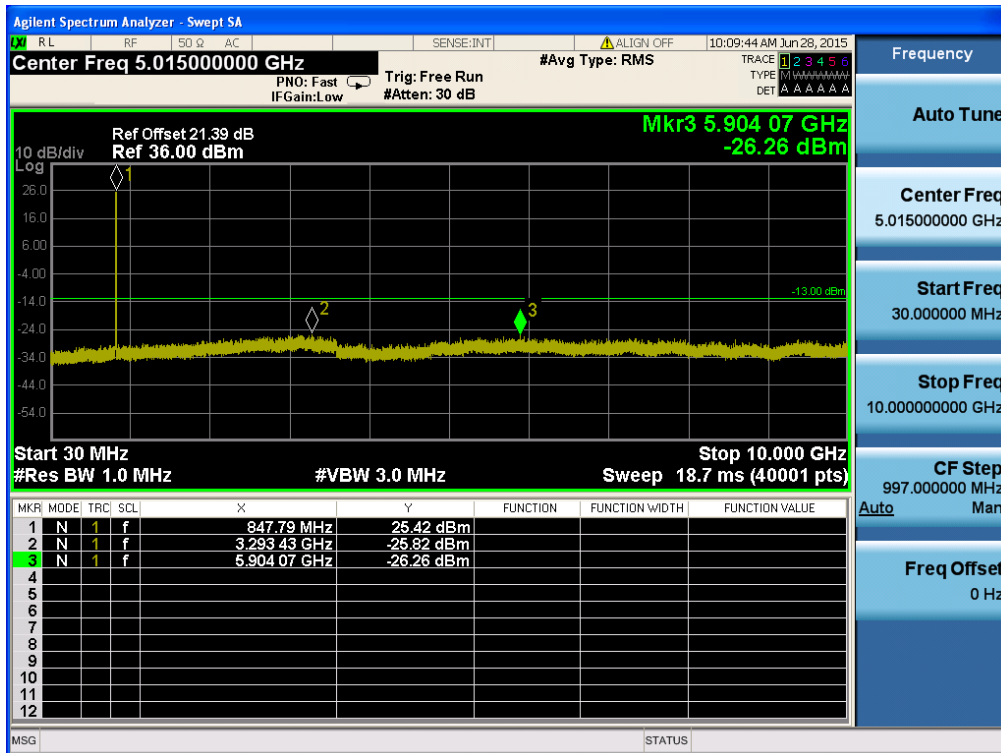

WCDMA1900 & Channel: 9262

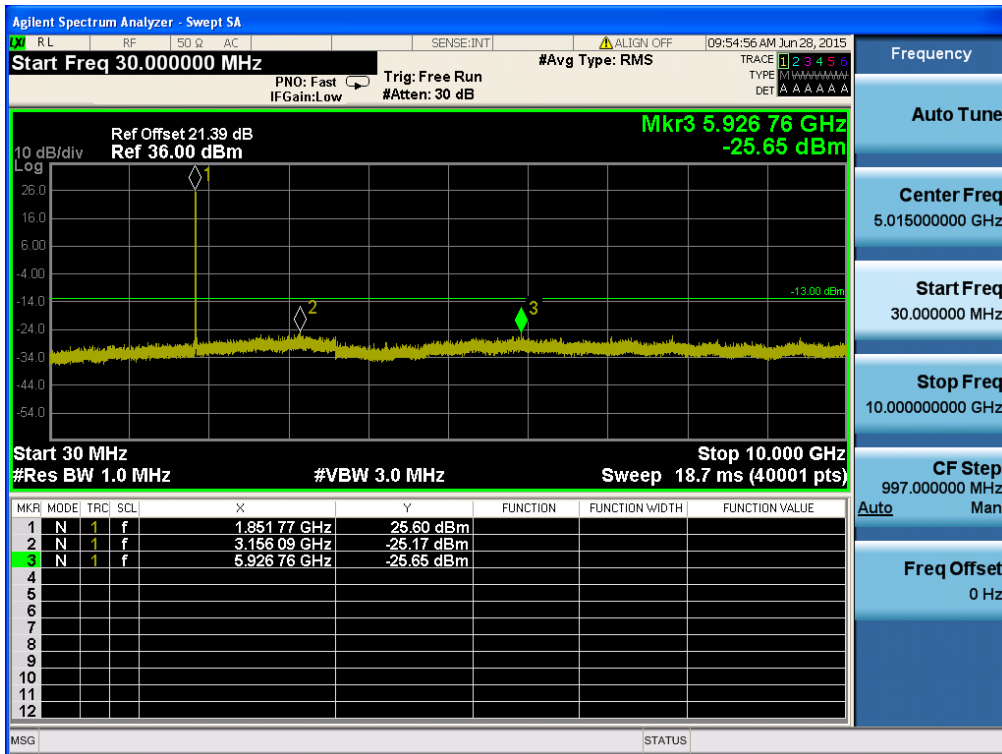

WCDMA1900 & Channel: 9262

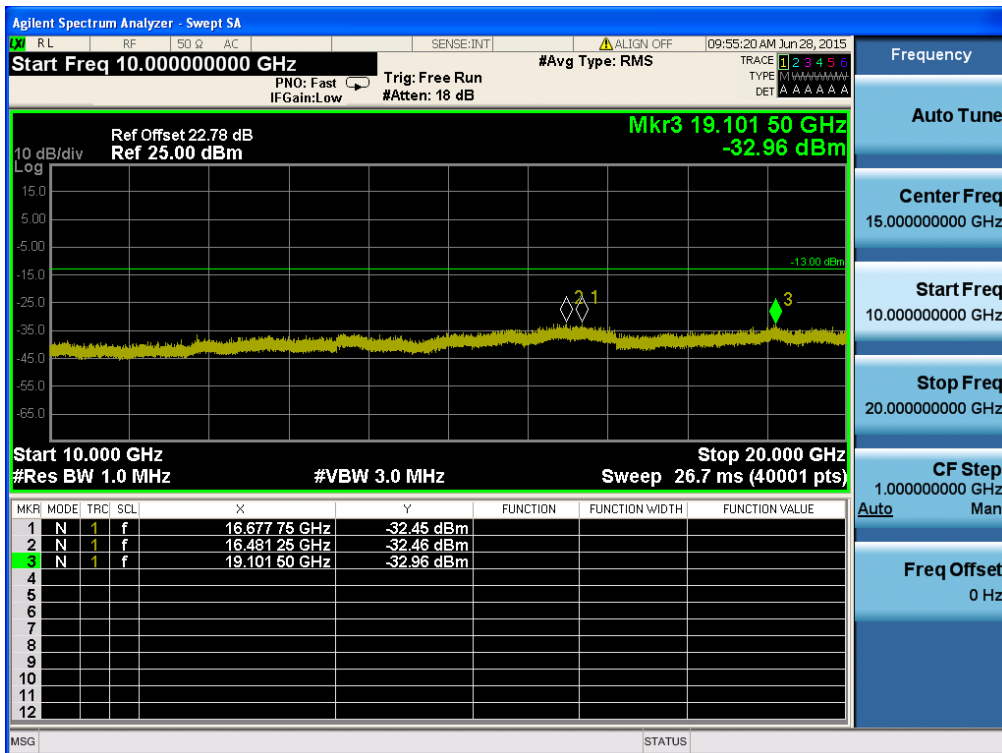

WCDMA1900 & Channel: 9400

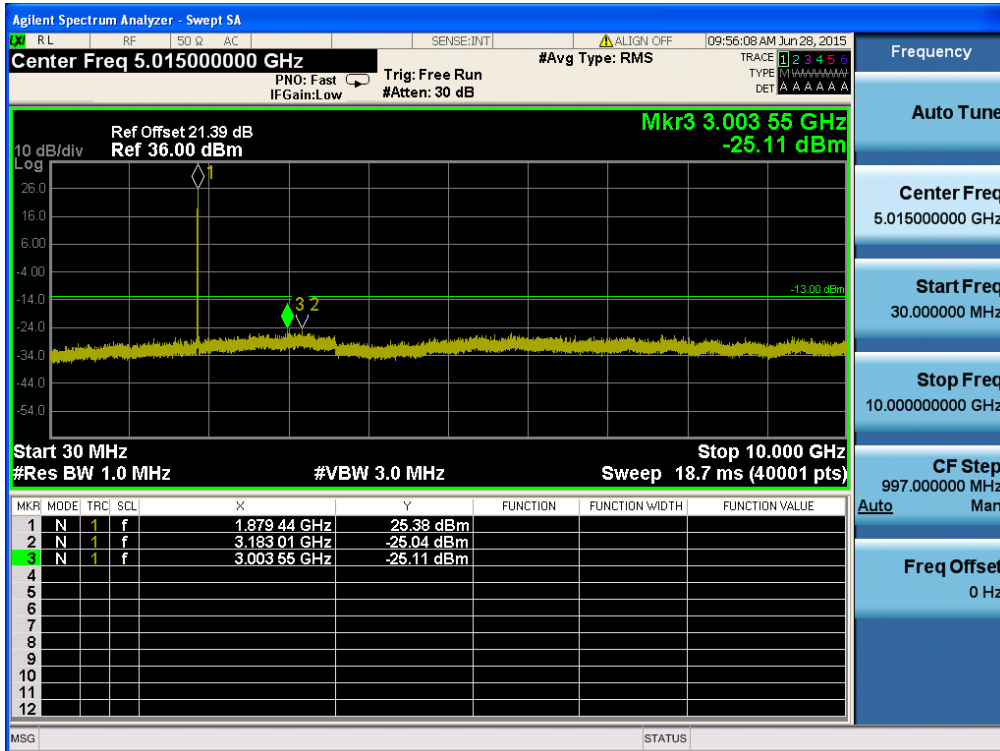

WCDMA1900 & Channel: 9400

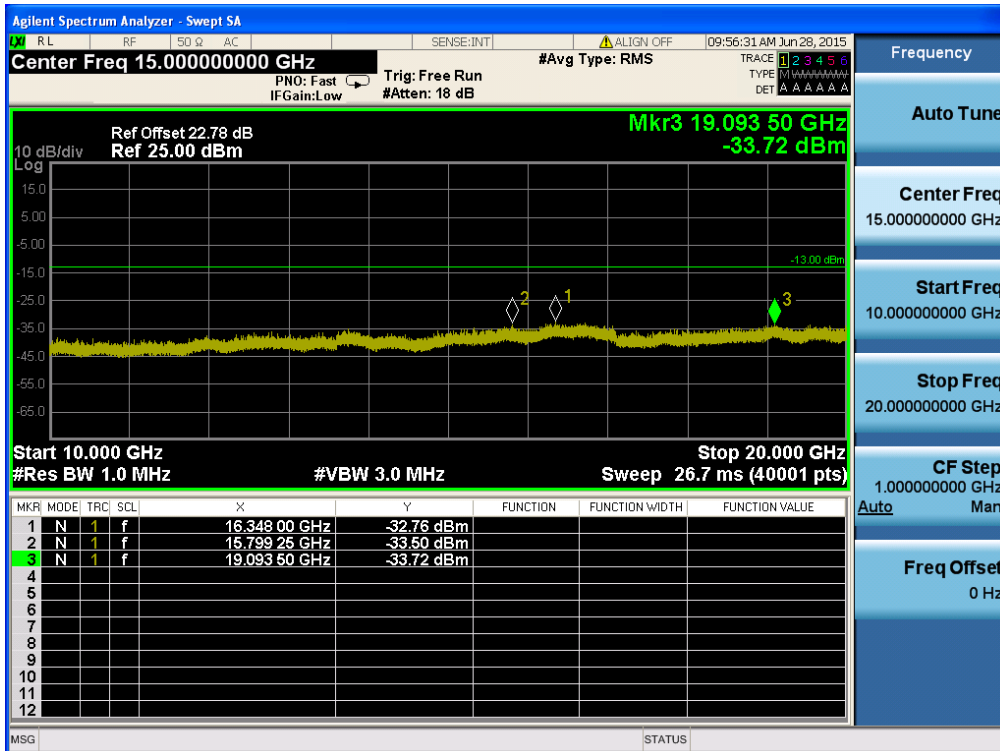

WCDMA1900 & Channel: 9538

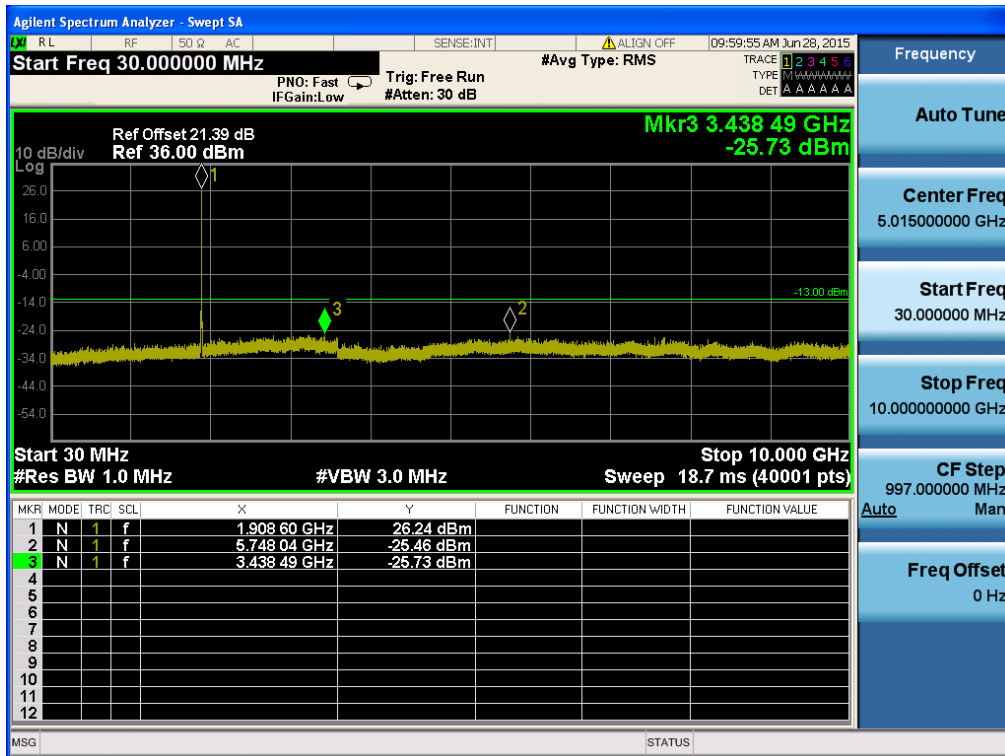

WCDMA1900 & Channel: 9538

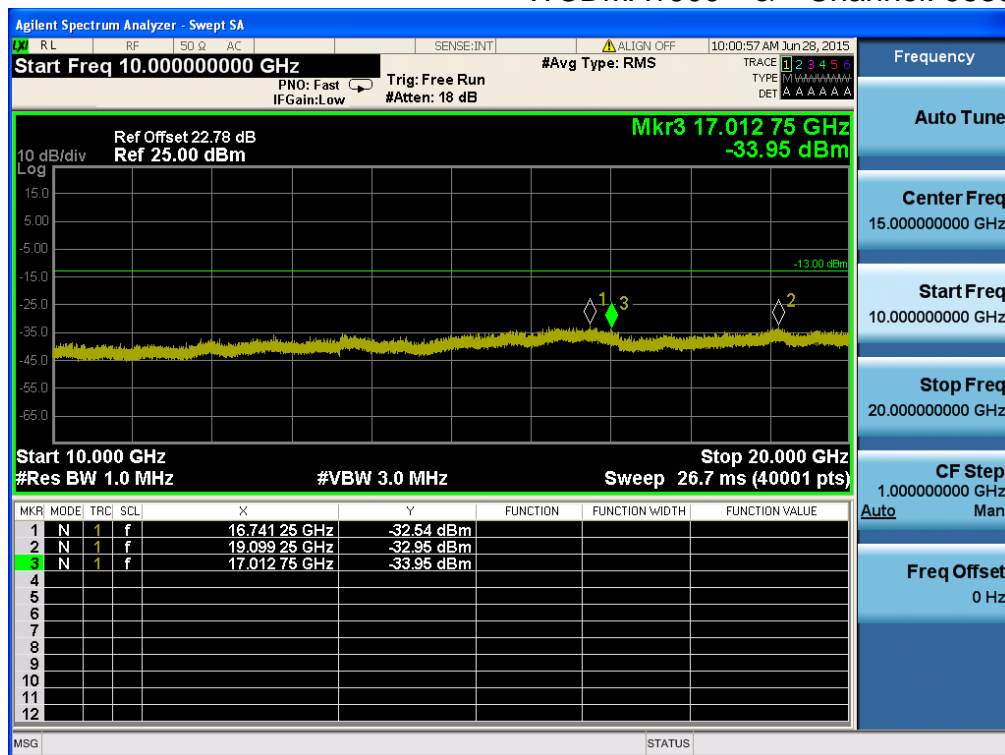

HSUPA1900 & Channel: 9262

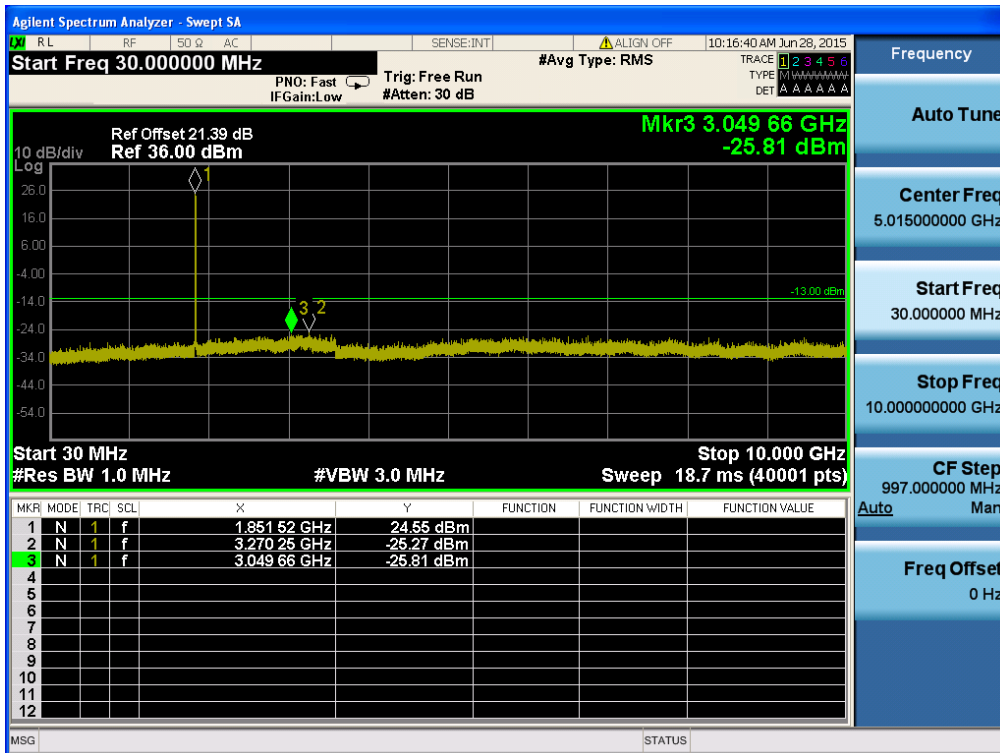

HSUPA 1900 & Channel: 9262

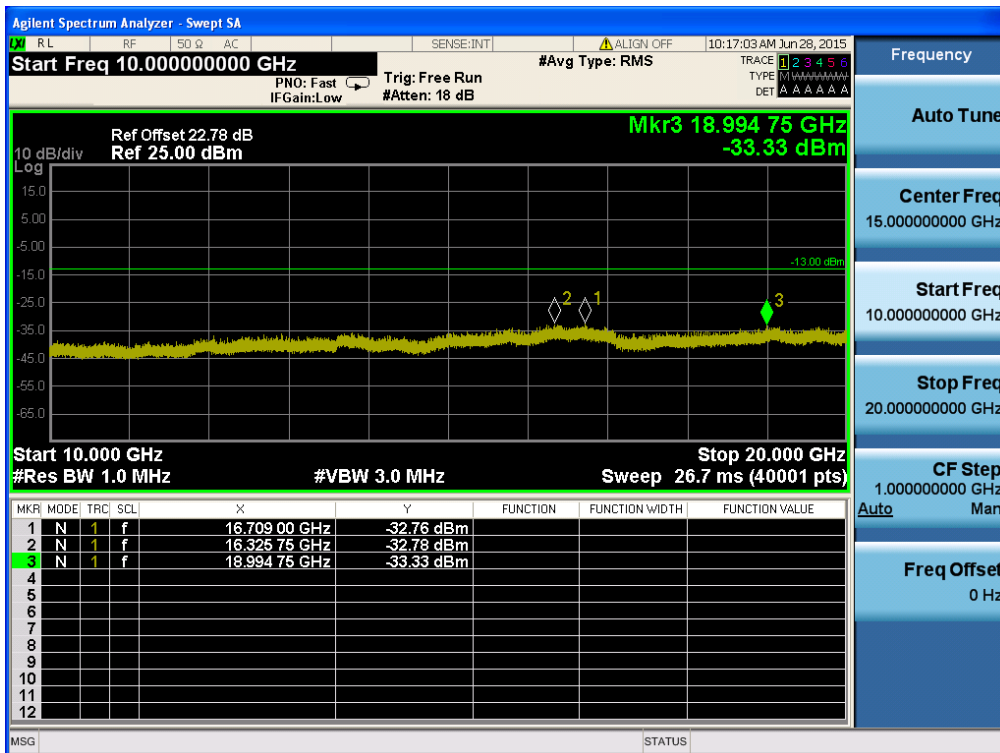

HSUPA1900 & Channel: 9400

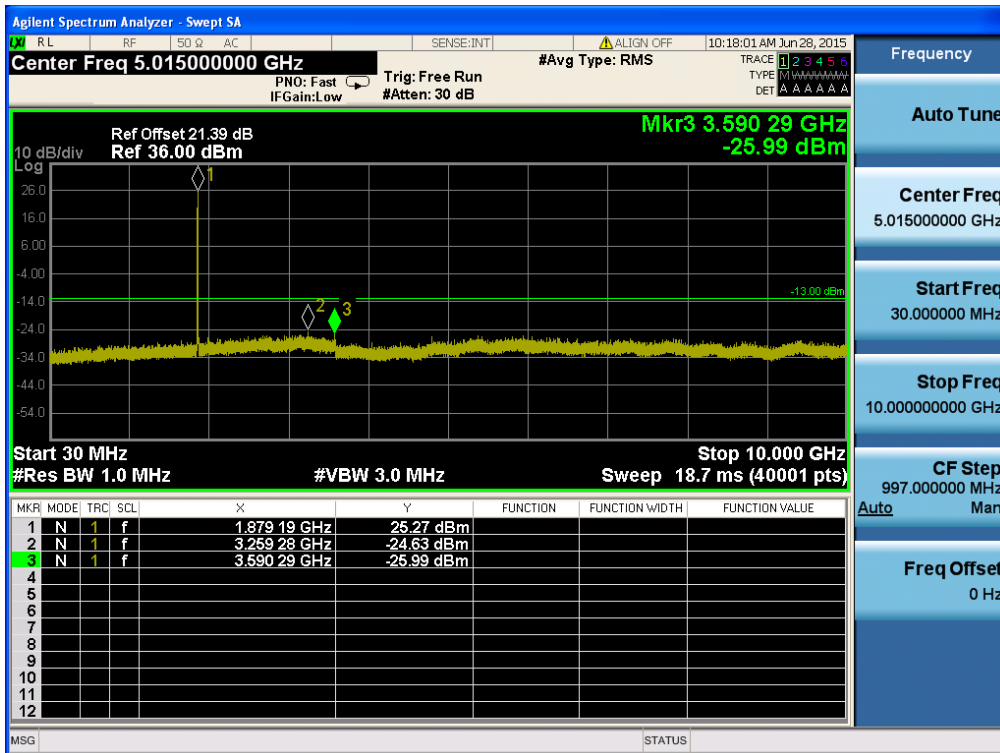

HSUPA1900 & Channel: 9400

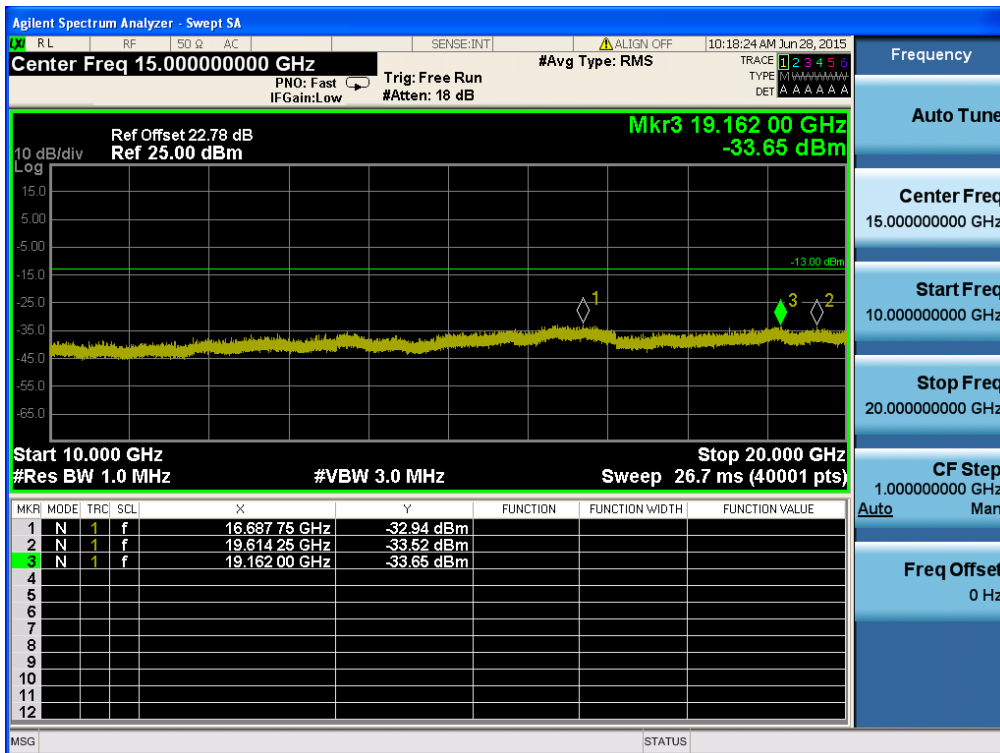

HSUPA1900 & Channel: 9538

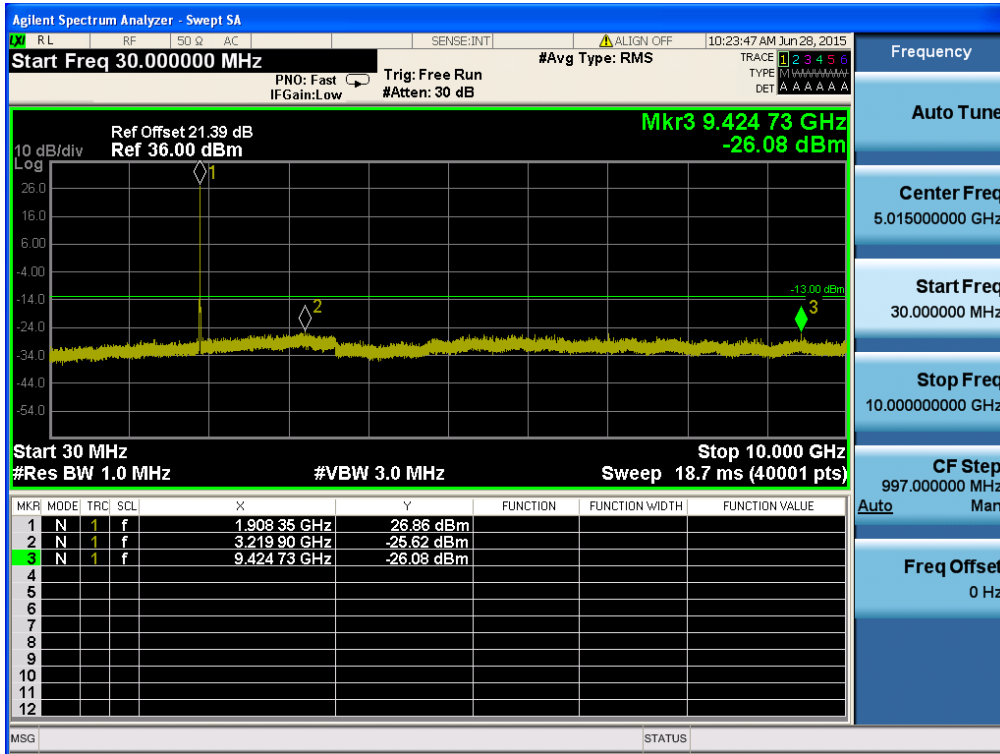

HSUPA1900 & Channel: 9538

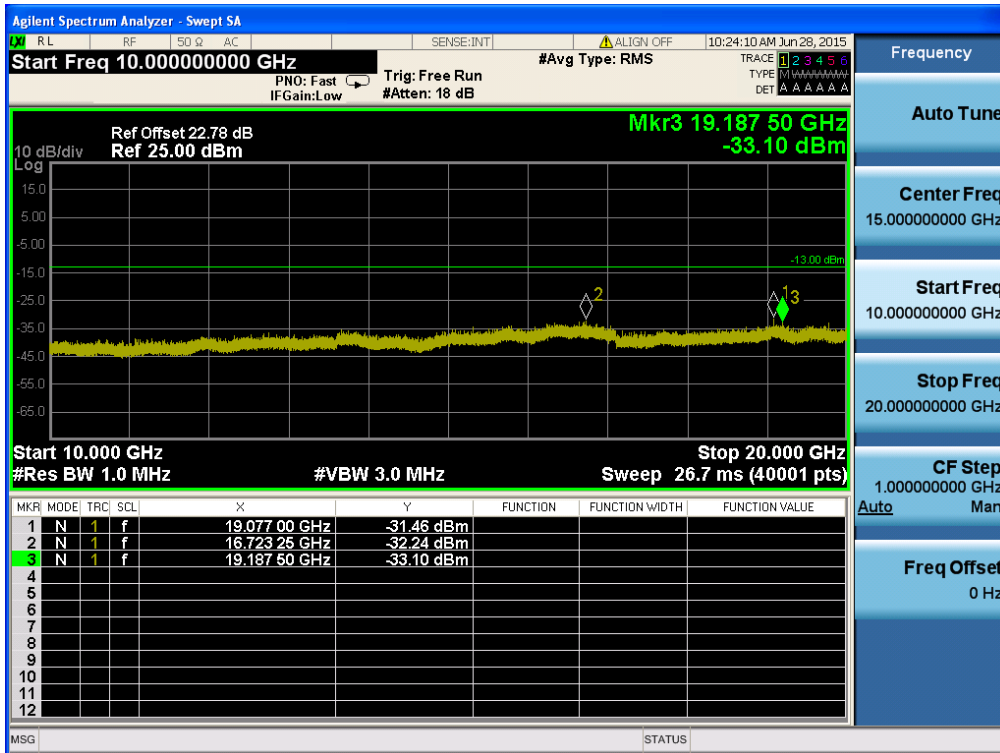

8.4 Band Edge

WCDMA850& Channel: 4132

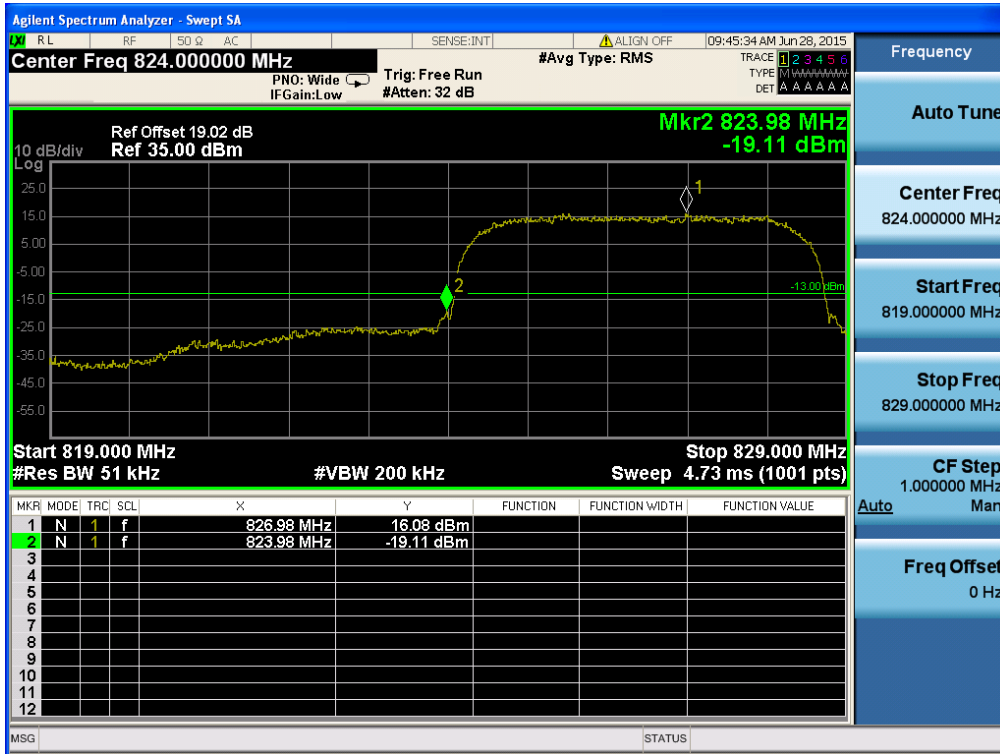

WCDMA850& Channel: 4132

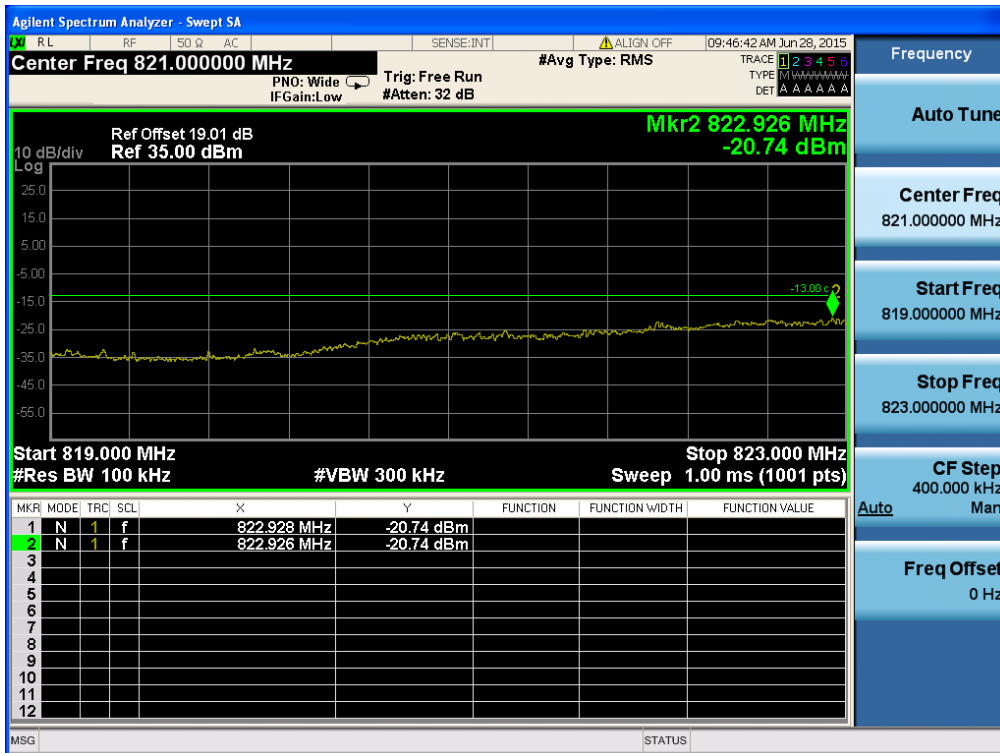

WCDMA850& Channel: 4233



WCDMA850& Channel: 4233

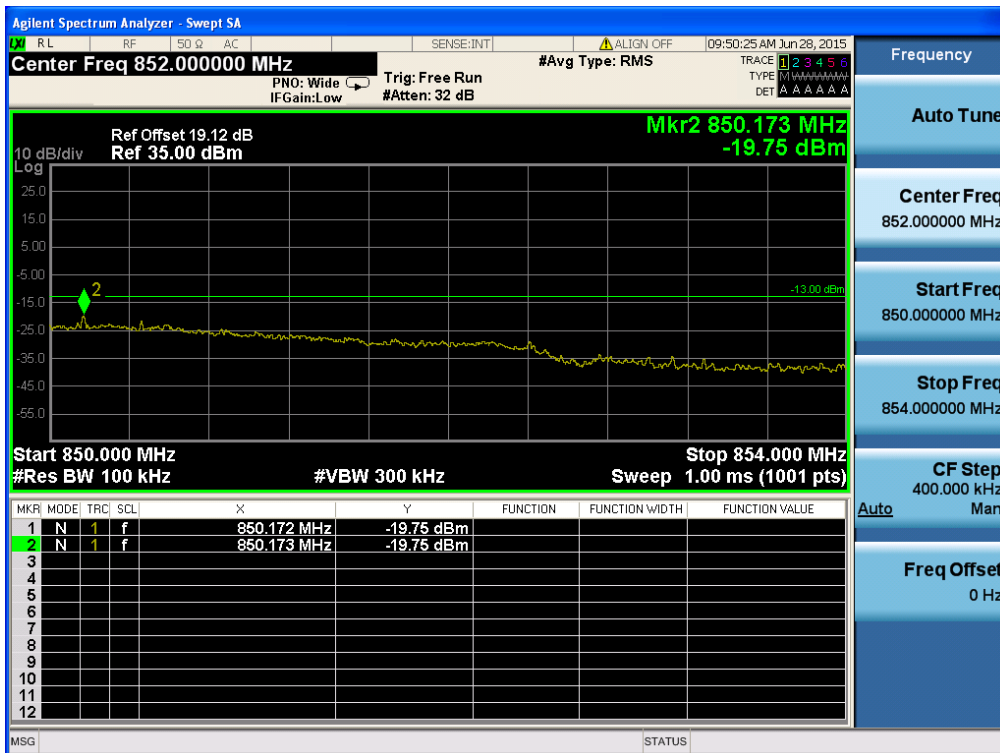

HSUPA850& Channel: 4132

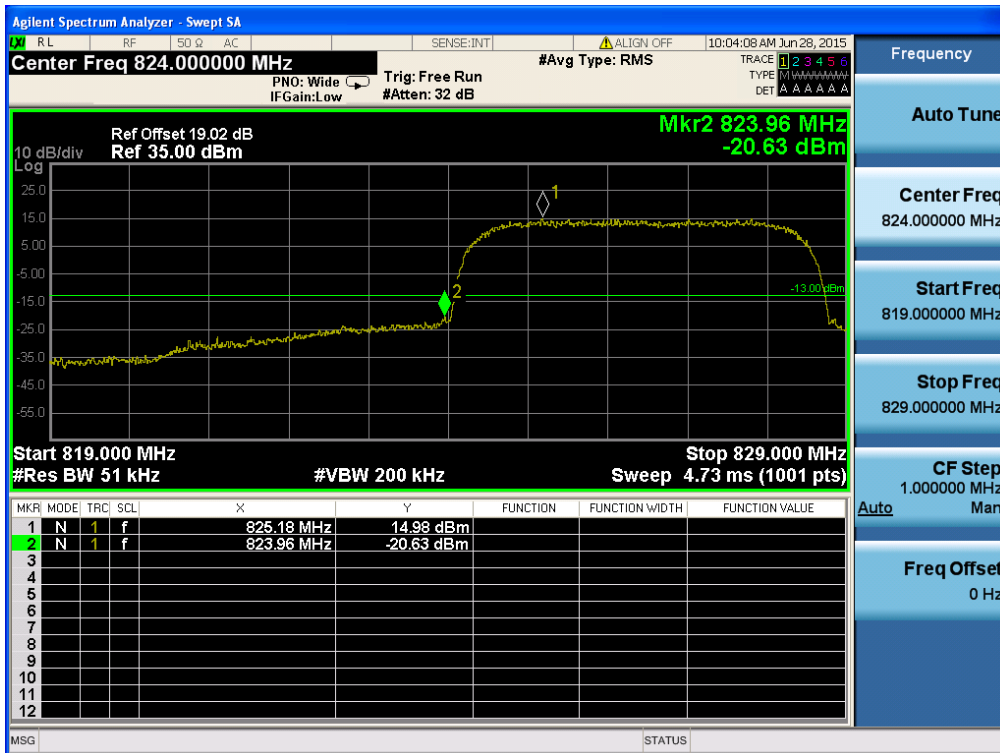

HSUPA850 & Channel: 4132

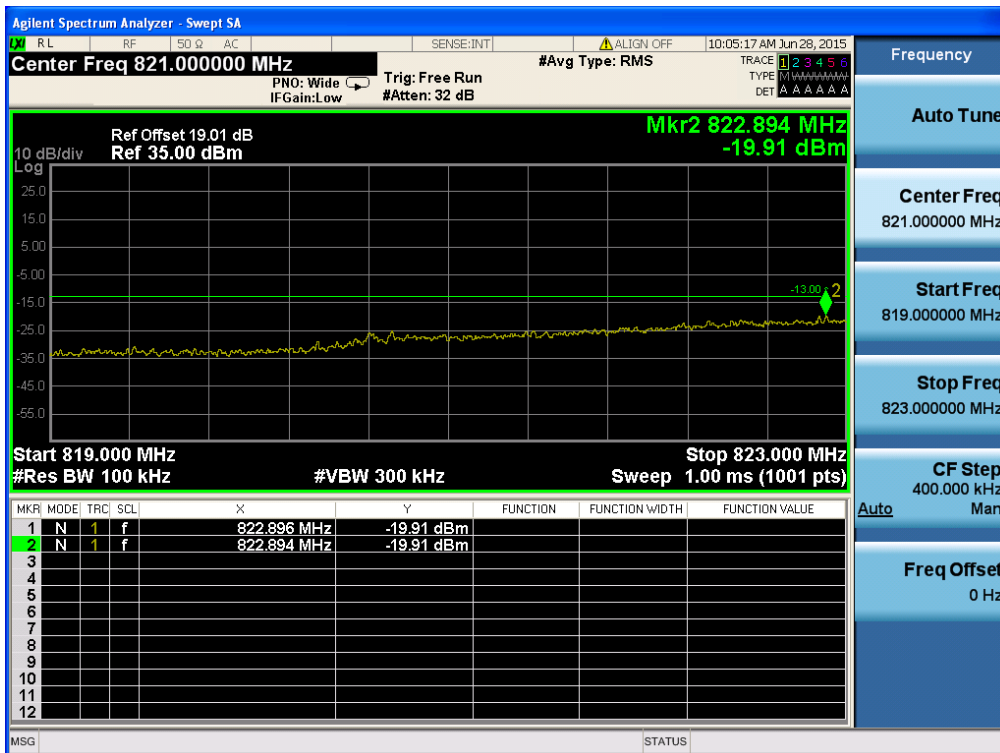

HSUPA850 & Channel: 4233



HSUPA850 & Channel: 4233

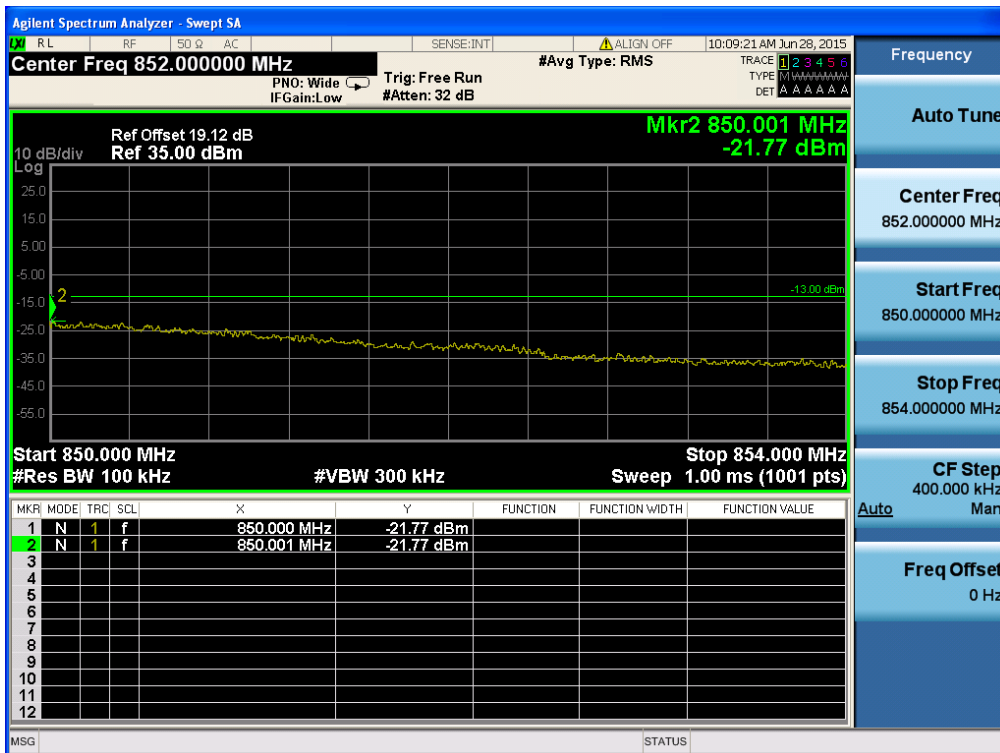

WCDMA1900 & Channel: 9262



WCDMA1900 & Channel: 9262

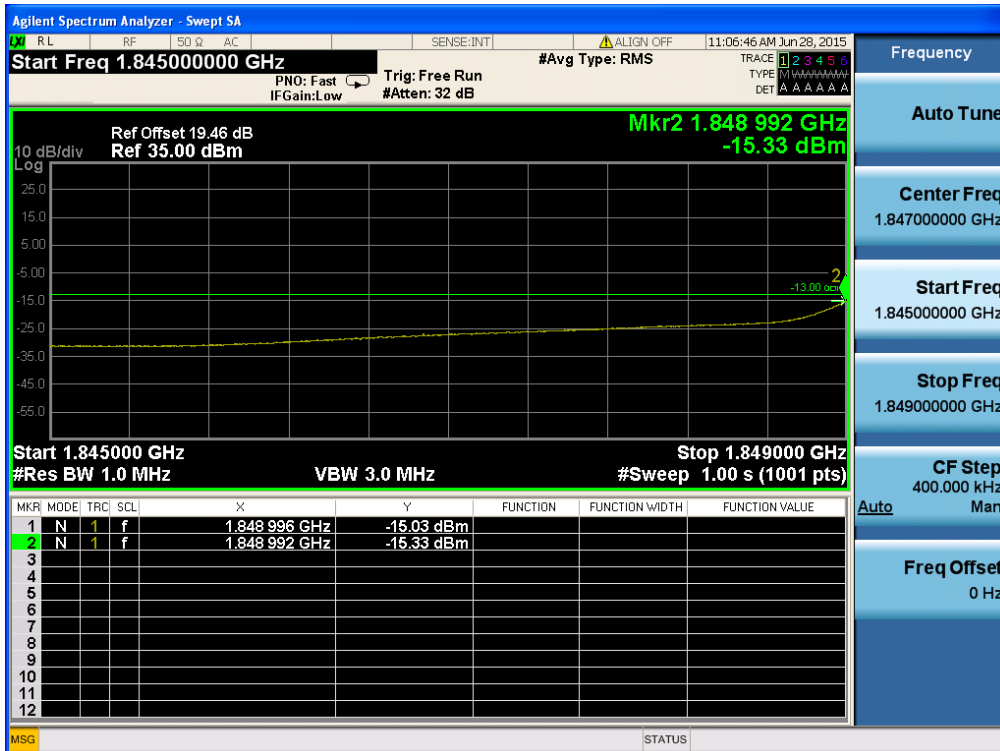

WCDMA1900 & Channel: 9538

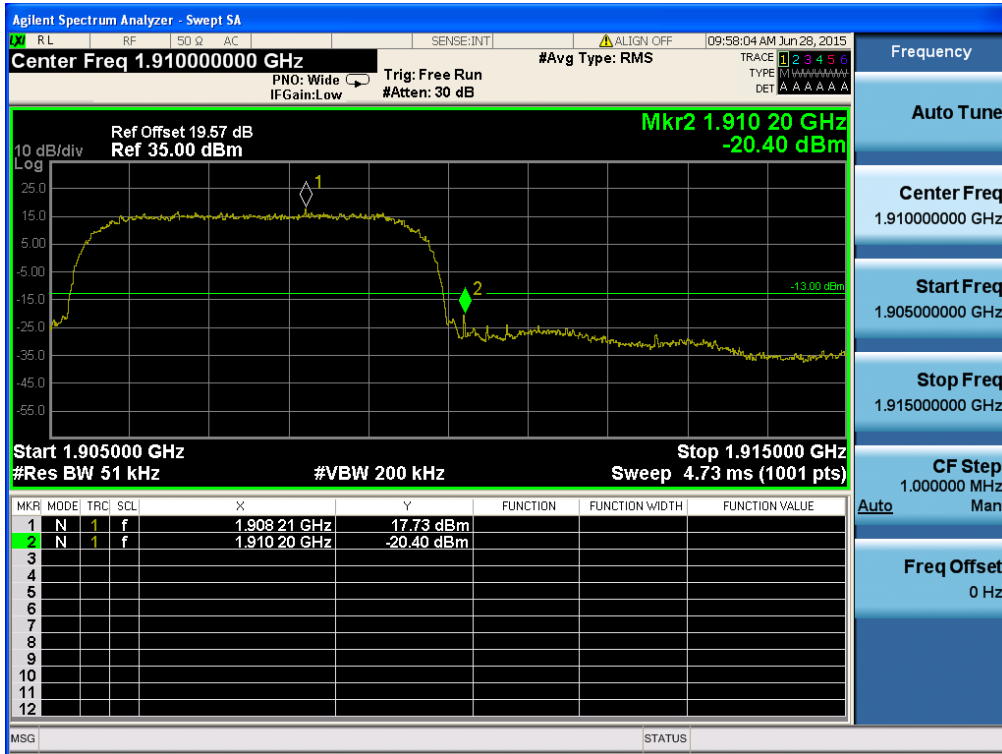

WCDMA1900 & Channel: 9538

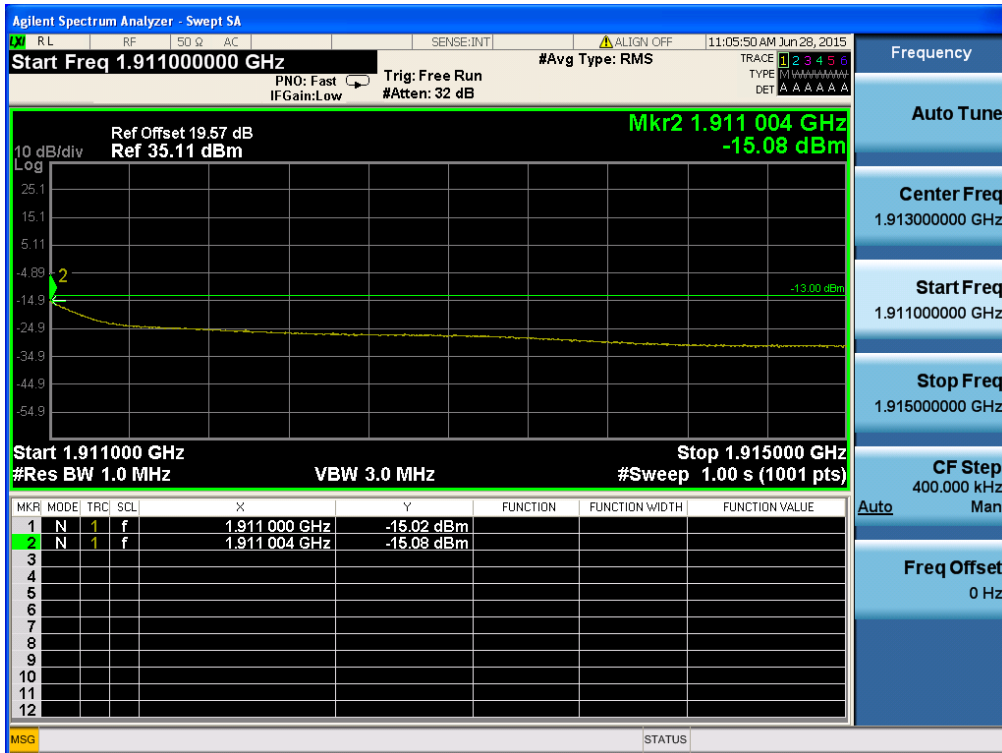

HSUPA1900 & Channel: 9262

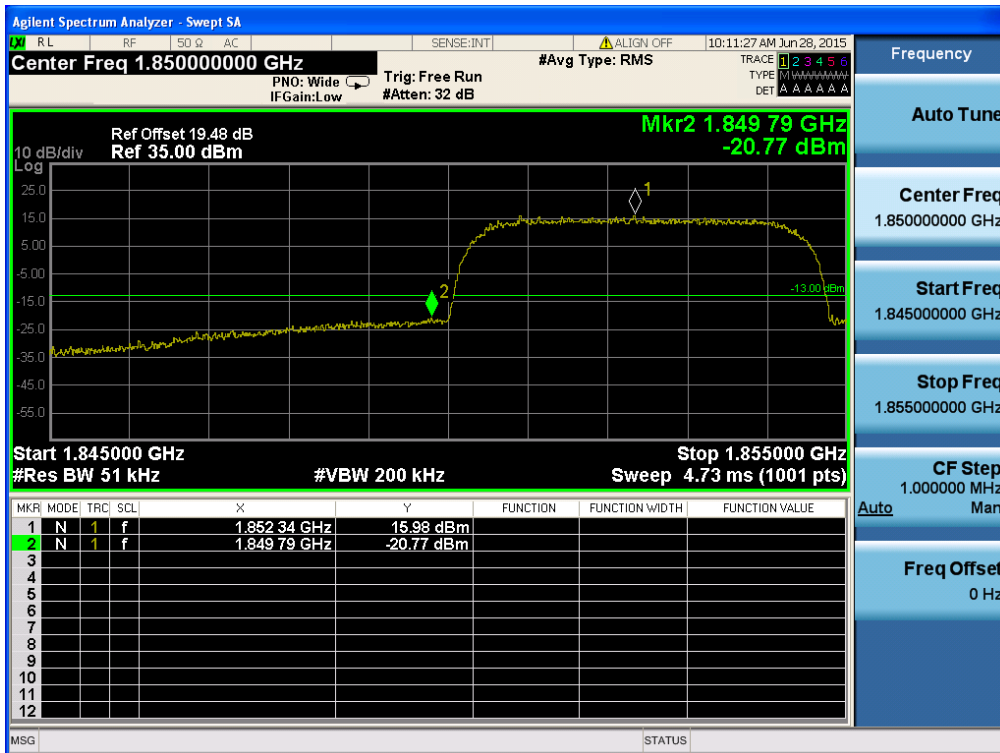

HSUPA1900 & Channel: 9262

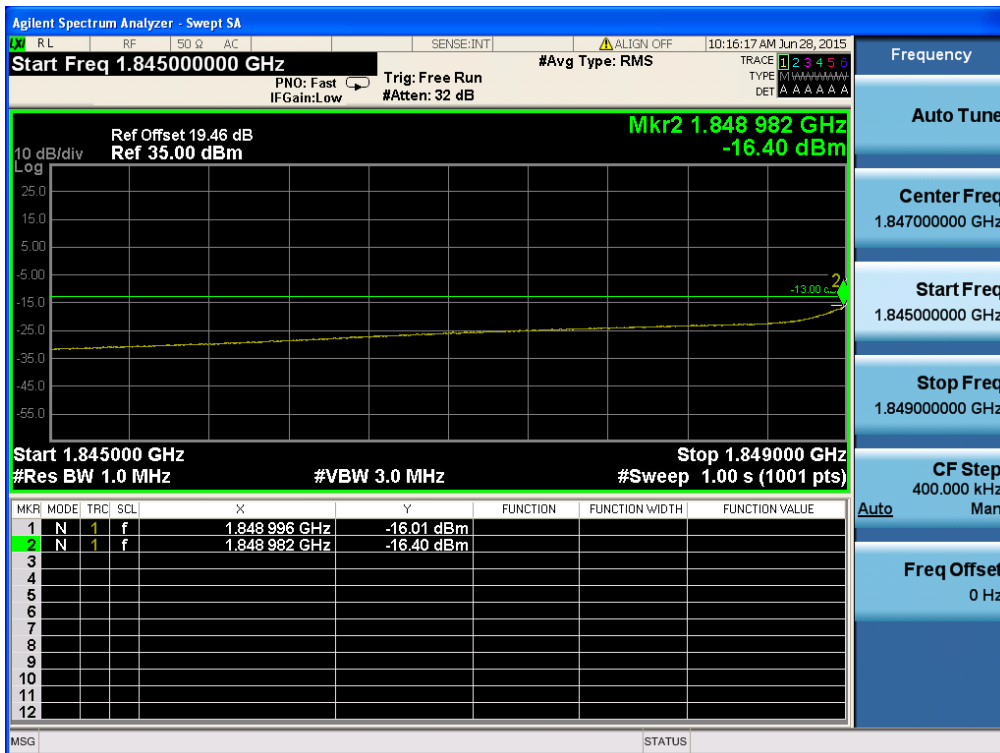

HSUPA1900 & Channel: 9538

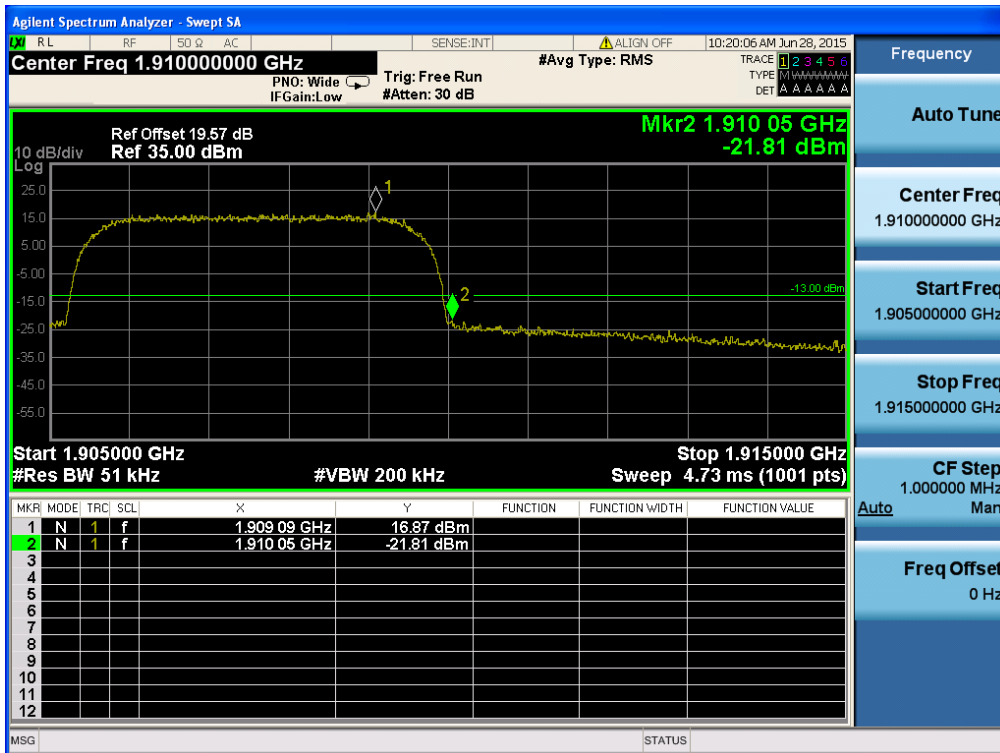

HSUPA1900 & Channel: 9538

