

TEST REPORT

of

FCC Part 15 Subpart C §15.247
IC RSS-247 Issue 2 and RSS-Gen Issue 5

FCC ID: YZP-ATC5CPL004
IC Certification: 7414C-ATC5CPL004

Equipment Under Test : BT/WIFI Combo Module
Model Name : ATC5CPL004
Variant Model Name(s) : -
FCC Applicant : LG Innotek Co., Ltd.
IC Applicant : LG Innotek Co., Ltd.
Manufacturer : LG Innotek Co., Ltd.
Date of Receipt : 2023.03.14
Date of Test(s) : 2023.03.14 ~ 2023.04.24
Date of Issue : 2023.04.24

In the configuration tested, the EUT complied with the standards specified above. This test report does not assure KOLAS accreditation.

- 1) The results of this test report are effective only to the items tested.
- 2) The SGS Korea is not responsible for the sampling, the results of this test report apply to the sample as received.
- 3) This test report cannot be reproduced, except in full, without prior written permission of the Company.
- 4) The data marked ※ in this report was provided by the customer and may affect the validity of the test results.

We are responsible for all the information of this test report except for the data(※) provided by the customer.

Tested by:



Teo Kim

Technical
Manager:



Jinhyoung Cho

SGS Korea Co., Ltd. Gunpo Laboratory

INDEX

<u>Table of Contents</u>	Page
1. General Information -----	3
2. Transmitter Radiated Spurious Emissions and Conducted Spurious Emissions ----	10
3. 20 dB Bandwidth & 99 % Bandwidth -----	30
4. Maximum Peak Conducted Output Power -----	39
5. Carrier Frequency Separation -----	41
6. Number of Hopping Frequencies -----	43
7. Time of Occupancy(Dwell Time) -----	45
8. AC Power Line Conducted Emission -----	53
9. Antenna Requirement -----	58

1. General Information

1.1 Testing Laboratory

SGS Korea Co., Ltd. (Gunpo Laboratory)
 - 10-2, LS-ro 182beon-gil, Gunpo-si, Gyeonggi-do, Korea, 15807
 - 4, LS-ro 182beon-gil, Gunpo-si, Gyeonggi-do, Korea, 15807
 - Designation number: KR0150

All SGS services are rendered in accordance with the applicable SGS conditions of service available on request and accessible at <http://www.sgs.com/en/Terms-and-Conditions.aspx>.

Phone No. : +82 31 688 0901
 Fax No. : +82 31 688 0921

1.2. Details of Applicant

FCC Applicant : LG Innotek Co., Ltd.
 FCC Address : 26, Hanamsandan 5beon-ro, Gwangsan-gu, Gwangju, South Korea, 506-731
 IC Applicant : LG Innotek Co., Ltd.
 IC Address : 26, Hanamsandan 5beon-ro, Gwangsan-gu, Gwangju, Korea (Republic Of), 506-731
 Contact Person : Jeong, In-chang
 Phone No. : +82 62 950 0332

1.3. Details of Manufacturer

Company : LG Innotek Co., Ltd.
 Address : 30, Magokjungang 10-ro, Gangseo-gu, Seoul, Korea, 07796

1.4. Description of EUT

Kind of Product	BT/WIFI Combo Module
Model Name	ATC5CPL004
Variant Model Names	-
Serial Number	Conducted: C-001 Radiated: N-001
Power Supply	DC 3.3 V
Frequency Range	2 402 MHz ~ 2 480 MHz (Bluetooth)
Modulation Technique	GFSK, $\pi/4$ DQPSK, 8DPSK
Number of Channels	79 channels (Bluetooth)
Antenna Type	Pattern Antenna
Antenna Gain[*]	2.28 dB i
H/W Version	1.0
S/W Version	1.0
FVIN	N/A

1.5. Information about the FHSS characteristics:

1.5.1. Pseudorandom Frequency Hopping Sequence

The channel is represented by a pseudo-random hopping sequence hopping through the 79 RF channels. The hopping sequence is unique for the piconet and is determined by the Bluetooth device address of the master; the phase in the hopping sequence is determined by the Bluetooth clock of the master. The channel is divided into time slots where each slot corresponds to an RF hop frequency. Consecutive hops correspond to different RF hop frequencies. The nominal hop rate is 1 600 hops/s.

1.5.2. Equal Hopping Frequency Use

The channels of this system will be used equally over the long-term distribution of the hopsets.

1.5.3. Example of a 79 hopping sequence in data mode:

02, 05, 31, 24, 20, 10, 43, 36, 30, 23, 40, 06, 21, 50, 44, 09, 71, 78, 01, 13, 73, 07, 70, 72, 35, 62, 42, 11, 41, 08, 16, 29, 60, 15, 34, 61, 58, 04, 67, 12, 22, 53, 57, 18, 27, 76, 39, 32, 17, 77, 52, 33, 56, 46, 37, 47, 64, 49, 45, 38, 69, 14, 51, 26, 79, 19, 28, 65, 75, 54, 48, 03, 25, 66, 05, 16, 68, 74, 59, 63, 55

1.5.4. System Receiver Input Bandwidth

Each channel bandwidth is 1 MHz.

The system receivers have input bandwidths that match the hopping channel bandwidths of their corresponding transmitters and shift frequencies in synchronization with the transmitted signals.

1.5.5. Equipment Description

15.247(a) (1) that the Rx input bandwidths shift frequencies in synchronization with the transmitted signals.

15.247(g): In accordance with the Bluetooth Industry Standard, the system is designed to comply with all of the regulations in Section 15.247 when the transmitter is presented with a continuous data (or information) system.

15.247(h): In accordance with the Bluetooth Industry Standard, the system does not coordinate its channels selection/ hopping sequence with other frequency hopping systems for the express purpose of avoiding the simultaneous occupancy of individual hopping frequencies by multiple transmitters.

1.6. Test Equipment List

Equipment	Manufacturer	Model	S/N	Cal. Date	Cal. Interval	Cal. Due
Signal Generator	R&S	SMA100B	106887	Oct. 13, 2022	Annual	Oct. 13, 2023
Signal Generator	R&S	SMBV100A	255834	May 25, 2022	Annual	May 25, 2023
Spectrum Analyzer	R&S	FSV30	103210	Dec. 07, 2022	Annual	Dec. 07, 2023
Spectrum Analyzer	Agilent	N9020A	MY53421758	Aug. 26, 2022	Annual	Aug. 26, 2023
Bluetooth Tester	TESCOM	TC-3000C	3000C000560	Sep. 14, 2022	Annual	Sep. 14, 2023
Directional Coupler	KRYTAR	152613	122660	Jul. 06, 2022	Annual	Jul. 06, 2023
BRIDGE COUPLER	MARKI MICROWAVE INC	CBR16-0012	1542	May 06, 2022	Annual	May 06, 2023
High Pass Filter	Wainwright Instrument GmbH	WHKX3.0/18G-6SS	21	Jun. 09, 2022	Annual	Jun. 09, 2023
High Pass Filter	Wainwright Instrument GmbH	WHNX7.5/26.5G-6SS	15	May 31, 2022	Annual	May 31, 2023
Low Pass Filter	Mini-Circuits	NLP-1200+	V 8979400903-2	Feb. 09, 2023	Annual	Feb. 09, 2024
Power Sensor	R&S	NRP-Z81	100669	May 06, 2022	Annual	May 06, 2023
DC Power Supply	Agilent	U8002A	MY54110041	Sep. 15, 2022	Annual	Sep. 15, 2023
Preamplifier	H.P.	8447F	2944A03909	Aug. 04, 2022	Annual	Aug. 04, 2023
Signal Conditioning Unit	R&S	SCU-18	10117	Jun. 13, 2022	Annual	Jun. 13, 2023
Preamplifier	TESTEK	TK-PA1840H	130016	Jan. 11, 2023	Annual	Jan. 11, 2024
Loop Antenna	Schwarzbeck Mess- Elektronik	FMZB 1519	1519-039	Aug. 23, 2021	Biennial	Aug. 23, 2023
Bilog Antenna	Schwarzbeck Mess- Elektronik	VULB 9163	01126	Feb. 09, 2023	Annual	Feb. 09, 2024
Horn Antenna	R&S	HF906	100326	Feb. 28, 2023	Annual	Feb. 28, 2024
Horn Antenna	Schwarzbeck Mess- Elektronik	BBHA 9170	9170-540	Nov. 30, 2022	Annual	Nov. 30, 2023
EMI Test Receiver	R&S	ESU26	100109	Jan. 18, 2023	Annual	Jan. 18, 2024
Turn Table	Innco systems GmbH	DS 1200 S	N/A	N.C.R.	N/A	N.C.R.
Controller	Innco systems GmbH	CONTROLLER CO3000- 4P	CO3000/963/383 30516/L	N.C.R.	N/A	N.C.R.
Antenna Mast	Innco systems GmbH	MA4640-XP-ET	MA4640/536/383 30516/L	N.C.R.	N/A	N.C.R.
Anechoic Chamber	SY Corporation	L x W x H (9.6 m x 6.4 m x 6.6 m)	N/A	N.C.R.	N/A	N.C.R.
Coaxial Cable	RFONE	MWX221-NMSNMS (4 m)	J1023142	Apr. 04, 2023	Semi- Annual	Oct. 04, 2023
Coaxial Cable	Qualwave Inc.	QA500-18-NN-10 (10 m)	22200114	Apr. 04, 2023	Semi- Annual	Oct. 04, 2023
Coaxial Cable	RADIALL	TESTPRO 3	182287	Feb. 18, 2023	Semi- Annual	Aug. 18, 2023
Coaxial Cable	RADIALL	TESTPRO 3	182288	Feb. 18, 2023	Semi- Annual	Aug. 18, 2023
Coaxial Cable	RADIALL	TESTPRO 3	182291	Feb. 18, 2023	Semi- Annual	Aug. 18, 2023
Test Receiver	R&S	ESCI 7	100911	Feb. 24, 2023	Annual	Feb. 24, 2024
Two-Line V-Network	R&S	ENV216	100190	May 13, 2022	Annual	May 13, 2023
Shield Room	SY Corporation	L x W x H (6.5 m x 3.5 m x 3.5 m)	N/A	N.C.R.	N/A	N.C.R.

1.7. Declaration by the Manufacturer

- Adaptive Frequency Hopping is supported and use at least 20 channels.
- Bluetooth and Bluetooth Low Energy transmit only on Core 0.

1.8. Summary of Test Results

The EUT has been tested according to the following specifications:

APPLIED STANDARD: FCC Part15 Subpart C, IC RSS-247 Issue 2 and RSS-Gen Issue 5			
Section in FCC	Section in IC	Test Item(s)	Result
15.205(a) 15.209 15.247(d)	RSS-247 Issue 2 5.5 RSS-Gen Issue 5 8.9	Transmitter Radiated Spurious Emissions and Conducted Spurious Emission	Complied
15.247(a)(1)	RSS-247 Issue 2 5.1(b) RSS-Gen Issue 5 6.7	20 dB Bandwidth and 99 % Bandwidth	Complied
15.247(a)(1) 15.247(b)(1)	RSS-247 Issue 2 5.1(b) 5.4(b)	Maximum Peak Conducted Output Power	Complied
15.247(a)(1)	RSS-247 Issue 2 5.1(b)	Carrier Frequency Separation	Complied
15.247(a)(1)(iii)	RSS-247 Issue 2 5.1(d)	Number of Hopping Frequencies	Complied
15.247(a)(1)(iii)	RSS-247 Issue 2 5.1(d)	Time of Occupancy (Dwell Time)	Complied
15.207	RSS-Gen Issue 5 8.8	AC Power Line Conducted Emission	Complied

1.9. Test Procedure(s)

The measurement procedures described in the American National Standard of Procedure for Compliance Testing of unlicensed Wireless Devices (ANSI C63.10-2013) and the guidance provided in KDB 558074 D01 15.247 Meas Guidance v05r02 were used in the measurement of the DUT.

1.10. Sample Calculation

Where relevant, the following sample calculation is provided:

1.10.1. Conducted Test

Offset value (dB) = Directional coupler (dB) + Cable loss (dB)

1.10.2. Radiation Test

Field strength level (dB μ V/m) = Measured level (dB μ V) + Antenna factor (dB/m) + Cable loss (dB) - Amplifier gain (dB)
 + Duty factor (dB)

1.11. Information of software for test

- Using the software of Broadcom Bluetool (Version 1.9.5.3) to testing of EUT.

1.12. Measurement Uncertainty

Where relevant, the following measurement uncertainty levels have been estimated for tests performed on the apparatus:

Parameter	Uncertainty	
Maximum Peak Conducted Output Power	0.33 dB	
99 % Bandwidth	6.89 kHz	
20 dB Bandwidth	6.79 kHz	
Conducted Spurious Emission	0.87 dB	
Time of Occupancy	0.02 ms	
AC Power Line Conducted Emission	4.00 dB	
Radiated Emission, 9 kHz to 30 MHz	H	3.40 dB
	V	3.40 dB
Radiated Emission, below 1 GHz	H	4.50 dB
	V	5.10 dB
Radiated Emission, above 1 GHz	H	3.70 dB
	V	3.90 dB

All measurement uncertainty values are shown with a coverage factor $k = 2$ to indicate a 95 % level of confidence.

1.13. Test Report Revision

Revision	Report Number	Date of Issue	Description
0	F690501-RF-RTL004003	2023.04.24	Initial

1.14. Device Capabilities

Frequency	Mode	SISO		MIMO
		Core 0	Core 1	Core 0 + Core 1
2.4 GHz	Bluetooth & Bluetooth Low Energy	O	X	X
	802.11b/g/n	X	O	X
5 GHz	802.11a	O	O	X
	802.11n/ac	O	O	O

1.15. Descriptions of Test Mode

Preliminary tests were performed in different data rates and recorded the RF output power in the following table:

Mode	Data Rate (Mbps)	Channel	Frequency (MHz)	RF Peak Output Power (dB m)
GFSK	1	Low	2 402	<u>-1.42</u>
		Middle	2 441	-1.68
		High	2 480	-2.09
$\pi/4$ DQPSK	2	Low	2 402	1.64
		Middle	2 441	1.54
		High	2 480	0.95
8DPSK	3	Low	2 402	<u>2.21</u>
		Middle	2 441	1.85
		High	2 480	1.18

Note;

1. For transmitter radiated spurious emissions, conducted spurious emission, carrier frequency separation and number of hopping frequencies, GFSK / DH5 and 8DPSK / 3DH5 are tested as worst condition.
2. For 20 dB bandwidth and maximum peak conducted output power, GFSK / DH5, $\pi/4$ DQPSK / 2DH5 and 8DPSK / 3DH5 are tested as worst condition.
3. For Time of Occupancy, GFSK / DH1, DH3, DH5 and 8DPSK / 3DH1, 3DH3, 3DH5 are tested as worst condition.

1.16. Duty Cycle Correction Factor of EUT

According to KDB 558074 D01 15.247 Meas Guidance v05r02, 9, as a “duty cycle correction factor”, pulse averaging with 20 log (worst case dwell time / 100 ms) has to be used for average result.

DH5 on time (One Pulse) Plot on Channel 39

DH5 on time (Count Pulses) Plot on Channel 39

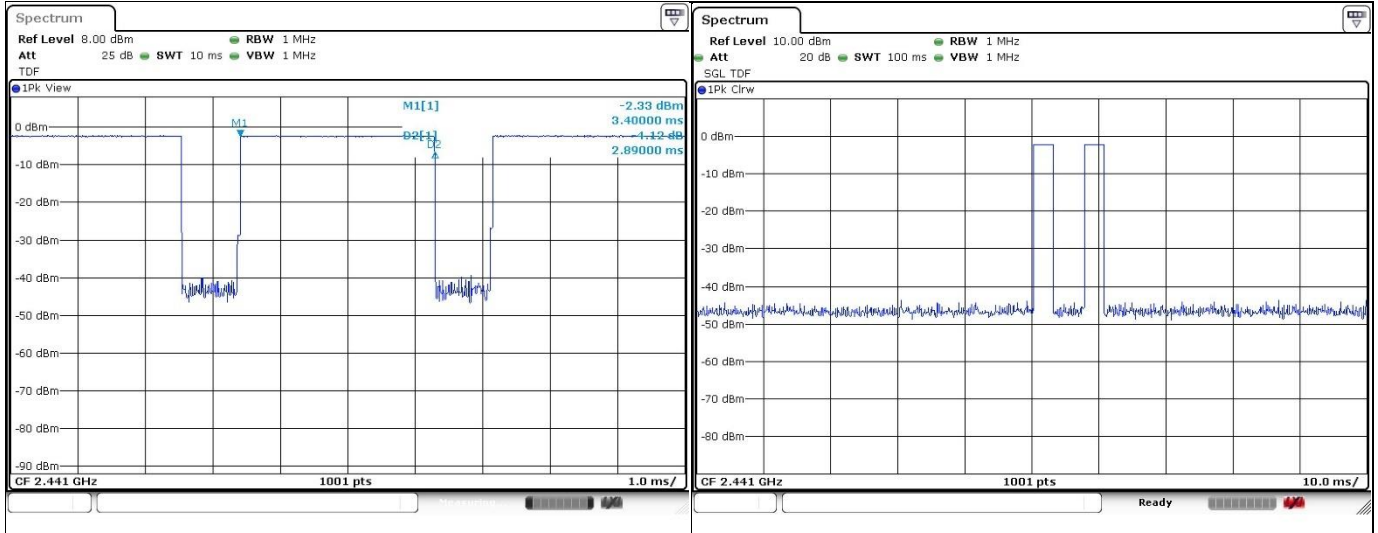

In AFH mode, the minimum hopping frequencies are 20, to get the longest dwell time DH5 packet is observed;
 the period to have DH5 packet completing one hopping sequence is $2.89 \text{ ms} \times 20 \text{ channels} = 57.80 \text{ ms}$

There cannot be 2 complete hopping sequences within 100 ms period, considering the random hopping behavior, maximum 2 hops can be possibly observed within the period. $[100 \text{ ms} / 57.80 \text{ ms}] = 2 \text{ hops}$

Thus, the maximum possible ON time:

$$2.89 \text{ ms} \times 2 = 5.78 \text{ ms}$$

Worst case Duty Cycle Correction factor, which is derived from the maximum possible ON time:

$$20 \times \log (5.78 \text{ ms} / 100 \text{ ms}) = -24.76 \text{ dB}$$

2. Transmitter Radiated Spurious Emissions and Conducted Spurious Emissions

2.1. Test Setup

2.1.1. Transmitter Radiated Spurious Emissions

The diagram below shows the test setup that is utilized to make the measurements for emission from 9 kHz to 30 MHz.

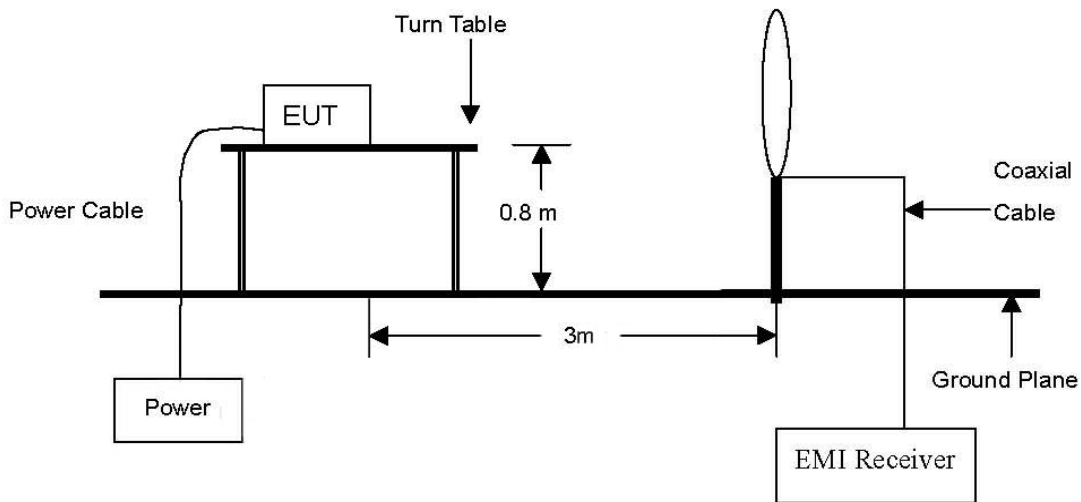

The diagram below shows the test setup that is utilized to make the measurements for emission from 30 MHz to 1 GHz.

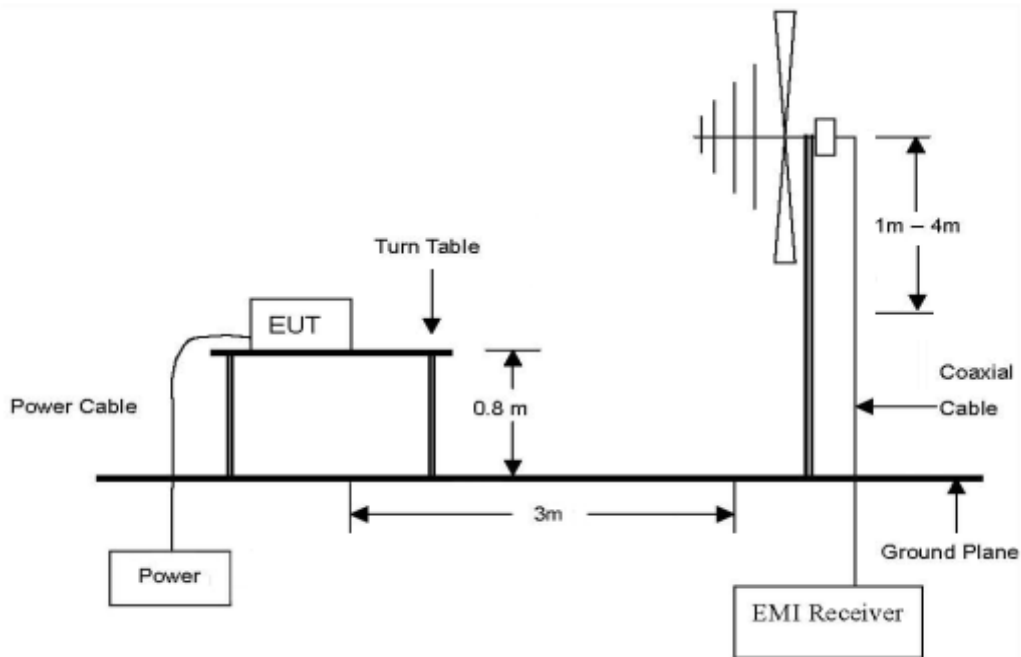

The diagram below shows the test setup that is utilized to make the measurements for emission. The spurious emissions were investigated from 1 GHz to the 10th harmonic of the highest fundamental frequency or 40 GHz, whichever is lower.

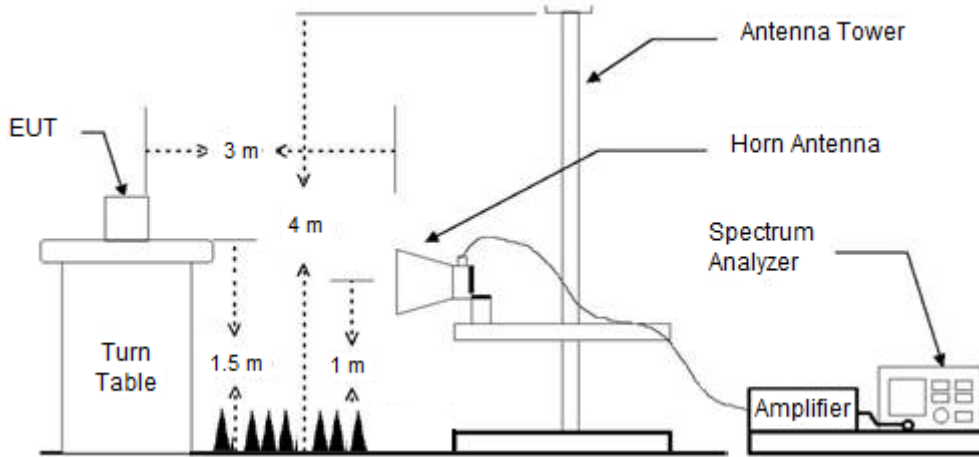

2.1.2. Conducted Spurious Emissions

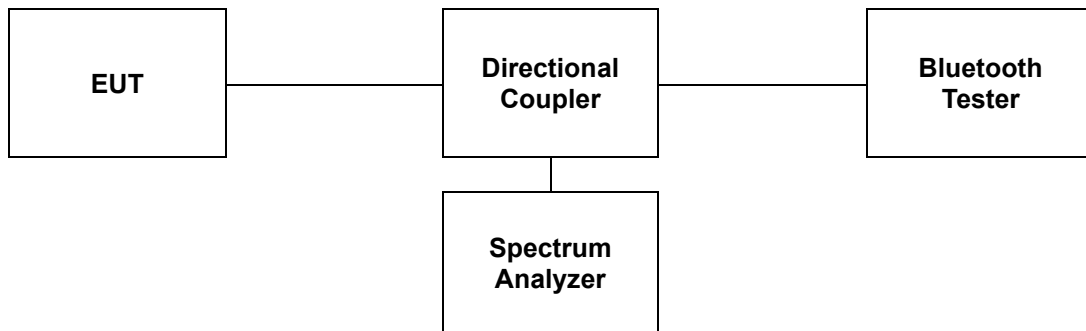

2.2. Limit

2.2.1. FCC

According to §15.247(d), in any 100 kHz bandwidth outside the frequency band in which the spread spectrum or digitally modulated intentional radiator is operating, the radio frequency power that is produced by the intentional radiator shall be at least 20 dB below that in the 100 kHz bandwidth within the band that contains the highest level of the desired power, based on either an RF conducted or a radiated measurement, provided the transmitter demonstrates compliance with the peak conducted power limits. If the transmitter complies with the conducted power limits based on the use of RMS averaging over a time interval, as permitted under paragraph (b)(3) of this section, the attenuation required under this paragraph shall be 30 dB instead of 20 dB. Attenuation below the general limits specified in §15.209(a) is not required. In addition, radiated emission which fall in the restricted bands, as defined in §15.205(a), must also comply with the radiated emission limits specified in §15.209(a) (see §15.205(c)).

According to §15.209(a), except as provided elsewhere in this subpart, the emissions from an intentional radiator shall not exceed the field strength levels specified in the following table:

Frequency (MHz)	Field Strength ($\mu\text{V}/\text{m}$)	Measurement Distance (Meters)
0.009-0.490	$2\ 400/F(\text{kHz})$	300
0.490-1.705	$24\ 000/F(\text{kHz})$	30
1.705-30.0	30	30
30-88	100**	3
88-216	150**	3
216-960	200**	3
Above 960	500	3

** Except as provided in paragraph (g), fundamental emissions from intentional radiators operating under this section shall not be located in the frequency bands 54-72 MHz, 76-88 MHz, 174-216 MHz or 470-806 MHz. However, operation within these frequency bands is permitted under other sections of this part, e.g., §§15.231 and 15.241.

2.2.2. IC

According to RSS-247 Issue 2, 5.5, in any 100 kHz bandwidth outside the frequency band in which the spread spectrum or digitally modulated device is operating, the RF power that is produced shall be at least 20 dB below that in the 100 kHz bandwidth within the band that contains the highest level of the desired power, based on either an RF conducted or a radiated measurement, provided that the transmitter demonstrates compliance with the peak conducted power limits. If the transmitter complies with the conducted power limits based on the use of root-mean-square averaging over a time interval, as permitted under section 5.4(d), the attenuation required shall be 30 dB instead of 20 dB. Attenuation below the general field strength limits specified in RSS-Gen is not required.

According to RSS-Gen Issue 5, 8.9, except where otherwise indicated in the applicable RSS, radiated emissions shall comply with the field strength limits shown in table 5 and table 6. Additionally, the level of any transmitter unwanted emission shall not exceed the level of the transmitter's fundamental emission.

Table 5 – General Field Strength Limits at frequencies above 30 MHz

Frequency (MHz)	Field Strength ($\mu\text{V}/\text{m}$ at 3 m)
30-88	100
88-216	150
216-960	200
Above 960	500

Table 6 – General Field Strength Limits at frequencies below 30 MHz

Frequency	Magnetic Field Strength (H-Field) ($\mu\text{A}/\text{m}$)	Measurement Distance (meters)
9-490 kHz ¹	6.37/F (F in kHz)	300
490-1 705 kHz	63.7/F (F in kHz)	30
1.705-30 MHz	0.08	30

Note¹: The emission limits for the ranges 9-90 kHz and 110-490 kHz are based on measurements employing a linear average detector.

2.3. Test Procedures

Radiated emissions from the EUT were measured according to the dictates of ANSI C63.10-2013 and only the radiated emissions of the configuration that produced the worst case emissions are reported in this section.

2.3.1. Test Procedures for emission below 30 MHz

1. The EUT was placed on the top of a rotating table 0.8 meters above the ground at a 3 meter anechoic chamber test site. The table was rotated 360 degrees to determine the position of the highest radiation.
2. Then antenna is a loop antenna is fixed at one meter above the ground to determine the maximum value of the field strength. Both parallel and perpendicular of the antenna are set to make the measurement.
3. For each suspected emission, the EUT was arranged to its worst case and then the table was turned from 0 degrees to 360 degrees to find the maximum reading.
4. The test-receiver system was set to average or quasi peak detect function and Specified Bandwidth with Maximum Hold Mode.

2.3.2. Test Procedures for emission from above 30 MHz

1. The EUT was placed on the top of a rotating table 0.8 meters above the ground at a 3 meter anechoic chamber test site below 1 GHz and 1.5 meter above the ground at a 3 meter anechoic chamber test site above 1 GHz. The table was rotated 360 degrees to determine the position of the highest radiation.
2. During performing radiated emission below 1 GHz, the EUT was set 3 meters away from the interference receiving antenna, which was mounted on the top of a variable-height antenna tower. During performing radiated emission above 1 GHz, the EUT was set 3 meter away from the interference-receiving antenna.
3. The antenna is a bi-log antenna, a horn antenna and its height is varied from one meter to four meters above the ground to determine the maximum value of the field strength. Both horizontal and vertical polarizations of the antenna are set to make the measurement.
4. For each suspected emission, the EUT was arranged to its worst case and then the antenna was tuned to heights from 1 meter to 4 meters and the table was turned from 0 degrees to 360 degrees to find the maximum reading.
5. For measurements below 1 GHz resolution bandwidth is set to 100 kHz for peak detection measurements or 120 kHz for quasi-peak detection measurements. Peak detection is used unless otherwise noted as quasi-peak.
6. For measurements Above 1 GHz resolution bandwidth is set to 1 MHz, the video bandwidth is set to 3 MHz for peak measurements and as applicable for average measurements.

2.3.3. Definition of EUT Axis.

The test orthogonal plan of EUT was investigated with three axis described in the test setup photo. All radiated testing of EUT was performed with Y-axis as worst case.

2.3.4. Test Procedures for Conducted Spurious Emissions

2.3.4.1. Band-edge Compliance of RF Conducted Emissions

The transmitter output was connected to the spectrum analyzer.

Span = wide enough to capture the peak level of the emission operating on the channel closest to the band edge, as well as any modulation products which fall outside of the authorized band of operation.

RBW \geq 100 kHz

VBW = 300 kHz

Sweep = auto

Detector function = peak

Trace = max hold

2.3.4.2. Spurious RF Conducted Emissions

The transmitter output was connected to the spectrum analyzer.

RBW = 1 MHz

VBW = 3 MHz

Sweep = auto

Detector function = peak

Trace = max hold

2.3.4.3. TDF function

- For plots showing conducted spurious emissions from 9 kHz to 25 GHz, all path loss of wide frequency range was investigated and compensated to spectrum analyzer as TDF function.

So, the reading values shown in plots were final result.

2.4. Test Results

Ambient temperature : (23 ± 1) °C
 Relative humidity : 47 % R.H.

2.4.1. Radiated Spurious Emission below 1 000 MHz

The frequency spectrum from 9 kHz to 1 000 MHz was investigated. All reading values are peak values.

Radiated Emissions			Ant.	Correction Factors		Total	Limit	
Frequency (MHz)	Reading (dB μ V)	Detect Mode	Pol.	AF (dB/m)	AMP + CL (dB)	Actual (dB μ V/m)	Limit (dB μ V/m)	Margin (dB)
62.50	35.70	Peak	V	17.65	-27.14	26.21	40.00	13.79
111.88	39.50	Peak	V	17.10	-26.76	29.84	43.50	13.66
119.28	39.70	Peak	V	15.64	-26.69	28.65	43.50	14.85
166.49	40.60	Peak	V	14.60	-26.44	28.76	43.50	14.74
253.22	37.80	Peak	H	18.60	-25.69	30.71	46.00	15.29
327.02	36.40	Peak	V	19.75	-25.31	30.84	46.00	15.16
Above 400.00	Not detected	-	-	-	-	-	-	-

Remark;

- Spurious emissions for all channels and modes were investigated and almost the same below 1 GHz.
- Test from 30 MHz to 1 000 MHz was performed using the software of EP5RE(V5.3.70) from TOYO.
- Reported spurious emissions are in **EDR / 3DH5 / Low channel** as worst case among other modes.
- Radiated spurious emission measurement as below.
 (Actual = Reading + AF + AMP + CL)
- According to §15.31(o), emission levels are not report much lower than the limits by over 20 dB.

- Test plot

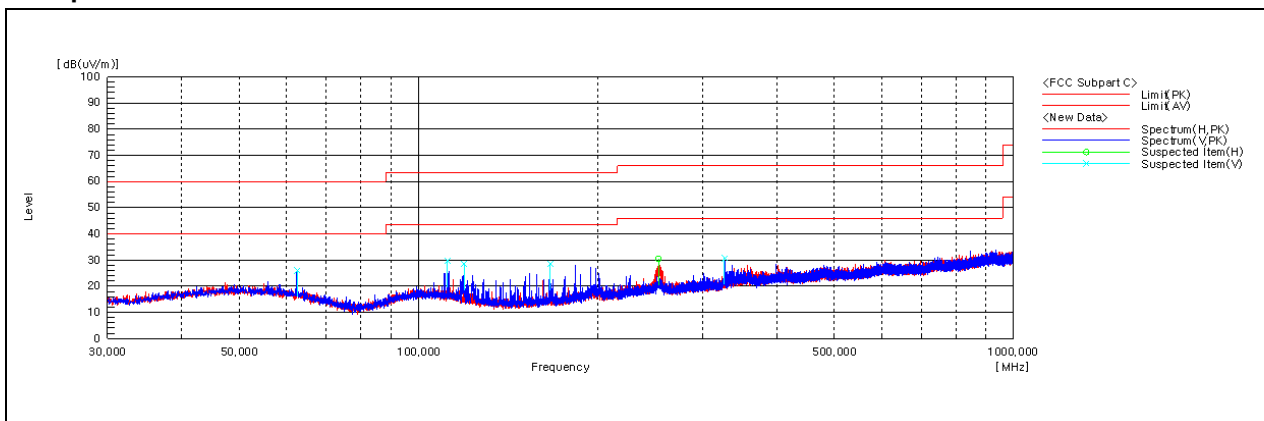

2.4.2. Radiated Spurious Emission above 1 000 MHz

The frequency spectrum above 1 000 MHz was investigated. All reading values are peak values.

Operating Mode: GFSK

A. Low Channel (2 402 MHz)

Radiated Emissions			Ant.	Correction Factors			Total	Limit	
Frequency (MHz)	Reading (dB μ V)	Detect Mode	Pol.	AF (dB/m)	CL (dB)	DF (dB)	Actual (dB μ V/m)	Limit (dB μ V/m)	Margin (dB)
*2 310.00	24.42	Peak	V	28.04	5.99	-	58.45	74.00	15.55
*2 310.00	24.42	Average	V	-	-	-24.76	33.69	54.00	20.31
*2 373.82	27.18	Peak	V	28.25	6.18	-	61.61	74.00	12.39
*2 373.82	27.18	Average	V	-	-	-24.76	36.85	54.00	17.15
*2 390.00	25.27	Peak	V	28.28	6.20	-	59.75	74.00	14.25
*2 390.00	25.27	Average	V	-	-	-24.76	34.99	54.00	19.01

Radiated Emissions			Ant.	Correction Factors			Total	Limit	
Frequency (MHz)	Reading (dB μ V)	Detect Mode	Pol.	AF (dB/m)	AMP+CL (dB)	DF (dB)	Actual (dB μ V/m)	Limit (dB μ V/m)	Margin (dB)
Above 1 000.00	Not detected	-	-	-	-	-	-	-	-

B. Middle Channel (2 441 MHz)

Radiated Emissions			Ant.	Correction Factors			Total	Limit	
Frequency (MHz)	Reading (dB μ V)	Detect Mode	Pol.	AF (dB/m)	AMP+CL (dB)	DF (dB)	Actual (dB μ V/m)	Limit (dB μ V/m)	Margin (dB)
Above 1 000.00	Not detected	-	-	-	-	-	-	-	-

C. High Channel (2 480 MHz)

Radiated Emissions			Ant.	Correction Factors			Total	Limit	
Frequency (MHz)	Reading (dB μ V)	Detect Mode	Pol.	AF (dB/m)	CL (dB)	DF (dB)	Actual (dB μ V/m)	Limit (dB μ V/m)	Margin (dB)
*2 483.50	25.49	Peak	V	28.27	6.40	-	60.16	74.00	13.84
*2 483.50	25.49	Average	V	-	-	-24.76	35.40	54.00	18.60
*2 484.95	26.61	Peak	V	28.27	6.38	-	61.26	74.00	12.74
*2 484.95	26.61	Average	V	-	-	-24.76	36.50	54.00	17.50
*2 500.00	25.12	Peak	V	28.30	6.19	-	59.61	74.00	14.39
*2 500.00	25.12	Average	V	-	-	-24.76	34.85	54.00	19.15

Radiated Emissions			Ant.	Correction Factors			Total	Limit	
Frequency (MHz)	Reading (dB μ V)	Detect Mode	Pol.	AF (dB/m)	AMP+CL (dB)	DF (dB)	Actual (dB μ V/m)	Limit (dB μ V/m)	Margin (dB)
Above 1 000.00	Not detected	-	-	-	-	-	-	-	-

Operating Mode: 8DPSK

A. Low Channel (2 402 MHz)

Radiated Emissions			Ant.	Correction Factors			Total	Limit	
Frequency (MHz)	Reading (dB μ V)	Detect Mode	Pol.	AF (dB/m)	CL (dB)	DF (dB)	Actual (dB μ V/m)	Limit (dB μ V/m)	Margin (dB)
*2 310.00	24.52	Peak	V	28.04	5.99	-	58.55	74.00	15.45
*2 310.00	24.52	Average	V	-	-	-24.76	33.79	54.00	20.21
*2 366.78	26.47	Peak	V	28.23	6.26	-	60.96	74.00	13.04
*2 366.78	26.47	Average	V	-	-	-24.76	36.20	54.00	17.80
*2 390.00	26.07	Peak	V	28.28	6.20	-	60.55	74.00	13.45
*2 390.00	26.07	Average	V	-	-	-24.76	35.79	54.00	18.21

Radiated Emissions			Ant.	Correction Factors			Total	Limit	
Frequency (MHz)	Reading (dB μ V)	Detect Mode	Pol.	AF (dB/m)	AMP+CL (dB)	DF (dB)	Actual (dB μ V/m)	Limit (dB μ V/m)	Margin (dB)
Above 1 000.00	Not detected	-	-	-	-	-	-	-	-

B. Middle Channel (2 441 MHz)

Radiated Emissions			Ant.	Correction Factors			Total	Limit	
Frequency (MHz)	Reading (dB μ V)	Detect Mode	Pol.	AF (dB/m)	AMP+CL (dB)	DF (dB)	Actual (dB μ V/m)	Limit (dB μ V/m)	Margin (dB)
Above 1 000.00	Not detected	-	-	-	-	-	-	-	-

C. High Channel (2 480 MHz)

Radiated Emissions			Ant.	Correction Factors			Total	Limit	
Frequency (MHz)	Reading (dBμV)	Detect Mode	Pol.	AF (dB/m)	CL (dB)	DF (dB)	Actual (dBμV/m)	Limit (dBμV/m)	Margin (dB)
*2 483.50	25.48	Peak	V	28.27	6.40	-	60.15	74.00	13.85
*2 483.50	25.48	Average	V	-	-	-24.76	35.39	54.00	18.61
*2 494.75	27.53	Peak	V	28.29	6.26	-	62.08	74.00	11.92
*2 494.75	27.53	Average	V	-	-	-24.76	37.32	54.00	16.68
*2 500.00	25.49	Peak	V	28.30	6.19	-	59.98	74.00	14.02
*2 500.00	25.49	Average	V	-	-	-24.76	35.22	54.00	18.78

Radiated Emissions			Ant.	Correction Factors			Total	Limit	
Frequency (MHz)	Reading (dBμV)	Detect Mode	Pol.	AF (dB/m)	AMP+CL (dB)	DF (dB)	Actual (dBμV/m)	Limit (dBμV/m)	Margin (dB)
Above 1 000.00	Not detected	-	-	-	-	-	-	-	-

Remark;

1. "*" means the restricted band.
2. Measuring frequencies from 1 GHz to the 10th harmonic of highest fundamental frequency.
3. Radiated emissions measured in frequency above 1 000 MHz were made with an instrument using peak/average detector mode.
4. Actual = Reading + AF + CL + (DF) or Reading + AF + AMP + CL + (DF).
5. According to § 15.31(o), emission levels are not reported much lower than the limits by over 20 dB.
6. The maximized peak measured value complies with the average limit, to perform an average measurement is unnecessary.
7. AF = Antenna Factor, CL = Cable Loss, DF = Duty Correction Factor.

- Test plots

Mode: GFSK

Low channel band edge (Peak)

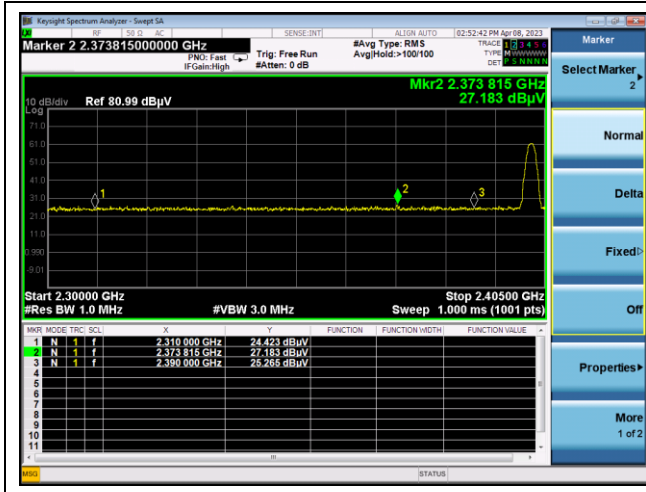

High channel band edge (Peak)

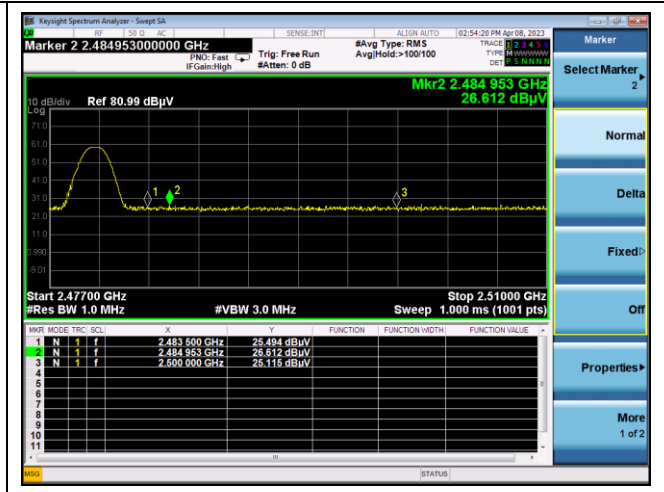

Mode: 8DPSK

Low channel band edge (Peak)

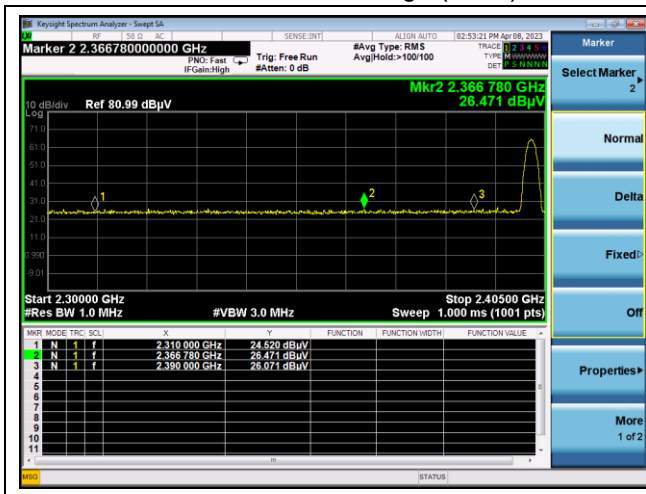

High channel band edge (Peak)

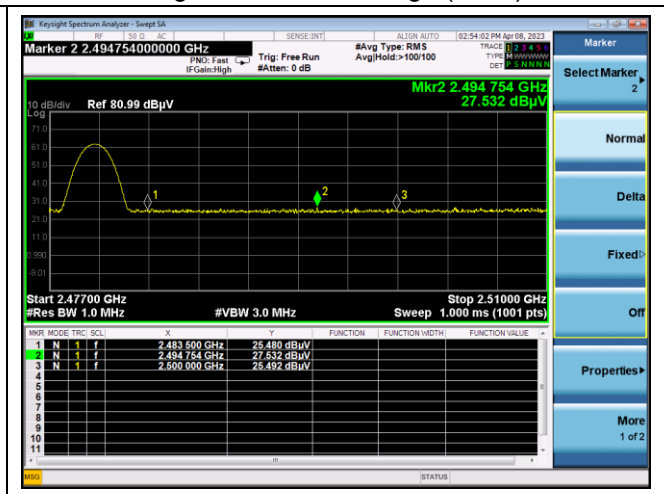

2.4.3. Plot of Conducted Spurious Emissions

Mode: GFSK_hopping function turned off

Low Channel

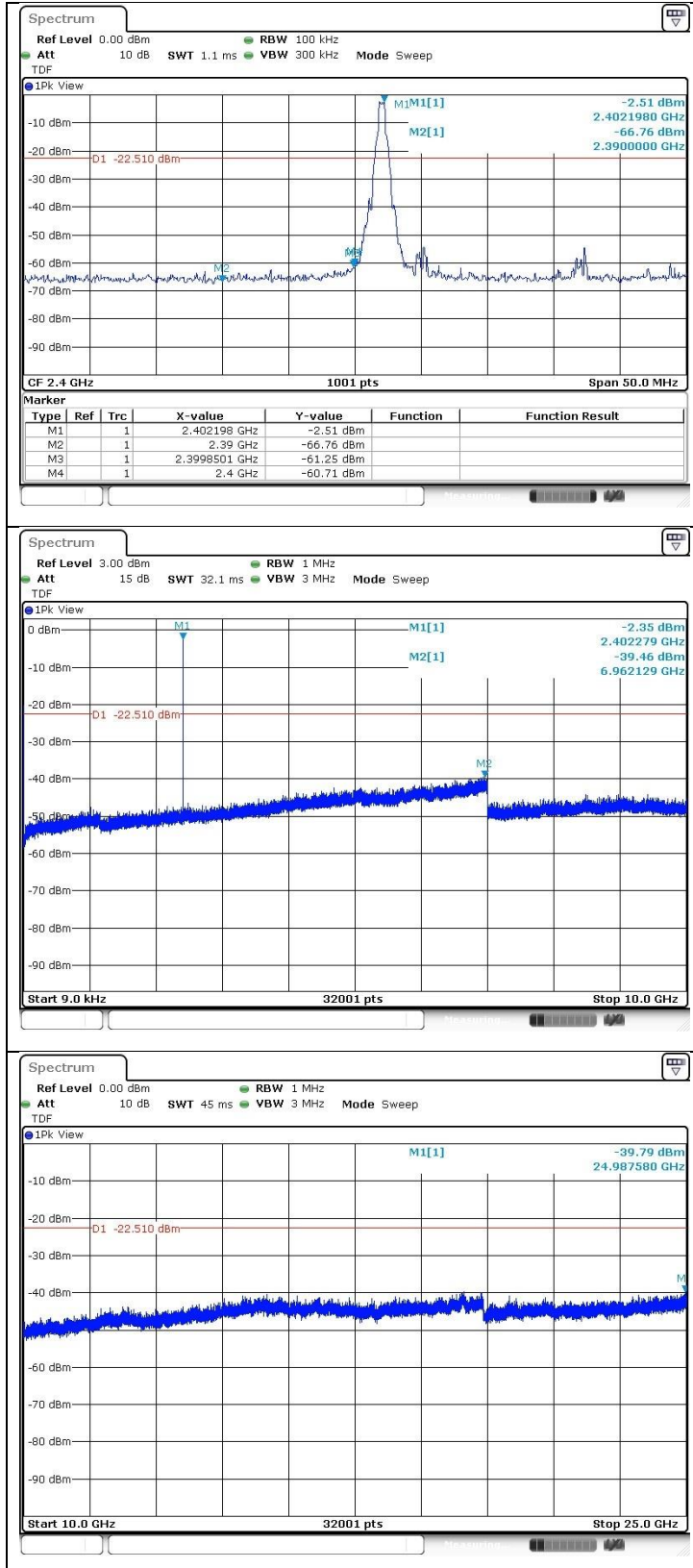

Middle Channel

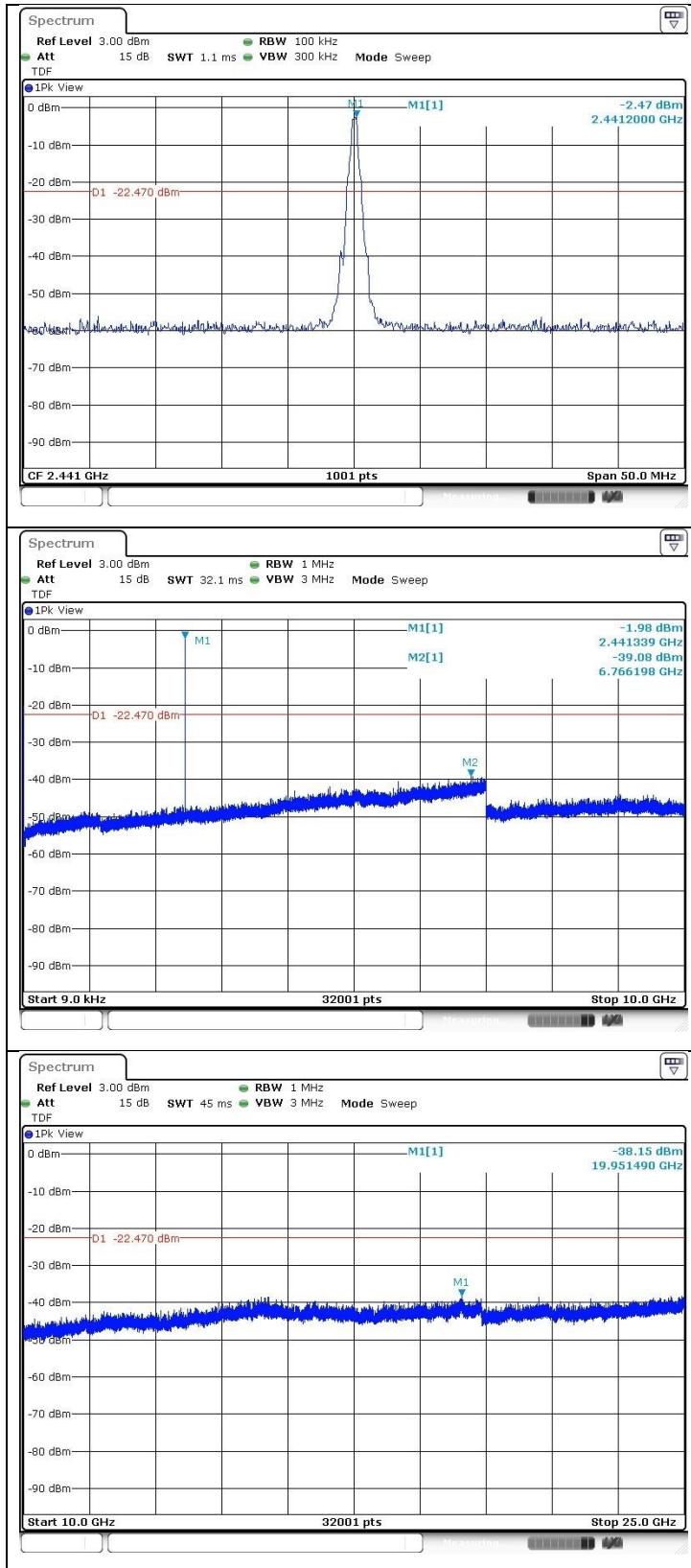

High Channel

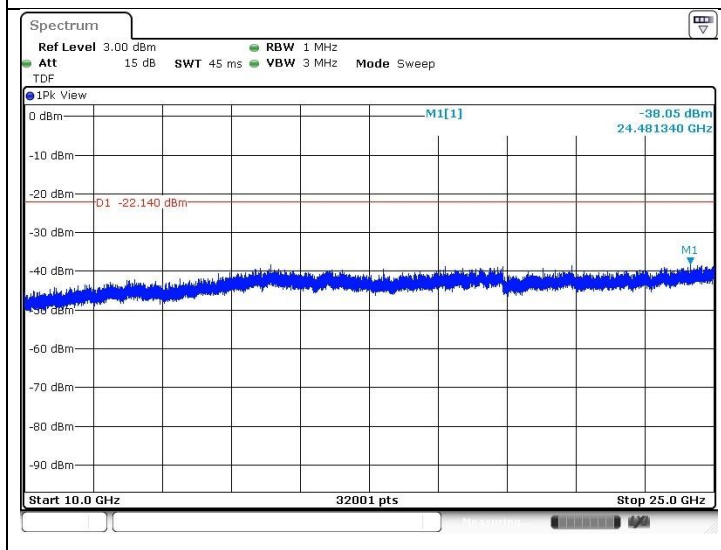
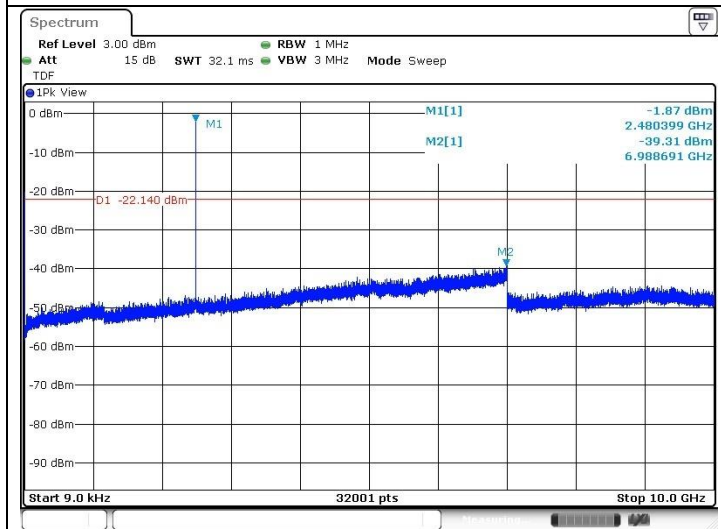
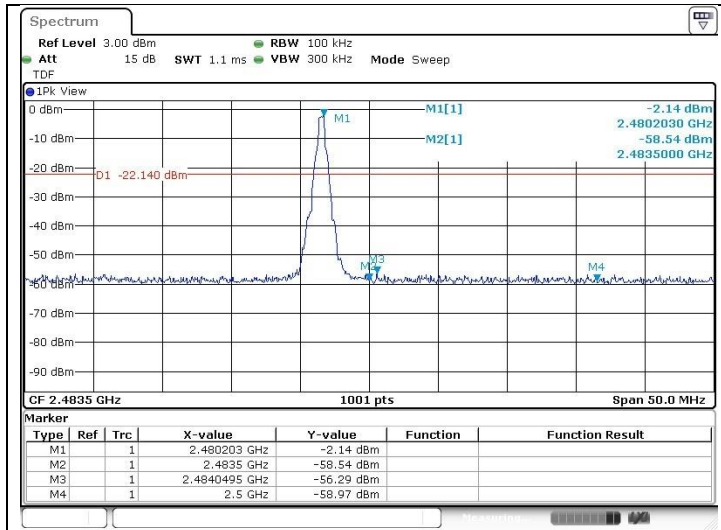

Mode: GFSK_hopping function turned on

Band edge compliance

Low Channel

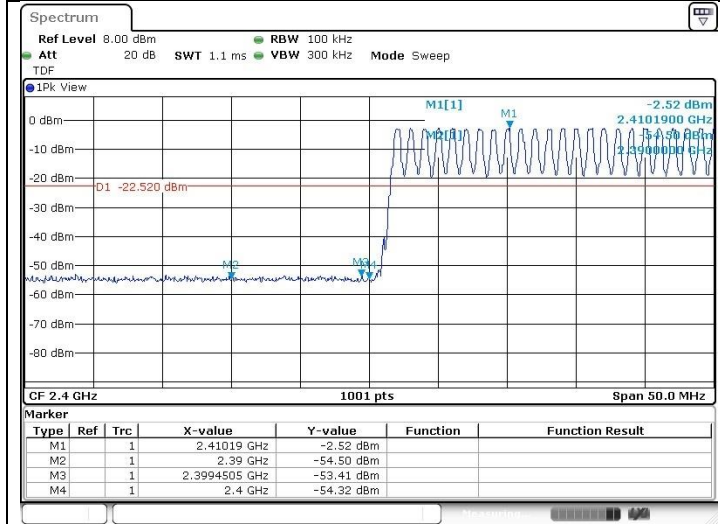

High Channel

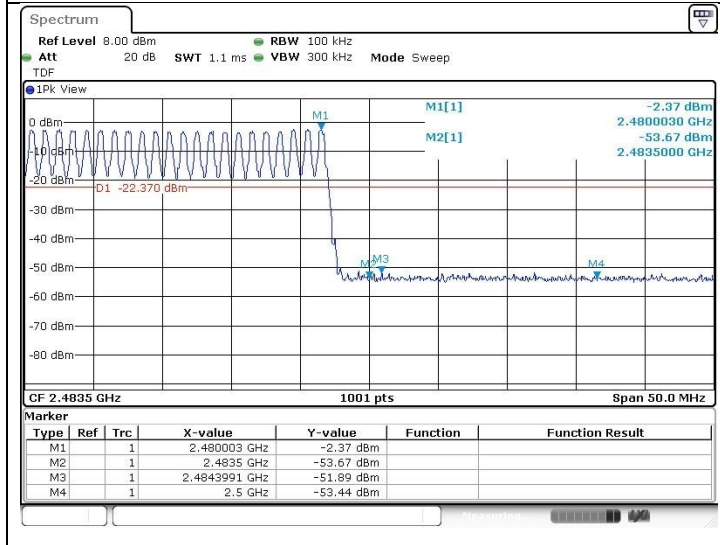

Mode: 8DPSK_hopping function turned off

Low channel

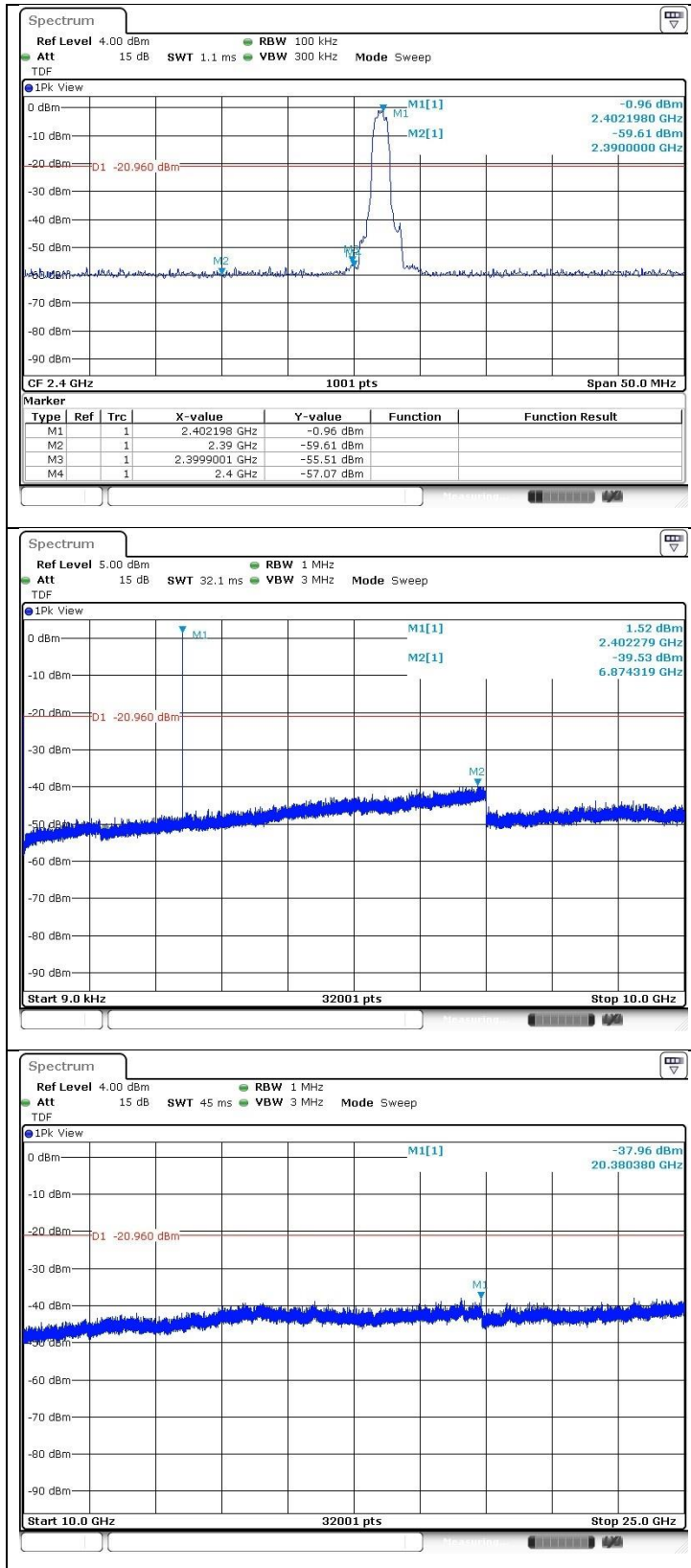

Middle channel

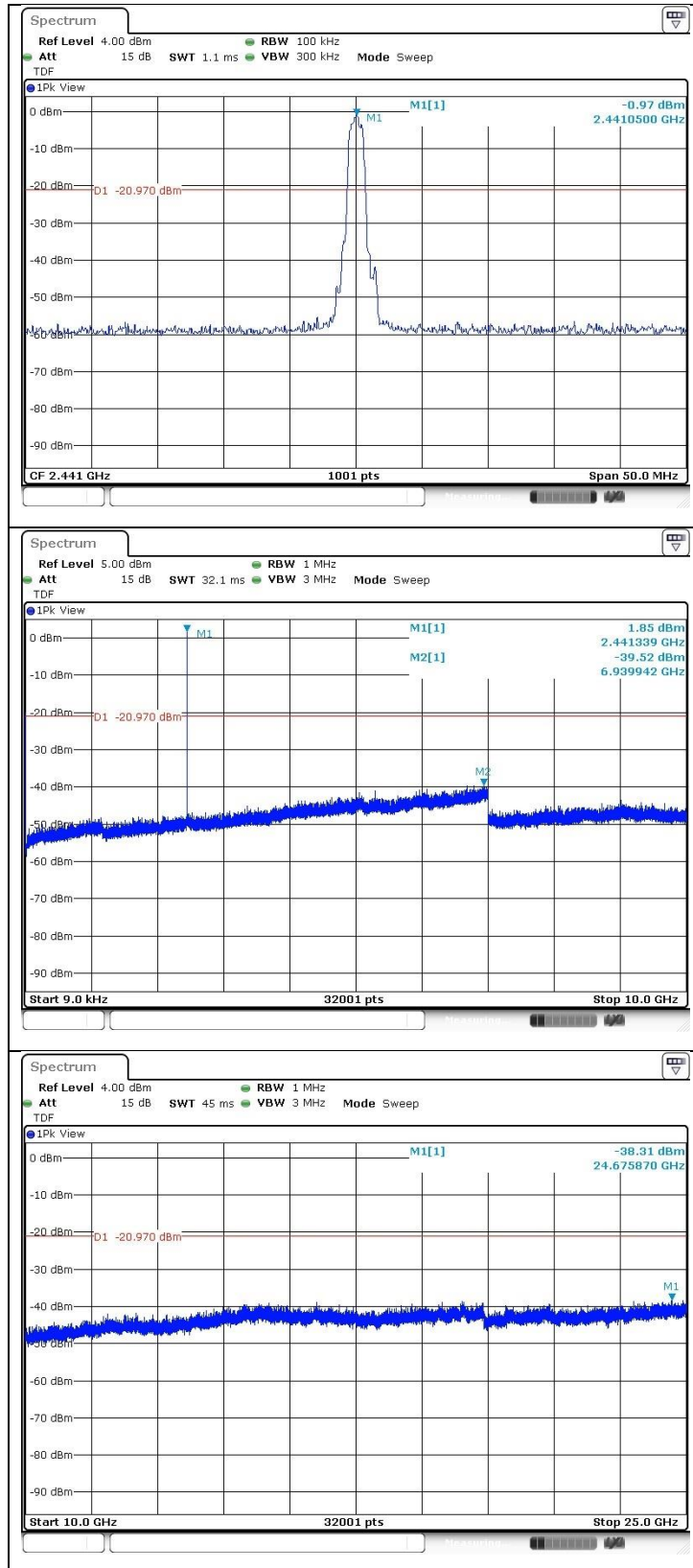

High channel

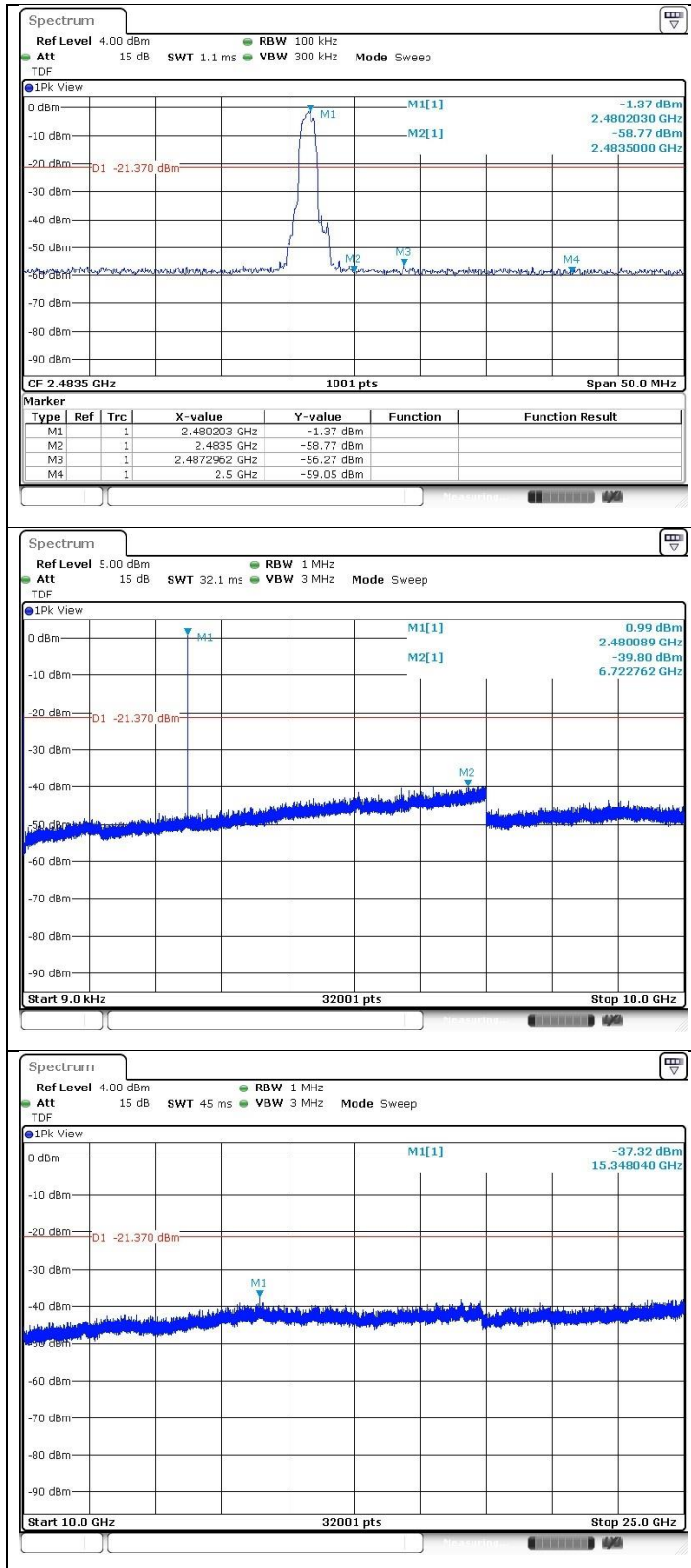

Mode: 8DPSK_hopping function turned on

Band edge compliance

Low channel

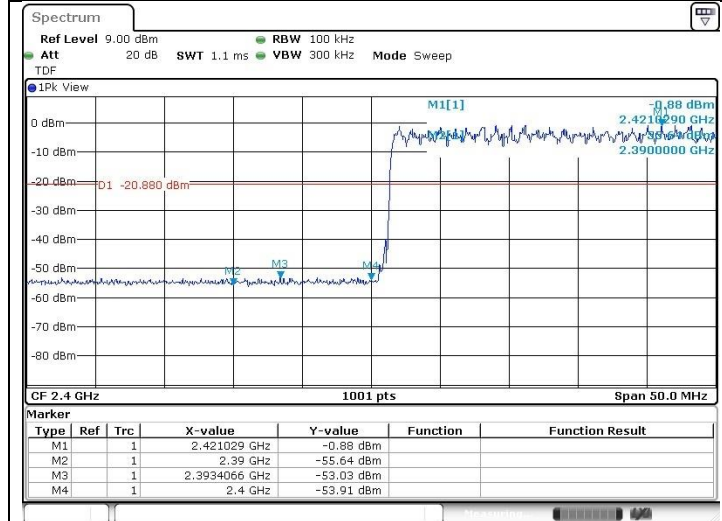

High channel

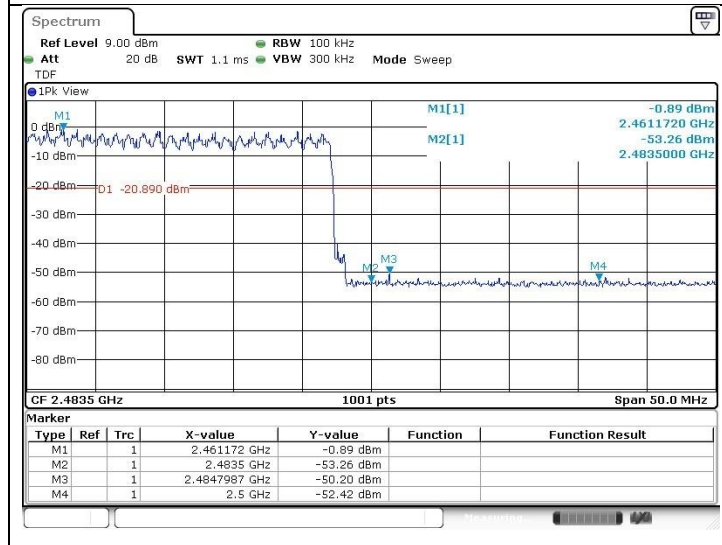

3. 20 dB Bandwidth and 99 % Bandwidth

3.1. Test Setup

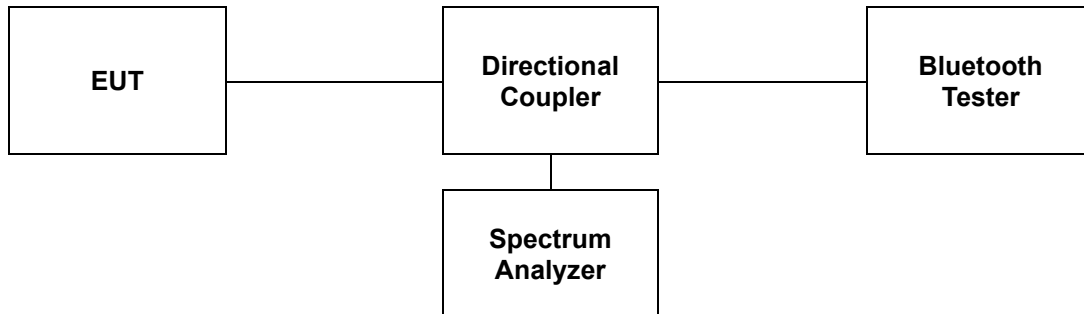

3.2. Limit

Limit: Not Applicable

3.3. Test Procedure

3.3.1. 20 dB Bandwidth

The test follows ANSI C63.10-2013.

The 20 dB bandwidth was measured with a spectrum analyzer connected to RF antenna connector (conducted measurement) while EUT was operating in transmit mode at the appropriate center frequency.

Use the following spectrum analyzer setting:

1. Span = approximately 2 to 5 times the 20 dB bandwidth.
2. RBW \geq 1 % to 5 % of the 20 dB bandwidth.
3. VBW \geq 3 x RBW
4. Sweep = auto
5. Detector = peak
6. Trace = max hold

The marker-to-peak function to set the mark to the peak of the emission. Use the marker-delta function to measure 20 dB down one side of the emission. Reset the function and move the marker to the other side of the emission, until it is (as close as possible to) even with the reference marker level. The marker-delta reading at this point is 20 dB bandwidth of the emission.

3.3.2. 99 % Bandwidth

- The span of the spectrum analyzer shall be set large enough to capture all products of the modulation process, including the emission skirts, around the carrier frequency, but small enough to avoid having other emissions (e.g. on adjacent channels) within the span.
- The detector of the spectrum analyzer shall be set to "Sample". However, a peak, or peak hold, may be used in place of the sampling detector since this usually produces a wider bandwidth than the actual bandwidth (worst-case measurement). Use of a peak hold (or "Max Hold") may be necessary to determine the occupied / x dB bandwidth if the device is not transmitting continuously.
- The resolution bandwidth (RBW) shall be in the range of 1 % to 5 % of the actual occupied / x dB bandwidth and the video bandwidth (VBW) shall not be smaller than three times the RBW value. Video averaging is not permitted.

Note: It may be necessary to repeat the measurement a few times until the RBW and VBW are in compliance with the above requirement.

For the 99 % emission bandwidth, the trace data points are recovered and directly summed in linear power level terms. The recovered amplitude data points, beginning at the lowest frequency, are placed in a running sum until 0.5 % of the total is reached, and that frequency recorded. The process is repeated for the highest frequency data points (starting at the highest frequency, at the right side of the span, and going down in frequency). This frequency is then recorded. The difference between the two recorded frequencies is the occupied bandwidth (or the 99 % emission bandwidth).

3.4. Test Results

Ambient temperature : (23 ± 1) °C
 Relative humidity : 47 % R.H.

Mode	Data Rate (Mbps)	Channel	Frequency (MHz)	20 dB Bandwidth (MHz)	99 % Bandwidth (MHz)
GFSK	1	Low	2 402	1.037	0.944
		Middle	2 441	1.052	0.965
		High	2 480	1.049	0.965
π/4DQPSK	2	Low	2 402	1.349	1.199
		Middle	2 441	1.364	1.208
		High	2 480	1.361	1.208
8DPSK	3	Low	2 402	1.316	1.199
		Middle	2 441	1.346	1.208
		High	2 480	1.346	1.208

- Test plots

20 dB Bandwidth

Mode: GFSK

Low Channel



Middle Channel

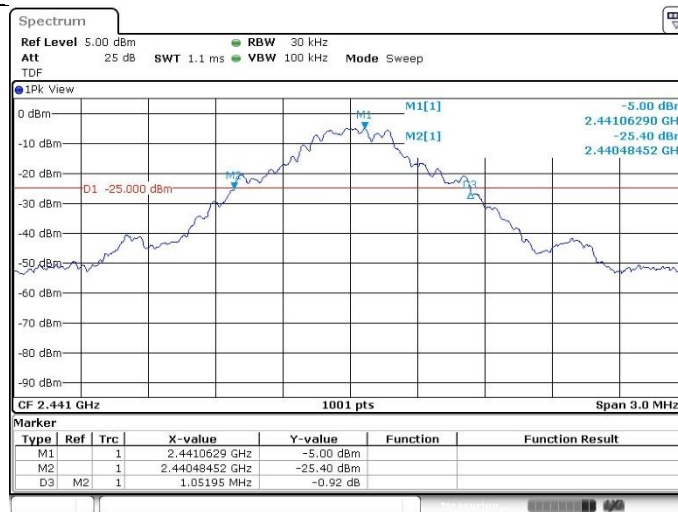

High Channel

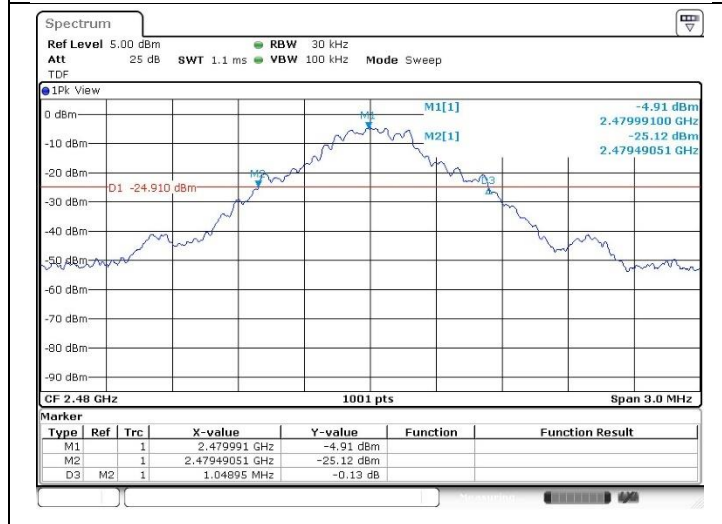

Mode: $\pi/4$ QPSK

Low Channel

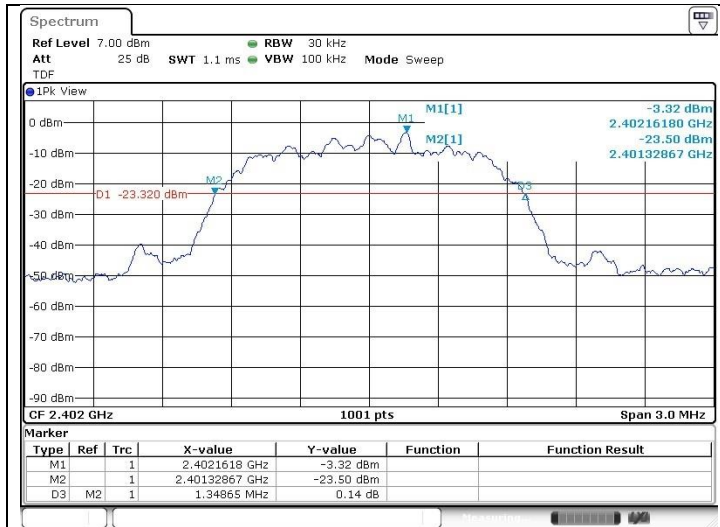

Middle Channel

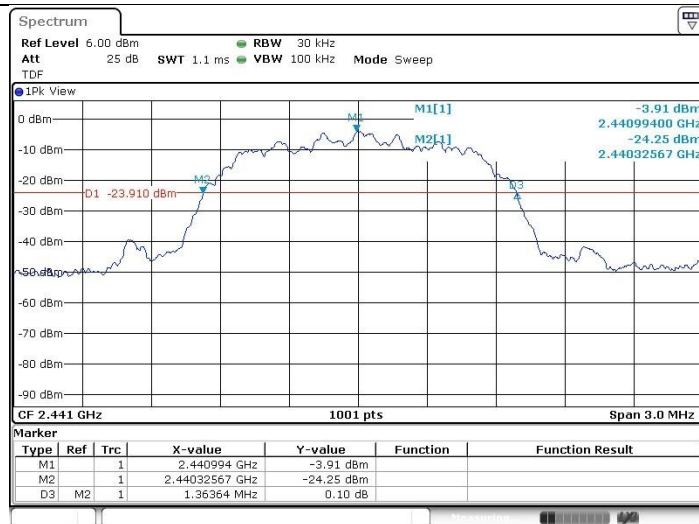

High Channel

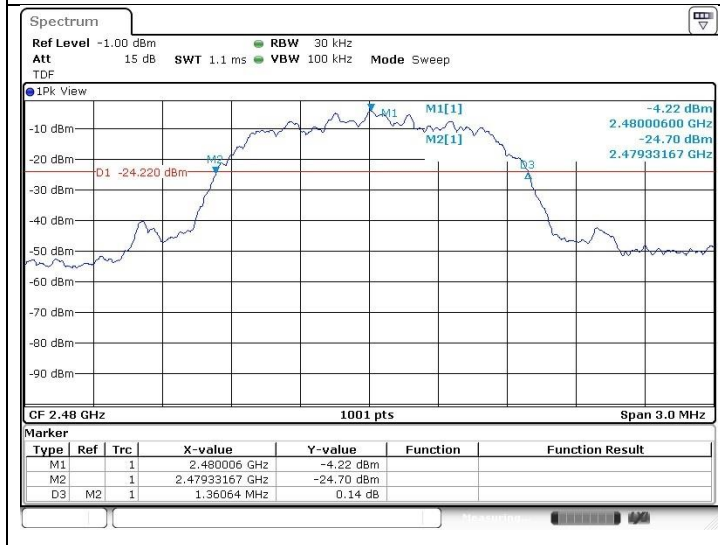

Mode: 8DPSK

Low Channel

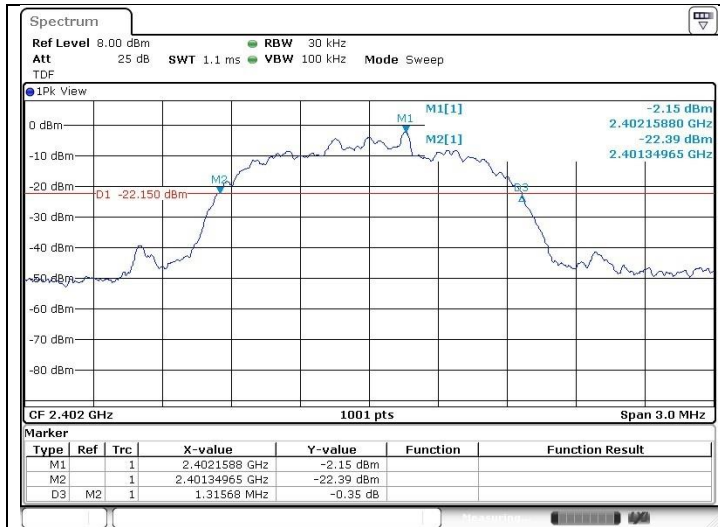

Middle Channel

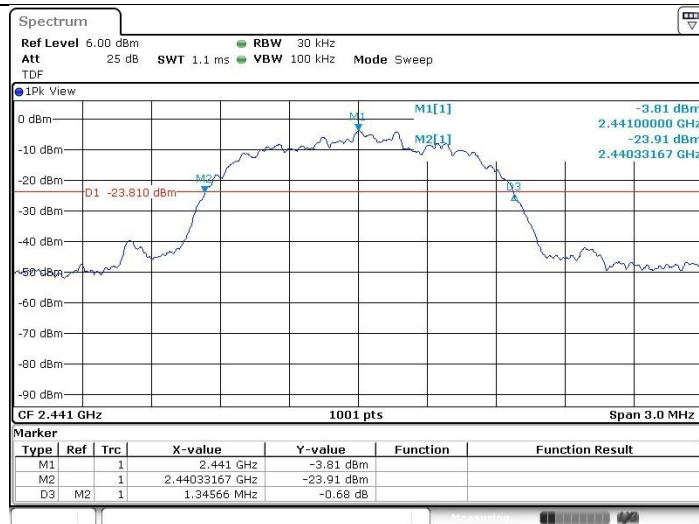

High Channel

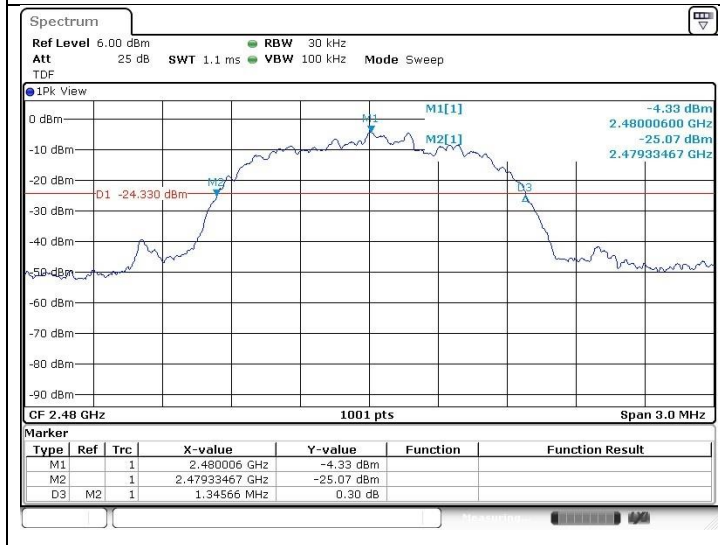

99 % Bandwidth

Mode: GFSK

Low Channel



Middle Channel

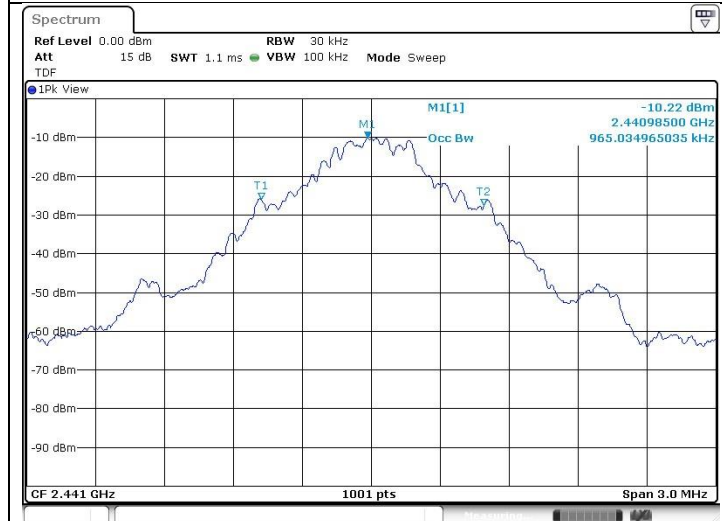

High Channel

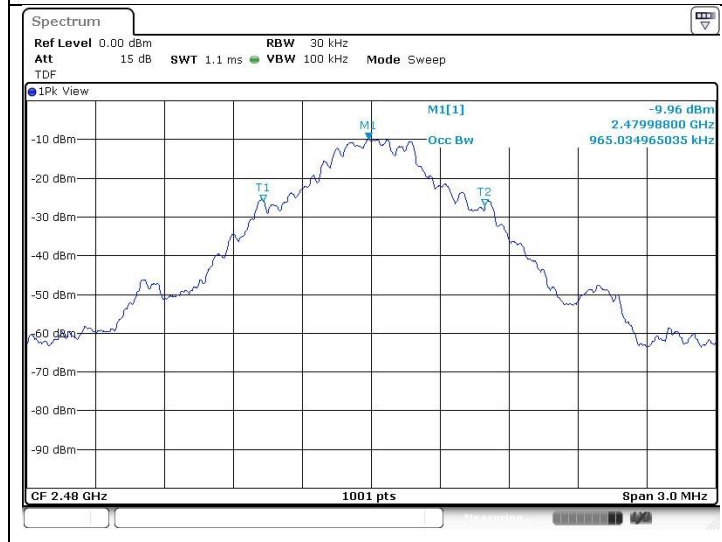

Mode: $\pi/4$ DQPSK

Low Channel

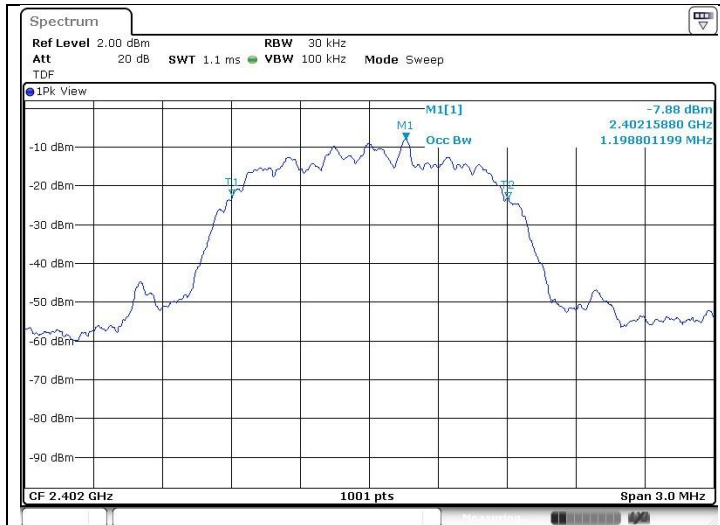

Middle Channel

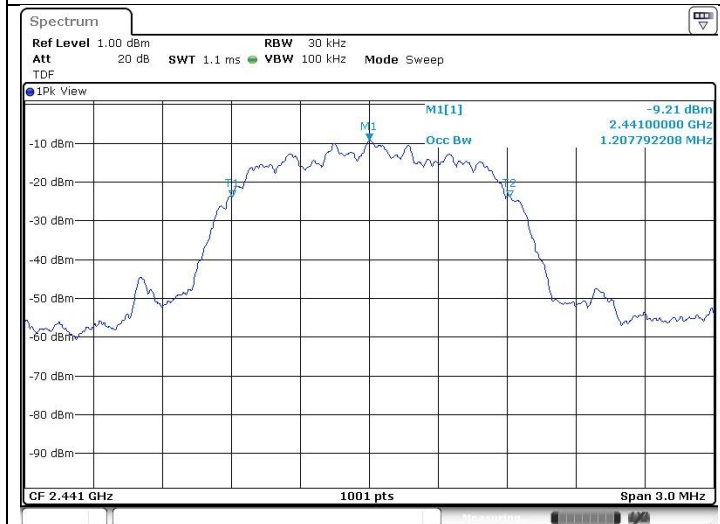

High Channel

