



FCC ID: YZKSMCWBR14SN5

FCC PART 15C TEST REPORT FOR CERTIFICATION
On Behalf of

Edgecore Networks Corporation

150 Mbps 4-port Wireless Broadband Router

Model No.: SMCWBR14S-N5

FCC ID: YZKSMCWBR14SN5

Prepared for : Edgecore Networks Corporation
No.1 Creation Rd.3, Hsinchu Science Park, Hsinchu,
30077, Taiwan, R.O.C

Prepared By : Audix Technology (Shenzhen) Co., Ltd.
No. 6, Ke Feng Rd., 52 Block,
Shenzhen Science & Industrial Park,
Nantou, Shenzhen, Guangdong, China

Tel: (0755) 26639496

Report Number : ACS-F11140
Date of Test : Jun.27~Jul.08, 2011
Date of Report : Jul.12, 2011

TABLE OF CONTENTS

| Description | Page |
|-----------------------------------------------------------------------|------------|
| 1. SUMMARY OF STANDARDS AND RESULTS..... | 1-1 |
| 1.1. Description of Standards and Results | 1-1 |
| 2. GENERAL INFORMATION | 2-1 |
| 2.1. Description of Device (EUT) | 2-1 |
| 2.2. Test Information..... | 2-2 |
| 2.3. Tested Supporting System Details | 2-3 |
| 2.4. Block diagram of connection between the EUT and simulators | 2-3 |
| 2.5. Test Facility | 2-4 |
| 2.6. Measurement Uncertainty (95% confidence levels, k=2) | 2-4 |
| 3. POWER LINE CONDUCTED EMISSION TEST | 3-1 |
| 3.1. Test Equipments..... | 3-1 |
| 3.2. Block Diagram of Test Setup..... | 3-1 |
| 3.3. Power Line Conducted Emission Test Limits..... | 3-1 |
| 3.4. Configuration of EUT on Test | 3-2 |
| 3.5. Operating Condition of EUT..... | 3-2 |
| 3.6. Test Procedure..... | 3-2 |
| 3.7. Power Line Conducted Emission Test Results | 3-2 |
| 4. RADIATED EMISSION TEST | 4-1 |
| 4.1. Test Equipment | 4-1 |
| 4.2. Block Diagram of Test Setup..... | 4-1 |
| 4.3. Radiated Emission Limit..... | 4-2 |
| 4.4. EUT Configuration on Test..... | 4-3 |
| 4.5. Operating Condition of EUT..... | 4-3 |
| 4.6. Test Procedure..... | 4-3 |
| 4.7. Radiated Emission Test Results | 4-4 |
| 5. CONDUCTED SPURIOUS EMISSIONS..... | 5-1 |
| 5.1. Test Equipment | 5-1 |
| 5.2. Limit..... | 5-1 |
| 5.3. Test Procedure..... | 5-1 |
| 5.4. Test result..... | 5-1 |
| 6. BAND EDGE COMPLIANCE TEST | 6-1 |
| 6.1. Test Equipment | 6-1 |
| 6.2. Limit..... | 6-1 |
| 6.3. Test Produce | 6-1 |
| 6.4. Test Results | 6-1 |
| 7. 6dB Bandwidth Test..... | 7-1 |
| 7.1. Test Equipment | 7-1 |
| 7.2. Limit..... | 7-1 |
| 7.3. Test Procedure..... | 7-1 |
| 7.4. Test Results | 7-1 |
| 8. OUTPUT POWER TEST..... | 8-1 |
| 8.1. Test Equipment | 8-1 |
| 8.2. Limit (FCC Part 15C 15.247 b(3))..... | 8-1 |
| 8.3. Test Procedure..... | 8-1 |
| 8.4. Test Results | 8-2 |
| 9. POWER SPECTRAL DENSITY TEST | 9-1 |
| 9.1. Test Equipment | 9-1 |

| | | |
|------------|------------------------------------------------------------|-------------|
| 9.2. | Limit..... | 9-1 |
| 9.3. | Test Procedure..... | 9-1 |
| 9.4. | Test Results | 9-2 |
| 10. | ANTENNA REQUIREMENT | 10-1 |
| 10.1. | STANDARD APPLICABLE..... | 10-1 |
| 10.2. | ANTENNA CONNECTED CONSTRUCTION | 10-1 |
| 11. | MPE ESTIMATION..... | 11-1 |
| 11.1. | Limit for General Population/ Uncontrolled Exposures | 11-1 |
| 11.2. | 2, Estimation Result | 11-1 |
| 12. | DEVIATION TO TEST SPECIFICATIONS..... | 12-1 |
| 13. | PHOTOGRAPH OF TEST | 13-1 |
| 13.1. | Photos of Power Line Conducted Emission Test | 13-1 |
| 13.2. | Photos of Radiated Emission Test..... | 13-2 |
| 14. | PHOTOS OF THE EUT..... | 14-1 |

TEST REPORT CERTIFICATION

Applicant : Edgecore Networks Corporation
Manufacturer : Edgecore Networks Corporation
EUT Description : 150 Mbps 4-port Wireless Broadband Router
FCC ID : YZKSMCWBR14SN5
(A) MODEL NO. : SMCWBR14S-N5
(B) SERIAL NO. : N/A
(C) POWER SUPPLY : DC 9V
(D) TEST VOLTAGE : DC 9V From Adapter input AC 120V/60Hz

Tested for comply with:
FCC Rules and Regulations Part 15 Subpart C: 2008

Test procedure used:
ANSI C63.10:2009

The device described above is tested by AUDIX TECHNOLOGY (SHENZHEN) CO., LTD. to confirm comply with all the FCC Part 15 Subpart C requirements.

The test results are contained in this test report and AUDIX TECHNOLOGY (SHENZHEN) CO., LTD. is assumed full responsibility for the accuracy and completeness of these tests. Also, this report shows that the Equipment Under Test (EUT) is to be technically compliant with the FCC and IC requirements. This report contains data that are not covered by the NVLAP accreditation.

This Report is made under FCC Part 2.1075. No modifications were required during testing to bring this product into compliance.

This report applies to above tested sample only. This report shall not be reproduced in part without written approval of AUDIX TECHNOLOGY (SHENZHEN) CO., LTD.

The report must not be used by the client to claim product certification, approval, or endorsement by NVLAP, NIST, or any agency of the federal government.

Date of Test : Jun.27-Jul.08, 2011 Report of date: Jul.12, 2011

Prepared by : Sala Yang / Senior Assistant
Reviewed by : Sunny Lu / Senior Assistant

Audix Technology (Shenzhen) Co., Ltd.
EMC 部門報告專用章
Stamp only for EMC Dept. Report
Signature: Ken Lu 7/4/11

Approved & Authorized Signer : Ken Lu / Manager

1. SUMMARY OF STANDARDS AND RESULTS

1.1. Description of Standards and Results

The EUT have been tested according to the applicable standards as referenced below.

| EMISSION | | |
|-------------------------------|------------------------------------------|---------|
| Description of Test Item | Standard | Results |
| Power Line Conducted Emission | FCC Part 15: 15.207 ANSI C63.10: 2009 | PASS |
| Radiated Emission | FCC Part 15: 15.209 ANSI C63.10: 2009 | PASS |
| Band Edge Compliance | FCC Part 15: 15.247 ANSI C63.10: 2009 | PASS |
| Conducted spurious emissions | FCC Part 15: 15.247 ANSI C63.10: 2009 | PASS |
| 6dB Bandwidth | FCC Part 15: 15.247 ANSI C63.10: 2009 | PASS |
| Peak Output Power | FCC Part 15: 15.247 ANSI C63.10: 2009 | PASS |
| Power Spectral Density | FCC Part 15: 15.247 ANSI C63.10: 2009 | PASS |
| Antenna requirement | FCC Part 15: 15.203 | PASS |

2. GENERAL INFORMATION

2.1. Description of Device (EUT)

| | | |
|-----------------------|---|-------------------------------------------------------------------------------------------------------------------------------------------------------------|
| Product Name | : | 150 Mbps 4-port Wireless Broadband Router |
| Model Number | : | SMCWBR14S-N5 |
| FCC ID | : | YZKSMCWBR14SN5 |
| Operation Frequency | : | IEEE 802.11b: 2412MHz—2462MHz IEEE 802.11g: 2412MHz—2462MHz IEEE802.11n HT20: 2412MHz—2462MHz IEEE802.11n HT40: 2422MHz—2452MHz |
| Channel Number | : | IEEE 802.11b/g, IEEE 802.11n HT20: 11 Channels IEEE 802.11n HT40: 7Channels |
| Modulation Technology | : | IEEE 802.11b: DSSS(CCK,DQPSK,DBPSK) IEEE 802.11g: OFDM(64QAM, 16QAM, QPSK, BPSK) IEEE 802.11n HT20, HT40: OFDM (64QAM, 16QAM, QPSK,BPSK) |
| Antenna Assembly Gain | : | One Dipole Antenna, One integrated PCB antenna, SIMO 1Tx2R, 5dBi Peak gain for dipole antenna Note: The integrated PCB antenna only used for receive. |
| Applicant | : | Edgecore Networks Corporation No.1 Creation Rd.3, Hsinchu Science Park, Hsinchu, 30077, Taiwan, R.O.C |
| Manufacturer | : | Edgecore Networks Corporation No.1 Creation Rd.3, Hsinchu Science Park, Hsinchu, 30077, Taiwan, R.O.C |
| Adapter | : | Manufacture: VASATA M/N: P090060-2B1 Unshielded, Undetachable,1.6m |
| Date of Test | : | Jun.27~Jul.08, 2011 |
| Date of Receipt | : | Jun.26, 2011 |
| Sample Type | : | Prototype production |

2.2. Test Information

A special test software was used to control EUT work in Continuous TX mode(100% duty cycle), and select test channel, wireless mode and data rate.

| Tested mode, channel, and data rate information | | | |
|-------------------------------------------------|-------------------------------|-------------|--------------------|
| Mode | data rate (Mbps)(see Note) | Channel | Frequency (MHz) |
| IEEE 802.11b | 11 | Low :CH1 | 2412 |
| | 11 | Middle: CH6 | 2437 |
| | 11 | High: CH11 | 2462 |
| IEEE 802.11g | 54 | Low :CH1 | 2412 |
| | 54 | Middle: CH6 | 2437 |
| | 54 | High: CH11 | 2462 |
| IEEE 802.11n HT20 | 6.5 | Low :CH1 | 2412 |
| | 6.5 | Middle: CH6 | 2437 |
| | 6.5 | High: CH11 | 2462 |
| IEEE 802.11n HT40 | 13.5 | Low :CH1 | 2422 |
| | 13.5 | Middle: CH4 | 2437 |
| | 13.5 | High: CH7 | 2452 |

Note1: According exploratory test, EUT will have maximum PK output power in those data rate, so those data rate were used for all test.

2.3. Tested Supporting System Details

| No. | Description | ACS No. | Manufacturer | Model | Serial Number | Approved type |
|-----|-------------------|---------------------------------------------------------------------------------|--------------|------------|---------------|------------------------------------------------------------------------------------------------------|
| 1 | Personal Computer | Test PC M | DELL | Studio 540 | 224XK2X | <input checked="" type="checkbox"/> FCC DoC <input checked="" type="checkbox"/> BSMI ID:R33002 |
| | | Power Cord: Unshielded, Detachable, 1.8m Display Card: HD3450 (DVI+VGA+HDMI) | | | | |

2.4. Block diagram of connection between the EUT and simulators

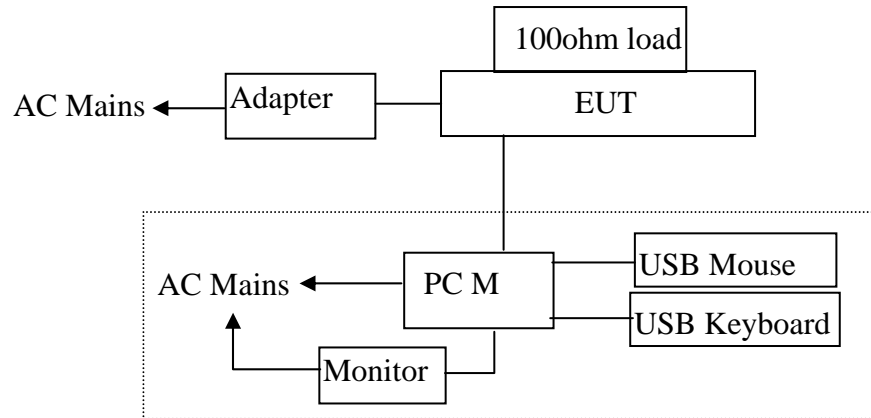

PC M run test software to control EUT work in Tx mode

2.5. Test Facility

Site Description

Name of Firm : Audix Technology (Shenzhen) Co., Ltd.
No. 6, Ke Feng Rd., 52 Block, Shenzhen
Science & Industrial Park, Nantou, Shenzhen,
Guangdong, China

3m Anechoic Chamber : Certificated by FCC, USA
Registration Number: 90454
Valid Date: Mar.31, 2012

3m & 10m Anechoic Chamber : Certificated by FCC, USA
Registration Number: 794232
Valid Date: Dec.30, 2012

EMC Lab. : Certificated by Industry Canada
Registration Number: IC 5183A-1
Valid Date: Jul.02, 2011

: Accredited by DATech, German
Registration Number: DAT-P-091/99-01
Valid Date: Feb.01, 2014

Accredited by NVLAP, USA
NVLAP Code: 200372-0
Valid Date: Mar.31, 2012

2.6. Measurement Uncertainty (95% confidence levels, k=2)

| Test Item | Uncertainty |
|--------------------------------------------------------------------|-----------------------------------|
| Uncertainty for Conduction emission test in No. 1 Conduction | 3.2 dB (150KHz to 30MHz) |
| Uncertainty for Radiation Emission test in 3m chamber | 3.6 dB(30~200MHz, Polarize: H) |
| | 3.7 dB(30~200MHz, Polarize: V) |
| | 4.0 dB(200M~1GHz, Polarize: H) |
| | 3.7 dB(200M~1GHz, Polarize: V) |
| Uncertainty for Radiation Emission test in 3m chamber (1GHz-18GHz) | 3.1dB (Distance: 3m Polarize: V) |
| | 3.7 dB (Distance: 3m Polarize: H) |
| Uncertainty for Radiated Spurious Emission test in RF chamber | 3.57 dB |
| Uncertainty for Conduction Spurious emission test | 2.00 dB |
| Uncertainty for Output power test | 0.73 dB |
| Uncertainty for Power density test | 2.00 dB |
| Uncertainty for Frequency range test | 7×10^{-8} |
| Uncertainty for Bandwidth test | 83 kHz |
| Uncertainty for DC power test | 0.038 % |
| Uncertainty for test site temperature and humidity | 0.6°C |
| | 3% |

3. POWER LINE CONDUCTED EMISSION TEST

3.1. Test Equipments

| Item | Equipment | Manufacturer | Model No. | Serial No. | Last Cal. | Cal. Interval |
|------|----------------|-----------------|-----------|---------------|------------|---------------|
| 1. | Test Receiver | Rohde & Schwarz | ESHS10 | 838693/001 | Nov.05, 10 | 1 Year |
| 2. | L.I.S.N.#1 | Rohde & Schwarz | ESH2-Z5 | 834066/011 | Nov.05, 10 | 1 Year |
| 3. | L.I.S.N.#3 | Kyoritsu | KNW-242C | 8-1920-1 | May 08, 11 | 1 Year |
| 4. | Terminator | Hubersuhner | 50Ω | No. 1 | May 08, 11 | 1 Year |
| 5. | RF Cable | Fujikura | 3D-2W | LISN Cable 1# | May 08, 11 | 1Year |
| 6. | Coaxial Switch | Anritsu | MP59B | M55367 | May 08, 11 | 1 Year |
| 7. | Passive Probe | Rohde & Schwarz | ESH2-Z3 | 299.7810.52 | May 08, 11 | 1 Year |
| 8. | Pulse Limiter | Rohde & Schwarz | ESH3-Z2 | 100341 | May 08, 11 | 1 Year |

3.2. Block Diagram of Test Setup

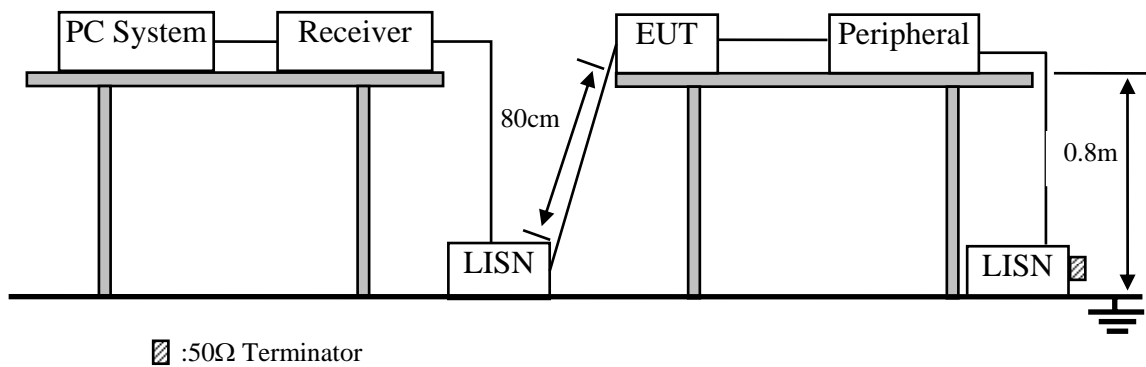

3.3. Power Line Conducted Emission Test Limits

| Frequency | Maximum RF Line Voltage | |
|-----------------|----------------------------|-------------------------|
| | Quasi-Peak Level dB(μV) | Average Level dB(μV) |
| 150kHz ~ 500kHz | 66 ~ 56* | 56 ~ 46* |
| 500kHz ~ 5MHz | 56 | 46 |
| 5MHz ~ 30MHz | 60 | 50 |

- Notes: 1. * Decreasing linearly with logarithm of frequency.
 2. The lower limit shall apply at the transition frequencies.

3.4. Configuration of EUT on Test

The following equipment are installed on Power Line Conducted Emission Test to meet the commission requirement and operating regulations in a manner which tends to maximize its emission characteristics in a normal application.

3.4.1. 150 Mbps 4-port Wireless Broadband Router (EUT)

Model Number : SMCWBR14S-N5

Serial Number : N/A

3.4.2. Support Equipment : As Tested Supporting System Details, in Section 2.3.

3.5. Operating Condition of EUT

3.5.1. Setup the EUT and simulator as shown as Section 2.4.

3.5.2. Turned on the power of all equipment.

3.5.3. PC run test software to control EUT work in Tx mode.

3.6. Test Procedure

The EUT was placed on a non-metallic table, 80cm above the ground plane. The EUT Power connected to the power mains through a line impedance stabilization network (L.I.S.N. 1#). This provides a 50 ohm coupling impedance for the EUT (Please refer the block diagram of the test setup and photographs). The AC line are checked to find out the maximum conducted emission. In order to find the maximum emission levels, the relative positions of equipment and all of the interface cables shall be changed according to ANSI C63.10: 2009 on Conducted Emission Test.

The bandwidth of test receiver (R & S ESHS10) is set at 10kHz.

The frequency range from 150kHz to 30MHz is checked.

3.7. Power Line Conducted Emission Test Results

PASS. (All emissions not reported below are too low against the prescribed limits.)

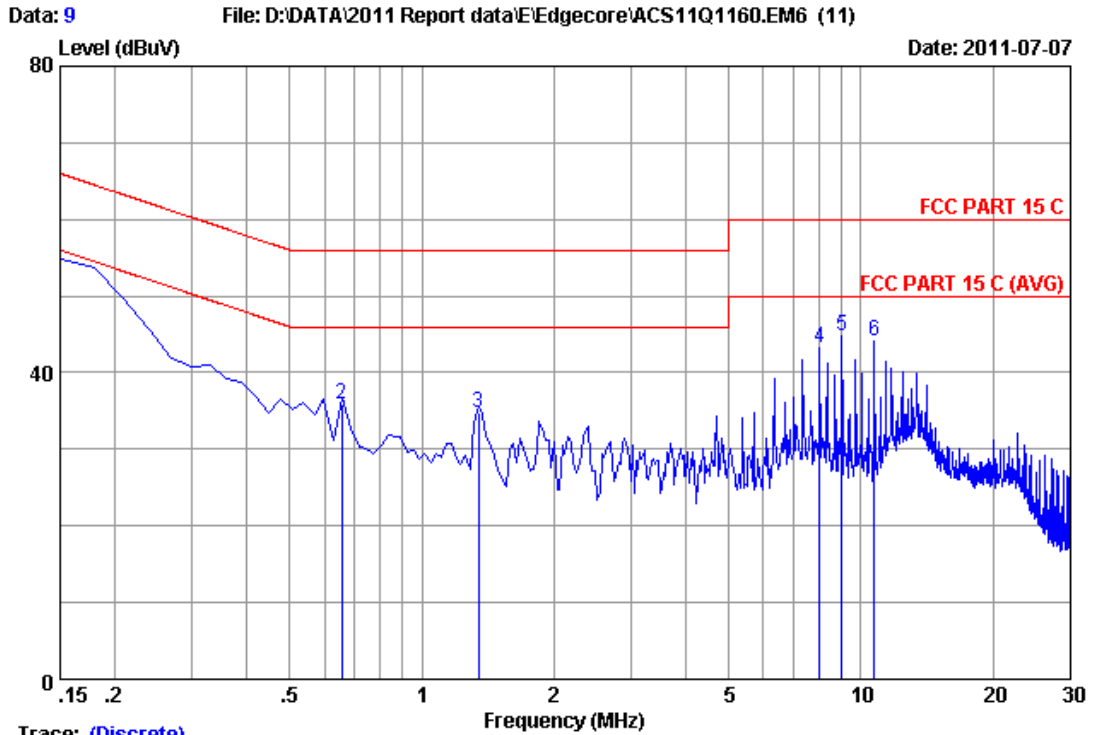

Trace: (Discrete)

Site no :1#conduction Data No :9
 Dis./Ant. **: 2011 ESH2-25 NEUTRAL
 Limit :FCC PART 15 C
 Env./Ins. :29.5°C/55% Engineer :Restar
 EUT :150 Mbps 4-port Wireless Broadband Router
 Power Rating :DC 9V From Adapter Input AC 120V/60Hz
 Test Mode :Tx Mode
 M/N:SMCWBR14S-N5

| No | Freq (MHz) | LISN Factor (dB) | Cable Loss (dB) | Reading (dBuV) | Emission Level (dBuV) | Limits (dBuV) | Margin (dB) | Remark |
|----|------------|------------------|-----------------|----------------|-----------------------|---------------|-------------|--------|
| 1 | 0.15000 | 0.21 | 9.88 | 43.75 | 53.84 | 66.00 | 12.16 | QP |
| 2 | 0.65745 | 0.23 | 9.89 | 25.70 | 35.82 | 56.00 | 20.18 | QP |
| 3 | 1.344 | 0.25 | 9.89 | 24.58 | 34.72 | 56.00 | 21.28 | QP |
| 4 | 8.060 | 0.41 | 9.98 | 32.88 | 43.27 | 60.00 | 16.73 | QP |
| 5 | 9.045 | 0.43 | 9.99 | 34.31 | 44.73 | 60.00 | 15.27 | QP |
| 6 | 10.717 | 0.47 | 9.99 | 33.65 | 44.11 | 60.00 | 15.89 | QP |

Remarks: 1.Emission Level=LISN Factor+Cable Loss(Include 10dB pulse limit)+Reading.
 2.If the average limit is met when using a quasi-peak detector, the EUT shall be deemed to meet both limits and measurement with average detector is unnecessary.

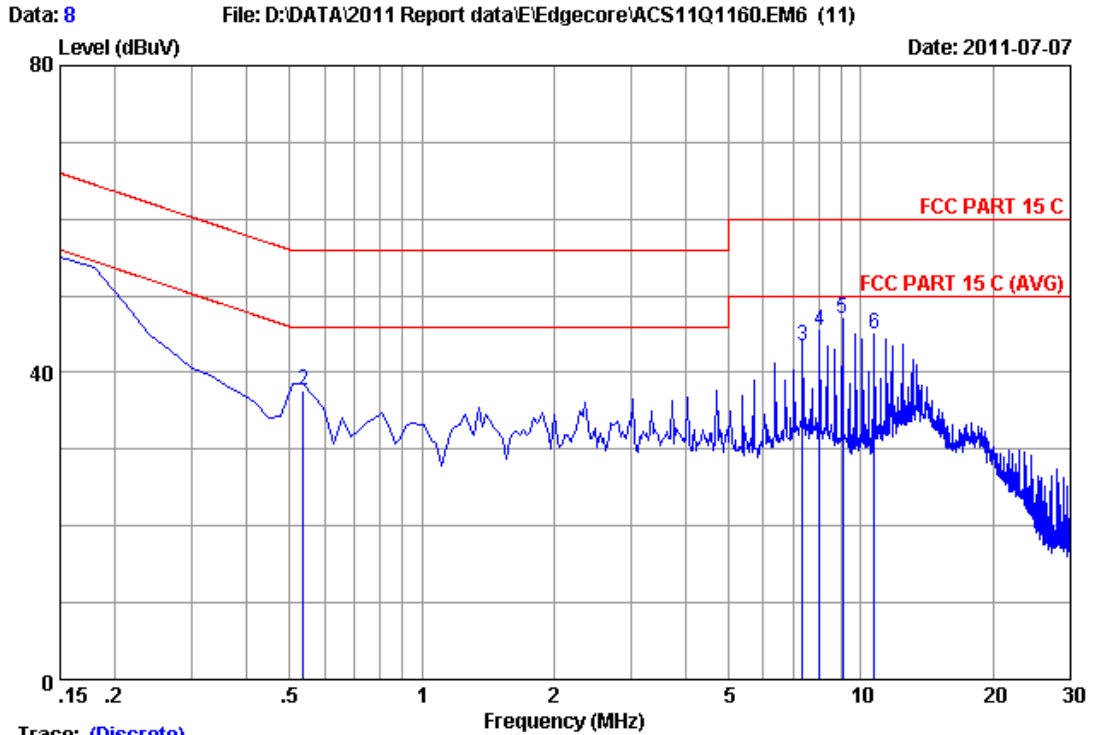

Trace: (Discrete)

Site no :1#conduction Data No :8
 Dis./Ant. **: 2011 ESH2-Z5 NEUTRAL
 Limit :FCC PART 15 C
 Env./Ins. :29.5*C/55% Engineer :Restar
 EUT :150 Mbps 4-port Wireless Broadband Router
 Power Rating :DC 9V From Adapter Input AC 120V/60Hz
 Test Mode :Tx Mode
 M/N:SMCWBR14S-N5

| No | Freq (MHz) | LISN Factor (dB) | Cable Loss (dB) | Reading (dBuV) | Emission Level (dBuV) | Limits (dBuV) | Margin (dB) | Remark |
|----|------------|------------------|-----------------|----------------|-----------------------|---------------|-------------|--------|
| 1 | 0.15000 | 0.21 | 9.88 | 43.92 | 54.01 | 66.00 | 11.99 | QP |
| 2 | 0.53805 | 0.22 | 9.88 | 27.54 | 37.64 | 56.00 | 18.36 | QP |
| 3 | 7.374 | 0.40 | 9.97 | 33.03 | 43.40 | 60.00 | 16.60 | QP |
| 4 | 8.060 | 0.41 | 9.98 | 35.00 | 45.39 | 60.00 | 14.61 | QP |
| 5 | 9.075 | 0.43 | 9.99 | 36.67 | 47.09 | 60.00 | 12.91 | QP |
| 6 | 10.747 | 0.47 | 9.99 | 34.55 | 45.01 | 60.00 | 14.99 | QP |

Remarks: 1.Emission Level=LISN Factor+Cable Loss(Include 10dB pulse limit)+Reading.
 2.If the average limit is met when using a quasi-peak detector. the EUT shall be deemed to meet both limits and measurement with average detector is unnecessary.

4. RADIATED EMISSION TEST

4.1. Test Equipment

4.1.1. For frequency range 30MHz~1000MHz (At Anechoic Chamber)

| Item | Equipment | Manufacturer | Model No. | Serial No. | Last Cal. | Cal. Interval |
|------|----------------|-----------------|-----------|-----------------|-------------|---------------|
| 1 | 3#Chamber | AUDIX | N/A | N/A | Dec.06,10 | 1 Year |
| 2 | EMI Spectrum | Agilent | E4407B | MY41440292 | May.08, 11 | 1 Year |
| 3 | Test Receiver | Rohde & Schwarz | ESVS10 | 834468/011 | May.08, 11 | 1 Year |
| 4 | Amplifier | HP | 8447D | 2648A04738 | May.08, 11 | 1 Year |
| 5 | Bilog Antenna | Schaffner | CBL6111C | 2598 | Oct. 26, 10 | 1 Year |
| 6 | RF Cable | MIYAZAKI | 8D-FB | 3# Chamber No.1 | May.08, 11 | 1 Year |
| 7 | Coaxial Switch | Anritsu | MP59B | M73989 | May.08, 11 | 1 Year |

4.1.2. For frequency range 1GHz~6GHz (At Anechoic Chamber)

| Item | Equipment | Manufacturer | Model No. | Serial No. | Last Cal. | Cal. Interval |
|------|-------------------|--------------|-------------|------------|------------|---------------|
| 1 | Spectrum Analyzer | Agilent | E4407B | MY41440292 | May.08, 11 | 1 Year |
| 2 | Horn Antenna | EMCO | 3115 | 9607-4877 | May.25, 11 | 1.5 Year |
| 3 | Amplifier | Agilent | 8449B | 3008A00863 | May.08, 11 | 1 Year |
| 4 | RF Cable | Hubersuhner | SUCOFLEX102 | 28622/2 | May.08, 11 | 1 Year |
| 5 | RF Cable | Hubersuhner | SUCOFLEX102 | 29091/2 | May.08, 11 | 1 Year |

4.2. Block Diagram of Test Setup

For frequency range 30MHz-1000MHz

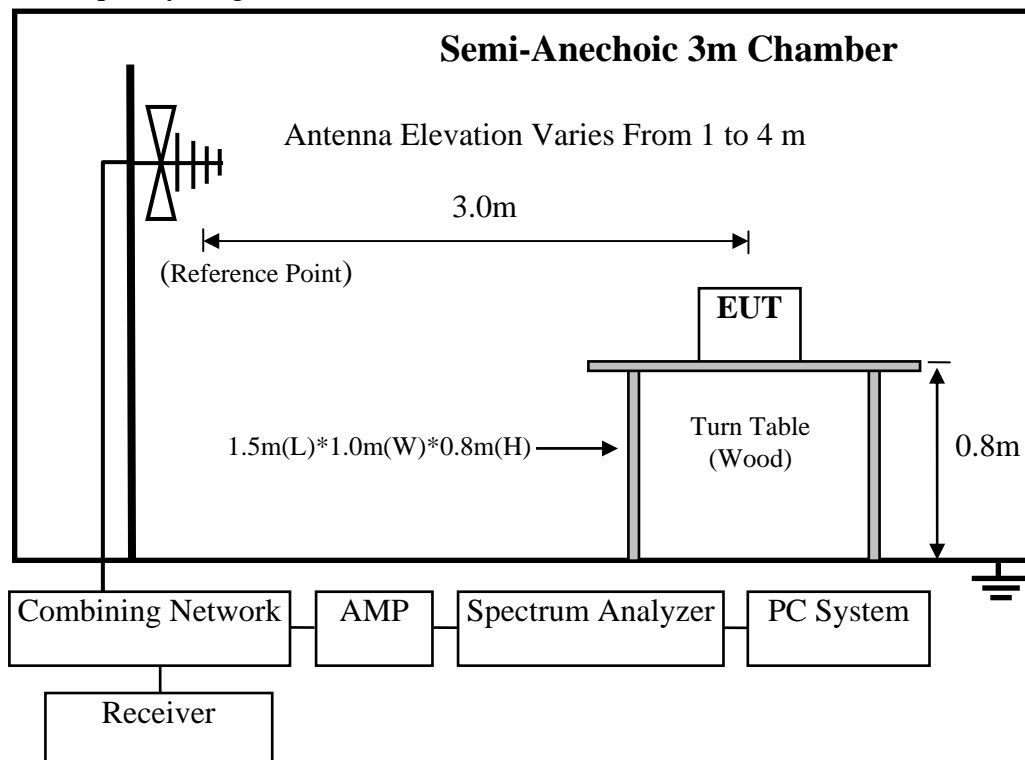

For frequency range 1GHz-25GHz

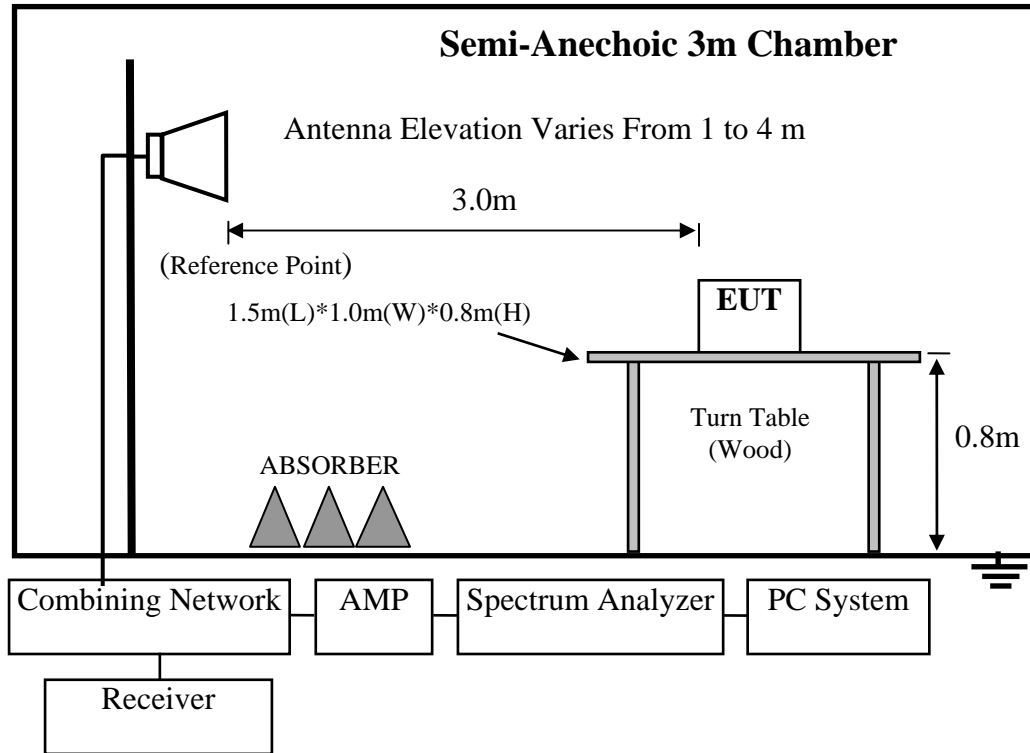

4.3. Radiated Emission Limit

4.3.1.15.209 limits

| FREQUENCY MHz | DISTANCE Meters | FIELD STRENGTHS LIMIT | |
|------------------|--------------------|---------------------------------------------------------------------------------------------------|-----------------------------------|
| | | $\mu\text{V}/\text{m}$ | $\text{dB}(\mu\text{V})/\text{m}$ |
| 30 ~ 88 | 3 | 100 | 40.0 |
| 88 ~ 216 | 3 | 150 | 43.5 |
| 216 ~ 960 | 3 | 200 | 46.0 |
| 960 ~ 1000 | 3 | 500 | 54.0 |
| Above 1000 | 3 | 74.0 $\text{dB}(\mu\text{V})/\text{m}$ (Peak) 54.0 $\text{dB}(\mu\text{V})/\text{m}$ (Average) | |

- Remark :
- (1) Emission level $\text{dB}\mu\text{V} = 20 \log$ Emission level $\mu\text{V}/\text{m}$
 - (2) The smaller limit shall apply at the cross point between two frequency bands.
 - (3) Distance is the distance in meters between the measuring instrument, antenna and the closest point of any part of the device or system.

4.3.2.15.205 Restricted bands of operation

| MHz | MHz | MHz | GHz |
|----------------------------|-----------------------|-----------------|------------------|
| 0.090 - 0.110 | 16.42 - 16.423 | 399.9 - 410 | 4.5 - 5.15 |
| ¹ 0.495 - 0.505 | 16.69475 - 16.69525 | 608 - 614 | 5.35 - 5.46 |
| 2.1735 - 2.1905 | 16.80425 - 16.80475 | 960 - 1240 | 7.25 - 7.75 |
| 4.125 - 4.128 | 25.5 - 25.67 | 1300 - 1427 | 8.025 - 8.5 |
| 4.17725 - 4.17775 | 37.5 - 38.25 | 1435 - 1626.5 | 9.0 - 9.2 |
| 4.20725 - 4.20775 | 73 - 74.6 | 1645.5 - 1646.5 | 9.3 - 9.5 |
| 6.215 - 6.218 | 74.8 - 75.2 | 1660 - 1710 | 10.6 - 12.7 |
| 6.26775 - 6.26825 | 108 - 121.94 | 1718.8 - 1722.2 | 13.25 - 13.4 |
| 6.31175 - 6.31225 | 123 - 138 | 2200 - 2300 | 14.47 - 14.5 |
| 8.291 - 8.294 | 149.9 - 150.05 | 2310 - 2390 | 15.35 - 16.2 |
| 8.362 - 8.366 | 156.52475 - 156.52525 | 2483.5 - 2500 | 17.7 - 21.4 |
| 8.37625 - 8.38675 | 156.7 - 156.9 | 2690 - 2900 | 22.01 - 23.12 |
| 8.41425 - 8.41475 | 162.0125 - 167.17 | 3260 - 3267 | 23.6 - 24.0 |
| 12.29 - 12.293 | 167.72 - 173.2 | 3332 - 3339 | 31.2 - 31.8 |
| 12.51975 - 12.52025 | 240 - 285 | 3345.8 - 3358 | 36.43 - 36.5 |
| 12.57675 - 12.57725 | 322 - 335.4 | 3600 - 4400 | (²) |

All the emissions appearing within 15.205 restricted frequency bands shall not exceed the limits shown in 15.209, all the other emissions shall be at least 20dB below the fundamental emissions, or comply with 15.209 limits.

4.4.EUT Configuration on Test

The configurations of EUT are listed in Section 3.5.

4.5.Operating Condition of EUT

Same as Conducted Emission test that is listed in Section 3.6. except the test set up replaced by Section 4.2.

4.6.Test Procedure

EUT and its simulators are placed on a turn table, which is 0.8 meter high above ground. The turn table can rotate 360 degrees to determine the position of the maximum emission level. Power on the EUT and let it working in test mode, then test it. EUT is set 3 meters away from the receiving antenna, which is mounted on a antenna tower. The antenna can be moved up and down between 1 meter and 4 meters to find out the maximum emission level. Broadband antenna (calibrated bilog antenna) is used as receiving antenna. Both horizontal and vertical polarization of the antenna are set on test.

The bandwidth of the EMI test receiver (R&S ESVS10) is set at 120kHz for frequency range from 30MHz to 1000 MHz.

The bandwidth of the Spectrum's VBW is set at 3MHz and RBW is set at 1MHz for peak emissions measurement above 1GHz and 1MHz RBW, 10Hz VBW for average emissions measure above 1GHz

The frequency range from 30MHz to 10th harmonic (25GHz) are checked. and no any emissions were found from 18GHz to 25 GHz, So the radiated emissions from 18GHz to 25GHz were not record.

4.7. Radiated Emission Test Results

PASS.

All the emissions from 30MHz to 25 GHz were comply with 15.209 limits.

Note: For emissions above 1GHz, if peak level comply with average limit, then the average level is deemed to comply with average limit.

Frequency: 30MHz~1GHz

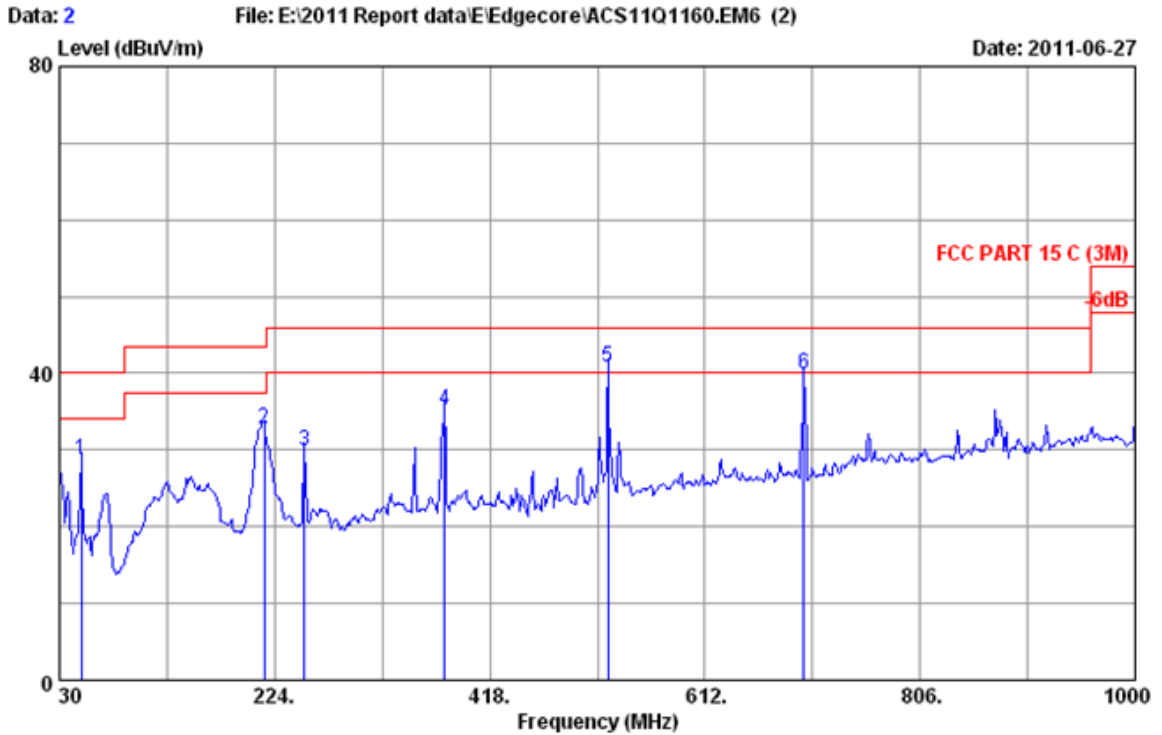

Site no. : 3m Chamber Data no. : 2
 Dis. / Ant. : 3m 2010 CBL6111C 2598 Ant. pol. : HORIZONTAL
 Limit : FCC PART 15 C (3M)
 Env. / Ins. : 24°C/56% Engineer : Leo_Li
 EUT : 150 Mbps 4-port Wireless Broadband Router
 Power rating : DC 9V From Adapter input AC 120V/60Hz
 Test Mode : Tx Mode
 SMCWBR14S-N5

| No. | Freq. (MHz) | Ant. Factor (dB/m) | Cable Loss (dB) | Reading (dBuV) | Emission Level (dBuV/m) | Limits (dBuV/m) | Margin (dB) | Remark |
|-----|-------------|--------------------|-----------------|----------------|-------------------------|-----------------|-------------|--------|
| 1 | 49.400 | 9.72 | 0.82 | 18.14 | 28.68 | 40.00 | 11.32 | QP |
| 2 | 214.300 | 10.02 | 1.99 | 20.78 | 32.79 | 43.50 | 10.71 | QP |
| 3 | 251.160 | 12.90 | 2.43 | 14.64 | 29.97 | 46.00 | 16.03 | QP |
| 4 | 377.260 | 15.64 | 3.25 | 16.40 | 35.29 | 46.00 | 10.71 | QP |
| 5 | 524.700 | 18.35 | 4.12 | 18.40 | 40.87 | 46.00 | 5.13 | QP |
| 6 | 701.240 | 20.79 | 5.01 | 14.00 | 39.80 | 46.00 | 6.20 | QP |

Remarks: 1. Emission Level= Antenna Factor + Cable Loss + Reading.
 2. The emission levels that are 20dB below the official limit are not reported.

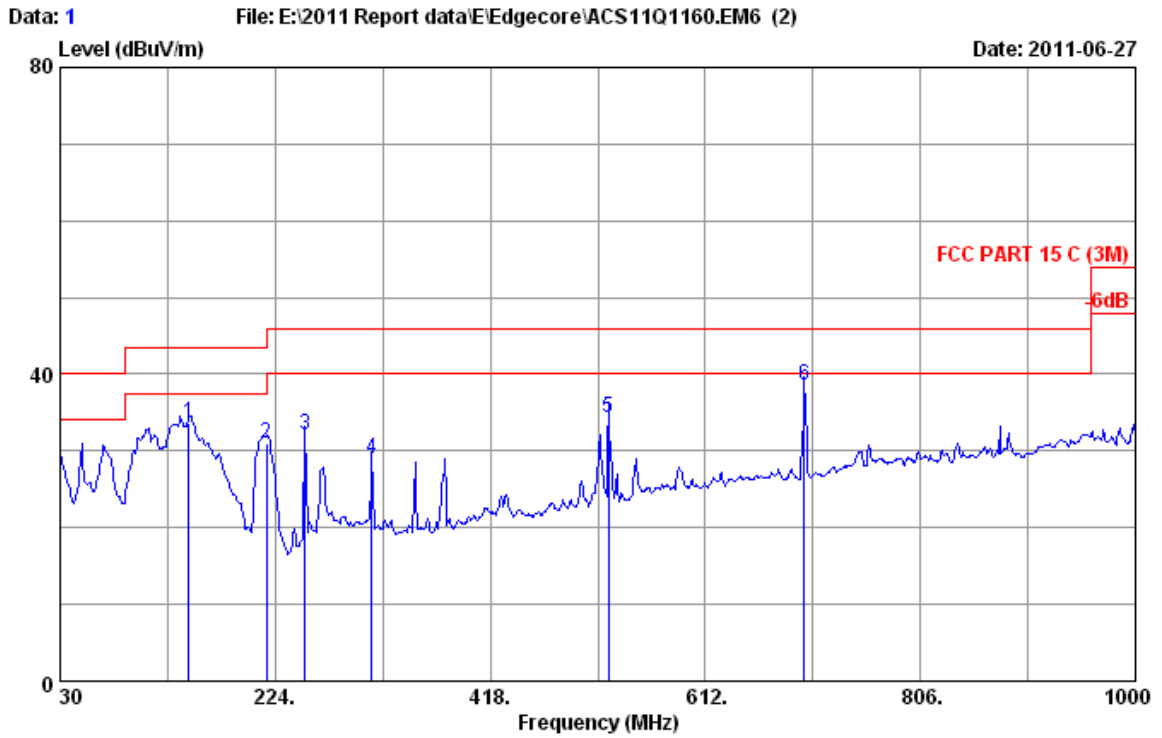

Site no. : 3m Chamber Data no. : 1
 Dis. / Ant. : 3m 2010 CBL6111C 2598 Ant. pol. : VERTICAL
 Limit : FCC PART 15 C (3M)
 Env. / Ins. : 24°C/56% Engineer : Leo_Li
 EUT : 150 Mbps 4-port Wireless Broadband Router
 Power rating : DC 9V From Adapter input AC 120V/60Hz
 Test Mode : Tx Mode
 SMCWBR14S-N5

| No. | Freq. (MHz) | Ant. Factor (dB/m) | Cable Loss (dB) | Reading (dBuV) | Emission Level (dBuV/m) | Limits (dBuV/m) | Margin (dB) | Remark |
|-----|-------------|--------------------|-----------------|----------------|-------------------------|-----------------|-------------|--------|
| 1 | 146.400 | 11.84 | 1.47 | 20.45 | 33.76 | 43.50 | 9.74 | QP |
| 2 | 216.240 | 10.04 | 2.02 | 18.94 | 31.00 | 46.00 | 15.00 | QP |
| 3 | 251.160 | 12.90 | 2.43 | 16.80 | 32.13 | 46.00 | 13.87 | QP |
| 4 | 311.300 | 14.02 | 3.04 | 11.91 | 28.97 | 46.00 | 17.03 | QP |
| 5 | 524.700 | 18.35 | 4.12 | 11.78 | 34.25 | 46.00 | 11.75 | QP |
| 6 | 701.240 | 20.79 | 5.01 | 12.86 | 38.66 | 46.00 | 7.34 | QP |

Remarks: 1. Emission Level= Antenna Factor + Cable Loss + Reading.
 2. The emission levels that are 20dB below the official limit are not reported.

Frequency: 1GHz~18GHz

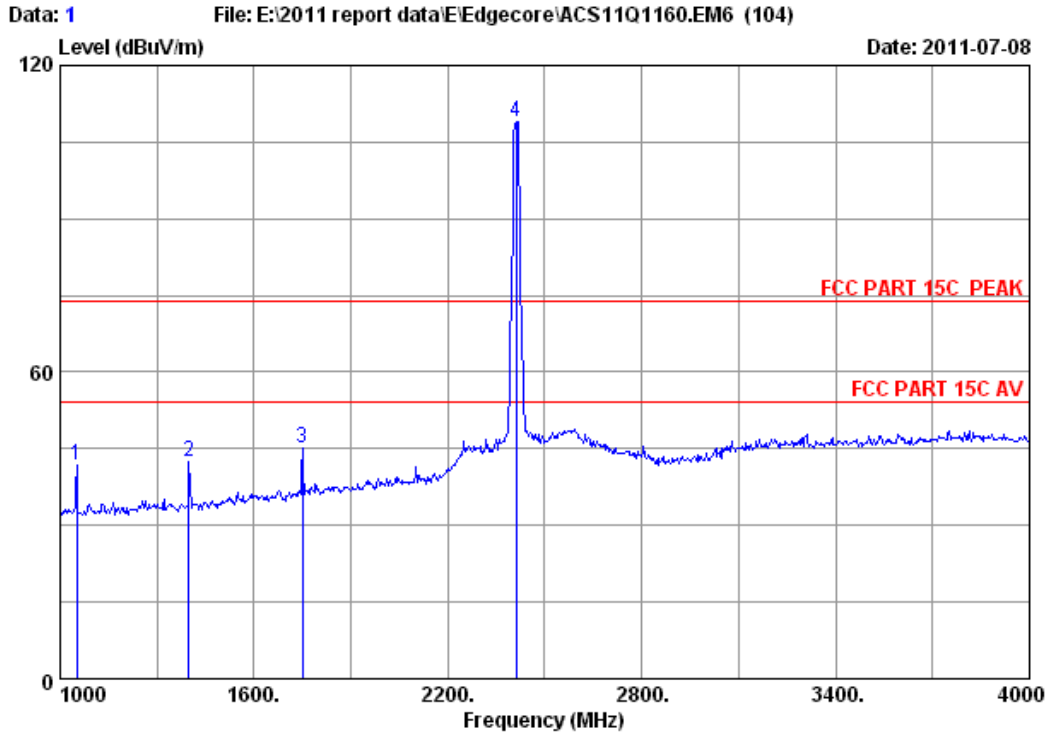

Site no. : 3m Chamber Data no. : 1
 Dis. / Ant. : 3m 3115(0911) Ant. pol. : VERTICAL
 Limit : FCC PART 15C PEAK
 Env. / Ins. : 23°C/54% Engineer : Leo-Li
 EUT : 150 Mbps 4-port Wireless Broadband Router
 Power : DC 9V From Adapter input AC 120V/60Hz
 Test mode : IEEE802.11b CH1 2412MHz Tx
 M/N : SMCWBR14S-N5

| | Ant. | Cable | Amp. | Emission | | | | | |
|-------|----------|-------|--------|----------|----------|----------|--------|--------|------|
| Freq. | Factor | loss | Factor | Reading | Level | Limits | Margin | Remark | |
| (MHz) | (dB/m) | (dB) | (dB) | (dBUV) | (dBUV/m) | (dBUV/m) | (dB) | | |
| 1 | 1051.000 | 25.50 | 4.86 | 37.81 | 49.20 | 41.75 | 74.00 | 32.25 | Peak |
| 2 | 1399.000 | 26.19 | 5.50 | 37.18 | 47.97 | 42.48 | 74.00 | 31.52 | Peak |
| 3 | 1750.000 | 27.80 | 6.18 | 36.86 | 48.05 | 45.17 | 74.00 | 28.83 | Peak |
| 4 | 2412.000 | 29.45 | 7.43 | 36.62 | 108.79 | 109.05 | 74.00 | -35.05 | Peak |

Remarks:

1. Emission Level= Antenna Factor + Cable Loss -Amp Factor + Reading.
2. The emission levels that are 20dB below the official limit are not reported.

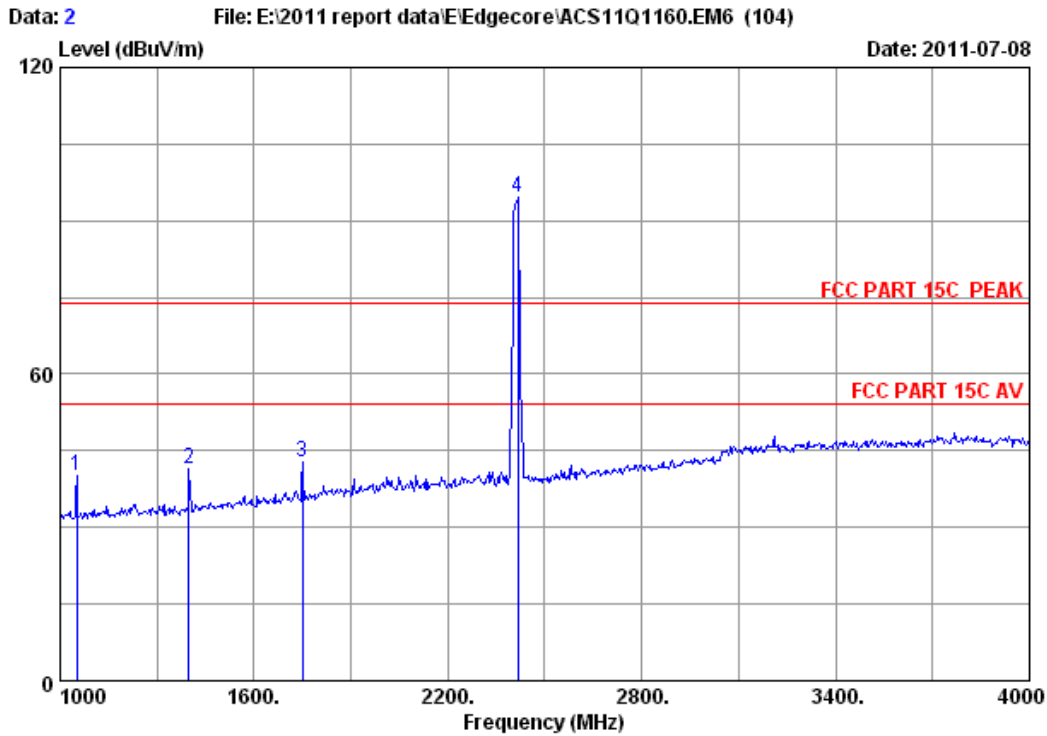

Site no. : 3m Chamber Data no. : 2
 Dis. / Ant. : 3m 3115(0911) Ant. pol. : HORIZONTAL
 Limit : FCC PART 15C PEAK
 Env. / Ins. : 23*C/54% Engineer : Leo-Li
 EUT : 150 Mbps 4-port Wireless Broadband Router
 Power : DC 9V From Adapter input AC 120V/60Hz
 Test mode : IEEE802.11b CH1 2412MHz Tx
 M/N : SMCWBR14S-N5

| | Ant. Freq. (MHz) | Ant. Factor (dB/m) | Cable loss (dB) | Amp. Factor (dB) | Reading (dBuV) | Emission Level (dBuV/m) | Limits (dBuV/m) | Margin (dB) | Remark |
|---|------------------|--------------------|-----------------|------------------|----------------|-------------------------|-----------------|-------------|--------|
| 1 | 1051.000 | 25.50 | 4.86 | 37.81 | 47.68 | 40.23 | 74.00 | 33.77 | Peak |
| 2 | 1399.000 | 26.19 | 5.50 | 37.18 | 46.97 | 41.48 | 74.00 | 32.52 | Peak |
| 3 | 1750.000 | 27.80 | 6.18 | 36.86 | 45.79 | 42.91 | 74.00 | 31.09 | Peak |
| 4 | 2416.000 | 29.45 | 7.43 | 36.61 | 94.41 | 94.68 | 74.00 | -20.68 | Peak |

Remarks:

1. Emission Level= Antenna Factor + Cable Loss -Amp Factor + Reading.
2. The emission levels that are 20dB below the official limit are not reported.

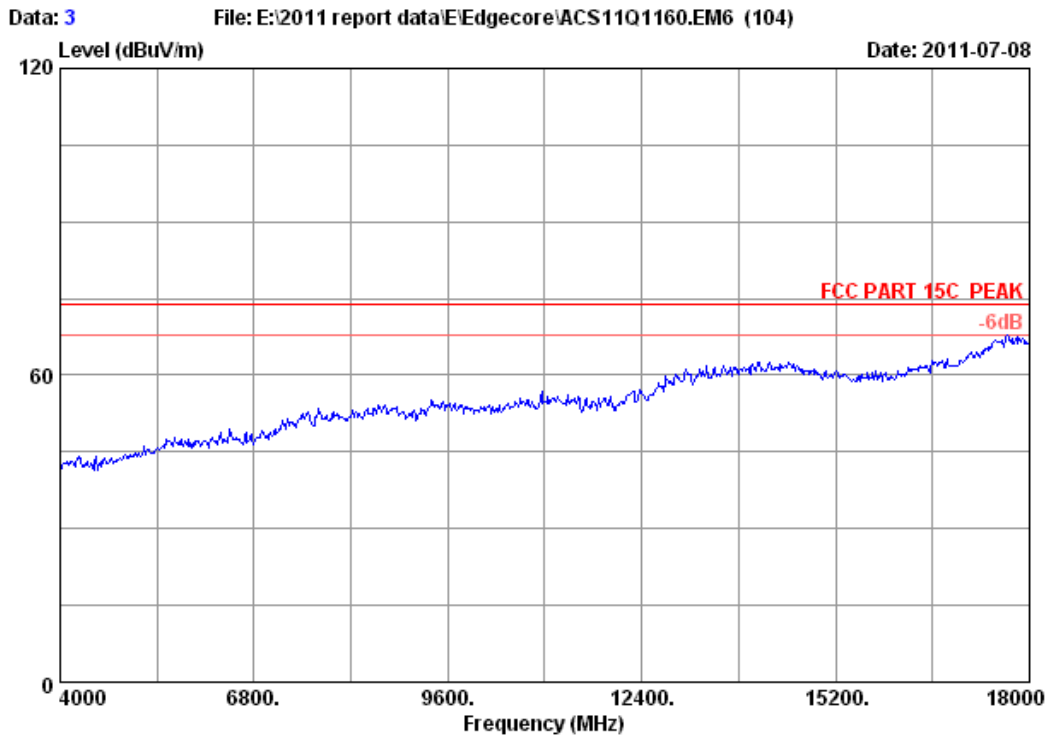

Site no. : 3m Chamber Data no. : 3
Dis. / Ant. : 3m 3115(0911) Ant. pol. : HORIZONTAL
Limit : FCC PART 15C PEAK
Env. / Ins. : 23°C/54% Engineer : Leo-Li
EUT : 150 Mbps 4-port Wireless Broadband Router
Power : DC 9V From Adapter input AC 120V/60Hz
Test mode : IEEE802.11b CH1 2412MHz Tx
M/N : SMCWBR14S-N5

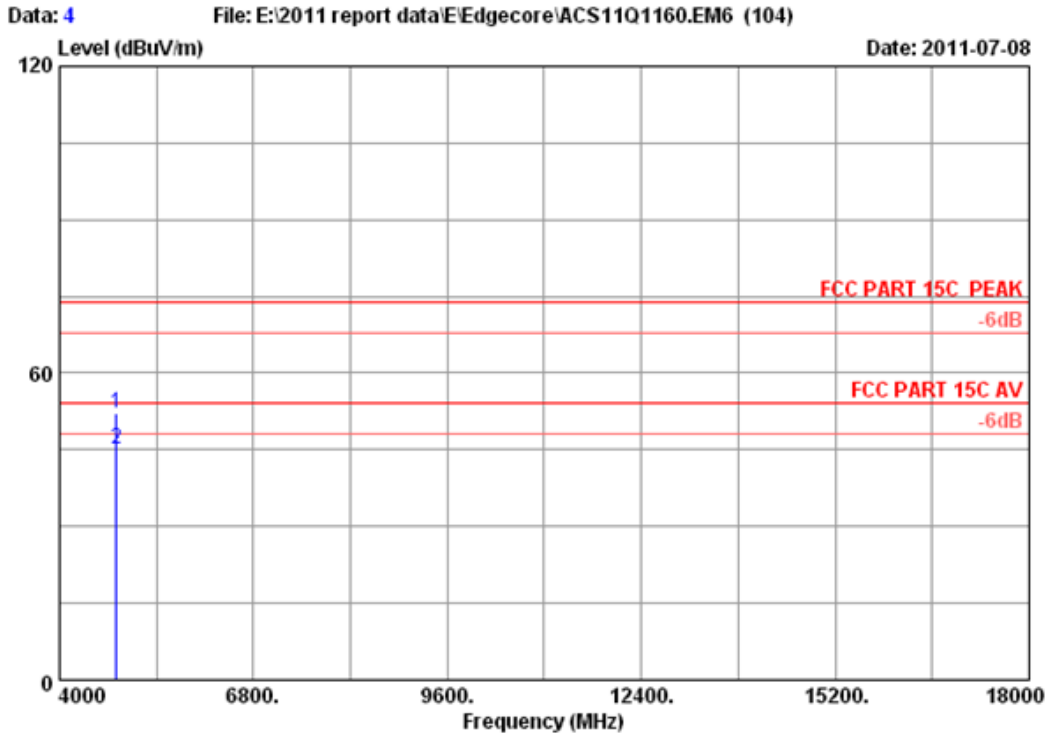

Site no. : 3m Chamber Data no. : 4
 Dis. / Ant. : 3m 3115(0911) Ant. pol. : HORIZONTAL
 Limit : FCC PART 15C PEAK
 Env. / Ins. : 23°C/54% Engineer : Leo-Li
 EUT : 150 Mbps 4-port Wireless Broadband Router
 Power : DC 9V From Adapter input AC 120V/60Hz
 Test mode : IEEE802.11b CH1 2412MHz Tx
 M/N : SMCWBR14S-N5

| | Ant. Freq. (MHz) | Ant. Factor (dB/m) | Cable loss (dB) | Amp. Factor (dB) | Reading (dBuV) | Emission Level (dBuV/m) | Limits (dBuV/m) | Margin (dB) | Remark |
|---|------------------|--------------------|-----------------|------------------|----------------|-------------------------|-----------------|-------------|---------|
| 1 | 4824.000 | 34.32 | 10.64 | 35.08 | 42.37 | 52.25 | 74.00 | 21.75 | Peak |
| 2 | 4824.000 | 34.32 | 10.64 | 35.08 | 35.27 | 45.15 | 54.00 | 8.85 | Average |

Remarks:

1. Emission Level= Antenna Factor + Cable Loss -Amp Factor + Reading.
2. The emission levels that are 20dB below the official limit are not reported.

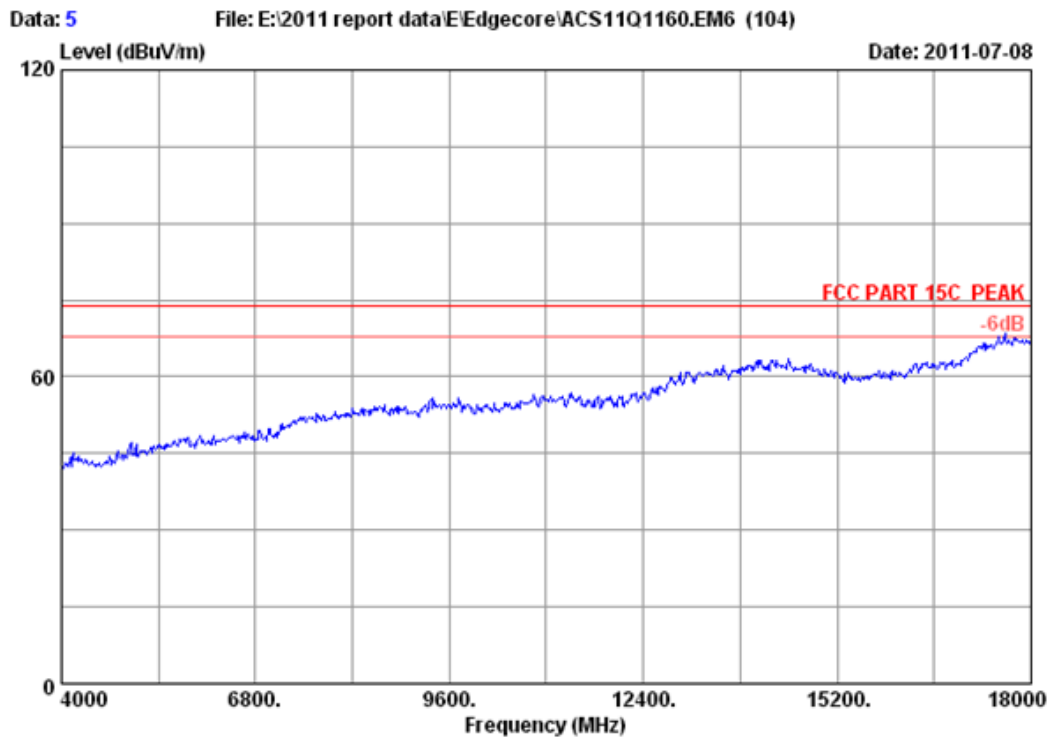

Site no. : 3m Chamber Data no. : 5
Dis. / Ant. : 3m 3115(0911) Ant. pol. : VERTICAL
Limit : FCC PART 15C PEAK
Env. / Ins. : 23°C/54% Engineer : Leo-Li
EUT : 150 Mbps 4-port Wireless Broadband Router
Power : DC 9V From Adapter input AC 120V/60Hz
Test mode : IEEE802.11b CH1 2412MHz Tx
M/N : SMCWBR14S-N5

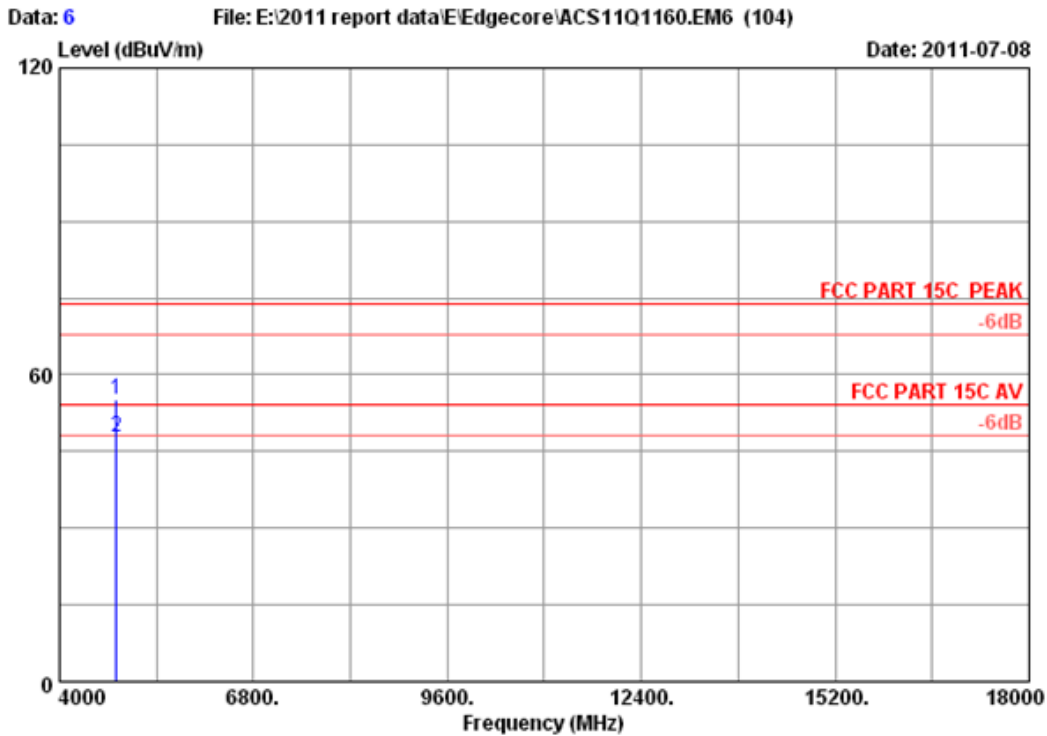

Site no. : 3m Chamber Data no. : 6
 Dis. / Ant. : 3m 3115(0911) Ant. pol. : VERTICAL
 Limit : FCC PART 15C PEAK
 Env. / Ins. : 23°C/54% Engineer : Leo-Li
 EUT : 150 Mbps 4-port Wireless Broadband Router
 Power : DC 9V From Adapter input AC 120V/60Hz
 Test mode : IEEE802.11b CH1 2412MHz Tx
 M/N : SMCWBR14S-N5

| | Freq. (MHz) | Ant. Factor (dB/m) | Cable loss (dB) | Amp. Factor (dB) | Reading (dBuV) | Emission Level (dBuV/m) | Limits (dBuV/m) | Margin (dB) | Remark |
|---|-------------|--------------------|-----------------|------------------|----------------|-------------------------|-----------------|-------------|---------|
| 1 | 4824.000 | 34.32 | 10.64 | 35.08 | 45.26 | 55.14 | 74.00 | 18.86 | Peak |
| 2 | 4824.000 | 34.32 | 10.64 | 35.08 | 37.85 | 47.73 | 54.00 | 6.27 | Average |

Remarks:

1. Emission Level= Antenna Factor + Cable Loss -Amp Factor + Reading.
2. The emission levels that are 20dB below the official limit are not reported.

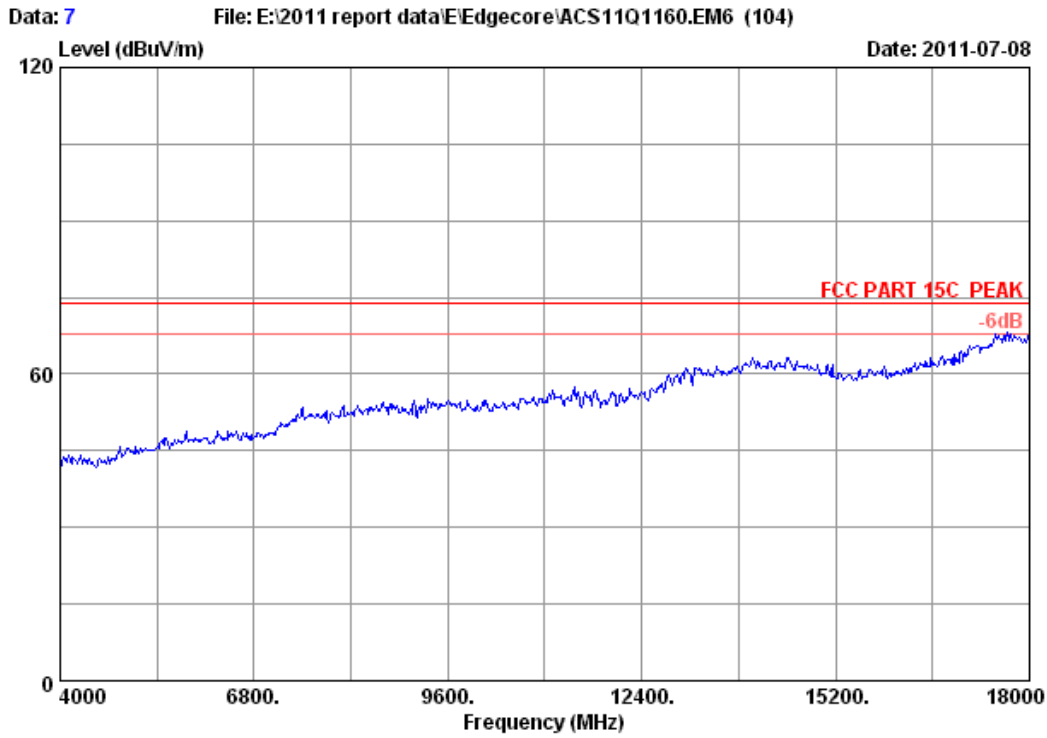

Site no. : 3m Chamber Data no. : 7
Dis. / Ant. : 3m 3115(0911) Ant. pol. : VERTICAL
Limit : FCC PART 15C PEAK
Env. / Ins. : 23°C/54% Engineer : Leo-Li
EUT : 150 Mbps 4-port Wireless Broadband Router
Power : DC 9V From Adapter input AC 120V/60Hz
Test mode : IEEE802.11b CH6 2437MHz Tx
M/N : SMCWBR14S-N5

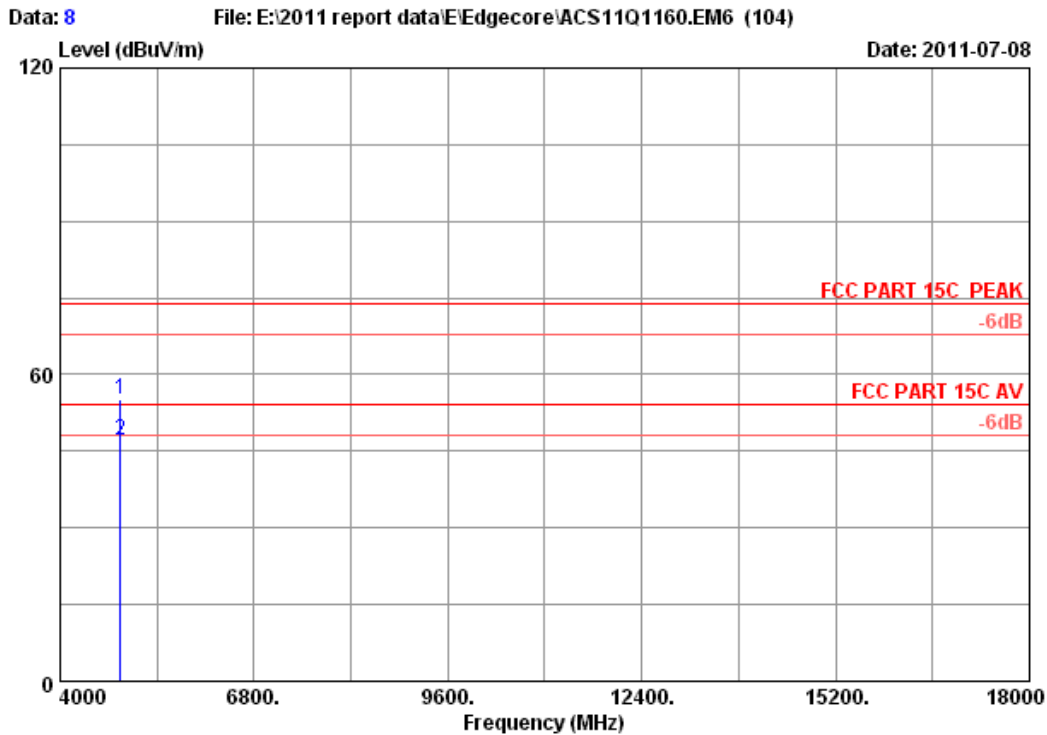

Site no. : 3m Chamber Data no. : 8
 Dis. / Ant. : 3m 3115(0911) Ant. pol. : VERTICAL
 Limit : FCC PART 15C PEAK
 Env. / Ins. : 23°C/54% Engineer : Leo-Li
 EUT : 150 Mbps 4-port Wireless Broadband Router
 Power : DC 9V From Adapter input AC 120V/60Hz
 Test mode : IEEE802.11b CH6 2437MHz Tx
 M/N : SMCWBR14S-N5

| | Ant. | Cable | Amp. | Emission | | | | | |
|-------|----------|-------|--------|----------|----------|----------|--------|--------|---------|
| Freq. | Factor | loss | Factor | Reading | Level | Limits | Margin | Remark | |
| (MHz) | (dB/m) | (dB) | (dB) | (dBuV) | (dBuV/m) | (dBuV/m) | (dB) | | |
| 1 | 4874.000 | 34.41 | 10.69 | 35.03 | 45.13 | 55.20 | 74.00 | 18.80 | Peak |
| 2 | 4874.000 | 34.41 | 10.69 | 35.03 | 37.16 | 47.23 | 54.00 | 6.77 | Average |

Remarks:

1. Emission Level= Antenna Factor + Cable Loss -Amp Factor + Reading.
2. The emission levels that are 20dB below the official limit are not reported.

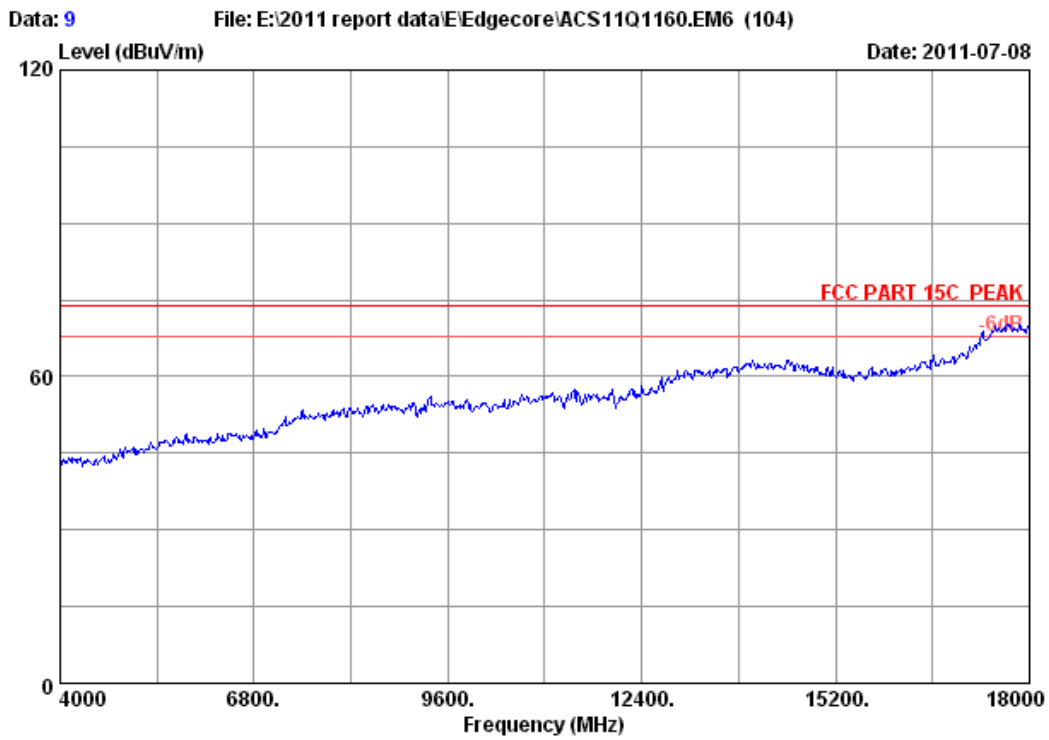

Site no. : 3m Chamber Data no. : 9
Dis. / Ant. : 3m 3115(0911) Ant. pol. : HORIZONTAL
Limit : FCC PART 15C PEAK
Env. / Ins. : 23°C/54% Engineer : Leo-Li
EUT : 150 Mbps 4-port Wireless Broadband Router
Power : DC 9V From Adapter input AC 120V/60Hz
Test mode : IEEE802.11b CH6 2437MHz Tx
M/N : SMCWBR14S-N5

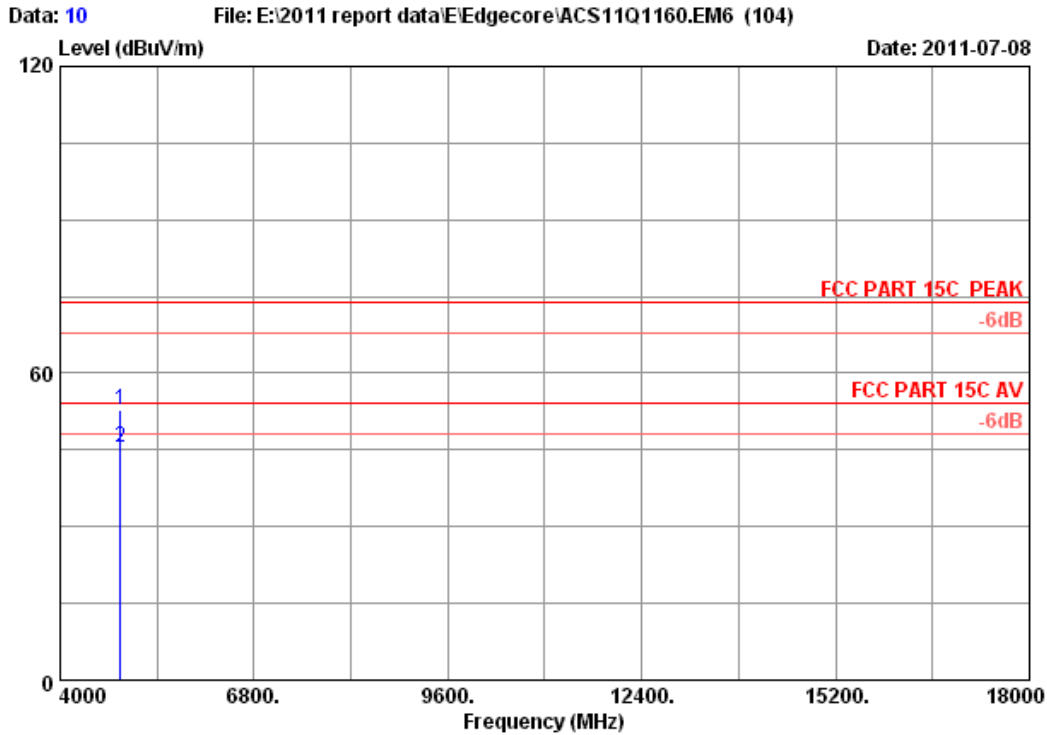

Site no. : 3m Chamber Data no. : 10
 Dis. / Ant. : 3m 3115(0911) Ant. pol. : HORIZONTAL
 Limit : FCC PART 15C PEAK
 Env. / Ins. : 23°C/54% Engineer : Leo-Li
 EUT : 150 Mbps 4-port Wireless Broadband Router
 Power : DC 9V From Adapter input AC 120V/60Hz
 Test mode : IEEE802.11b CH6 2437MHz Tx
 M/N : SMCWBR14S-N5

| | Ant. Freq. (MHz) | Ant. Factor (dB/m) | Cable loss (dB) | Amp. Factor (dB) | Reading (dBUV) | Emission Level (dBUV/m) | Limits (dBUV/m) | Margin (dB) | Remark |
|---|------------------|--------------------|-----------------|------------------|----------------|-------------------------|-----------------|-------------|---------|
| 1 | 4874.000 | 34.41 | 10.69 | 35.03 | 42.68 | 52.75 | 74.00 | 21.25 | Peak |
| 2 | 4874.000 | 34.41 | 10.69 | 35.03 | 35.42 | 45.49 | 54.00 | 8.51 | Average |

- Remarks:
1. Emission Level= Antenna Factor + Cable Loss -Amp Factor + Reading.
 2. The emission levels that are 20dB below the official limit are not reported.

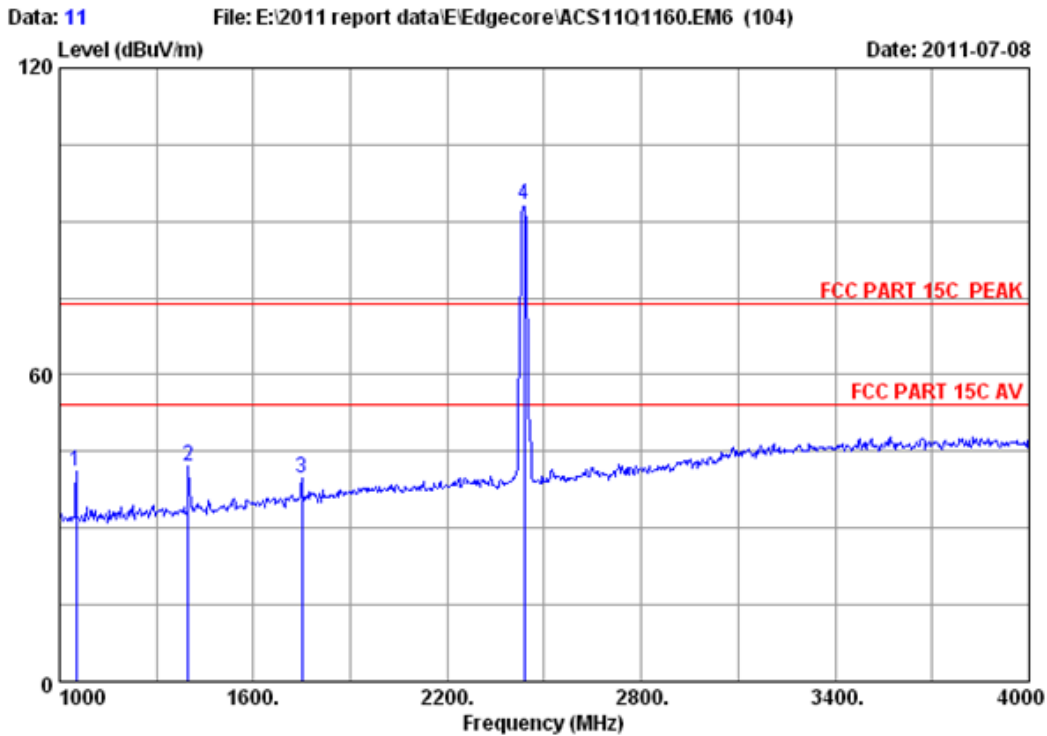

Site no. : 3m Chamber Data no. : 11
 Dis. / Ant. : 3m 3115(0911) Ant. pol. : HORIZONTAL
 Limit : FCC PART 15C PEAK
 Env. / Ins. : 23°C/54% Engineer : Leo-Li
 EUT : 150 Mbps 4-port Wireless Broadband Router
 Power : DC 9V From Adapter input AC 120V/60Hz
 Test mode : IEEE802.11b CH6 2437MHz Tx
 M/N : SMCWBR14S-N5

| | Freq. (MHz) | Ant. Factor (dB/m) | Cable loss (dB) | Amp. Factor (dB) | Reading (dBuV) | Emission Level (dBuV/m) | Limits (dBuV/m) | Margin (dB) | Remark |
|---|-------------|--------------------|-----------------|------------------|----------------|-------------------------|-----------------|-------------|--------|
| 1 | 1051.000 | 25.50 | 4.86 | 37.81 | 48.55 | 41.10 | 74.00 | 32.90 | Peak |
| 2 | 1399.000 | 26.19 | 5.50 | 37.18 | 47.52 | 42.03 | 74.00 | 31.97 | Peak |
| 3 | 1750.000 | 27.80 | 6.18 | 36.86 | 42.53 | 39.65 | 74.00 | 34.35 | Peak |
| 4 | 2437.000 | 29.47 | 7.46 | 36.61 | 92.89 | 93.21 | 74.00 | -19.21 | Peak |

Remarks:

1. Emission Level= Antenna Factor + Cable Loss -Amp Factor + Reading.
2. The emission levels that are 20dB below the official limit are not reported.

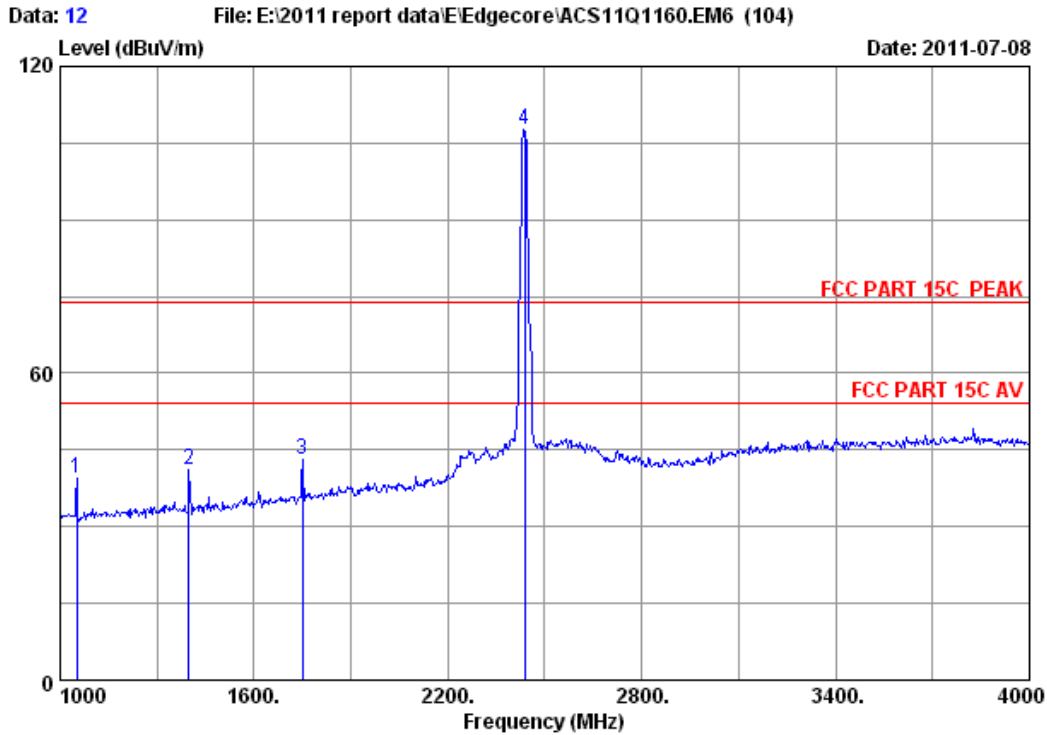

Site no. : 3m Chamber Data no. : 12
 Dis. / Ant. : 3m 3115(0911) Ant. pol. : VERTICAL
 Limit : FCC PART 15C PEAK
 Env. / Ins. : 23°C/54% Engineer : Leo-Li
 EUT : 150 Mbps 4-port Wireless Broadband Router
 Power : DC 9V From Adapter input AC 120V/60Hz
 Test mode : IEEE802.11b CH6 2437MHz Tx
 M/N : SMCWBR14S-N5

| | Ant. Freq. (MHz) | Ant. Factor (dB/m) | Cable loss (dB) | Amp. Factor (dB) | Reading (dBuV) | Emission Level (dBuV/m) | Limits (dBuV/m) | Margin (dB) | Remark |
|---|------------------|--------------------|-----------------|------------------|----------------|-------------------------|-----------------|-------------|--------|
| 1 | 1051.000 | 25.50 | 4.86 | 37.81 | 46.84 | 39.39 | 74.00 | 34.61 | Peak |
| 2 | 1399.000 | 26.19 | 5.50 | 37.18 | 46.65 | 41.16 | 74.00 | 32.84 | Peak |
| 3 | 1750.000 | 27.80 | 6.18 | 36.86 | 46.14 | 43.26 | 74.00 | 30.74 | Peak |
| 4 | 2437.000 | 29.47 | 7.46 | 36.61 | 107.22 | 107.54 | 74.00 | -33.54 | Peak |

Remarks:

1. Emission Level= Antenna Factor + Cable Loss -Amp Factor + Reading.
2. The emission levels that are 20dB below the official limit are not reported.

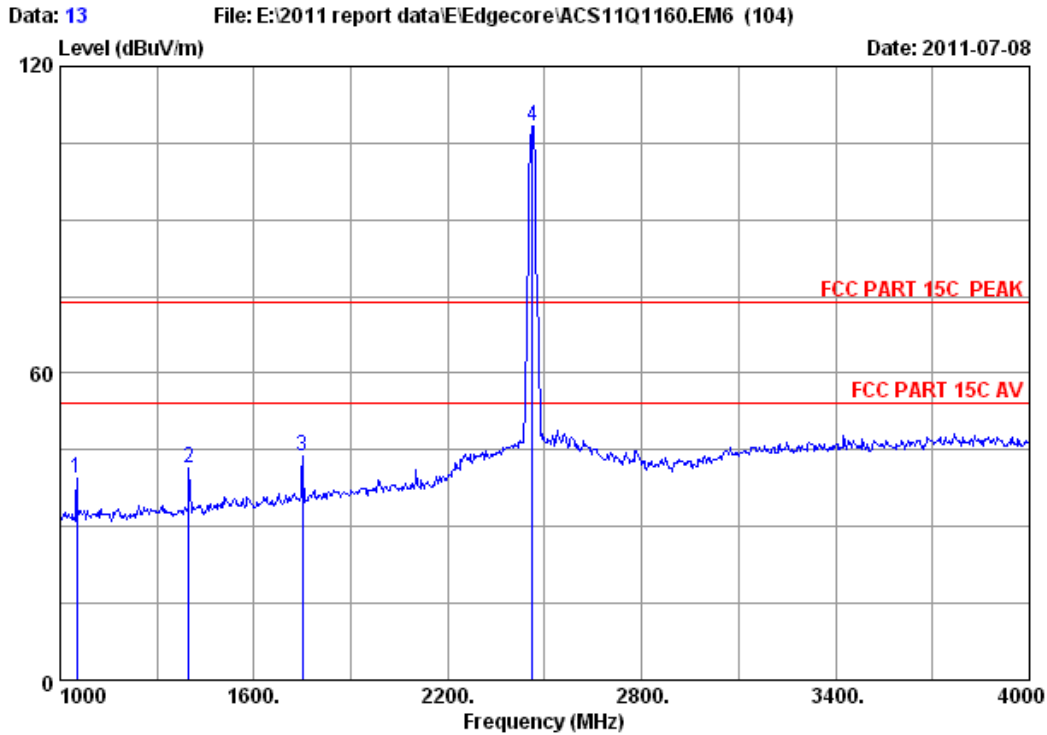

Site no. : 3m Chamber Data no. : 13
 Dis. / Ant. : 3m 3115(0911) Ant. pol. : VERTICAL
 Limit : FCC PART 15C PEAK
 Env. / Ins. : 23°C/54% Engineer : Leo-Li
 EUT : 150 Mbps 4-port Wireless Broadband Router
 Power : DC 9V From Adapter input AC 120V/60Hz
 Test mode : IEEE802.11b CH11 2462MHz Tx
 M/N : SMCWBR14S-N5

| | Ant. Freq. (MHz) | Ant. Factor (dB/m) | Cable loss (dB) | Amp. Factor (dB) | Reading (dBuV) | Emission Level (dBuV/m) | Limits (dBuV/m) | Margin (dB) | Remark |
|---|------------------|--------------------|-----------------|------------------|----------------|-------------------------|-----------------|-------------|--------|
| 1 | 1051.000 | 25.50 | 4.86 | 37.81 | 46.83 | 39.38 | 74.00 | 34.62 | Peak |
| 2 | 1399.000 | 26.19 | 5.50 | 37.18 | 47.05 | 41.56 | 74.00 | 32.44 | Peak |
| 3 | 1750.000 | 27.80 | 6.18 | 36.86 | 46.73 | 43.85 | 74.00 | 30.15 | Peak |
| 4 | 2462.000 | 29.48 | 7.54 | 36.61 | 107.98 | 108.39 | 74.00 | -34.39 | Peak |

Remarks:

1. Emission Level= Antenna Factor + Cable Loss -Amp Factor + Reading.
2. The emission levels that are 20dB below the official limit are not reported.

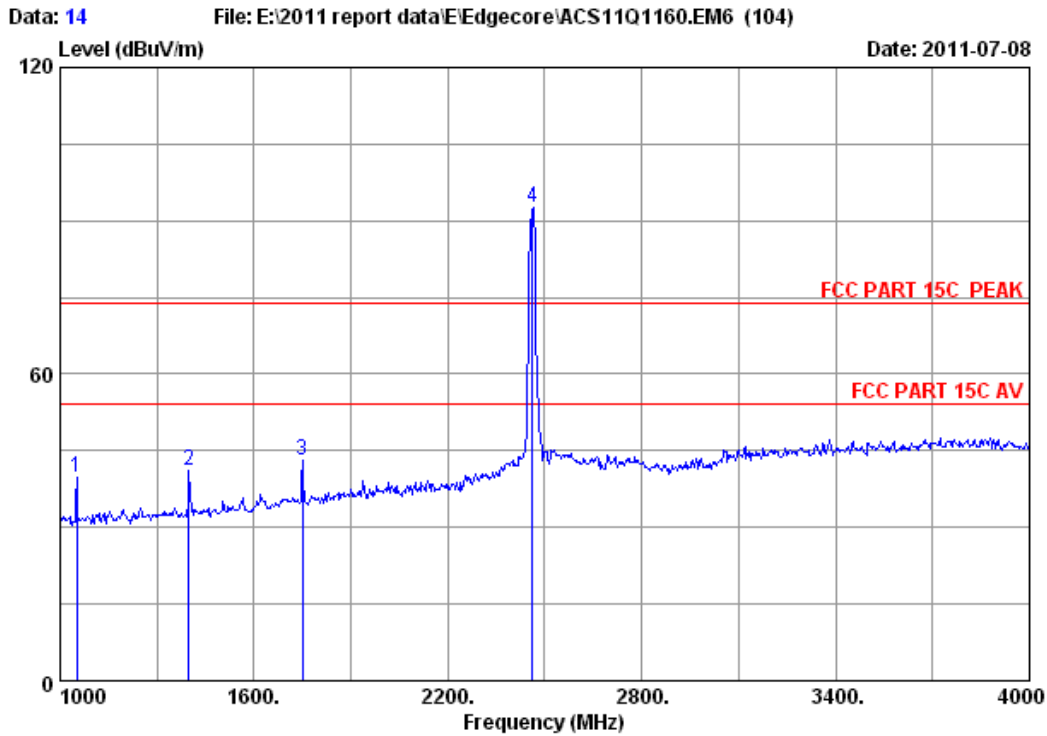

Site no. : 3m Chamber Data no. : 14
 Dis. / Ant. : 3m 3115(0911) Ant. pol. : HORIZONTAL
 Limit : FCC PART 15C PEAK
 Env. / Ins. : 23°C/54% Engineer : Leo-Li
 EUT : 150 Mbps 4-port Wireless Broadband Router
 Power : DC 9V From Adapter input AC 120V/60Hz
 Test mode : IEEE802.11b CH11 2462MHz Tx
 M/N : SMCWBR14S-N5

| | Ant. Freq. (MHz) | Ant. Factor (dB/m) | Cable loss (dB) | Amp. Factor (dB) | Reading (dBuV) | Emission Level (dBuV/m) | Limits (dBuV/m) | Margin (dB) | Remark |
|---|------------------|--------------------|-----------------|------------------|----------------|-------------------------|-----------------|-------------|--------|
| 1 | 1051.000 | 25.50 | 4.86 | 37.81 | 47.08 | 39.63 | 74.00 | 34.37 | Peak |
| 2 | 1399.000 | 26.19 | 5.50 | 37.18 | 46.69 | 41.20 | 74.00 | 32.80 | Peak |
| 3 | 1750.000 | 27.80 | 6.18 | 36.86 | 46.05 | 43.17 | 74.00 | 30.83 | Peak |
| 4 | 2462.000 | 29.48 | 7.54 | 36.61 | 92.17 | 92.58 | 74.00 | -18.58 | Peak |

Remarks:

1. Emission Level= Antenna Factor + Cable Loss -Amp Factor + Reading.
2. The emission levels that are 20dB below the official limit are not reported.

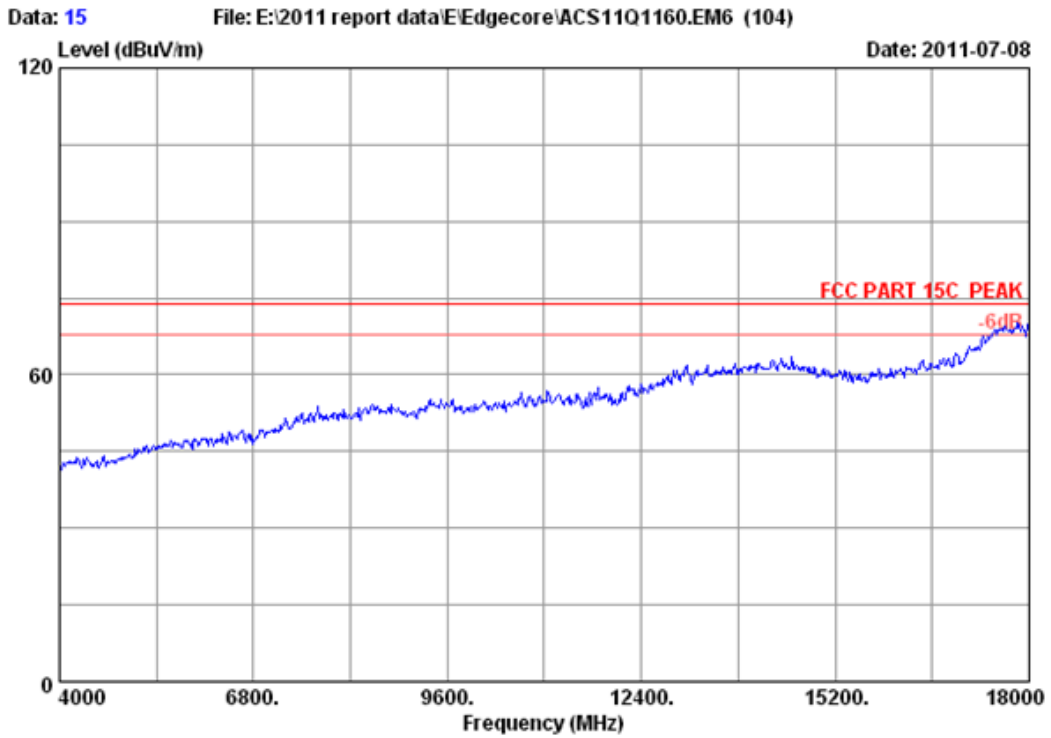

Site no. : 3m Chamber Data no. : 15
Dis. / Ant. : 3m 3115(0911) Ant. pol. : HORIZONTAL
Limit : FCC PART 15C PEAK
Env. / Ins. : 23°C/54% Engineer : Leo-Li
EUT : 150 Mbps 4-port Wireless Broadband Router
Power : DC 9V From Adapter input AC 120V/60Hz
Test mode : IEEE802.11b CH11 2462MHz Tx
M/N : SMCWBR14S-N5

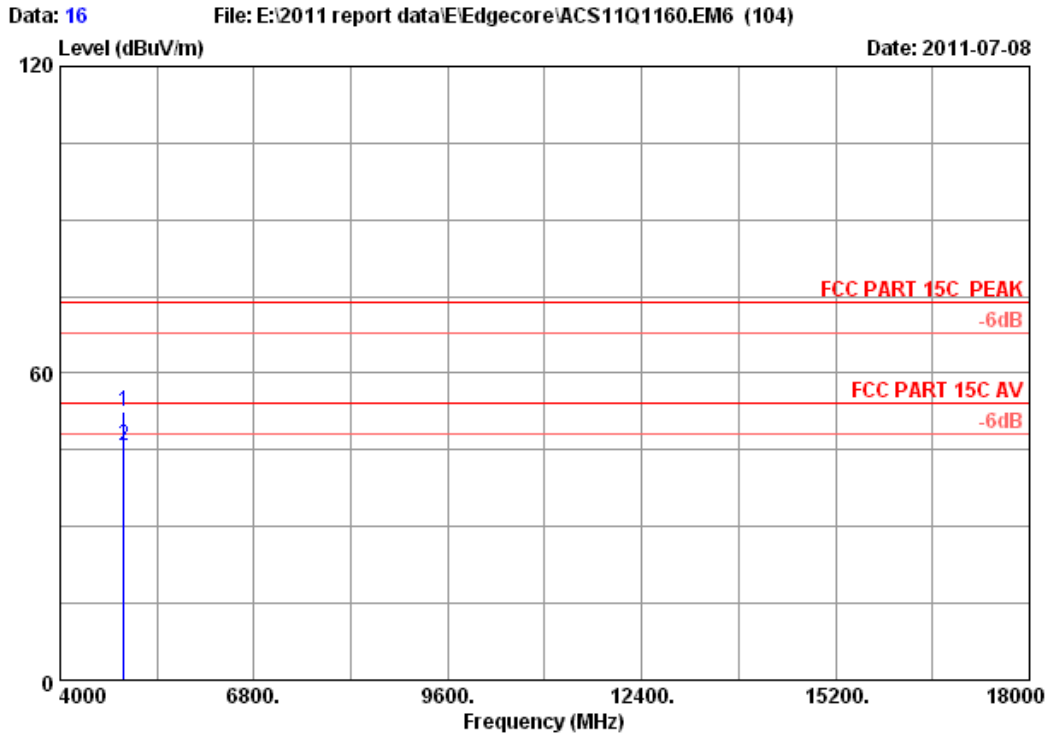

Site no. : 3m Chamber Data no. : 16
 Dis. / Ant. : 3m 3115(0911) Ant. pol. : HORIZONTAL
 Limit : FCC PART 15C PEAK
 Env. / Ins. : 23°C/54% Engineer : Leo-Li
 EUT : 150 Mbps 4-port Wireless Broadband Router
 Power : DC 9V From Adapter input AC 120V/60Hz
 Test mode : IEEE802.11b CH11 2462MHz Tx
 M/N : SMCWBR14S-N5

| | Ant. Freq. (MHz) | Ant. Factor (dB/m) | Cable loss (dB) | Amp. Factor (dB) | Reading (dBuV) | Emission Level (dBuV/m) | Limits (dBuV/m) | Margin (dB) | Remark |
|---|------------------|--------------------|-----------------|------------------|----------------|-------------------------|-----------------|-------------|---------|
| 1 | 4924.000 | 34.49 | 10.76 | 34.98 | 42.13 | 52.40 | 74.00 | 21.60 | Peak |
| 2 | 4924.000 | 34.49 | 10.76 | 34.98 | 35.42 | 45.69 | 54.00 | 8.31 | Average |

Remarks:

1. Emission Level= Antenna Factor + Cable Loss -Amp Factor + Reading.
2. The emission levels that are 20dB below the official limit are not reported.

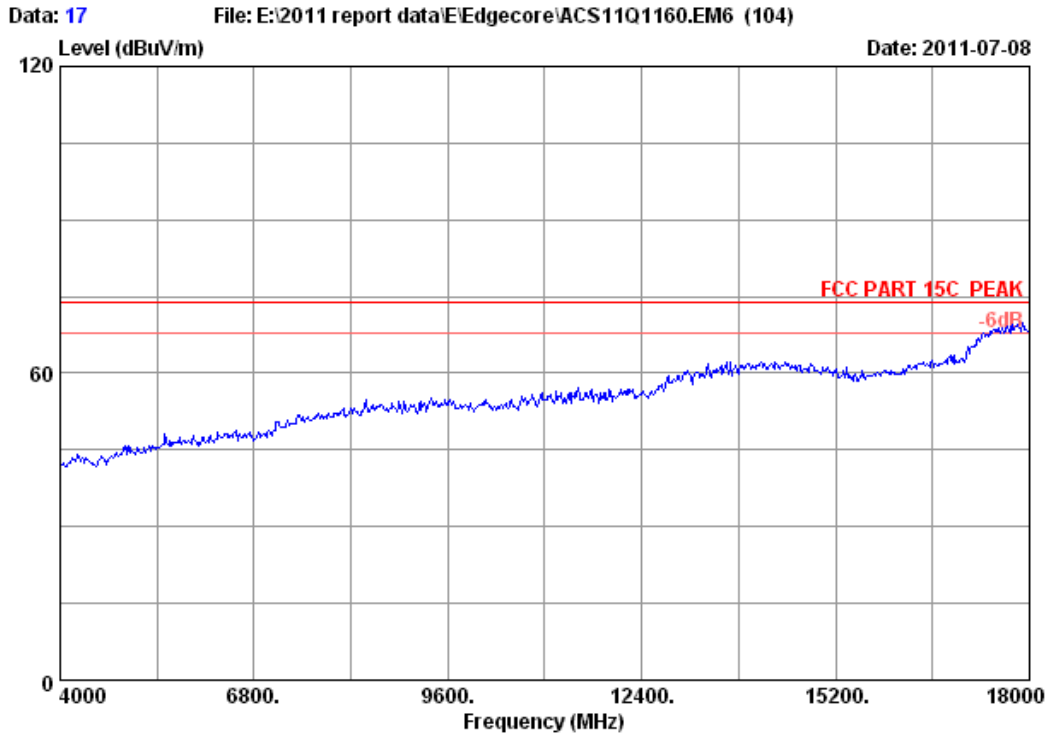

Site no. : 3m Chamber Data no. : 17
Dis. / Ant. : 3m 3115(0911) Ant. pol. : VERTICAL
Limit : FCC PART 15C PEAK
Env. / Ins. : 23°C/54% Engineer : Leo-Li
EUT : 150 Mbps 4-port Wireless Broadband Router
Power : DC 9V From Adapter input AC 120V/60Hz
Test mode : IEEE802.11b CH11 2462MHz Tx
M/N : SMCWBR14S-N5

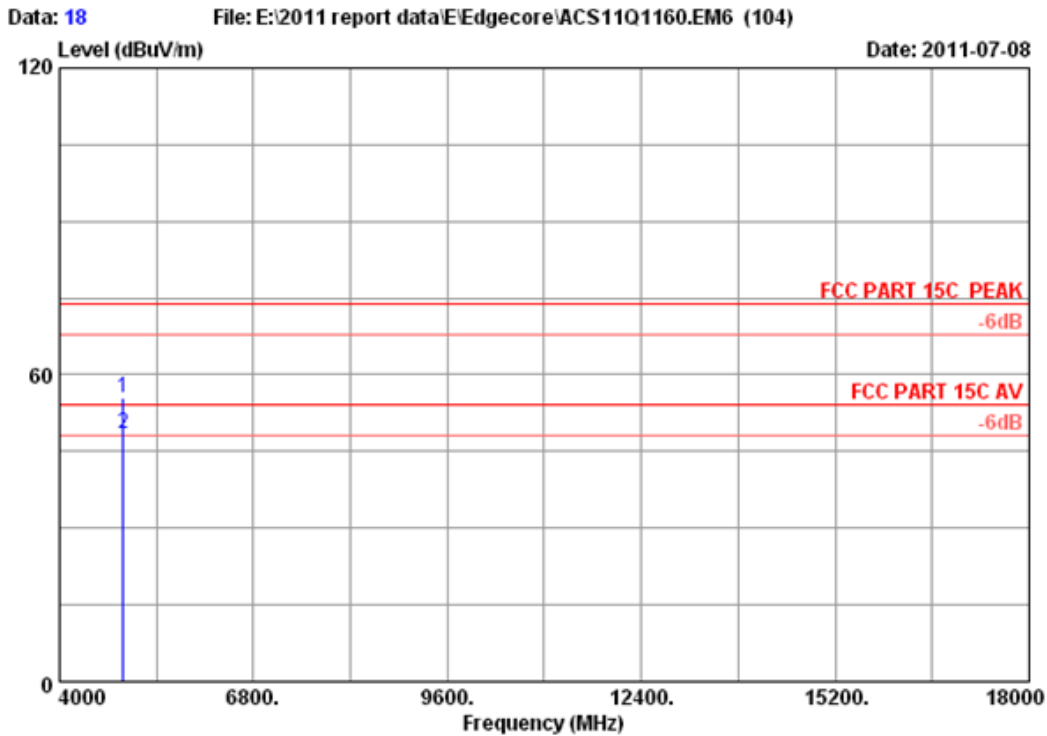

Site no. : 3m Chamber Data no. : 18
 Dis. / Ant. : 3m 3115(0911) Ant. pol. : VERTICAL
 Limit : FCC PART 15C PEAK
 Env. / Ins. : 23°C/54% Engineer : Leo-Li
 EUT : 150 Mbps 4-port Wireless Broadband Router
 Power : DC 9V From Adapter input AC 120V/60Hz
 Test mode : IEEE802.11b CH11 2462MHz Tx
 M/N : SMCWBR14S-N5

| | Freq. (MHz) | Ant. Factor (dB/m) | Cable loss (dB) | Amp. Factor (dB) | Reading (dBuV) | Emission Level (dBuV/m) | Limits (dBuV/m) | Margin (dB) | Remark |
|---|-------------|--------------------|-----------------|------------------|----------------|-------------------------|-----------------|-------------|---------|
| 1 | 4924.000 | 34.49 | 10.76 | 34.98 | 45.32 | 55.59 | 74.00 | 18.41 | Peak |
| 2 | 4924.000 | 34.49 | 10.76 | 34.98 | 38.14 | 48.41 | 54.00 | 5.59 | Average |

- Remarks:
- Emission Level= Antenna Factor + Cable Loss -Amp Factor + Reading.
 - The emission levels that are 20dB below the official limit are not reported.

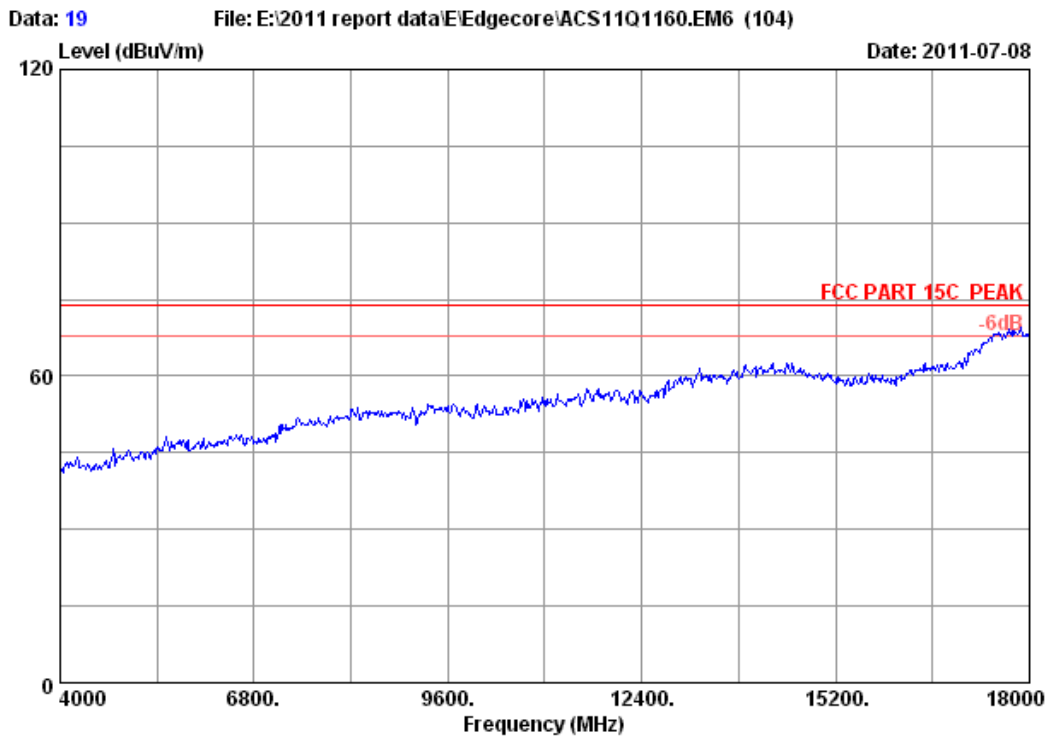

Site no. : 3m Chamber Data no. : 19
Dis. / Ant. : 3m 3115(0911) Ant. pol. : VERTICAL
Limit : FCC PART 15C PEAK
Env. / Ins. : 23°C/54% Engineer : Leo-Li
EUT : 150 Mbps 4-port Wireless Broadband Router
Power : DC 9V From Adapter input AC 120V/60Hz
Test mode : IEEE802.11g CH1 2412MHz Tx
M/N : SMCWBR14S-N5

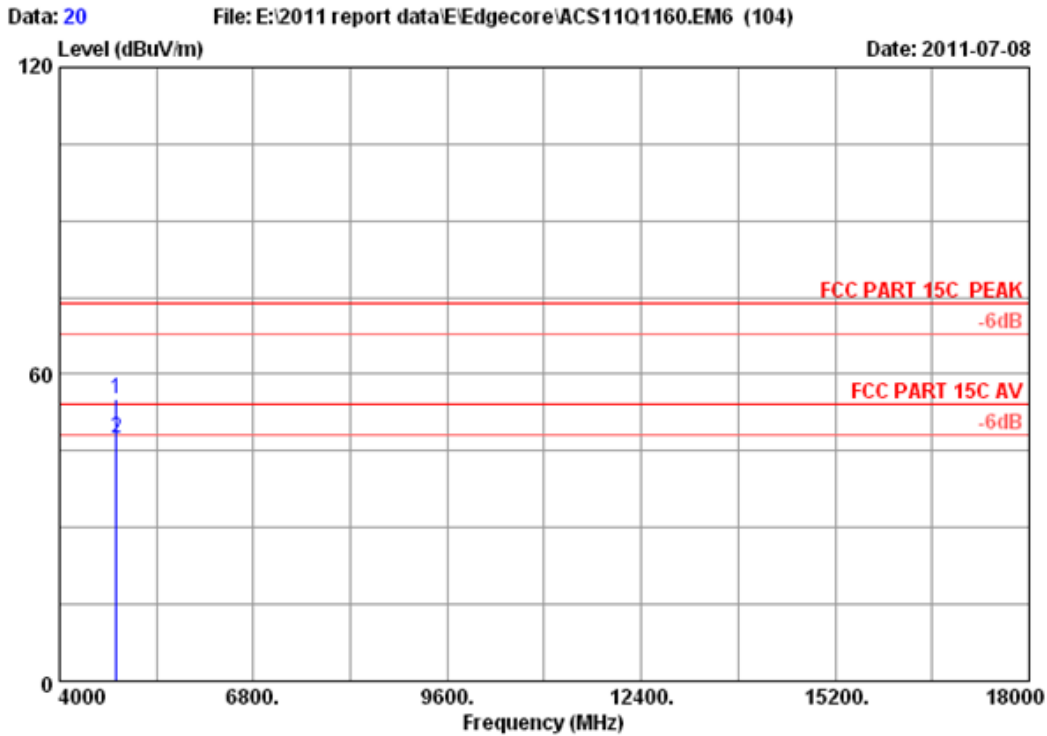

Site no. : 3m Chamber Data no. : 20
 Dis. / Ant. : 3m 3115(0911) Ant. pol. : VERTICAL
 Limit : FCC PART 15C PEAK
 Env. / Ins. : 23°C/54% Engineer : Leo-Li
 EUT : 150 Mbps 4-port Wireless Broadband Router
 Power : DC 9V From Adapter input AC 120V/60Hz
 Test mode : IEEE802.11g CH1 2412MHz Tx
 M/N : SMCWBR14S-N5

| | Ant. Freq. (MHz) | Ant. Factor (dB/m) | Cable loss (dB) | Amp. Factor (dB) | Reading (dBuV) | Emission Level (dBuV/m) | Limits (dBuV/m) | Margin (dB) | Remark |
|---|------------------|--------------------|-----------------|------------------|----------------|-------------------------|-----------------|-------------|---------|
| 1 | 4824.000 | 34.32 | 10.64 | 35.08 | 45.37 | 55.25 | 74.00 | 18.75 | Peak |
| 2 | 4824.000 | 34.32 | 10.64 | 35.08 | 37.43 | 47.31 | 54.00 | 6.69 | Average |

- Remarks:
1. Emission Level= Antenna Factor + Cable Loss -Amp Factor + Reading.
 2. The emission levels that are 20dB below the official limit are not reported.

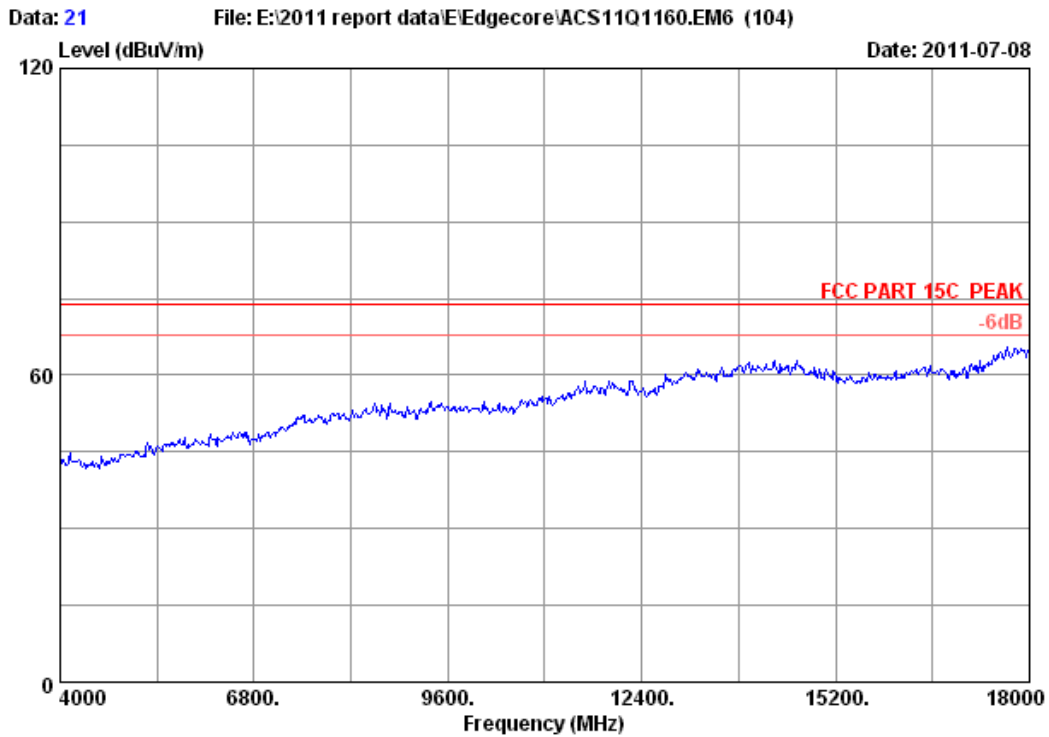

Site no. : 3m Chamber Data no. : 21
Dis. / Ant. : 3m 3115(0911) Ant. pol. : HORIZONTAL
Limit : FCC PART 15C PEAK
Env. / Ins. : 23°C/54% Engineer : Leo-Li
EUT : 150 Mbps 4-port Wireless Broadband Router
Power : DC 9V From Adapter input AC 120V/60Hz
Test mode : IEEE802.11g CH1 2412MHz Tx
M/N : SMCWBR14S-N5

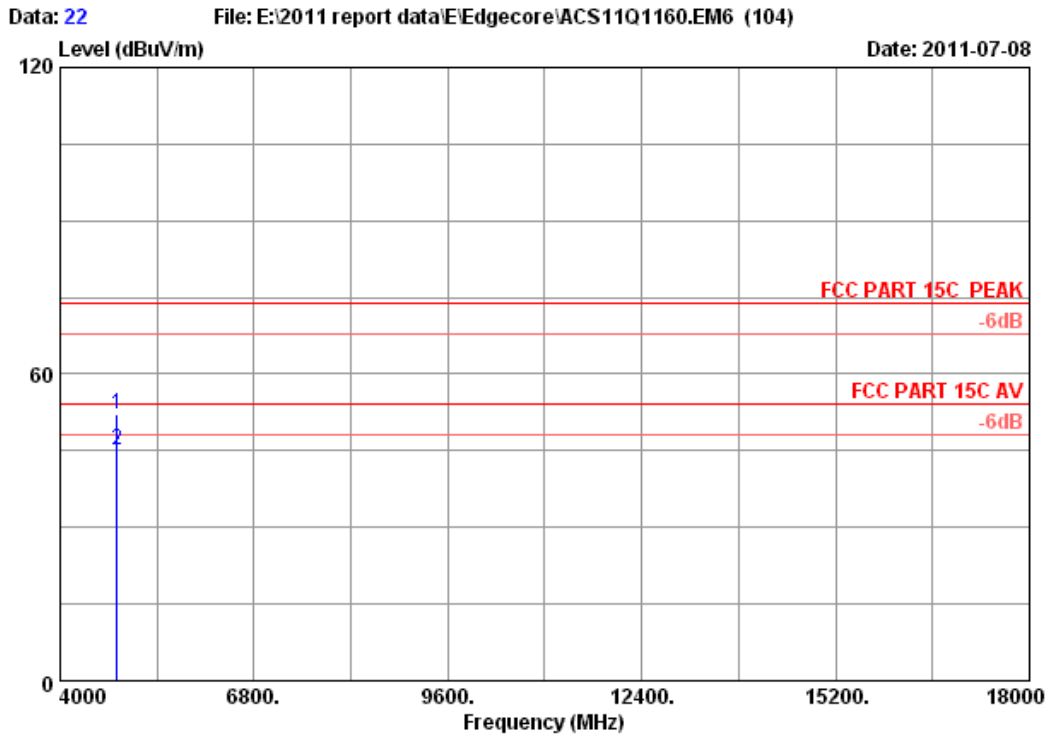

Site no. : 3m Chamber Data no. : 22
 Dis. / Ant. : 3m 3115(0911) Ant. pol. : HORIZONTAL
 Limit : FCC PART 15C PEAK
 Env. / Ins. : 23*C/54% Engineer : Leo-Li
 EUT : 150 Mbps 4-port Wireless Broadband Router
 Power : DC 9V From Adapter input AC 120V/60Hz
 Test mode : IEEE802.11g CH1 2412MHz Tx
 M/N : SMCWBR14S-N5

| | Freq. (MHz) | Ant. Factor (dB/m) | Cable loss (dB) | Amp. Factor (dB) | Reading (dBuV) | Emission Level (dBuV/m) | Limits (dBuV/m) | Margin (dB) | Remark |
|---|----------------|--------------------------|-----------------------|------------------------|-------------------|-------------------------------|--------------------|----------------|---------|
| 1 | 4824.000 | 34.32 | 10.64 | 35.08 | 42.37 | 52.25 | 74.00 | 21.75 | Peak |
| 2 | 4824.000 | 34.32 | 10.64 | 35.08 | 35.28 | 45.16 | 54.00 | 8.84 | Average |

Remarks:
 1. Emission Level= Antenna Factor + Cable Loss -Amp Factor + Reading.
 2. The emission levels that are 20dB below the official limit are not reported.

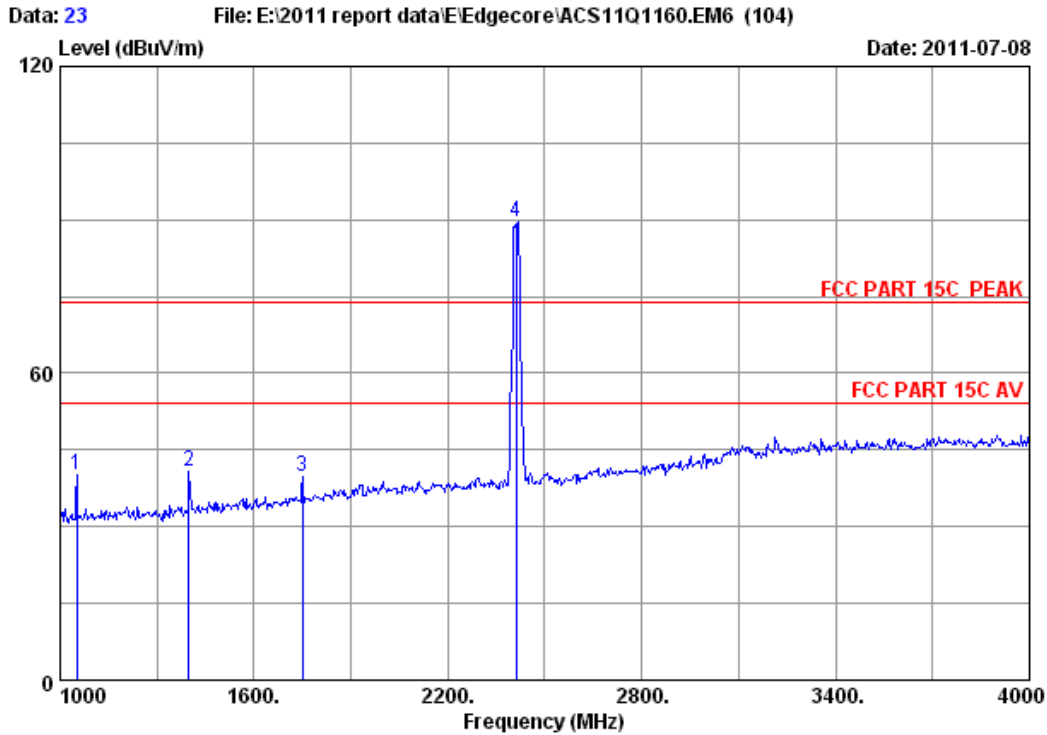

Site no. : 3m Chamber Data no. : 23
 Dis. / Ant. : 3m 3115(0911) Ant. pol. : HORIZONTAL
 Limit : FCC PART 15C PEAK
 Env. / Ins. : 23°C/54% Engineer : Leo-Li
 EUT : 150 Mbps 4-port Wireless Broadband Router
 Power : DC 9V From Adapter input AC 120V/60Hz
 Test mode : IEEE802.11g CH1 2412MHz Tx
 M/N : SMCWBR14S-N5

| | Ant. Freq. (MHz) | Ant. Factor (dB/m) | Cable loss (dB) | Amp. Factor (dB) | Reading (dBuV) | Emission Level (dBuV/m) | Limits (dBuV/m) | Margin (dB) | Remark |
|---|------------------|--------------------|-----------------|------------------|----------------|-------------------------|-----------------|-------------|--------|
| 1 | 1051.000 | 25.50 | 4.86 | 37.81 | 47.59 | 40.14 | 74.00 | 33.86 | Peak |
| 2 | 1399.000 | 26.19 | 5.50 | 37.18 | 46.40 | 40.91 | 74.00 | 33.09 | Peak |
| 3 | 1750.000 | 27.80 | 6.18 | 36.86 | 42.54 | 39.66 | 74.00 | 34.34 | Peak |
| 4 | 2412.000 | 29.45 | 7.43 | 36.62 | 89.33 | 89.59 | 74.00 | -15.59 | Peak |

Remarks:

1. Emission Level= Antenna Factor + Cable Loss -Amp Factor + Reading.
2. The emission levels that are 20dB below the official limit are not reported.

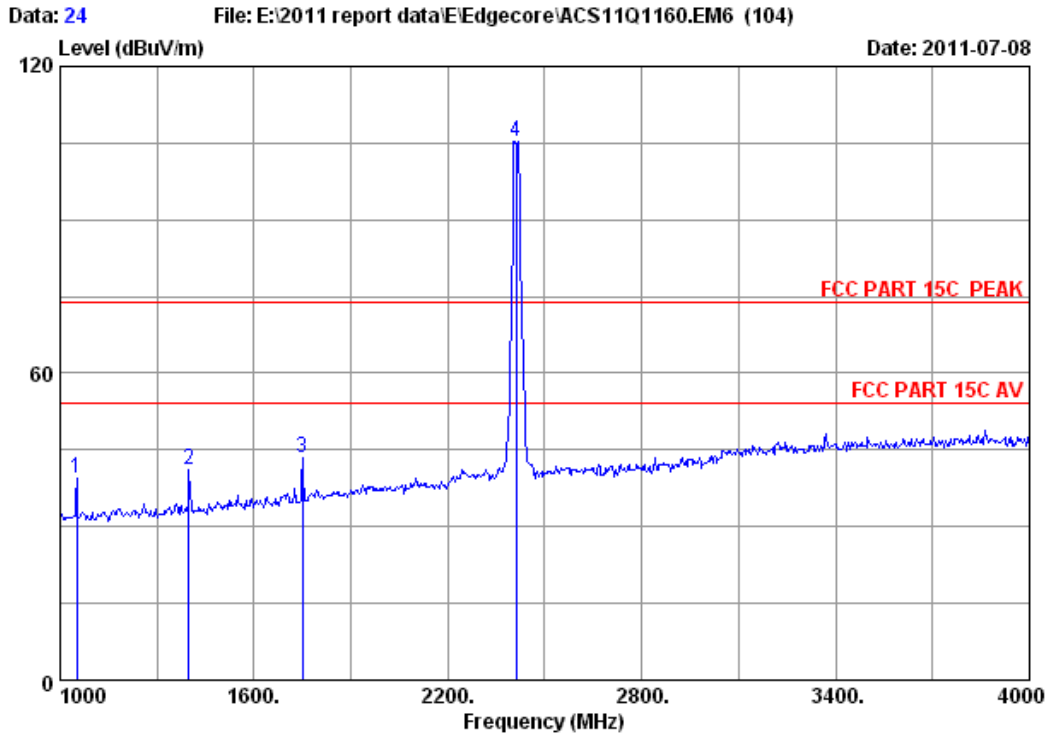

Site no. : 3m Chamber Data no. : 24
 Dis. / Ant. : 3m 3115(0911) Ant. pol. : VERTICAL
 Limit : FCC PART 15C PEAK
 Env. / Ins. : 23°C/54% Engineer : Leo-Li
 EUT : 150 Mbps 4-port Wireless Broadband Router
 Power : DC 9V From Adapter input AC 120V/60Hz
 Test mode : IEEE802.11g CH1 2412MHz Tx
 M/N : SMCWBR14S-N5

| | Ant. Freq. (MHz) | Ant. Factor (dB/m) | Cable loss (dB) | Amp. Factor (dB) | Reading (dBuV) | Emission Level (dBuV/m) | Limits (dBuV/m) | Margin (dB) | Remark |
|---|------------------|--------------------|-----------------|------------------|----------------|-------------------------|-----------------|-------------|--------|
| 1 | 1051.000 | 25.50 | 4.86 | 37.81 | 46.80 | 39.35 | 74.00 | 34.65 | Peak |
| 2 | 1399.000 | 26.19 | 5.50 | 37.18 | 46.61 | 41.12 | 74.00 | 32.88 | Peak |
| 3 | 1750.000 | 27.80 | 6.18 | 36.86 | 46.33 | 43.45 | 74.00 | 30.55 | Peak |
| 4 | 2412.000 | 29.45 | 7.43 | 36.62 | 105.16 | 105.42 | 74.00 | -31.42 | Peak |

Remarks:

1. Emission Level= Antenna Factor + Cable Loss -Amp Factor + Reading.
2. The emission levels that are 20dB below the official limit are not reported.

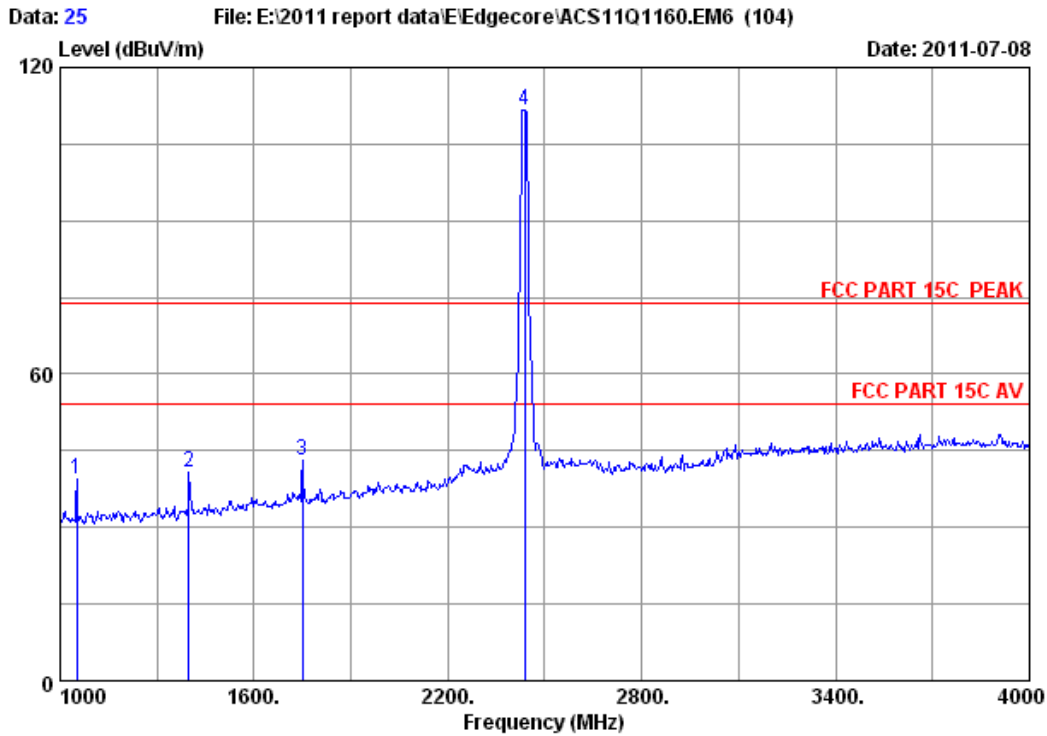

Site no. : 3m Chamber Data no. : 25
 Dis. / Ant. : 3m 3115(0911) Ant. pol. : VERTICAL
 Limit : FCC PART 15C PEAK
 Env. / Ins. : 23°C/54% Engineer : Leo-Li
 EUT : 150 Mbps 4-port Wireless Broadband Router
 Power : DC 9V From Adapter input AC 120V/60Hz
 Test mode : IEEE802.11g CH6 2437MHz Tx
 M/N : SMCWBR14S-N5

| | Ant. Freq. (MHz) | Ant. Factor (dB/m) | Cable loss (dB) | Amp. Factor (dB) | Reading (dBuV) | Emission Level (dBuV/m) | Limits (dBuV/m) | Margin (dB) | Remark |
|---|------------------|--------------------|-----------------|------------------|----------------|-------------------------|-----------------|-------------|--------|
| 1 | 1051.000 | 25.50 | 4.86 | 37.81 | 46.81 | 39.36 | 74.00 | 34.64 | Peak |
| 2 | 1399.000 | 26.19 | 5.50 | 37.18 | 46.38 | 40.89 | 74.00 | 33.11 | Peak |
| 3 | 1750.000 | 27.80 | 6.18 | 36.86 | 46.04 | 43.16 | 74.00 | 30.84 | Peak |
| 4 | 2437.000 | 29.47 | 7.46 | 36.61 | 111.35 | 111.67 | 74.00 | -37.67 | Peak |

Remarks:

1. Emission Level= Antenna Factor + Cable Loss -Amp Factor + Reading.
2. The emission levels that are 20dB below the official limit are not reported.

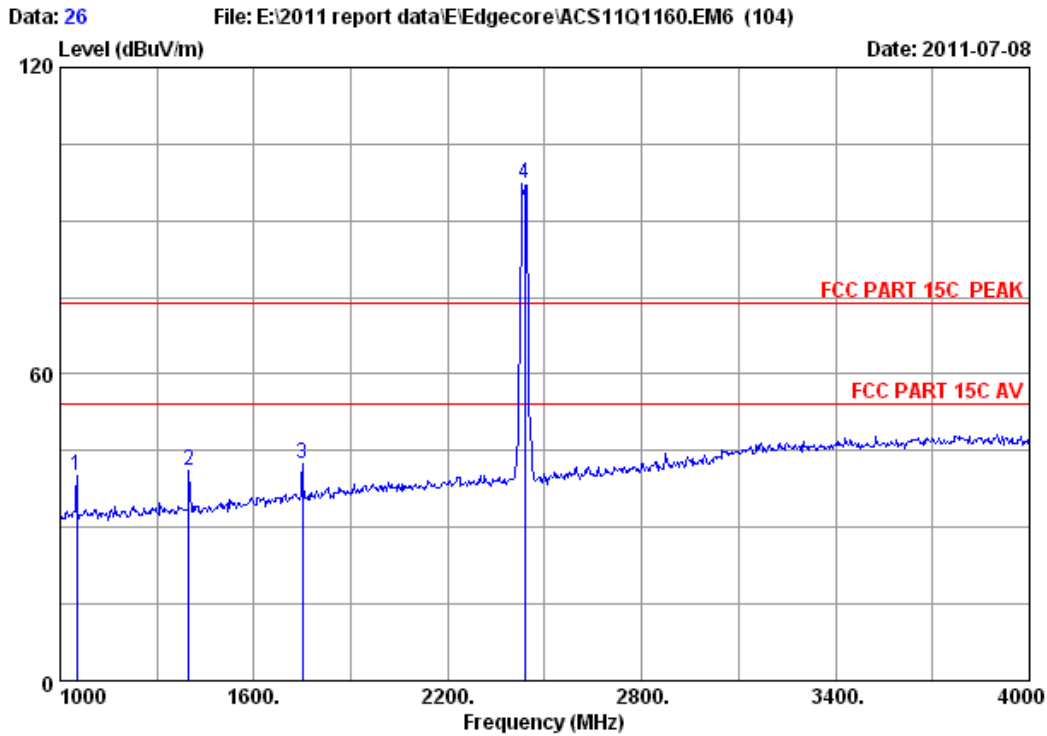

Site no. : 3m Chamber Data no. : 26
 Dis. / Ant. : 3m 3115(0911) Ant. pol. : HORIZONTAL
 Limit : FCC PART 15C PEAK
 Env. / Ins. : 23*C/54% Engineer : Leo-Li
 EUT : 150 Mbps 4-port Wireless Broadband Router
 Power : DC 9V From Adapter input AC 120V/60Hz
 Test mode : IEEE802.11g CH6 2437MHz Tx
 M/N : SMCWBR14S-N5

| | Ant. Freq. (MHz) | Ant. Factor (dB/m) | Cable loss (dB) | Amp. Factor (dB) | Reading (dBuV) | Emission Level (dBuV/m) | Limits (dBuV/m) | Margin (dB) | Remark |
|---|------------------|--------------------|-----------------|------------------|----------------|-------------------------|-----------------|-------------|--------|
| 1 | 1051.000 | 25.50 | 4.86 | 37.81 | 47.65 | 40.20 | 74.00 | 33.80 | Peak |
| 2 | 1399.000 | 26.19 | 5.50 | 37.18 | 46.69 | 41.20 | 74.00 | 32.80 | Peak |
| 3 | 1750.000 | 27.80 | 6.18 | 36.86 | 45.23 | 42.35 | 74.00 | 31.65 | Peak |
| 4 | 2437.000 | 29.47 | 7.46 | 36.61 | 96.98 | 97.30 | 74.00 | -23.30 | Peak |

Remarks:

1. Emission Level= Antenna Factor + Cable Loss -Amp Factor + Reading.
2. The emission levels that are 20dB below the official limit are not reported.

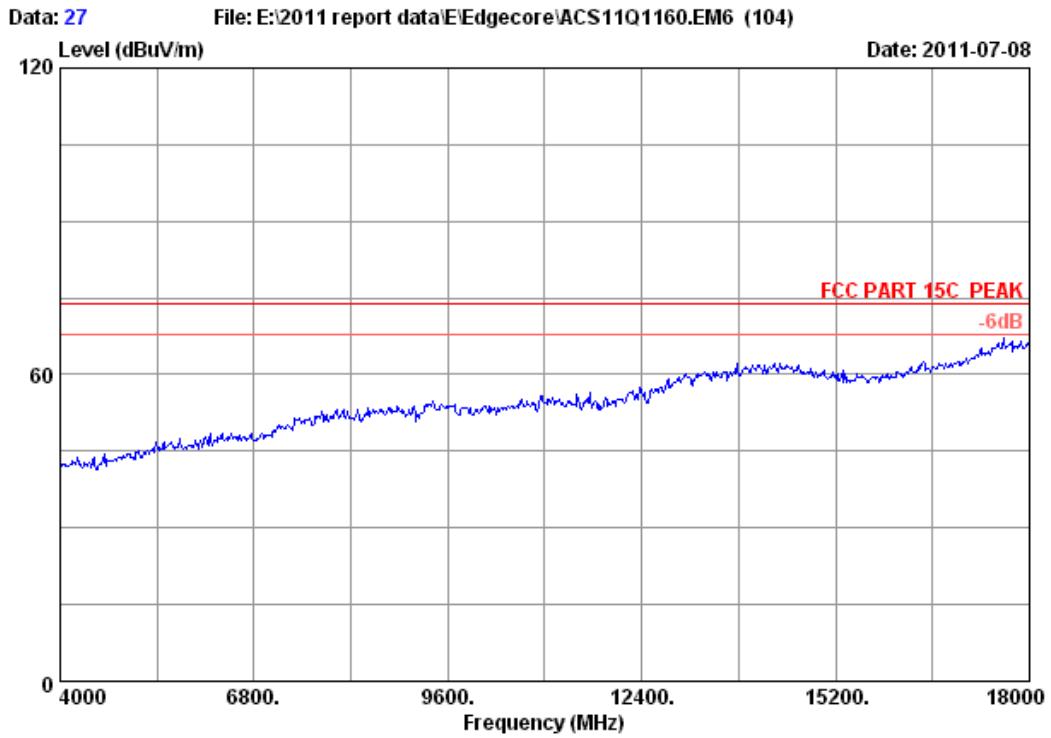

Site no. : 3m Chamber Data no. : 27
Dis. / Ant. : 3m 3115(0911) Ant. pol. : HORIZONTAL
Limit : FCC PART 15C PEAK
Env. / Ins. : 23°C/54% Engineer : Leo-Li
EUT : 150 Mbps 4-port Wireless Broadband Router
Power : DC 9V From Adapter input AC 120V/60Hz
Test mode : IEEE802.11g CH6 2437MHz Tx
M/N : SMCWBR14S-N5

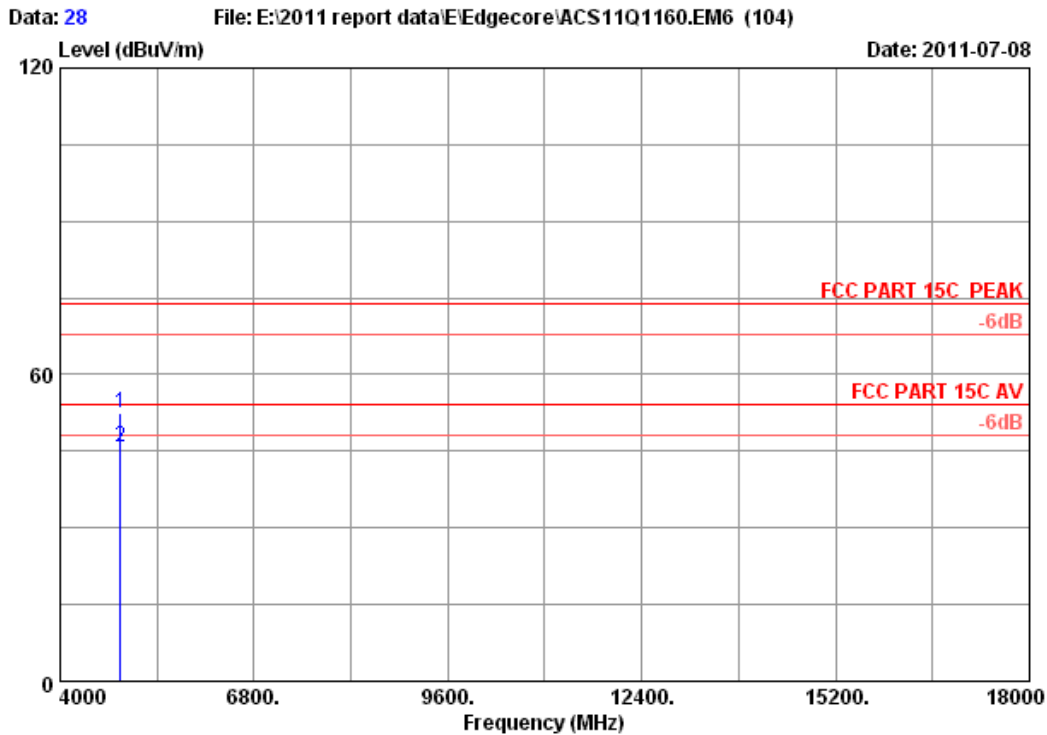

Site no. : 3m Chamber Data no. : 28
 Dis. / Ant. : 3m 3115(0911) Ant. pol. : HORIZONTAL
 Limit : FCC PART 15C PEAK
 Env. / Ins. : 23°C/54% Engineer : Leo-Li
 EUT : 150 Mbps 4-port Wireless Broadband Router
 Power : DC 9V From Adapter input AC 120V/60Hz
 Test mode : IEEE802.11g CH6 2437MHz Tx
 M/N : SMCWBR14S-N5

| | Ant. | Cable | Amp. | Emission | | | | | |
|-------|----------|-------|--------|----------|----------|----------|--------|--------|---------|
| Freq. | Factor | loss | Factor | Reading | Level | Limits | Margin | Remark | |
| (MHz) | (dB/m) | (dB) | (dB) | (dBuV) | (dBuV/m) | (dBuV/m) | (dB) | | |
| 1 | 4874.000 | 34.41 | 10.69 | 35.03 | 42.56 | 52.63 | 74.00 | 21.37 | Peak |
| 2 | 4874.000 | 34.41 | 10.69 | 35.03 | 35.84 | 45.91 | 54.00 | 8.09 | Average |

Remarks:

1. Emission Level= Antenna Factor + Cable Loss -Amp Factor + Reading.
2. The emission levels that are 20dB below the official limit are not reported.

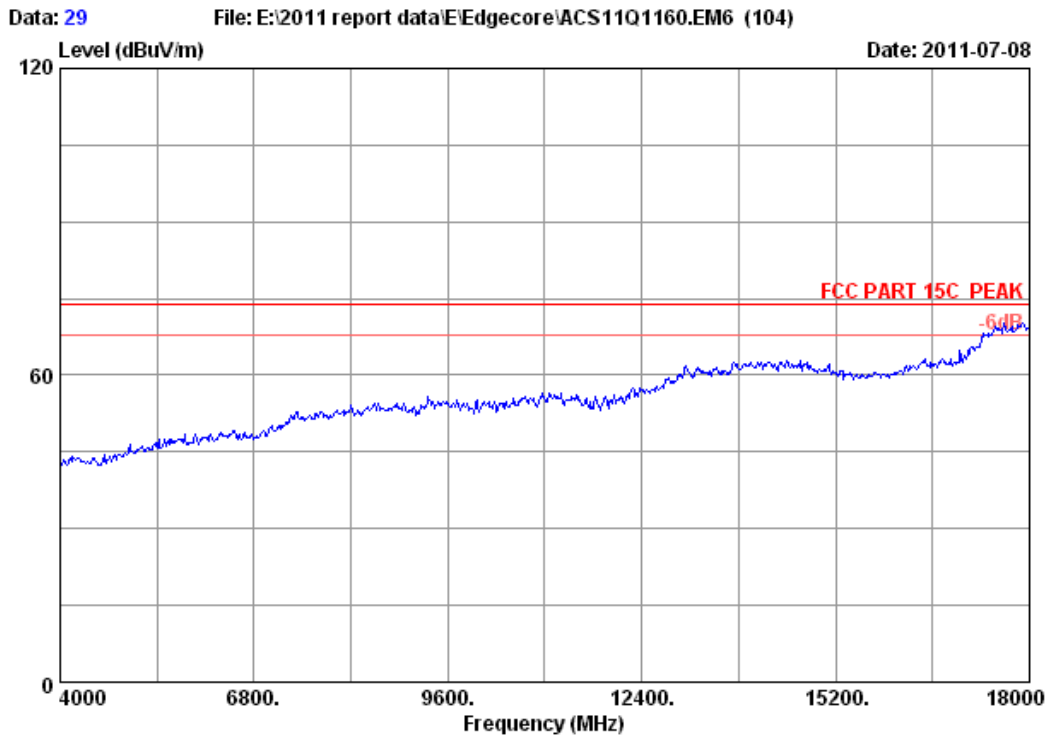

Site no. : 3m Chamber Data no. : 29
Dis. / Ant. : 3m 3115(0911) Ant. pol. : VERTICAL
Limit : FCC PART 15C PEAK
Env. / Ins. : 23°C/54% Engineer : Leo-Li
EUT : 150 Mbps 4-port Wireless Broadband Router
Power : DC 9V From Adapter input AC 120V/60Hz
Test mode : IEEE802.11g CH6 2437MHz Tx
M/N : SMCWBR14S-N5

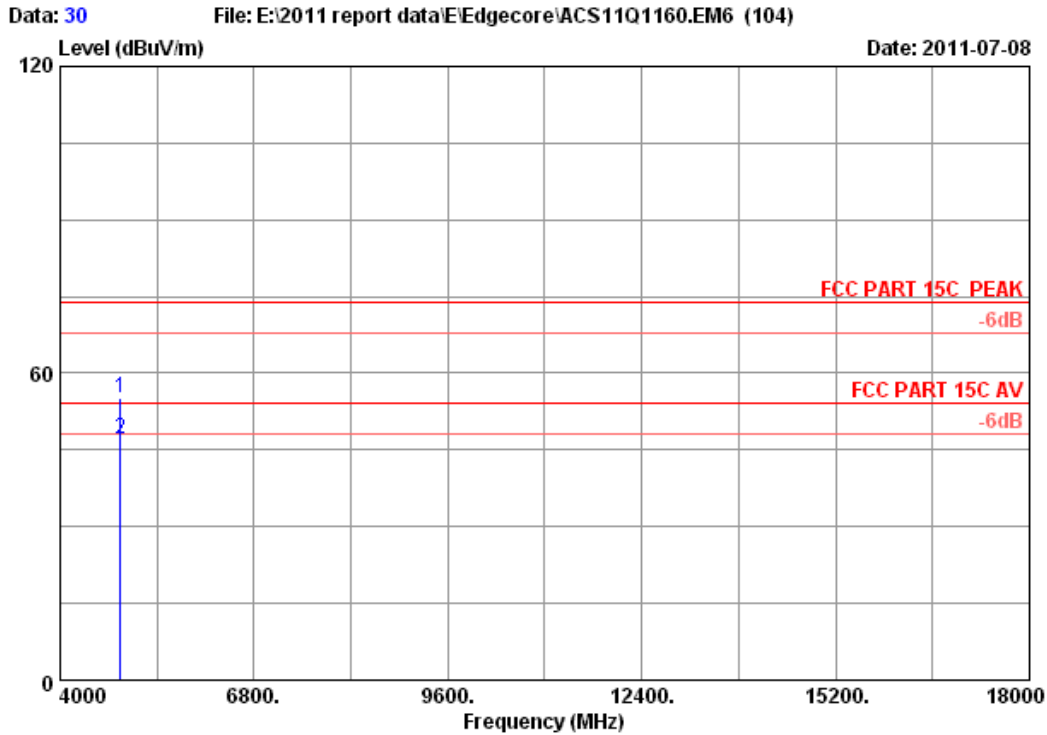

Site no. : 3m Chamber Data no. : 30
 Dis. / Ant. : 3m 3115(0911) Ant. pol. : VERTICAL
 Limit : FCC PART 15C PEAK
 Env. / Ins. : 23°C/54% Engineer : Leo-Li
 EUT : 150 Mbps 4-port Wireless Broadband Router
 Power : DC 9V From Adapter input AC 120V/60Hz
 Test mode : IEEE802.11g CH6 2437MHz Tx
 M/N : SMCWBR14S-N5

| | Ant. Freq. (MHz) | Ant. Factor (dB/m) | Cable loss (dB) | Amp. Factor (dB) | Reading (dBuV) | Emission Level (dBuV/m) | Limits (dBuV/m) | Margin (dB) | Remark |
|---|------------------|--------------------|-----------------|------------------|----------------|-------------------------|-----------------|-------------|---------|
| 1 | 4874.000 | 34.41 | 10.69 | 35.03 | 45.23 | 55.30 | 74.00 | 18.70 | Peak |
| 2 | 4874.000 | 34.41 | 10.69 | 35.03 | 36.98 | 47.05 | 54.00 | 6.95 | Average |

Remarks:

1. Emission Level= Antenna Factor + Cable Loss -Amp Factor + Reading.
2. The emission levels that are 20dB below the official limit are not reported.

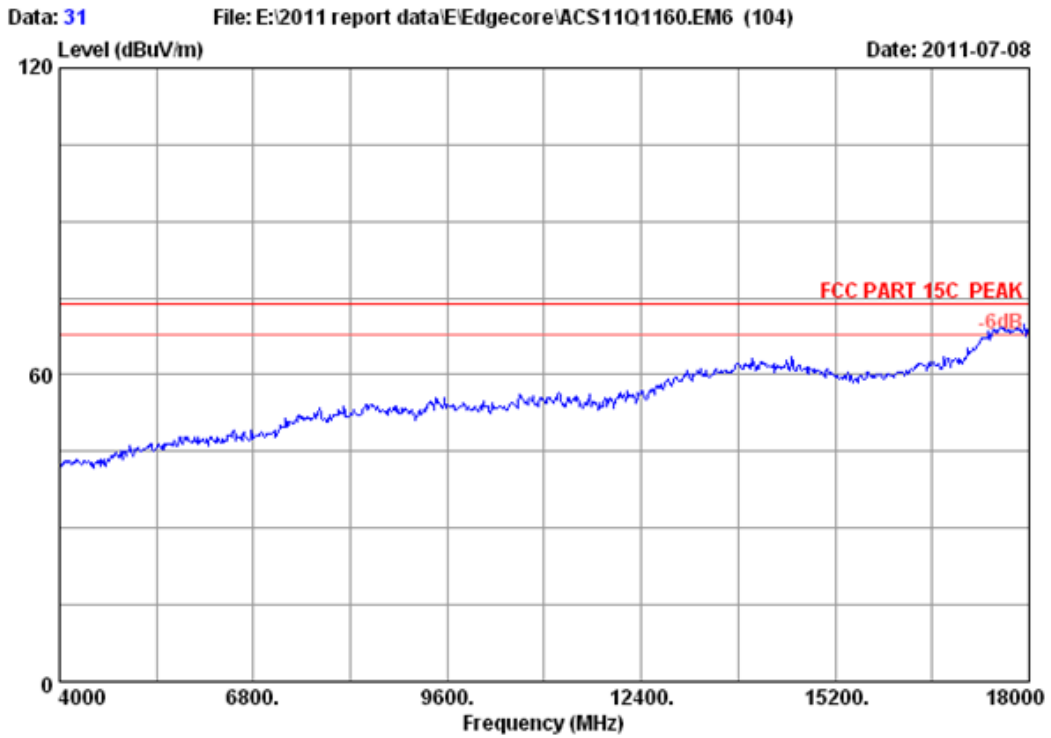

Site no. : 3m Chamber Data no. : 31
Dis. / Ant. : 3m 3115(0911) Ant. pol. : VERTICAL
Limit : FCC PART 15C PEAK
Env. / Ins. : 23°C/54% Engineer : Leo-Li
EUT : 150 Mbps 4-port Wireless Broadband Router
Power : DC 9V From Adapter input AC 120V/60Hz
Test mode : IEEE802.11g CH11 2462MHz Tx
M/N : SMCWBR14S-N5

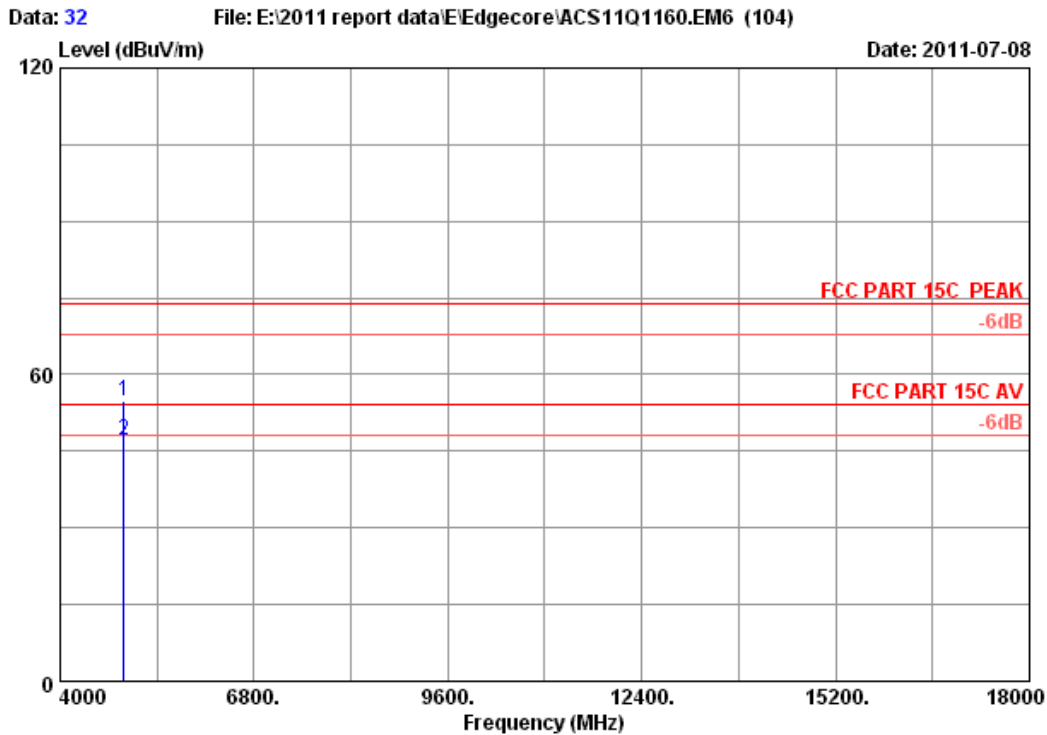

Site no. : 3m Chamber Data no. : 32
 Dis. / Ant. : 3m 3115(0911) Ant. pol. : VERTICAL
 Limit : FCC PART 15C PEAK
 Env. / Ins. : 23°C/54% Engineer : Leo-Li
 EUT : 150 Mbps 4-port Wireless Broadband Router
 Power : DC 9V From Adapter input AC 120V/60Hz
 Test mode : IEEE802.11g CH11 2462MHz Tx
 M/N : SMCWBR14S-N5

| | Ant. Freq. (MHz) | Ant. Factor (dB/m) | Cable loss (dB) | Amp. Factor (dB) | Reading (dBuV) | Emission Level (dBuV/m) | Limits (dBuV/m) | Margin (dB) | Remark |
|---|------------------|--------------------|-----------------|------------------|----------------|-------------------------|-----------------|-------------|---------|
| 1 | 4924.000 | 34.49 | 10.76 | 34.98 | 44.62 | 54.89 | 74.00 | 19.11 | Peak |
| 2 | 4924.000 | 34.49 | 10.76 | 34.98 | 36.87 | 47.14 | 54.00 | 6.86 | Average |

Remarks:

1. Emission Level= Antenna Factor + Cable Loss - Amp Factor + Reading.
2. The emission levels that are 20dB below the official limit are not reported.

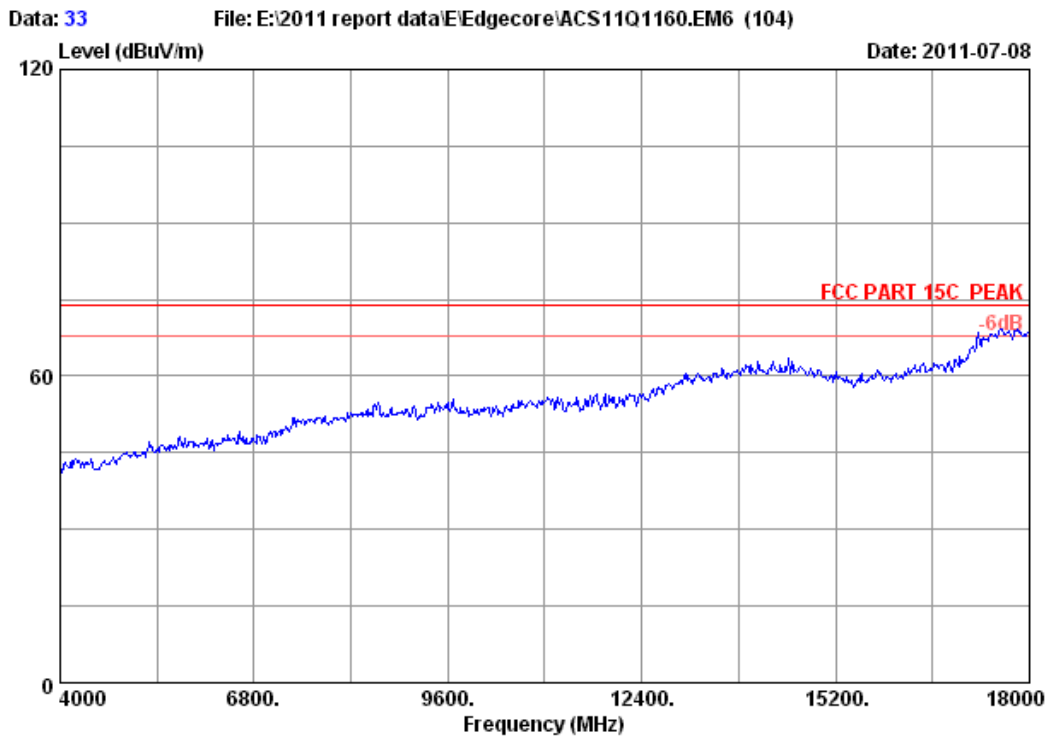

Site no. : 3m Chamber Data no. : 33
Dis. / Ant. : 3m 3115(0911) Ant. pol. : HORIZONTAL
Limit : FCC PART 15C PEAK
Env. / Ins. : 23°C/54% Engineer : Leo-Li
EUT : 150 Mbps 4-port Wireless Broadband Router
Power : DC 9V From Adapter input AC 120V/60Hz
Test mode : IEEE802.11g CH11 2462MHz Tx
M/N : SMCWBR14S-N5

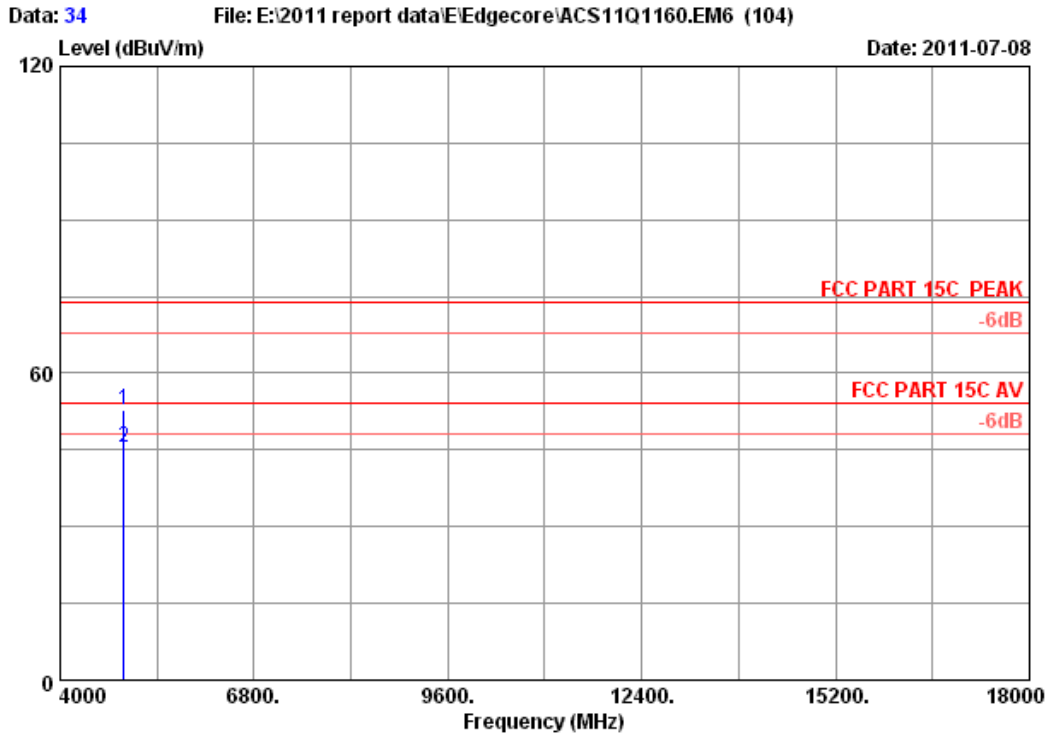

Site no. : 3m Chamber Data no. : 34
 Dis. / Ant. : 3m 3115(0911) Ant. pol. : HORIZONTAL
 Limit : FCC PART 15C PEAK
 Env. / Ins. : 23°C/54% Engineer : Leo-Li
 EUT : 150 Mbps 4-port Wireless Broadband Router
 Power : DC 9V From Adapter input AC 120V/60Hz
 Test mode : IEEE802.11g CH11 2462MHz Tx
 M/N : SMCWBR14S-N5

| | Ant. Freq. (MHz) | Ant. Factor (dB/m) | Cable loss (dB) | Amp. Factor (dB) | Reading (dBuV) | Emission Level (dBuV/m) | Limits (dBuV/m) | Margin (dB) | Remark |
|---|------------------|--------------------|-----------------|------------------|----------------|-------------------------|-----------------|-------------|---------|
| 1 | 4924.000 | 34.49 | 10.76 | 34.98 | 42.68 | 52.95 | 74.00 | 21.05 | Peak |
| 2 | 4924.000 | 34.49 | 10.76 | 34.98 | 35.27 | 45.54 | 54.00 | 8.46 | Average |

Remarks:

1. Emission Level= Antenna Factor + Cable Loss -Amp Factor + Reading.
2. The emission levels that are 20dB below the official limit are not reported.

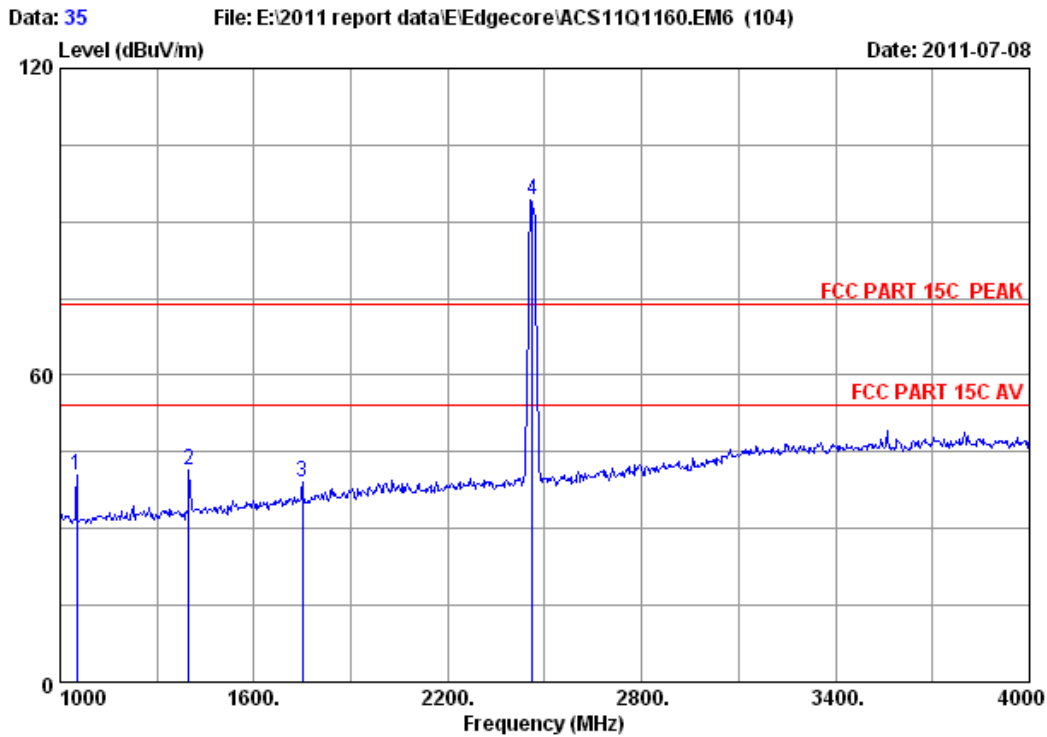

Site no. : 3m Chamber Data no. : 35
 Dis. / Ant. : 3m 3115(0911) Ant. pol. : HORIZONTAL
 Limit : FCC PART 15C PEAK
 Env. / Ins. : 23°C/54% Engineer : Leo-Li
 EUT : 150 Mbps 4-port Wireless Broadband Router
 Power : DC 9V From Adapter input AC 120V/60Hz
 Test mode : IEEE802.11g CH11 2462MHz Tx
 M/N : SMCWBR14S-N5

| | Ant. Freq. (MHz) | Ant. Factor (dB/m) | Cable loss (dB) | Amp. Factor (dB) | Reading (dBuV) | Emission Level (dBuV/m) | Limits (dBuV/m) | Margin (dB) | Remark |
|---|------------------|--------------------|-----------------|------------------|----------------|-------------------------|-----------------|-------------|--------|
| 1 | 1051.000 | 25.50 | 4.86 | 37.81 | 48.01 | 40.56 | 74.00 | 33.44 | Peak |
| 2 | 1399.000 | 26.19 | 5.50 | 37.18 | 46.79 | 41.30 | 74.00 | 32.70 | Peak |
| 3 | 1750.000 | 27.80 | 6.18 | 36.86 | 41.90 | 39.02 | 74.00 | 34.98 | Peak |
| 4 | 2462.000 | 29.48 | 7.54 | 36.61 | 93.77 | 94.18 | 74.00 | -20.18 | Peak |

Remarks:

1. Emission Level= Antenna Factor + Cable Loss -Amp Factor + Reading.
2. The emission levels that are 20dB below the official limit are not reported.

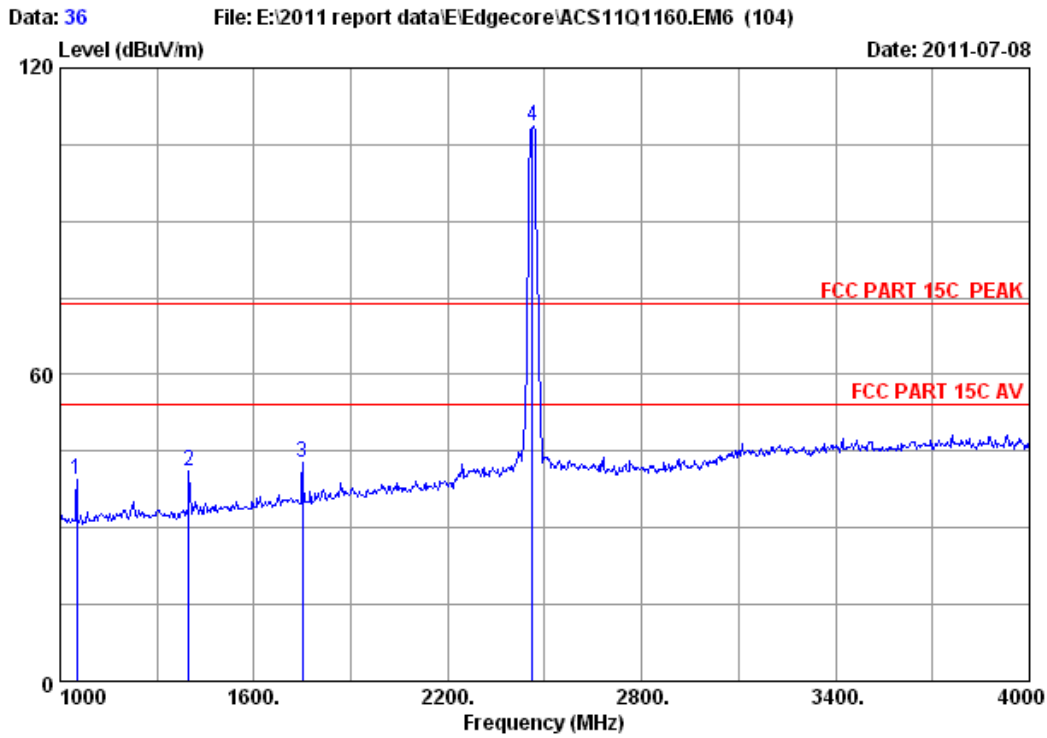

Site no. : 3m Chamber Data no. : 36
 Dis. / Ant. : 3m 3115(0911) Ant. pol. : VERTICAL
 Limit : FCC PART 15C PEAK
 Env. / Ins. : 23°C/54% Engineer : Leo-Li
 EUT : 150 Mbps 4-port Wireless Broadband Router
 Power : DC 9V From Adapter input AC 120V/60Hz
 Test mode : IEEE802.11g CH11 2462MHz Tx
 M/N : SMCWBR14S-N5

| | Ant. Freq. (MHz) | Ant. Factor (dB/m) | Cable loss (dB) | Amp. Factor (dB) | Reading (dBuV) | Emission Level (dBuV/m) | Limits (dBuV/m) | Margin (dB) | Remark |
|---|------------------|--------------------|-----------------|------------------|----------------|-------------------------|-----------------|-------------|--------|
| 1 | 1051.000 | 25.50 | 4.86 | 37.81 | 46.87 | 39.42 | 74.00 | 34.58 | Peak |
| 2 | 1399.000 | 26.19 | 5.50 | 37.18 | 46.70 | 41.21 | 74.00 | 32.79 | Peak |
| 3 | 1750.000 | 27.80 | 6.18 | 36.86 | 45.69 | 42.81 | 74.00 | 31.19 | Peak |
| 4 | 2462.000 | 29.48 | 7.54 | 36.61 | 108.07 | 108.48 | 74.00 | -34.48 | Peak |

Remarks:

1. Emission Level= Antenna Factor + Cable Loss -Amp Factor + Reading.
2. The emission levels that are 20dB below the official limit are not reported.

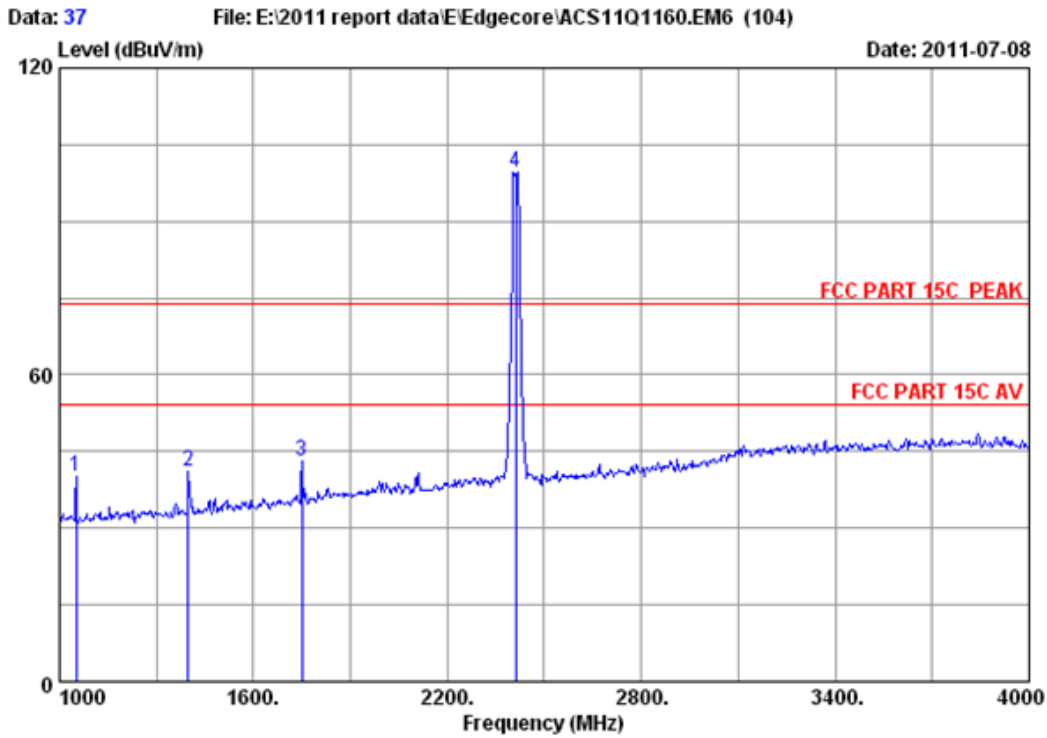

Site no. : 3m Chamber Data no. : 37
 Dis. / Ant. : 3m 3115(0911) Ant. pol. : VERTICAL
 Limit : FCC PART 15C PEAK
 Env. / Ins. : 23°C/54% Engineer : Leo-Li
 EUT : 150 Mbps 4-port Wireless Broadband Router
 Power : DC 9V From Adapter input AC 120V/60Hz
 Test mode : IEEE802.11nHT20 CH1 2412MHz Tx
 M/N : SMCWBR14S-N5

| | Freq. (MHz) | Ant. Factor (dB/m) | Cable loss (dB) | Amp. Factor (dB) | Reading (dBUV) | Emission Level (dBUV/m) | Limits (dBUV/m) | Margin (dB) | Remark |
|---|-------------|--------------------|-----------------|------------------|----------------|-------------------------|-----------------|-------------|--------|
| 1 | 1051.000 | 25.50 | 4.86 | 37.81 | 47.43 | 39.98 | 74.00 | 34.02 | Peak |
| 2 | 1399.000 | 26.19 | 5.50 | 37.18 | 46.74 | 41.25 | 74.00 | 32.75 | Peak |
| 3 | 1750.000 | 27.80 | 6.18 | 36.86 | 45.94 | 43.06 | 74.00 | 30.94 | Peak |
| 4 | 2412.000 | 29.45 | 7.43 | 36.62 | 99.39 | 99.65 | 74.00 | -25.65 | Peak |

Remarks:

1. Emission Level= Antenna Factor + Cable Loss -Amp Factor + Reading.
2. The emission levels that are 20dB below the official limit are not reported.

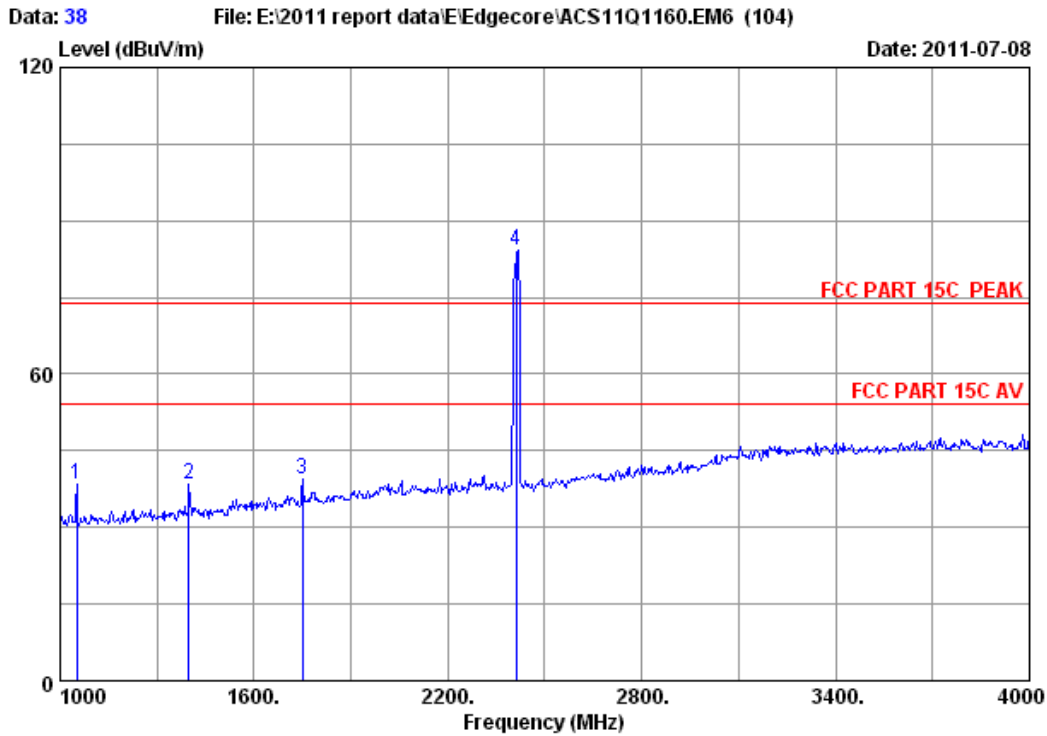

Site no. : 3m Chamber Data no. : 38
 Dis. / Ant. : 3m 3115(0911) Ant. pol. : HORIZONTAL
 Limit : FCC PART 15C PEAK
 Env. / Ins. : 23°C/54% Engineer : Leo-Li
 EUT : 150 Mbps 4-port Wireless Broadband Router
 Power : DC 9V From Adapter input AC 120V/60Hz
 Test mode : IEEE802.11nHT20 CH1 2412MHz Tx
 M/N : SMCWBR14S-N5

| | Ant. Freq. (MHz) | Ant. Factor (dB/m) | Cable loss (dB) | Amp. Factor (dB) | Reading (dBuV) | Emission Level (dBuV/m) | Limits (dBuV/m) | Margin (dB) | Remark |
|---|------------------|--------------------|-----------------|------------------|----------------|-------------------------|-----------------|-------------|--------|
| 1 | 1051.000 | 25.50 | 4.86 | 37.81 | 45.74 | 38.29 | 74.00 | 35.71 | Peak |
| 2 | 1399.000 | 26.19 | 5.50 | 37.18 | 43.79 | 38.30 | 74.00 | 35.70 | Peak |
| 3 | 1750.000 | 27.80 | 6.18 | 36.86 | 42.48 | 39.60 | 74.00 | 34.40 | Peak |
| 4 | 2412.000 | 29.45 | 7.43 | 36.62 | 83.83 | 84.09 | 74.00 | -10.09 | Peak |

Remarks:

1. Emission Level= Antenna Factor + Cable Loss -Amp Factor + Reading.
2. The emission levels that are 20dB below the official limit are not reported.

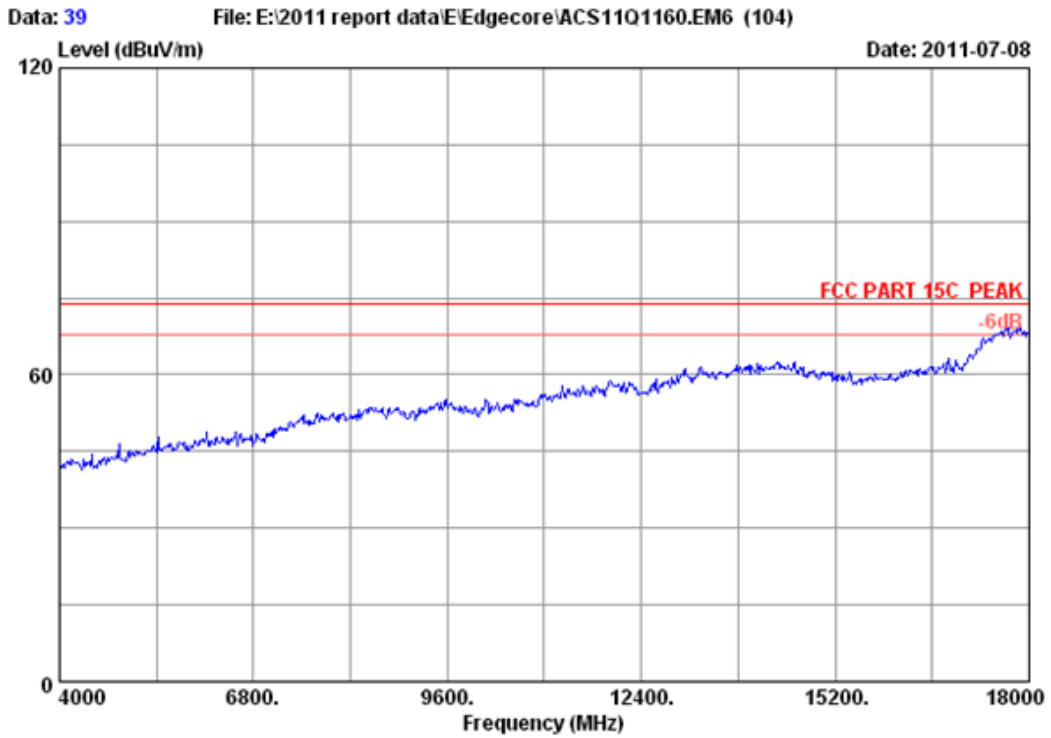

Site no. : 3m Chamber Data no. : 39
Dis. / Ant. : 3m 3115(0911) Ant. pol. : VERTICAL
Limit : FCC PART 15C PEAK
Env. / Ins. : 23°C/54% Engineer : Leo-Li
EUT : 150 Mbps 4-port Wireless Broadband Router
Power : DC 9V From Adapter input AC 120V/60Hz
Test mode : IEEE802.11nHT20 CH1 2412MHz Tx
M/N : SMCWBR14S-N5

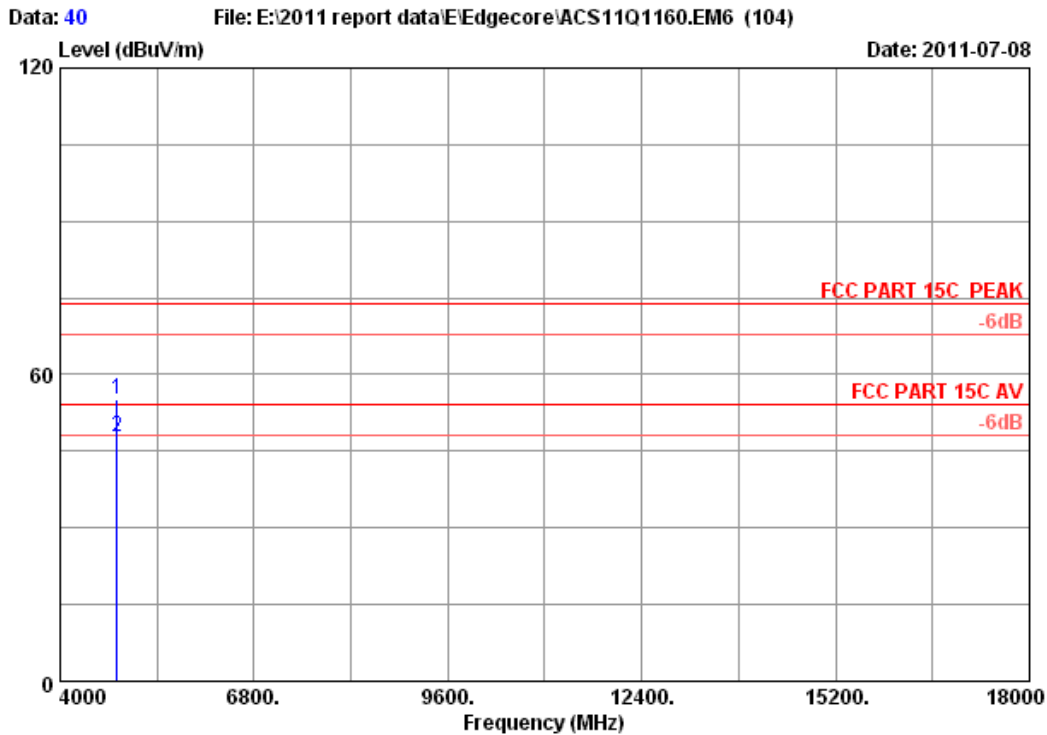

Site no. : 3m Chamber Data no. : 40
 Dis. / Ant. : 3m 3115(0911) Ant. pol. : VERTICAL
 Limit : FCC PART 15C PEAK
 Env. / Ins. : 23°C/54% Engineer : Leo-Li
 EUT : 150 Mbps 4-port Wireless Broadband Router
 Power : DC 9V From Adapter input AC 120V/60Hz
 Test mode : IEEE802.11nHT20 CH1 2412MHz Tx
 M/N : SMCWBR14S-N5

| | Ant. Freq. (MHz) | Ant. Factor (dB/m) | Cable loss (dB) | Amp. Factor (dB) | Reading (dBuV) | Emission Level (dBuV/m) | Limits (dBuV/m) | Margin (dB) | Remark |
|---|------------------|--------------------|-----------------|------------------|----------------|-------------------------|-----------------|-------------|---------|
| 1 | 4824.000 | 34.32 | 10.64 | 35.08 | 45.33 | 55.21 | 74.00 | 18.79 | Peak |
| 2 | 4824.000 | 34.32 | 10.64 | 35.08 | 37.86 | 47.74 | 54.00 | 6.26 | Average |

Remarks:

1. Emission Level= Antenna Factor + Cable Loss -Amp Factor + Reading.
2. The emission levels that are 20dB below the official limit are not reported.

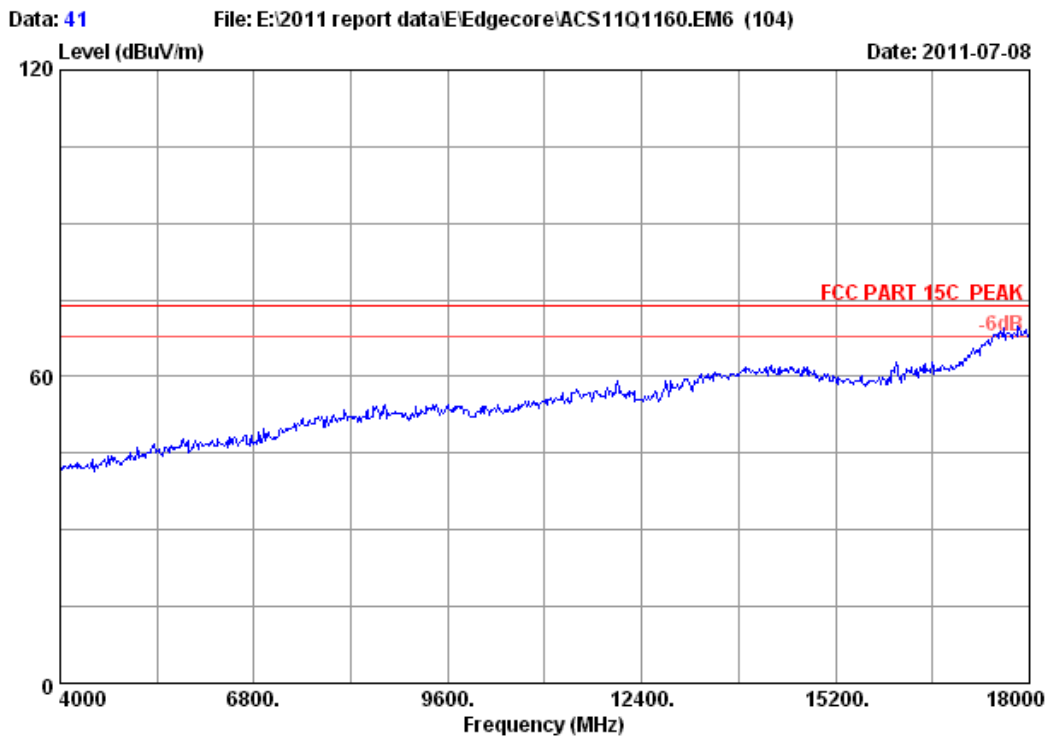

Site no. : 3m Chamber Data no. : 41
Dis. / Ant. : 3m 3115(0911) Ant. pol. : HORIZONTAL
Limit : FCC PART 15C PEAK
Env. / Ins. : 23°C/54% Engineer : Leo-Li
EUT : 150 Mbps 4-port Wireless Broadband Router
Power : DC 9V From Adapter input AC 120V/60Hz
Test mode : IEEE802.11nHT20 CH1 2412MHz Tx
M/N : SMCWBR14S-N5

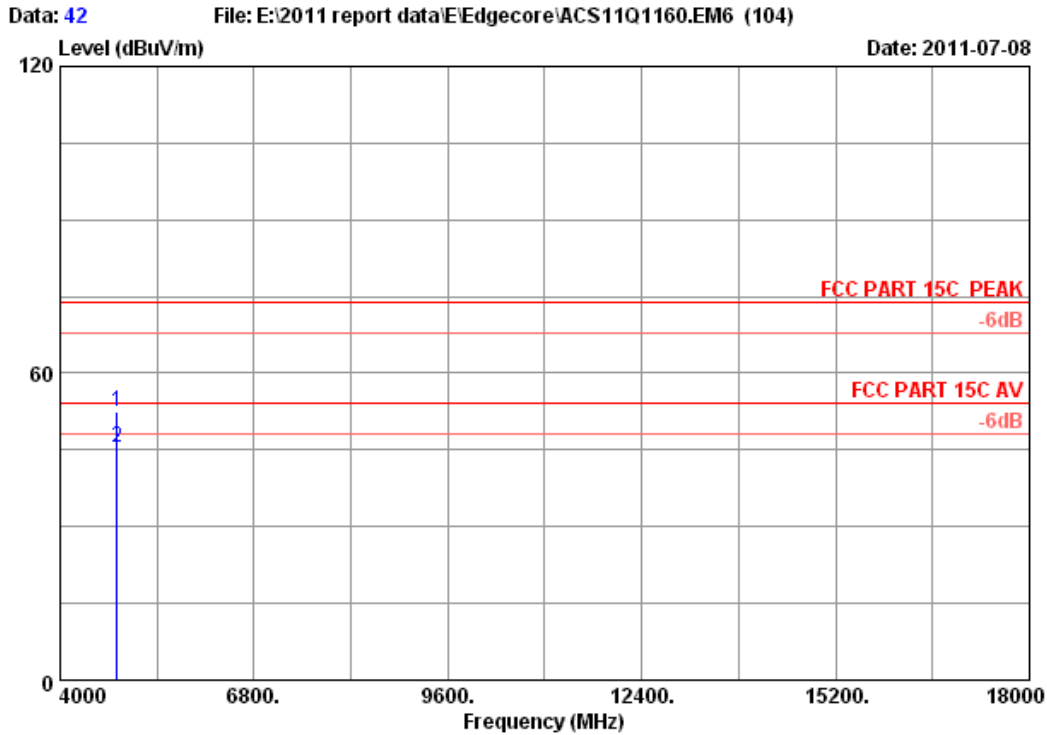

Site no. : 3m Chamber Data no. : 42
 Dis. / Ant. : 3m 3115(0911) Ant. pol. : HORIZONTAL
 Limit : FCC PART 15C PEAK
 Env. / Ins. : 23°C/54% Engineer : Leo-Li
 EUT : 150 Mbps 4-port Wireless Broadband Router
 Power : DC 9V From Adapter input AC 120V/60Hz
 Test mode : IEEE802.11nHT20 CH1 2412MHz Tx
 M/N : SMCWBR14S-N5

| | Ant. | Cable | Amp. | Emission | | | | | |
|-------|----------|-------|--------|----------|----------|----------|--------|--------|---------|
| Freq. | Factor | loss | Factor | Reading | Level | Limits | Margin | Remark | |
| (MHz) | (dB/m) | (dB) | (dB) | (dBuV) | (dBuV/m) | (dBuV/m) | (dB) | | |
| 1 | 4824.000 | 34.32 | 10.64 | 35.08 | 42.66 | 52.54 | 74.00 | 21.46 | Peak |
| 2 | 4824.000 | 34.32 | 10.64 | 35.08 | 35.48 | 45.36 | 54.00 | 8.64 | Average |

Remarks:

1. Emission Level= Antenna Factor + Cable Loss -Amp Factor + Reading.
2. The emission levels that are 20dB below the official limit are not reported.

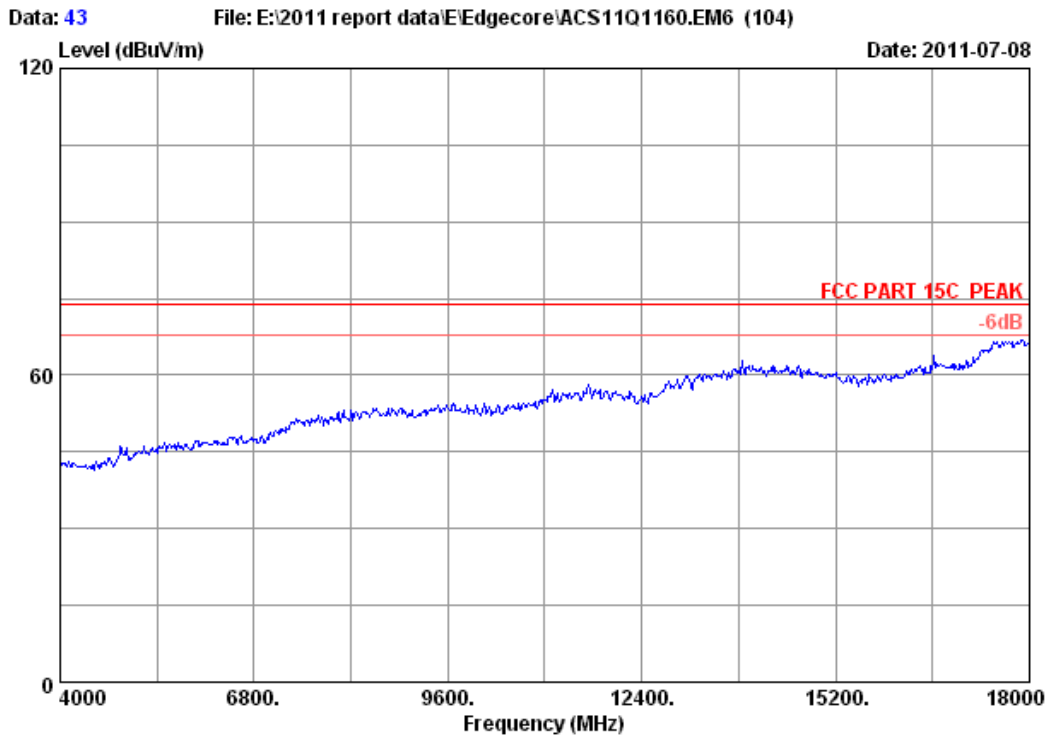

Site no. : 3m Chamber Data no. : 43
Dis. / Ant. : 3m 3115(0911) Ant. pol. : HORIZONTAL
Limit : FCC PART 15C PEAK
Env. / Ins. : 23°C/54% Engineer : Leo-Li
EUT : 150 Mbps 4-port Wireless Broadband Router
Power : DC 9V From Adapter input AC 120V/60Hz
Test mode : IEEE802.11nHT20 CH6 2437MHz Tx
M/N : SMCWBR14S-N5

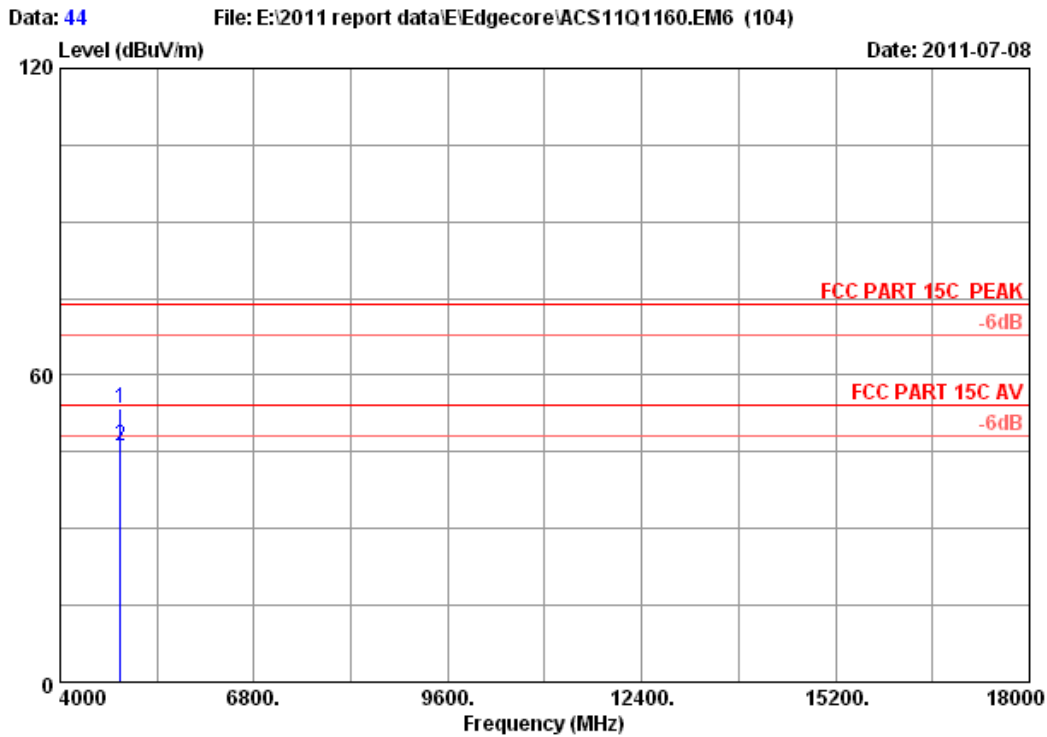

Site no. : 3m Chamber Data no. : 44
 Dis. / Ant. : 3m 3115(0911) Ant. pol. : HORIZONTAL
 Limit : FCC PART 15C PEAK
 Env. / Ins. : 23°C/54% Engineer : Leo-Li
 EUT : 150 Mbps 4-port Wireless Broadband Router
 Power : DC 9V From Adapter input AC 120V/60Hz
 Test mode : IEEE802.11nHT20 CH6 2437MHz Tx
 M/N : SMCWBR14S-N5

| | Ant. Freq. (MHz) | Ant. Factor (dB/m) | Cable loss (dB) | Amp. Factor (dB) | Reading (dBuV) | Emission Level (dBuV/m) | Limits (dBuV/m) | Margin (dB) | Remark |
|---|------------------|--------------------|-----------------|------------------|----------------|-------------------------|-----------------|-------------|---------|
| 1 | 4874.000 | 34.41 | 10.69 | 35.03 | 43.26 | 53.33 | 74.00 | 20.67 | Peak |
| 2 | 4874.000 | 34.41 | 10.69 | 35.03 | 36.14 | 46.21 | 54.00 | 7.79 | Average |

Remarks:

1. Emission Level= Antenna Factor + Cable Loss -Amp Factor + Reading.
2. The emission levels that are 20dB below the official limit are not reported.

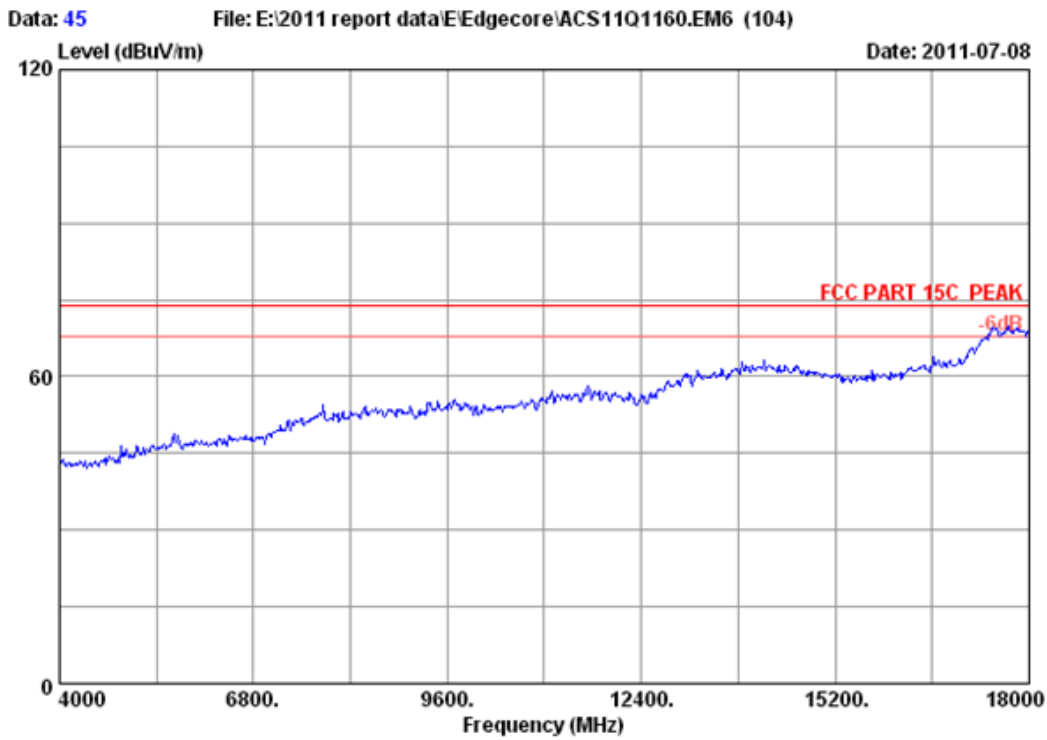

Site no. : 3m Chamber Data no. : 45
Dis. / Ant. : 3m 3115(0911) Ant. pol. : VERTICAL
Limit : FCC PART 15C PEAK
Env. / Ins. : 23°C/54% Engineer : Leo-Li
EUT : 150 Mbps 4-port Wireless Broadband Router
Power : DC 9V From Adapter input AC 120V/60Hz
Test mode : IEEE802.11nHT20 CH6 2437MHz Tx
M/N : SMCWBR14S-N5

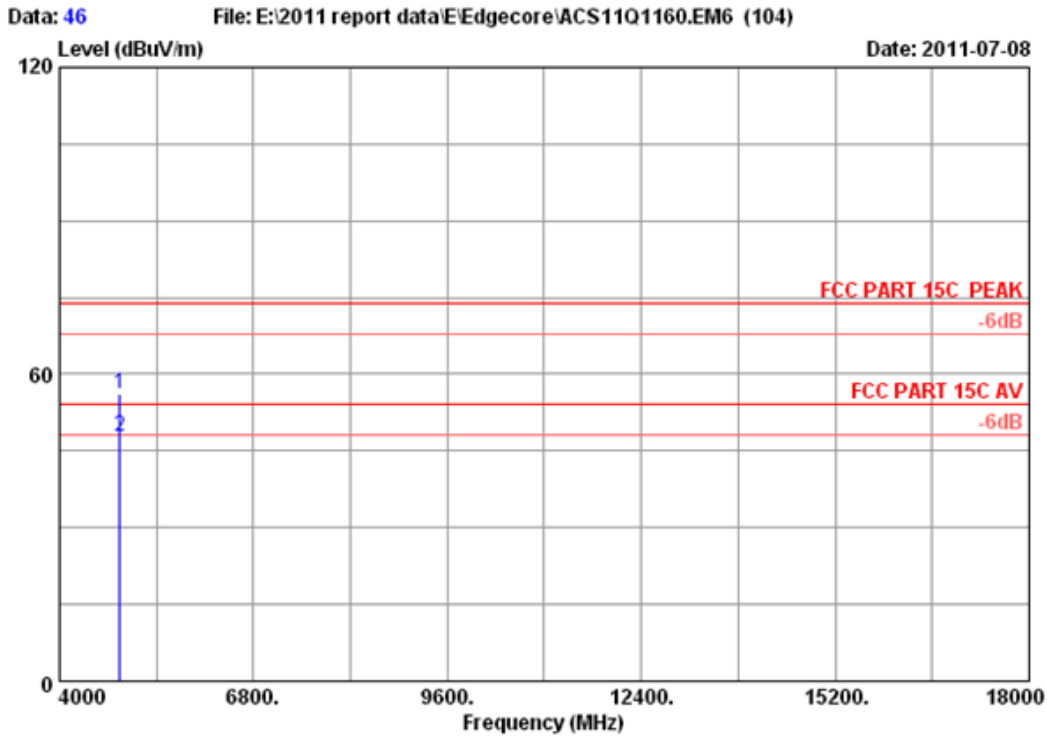

Site no. : 3m Chamber Data no. : 46
 Dis. / Ant. : 3m 3115(0911) Ant. pol. : VERTICAL
 Limit : FCC PART 15C PEAK
 Env. / Ins. : 23°C/54% Engineer : Leo-Li
 EUT : 150 Mbps 4-port Wireless Broadband Router
 Power : DC 9V From Adapter input AC 120V/60Hz
 Test mode : IEEE802.11nHT20 CH6 2437MHz Tx
 M/N : SMCWBR14S-N5

| | Ant. Freq. (MHz) | Factor (dB/m) | Cable loss (dB) | Amp. Factor (dB) | Reading (dBuV) | Emission Level (dBuV/m) | Limits (dBuV/m) | Margin (dB) | Remark |
|---|------------------|---------------|-----------------|------------------|----------------|-------------------------|-----------------|-------------|---------|
| 1 | 4874.000 | 34.41 | 10.69 | 35.03 | 46.25 | 56.32 | 74.00 | 17.68 | Peak |
| 2 | 4874.000 | 34.41 | 10.69 | 35.03 | 37.84 | 47.91 | 54.00 | 6.09 | Average |

Remarks:
 1. Emission Level= Antenna Factor + Cable Loss -Amp Factor + Reading.
 2. The emission levels that are 20dB below the official limit are not reported.

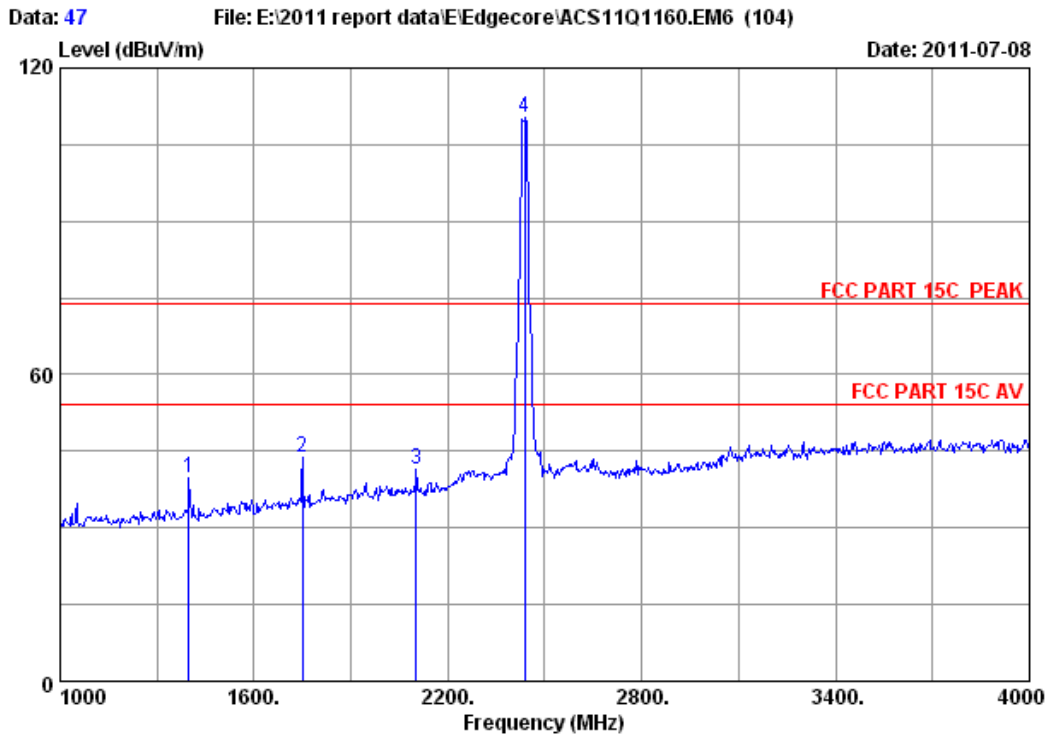

```

Site no.      : 3m Chamber           Data no. : 47
Dis. / Ant.  : 3m 3115(0911)       Ant. pol.: VERTICAL
Limit        : FCC PART 15C PEAK
Env. / Ins.  : 23*C/54%           Engineer : Leo-Li
EUT          : 150 Mbps 4-port Wireless Broadband Router
Power        : DC 9V From Adapter input AC 120V/60Hz
Test mode    : IEEE802.11nHT20 CH6 2437MHz Tx
M/N         : SMCWBR14S-N5
    
```

| | Ant. Freq. (MHz) | Ant. Factor (dB/m) | Cable loss (dB) | Amp. Factor (dB) | Reading (dBuV) | Emission Level (dBuV/m) | Limits (dBuV/m) | Margin (dB) | Remark |
|---|------------------|--------------------|-----------------|------------------|----------------|-------------------------|-----------------|-------------|--------|
| 1 | 1399.000 | 26.19 | 5.50 | 37.18 | 45.26 | 39.77 | 74.00 | 34.23 | Peak |
| 2 | 1750.000 | 27.80 | 6.18 | 36.86 | 46.52 | 43.64 | 74.00 | 30.36 | Peak |
| 3 | 2101.000 | 29.26 | 6.86 | 36.68 | 41.86 | 41.30 | 74.00 | 32.70 | Peak |
| 4 | 2437.000 | 29.47 | 7.46 | 36.61 | 109.87 | 110.19 | 74.00 | -36.19 | Peak |

Remarks:

1. Emission Level= Antenna Factor + Cable Loss -Amp Factor + Reading.
2. The emission levels that are 20dB below the official limit are not reported.

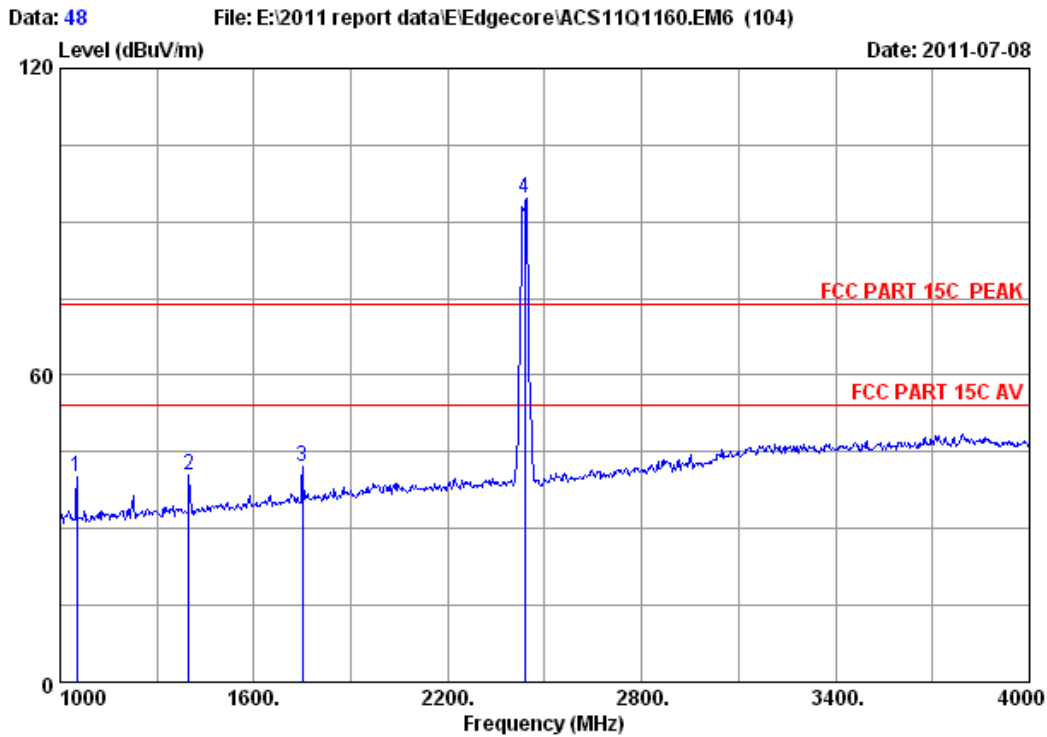

Site no. : 3m Chamber Data no. : 48
 Dis. / Ant. : 3m 3115(0911) Ant. pol. : HORIZONTAL
 Limit : FCC PART 15C PEAK
 Env. / Ins. : 23°C/54% Engineer : Leo-Li
 EUT : 150 Mbps 4-port Wireless Broadband Router
 Power : DC 9V From Adapter input AC 120V/60Hz
 Test mode : IEEE802.11nHT20 CH6 2437MHz Tx
 M/N : SMCWBR14S-N5

| | Ant. Freq. (MHz) | Ant. Factor (dB/m) | Cable loss (dB) | Amp. Factor (dB) | Reading (dBuV) | Emission Level (dBuV/m) | Limits (dBuV/m) | Margin (dB) | Remark |
|---|------------------|--------------------|-----------------|------------------|----------------|-------------------------|-----------------|-------------|--------|
| 1 | 1051.000 | 25.50 | 4.86 | 37.81 | 47.59 | 40.14 | 74.00 | 33.86 | Peak |
| 2 | 1399.000 | 26.19 | 5.50 | 37.18 | 45.91 | 40.42 | 74.00 | 33.58 | Peak |
| 3 | 1750.000 | 27.80 | 6.18 | 36.86 | 44.95 | 42.07 | 74.00 | 31.93 | Peak |
| 4 | 2437.000 | 29.47 | 7.46 | 36.61 | 94.27 | 94.59 | 74.00 | -20.59 | Peak |

Remarks:

1. Emission Level= Antenna Factor + Cable Loss -Amp Factor + Reading.
2. The emission levels that are 20dB below the official limit are not reported.

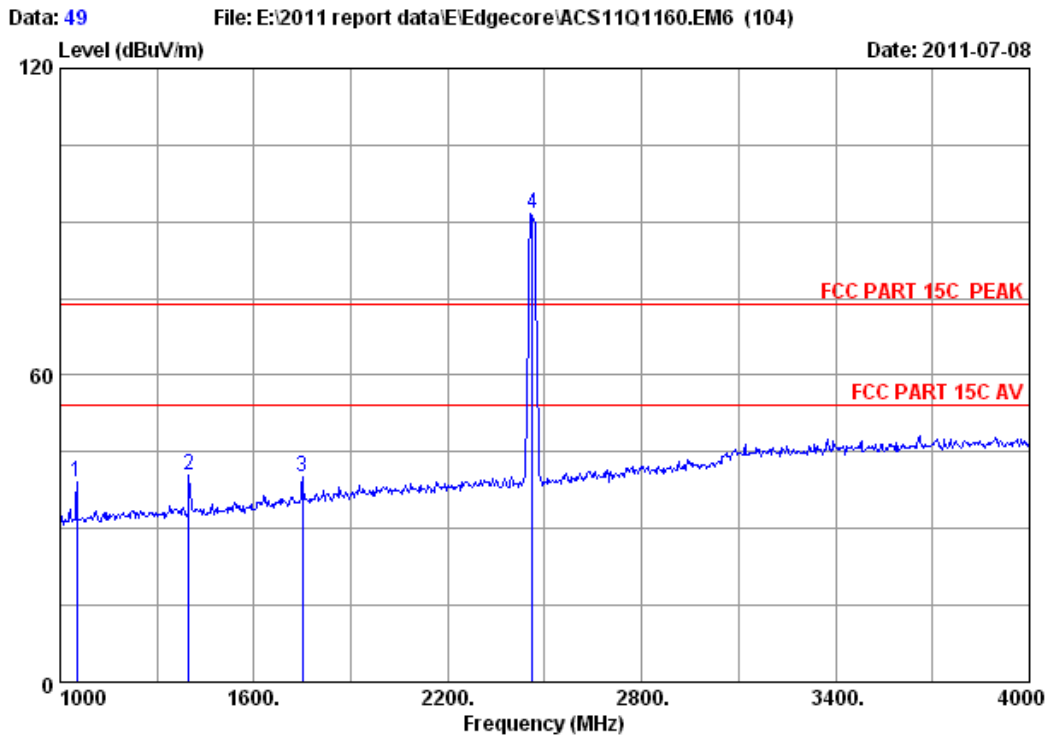

Site no. : 3m Chamber Data no. : 49
 Dis. / Ant. : 3m 3115(0911) Ant. pol. : HORIZONTAL
 Limit : FCC PART 15C PEAK
 Env. / Ins. : 23°C/54% Engineer : Leo-Li
 EUT : 150 Mbps 4-port Wireless Broadband Router
 Power : DC 9V From Adapter input AC 120V/60Hz
 Test mode : IEEE802.11nHT20 CH11 2462MHz Tx
 M/N : SMCWBR14S-N5

| | Ant. Freq. (MHz) | Ant. Factor (dB/m) | Cable loss (dB) | Amp. Factor (dB) | Reading (dBuV) | Emission Level (dBuV/m) | Limits (dBuV/m) | Margin (dB) | Remark |
|---|------------------|--------------------|-----------------|------------------|----------------|-------------------------|-----------------|-------------|--------|
| 1 | 1051.000 | 25.50 | 4.86 | 37.81 | 46.62 | 39.17 | 74.00 | 34.83 | Peak |
| 2 | 1399.000 | 26.19 | 5.50 | 37.18 | 45.85 | 40.36 | 74.00 | 33.64 | Peak |
| 3 | 1750.000 | 27.80 | 6.18 | 36.86 | 42.92 | 40.04 | 74.00 | 33.96 | Peak |
| 4 | 2462.000 | 29.48 | 7.54 | 36.61 | 91.28 | 91.69 | 74.00 | -17.69 | Peak |

Remarks:

1. Emission Level= Antenna Factor + Cable Loss -Amp Factor + Reading.
2. The emission levels that are 20dB below the official limit are not reported.

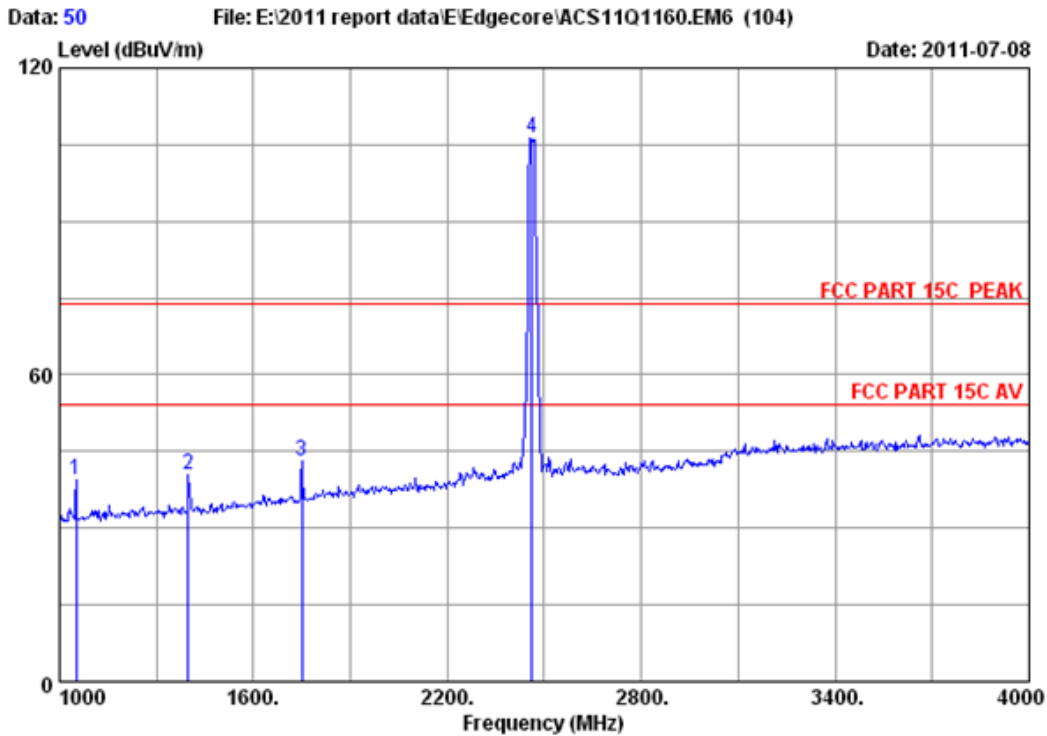

Site no. : 3m Chamber Data no. : 50
 Dis. / Ant. : 3m 3115(0911) Ant. pol. : VERTICAL
 Limit : FCC PART 15C PEAK
 Env. / Ins. : 23°C/54% Engineer : Leo-Li
 EUT : 150 Mbps 4-port Wireless Broadband Router
 Power : DC 9V From Adapter input AC 120V/60Hz
 Test mode : IEEE802.11nHT20 CH11 2462MHz Tx
 M/N : SMCWBR14S-N5

| | Ant. Freq. (MHz) | Ant. Factor (dB/m) | Cable loss (dB) | Amp. Factor (dB) | Reading (dBUV) | Emission Level (dBUV/m) | Limits (dBUV/m) | Margin (dB) | Remark |
|---|------------------|--------------------|-----------------|------------------|----------------|-------------------------|-----------------|-------------|--------|
| 1 | 1051.000 | 25.50 | 4.86 | 37.81 | 47.06 | 39.61 | 74.00 | 34.39 | Peak |
| 2 | 1399.000 | 26.19 | 5.50 | 37.18 | 45.85 | 40.36 | 74.00 | 33.64 | Peak |
| 3 | 1750.000 | 27.80 | 6.18 | 36.86 | 46.14 | 43.26 | 74.00 | 30.74 | Peak |
| 4 | 2462.000 | 29.48 | 7.54 | 36.61 | 105.85 | 106.26 | 74.00 | -32.26 | Peak |

Remarks:

1. Emission Level= Antenna Factor + Cable Loss -Amp Factor + Reading.
2. The emission levels that are 20dB below the official limit are not reported.

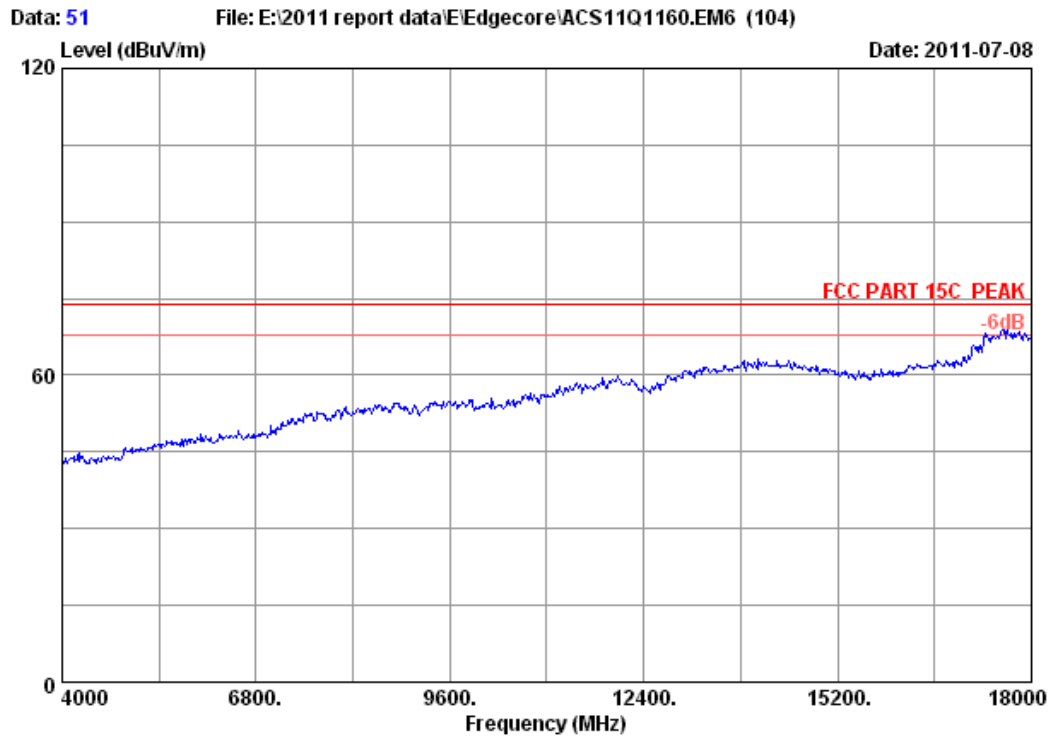

Site no. : 3m Chamber Data no. : 51
Dis. / Ant. : 3m 3115(0911) Ant. pol. : HORIZONTAL
Limit : FCC PART 15C PEAK
Env. / Ins. : 23°C/54% Engineer : Leo-Li
EUT : 150 Mbps 4-port Wireless Broadband Router
Power : DC 9V From Adapter input AC 120V/60Hz
Test mode : IEEE802.11nHT20 CH11 2462MHz Tx
M/N : SMCWBR14S-N5

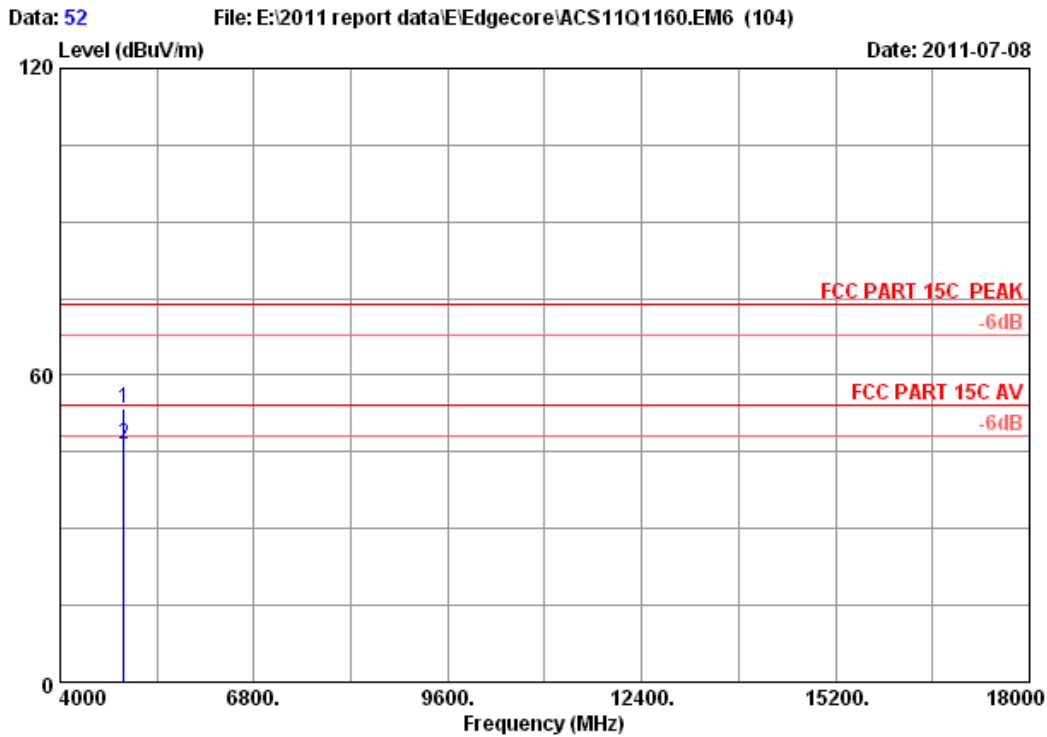

Site no. : 3m Chamber Data no. : 52
 Dis. / Ant. : 3m 3115(0911) Ant. pol. : HORIZONTAL
 Limit : FCC PART 15C PEAK
 Env. / Ins. : 23°C/54% Engineer : Leo-Li
 EUT : 150 Mbps 4-port Wireless Broadband Router
 Power : DC 9V From Adapter input AC 120V/60Hz
 Test mode : IEEE802.11nHT20 CH11 2462MHz Tx
 M/N : SMCWBR14S-N5

| | Ant. Freq. (MHz) | Ant. Factor (dB/m) | Cable loss (dB) | Amp. Factor (dB) | Reading (dBuV) | Emission Level (dBuV/m) | Limits (dBuV/m) | Margin (dB) | Remark |
|---|------------------|--------------------|-----------------|------------------|----------------|-------------------------|-----------------|-------------|---------|
| 1 | 4924.000 | 34.49 | 10.76 | 34.98 | 43.26 | 53.53 | 74.00 | 20.47 | Peak |
| 2 | 4924.000 | 34.49 | 10.76 | 34.98 | 36.14 | 46.41 | 54.00 | 7.59 | Average |

Remarks:

1. Emission Level= Antenna Factor + Cable Loss -Amp Factor + Reading.
2. The emission levels that are 20dB below the official limit are not reported.

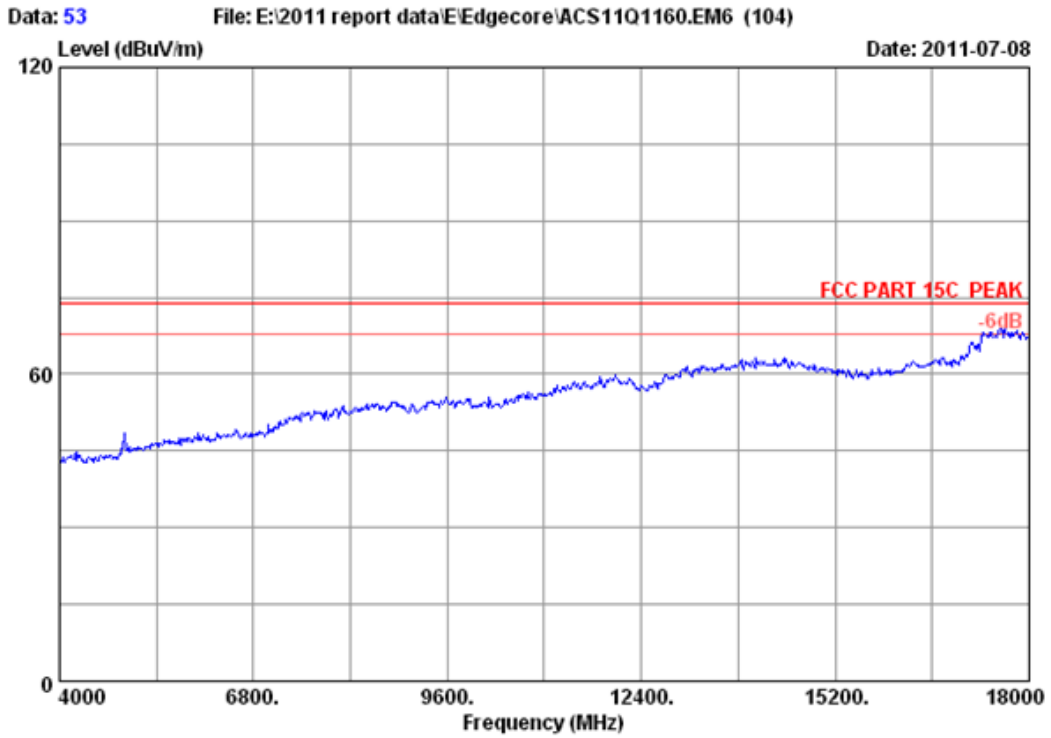

Site no. : 3m Chamber Data no. : 53
Dis. / Ant. : 3m 3115(0911) Ant. pol. : VERTICAL
Limit : FCC PART 15C PEAK
Env. / Ins. : 23°C/54% Engineer : Leo-Li
EUT : 150 Mbps 4-port Wireless Broadband Router
Power : DC 9V From Adapter input AC 120V/60Hz
Test mode : IEEE802.11nHT20 CH11 2462MHz Tx
M/N : SMCWBR14S-N5

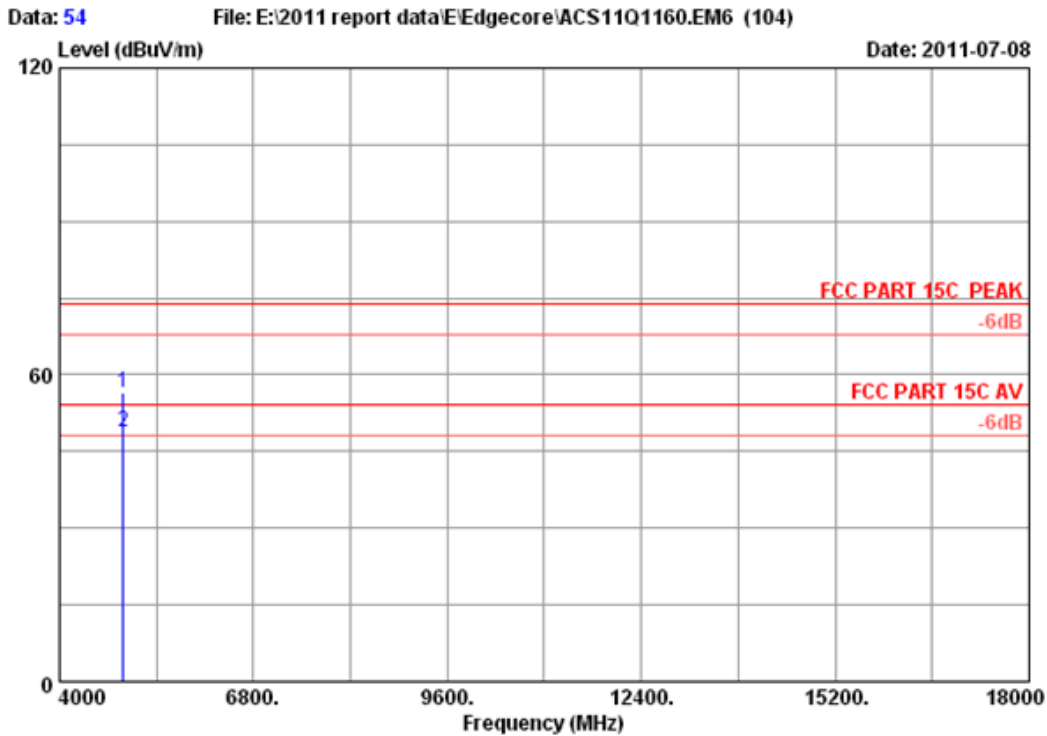

Site no. : 3m Chamber Data no. : 54
 Dis. / Ant. : 3m 3115(0911) Ant. pol. : VERTICAL
 Limit : FCC PART 15C PEAK
 Env. / Ins. : 23°C/54% Engineer : Leo-Li
 EUT : 150 Mbps 4-port Wireless Broadband Router
 Power : DC 9V From Adapter input AC 120V/60Hz
 Test mode : IEEE802.11nHT20 CH11 2462MHz Tx
 M/N : SMCWBR14S-N5

| | Freq. (MHz) | Ant. Factor (dB/m) | Cable loss (dB) | Amp. Factor (dB) | Reading (dBuV) | Emission Level (dBuV/m) | Limits (dBuV/m) | Margin (dB) | Remark |
|---|-------------|--------------------|-----------------|------------------|----------------|-------------------------|-----------------|-------------|---------|
| 1 | 4924.000 | 34.49 | 10.76 | 34.98 | 46.25 | 56.52 | 74.00 | 17.48 | Peak |
| 2 | 4924.000 | 34.49 | 10.76 | 34.98 | 38.47 | 48.74 | 54.00 | 5.26 | Average |

Remarks:
 1. Emission Level= Antenna Factor + Cable Loss -Amp Factor + Reading.
 2. The emission levels that are 20dB below the official limit are not reported.

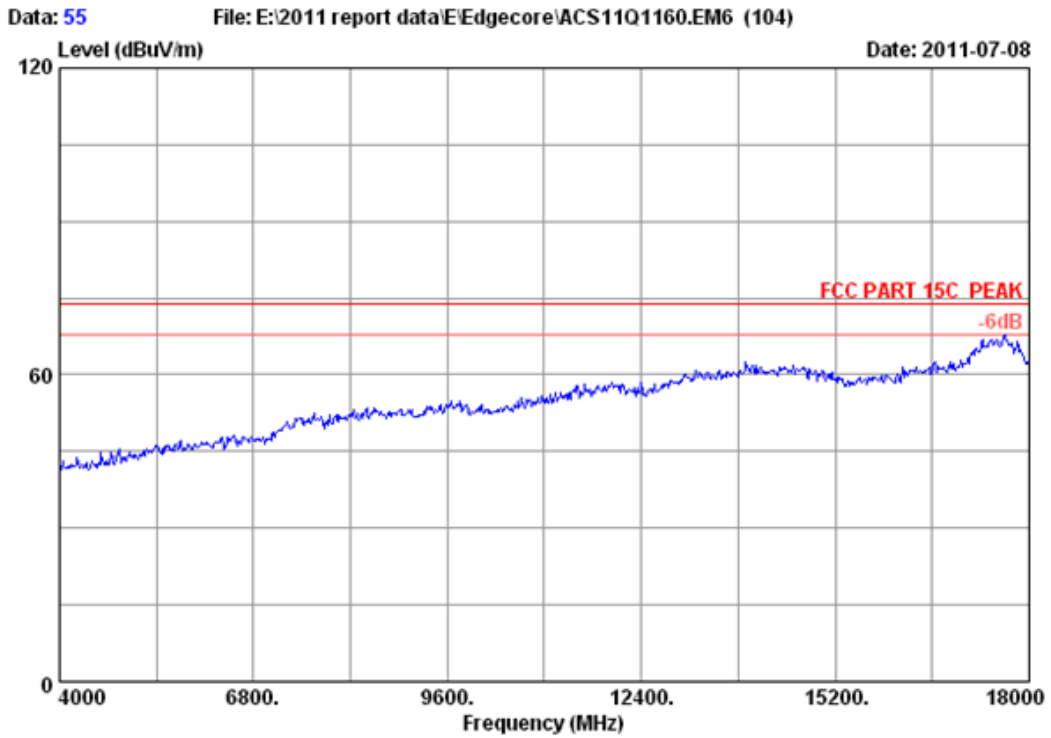

Site no. : 3m Chamber Data no. : 55
Dis. / Ant. : 3m 3115(0911) Ant. pol. : VERTICAL
Limit : FCC PART 15C PEAK
Env. / Ins. : 23°C/54% Engineer : Leo-Li
EUT : 150 Mbps 4-port Wireless Broadband Router
Power : DC 9V From Adapter input AC 120V/60Hz
Test mode : IEEE802.11nHT40 CH1 2422MHz Tx
M/N : SMCWBR14S-N5

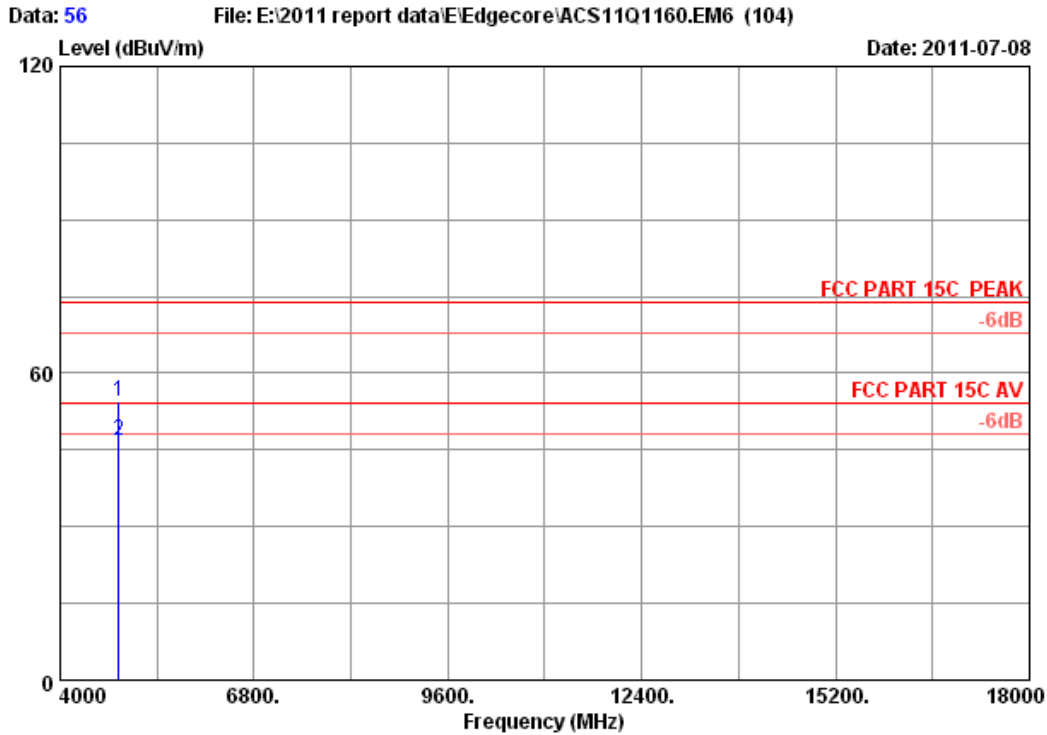

Site no. : 3m Chamber Data no. : 56
 Dis. / Ant. : 3m 3115(0911) Ant. pol. : VERTICAL
 Limit : FCC PART 15C PEAK
 Env. / Ins. : 23°C/54% Engineer : Leo-Li
 EUT : 150 Mbps 4-port Wireless Broadband Router
 Power : DC 9V From Adapter input AC 120V/60Hz
 Test mode : IEEE802.11nHT40 CH1 2422MHz Tx
 M/N : SMCWBR14S-N5

| | Ant. Freq. (MHz) | Ant. Factor (dB/m) | Cable loss (dB) | Amp. Factor (dB) | Reading (dBuV) | Emission Level (dBuV/m) | Limits (dBuV/m) | Margin (dB) | Remark |
|---|------------------|--------------------|-----------------|------------------|----------------|-------------------------|-----------------|-------------|---------|
| 1 | 4844.000 | 34.35 | 10.67 | 35.05 | 44.63 | 54.60 | 74.00 | 19.40 | Peak |
| 2 | 4844.000 | 34.35 | 10.67 | 35.05 | 36.98 | 46.95 | 54.00 | 7.05 | Average |

Remarks:

1. Emission Level= Antenna Factor + Cable Loss -Amp Factor + Reading.
2. The emission levels that are 20dB below the official limit are not reported.

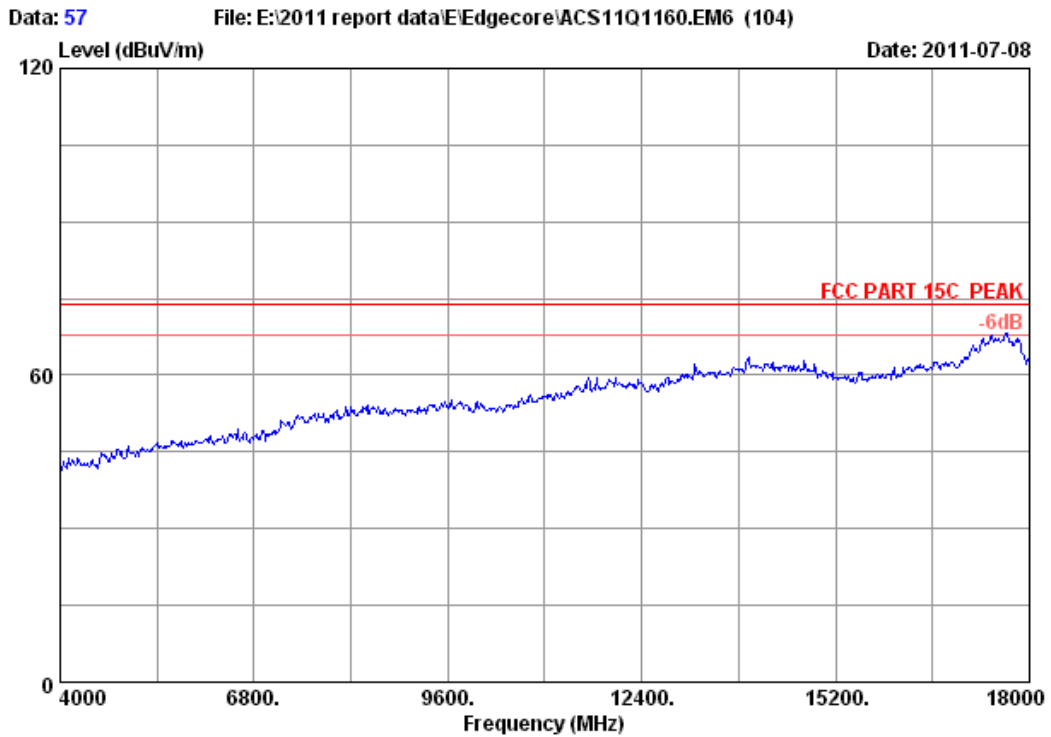

| | | | |
|-------------|---------------------------------------------|-------------|------------|
| Site no. | : 3m Chamber | Data no. : | 57 |
| Dis. / Ant. | : 3m 3115(0911) | Ant. pol. : | HORIZONTAL |
| Limit | : FCC PART 15C PEAK | | |
| Env. / Ins. | : 23°C/54% | Engineer : | Leo-Li |
| EUT | : 150 Mbps 4-port Wireless Broadband Router | | |
| Power | : DC 9V From Adapter input AC 120V/60Hz | | |
| Test mode | : IEEE802.11nHT40 CH1 2422MHz Tx | | |
| M/N | : SMCWBR14S-N5 | | |

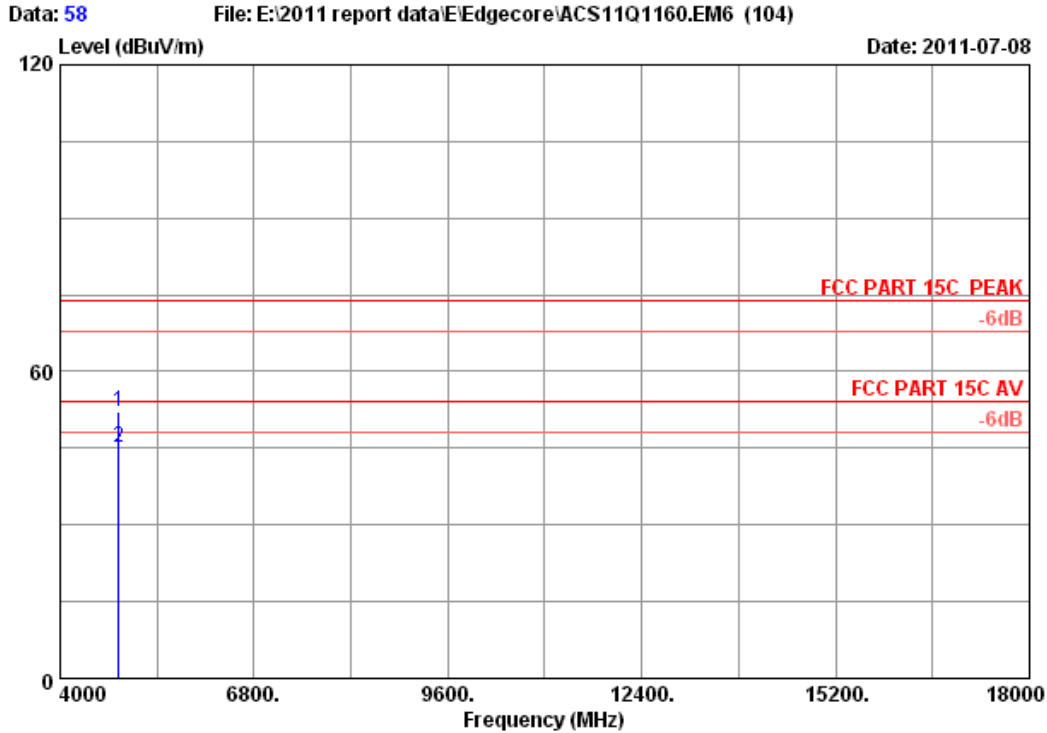

Site no. : 3m Chamber Data no. : 58
 Dis. / Ant. : 3m 3115(0911) Ant. pol. : HORIZONTAL
 Limit : FCC PART 15C PEAK
 Env. / Ins. : 23°C/54% Engineer : Leo-Li
 EUT : 150 Mbps 4-port Wireless Broadband Router
 Power : DC 9V From Adapter input AC 120V/60Hz
 Test mode : IEEE802.11nHT40 CH1 2422MHz Tx
 M/N : SMCWBR14S-N5

| | Freq. (MHz) | Ant. Factor (dB/m) | Cable loss (dB) | Amp. Factor (dB) | Reading (dBuV) | Emission Level (dBuV/m) | Limits (dBuV/m) | Margin (dB) | Remark |
|---|-------------|--------------------|-----------------|------------------|----------------|-------------------------|-----------------|-------------|---------|
| 1 | 4844.000 | 34.35 | 10.67 | 35.05 | 42.32 | 52.29 | 74.00 | 21.71 | Peak |
| 2 | 4844.000 | 34.35 | 10.67 | 35.05 | 35.17 | 45.14 | 54.00 | 8.86 | Average |

Remarks:

1. Emission Level= Antenna Factor + Cable Loss -Amp Factor + Reading.
2. The emission levels that are 20dB below the official limit are not reported.

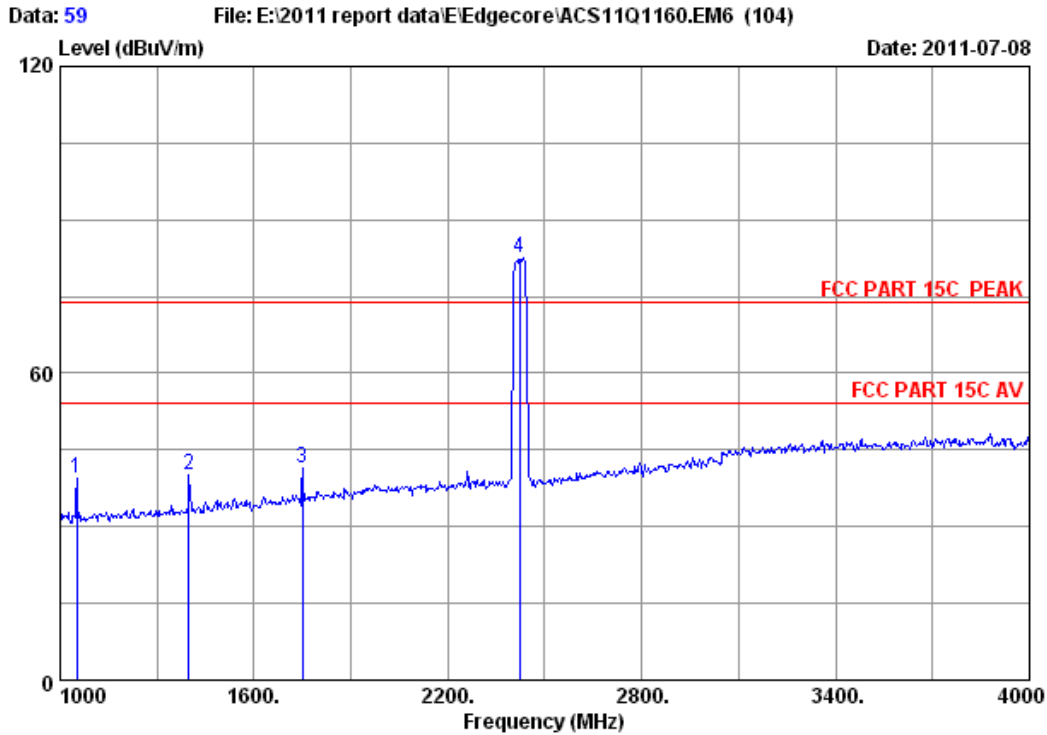

Site no. : 3m Chamber Data no. : 59
 Dis. / Ant. : 3m 3115(0911) Ant. pol. : HORIZONTAL
 Limit : FCC PART 15C PEAK
 Env. / Ins. : 23°C/54% Engineer : Leo-Li
 EUT : 150 Mbps 4-port Wireless Broadband Router
 Power : DC 9V From Adapter input AC 120V/60Hz
 Test mode : IEEE802.11nHT40 CH1 2422MHz Tx
 M/N : SMCWBR14S-N5

| | Ant. Freq. (MHz) | Ant. Factor (dB/m) | Cable loss (dB) | Amp. Factor (dB) | Reading (dBuV) | Emission Level (dBuV/m) | Limits (dBuV/m) | Margin (dB) | Remark |
|---|------------------|--------------------|-----------------|------------------|----------------|-------------------------|-----------------|-------------|--------|
| 1 | 1051.000 | 25.50 | 4.86 | 37.81 | 46.77 | 39.32 | 74.00 | 34.68 | Peak |
| 2 | 1399.000 | 26.19 | 5.50 | 37.18 | 45.71 | 40.22 | 74.00 | 33.78 | Peak |
| 3 | 1750.000 | 27.80 | 6.18 | 36.86 | 44.41 | 41.53 | 74.00 | 32.47 | Peak |
| 4 | 2422.000 | 29.46 | 7.46 | 36.61 | 82.37 | 82.68 | 74.00 | -8.68 | Peak |

Remarks:

1. Emission Level= Antenna Factor + Cable Loss -Amp Factor + Reading.
2. The emission levels that are 20dB below the official limit are not reported.

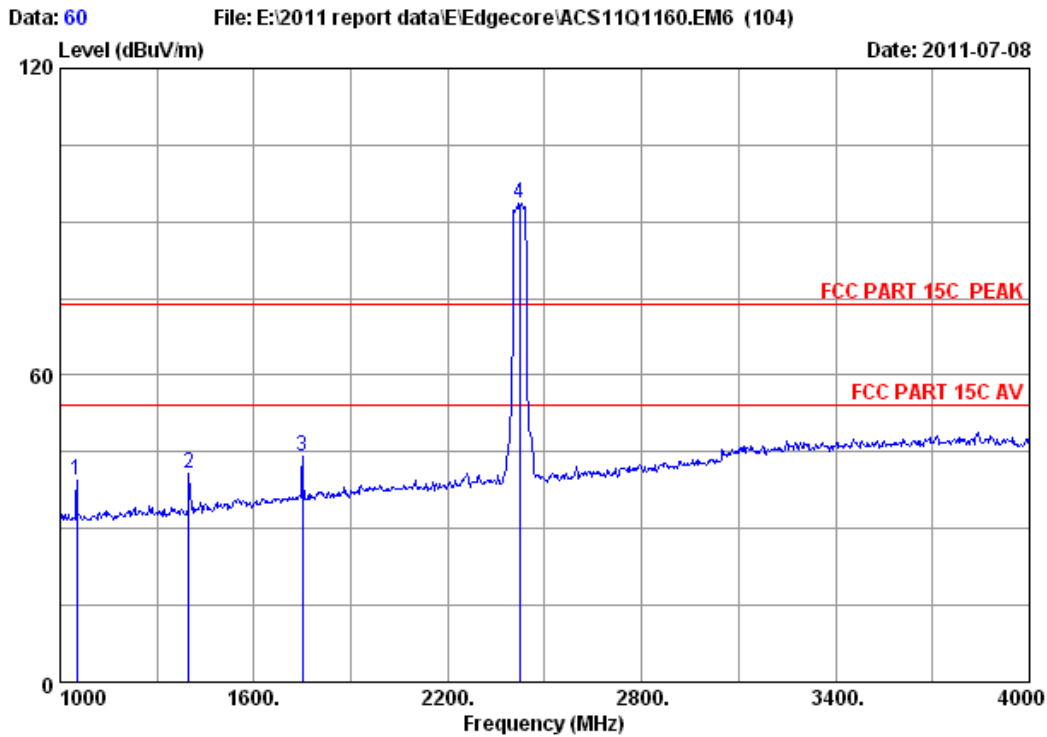

Site no. : 3m Chamber Data no. : 60
 Dis. / Ant. : 3m 3115(0911) Ant. pol. : VERTICAL
 Limit : FCC PART 15C PEAK
 Env. / Ins. : 23°C/54% Engineer : Leo-Li
 EUT : 150 Mbps 4-port Wireless Broadband Router
 Power : DC 9V From Adapter input AC 120V/60Hz
 Test mode : IEEE802.11nHT40 CH1 2422MHz Tx
 M/N : SMCWBR14S-N5

| | Ant. Freq. (MHz) | Ant. Factor (dB/m) | Cable loss (dB) | Amp. Factor (dB) | Reading (dBuV) | Emission Level (dBuV/m) | Limits (dBuV/m) | Margin (dB) | Remark |
|---|------------------|--------------------|-----------------|------------------|----------------|-------------------------|-----------------|-------------|--------|
| 1 | 1051.000 | 25.50 | 4.86 | 37.81 | 46.77 | 39.32 | 74.00 | 34.68 | Peak |
| 2 | 1399.000 | 26.19 | 5.50 | 37.18 | 46.38 | 40.89 | 74.00 | 33.11 | Peak |
| 3 | 1750.000 | 27.80 | 6.18 | 36.86 | 46.88 | 44.00 | 74.00 | 30.00 | Peak |
| 4 | 2422.000 | 29.46 | 7.46 | 36.61 | 93.20 | 93.51 | 74.00 | -19.51 | Peak |

Remarks:

1. Emission Level= Antenna Factor + Cable Loss -Amp Factor + Reading.
2. The emission levels that are 20dB below the official limit are not reported.

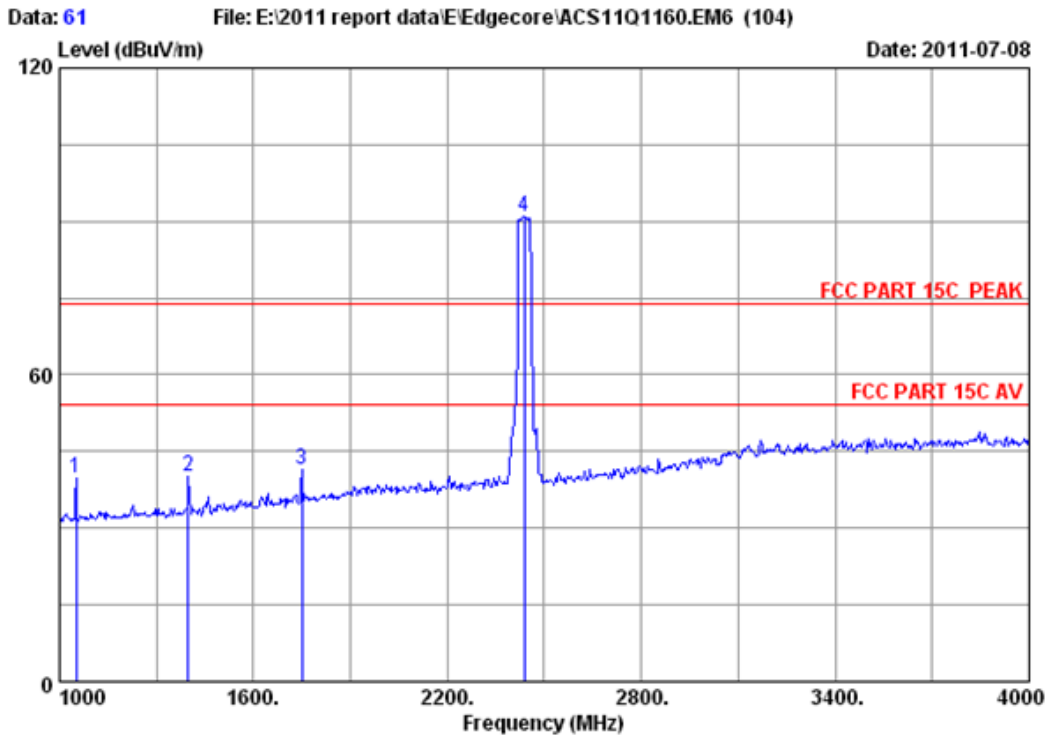

Site no. : 3m Chamber Data no. : 61
 Dis. / Ant. : 3m 3115(0911) Ant. pol. : HORIZONTAL
 Limit : FCC PART 15C PEAK
 Env. / Ins. : 23°C/54% Engineer : Leo-Li
 EUT : 150 Mbps 4-port Wireless Broadband Router
 Power : DC 9V From Adapter input AC 120V/60Hz
 Test mode : IEEE802.11nHT40 CH4 2437MHz Tx
 M/N : SMCWBR14S-N5

| | Ant. Freq. (MHz) | Ant. Factor (dB/m) | Cable loss (dB) | Amp. Factor (dB) | Reading (dBuV) | Emission Level (dBuV/m) | Limits (dBuV/m) | Margin (dB) | Remark |
|---|------------------|--------------------|-----------------|------------------|----------------|-------------------------|-----------------|-------------|--------|
| 1 | 1051.000 | 25.50 | 4.86 | 37.81 | 47.14 | 39.69 | 74.00 | 34.31 | Peak |
| 2 | 1399.000 | 26.19 | 5.50 | 37.18 | 45.65 | 40.16 | 74.00 | 33.84 | Peak |
| 3 | 1750.000 | 27.80 | 6.18 | 36.86 | 44.36 | 41.48 | 74.00 | 32.52 | Peak |
| 4 | 2437.000 | 29.47 | 7.46 | 36.61 | 90.52 | 90.84 | 74.00 | -16.84 | Peak |

Remarks:

1. Emission Level= Antenna Factor + Cable Loss -Amp Factor + Reading.
2. The emission levels that are 20dB below the official limit are not reported.

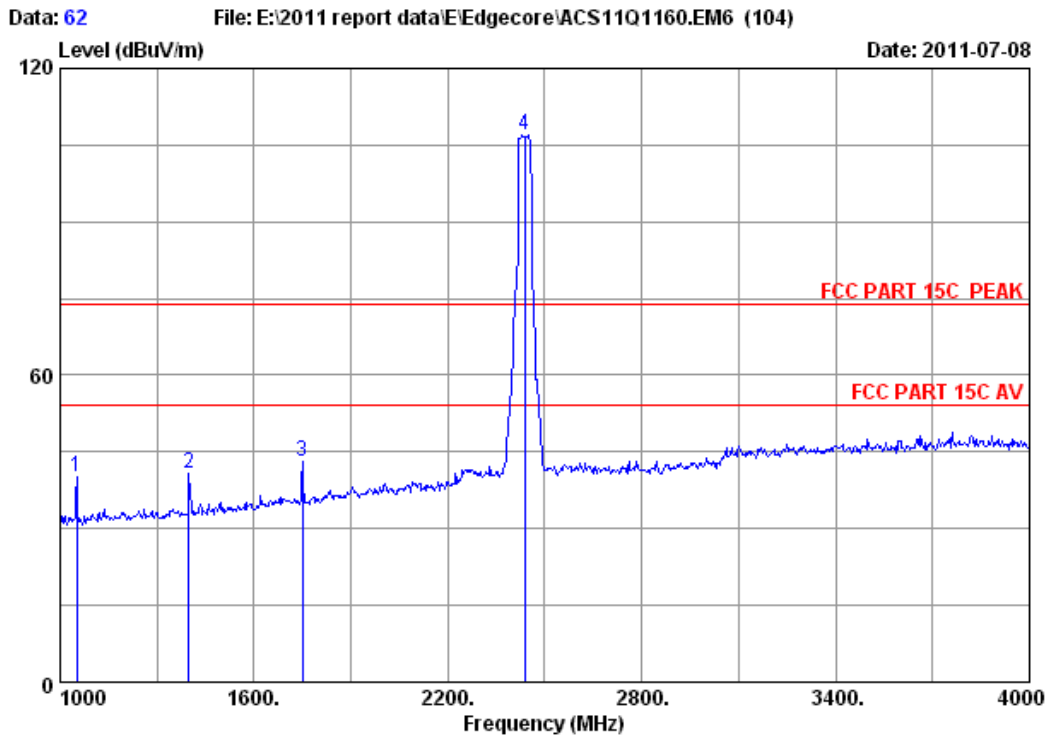

Site no. : 3m Chamber Data no. : 62
 Dis. / Ant. : 3m 3115(0911) Ant. pol. : VERTICAL
 Limit : FCC PART 15C PEAK
 Env. / Ins. : 23°C/54% Engineer : Leo-Li
 EUT : 150 Mbps 4-port Wireless Broadband Router
 Power : DC 9V From Adapter input AC 120V/60Hz
 Test mode : IEEE802.11nHT40 CH4 2437MHz Tx
 M/N : SMCWBR14S-N5

| | Ant. Freq. (MHz) | Ant. Factor (dB/m) | Cable loss (dB) | Amp. Factor (dB) | Reading (dBuV) | Emission Level (dBuV/m) | Limits (dBuV/m) | Margin (dB) | Remark |
|---|------------------|--------------------|-----------------|------------------|----------------|-------------------------|-----------------|-------------|--------|
| 1 | 1051.000 | 25.50 | 4.86 | 37.81 | 47.56 | 40.11 | 74.00 | 33.89 | Peak |
| 2 | 1399.000 | 26.19 | 5.50 | 37.18 | 46.23 | 40.74 | 74.00 | 33.26 | Peak |
| 3 | 1750.000 | 27.80 | 6.18 | 36.86 | 45.98 | 43.10 | 74.00 | 30.90 | Peak |
| 4 | 2437.000 | 29.47 | 7.46 | 36.61 | 106.68 | 107.00 | 74.00 | -33.00 | Peak |

Remarks:

1. Emission Level= Antenna Factor + Cable Loss -Amp Factor + Reading.
2. The emission levels that are 20dB below the official limit are not reported.

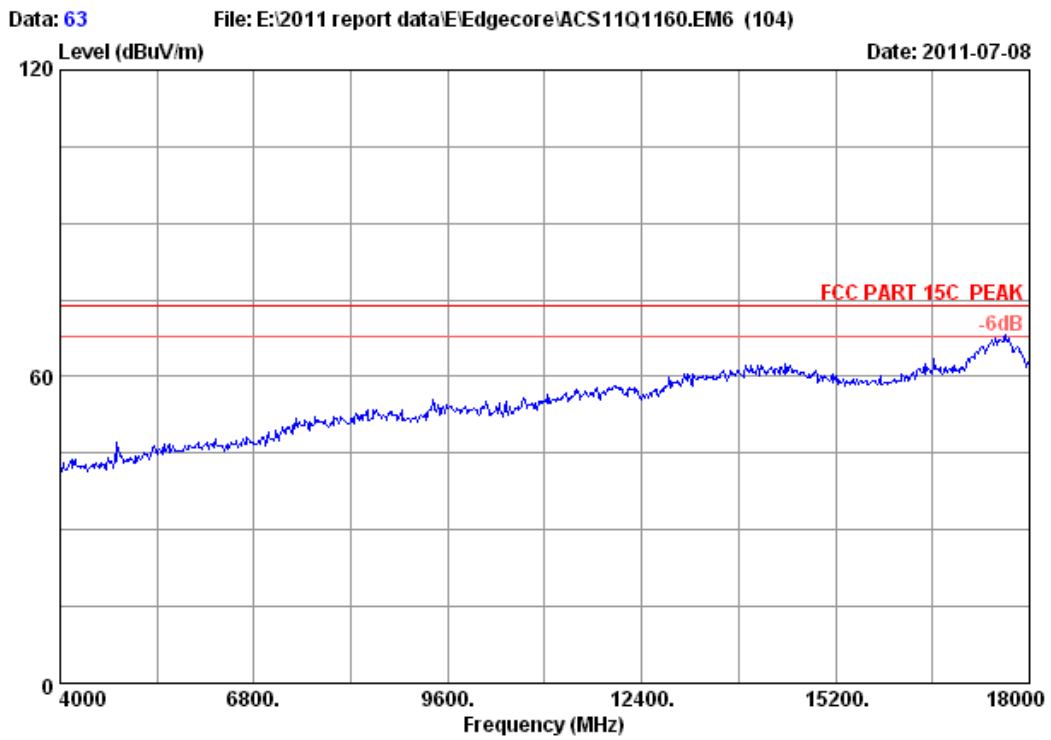

Site no. : 3m Chamber Data no. : 63
Dis. / Ant. : 3m 3115(0911) Ant. pol. : VERTICAL
Limit : FCC PART 15C PEAK
Env. / Ins. : 23°C/54% Engineer : Leo-Li
EUT : 150 Mbps 4-port Wireless Broadband Router
Power : DC 9V From Adapter input AC 120V/60Hz
Test mode : IEEE802.11nHT40 CH4 2437MHz Tx
M/N : SMCWBR14S-N5

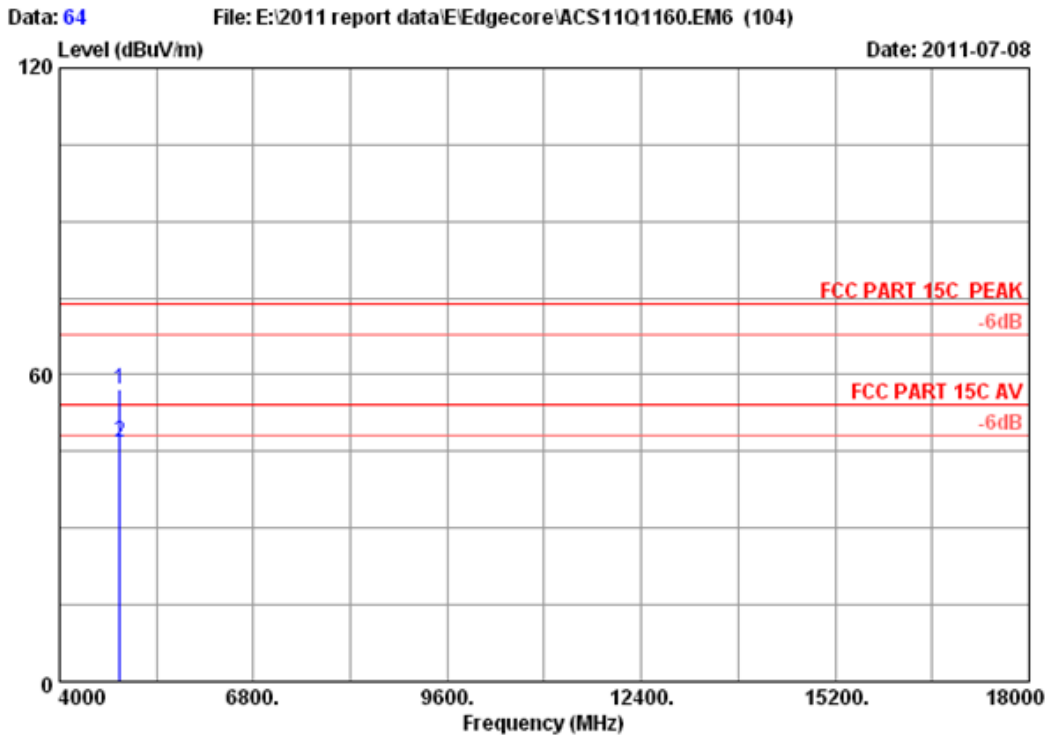

Site no. : 3m Chamber Data no. : 64
 Dis. / Ant. : 3m 3115(0911) Ant. pol. : VERTICAL
 Limit : FCC PART 15C PEAK
 Env. / Ins. : 23°C/54% Engineer : Leo-Li
 EUT : 150 Mbps 4-port Wireless Broadband Router
 Power : DC 9V From Adapter input AC 120V/60Hz
 Test mode : IEEE802.11nHT40 CH4 2437MHz Tx
 M/N : SMCWBR14S-N5

| | Freq. (MHz) | Ant. Factor (dB/m) | Cable loss (dB) | Amp. Factor (dB) | Reading (dBuV) | Emission Level (dBuV/m) | Limits (dBuV/m) | Margin (dB) | Remark |
|---|-------------|--------------------|-----------------|------------------|----------------|-------------------------|-----------------|-------------|---------|
| 1 | 4874.000 | 34.41 | 10.69 | 35.03 | 46.98 | 57.05 | 74.00 | 16.95 | Peak |
| 2 | 4874.000 | 34.41 | 10.69 | 35.03 | 36.78 | 46.85 | 54.00 | 7.15 | Average |

Remarks:

- Emission Level= Antenna Factor + Cable Loss -Amp Factor + Reading.
- The emission levels that are 20dB below the official limit are not reported.

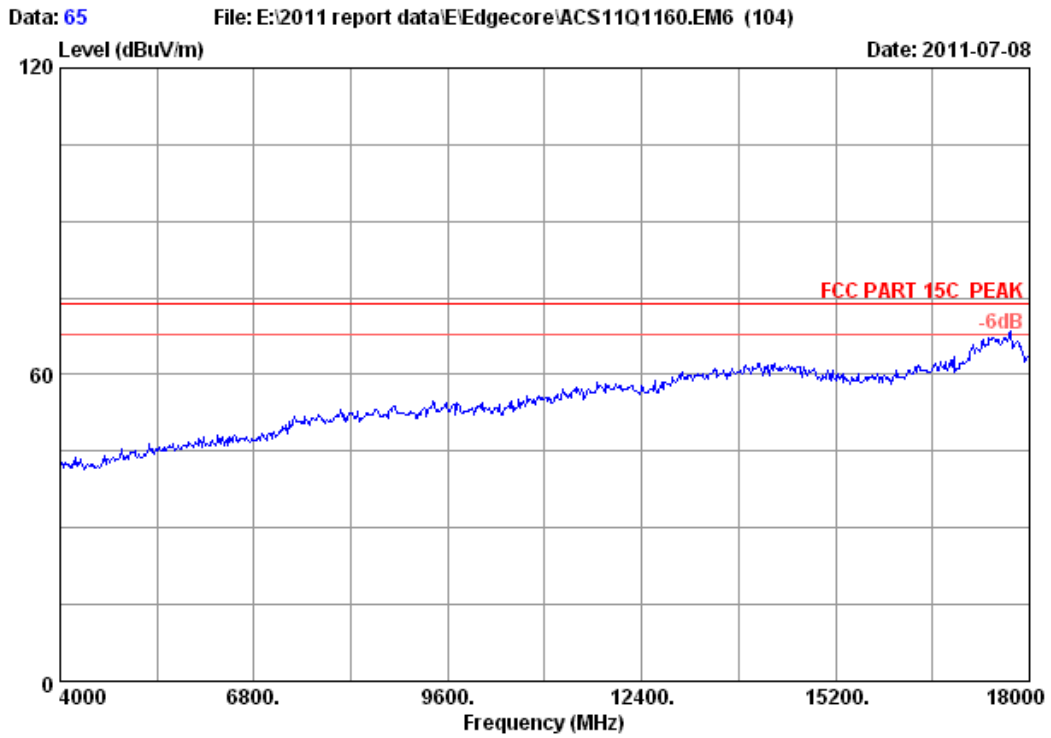

Site no. : 3m Chamber Data no. : 65
Dis. / Ant. : 3m 3115(0911) Ant. pol. : HORIZONTAL
Limit : FCC PART 15C PEAK
Env. / Ins. : 23°C/54% Engineer : Leo-Li
EUT : 150 Mbps 4-port Wireless Broadband Router
Power : DC 9V From Adapter input AC 120V/60Hz
Test mode : IEEE802.11nHT40 CH4 2437MHz Tx
M/N : SMCWBR14S-N5

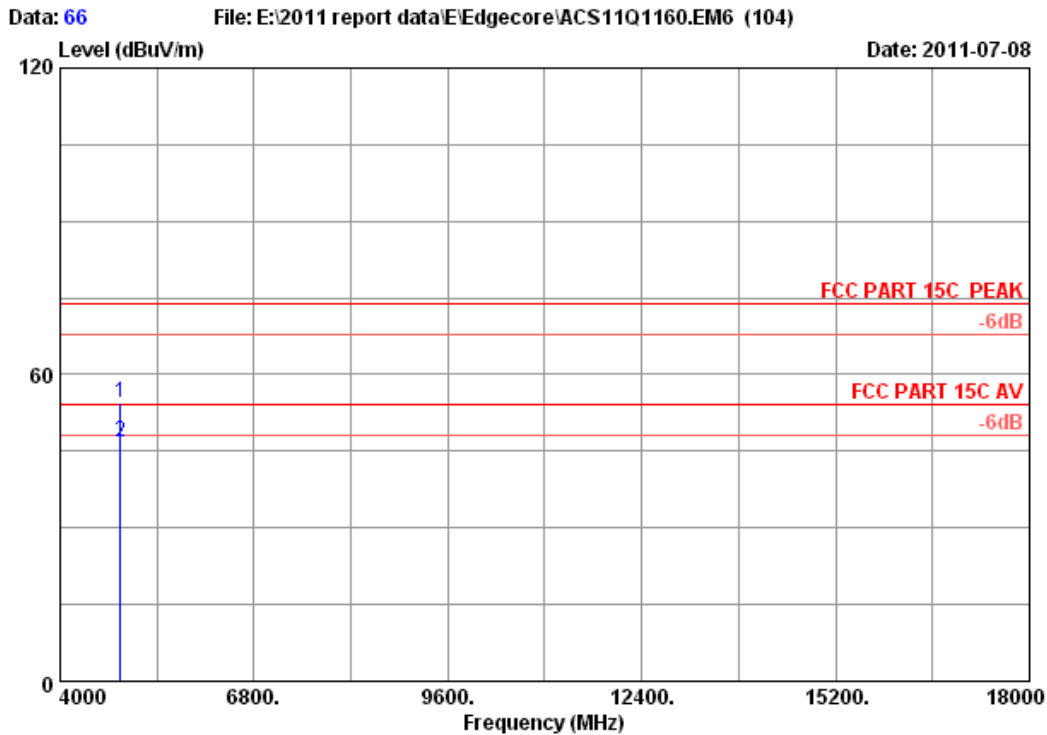

Site no. : 3m Chamber Data no. : 66
 Dis. / Ant. : 3m 3115(0911) Ant. pol. : HORIZONTAL
 Limit : FCC PART 15C PEAK
 Env. / Ins. : 23°C/54% Engineer : Leo-Li
 EUT : 150 Mbps 4-port Wireless Broadband Router
 Power : DC 9V From Adapter input AC 120V/60Hz
 Test mode : IEEE802.11nHT40 CH4 2437MHz Tx
 M/N : SMCWBR14S-N5

| | Ant. Freq. (MHz) | Ant. Factor (dB/m) | Cable loss (dB) | Amp. Factor (dB) | Reading (dBuV) | Emission Level (dBuV/m) | Limits (dBuV/m) | Margin (dB) | Remark |
|---|------------------|--------------------|-----------------|------------------|----------------|-------------------------|-----------------|-------------|---------|
| 1 | 4874.000 | 34.41 | 10.69 | 35.03 | 44.36 | 54.43 | 74.00 | 19.57 | Peak |
| 2 | 4874.000 | 34.41 | 10.69 | 35.03 | 36.84 | 46.91 | 54.00 | 7.09 | Average |

Remarks:

1. Emission Level= Antenna Factor + Cable Loss -Amp Factor + Reading.
2. The emission levels that are 20dB below the official limit are not reported.

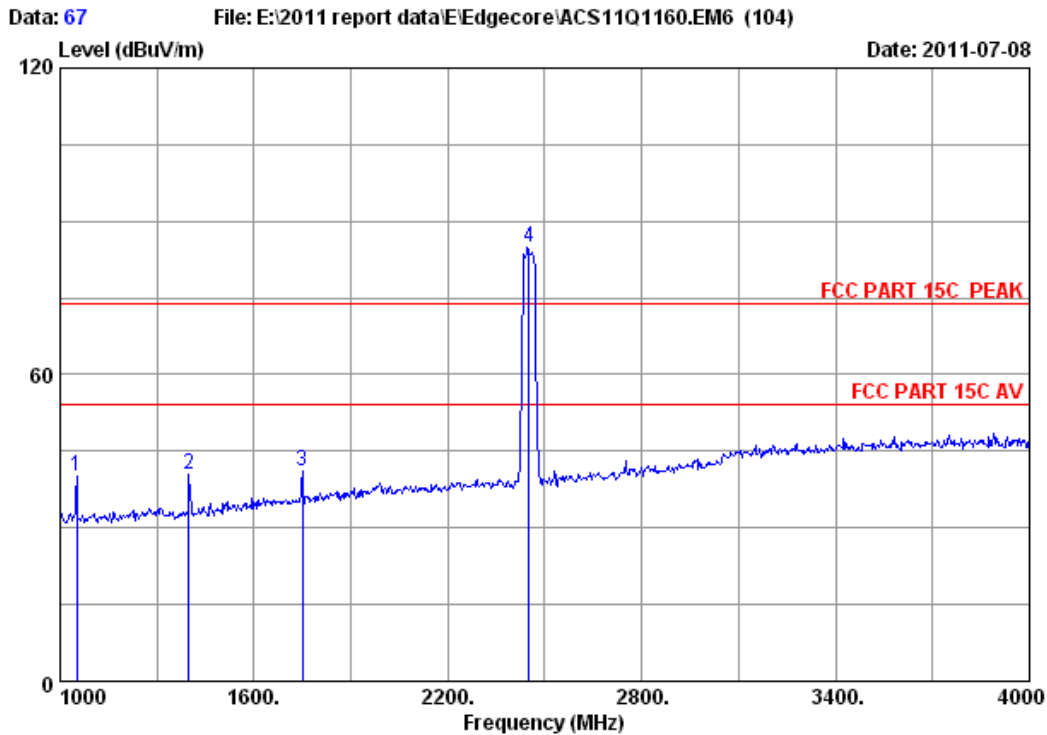

Site no. : 3m Chamber Data no. : 67
 Dis. / Ant. : 3m 3115(0911) Ant. pol. : HORIZONTAL
 Limit : FCC PART 15C PEAK
 Env. / Ins. : 23°C/54% Engineer : Leo-Li
 EUT : 150 Mbps 4-port Wireless Broadband Router
 Power : DC 9V From Adapter input AC 120V/60Hz
 Test mode : IEEE802.11nHT40 CH7 2452MHz Tx
 M/N : SMCWBR14S-N5

| | Ant. Freq. (MHz) | Ant. Factor (dB/m) | Cable loss (dB) | Amp. Factor (dB) | Reading (dBuV) | Emission Level (dBuV/m) | Limits (dBuV/m) | Margin (dB) | Remark |
|---|------------------|--------------------|-----------------|------------------|----------------|-------------------------|-----------------|-------------|--------|
| 1 | 1051.000 | 25.50 | 4.86 | 37.81 | 47.50 | 40.05 | 74.00 | 33.95 | Peak |
| 2 | 1399.000 | 26.19 | 5.50 | 37.18 | 45.92 | 40.43 | 74.00 | 33.57 | Peak |
| 3 | 1750.000 | 27.80 | 6.18 | 36.86 | 44.15 | 41.27 | 74.00 | 32.73 | Peak |
| 4 | 2452.000 | 29.47 | 7.50 | 36.61 | 84.62 | 84.98 | 74.00 | -10.98 | Peak |

Remarks:

1. Emission Level= Antenna Factor + Cable Loss -Amp Factor + Reading.
2. The emission levels that are 20dB below the official limit are not reported.

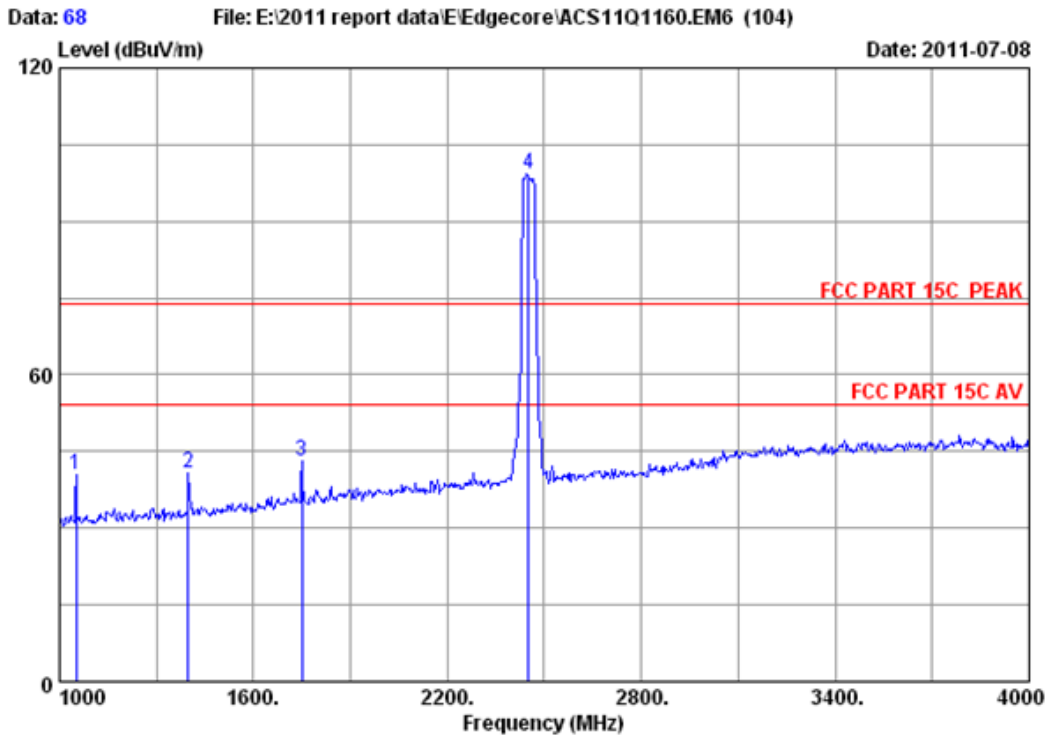

Site no. : 3m Chamber Data no. : 68
 Dis. / Ant. : 3m 3115(0911) Ant. pol. : VERTICAL
 Limit : FCC PART 15C PEAK
 Env. / Ins. : 23°C/54% Engineer : Leo-Li
 EUT : 150 Mbps 4-port Wireless Broadband Router
 Power : DC 9V From Adapter input AC 120V/60Hz
 Test mode : IEEE802.11nHT40 CH7 2452MHz Tx
 M/N : SMCWBR14S-N5

| | Freq. (MHz) | Ant. Factor (dB/m) | Cable loss (dB) | Amp. Factor (dB) | Reading (dBUV) | Emission Level (dBUV/m) | Limits (dBUV/m) | Margin (dB) | Remark |
|---|-------------|--------------------|-----------------|------------------|----------------|-------------------------|-----------------|-------------|--------|
| 1 | 1051.000 | 25.50 | 4.86 | 37.81 | 47.75 | 40.30 | 74.00 | 33.70 | Peak |
| 2 | 1399.000 | 26.19 | 5.50 | 37.18 | 46.34 | 40.85 | 74.00 | 33.15 | Peak |
| 3 | 1750.000 | 27.80 | 6.18 | 36.86 | 46.06 | 43.18 | 74.00 | 30.82 | Peak |
| 4 | 2452.000 | 29.47 | 7.50 | 36.61 | 98.80 | 99.16 | 74.00 | -25.16 | Peak |

Remarks:

1. Emission Level= Antenna Factor + Cable Loss -Amp Factor + Reading.
2. The emission levels that are 20dB below the official limit are not reported.

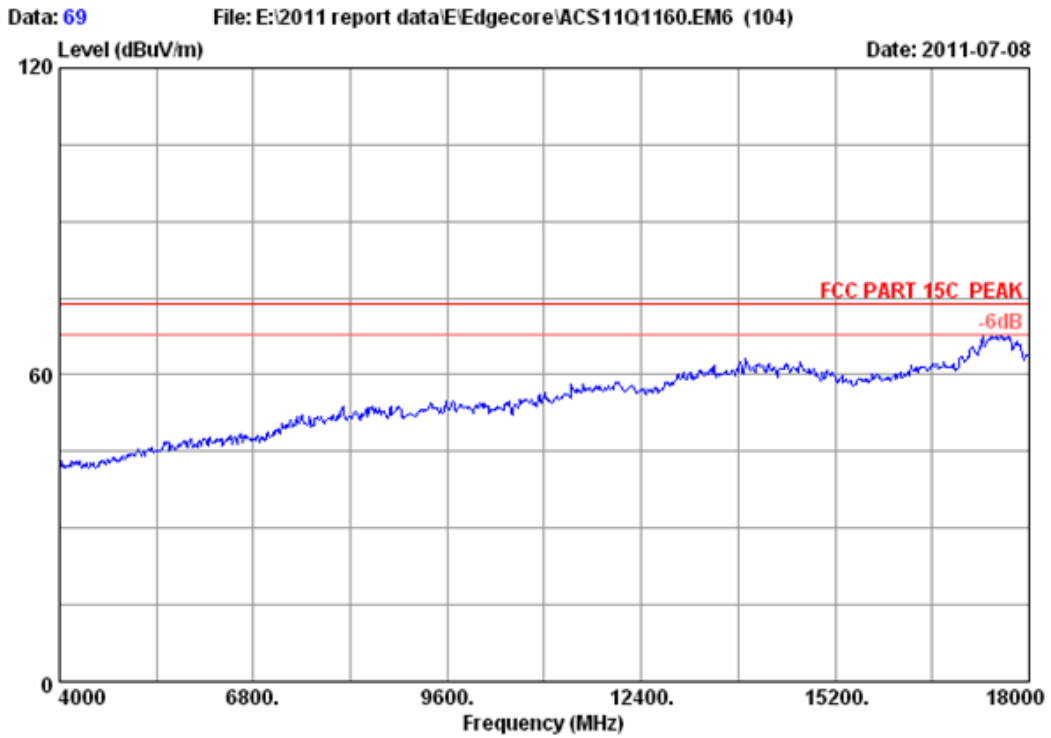

Site no. : 3m Chamber Data no. : 69
Dis. / Ant. : 3m 3115(0911) Ant. pol. : HORIZONTAL
Limit : FCC PART 15C PEAK
Env. / Ins. : 23°C/54% Engineer : Leo-Li
EUT : 150 Mbps 4-port Wireless Broadband Router
Power : DC 9V From Adapter input AC 120V/60Hz
Test mode : IEEE802.11nHT40 CH7 2452MHz Tx
M/N : SMCWBR14S-N5

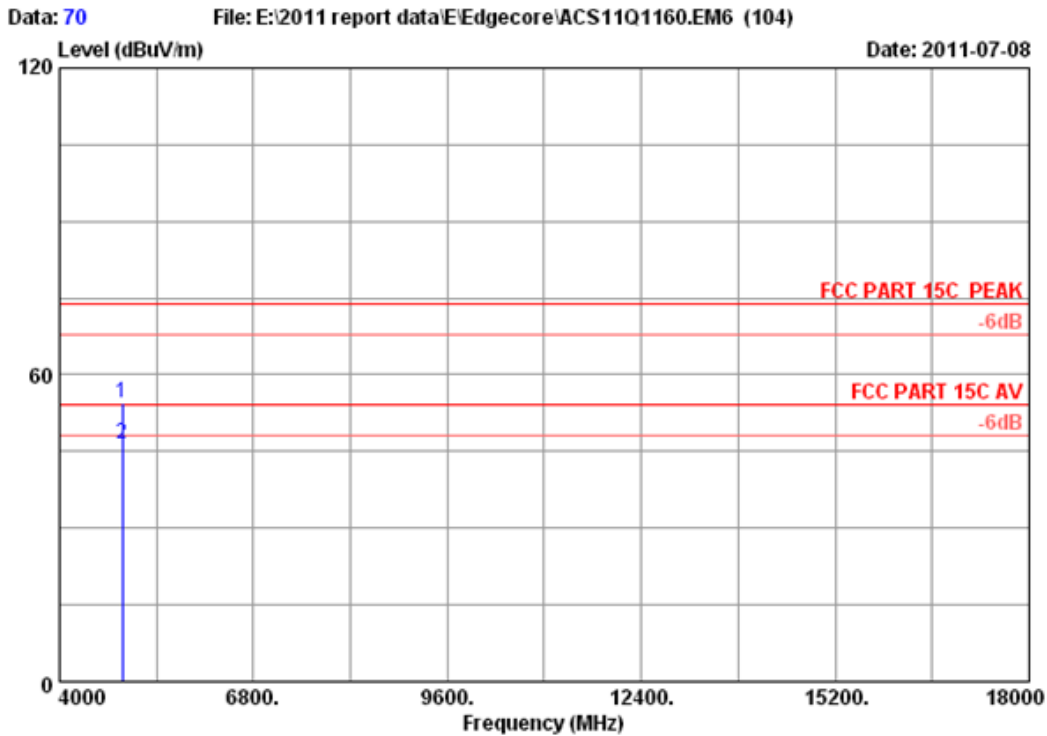

Site no. : 3m Chamber Data no. : 70
 Dis. / Ant. : 3m 3115(0911) Ant. pol. : HORIZONTAL
 Limit : FCC PART 15C PEAK
 Env. / Ins. : 23°C/54% Engineer : Leo-Li
 EUT : 150 Mbps 4-port Wireless Broadband Router
 Power : DC 9V From Adapter input AC 120V/60Hz
 Test mode : IEEE802.11nHT40 CH7 2452MHz Tx
 M/N : SMCWBR14S-N5

| | Freq. (MHz) | Ant. Factor (dB/m) | Cable loss (dB) | Amp. Factor (dB) | Reading (dBuV) | Emission Level (dBuV/m) | Limits (dBuV/m) | Margin (dB) | Remark |
|---|-------------|--------------------|-----------------|------------------|----------------|-------------------------|-----------------|-------------|---------|
| 1 | 4904.000 | 34.46 | 10.74 | 35.00 | 44.26 | 54.46 | 74.00 | 19.54 | Peak |
| 2 | 4904.000 | 34.46 | 10.74 | 35.00 | 36.24 | 46.44 | 54.00 | 7.56 | Average |

Remarks:
 1. Emission Level= Antenna Factor + Cable Loss -Amp Factor + Reading.
 2. The emission levels that are 20dB below the official limit are not reported.

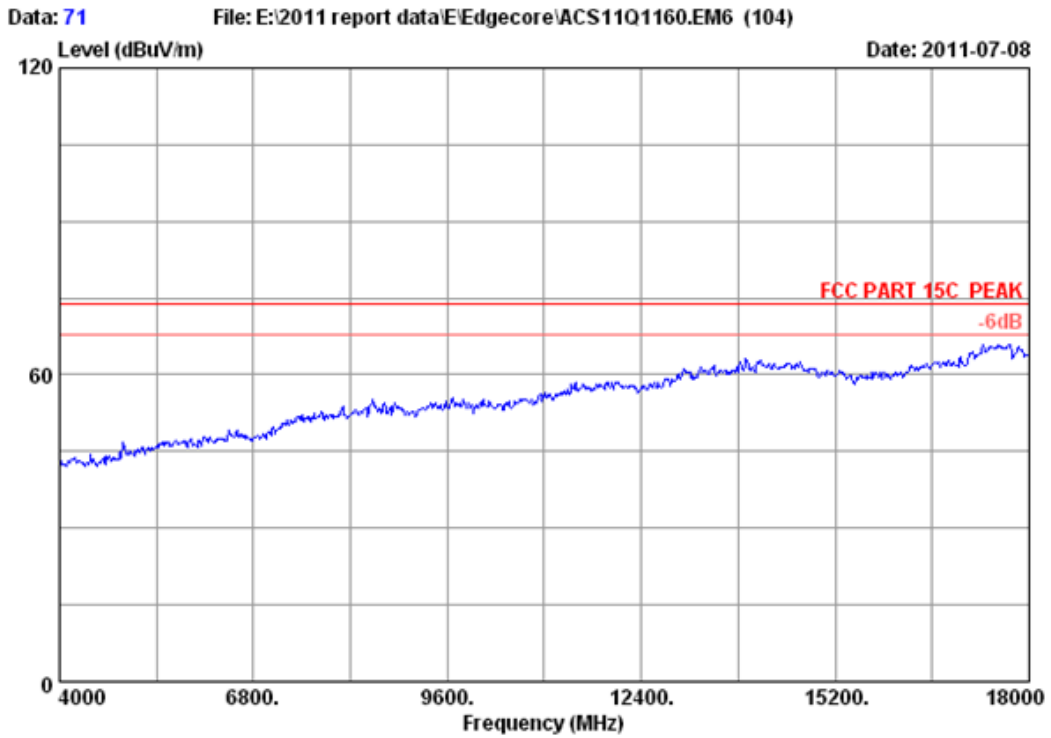

Site no. : 3m Chamber Data no. : 71
Dis. / Ant. : 3m 3115(0911) Ant. pol. : VERTICAL
Limit : FCC PART 15C PEAK
Env. / Ins. : 23°C/54% Engineer : Leo-Li
EUT : 150 Mbps 4-port Wireless Broadband Router
Power : DC 9V From Adapter input AC 120V/60Hz
Test mode : IEEE802.11nHT40 CH7 2452MHz Tx
M/N : SMCWBR14S-N5

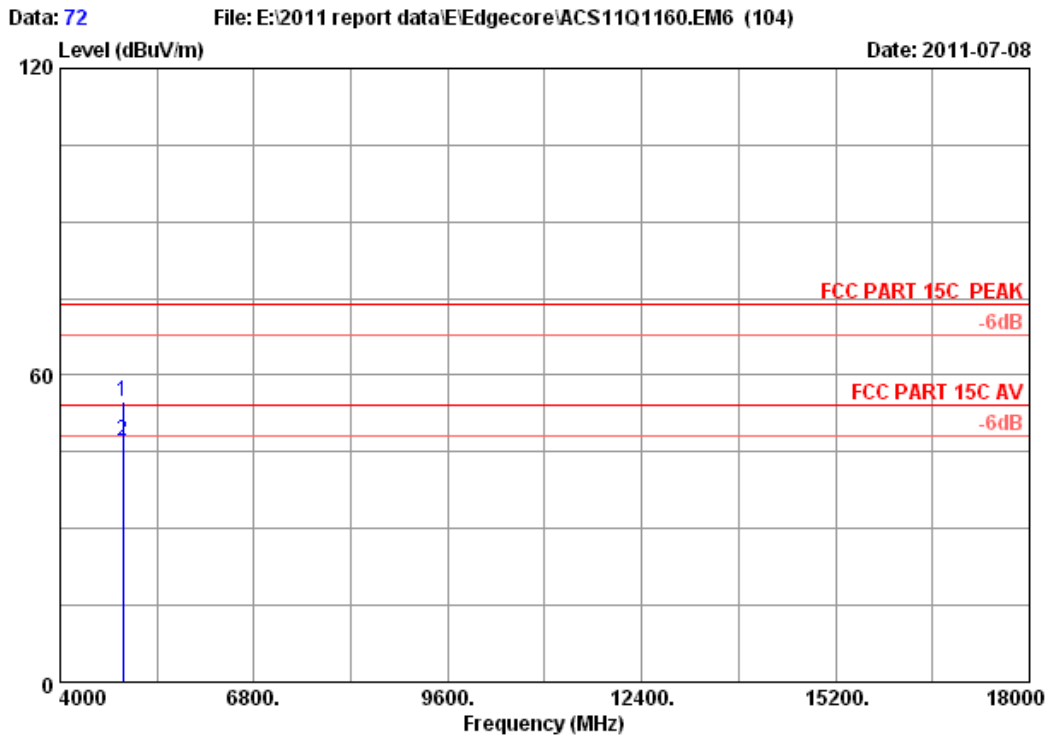

Site no. : 3m Chamber Data no. : 72
 Dis. / Ant. : 3m 3115(0911) Ant. pol. : VERTICAL
 Limit : FCC PART 15C PEAK
 Env. / Ins. : 23*C/54% Engineer : Leo-Li
 EUT : 150 Mbps 4-port Wireless Broadband Router
 Power : DC 9V From Adapter input AC 120V/60Hz
 Test mode : IEEE802.11nHT40 CH7 2452MHz Tx
 M/N : SMCWBR14S-N5

| | Freq. (MHz) | Ant. Factor (dB/m) | Cable loss (dB) | Amp. Factor (dB) | Reading (dBuV) | Emission Level (dBuV/m) | Limits (dBuV/m) | Margin (dB) | Remark |
|---|----------------|--------------------------|-----------------------|------------------------|-------------------|-------------------------------|--------------------|----------------|---------|
| 1 | 4904.000 | 34.46 | 10.74 | 35.00 | 44.58 | 54.78 | 74.00 | 19.22 | Peak |
| 2 | 4904.000 | 34.46 | 10.74 | 35.00 | 37.10 | 47.30 | 54.00 | 6.70 | Average |

Remarks:

1. Emission Level= Antenna Factor + Cable Loss -Amp Factor + Reading.
2. The emission levels that are 20dB below the official limit are not reported.

5. CONDUCTED SPURIOUS EMISSIONS

5.1. Test Equipment

| Item | Equipment | Manufacturer | Model No. | Serial No. | Last Cal. | Cal. Interval |
|------|-------------------|--------------|-------------|------------|-----------|---------------|
| 1. | Spectrum Analyzer | Agilent | E4446A | US44300459 | May.08,11 | 1 Year |
| 2. | Attenuator | Agilent | 8491B | MY39262165 | May.08,11 | 1 Year |
| 3. | RF Cable | Hubersuhner | SUCOFLEX102 | 28618/2 | May.08,11 | 1Year |

5.2. Limit

In any 100kHz bandwidth outside the frequency bands in which the spread spectrum intentional radiator is operating, the radio frequency power that is produced by the intentional radiator shall be at least 20dB below that in the 100kHz bandwidth within the band that contains the highest level of the desired power.

5.3. Test Procedure

The transmitter output was connected to a spectrum analyzer, The resolution bandwidth is set to 100 kHz, The video bandwidth is set to 300 kHz and measure all the emissions detected.

5.4. Test result

PASS (The testing data was attached in the next pages.)

Test Mode: IEEE 802.11b TX
CH1

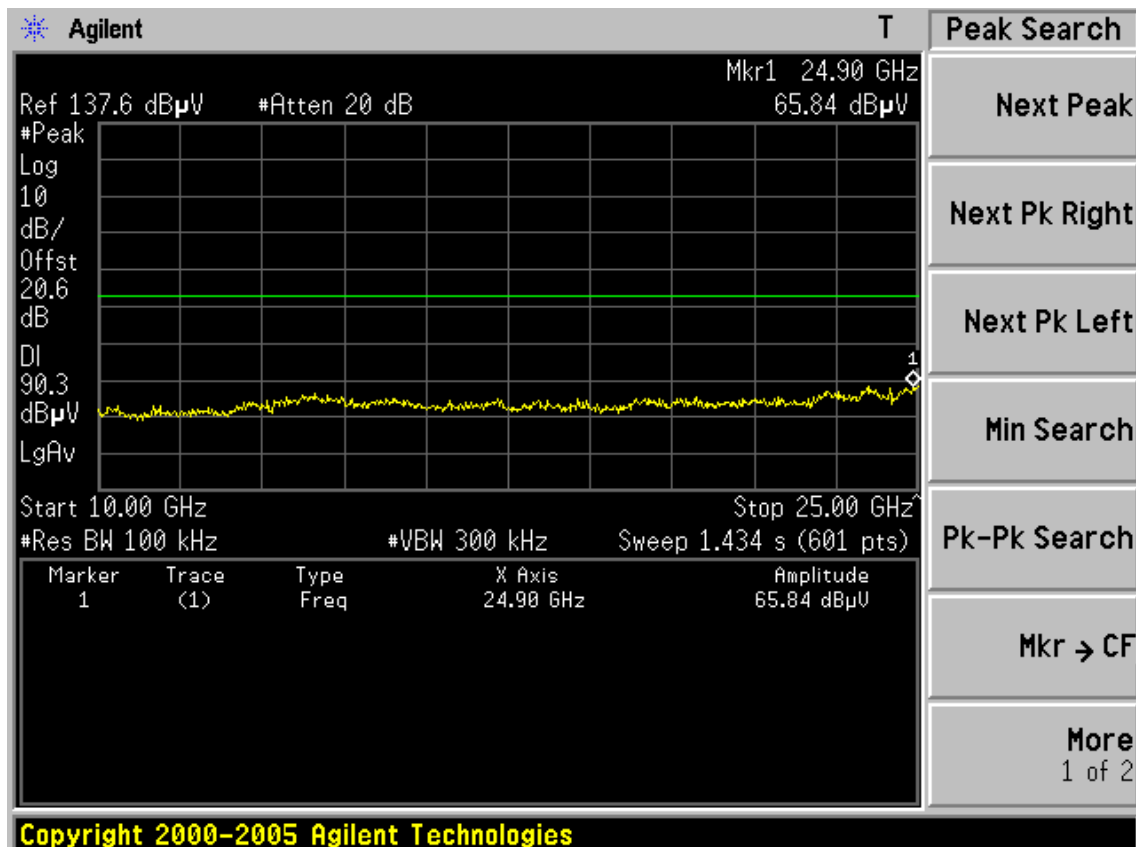
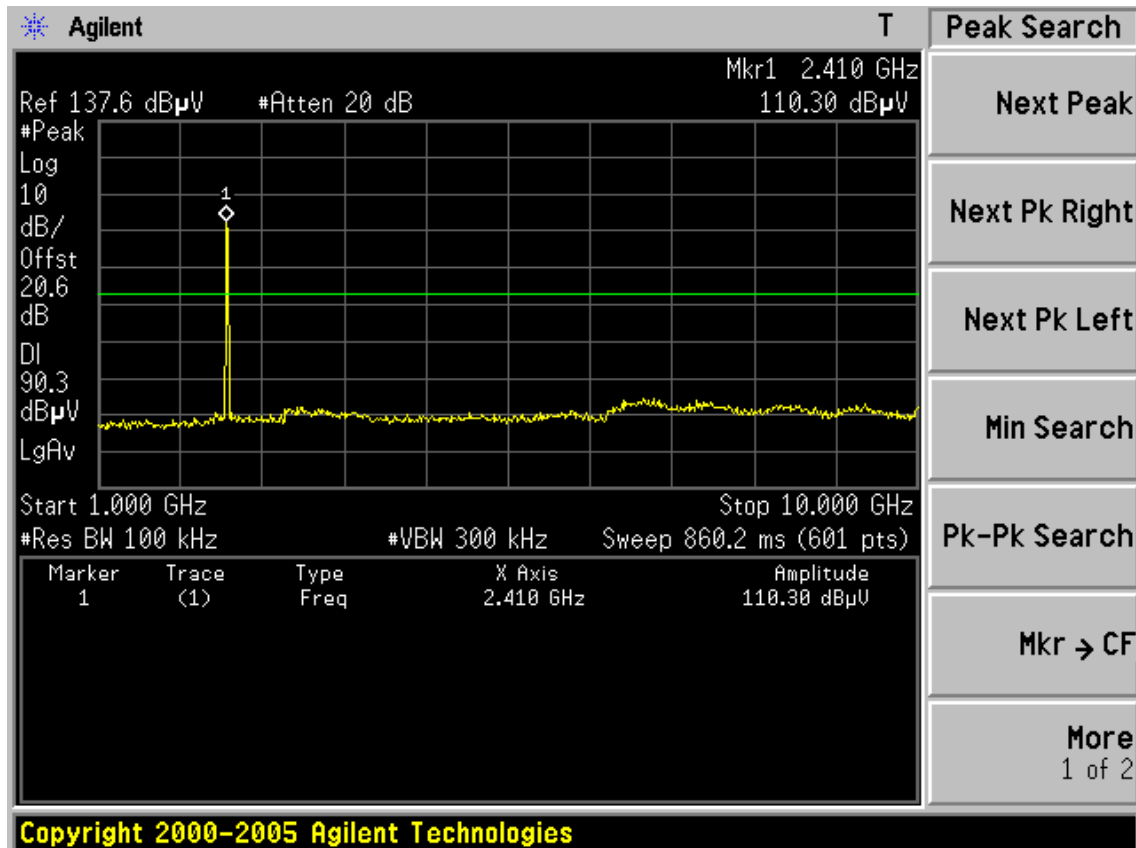

Agilent
T

Ref 137.6 dB μ V #Atten 20 dB
 #Peak
 Log
 10
 dB/
 Offst
 20.6
 dB
 DI
 90.3
 dB μ V
 LgAv

Mkr1 898.2 MHz
 60.39 dB μ V

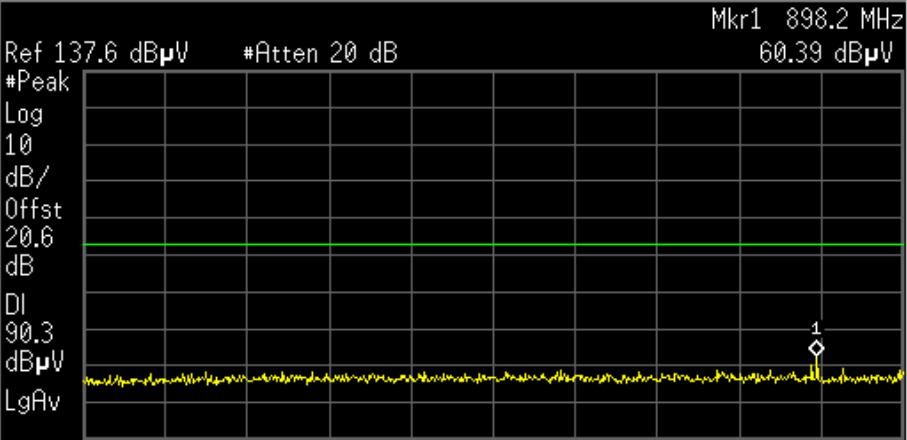

Start 30.0 MHz
Stop 1.000 0 GHz

#Res BW 100 kHz
#VBW 300 kHz
Sweep 92.72 ms (601 pts)

| Marker | Trace | Type | X Axis | Amplitude |
|--------|-------|------|-----------|------------------|
| 1 | (1) | Freq | 898.2 MHz | 60.39 dB μ V |

Peak Search
 Next Peak
 Next Pk Right
 Next Pk Left
 Min Search
 Pk-Pk Search
 Mkr \rightarrow CF
 More
 1 of 2

Copyright 2000-2005 Agilent Technologies

Agilent
T

Ref 137.6 dB μ V #Atten 20 dB
 #Peak
 Log
 10
 dB/
 Offst
 20.6
 dB
 DI
 91.1
 dB μ V
 LgAv

Mkr3 2.400 0 GHz
 71.01 dB μ V

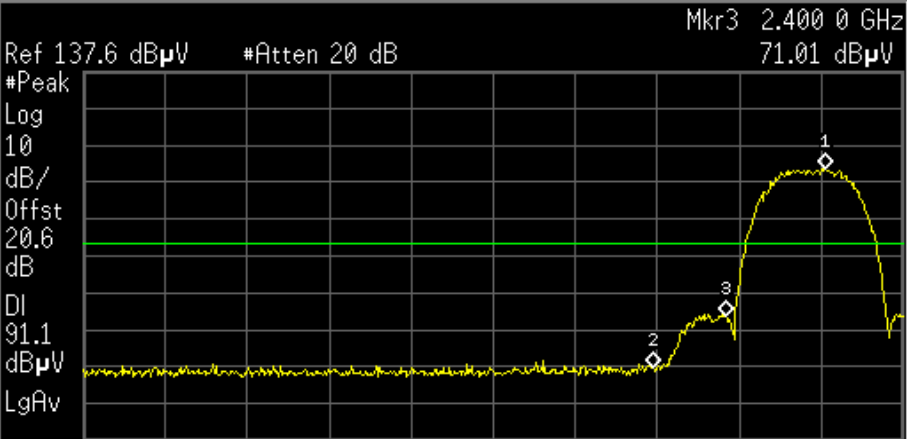

Start 2.310 0 GHz
Stop 2.425 0 GHz

#Res BW 100 kHz
#VBW 300 kHz
Sweep 11 ms (601 pts)

| Marker | Trace | Type | X Axis | Amplitude |
|--------|-------|------|-------------|-------------------|
| 1 | (1) | Freq | 2.414 1 GHz | 111.13 dB μ V |
| 2 | (1) | Freq | 2.390 0 GHz | 57.42 dB μ V |
| 3 | (1) | Freq | 2.400 0 GHz | 71.01 dB μ V |

Marker
 Select Marker
 1 2 3 4
 Normal
 Delta
 Delta Pair
 (Tracking Ref)
 Ref \triangle
 Span Pair
 Span Center
 Off
 More
 1 of 2

Copyright 2000-2005 Agilent Technologies

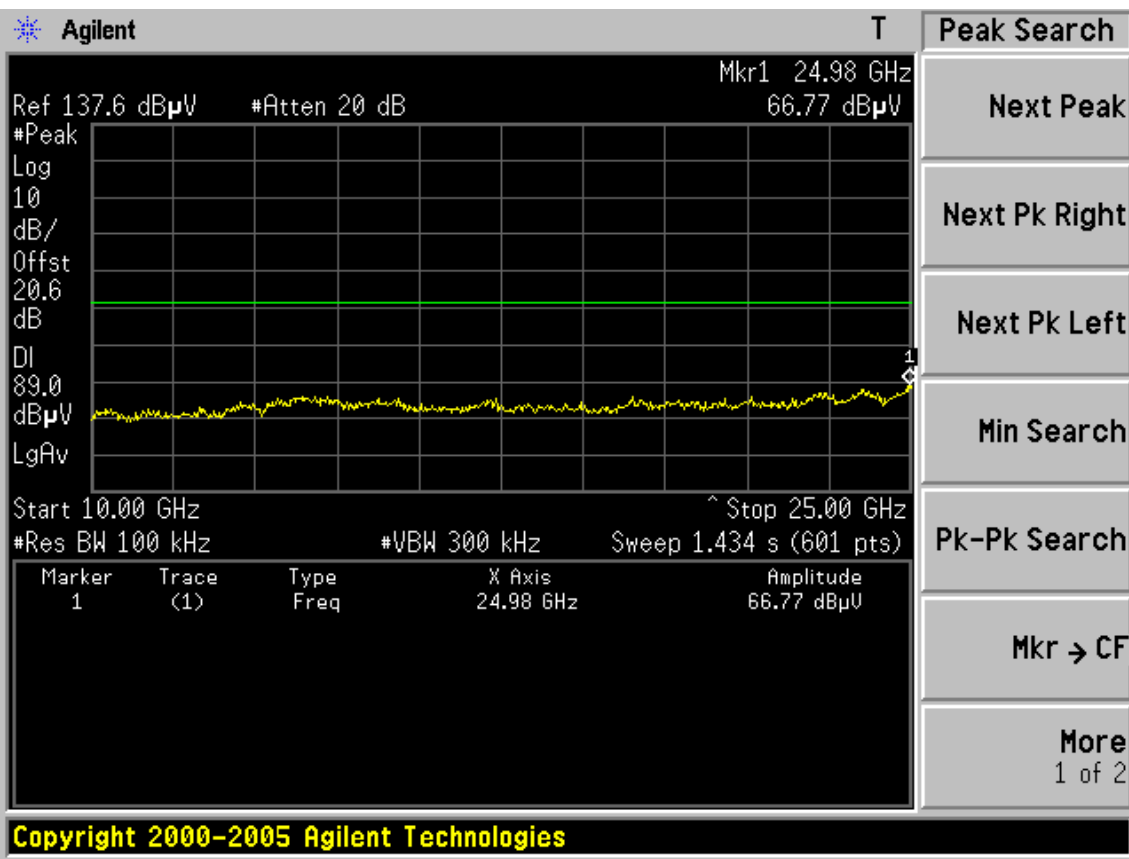
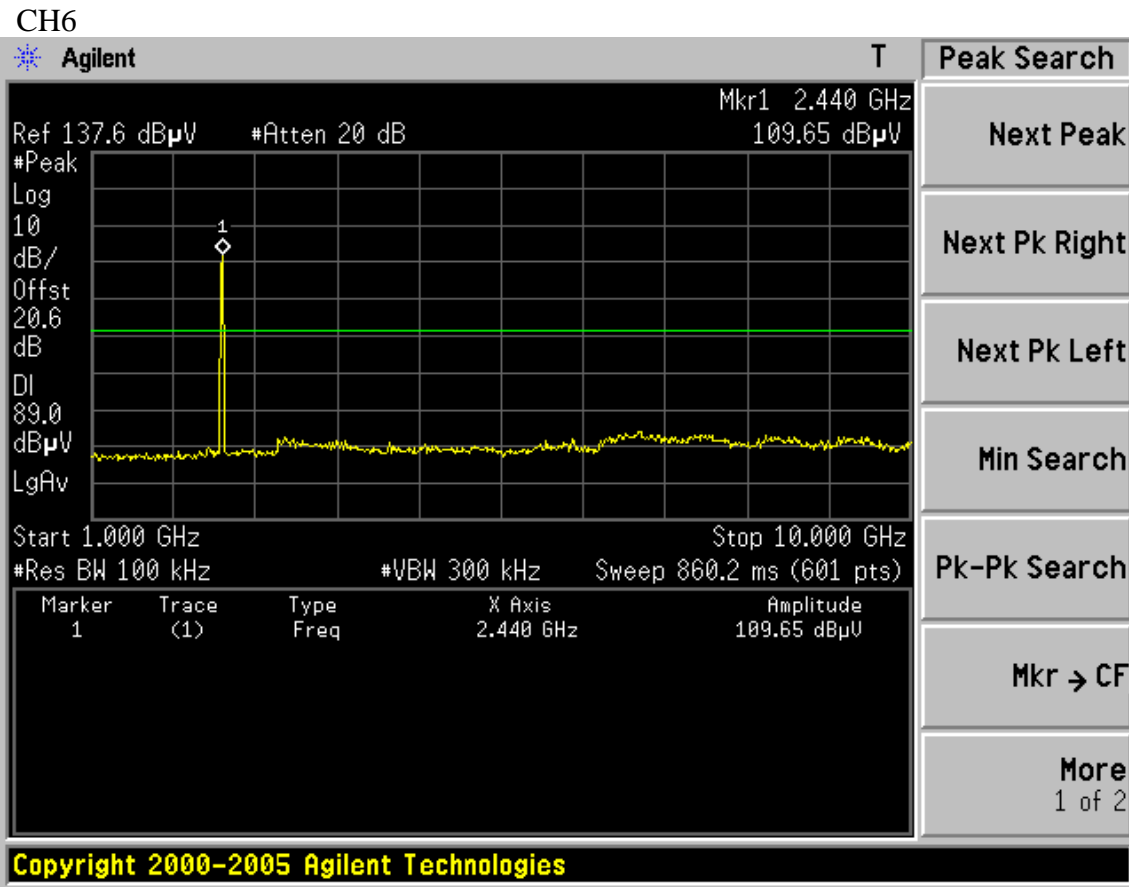

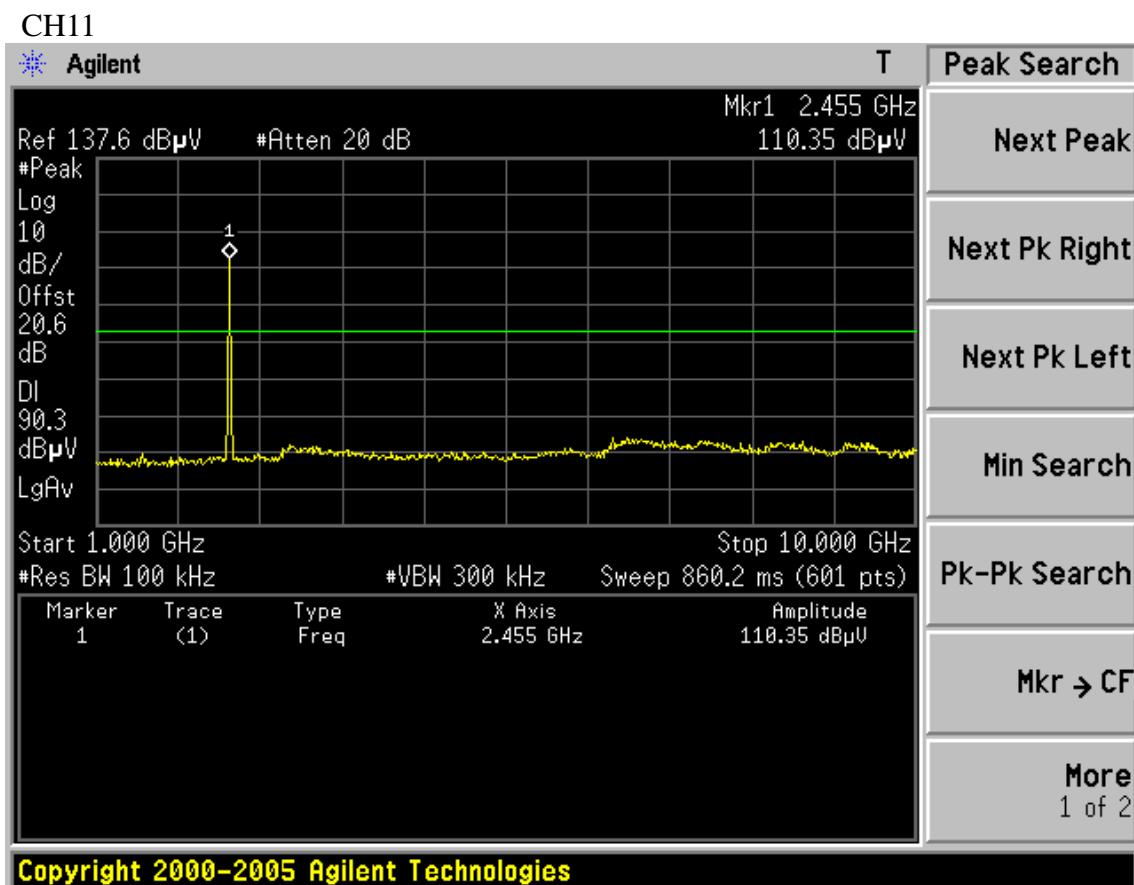
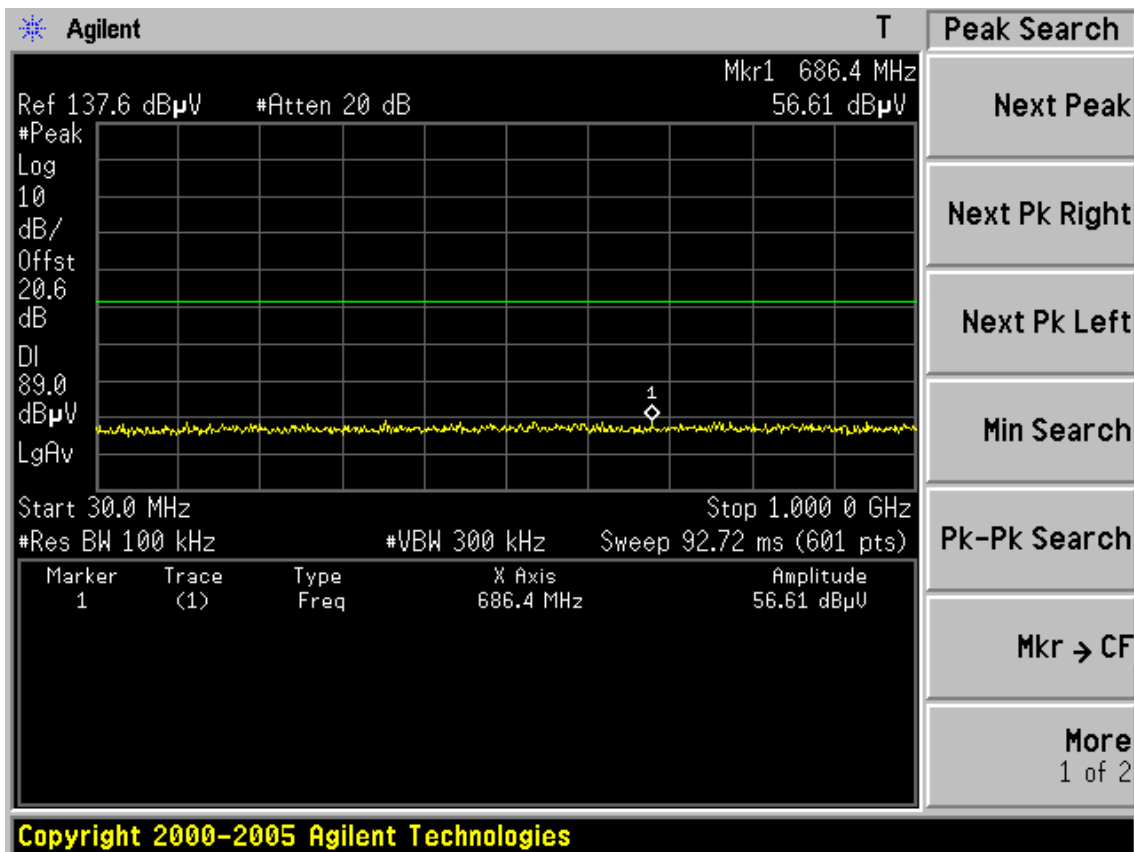

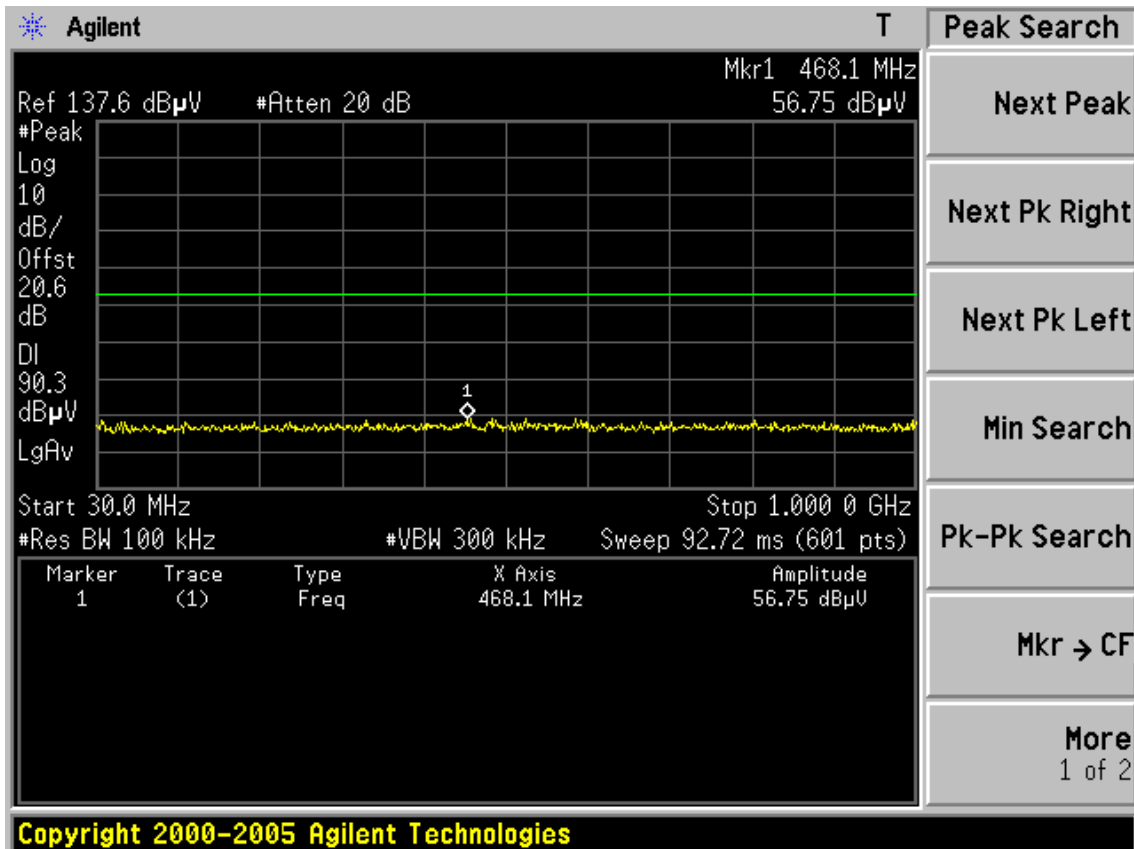
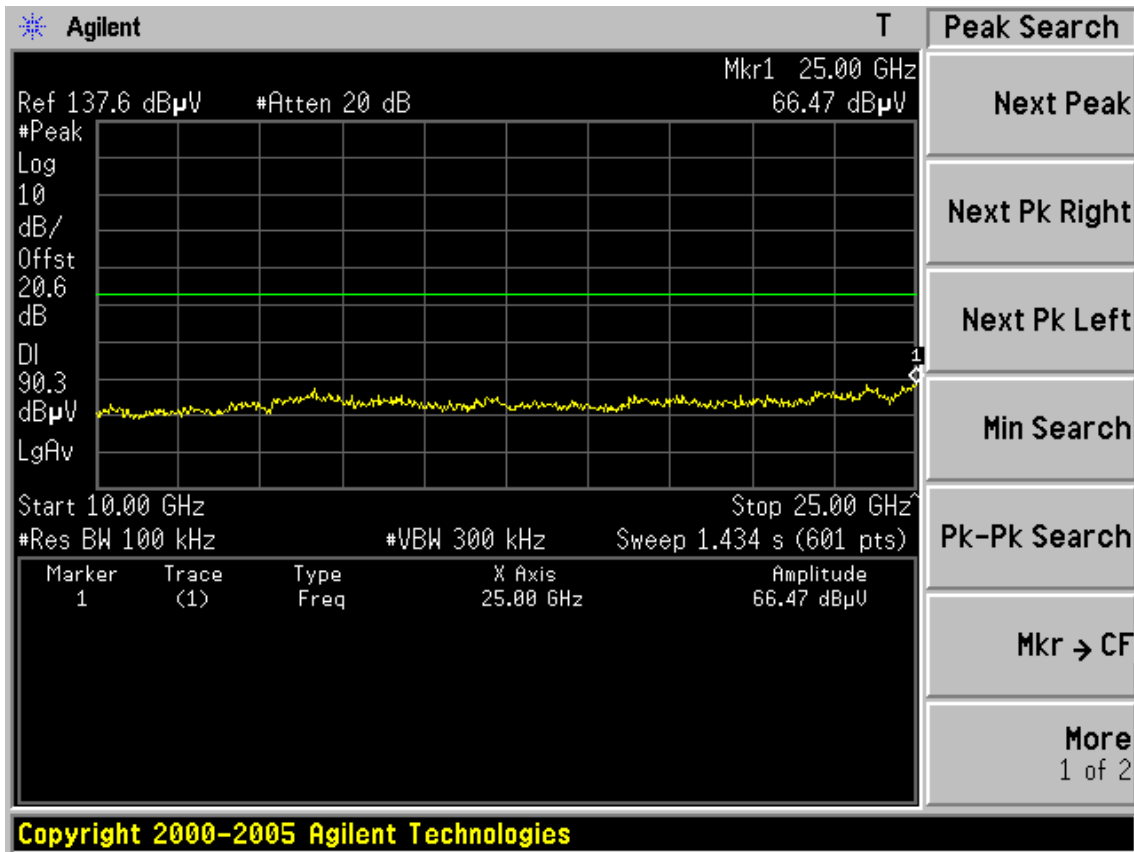

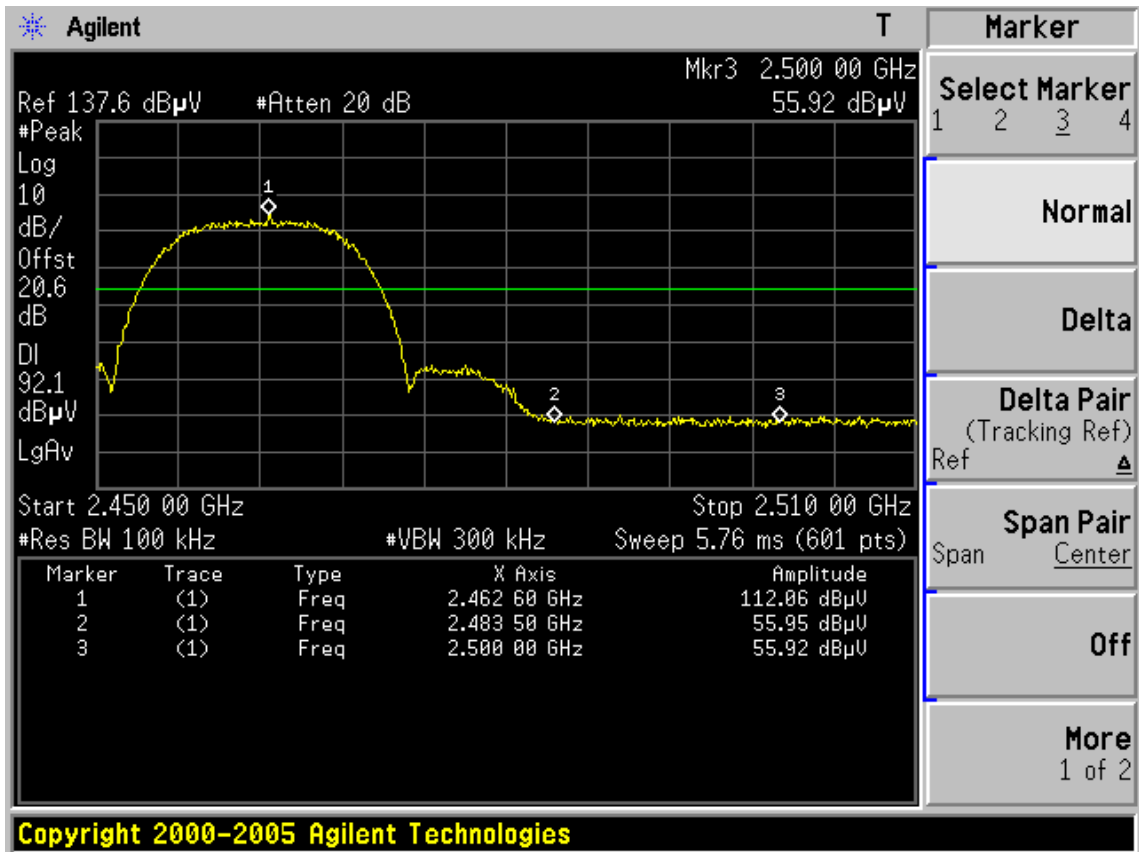

Test Mode: IEEE 802.11g TX
CH1

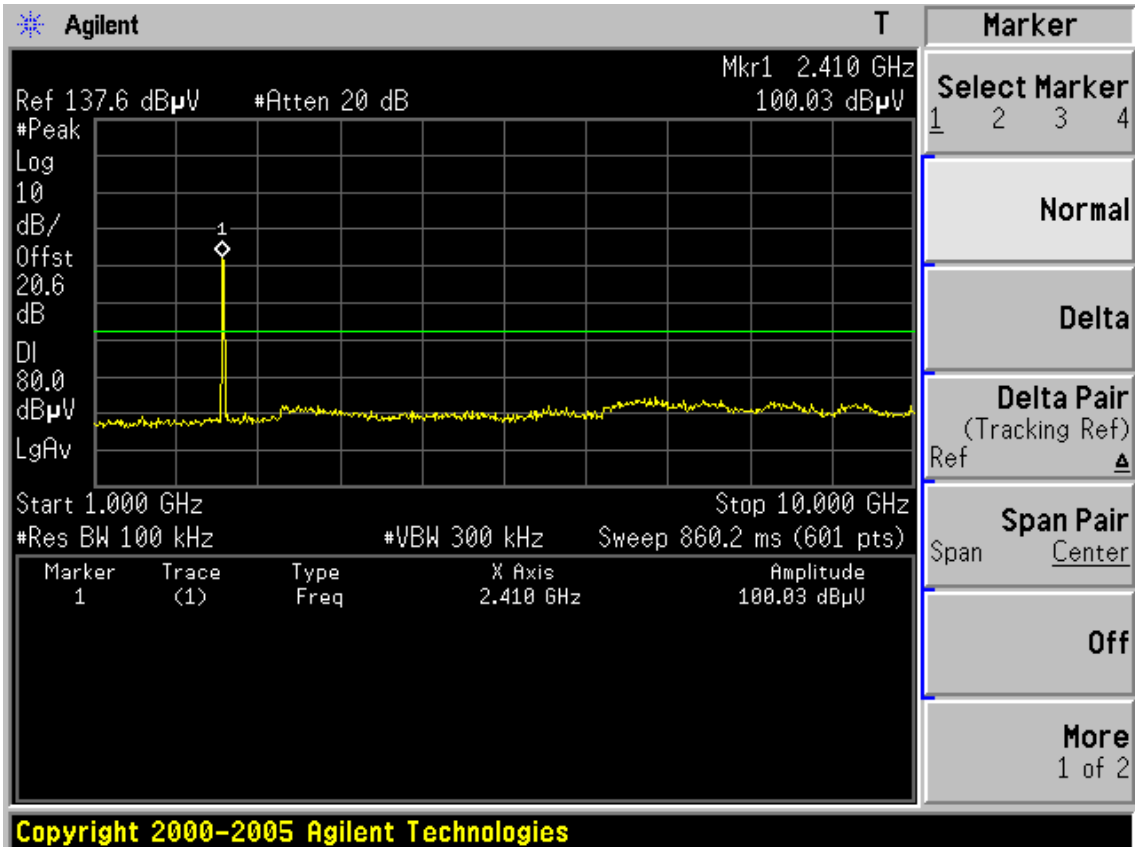

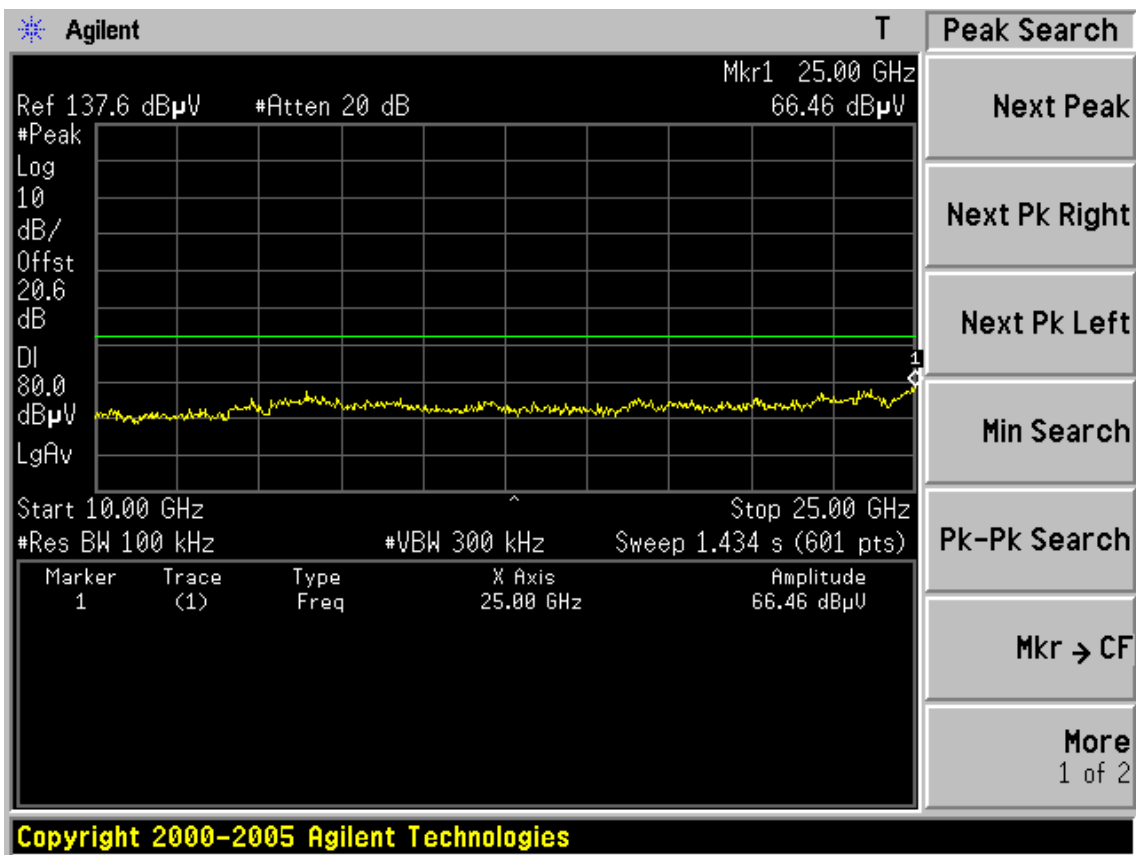
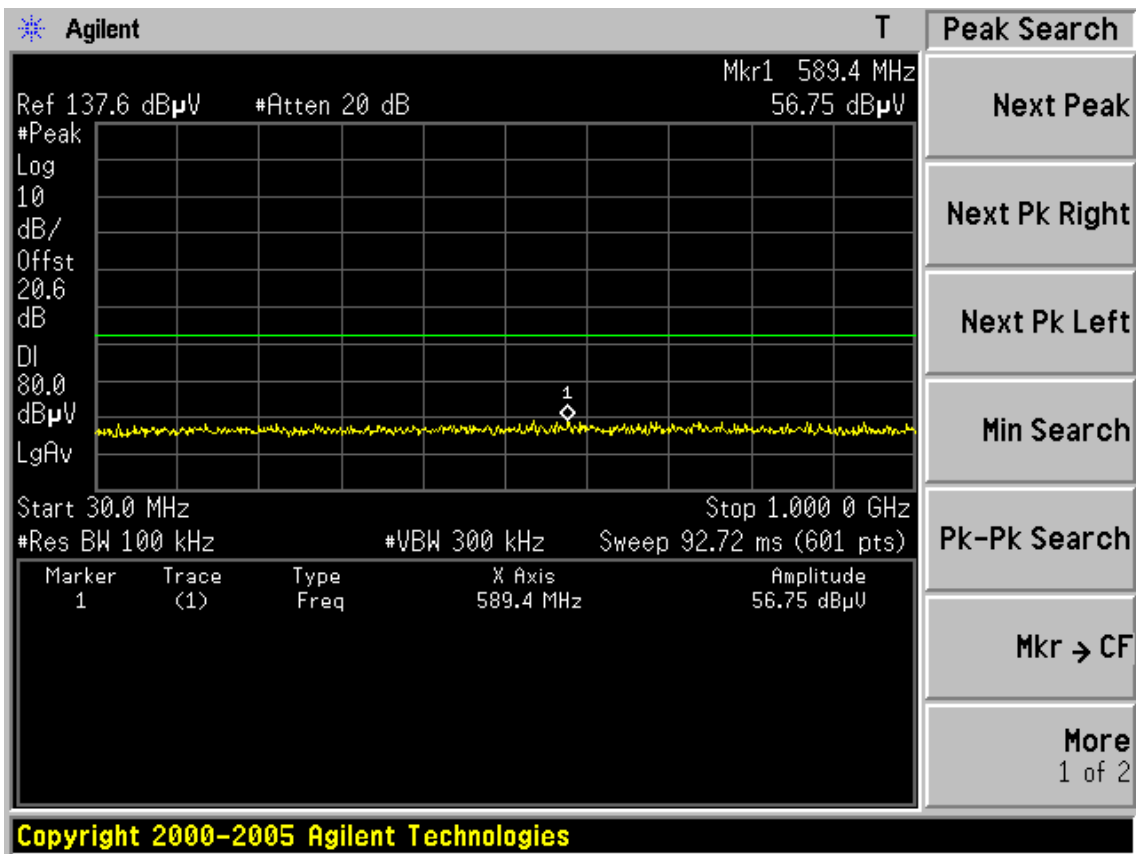

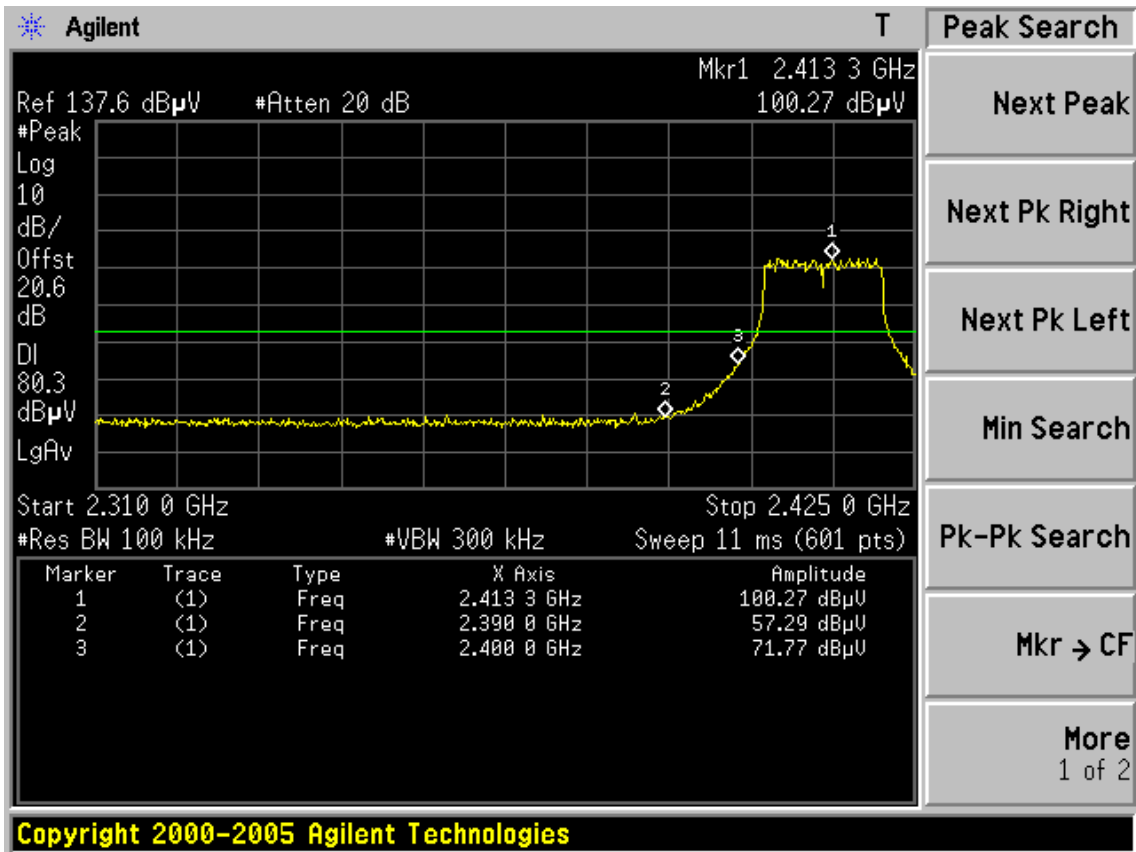

CH6

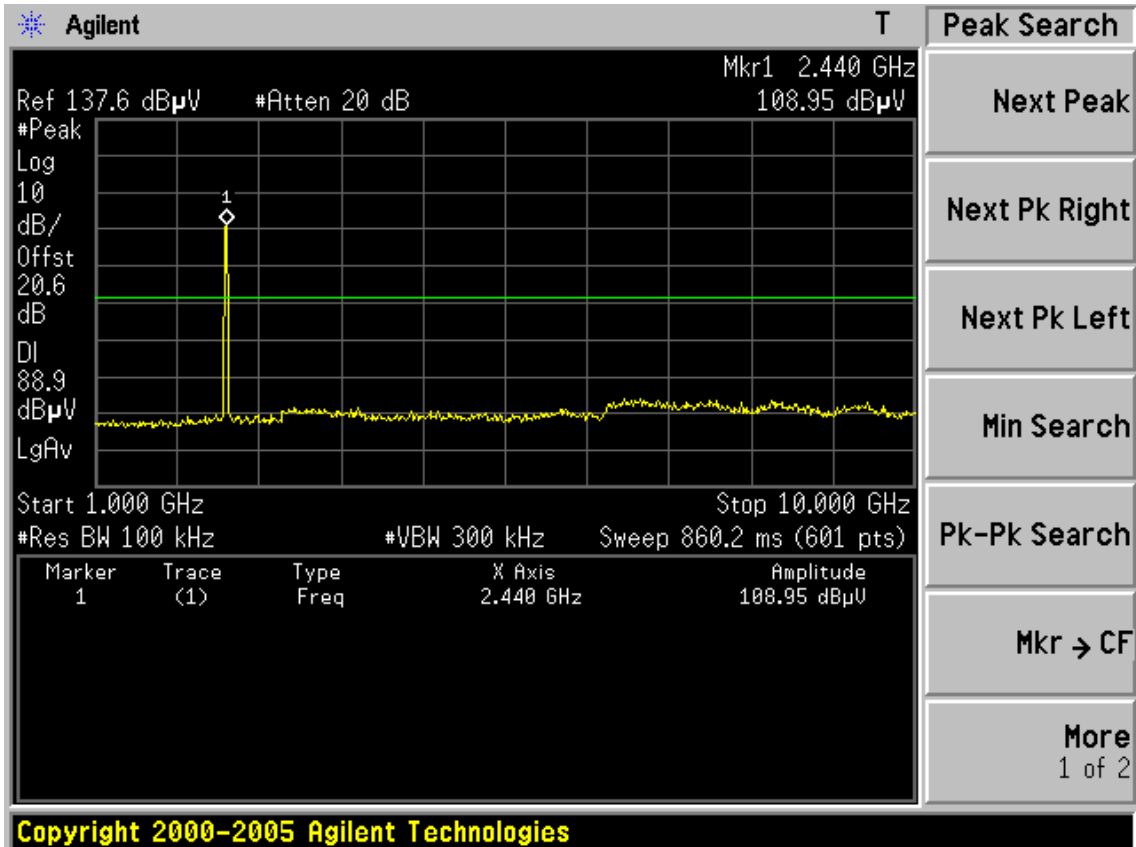

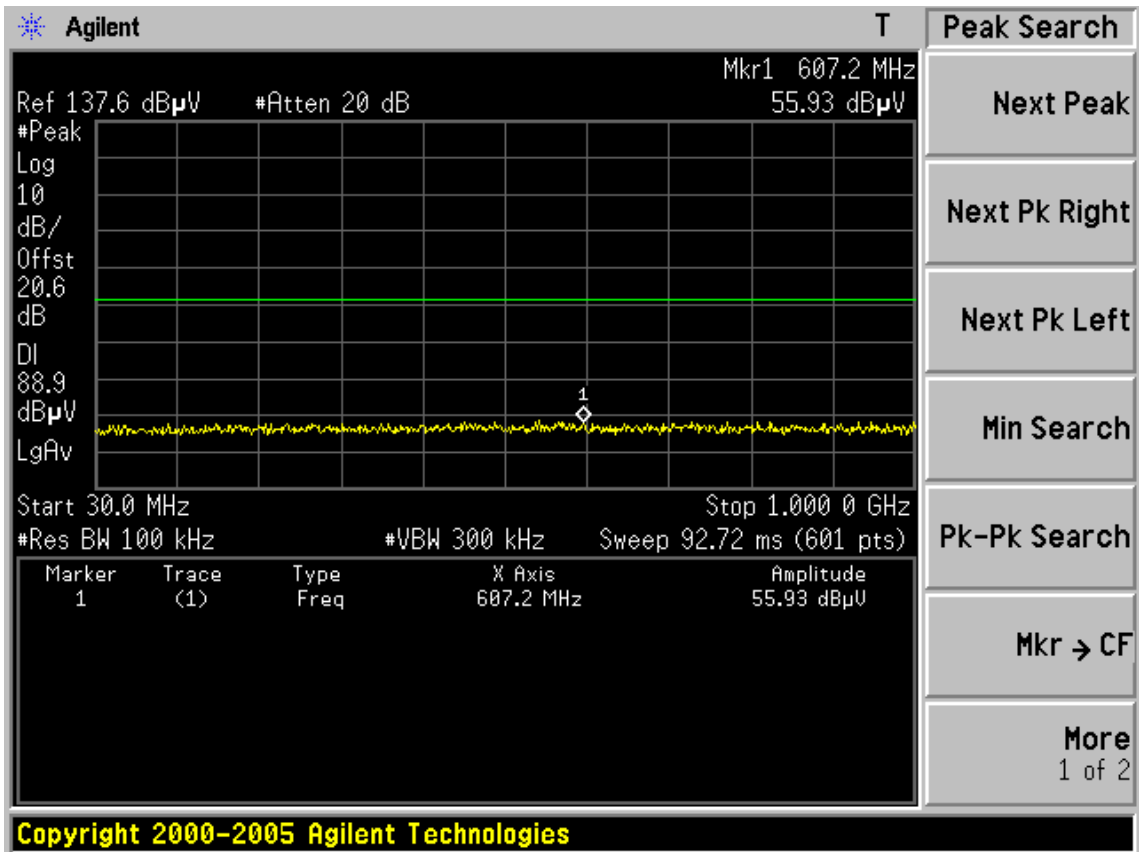
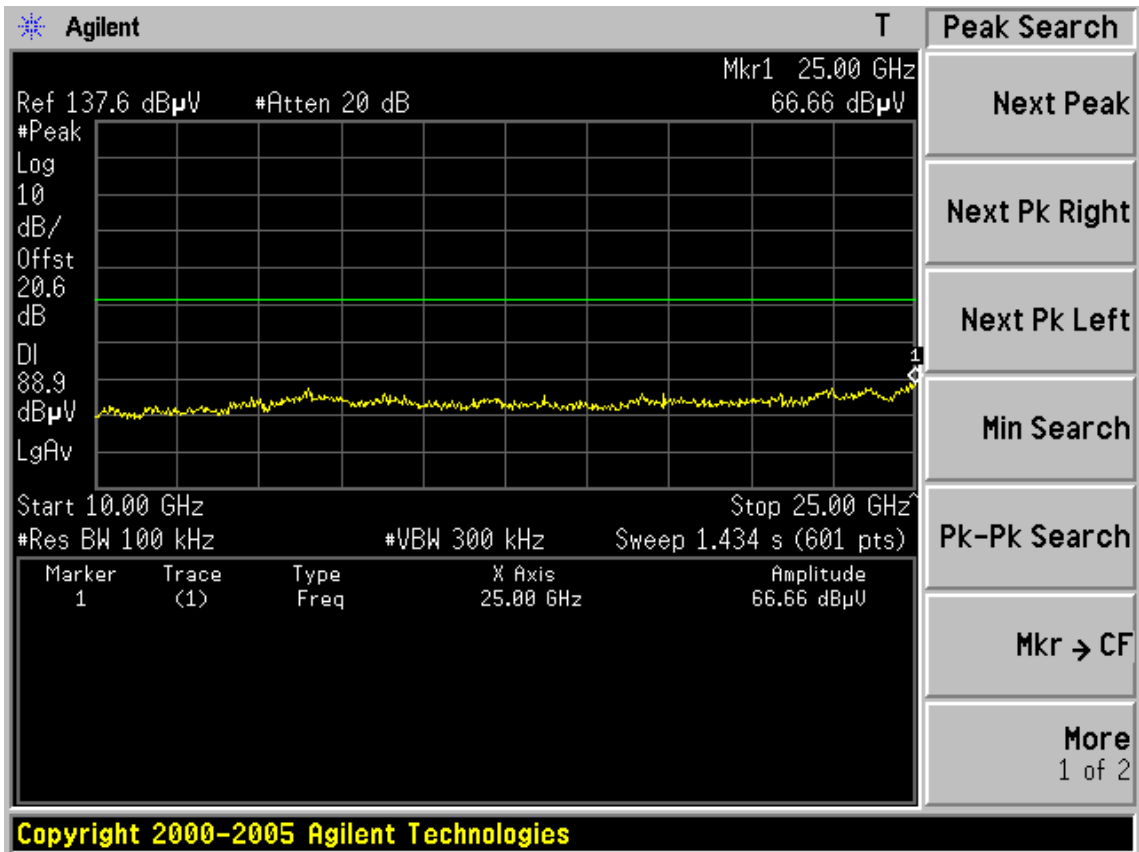

CH11

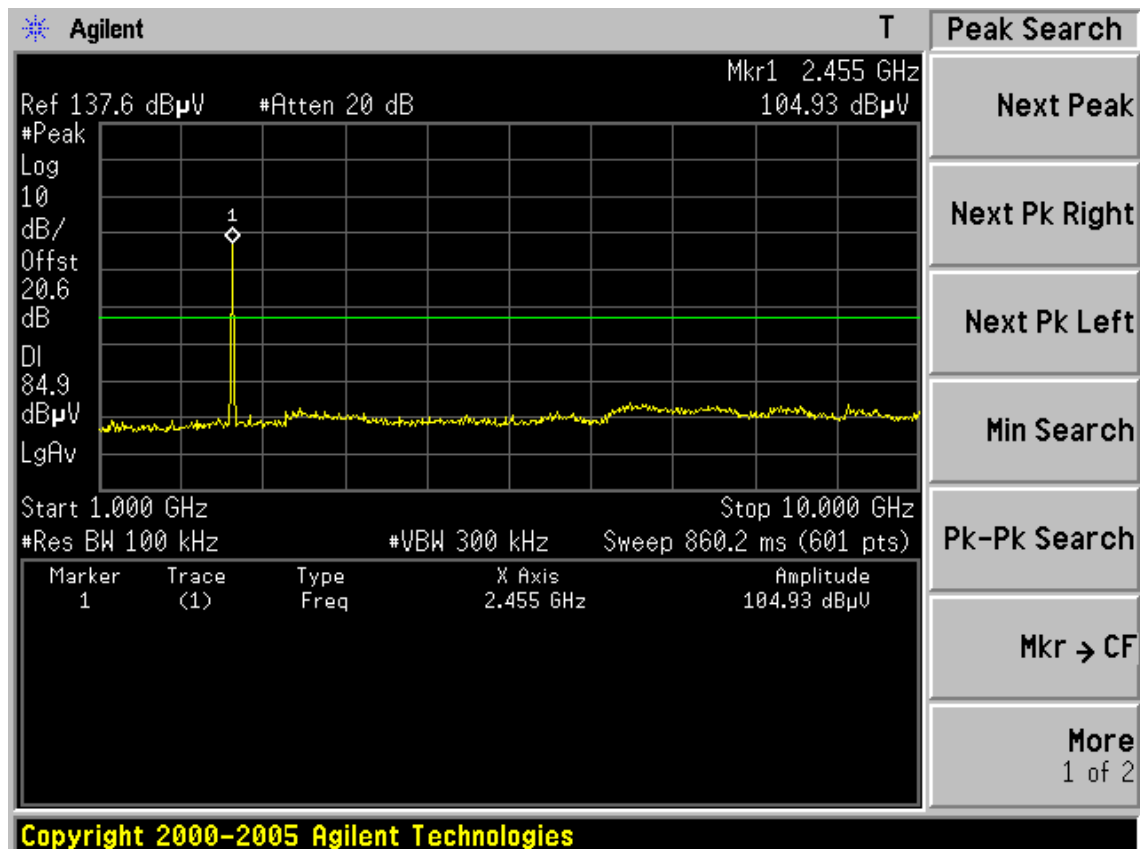
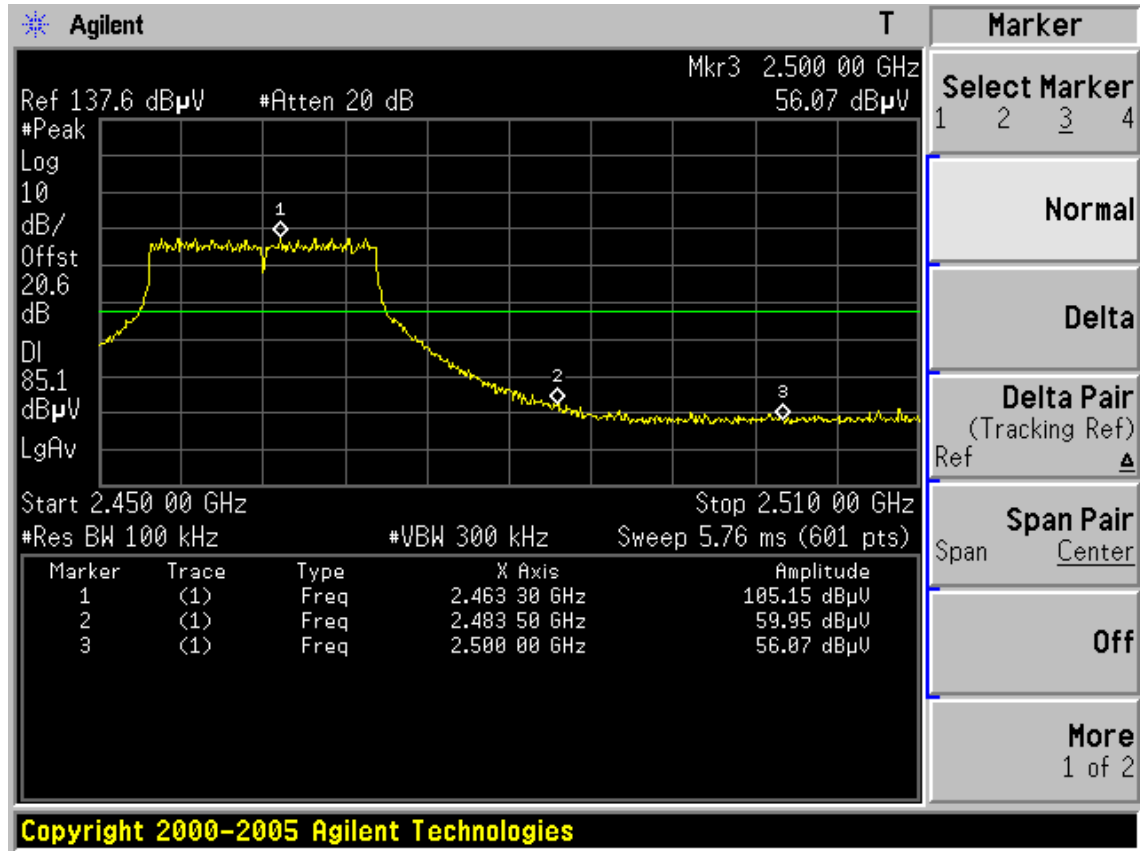

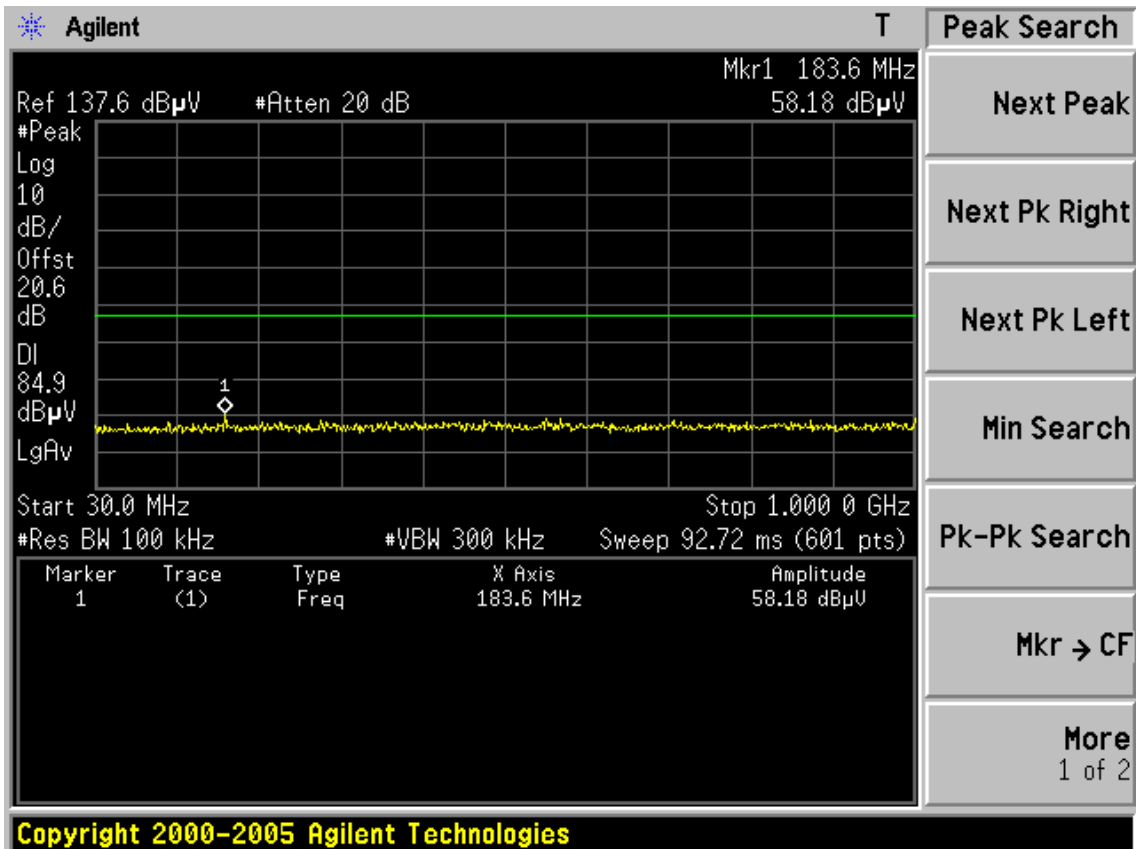
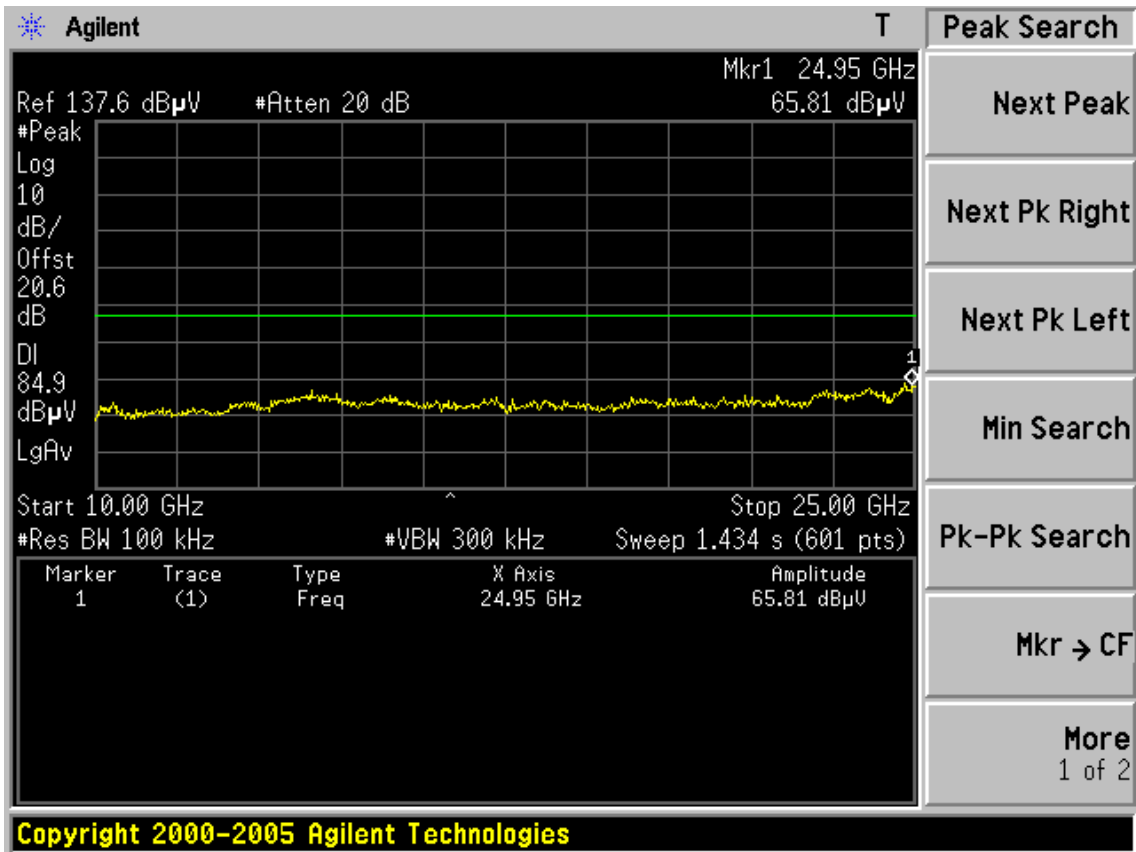

Test Mode: IEEE 802.11n HT20 TX
CH1

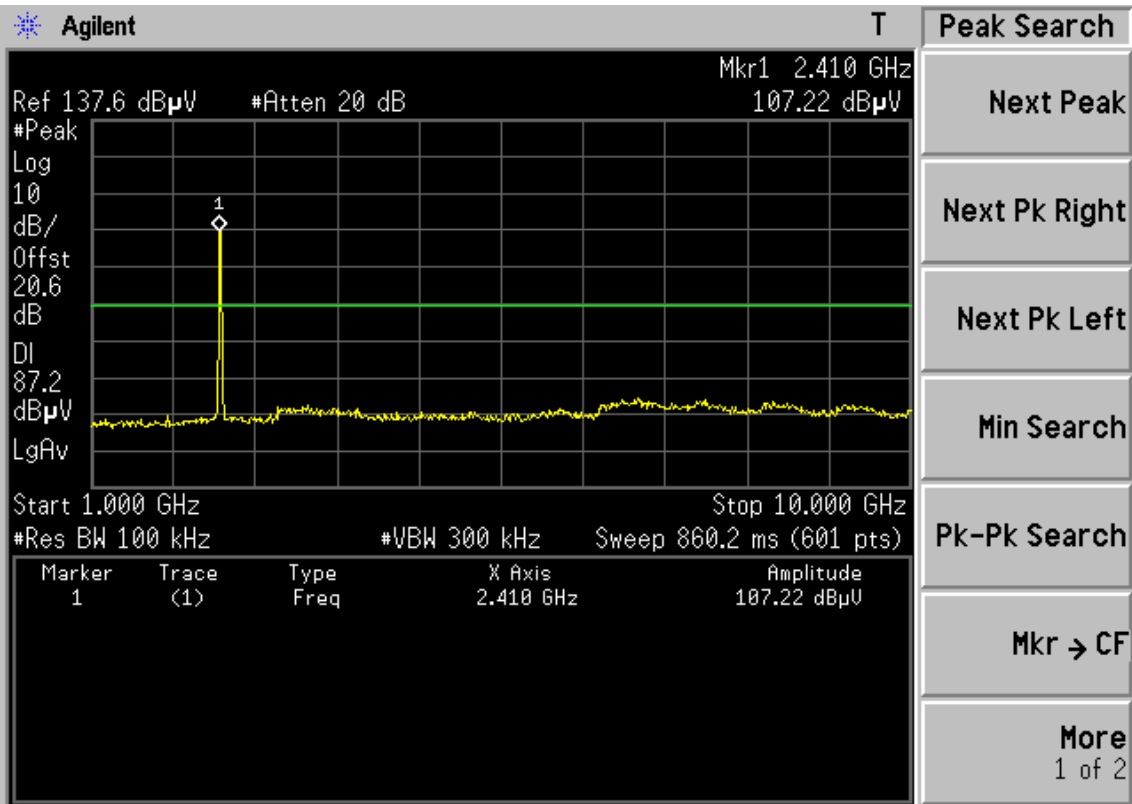

Copyright 2000-2005 Agilent Technologies

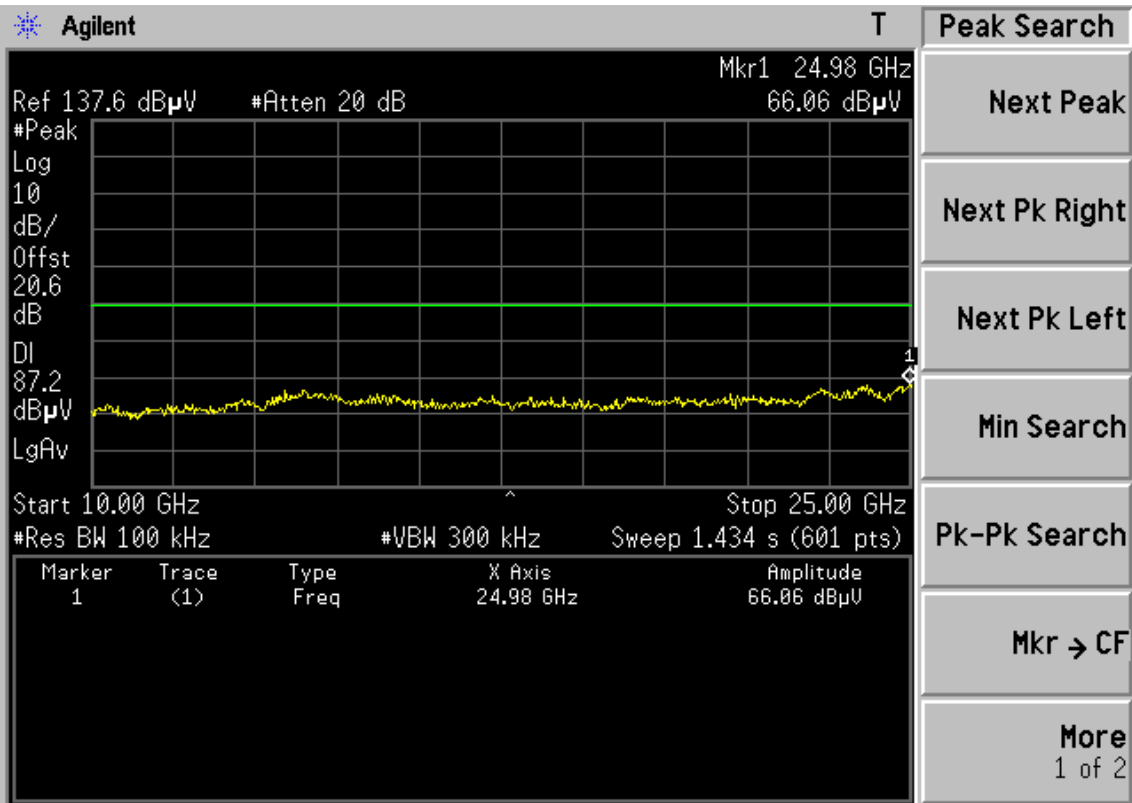

Copyright 2000-2005 Agilent Technologies

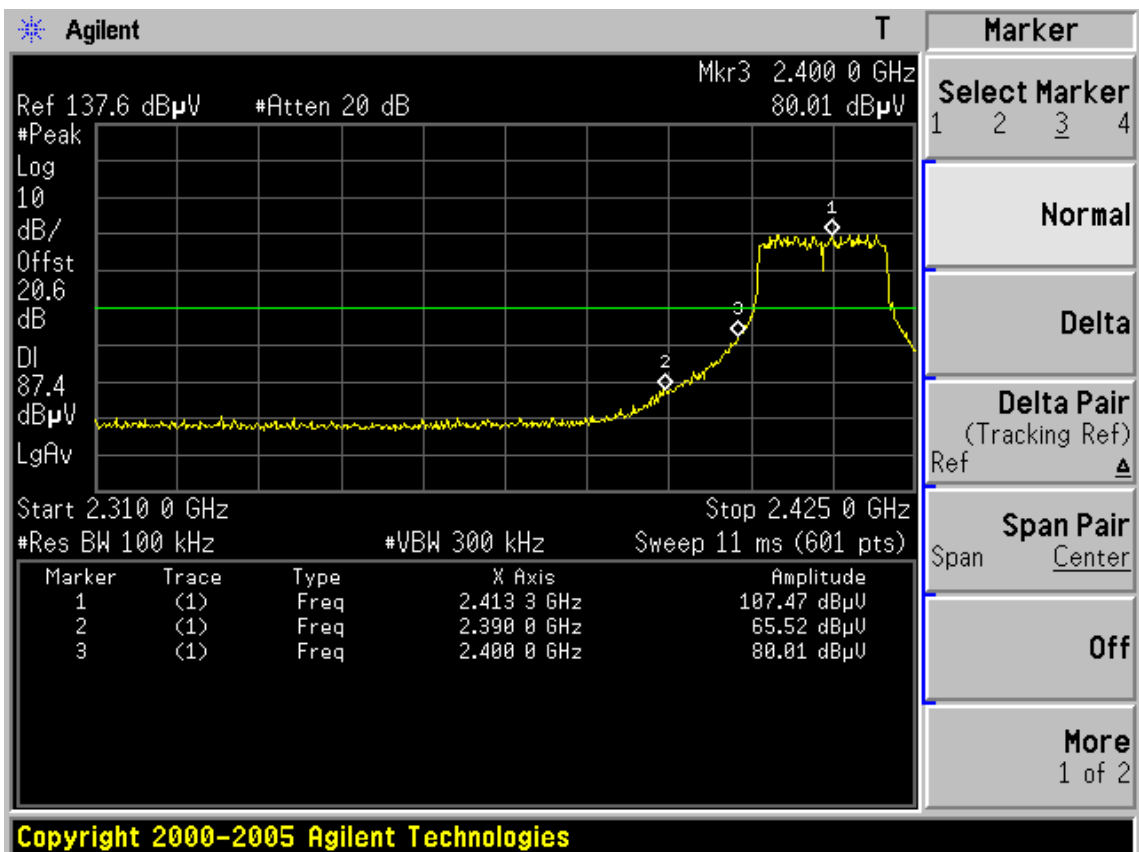
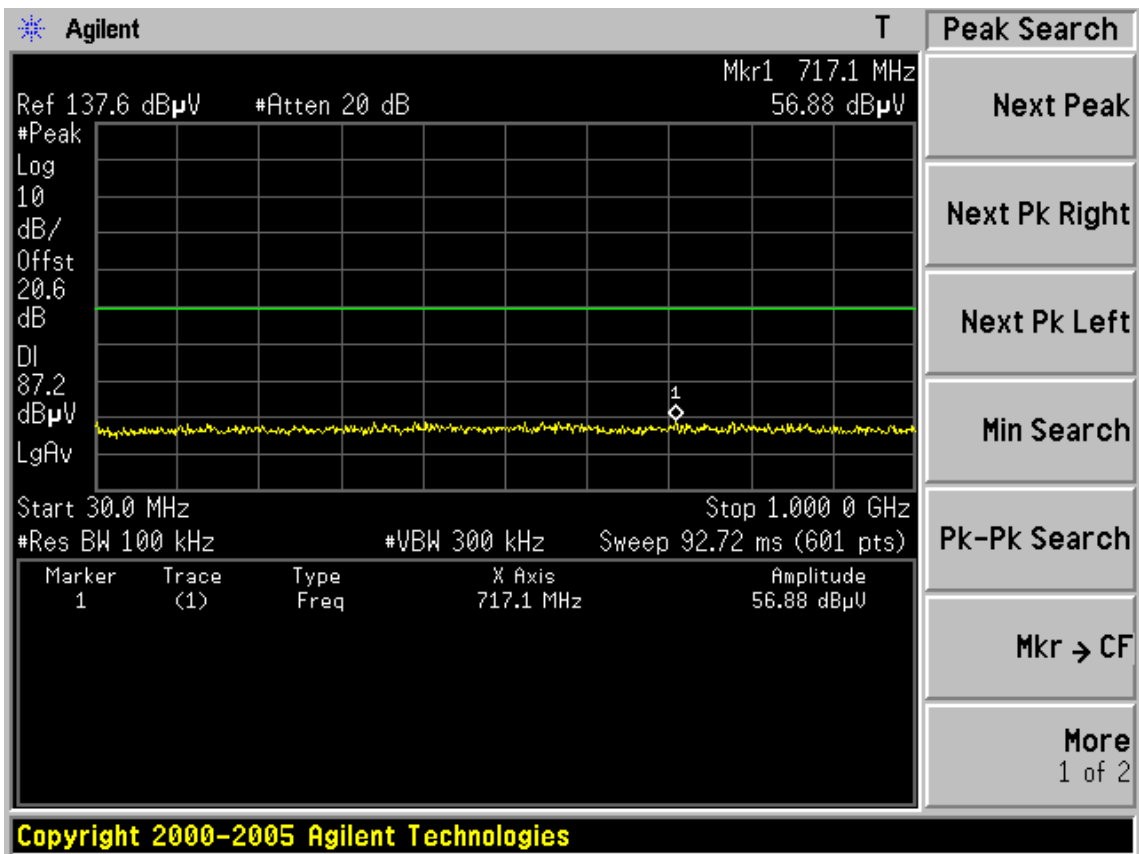

CH6

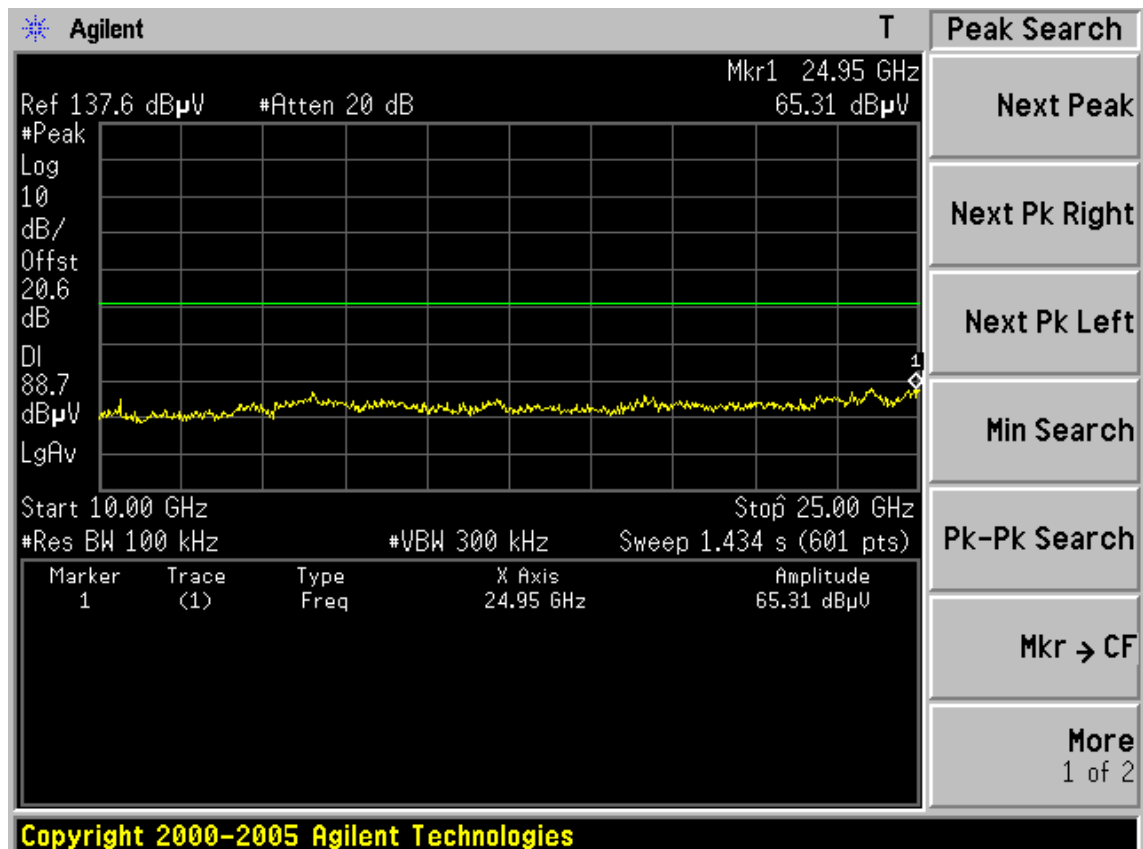
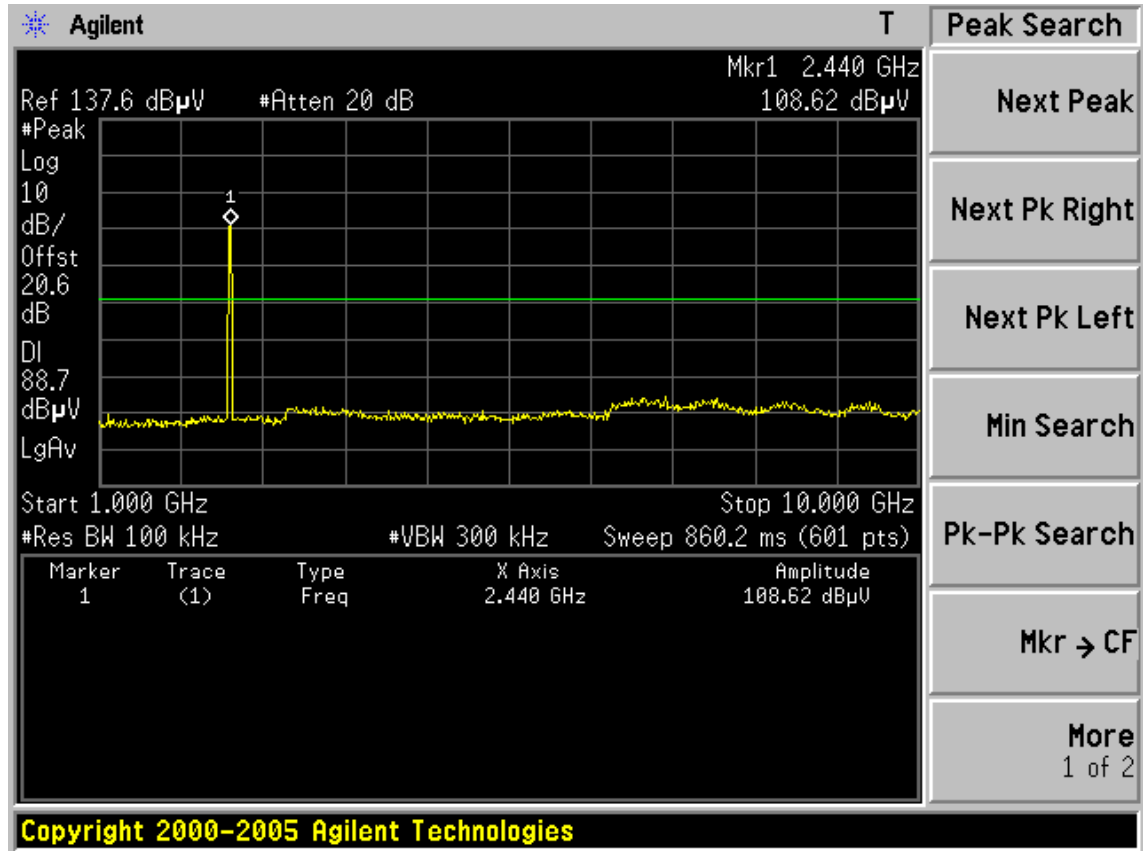

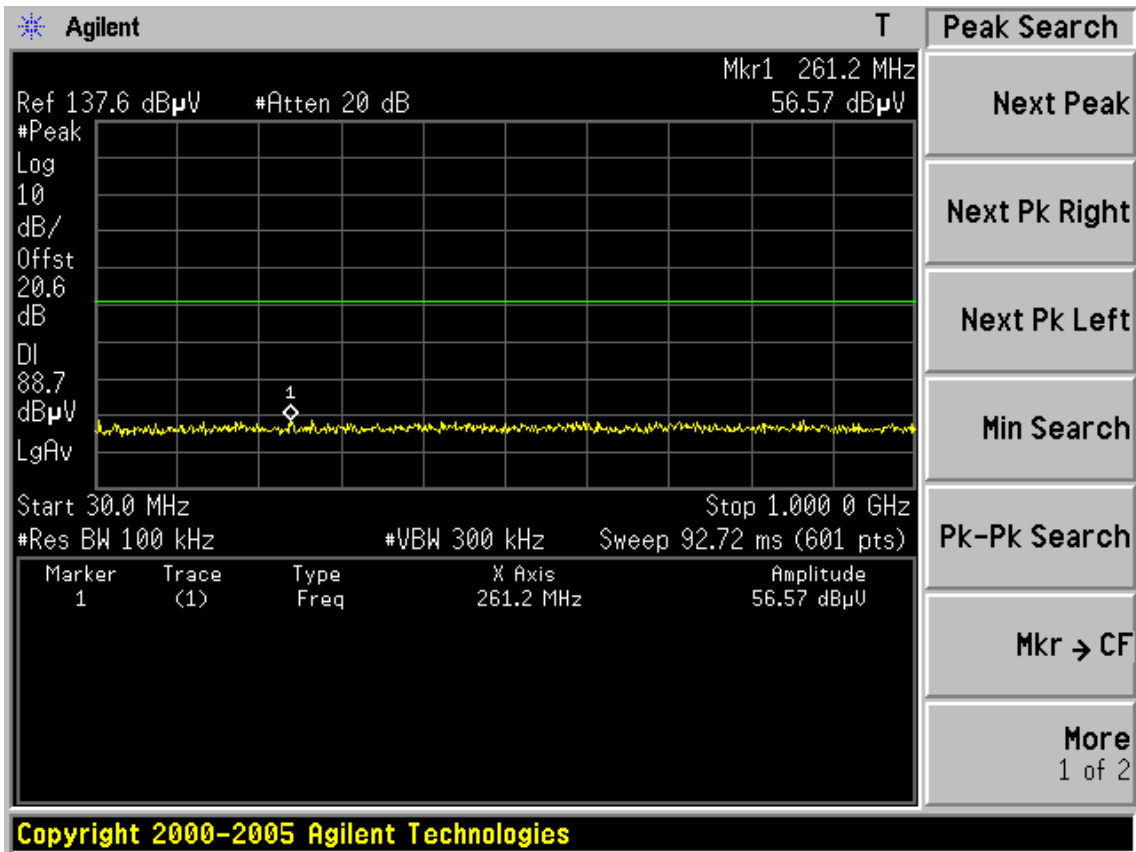

CH11

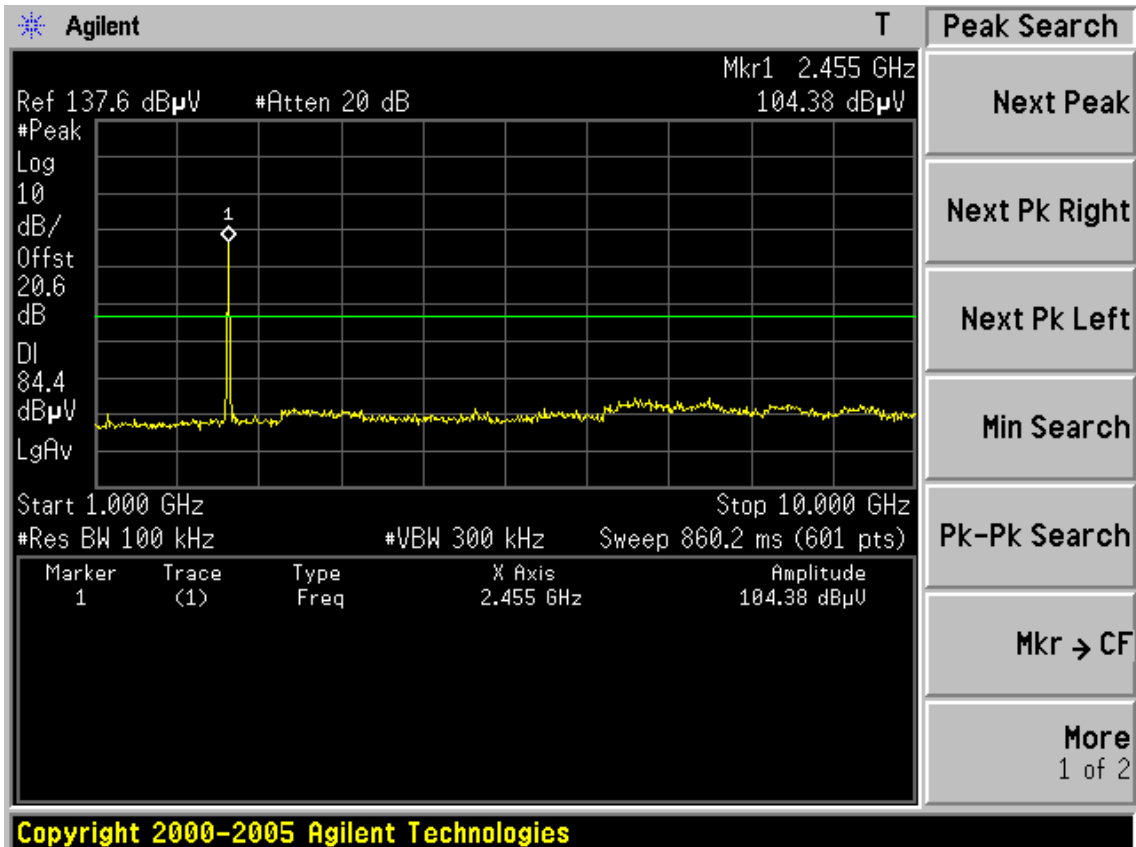

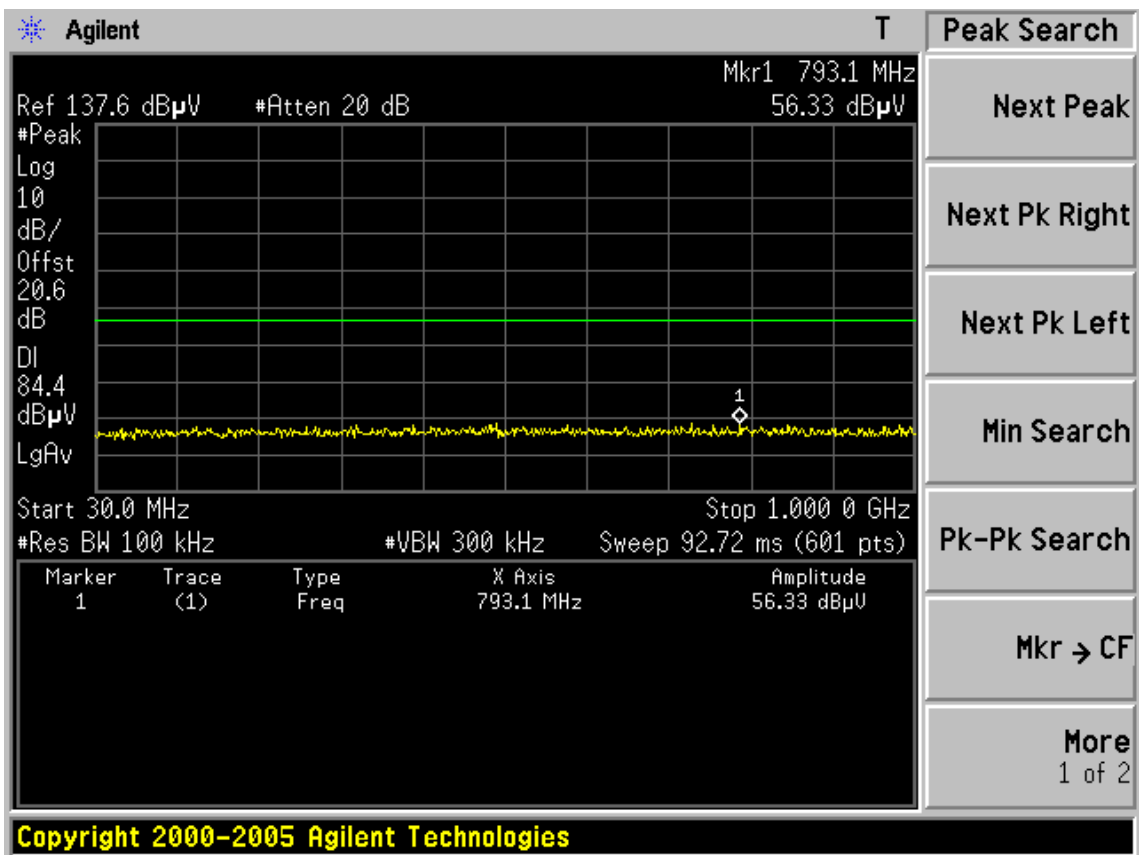
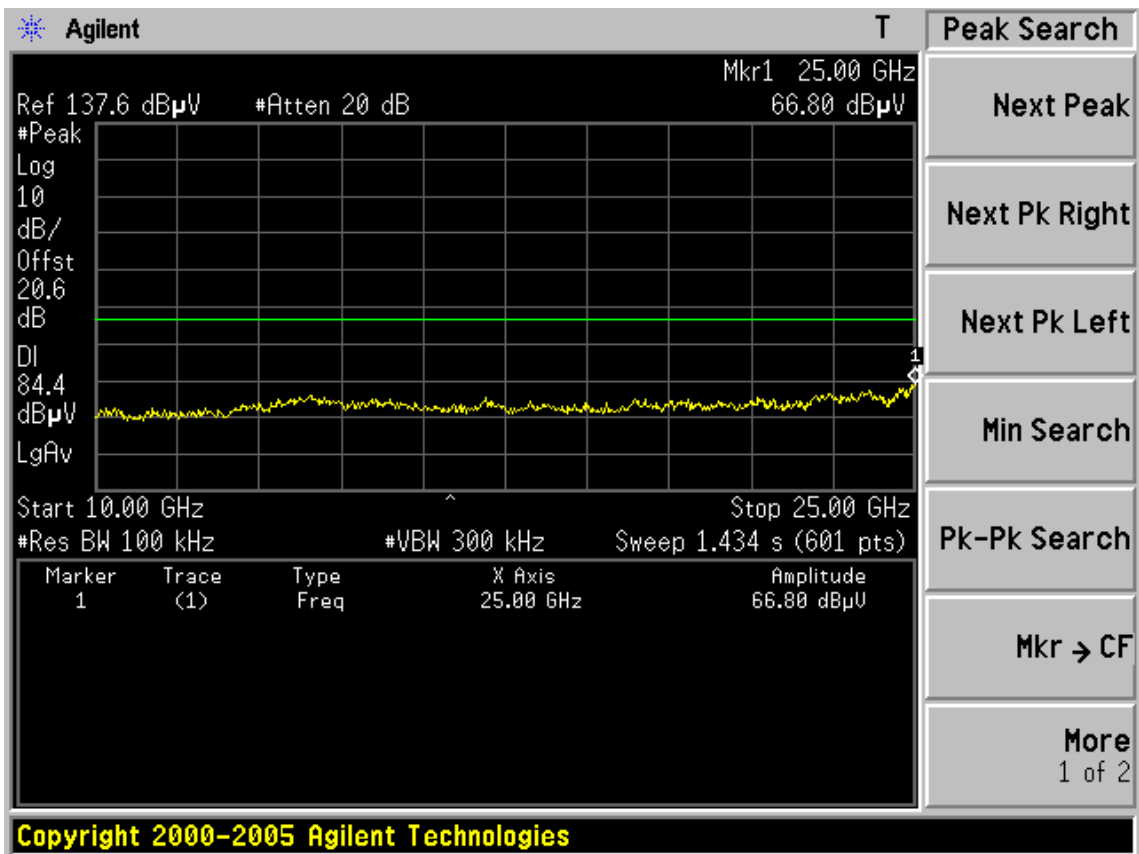

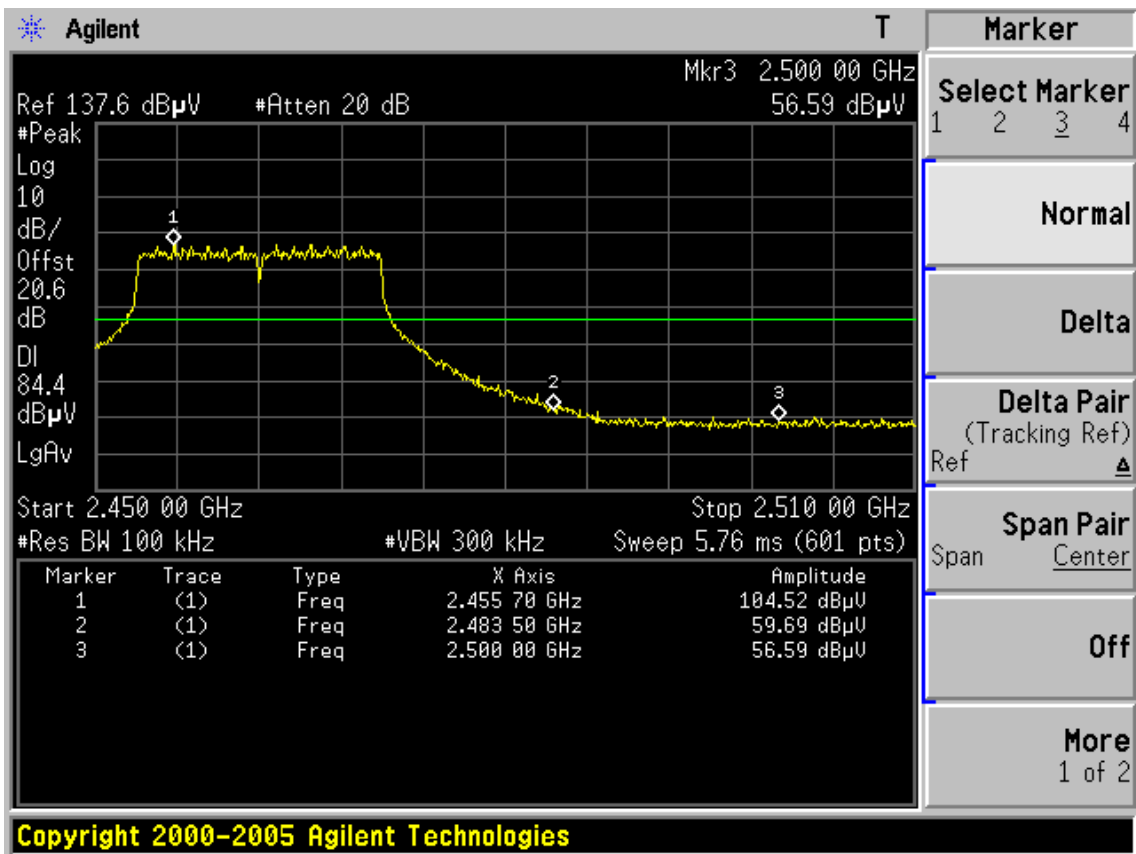

Test Mode: IEEE 802.11n HT40TX
CH3

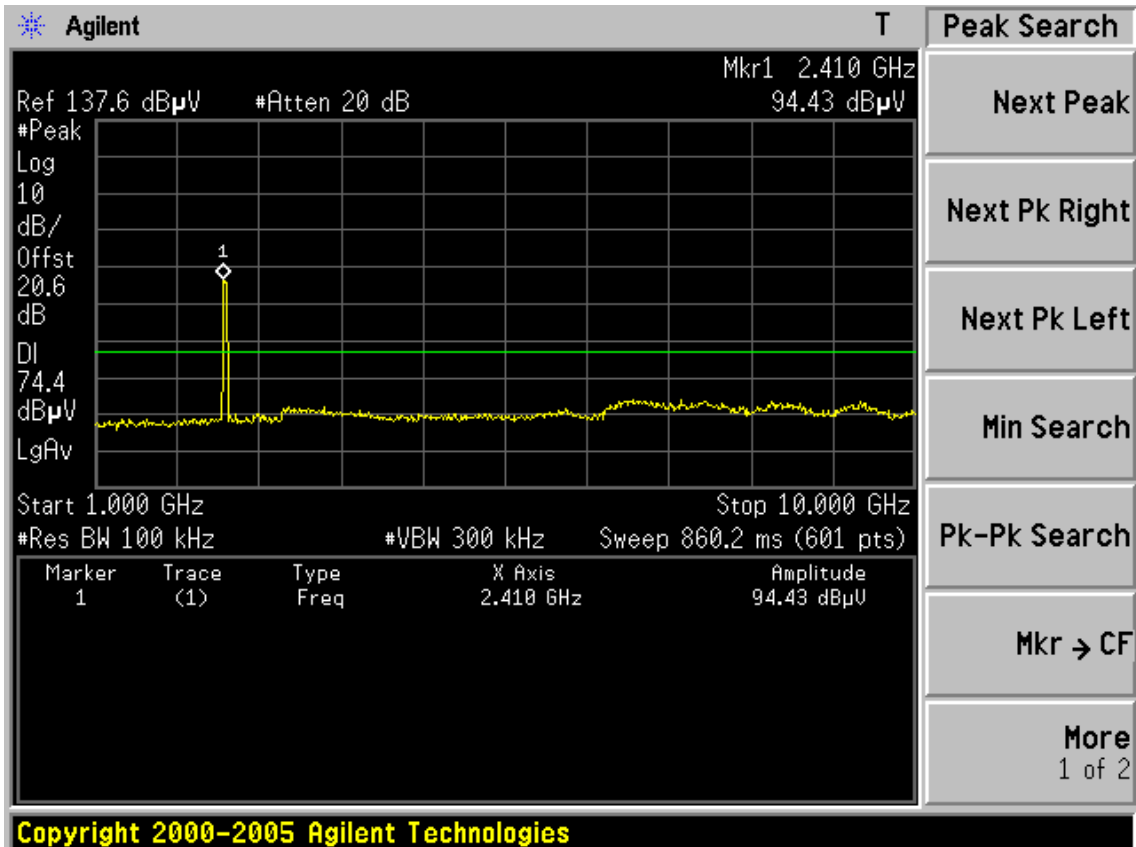

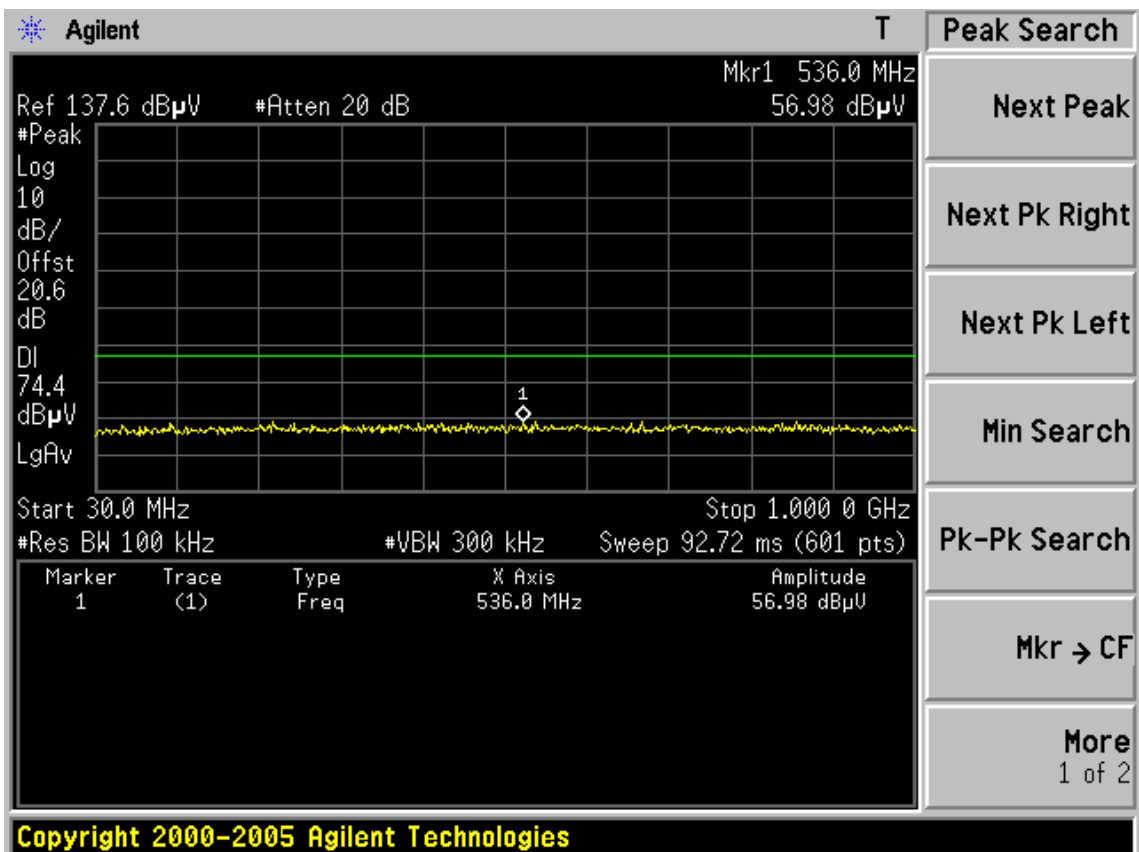
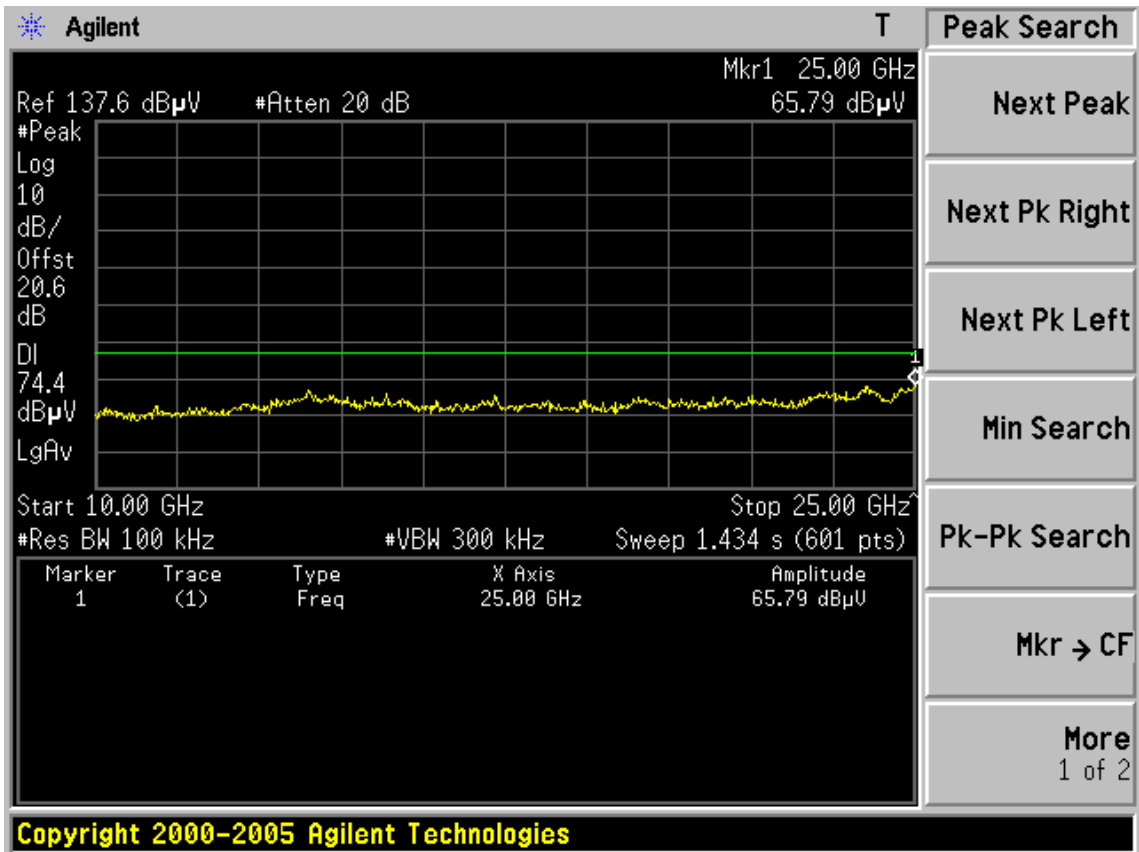

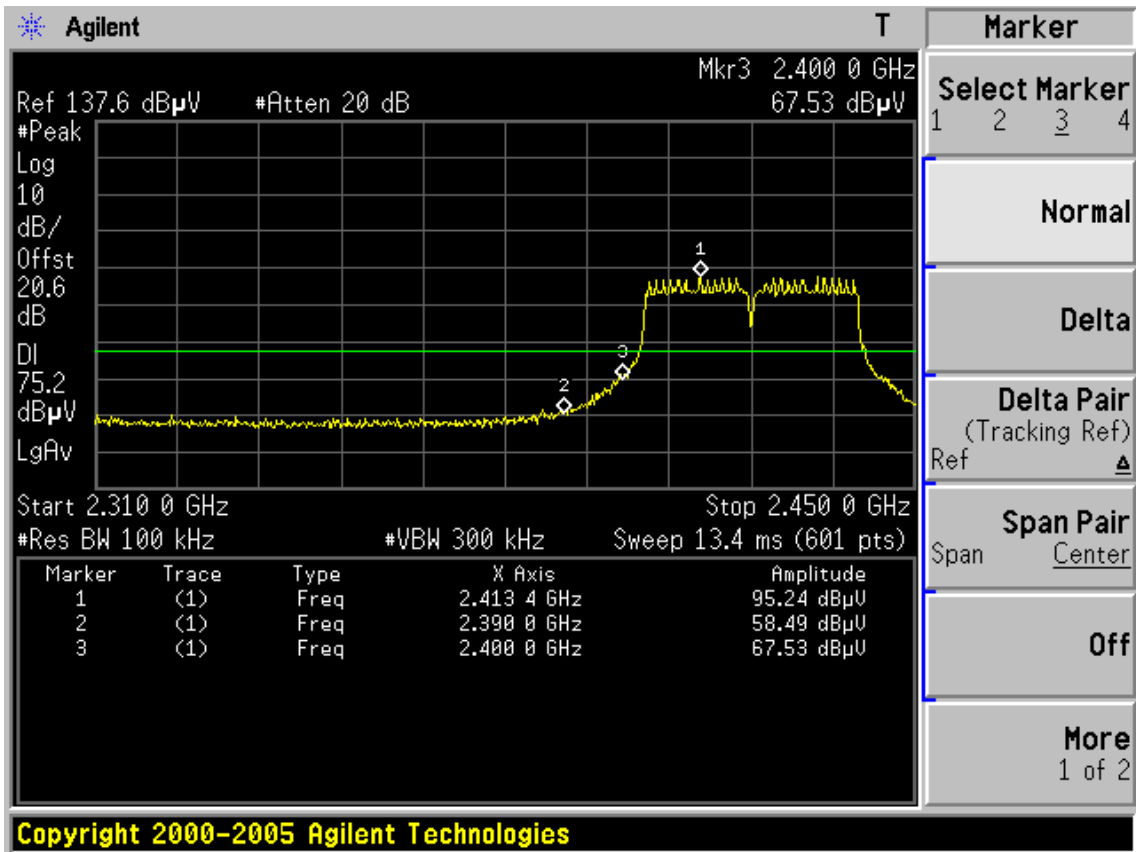

CH6

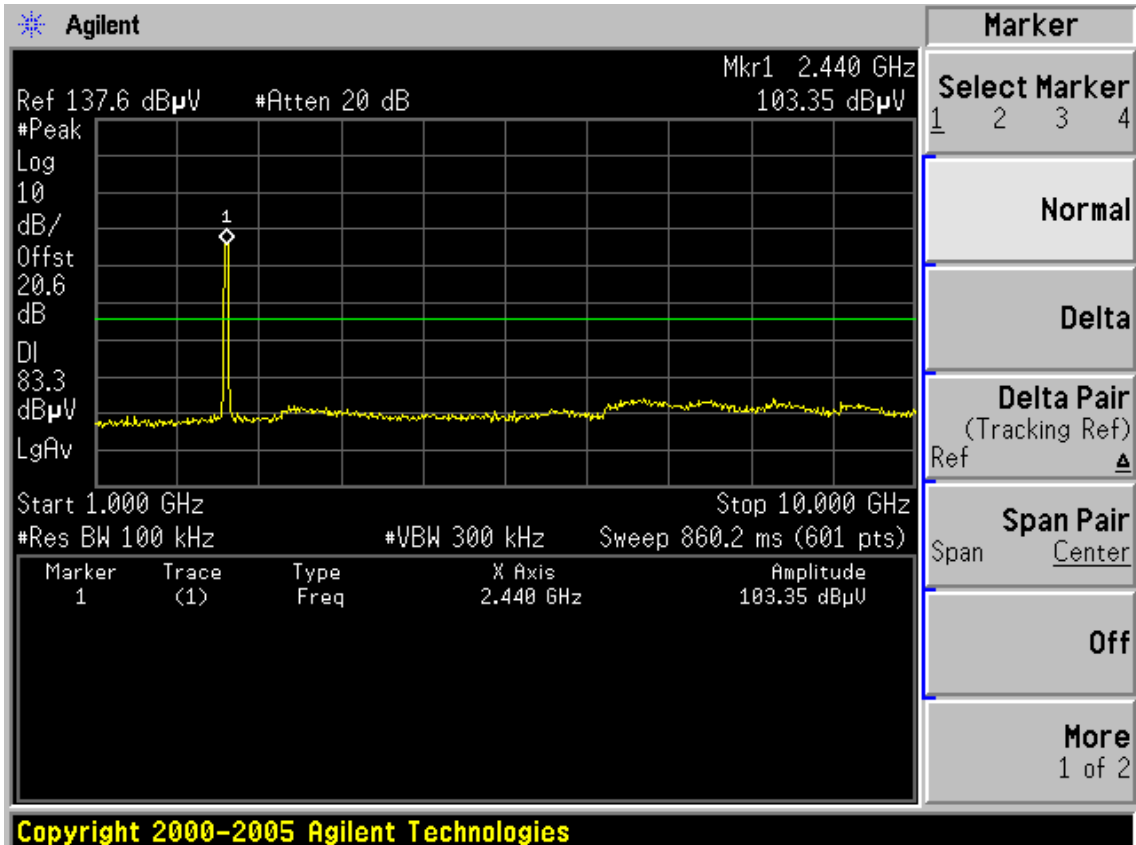

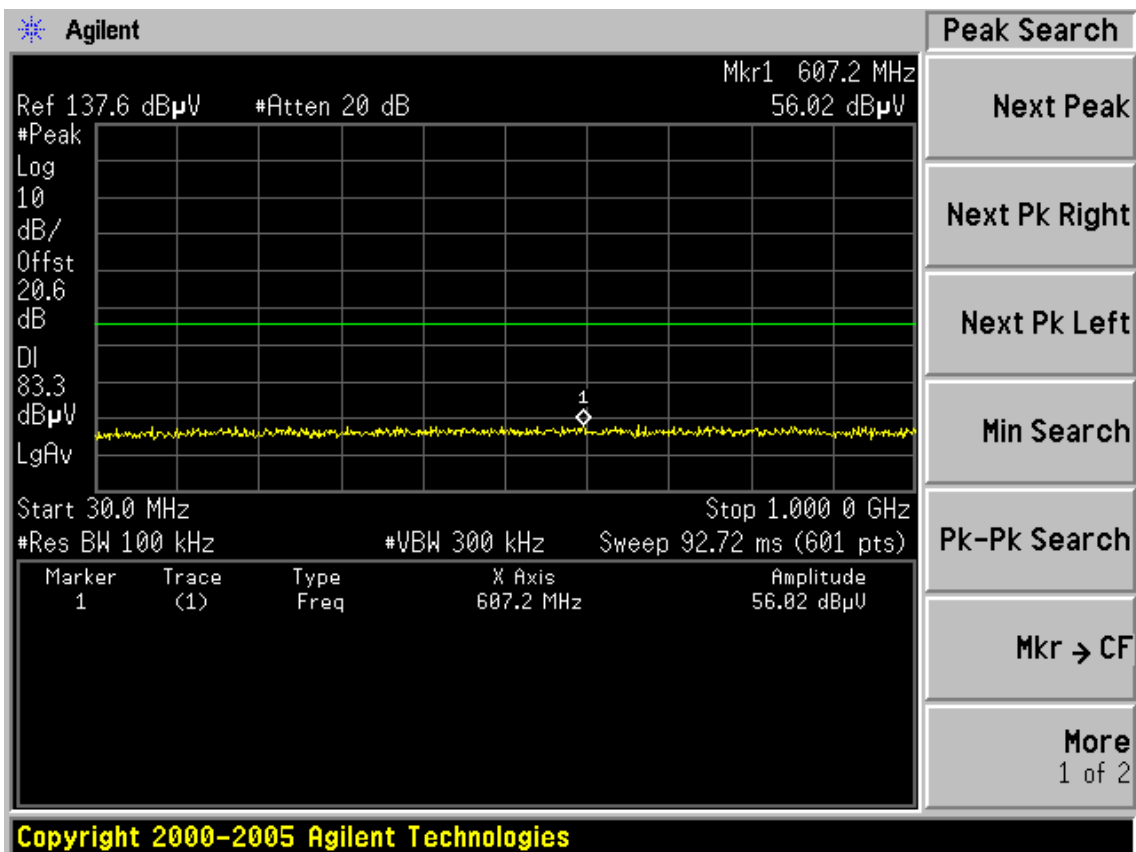
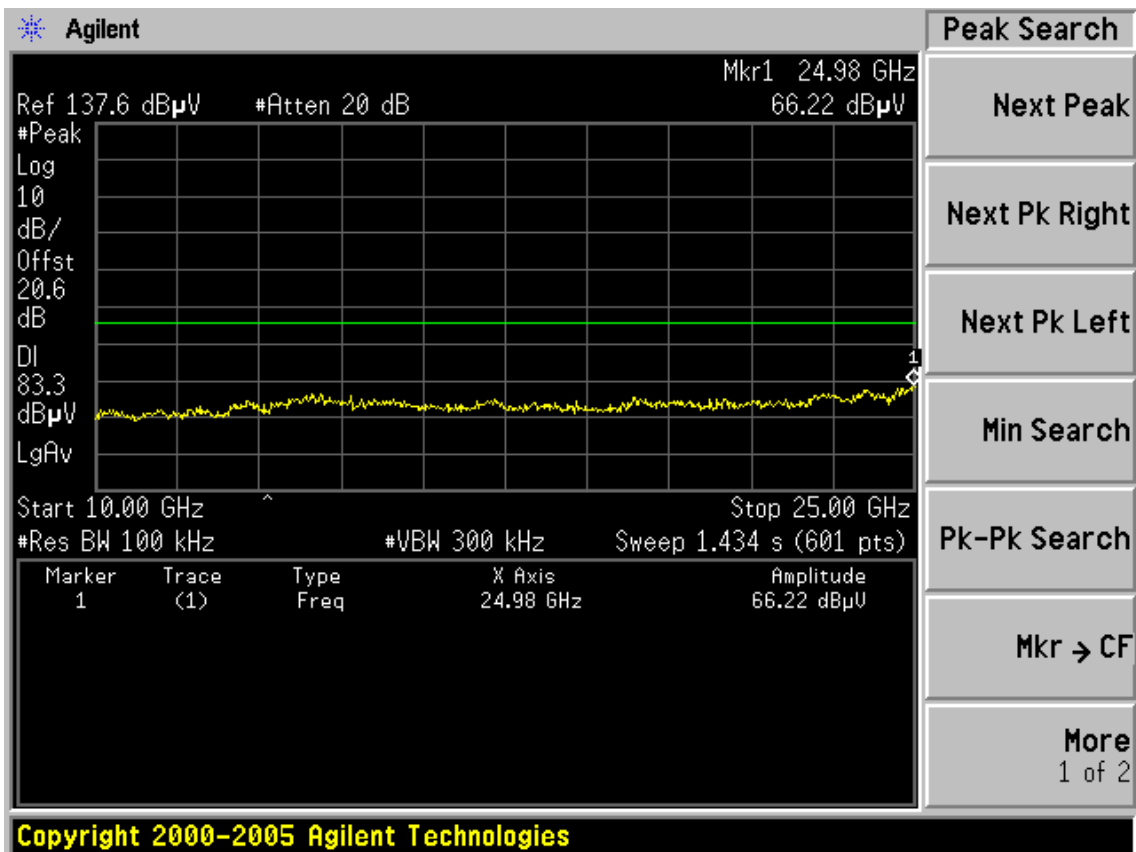

CH9

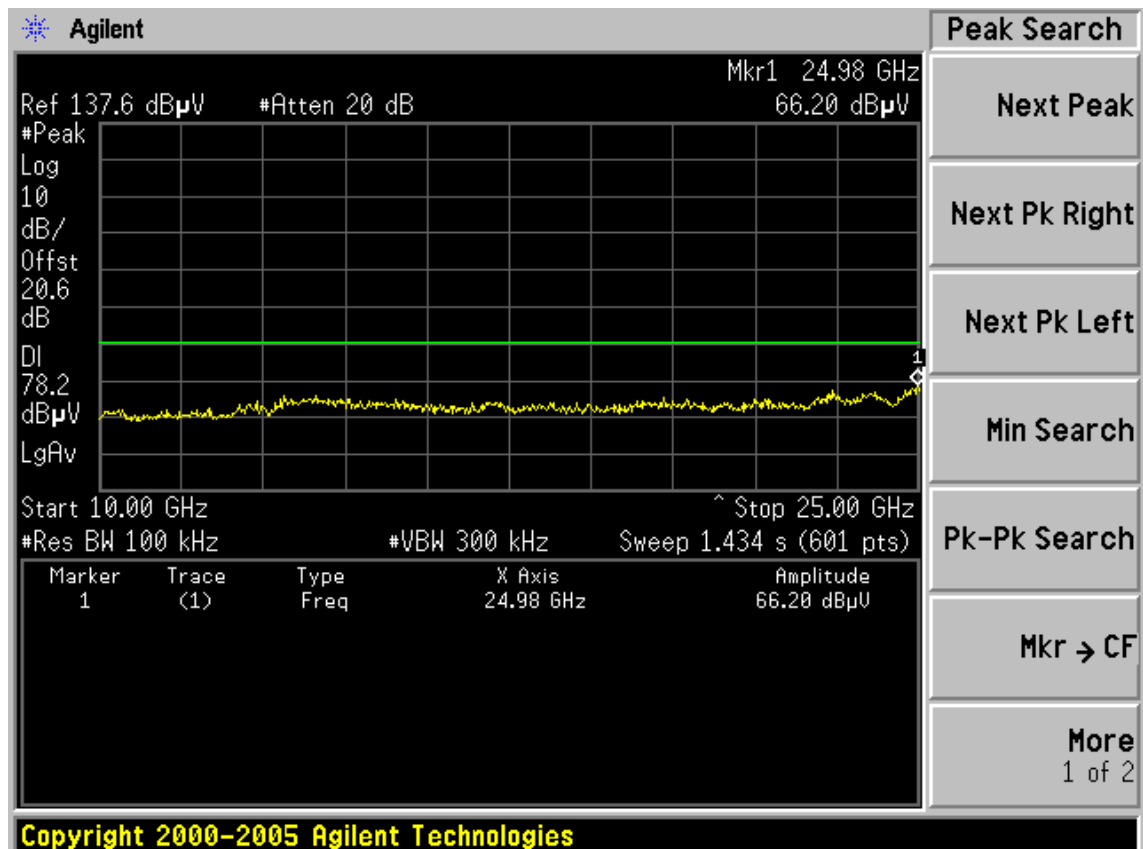
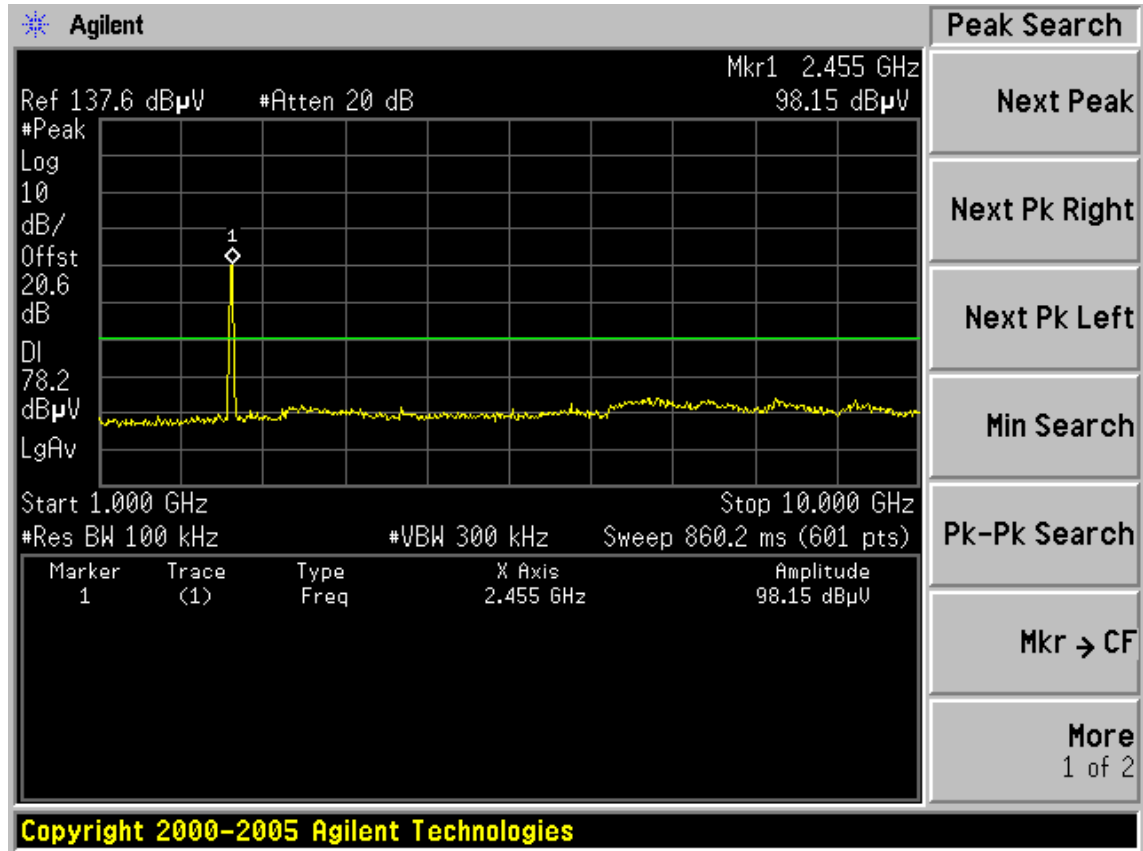

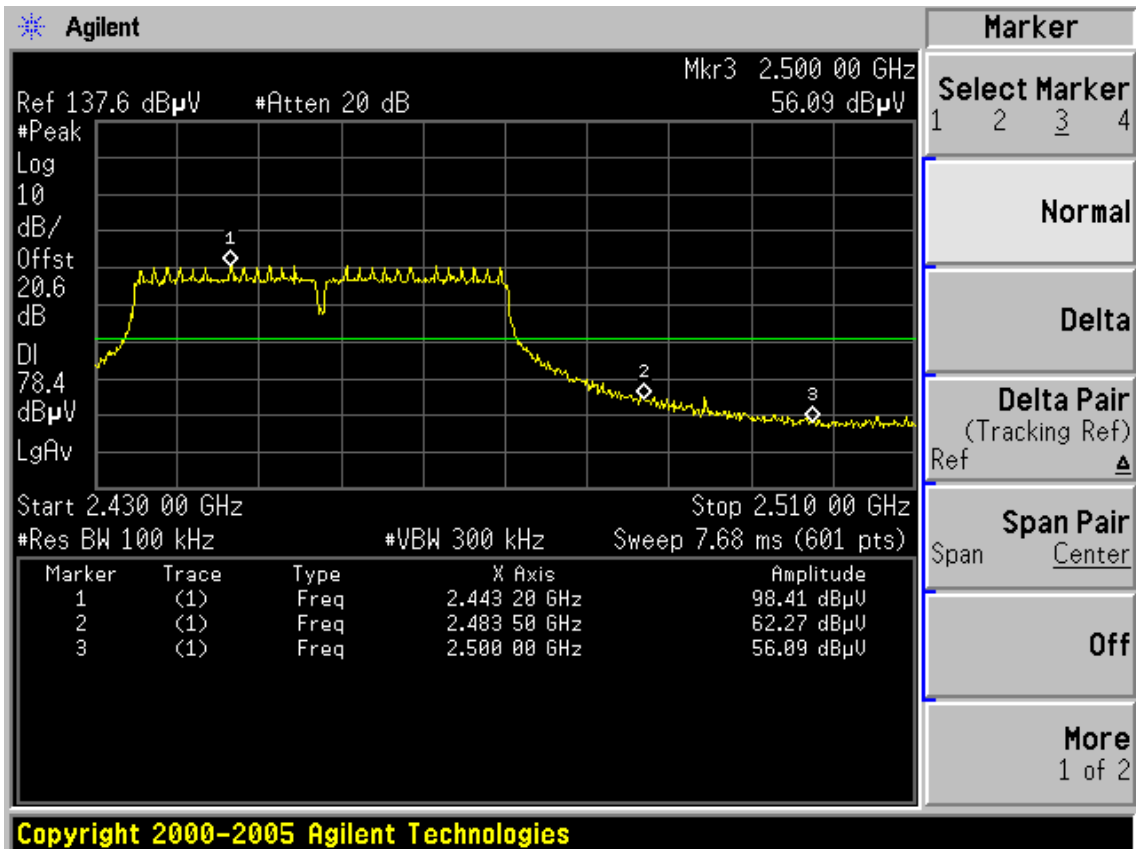
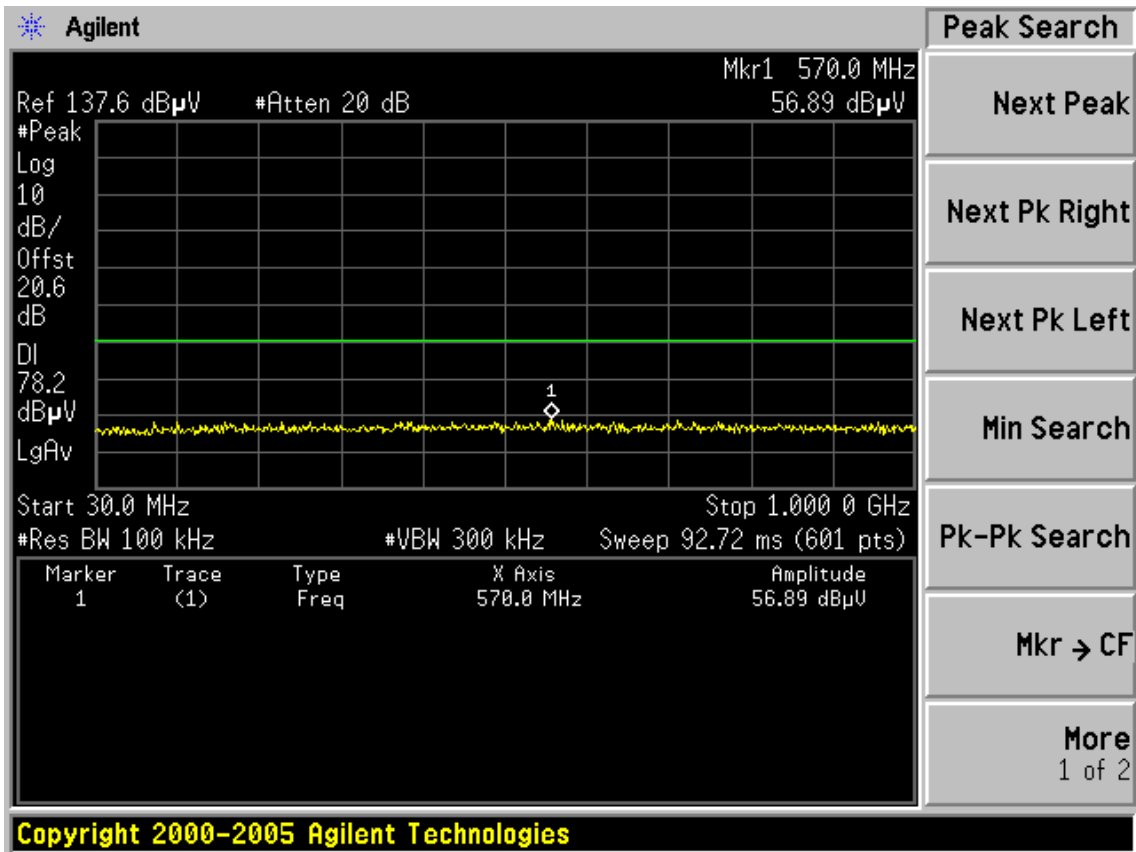

6. BAND EDGE COMPLIANCE TEST

6.1. Test Equipment

| Item | Equipment | Manufacturer | Model No. | Serial No. | Last Cal. | Cal. Interval |
|------|-------------------|--------------|-------------|------------|------------|---------------|
| 1. | Spectrum Analyzer | Agilent | E4446A | US44300459 | May.08,11 | 1 Year |
| 2. | Horn Antenna | EMCO | 3115 | 9607-4877 | May.25, 11 | 1.5 Year |
| 3. | Amplifier | Agilent | 8449B | 3008A02495 | May.08, 11 | 1 Year |
| 4. | RF Cable | Hubersuhner | SUCOFLEX102 | 28620/2 | May.08,11 | 1 Year |
| 5. | RF Cable | Hubersuhner | SUCOFLEX102 | 28618/2 | May.08,11 | 1 Year |
| 6. | RF Cable | Hubersuhner | SUCOFLEX102 | 28610/2 | May.08,11 | 1 Year |

6.2. Limit

All the lower and upper band-edges emissions appearing within 2310MHz to 2390MHz and 2483.5MHz to 2500MHz restricted frequency bands shall not exceed the limits shown in 15.209, all the other emissions outside operation frequency band 2400MHz to 2483.5MHz shall be at least 20dB below the fundamental emissions, or comply with 15.209 limits.

6.3. Test Produce

1. The EUT is placed on a turntable, which is 0.8m above the ground plane and worked at highest radiated power.
2. The turntable was rotated for 360 degrees to determine the position of maximum emission level.
3. EUT is set 3m away from the receiving antenna, which is varied from 1m to 4m to find out the highest emission.
4. Set the spectrum analyzer in the following setting in order to capture the lower and upper band-edges of the emission:
 - (a) PEAK: RBW=1MHz; VBW=3MHz; Sweep=AUTO
 - (b) AVERAGE: RBW=1MHz; VBW=10Hz; Sweep=AUTO

6.4. Test Results

Pass (The testing data was attached in the next pages.)

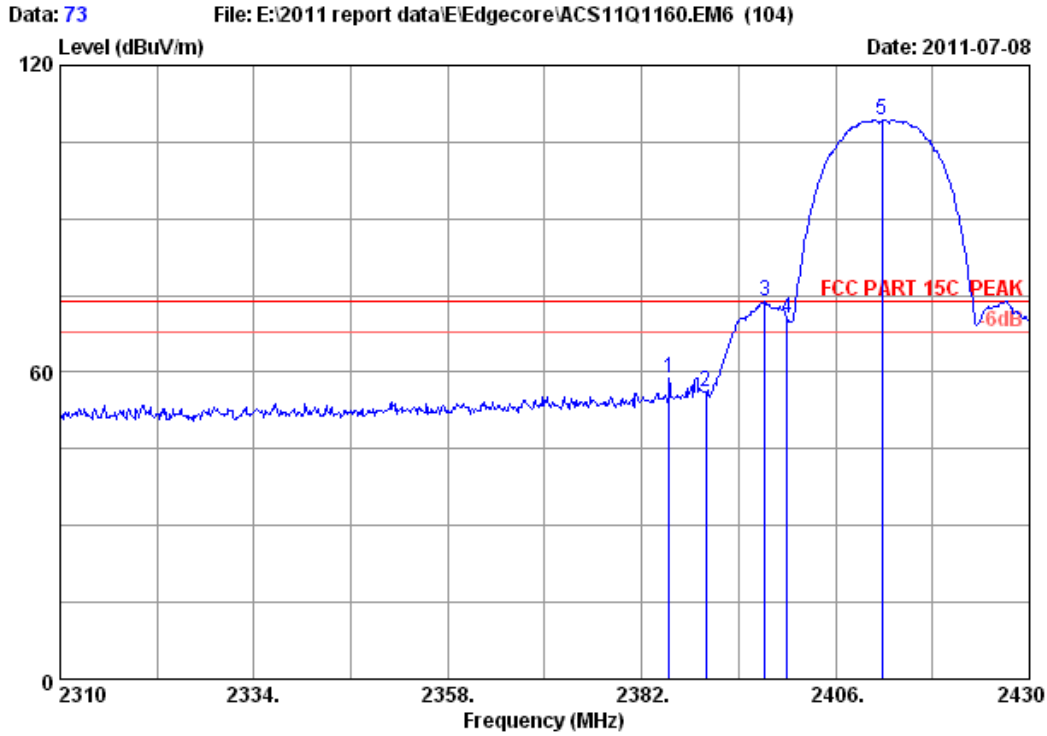

Site no. : 3m Chamber Data no. : 73
 Dis. / Ant. : 3m 3115(0911) Ant. pol. : VERTICAL
 Limit : FCC PART 15C PEAK
 Env. / Ins. : 23*C/54% Engineer : Leo-Li
 EUT : 150 Mbps 4-port Wireless Broadband Router
 Power : DC 9V From Adapter input AC 120V/60Hz
 Test mode : IEEE802.11b CH1 2412MHz Tx
 M/N : SMCWBR14S-N5

| | Ant. Freq. (MHz) | Ant. Factor (dB/m) | Cable loss (dB) | Amp. Factor (dB) | Reading (dBuV) | Emission Level (dBuV/m) | Limits (dBuV/m) | Margin (dB) | Remark |
|---|------------------|--------------------|-----------------|------------------|----------------|-------------------------|-----------------|-------------|--------|
| 1 | 2385.360 | 29.43 | 7.39 | 36.62 | 58.76 | 58.96 | 74.00 | 15.04 | Peak |
| 2 | 2390.000 | 29.44 | 7.39 | 36.62 | 55.98 | 56.19 | 74.00 | 17.81 | Peak |
| 3 | 2397.240 | 29.44 | 7.39 | 36.62 | 73.52 | 73.73 | 74.00 | 0.27 | Peak |
| 4 | 2400.000 | 29.44 | 7.43 | 36.62 | 70.31 | 70.56 | 74.00 | 3.44 | Peak |
| 5 | 2411.760 | 29.45 | 7.43 | 36.62 | 109.10 | 109.36 | 74.00 | -35.36 | Peak |

Remarks:

1. Emission Level= Antenna Factor + Cable Loss -Amp Factor + Reading.
2. The emission levels that are 20dB below the official limit are not reported.

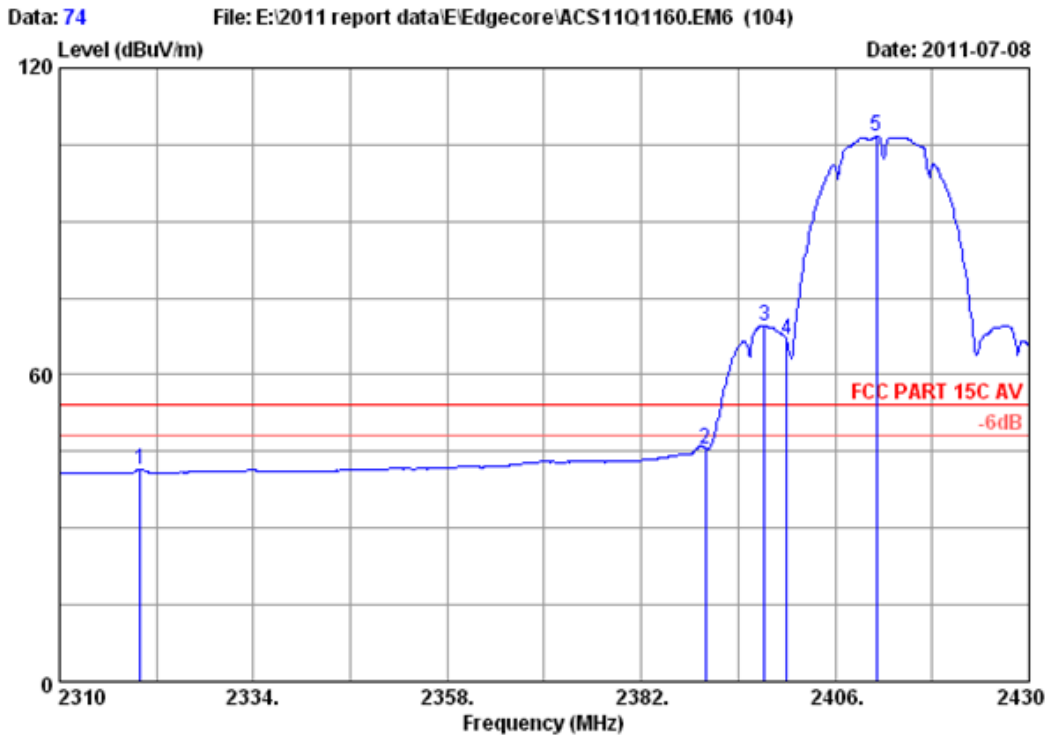

Site no. : 3m Chamber Data no. : 74
 Dis. / Ant. : 3m 3115(0911) Ant. pol. : VERTICAL
 Limit : FCC PART 15C AV
 Env. / Ins. : 23°C/54% Engineer : Leo-Li
 EUT : 150 Mbps 4-port Wireless Broadband Router
 Power : DC 9V From Adapter input AC 120V/60Hz
 Test mode : IEEE802.11b CH1 2412MHz Tx
 M/N : SMCWBR14S-N5

| | Freq. (MHz) | Ant. Factor (dB/m) | Cable loss (dB) | Amp. Factor (dB) | Reading (dBuV) | Emission Level (dBuV/m) | Limits (dBuV/m) | Margin (dB) | Remark |
|---|-------------|--------------------|-----------------|------------------|----------------|-------------------------|-----------------|-------------|---------|
| 1 | 2319.960 | 29.40 | 7.27 | 36.63 | 41.45 | 41.49 | 54.00 | 12.51 | Average |
| 2 | 2390.000 | 29.44 | 7.39 | 36.62 | 45.30 | 45.51 | 54.00 | 8.49 | Average |
| 3 | 2397.240 | 29.44 | 7.39 | 36.62 | 69.39 | 69.60 | 54.00 | -15.60 | Average |
| 4 | 2400.000 | 29.44 | 7.43 | 36.62 | 66.63 | 66.88 | 54.00 | -12.88 | Average |
| 5 | 2411.160 | 29.45 | 7.43 | 36.62 | 106.36 | 106.62 | 54.00 | -52.62 | Average |

Remarks:

1. Emission Level= Antenna Factor + Cable Loss -Amp Factor + Reading.
2. The emission levels that are 20dB below the official limit are not reported.

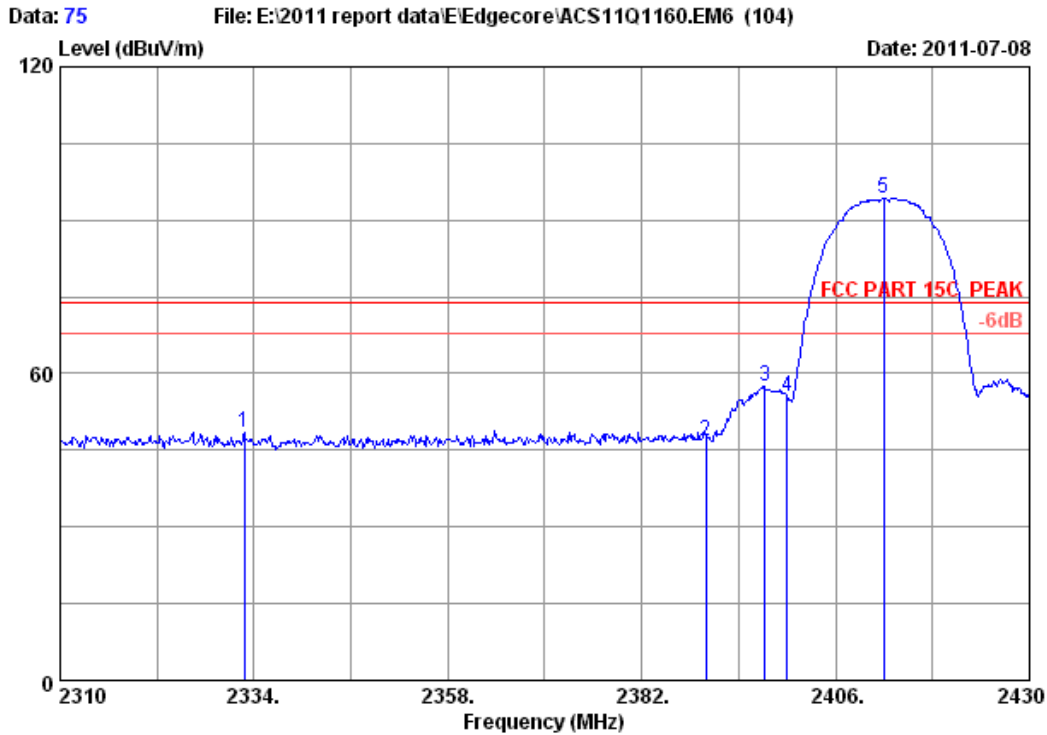

Site no. : 3m Chamber Data no. : 75
 Dis. / Ant. : 3m 3115(0911) Ant. pol. : HORIZONTAL
 Limit : FCC PART 15C PEAK
 Env. / Ins. : 23°C/54% Engineer : Leo-Li
 EUT : 150 Mbps 4-port Wireless Broadband Router
 Power : DC 9V From Adapter input AC 120V/60Hz
 Test mode : IEEE802.11b CH1 2412MHz Tx
 M/N : SMCWBR14S-N5

| | Ant. | Cable | Amp. | Emission | | | | | |
|-------|----------|-------|--------|----------|----------|----------|--------|--------|------|
| Freq. | Factor | loss | Factor | Reading | Level | Limits | Margin | Remark | |
| (MHz) | (dB/m) | (dB) | (dB) | (dBuV) | (dBuV/m) | (dBuV/m) | (dB) | | |
| 1 | 2332.800 | 29.40 | 7.27 | 36.63 | 48.55 | 48.59 | 74.00 | 25.41 | Peak |
| 2 | 2390.000 | 29.44 | 7.39 | 36.62 | 46.55 | 46.76 | 74.00 | 27.24 | Peak |
| 3 | 2397.240 | 29.44 | 7.39 | 36.62 | 57.44 | 57.65 | 74.00 | 16.35 | Peak |
| 4 | 2400.000 | 29.44 | 7.43 | 36.62 | 55.13 | 55.38 | 74.00 | 18.62 | Peak |
| 5 | 2412.000 | 29.45 | 7.43 | 36.62 | 94.02 | 94.28 | 74.00 | -20.28 | Peak |

Remarks:

1. Emission Level= Antenna Factor + Cable Loss -Amp Factor + Reading.
2. The emission levels that are 20dB below the official limit are not reported.

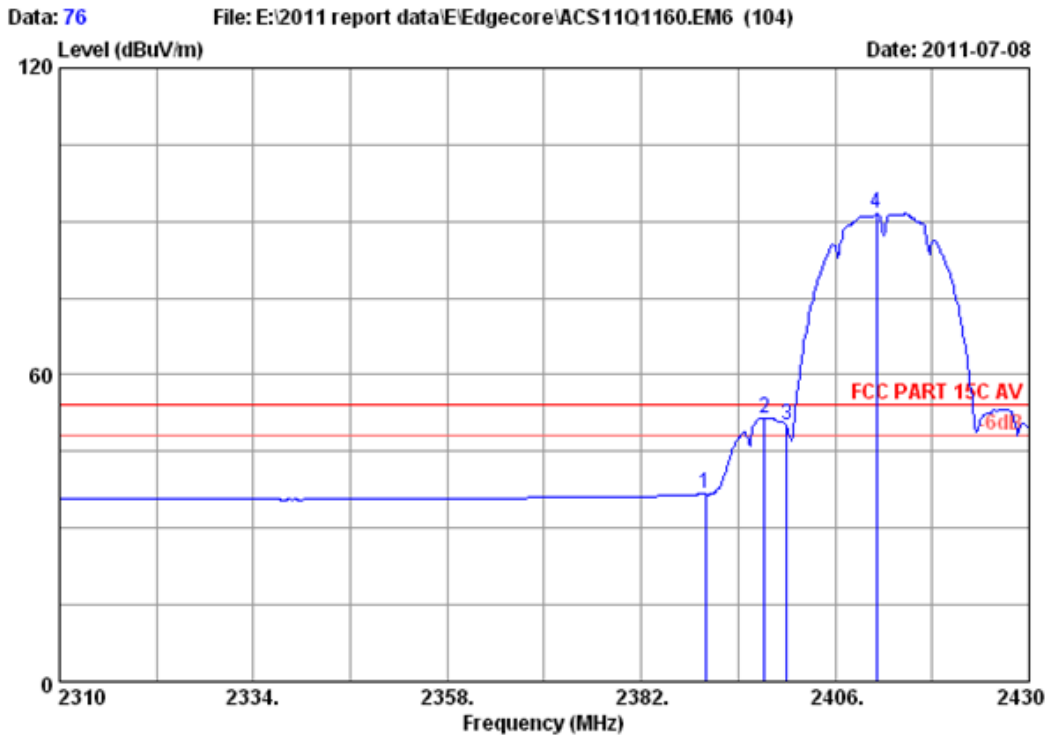

Data: 76 File: E:\2011 report data\EEdgecore\ACS11Q1160.EM6 (104) Date: 2011-07-08
 Site no. : 3m Chamber Data no. : 76
 Dis. / Ant. : 3m 3115(0911) Ant. pol. : HORIZONTAL
 Limit : FCC PART 15C AV
 Env. / Ins. : 23°C/54% Engineer : Leo-Li
 EUT : 150 Mbps 4-port Wireless Broadband Router
 Power : DC 9V From Adapter input AC 120V/60Hz
 Test mode : IEEE802.11b CH1 2412MHz Tx
 M/N : SMCWBR14S-N5

| | Freq. (MHz) | Ant. Factor (dB/m) | Cable loss (dB) | Amp. Factor (dB) | Reading (dBuV) | Emission Level (dBuV/m) | Limits (dBuV/m) | Margin (dB) | Remark |
|---|-------------|--------------------|-----------------|------------------|----------------|-------------------------|-----------------|-------------|---------|
| 1 | 2390.000 | 29.44 | 7.39 | 36.62 | 36.40 | 36.61 | 54.00 | 17.39 | Average |
| 2 | 2397.240 | 29.44 | 7.39 | 36.62 | 51.41 | 51.62 | 54.00 | 2.38 | Average |
| 3 | 2400.000 | 29.44 | 7.43 | 36.62 | 49.72 | 49.97 | 54.00 | 4.03 | Average |
| 4 | 2411.160 | 29.45 | 7.43 | 36.62 | 91.19 | 91.45 | 54.00 | -37.45 | Average |

Remarks:

1. Emission Level= Antenna Factor + Cable Loss -Amp Factor + Reading.
2. The emission levels that are 20dB below the official limit are not reported.

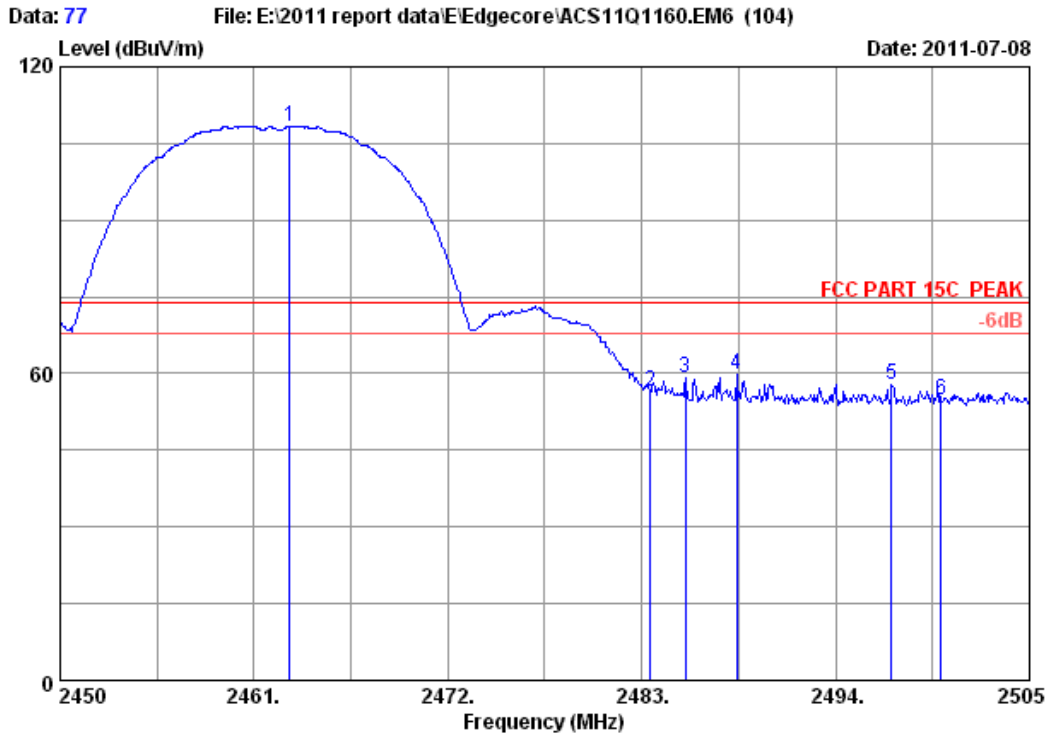

Site no. : 3m Chamber Data no. : 77
 Dis. / Ant. : 3m 3115(0911) Ant. pol. : VERTICAL
 Limit : FCC PART 15C PEAK
 Env. / Ins. : 23°C/54% Engineer : Leo-Li
 EUT : 150 Mbps 4-port Wireless Broadband Router
 Power : DC 9V From Adapter input AC 120V/60Hz
 Test mode : IEEE802.11b CH11 2462MHz Tx
 M/N : SMCWBR14S-N5

| | Freq. (MHz) | Ant. Factor (dB/m) | Cable loss (dB) | Amp. Factor (dB) | Reading (dBuV) | Emission Level (dBuV/m) | Limits (dBuV/m) | Margin (dB) | Remark |
|---|-------------|--------------------|-----------------|------------------|----------------|-------------------------|-----------------|-------------|--------|
| 1 | 2463.035 | 29.48 | 7.54 | 36.61 | 108.06 | 108.47 | 74.00 | -34.47 | Peak |
| 2 | 2483.500 | 29.49 | 7.58 | 36.60 | 56.03 | 56.50 | 74.00 | 17.50 | Peak |
| 3 | 2485.475 | 29.49 | 7.58 | 36.60 | 58.85 | 59.32 | 74.00 | 14.68 | Peak |
| 4 | 2488.390 | 29.50 | 7.58 | 36.60 | 59.52 | 60.00 | 74.00 | 14.00 | Peak |
| 5 | 2497.190 | 29.50 | 7.58 | 36.60 | 57.36 | 57.84 | 74.00 | 16.16 | Peak |
| 6 | 2500.000 | 29.50 | 7.62 | 36.60 | 54.44 | 54.96 | 74.00 | 19.04 | Peak |

Remarks:

1. Emission Level= Antenna Factor + Cable Loss -Amp Factor + Reading.
2. The emission levels that are 20dB below the official limit are not reported.

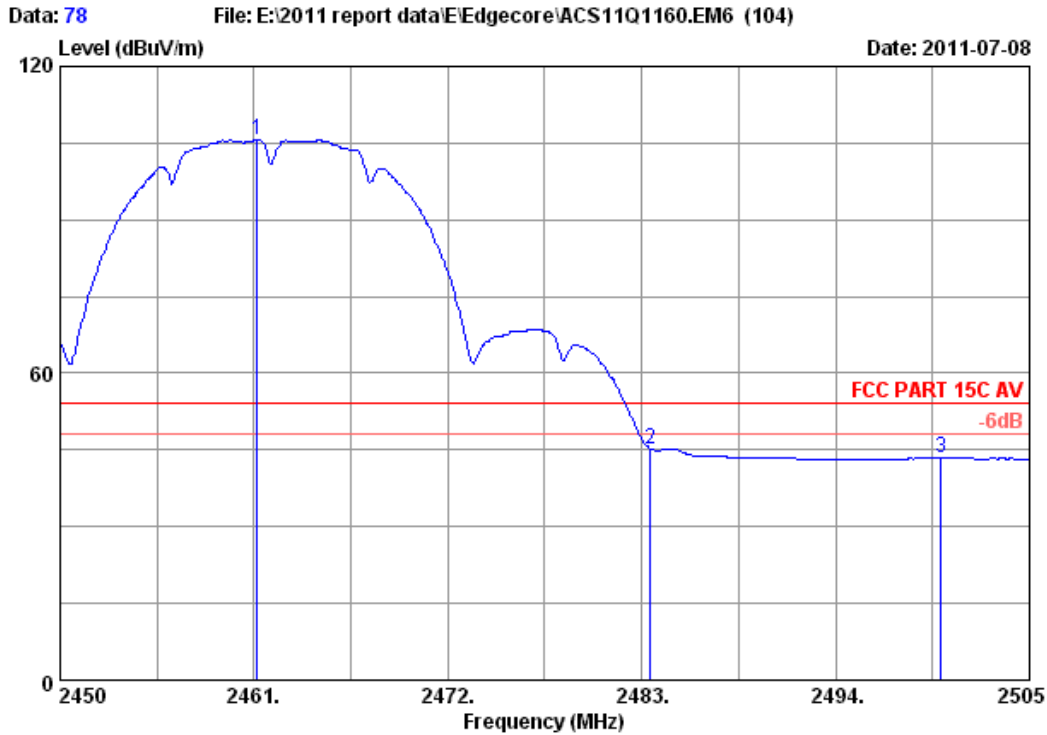

Site no. : 3m Chamber Data no. : 78
 Dis. / Ant. : 3m 3115(0911) Ant. pol. : VERTICAL
 Limit : FCC PART 15C AV
 Env. / Ins. : 23°C/54% Engineer : Leo-Li
 EUT : 150 Mbps 4-port Wireless Broadband Router
 Power : DC 9V From Adapter input AC 120V/60Hz
 Test mode : IEEE802.11b CH11 2462MHz Tx
 M/N : SMCWBR14S-N5

| | Freq. (MHz) | Ant. Factor (dB/m) | Cable loss (dB) | Amp. Factor (dB) | Reading (dBuV) | Emission Level (dBuV/m) | Limits (dBuV/m) | Margin (dB) | Remark |
|---|----------------|--------------------------|-----------------------|------------------------|-------------------|-------------------------------|--------------------|----------------|---------|
| 1 | 2461.165 | 29.48 | 7.54 | 36.61 | 105.27 | 105.68 | 54.00 | -51.68 | Average |
| 2 | 2483.500 | 29.49 | 7.58 | 36.60 | 44.73 | 45.20 | 54.00 | 8.80 | Average |
| 3 | 2500.000 | 29.50 | 7.62 | 36.60 | 42.82 | 43.34 | 54.00 | 10.66 | Average |

Remarks:

1. Emission Level= Antenna Factor + Cable Loss -Amp Factor + Reading.
2. The emission levels that are 20dB below the official limit are not reported.

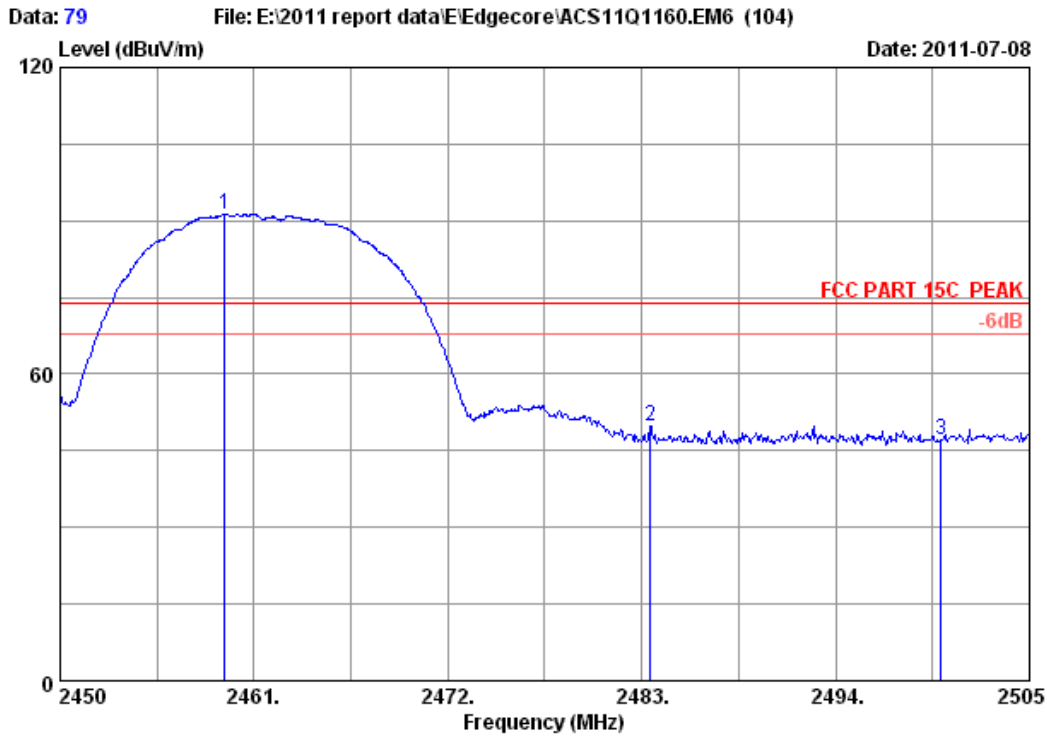

Site no. : 3m Chamber Data no. : 79
 Dis. / Ant. : 3m 3115(0911) Ant. pol. : HORIZONTAL
 Limit : FCC PART 15C PEAK
 Env. / Ins. : 23°C/54% Engineer : Leo-Li
 EUT : 150 Mbps 4-port Wireless Broadband Router
 Power : DC 9V From Adapter input AC 120V/60Hz
 Test mode : IEEE802.11b CH11 2462MHz Tx
 M/N : SMCWBR14S-N5

| | Freq. (MHz) | Ant. Factor (dB/m) | Cable loss (dB) | Amp. Factor (dB) | Reading (dBuV) | Emission Level (dBuV/m) | Limits (dBuV/m) | Margin (dB) | Remark |
|---|-------------|--------------------|-----------------|------------------|----------------|-------------------------|-----------------|-------------|--------|
| 1 | 2459.350 | 29.48 | 7.54 | 36.61 | 90.82 | 91.23 | 74.00 | -17.23 | Peak |
| 2 | 2483.500 | 29.49 | 7.58 | 36.60 | 49.23 | 49.70 | 74.00 | 24.30 | Peak |
| 3 | 2500.000 | 29.50 | 7.62 | 36.60 | 46.72 | 47.24 | 74.00 | 26.76 | Peak |

Remarks:

1. Emission Level= Antenna Factor + Cable Loss -Amp Factor + Reading.
2. The emission levels that are 20dB below the official limit are not reported.

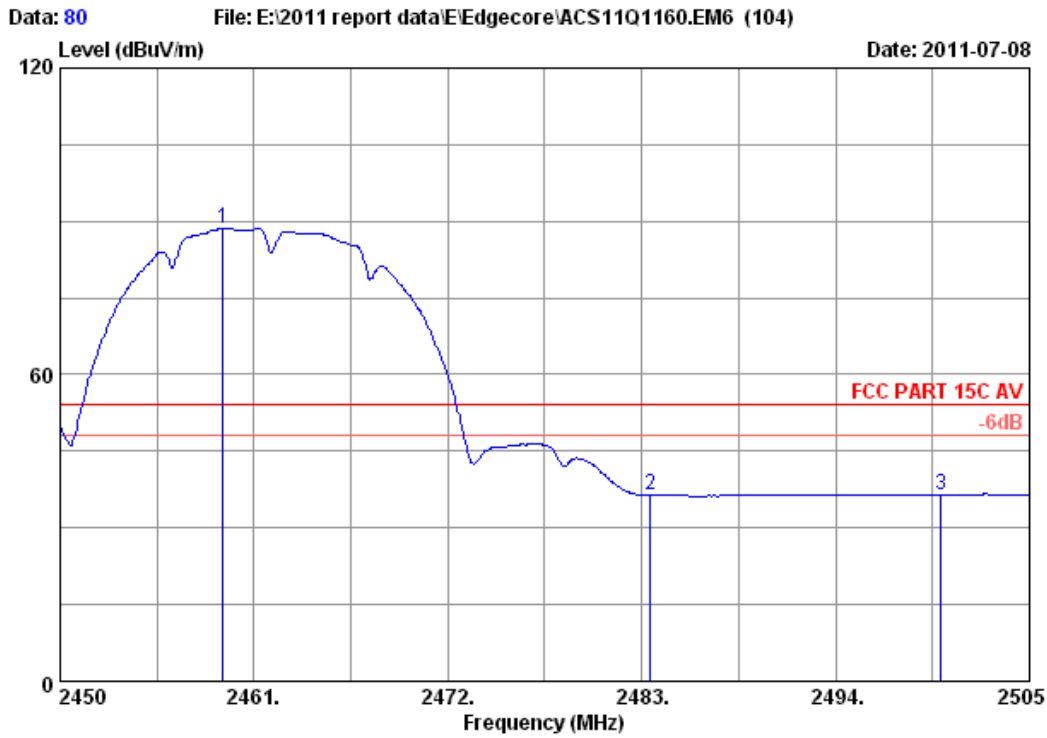

Site no. : 3m Chamber Data no. : 80
 Dis. / Ant. : 3m 3115(0911) Ant. pol. : HORIZONTAL
 Limit : FCC PART 15C AV
 Env. / Ins. : 23°C/54% Engineer : Leo-Li
 EUT : 150 Mbps 4-port Wireless Broadband Router
 Power : DC 9V From Adapter input AC 120V/60Hz
 Test mode : IEEE802.11b CH11 2462MHz Tx
 M/N : SMCWBR14S-N5

| | Ant. Freq. (MHz) | Ant. Factor (dB/m) | Cable loss (dB) | Amp. Factor (dB) | Reading (dBuV) | Emission Level (dBuV/m) | Limits (dBuV/m) | Margin (dB) | Remark |
|---|------------------|--------------------|-----------------|------------------|----------------|-------------------------|-----------------|-------------|---------|
| 1 | 2459.240 | 29.48 | 7.54 | 36.61 | 88.27 | 88.68 | 54.00 | -34.68 | Average |
| 2 | 2483.500 | 29.49 | 7.58 | 36.60 | 35.88 | 36.35 | 54.00 | 17.65 | Average |
| 3 | 2500.000 | 29.50 | 7.62 | 36.60 | 36.01 | 36.53 | 54.00 | 17.47 | Average |

Remarks:

1. Emission Level= Antenna Factor + Cable Loss -Amp Factor + Reading.
2. The emission levels that are 20dB below the official limit are not reported.

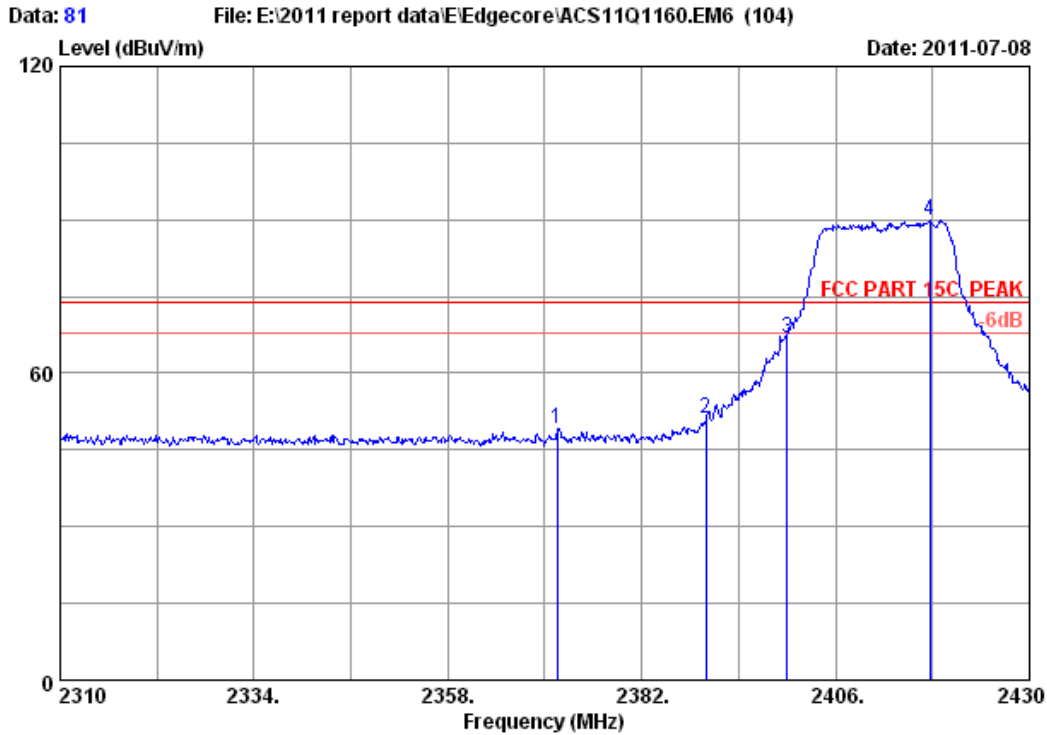

Site no. : 3m Chamber Data no. : 81
 Dis. / Ant. : 3m 3115(0911) Ant. pol. : HORIZONTAL
 Limit : FCC PART 15C PEAK
 Env. / Ins. : 23*C/54% Engineer : Leo-Li
 EUT : 150 Mbps 4-port Wireless Broadband Router
 Power : DC 9V From Adapter input AC 120V/60Hz
 Test mode : IEEE802.11g CH1 2412MHz Tx
 M/N : SMCWBR14S-N5

| | Ant. Freq. (MHz) | Ant. Factor (dB/m) | Cable loss (dB) | Amp. Factor (dB) | Reading (dBuV) | Emission Level (dBuV/m) | Limits (dBuV/m) | Margin (dB) | Remark |
|---|------------------|--------------------|-----------------|------------------|----------------|-------------------------|-----------------|-------------|--------|
| 1 | 2371.560 | 29.43 | 7.35 | 36.62 | 49.07 | 49.23 | 74.00 | 24.77 | Peak |
| 2 | 2390.000 | 29.44 | 7.39 | 36.62 | 50.99 | 51.20 | 74.00 | 22.80 | Peak |
| 3 | 2400.000 | 29.44 | 7.43 | 36.62 | 66.45 | 66.70 | 74.00 | 7.30 | Peak |
| 4 | 2417.640 | 29.45 | 7.43 | 36.61 | 89.62 | 89.89 | 74.00 | -15.89 | Peak |

Remarks:

1. Emission Level= Antenna Factor + Cable Loss -Amp Factor + Reading.
2. The emission levels that are 20dB below the official limit are not reported.

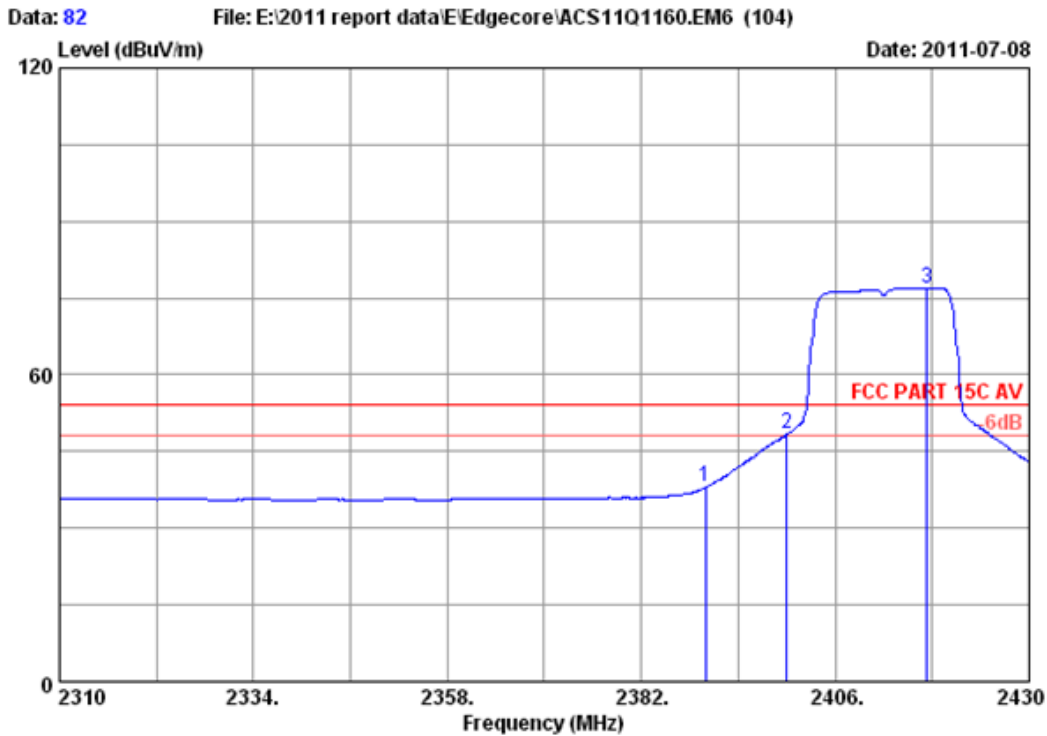

Site no. : 3m Chamber Data no. : 82
 Dis. / Ant. : 3m 3115(0911) Ant. pol. : HORIZONTAL
 Limit : FCC PART 15C AV
 Env. / Ins. : 23°C/54% Engineer : Leo-Li
 EUT : 150 Mbps 4-port Wireless Broadband Router
 Power : DC 9V From Adapter input AC 120V/60Hz
 Test mode : IEEE802.11g CH1 2412MHz Tx
 M/N : SMCWBR14S-N5

| | Freq. (MHz) | Ant. Factor (dB/m) | Cable loss (dB) | Amp. Factor (dB) | Reading (dBuV) | Emission Level (dBuV/m) | Limits (dBuV/m) | Margin (dB) | Remark |
|---|-------------|--------------------|-----------------|------------------|----------------|-------------------------|-----------------|-------------|---------|
| 1 | 2390.000 | 29.44 | 7.39 | 36.62 | 37.77 | 37.98 | 54.00 | 16.02 | Average |
| 2 | 2400.000 | 29.44 | 7.43 | 36.62 | 48.14 | 48.39 | 54.00 | 5.61 | Average |
| 3 | 2417.400 | 29.45 | 7.43 | 36.61 | 76.64 | 76.91 | 54.00 | -22.91 | Average |

Remarks:

1. Emission Level= Antenna Factor + Cable Loss -Amp Factor + Reading.
2. The emission levels that are 20dB below the official limit are not reported.

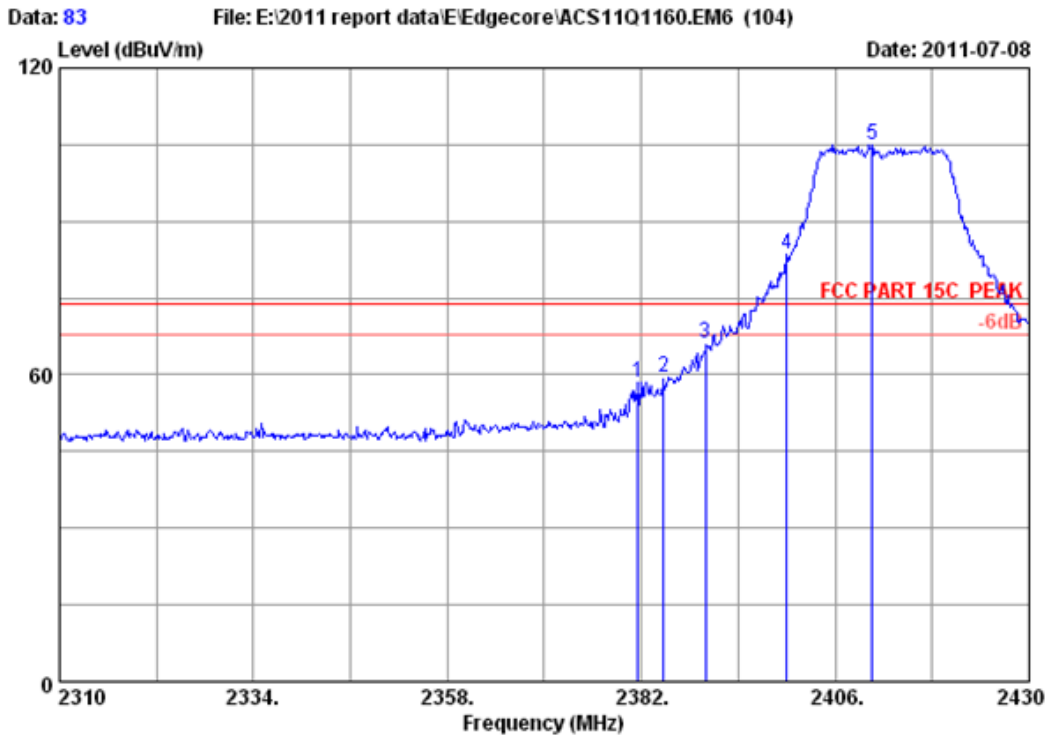

Site no. : 3m Chamber Data no. : 83
 Dis. / Ant. : 3m 3115(0911) Ant. pol. : VERTICAL
 Limit : FCC PART 15C PEAK
 Env. / Ins. : 23°C/54% Engineer : Leo-Li
 EUT : 150 Mbps 4-port Wireless Broadband Router
 Power : DC 9V From Adapter input AC 120V/60Hz
 Test mode : IEEE802.11g CH1 2412MHz Tx
 M/N : SMCWBR14S-N5

| | Ant. Freq. (MHz) | Ant. Factor (dB/m) | Cable loss (dB) | Amp. Factor (dB) | Reading (dBuV) | Emission Level (dBuV/m) | Limits (dBuV/m) | Margin (dB) | Remark |
|---|------------------|--------------------|-----------------|------------------|----------------|-------------------------|-----------------|-------------|--------|
| 1 | 2381.640 | 29.43 | 7.39 | 36.62 | 58.24 | 58.44 | 74.00 | 15.56 | Peak |
| 2 | 2384.760 | 29.43 | 7.39 | 36.62 | 59.22 | 59.42 | 74.00 | 14.58 | Peak |
| 3 | 2390.000 | 29.44 | 7.39 | 36.62 | 66.05 | 66.26 | 74.00 | 7.74 | Peak |
| 4 | 2400.000 | 29.44 | 7.43 | 36.62 | 83.29 | 83.54 | 74.00 | -9.54 | Peak |
| 5 | 2410.560 | 29.45 | 7.43 | 36.62 | 104.76 | 105.02 | 74.00 | -31.02 | Peak |

Remarks:

1. Emission Level= Antenna Factor + Cable Loss -Amp Factor + Reading.
2. The emission levels that are 20dB below the official limit are not reported.

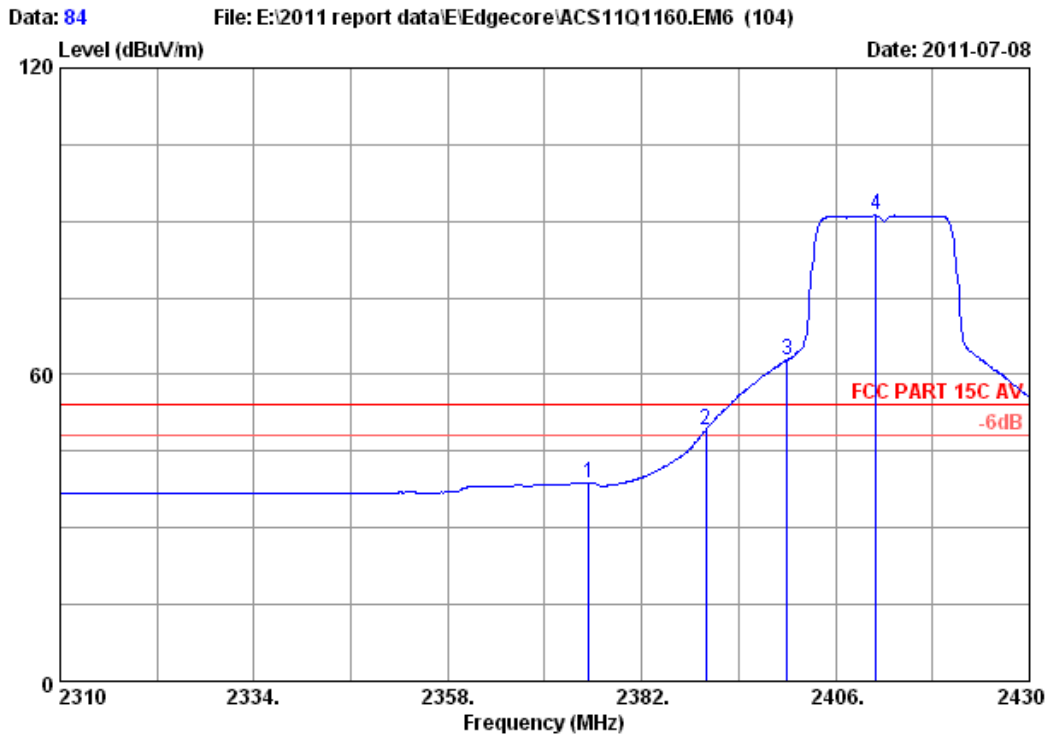

Site no. : 3m Chamber Data no. : 84
 Dis. / Ant. : 3m 3115(0911) Ant. pol. : VERTICAL
 Limit : FCC PART 15C AV
 Env. / Ins. : 23°C/54% Engineer : Leo-Li
 EUT : 150 Mbps 4-port Wireless Broadband Router
 Power : DC 9V From Adapter input AC 120V/60Hz
 Test mode : IEEE802.11g CH1 2412MHz Tx
 M/N : SMCWBR14S-N5

| | Ant. Freq. (MHz) | Ant. Factor (dB/m) | Cable loss (dB) | Amp. Factor (dB) | Reading (dBuV) | Emission Level (dBuV/m) | Limits (dBuV/m) | Margin (dB) | Remark |
|---|------------------|--------------------|-----------------|------------------|----------------|-------------------------|-----------------|-------------|---------|
| 1 | 2375.400 | 29.43 | 7.35 | 36.62 | 38.71 | 38.87 | 54.00 | 15.13 | Average |
| 2 | 2390.000 | 29.44 | 7.39 | 36.62 | 49.06 | 49.27 | 54.00 | 4.73 | Average |
| 3 | 2400.000 | 29.44 | 7.43 | 36.62 | 62.66 | 62.91 | 54.00 | -8.91 | Average |
| 4 | 2411.040 | 29.45 | 7.43 | 36.62 | 90.87 | 91.13 | 54.00 | -37.13 | Average |

Remarks:

1. Emission Level= Antenna Factor + Cable Loss -Amp Factor + Reading.
2. The emission levels that are 20dB below the official limit are not reported.

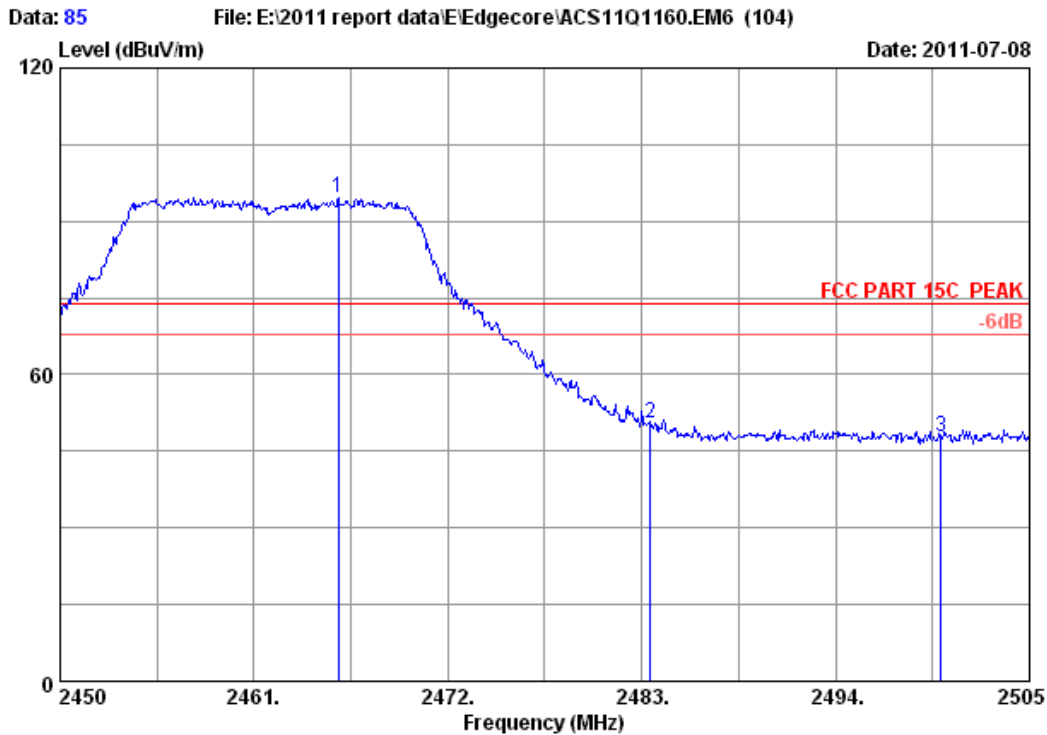

Site no. : 3m Chamber Data no. : 85
 Dis. / Ant. : 3m 3115(0911) Ant. pol. : HORIZONTAL
 Limit : FCC PART 15C PEAK
 Env. / Ins. : 23°C/54% Engineer : Leo-Li
 EUT : 150 Mbps 4-port Wireless Broadband Router
 Power : DC 9V From Adapter input AC 120V/60Hz
 Test mode : IEEE802.11g CH11 2462MHz Tx
 M/N : SMCWBR14S-N5

| | Ant. Freq. (MHz) | Ant. Factor (dB/m) | Cable loss (dB) | Amp. Factor (dB) | Reading (dBuV) | Emission Level (dBuV/m) | Limits (dBuV/m) | Margin (dB) | Remark |
|---|------------------|--------------------|-----------------|------------------|----------------|-------------------------|-----------------|-------------|--------|
| 1 | 2465.785 | 29.48 | 7.54 | 36.61 | 94.30 | 94.71 | 74.00 | -20.71 | Peak |
| 2 | 2483.500 | 29.49 | 7.58 | 36.60 | 50.03 | 50.50 | 74.00 | 23.50 | Peak |
| 3 | 2500.000 | 29.50 | 7.62 | 36.60 | 47.29 | 47.81 | 74.00 | 26.19 | Peak |

Remarks:

1. Emission Level= Antenna Factor + Cable Loss -Amp Factor + Reading.
2. The emission levels that are 20dB below the official limit are not reported.

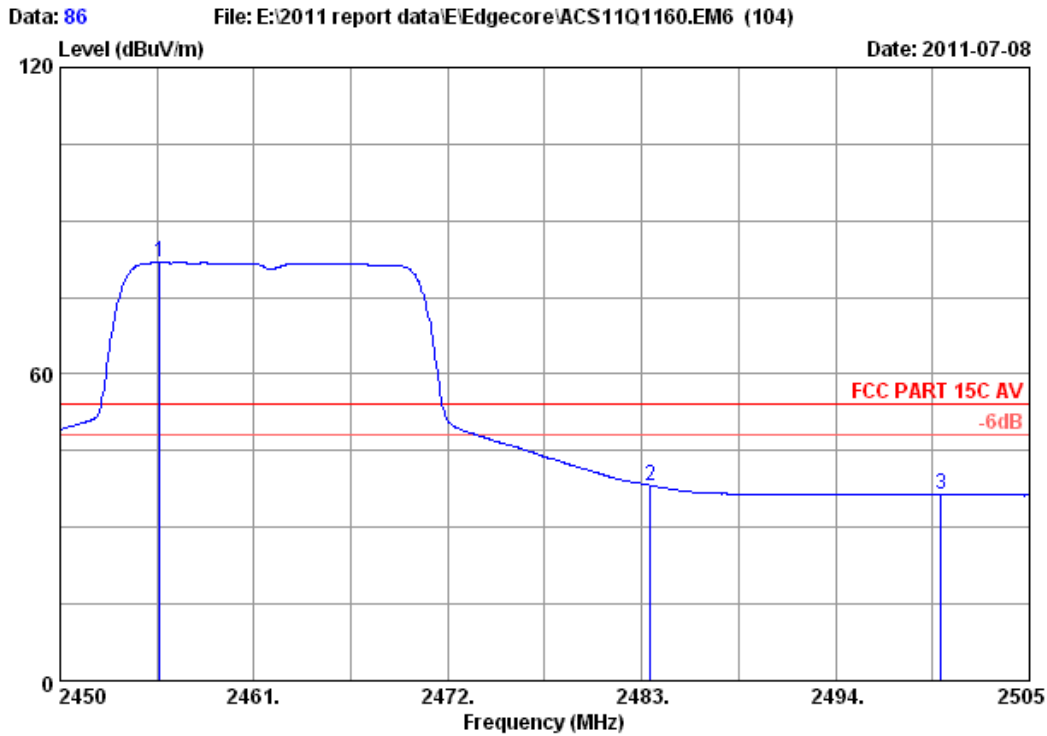

Site no. : 3m Chamber Data no. : 86
 Dis. / Ant. : 3m 3115(0911) Ant. pol. : HORIZONTAL
 Limit : FCC PART 15C AV
 Env. / Ins. : 23°C/54% Engineer : Leo-Li
 EUT : 150 Mbps 4-port Wireless Broadband Router
 Power : DC 9V From Adapter input AC 120V/60Hz
 Test mode : IEEE802.11g CH11 2462MHz Tx
 M/N : SMCWBR14S-N5

| | Ant. Freq. (MHz) | Ant. Factor (dB/m) | Cable loss (dB) | Amp. Factor (dB) | Reading (dBuV) | Emission Level (dBuV/m) | Limits (dBuV/m) | Margin (dB) | Remark |
|---|------------------|--------------------|-----------------|------------------|----------------|-------------------------|-----------------|-------------|---------|
| 1 | 2455.665 | 29.48 | 7.50 | 36.61 | 81.47 | 81.84 | 54.00 | -27.84 | Average |
| 2 | 2483.500 | 29.49 | 7.58 | 36.60 | 37.75 | 38.22 | 54.00 | 15.78 | Average |
| 3 | 2500.000 | 29.50 | 7.62 | 36.60 | 35.95 | 36.47 | 54.00 | 17.53 | Average |

Remarks:

1. Emission Level= Antenna Factor + Cable Loss -Amp Factor + Reading.
2. The emission levels that are 20dB below the official limit are not reported.

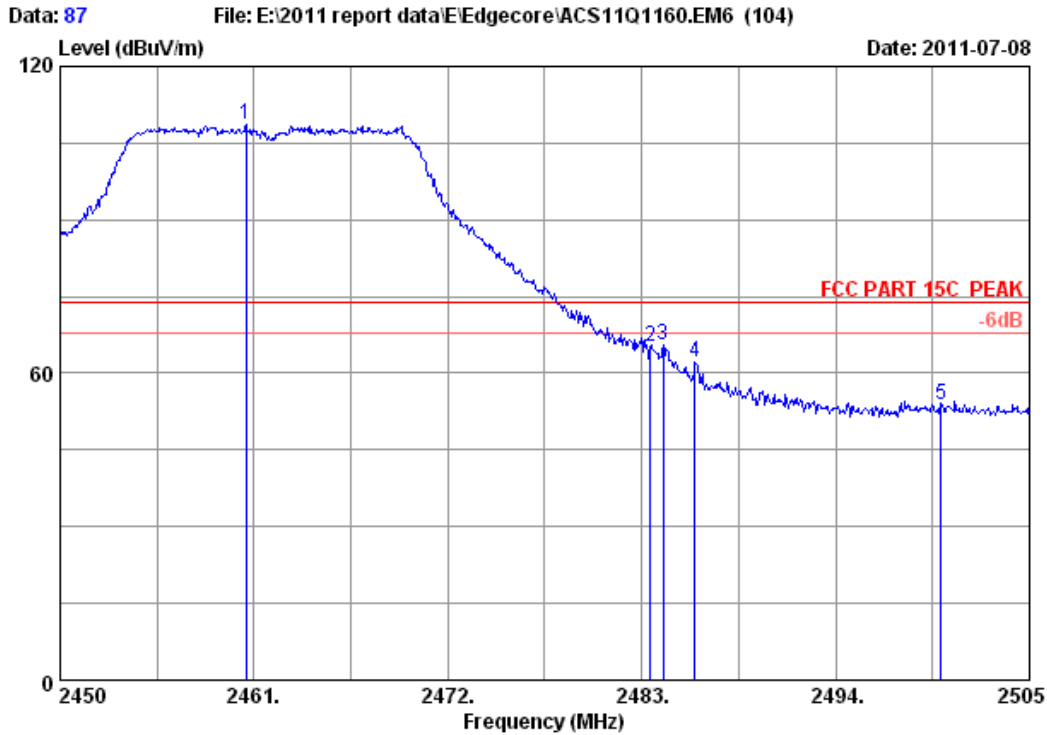

Site no. : 3m Chamber Data no. : 87
 Dis. / Ant. : 3m 3115(0911) Ant. pol. : VERTICAL
 Limit : FCC PART 15C PEAK
 Env. / Ins. : 23°C/54% Engineer : Leo-Li
 EUT : 150 Mbps 4-port Wireless Broadband Router
 Power : DC 9V From Adapter input AC 120V/60Hz
 Test mode : IEEE802.11g CH11 2462MHz Tx
 M/N : SMCWBR14S-N5

| | Ant. Freq. (MHz) | Ant. Factor (dB/m) | Cable loss (dB) | Amp. Factor (dB) | Reading (dBuV) | Emission Level (dBuV/m) | Limits (dBuV/m) | Margin (dB) | Remark |
|---|------------------|--------------------|-----------------|------------------|----------------|-------------------------|-----------------|-------------|--------|
| 1 | 2460.560 | 29.48 | 7.54 | 36.61 | 108.38 | 108.79 | 74.00 | -34.79 | Peak |
| 2 | 2483.500 | 29.49 | 7.58 | 36.60 | 64.73 | 65.20 | 74.00 | 8.80 | Peak |
| 3 | 2484.210 | 29.49 | 7.58 | 36.60 | 64.88 | 65.35 | 74.00 | 8.65 | Peak |
| 4 | 2486.025 | 29.49 | 7.58 | 36.60 | 61.68 | 62.15 | 74.00 | 11.85 | Peak |
| 5 | 2500.000 | 29.50 | 7.62 | 36.60 | 53.38 | 53.90 | 74.00 | 20.10 | Peak |

Remarks:

1. Emission Level= Antenna Factor + Cable Loss -Amp Factor + Reading.
2. The emission levels that are 20dB below the official limit are not reported.

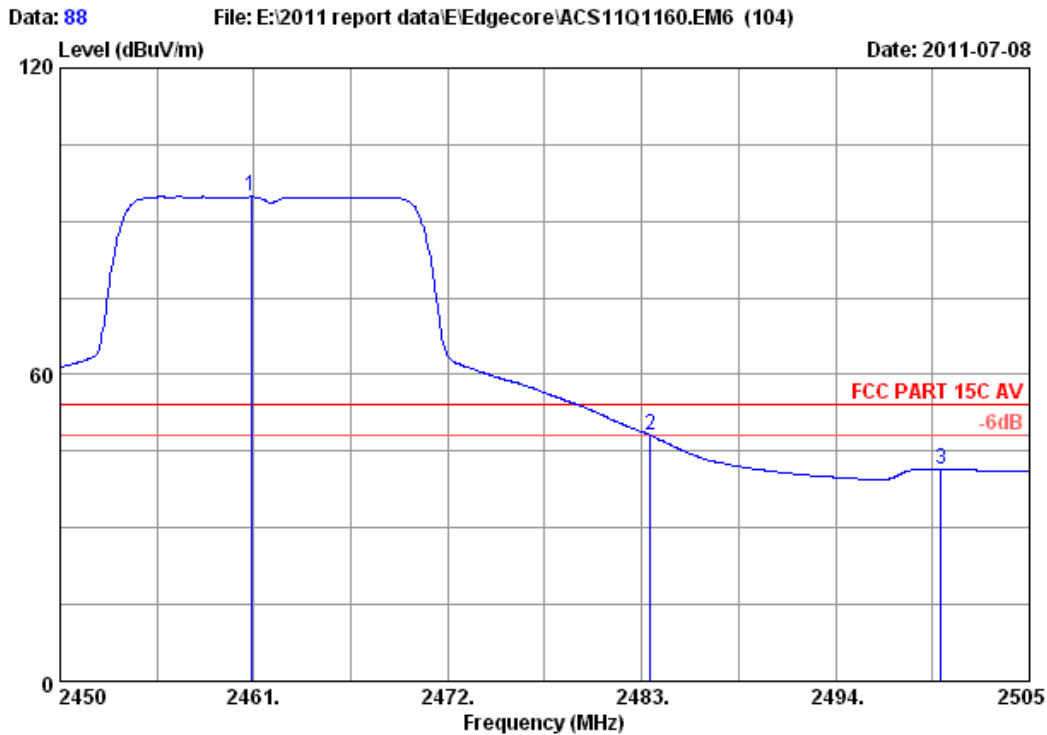

Site no. : 3m Chamber Data no. : 88
 Dis. / Ant. : 3m 3115(0911) Ant. pol. : VERTICAL
 Limit : FCC PART 15C AV
 Env. / Ins. : 23°C/54% Engineer : Leo-Li
 EUT : 150 Mbps 4-port Wireless Broadband Router
 Power : DC 9V From Adapter input AC 120V/60Hz
 Test mode : IEEE802.11g CH11 2462MHz Tx
 M/N : SMCWBR14S-N5

| | Ant. Freq. (MHz) | Ant. Factor (dB/m) | Cable loss (dB) | Amp. Factor (dB) | Reading (dBuV) | Emission Level (dBuV/m) | Limits (dBuV/m) | Margin (dB) | Remark |
|---|------------------|--------------------|-----------------|------------------|----------------|-------------------------|-----------------|-------------|---------|
| 1 | 2460.835 | 29.48 | 7.54 | 36.61 | 94.38 | 94.79 | 54.00 | -40.79 | Average |
| 2 | 2483.500 | 29.49 | 7.58 | 36.60 | 47.65 | 48.12 | 54.00 | 5.88 | Average |
| 3 | 2500.000 | 29.50 | 7.62 | 36.60 | 40.97 | 41.49 | 54.00 | 12.51 | Average |

Remarks:

1. Emission Level= Antenna Factor + Cable Loss -Amp Factor + Reading.
2. The emission levels that are 20dB below the official limit are not reported.

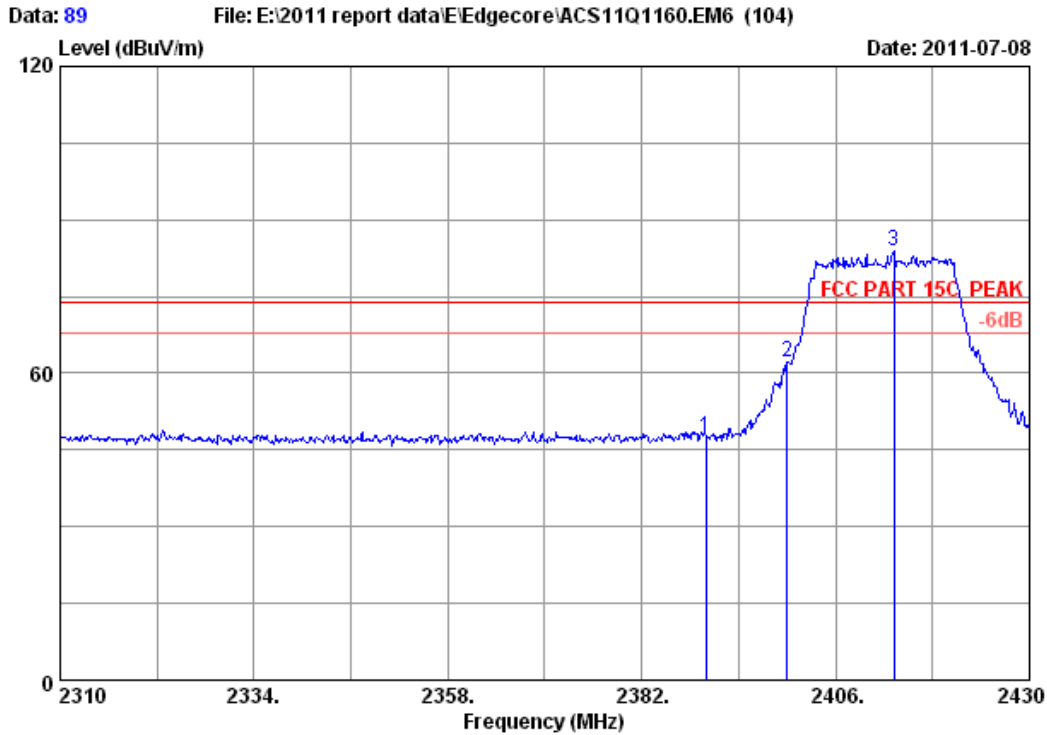

Site no. : 3m Chamber Data no. : 89
 Dis. / Ant. : 3m 3115(0911) Ant. pol. : HORIZONTAL
 Limit : FCC PART 15C PEAK
 Env. / Ins. : 23°C/54% Engineer : Leo-Li
 EUT : 150 Mbps 4-port Wireless Broadband Router
 Power : DC 9V From Adapter input AC 120V/60Hz
 Test mode : IEEE802.11nHT20 CH1 2412MHz Tx
 M/N : SMCWBR14S-N5

| | Ant. Freq. (MHz) | Ant. Factor (dB/m) | Cable loss (dB) | Amp. Factor (dB) | Reading (dBuV) | Emission Level (dBuV/m) | Limits (dBuV/m) | Margin (dB) | Remark |
|---|------------------|--------------------|-----------------|------------------|----------------|-------------------------|-----------------|-------------|--------|
| 1 | 2390.000 | 29.44 | 7.39 | 36.62 | 47.14 | 47.35 | 74.00 | 26.65 | Peak |
| 2 | 2400.000 | 29.44 | 7.43 | 36.62 | 62.03 | 62.28 | 74.00 | 11.72 | Peak |
| 3 | 2413.200 | 29.45 | 7.43 | 36.62 | 83.52 | 83.78 | 74.00 | -9.78 | Peak |

Remarks:

1. Emission Level= Antenna Factor + Cable Loss -Amp Factor + Reading.
2. The emission levels that are 20dB below the official limit are not reported.

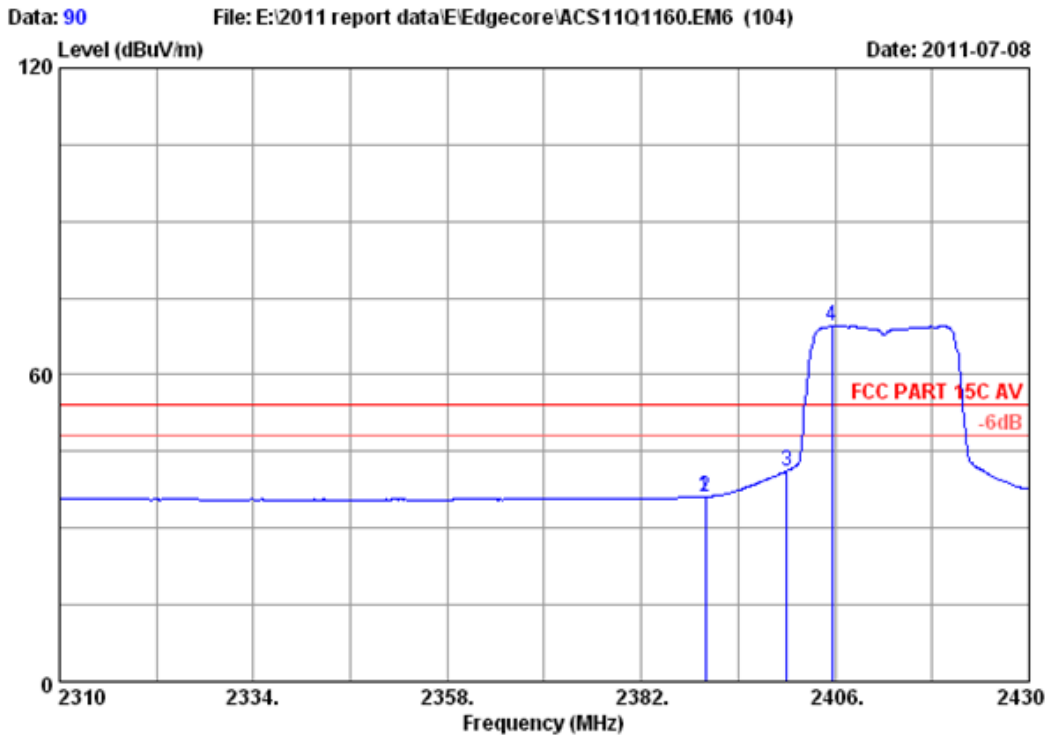

Site no. : 3m Chamber Data no. : 90
 Dis. / Ant. : 3m 3115(0911) Ant. pol. : HORIZONTAL
 Limit : FCC PART 15C AV
 Env. / Ins. : 23°C/54% Engineer : Leo-Li
 EUT : 150 Mbps 4-port Wireless Broadband Router
 Power : DC 9V From Adapter input AC 120V/60Hz
 Test mode : IEEE802.11nHT20 CH1 2412MHz Tx
 M/N : SMCWBR14S-N5

| | Freq. (MHz) | Ant. Factor (dB/m) | Cable loss (dB) | Amp. Factor (dB) | Reading (dBuV) | Emission Level (dBuV/m) | Limits (dBuV/m) | Margin (dB) | Remark |
|---|-------------|--------------------|-----------------|------------------|----------------|-------------------------|-----------------|-------------|---------|
| 1 | 2390.000 | 29.44 | 7.39 | 36.62 | 35.92 | 36.13 | 54.00 | 17.87 | Average |
| 2 | 2390.000 | 29.44 | 7.39 | 36.62 | 35.92 | 36.13 | 54.00 | 17.87 | Average |
| 3 | 2400.000 | 29.44 | 7.43 | 36.62 | 40.98 | 41.23 | 54.00 | 12.77 | Average |
| 4 | 2405.640 | 29.45 | 7.43 | 36.62 | 69.27 | 69.53 | 54.00 | -15.53 | Average |

Remarks:

1. Emission Level= Antenna Factor + Cable Loss -Amp Factor + Reading.
2. The emission levels that are 20dB below the official limit are not reported.

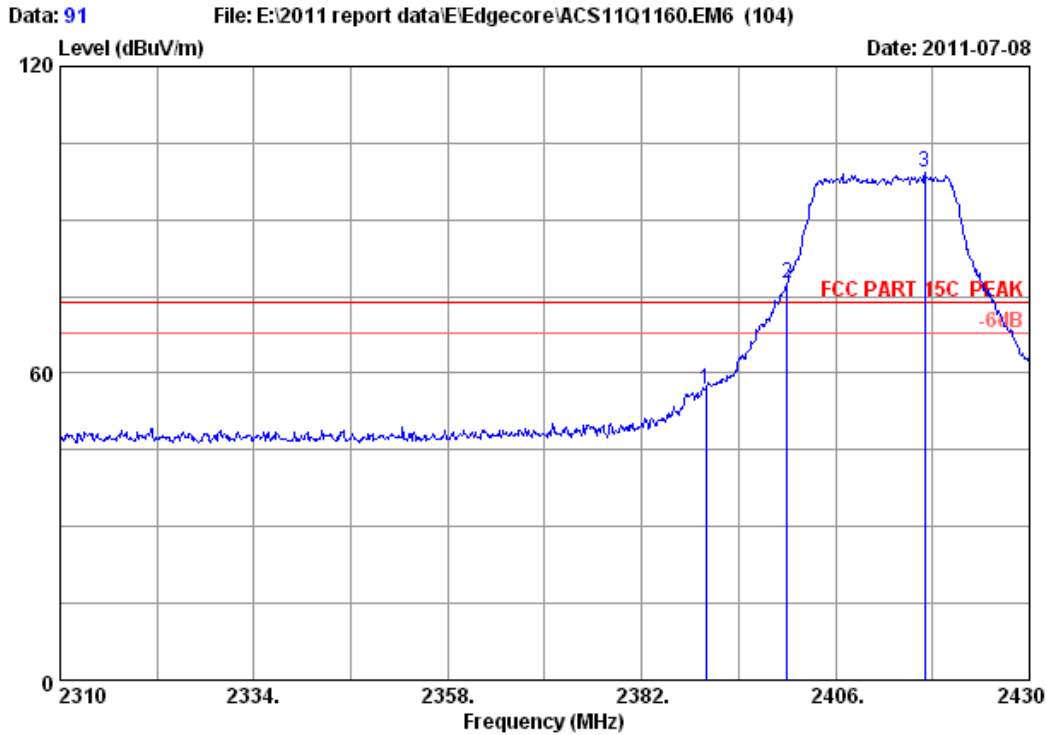

Site no. : 3m Chamber Data no. : 91
 Dis. / Ant. : 3m 3115(0911) Ant. pol. : VERTICAL
 Limit : FCC PART 15C PEAK
 Env. / Ins. : 23°C/54% Engineer : Leo-Li
 EUT : 150 Mbps 4-port Wireless Broadband Router
 Power : DC 9V From Adapter input AC 120V/60Hz
 Test mode : IEEE802.11nHT20 CH1 2412MHz Tx
 M/N : SMCWBR14S-N5

| | Ant. Freq. (MHz) | Ant. Factor (dB/m) | Cable loss (dB) | Amp. Factor (dB) | Reading (dBuV) | Emission Level (dBuV/m) | Limits (dBuV/m) | Margin (dB) | Remark |
|---|------------------|--------------------|-----------------|------------------|----------------|-------------------------|-----------------|-------------|--------|
| 1 | 2390.000 | 29.44 | 7.39 | 36.62 | 56.47 | 56.68 | 74.00 | 17.32 | Peak |
| 2 | 2400.000 | 29.44 | 7.43 | 36.62 | 77.14 | 77.39 | 74.00 | -3.39 | Peak |
| 3 | 2417.040 | 29.45 | 7.43 | 36.61 | 99.08 | 99.35 | 74.00 | -25.35 | Peak |

Remarks:

1. Emission Level= Antenna Factor + Cable Loss -Amp Factor + Reading.
2. The emission levels that are 20dB below the official limit are not reported.

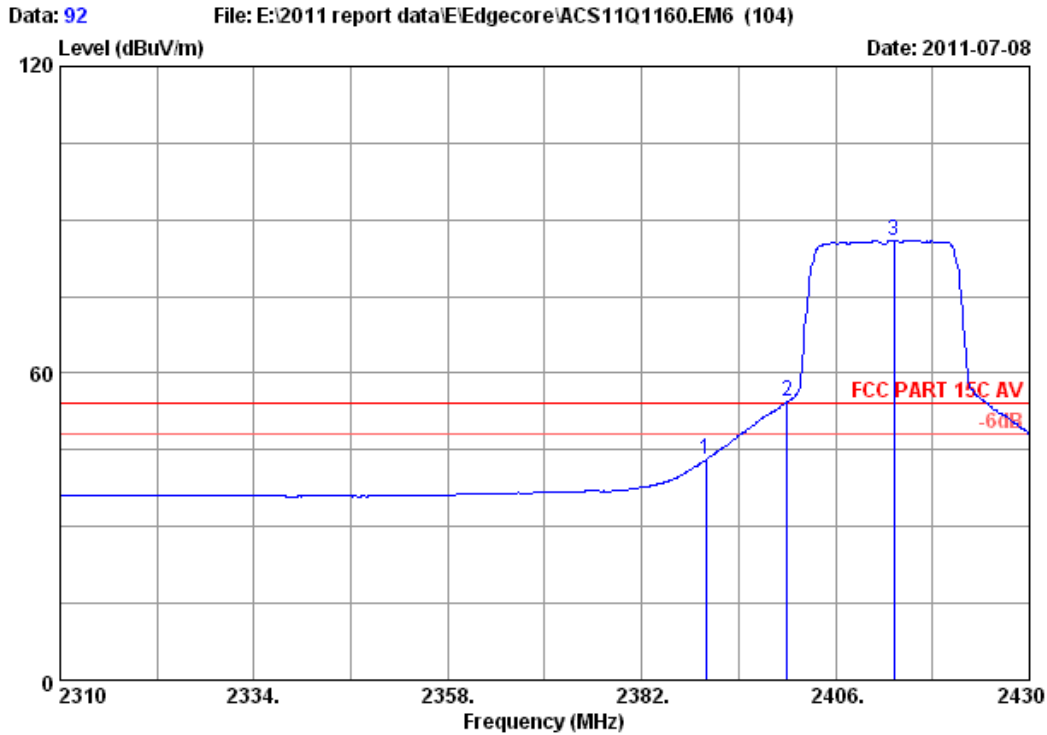

Site no. : 3m Chamber Data no. : 92
 Dis. / Ant. : 3m 3115(0911) Ant. pol. : VERTICAL
 Limit : FCC PART 15C AV
 Env. / Ins. : 23°C/54% Engineer : Leo-Li
 EUT : 150 Mbps 4-port Wireless Broadband Router
 Power : DC 9V From Adapter input AC 120V/60Hz
 Test mode : IEEE802.11nHT20 CH1 2412MHz Tx
 M/N : SMCWBR14S-N5

| | Ant. Freq. (MHz) | Ant. Factor (dB/m) | Cable loss (dB) | Amp. Factor (dB) | Reading (dBuV) | Emission Level (dBuV/m) | Limits (dBuV/m) | Margin (dB) | Remark |
|---|------------------|--------------------|-----------------|------------------|----------------|-------------------------|-----------------|-------------|---------|
| 1 | 2390.000 | 29.44 | 7.39 | 36.62 | 42.94 | 43.15 | 54.00 | 10.85 | Average |
| 2 | 2400.000 | 29.44 | 7.43 | 36.62 | 54.15 | 54.40 | 54.00 | -0.40 | Average |
| 3 | 2413.200 | 29.45 | 7.43 | 36.62 | 85.74 | 86.00 | 54.00 | -32.00 | Average |

Remarks:

1. Emission Level= Antenna Factor + Cable Loss -Amp Factor + Reading.
2. The emission levels that are 20dB below the official limit are not reported.

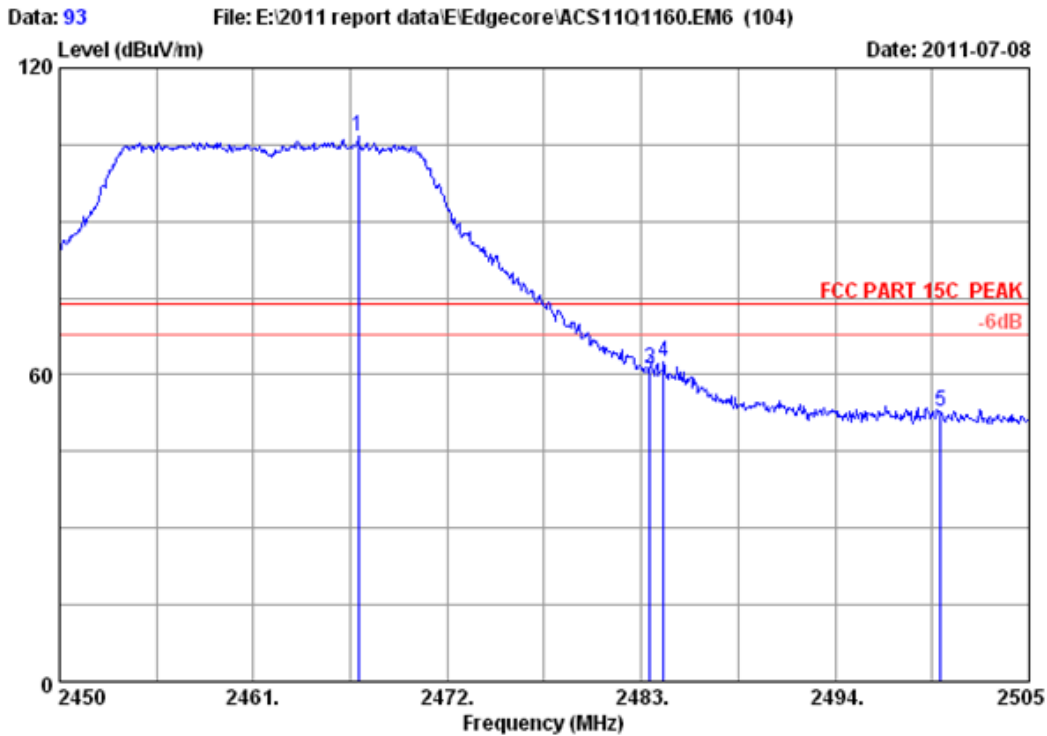

Site no. : 3m Chamber Data no. : 93
 Dis. / Ant. : 3m 3115(0911) Ant. pol. : VERTICAL
 Limit : FCC PART 15C PEAK
 Env. / Ins. : 23°C/54% Engineer : Leo-Li
 EUT : 150 Mbps 4-port Wireless Broadband Router
 Power : DC 9V From Adapter input AC 120V/60Hz
 Test mode : IEEE802.11nHT20 CH11 2462MHz Tx
 M/N : SMCWBR14S-N5

| | Freq. (MHz) | Ant. Factor (dB/m) | Cable loss (dB) | Amp. Factor (dB) | Reading (dBuV) | Emission Level (dBuV/m) | Limits (dBuV/m) | Margin (dB) | Remark |
|---|-------------|--------------------|-----------------|------------------|----------------|-------------------------|-----------------|-------------|--------|
| 1 | 2466.940 | 29.48 | 7.54 | 36.60 | 106.25 | 106.67 | 74.00 | -32.67 | Peak |
| 2 | 2483.500 | 29.49 | 7.58 | 36.60 | 60.58 | 61.05 | 74.00 | 12.95 | Peak |
| 3 | 2483.500 | 29.49 | 7.58 | 36.60 | 60.58 | 61.05 | 74.00 | 12.95 | Peak |
| 4 | 2484.265 | 29.49 | 7.58 | 36.60 | 62.19 | 62.66 | 74.00 | 11.34 | Peak |
| 5 | 2500.000 | 29.50 | 7.62 | 36.60 | 52.13 | 52.65 | 74.00 | 21.35 | Peak |

Remarks:

1. Emission Level= Antenna Factor + Cable Loss -Amp Factor + Reading.
2. The emission levels that are 20dB below the official limit are not reported.

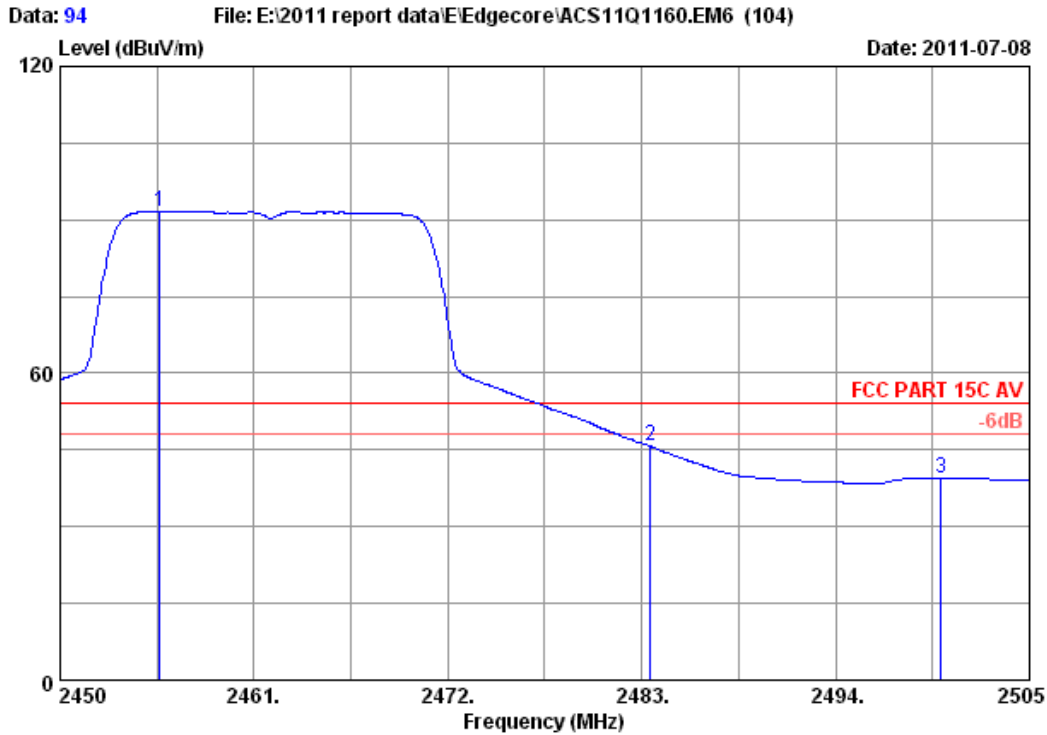

Site no. : 3m Chamber Data no. : 94
 Dis. / Ant. : 3m 3115(0911) Ant. pol. : VERTICAL
 Limit : FCC PART 15C AV
 Env. / Ins. : 23°C/54% Engineer : Leo-Li
 EUT : 150 Mbps 4-port Wireless Broadband Router
 Power : DC 9V From Adapter input AC 120V/60Hz
 Test mode : IEEE802.11nHT20 CH11 2462MHz Tx
 M/N : SMCWBR14S-N5

| | Ant. Freq. (MHz) | Ant. Factor (dB/m) | Cable loss (dB) | Amp. Factor (dB) | Reading (dBuV) | Emission Level (dBuV/m) | Limits (dBuV/m) | Margin (dB) | Remark |
|---|------------------|--------------------|-----------------|------------------|----------------|-------------------------|-----------------|-------------|---------|
| 1 | 2455.665 | 29.48 | 7.50 | 36.61 | 91.34 | 91.71 | 54.00 | -37.71 | Average |
| 2 | 2483.500 | 29.49 | 7.58 | 36.60 | 45.24 | 45.71 | 54.00 | 8.29 | Average |
| 3 | 2500.000 | 29.50 | 7.62 | 36.60 | 38.93 | 39.45 | 54.00 | 14.55 | Average |

Remarks:

1. Emission Level= Antenna Factor + Cable Loss -Amp Factor + Reading.
2. The emission levels that are 20dB below the official limit are not reported.

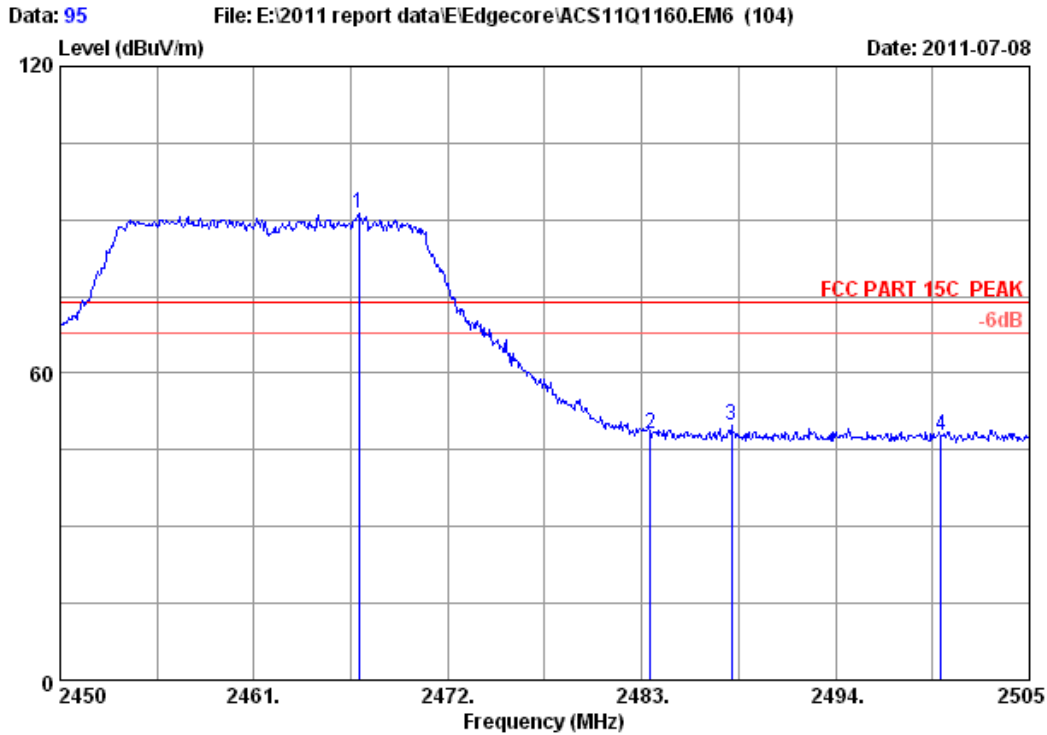

Site no. : 3m Chamber Data no. : 95
 Dis. / Ant. : 3m 3115(0911) Ant. pol. : HORIZONTAL
 Limit : FCC PART 15C PEAK
 Env. / Ins. : 23°C/54% Engineer : Leo-Li
 EUT : 150 Mbps 4-port Wireless Broadband Router
 Power : DC 9V From Adapter input AC 120V/60Hz
 Test mode : IEEE802.11nHT20 CH11 2462MHz Tx
 M/N : SMCWBR14S-N5

| | Freq. (MHz) | Ant. Factor (dB/m) | Cable loss (dB) | Amp. Factor (dB) | Reading (dBuV) | Emission Level (dBuV/m) | Limits (dBuV/m) | Margin (dB) | Remark |
|---|----------------|--------------------------|-----------------------|------------------------|-------------------|-------------------------------|--------------------|----------------|--------|
| 1 | 2466.940 | 29.48 | 7.54 | 36.60 | 90.67 | 91.09 | 74.00 | -17.09 | Peak |
| 2 | 2483.500 | 29.49 | 7.58 | 36.60 | 47.51 | 47.98 | 74.00 | 26.02 | Peak |
| 3 | 2488.115 | 29.50 | 7.58 | 36.60 | 49.20 | 49.68 | 74.00 | 24.32 | Peak |
| 4 | 2500.000 | 29.50 | 7.62 | 36.60 | 47.19 | 47.71 | 74.00 | 26.29 | Peak |

Remarks:

1. Emission Level= Antenna Factor + Cable Loss -Amp Factor + Reading.
2. The emission levels that are 20dB below the official limit are not reported.

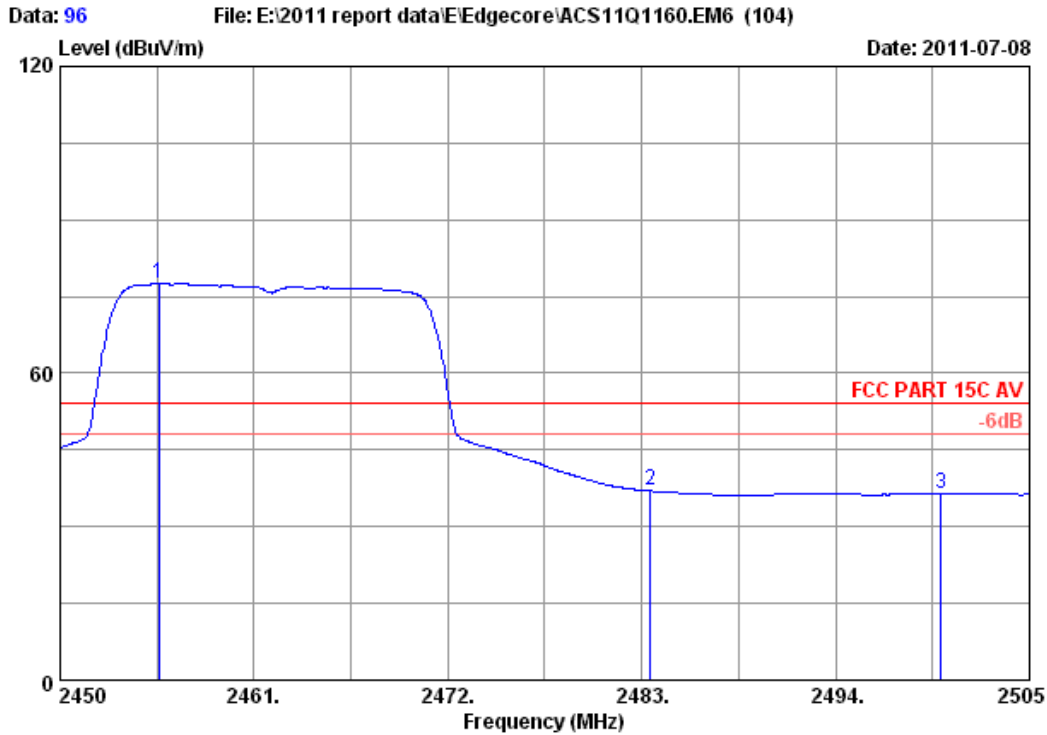

Site no. : 3m Chamber Data no. : 96
 Dis. / Ant. : 3m 3115(0911) Ant. pol. : HORIZONTAL
 Limit : FCC PART 15C AV
 Env. / Ins. : 23°C/54% Engineer : Leo-Li
 EUT : 150 Mbps 4-port Wireless Broadband Router
 Power : DC 9V From Adapter input AC 120V/60Hz
 Test mode : IEEE802.11nHT20 CH11 2462MHz Tx
 M/N : SMCWBR14S-N5

| | Ant. Freq. (MHz) | Ant. Factor (dB/m) | Cable loss (dB) | Amp. Factor (dB) | Reading (dBuV) | Emission Level (dBuV/m) | Limits (dBuV/m) | Margin (dB) | Remark |
|---|------------------|--------------------|-----------------|------------------|----------------|-------------------------|-----------------|-------------|---------|
| 1 | 2455.610 | 29.48 | 7.50 | 36.61 | 77.16 | 77.53 | 54.00 | -23.53 | Average |
| 2 | 2483.500 | 29.49 | 7.58 | 36.60 | 36.50 | 36.97 | 54.00 | 17.03 | Average |
| 3 | 2500.000 | 29.50 | 7.62 | 36.60 | 35.76 | 36.28 | 54.00 | 17.72 | Average |

Remarks:

1. Emission Level= Antenna Factor + Cable Loss -Amp Factor + Reading.
2. The emission levels that are 20dB below the official limit are not reported.

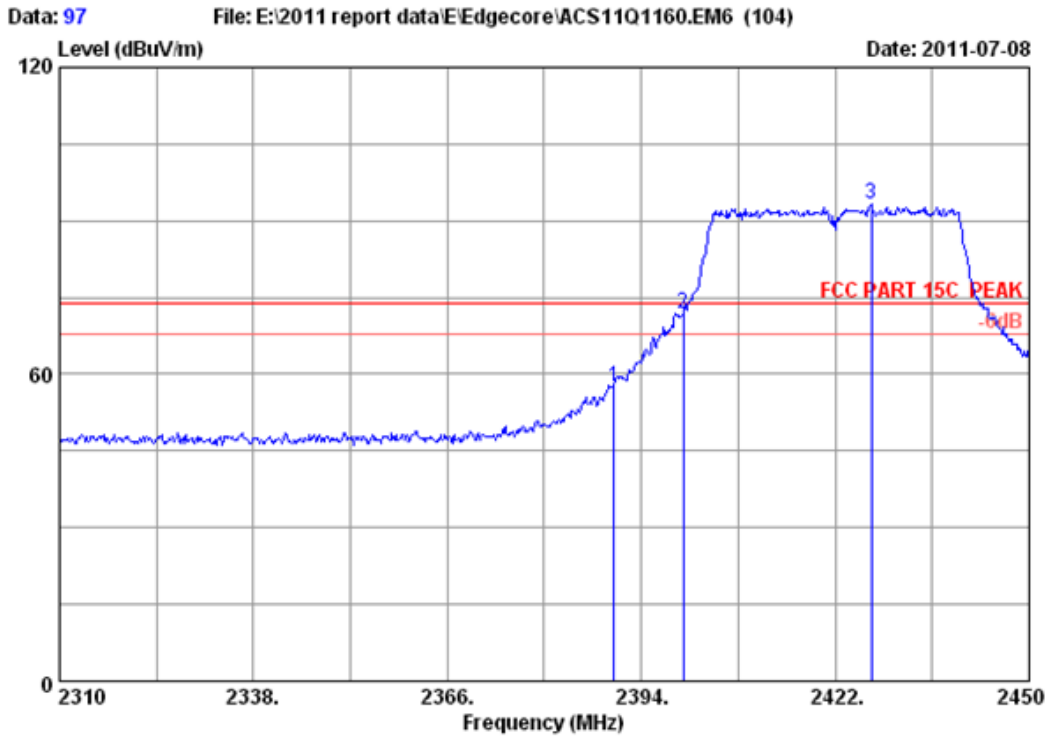

Site no. : 3m Chamber Data no. : 97
 Dis. / Ant. : 3m 3115(0911) Ant. pol. : VERTICAL
 Limit : FCC PART 15C PEAK
 Env. / Ins. : 23°C/54% Engineer : Leo-Li
 EUT : 150 Mbps 4-port Wireless Broadband Router
 Power : DC 9V From Adapter input AC 120V/60Hz
 Test mode : IEEE802.11nHT40 CH1 2422MHz Tx
 M/N : SMCWBR14S-N5

| | Ant. Freq. (MHz) | Ant. Factor (dB/m) | Cable loss (dB) | Amp. Factor (dB) | Reading (dBuV) | Emission Level (dBuV/m) | Limits (dBuV/m) | Margin (dB) | Remark |
|---|------------------|--------------------|-----------------|------------------|----------------|-------------------------|-----------------|-------------|--------|
| 1 | 2390.000 | 29.44 | 7.39 | 36.62 | 57.29 | 57.50 | 74.00 | 16.50 | Peak |
| 2 | 2400.000 | 29.44 | 7.43 | 36.62 | 71.46 | 71.71 | 74.00 | 2.29 | Peak |
| 3 | 2427.180 | 29.46 | 7.46 | 36.61 | 92.96 | 93.27 | 74.00 | -19.27 | Peak |

Remarks:

1. Emission Level= Antenna Factor + Cable Loss -Amp Factor + Reading.
2. The emission levels that are 20dB below the official limit are not reported.

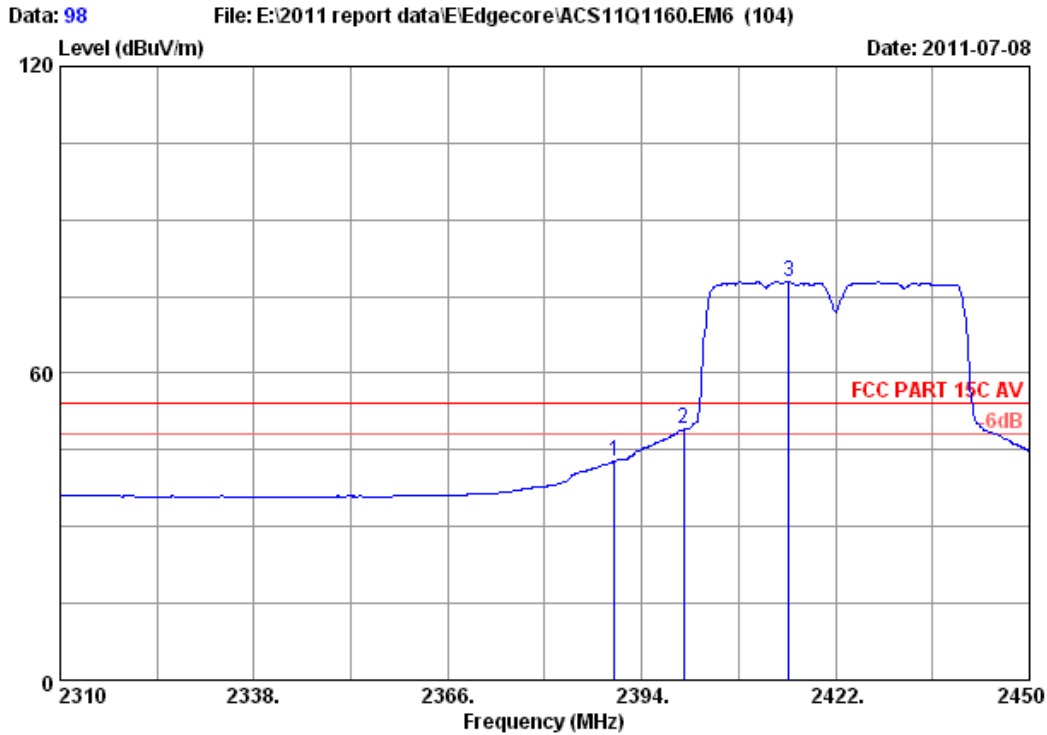

Site no. : 3m Chamber Data no. : 98
 Dis. / Ant. : 3m 3115(0911) Ant. pol. : VERTICAL
 Limit : FCC PART 15C AV
 Env. / Ins. : 23°C/54% Engineer : Leo-Li
 EUT : 150 Mbps 4-port Wireless Broadband Router
 Power : DC 9V From Adapter input AC 120V/60Hz
 Test mode : IEEE802.11nHT40 CH1 2422MHz Tx
 M/N : SMCWBR14S-N5

| | Ant. Freq. (MHz) | Ant. Factor (dB/m) | Cable loss (dB) | Amp. Factor (dB) | Reading (dBuV) | Emission Level (dBuV/m) | Limits (dBuV/m) | Margin (dB) | Remark |
|---|------------------|--------------------|-----------------|------------------|----------------|-------------------------|-----------------|-------------|---------|
| 1 | 2390.000 | 29.44 | 7.39 | 36.62 | 42.48 | 42.69 | 54.00 | 11.31 | Average |
| 2 | 2400.000 | 29.44 | 7.43 | 36.62 | 48.73 | 48.98 | 54.00 | 5.02 | Average |
| 3 | 2415.280 | 29.45 | 7.43 | 36.61 | 77.59 | 77.86 | 54.00 | -23.86 | Average |

Remarks:

1. Emission Level= Antenna Factor + Cable Loss -Amp Factor + Reading.
2. The emission levels that are 20dB below the official limit are not reported.

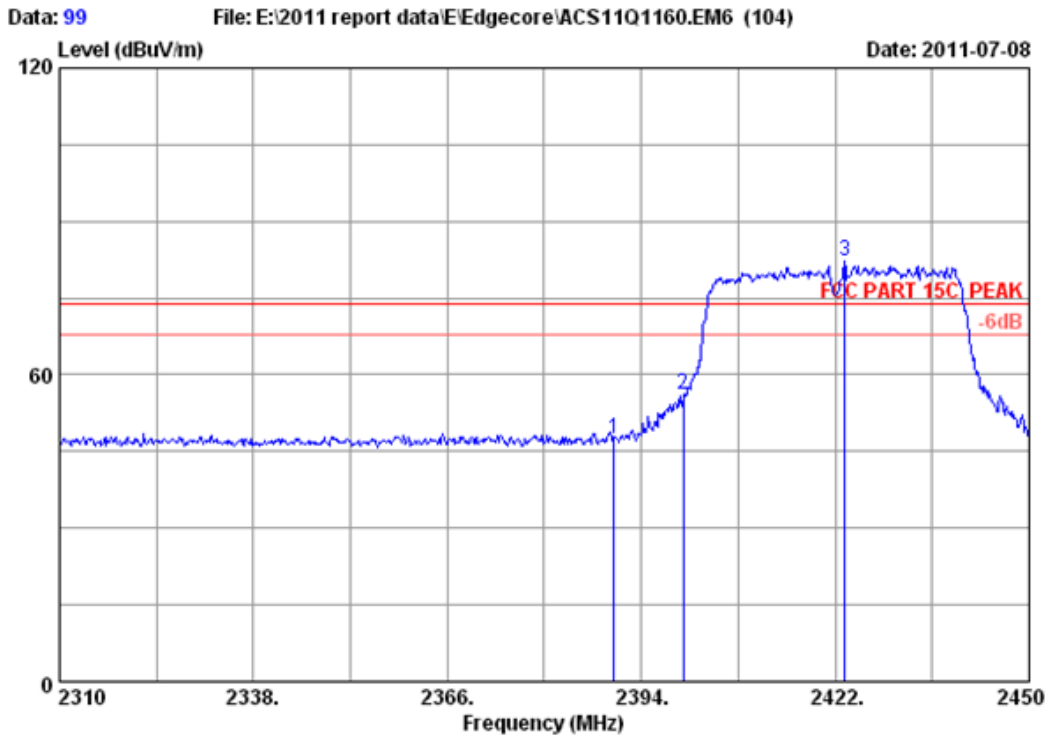

Site no. : 3m Chamber Data no. : 99
 Dis. / Ant. : 3m 3115(0911) Ant. pol. : HORIZONTAL
 Limit : FCC PART 15C PEAK
 Env. / Ins. : 23°C/54% Engineer : Leo-Li
 EUT : 150 Mbps 4-port Wireless Broadband Router
 Power : DC 9V From Adapter input AC 120V/60Hz
 Test mode : IEEE802.11nHT40 CH1 2422MHz Tx
 M/N : SMCWBR14S-N5

| | Freq. (MHz) | Ant. Factor (dB/m) | Cable loss (dB) | Amp. Factor (dB) | Reading (dBuV) | Emission Level (dBuV/m) | Limits (dBuV/m) | Margin (dB) | Remark |
|---|-------------|--------------------|-----------------|------------------|----------------|-------------------------|-----------------|-------------|--------|
| 1 | 2390.000 | 29.44 | 7.39 | 36.62 | 47.29 | 47.50 | 74.00 | 26.50 | Peak |
| 2 | 2400.000 | 29.44 | 7.43 | 36.62 | 55.88 | 56.13 | 74.00 | 17.87 | Peak |
| 3 | 2423.400 | 29.46 | 7.46 | 36.61 | 81.77 | 82.08 | 74.00 | -8.08 | Peak |

Remarks:

1. Emission Level= Antenna Factor + Cable Loss -Amp Factor + Reading.
2. The emission levels that are 20dB below the official limit are not reported.

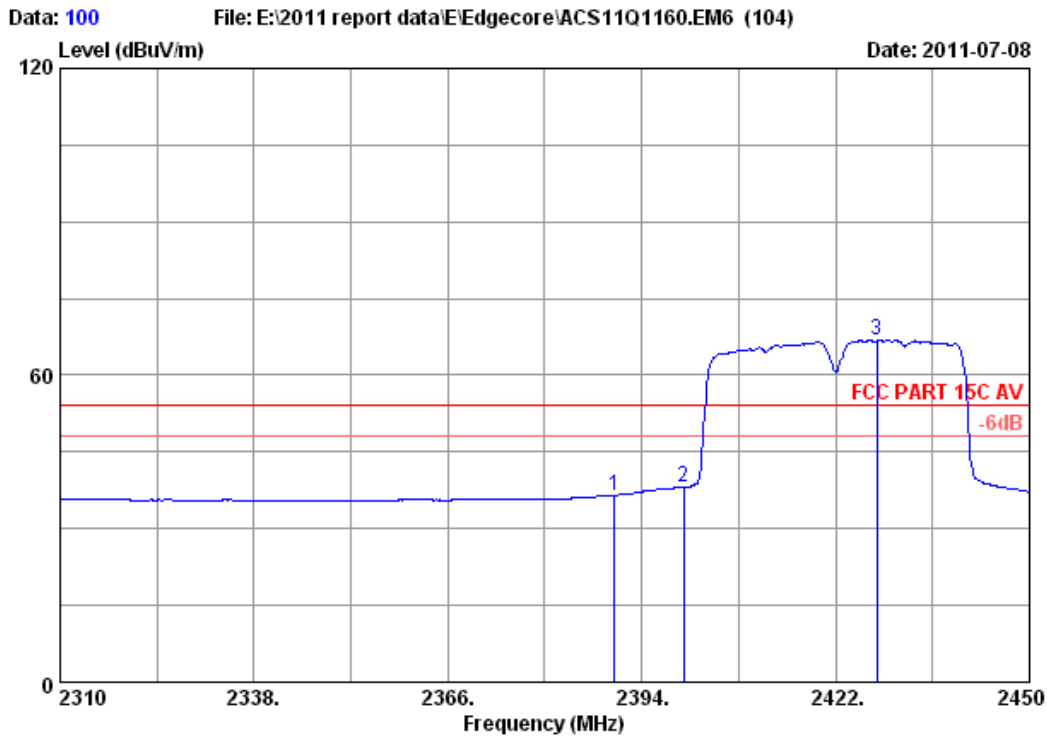

Site no. : 3m Chamber Data no. : 100
 Dis. / Ant. : 3m 3115(0911) Ant. pol. : HORIZONTAL
 Limit : FCC PART 15C AV
 Env. / Ins. : 23°C/54% Engineer : Leo-Li
 EUT : 150 Mbps 4-port Wireless Broadband Router
 Power : DC 9V From Adapter input AC 120V/60Hz
 Test mode : IEEE802.11nHT40 CH1 2422MHz Tx
 M/N : SMCWBR14S-N5

| | Ant. Freq. (MHz) | Ant. Factor (dB/m) | Cable loss (dB) | Amp. Factor (dB) | Reading (dBuV) | Emission Level (dBuV/m) | Limits (dBuV/m) | Margin (dB) | Remark |
|---|------------------|--------------------|-----------------|------------------|----------------|-------------------------|-----------------|-------------|---------|
| 1 | 2390.000 | 29.44 | 7.39 | 36.62 | 36.34 | 36.55 | 54.00 | 17.45 | Average |
| 2 | 2400.000 | 29.44 | 7.43 | 36.62 | 37.90 | 38.15 | 54.00 | 15.85 | Average |
| 3 | 2428.020 | 29.46 | 7.46 | 36.61 | 66.60 | 66.91 | 54.00 | -12.91 | Average |

Remarks:

1. Emission Level= Antenna Factor + Cable Loss -Amp Factor + Reading.
2. The emission levels that are 20dB below the official limit are not reported.

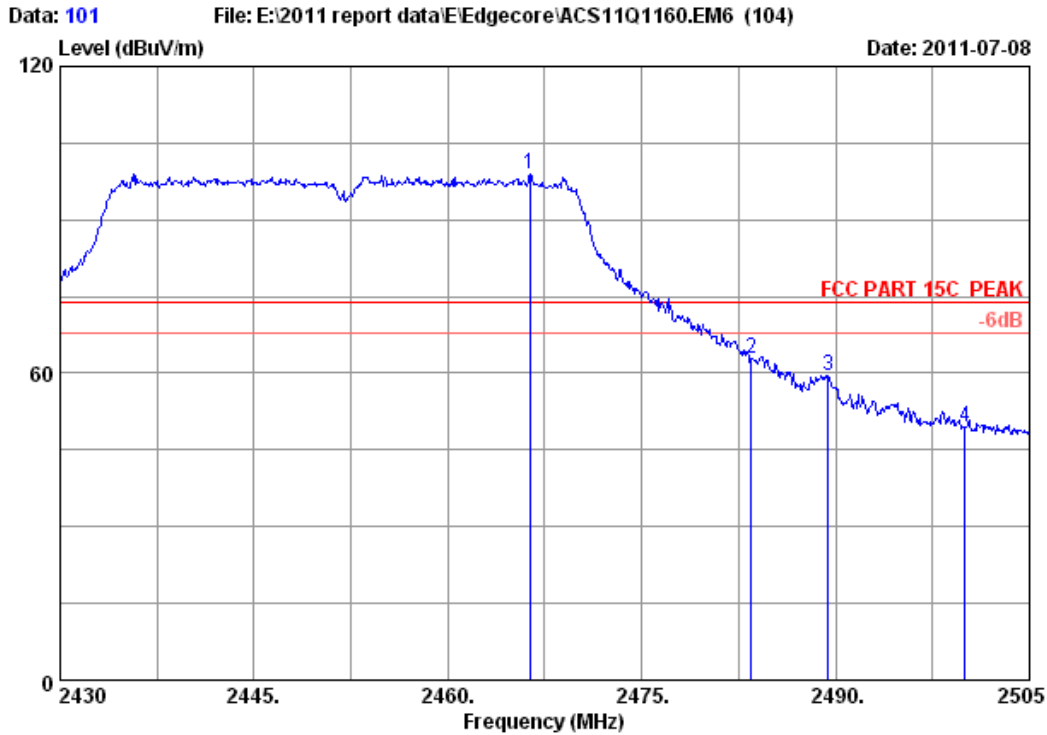

Site no. : 3m Chamber Data no. : 101
 Dis. / Ant. : 3m 3115(0911) Ant. pol. : VERTICAL
 Limit : FCC PART 15C PEAK
 Env. / Ins. : 23°C/54% Engineer : Leo-Li
 EUT : 150 Mbps 4-port Wireless Broadband Router
 Power : DC 9V From Adapter input AC 120V/60Hz
 Test mode : IEEE802.11nHT40 CH7 2452MHz Tx
 M/N : SMCWBR14S-N5

| | Freq. (MHz) | Ant. Factor (dB/m) | Cable loss (dB) | Amp. Factor (dB) | Reading (dBuV) | Emission Level (dBuV/m) | Limits (dBuV/m) | Margin (dB) | Remark |
|---|----------------|--------------------------|-----------------------|------------------------|-------------------|-------------------------------|--------------------|----------------|--------|
| 1 | 2466.375 | 29.48 | 7.54 | 36.60 | 98.68 | 99.10 | 74.00 | -25.10 | Peak |
| 2 | 2483.500 | 29.49 | 7.58 | 36.60 | 62.47 | 62.94 | 74.00 | 11.06 | Peak |
| 3 | 2489.400 | 29.50 | 7.58 | 36.60 | 59.18 | 59.66 | 74.00 | 14.34 | Peak |
| 4 | 2500.000 | 29.50 | 7.62 | 36.60 | 49.05 | 49.57 | 74.00 | 24.43 | Peak |

Remarks:

1. Emission Level= Antenna Factor + Cable Loss -Amp Factor + Reading.
2. The emission levels that are 20dB below the official limit are not reported.

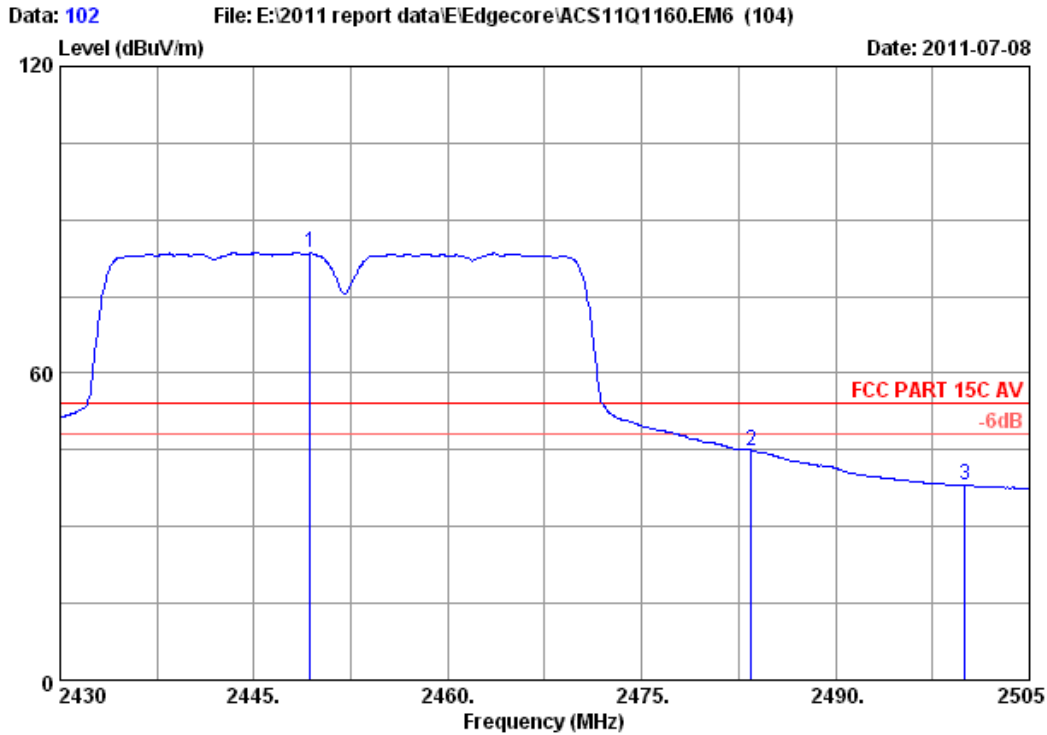

Site no. : 3m Chamber Data no. : 102
 Dis. / Ant. : 3m 3115(0911) Ant. pol. : VERTICAL
 Limit : FCC PART 15C AV
 Env. / Ins. : 23°C/54% Engineer : Leo-Li
 EUT : 150 Mbps 4-port Wireless Broadband Router
 Power : DC 9V From Adapter input AC 120V/60Hz
 Test mode : IEEE802.11nHT40 CH7 2452MHz Tx
 M/N : SMCWBR14S-N5

| | Ant. Freq. (MHz) | Ant. Factor (dB/m) | Cable loss (dB) | Amp. Factor (dB) | Reading (dBuV) | Emission Level (dBuV/m) | Limits (dBuV/m) | Margin (dB) | Remark |
|---|------------------|--------------------|-----------------|------------------|----------------|-------------------------|-----------------|-------------|---------|
| 1 | 2449.350 | 29.47 | 7.50 | 36.61 | 83.12 | 83.48 | 54.00 | -29.48 | Average |
| 2 | 2483.500 | 29.49 | 7.58 | 36.60 | 44.46 | 44.93 | 54.00 | 9.07 | Average |
| 3 | 2500.000 | 29.50 | 7.62 | 36.60 | 37.50 | 38.02 | 54.00 | 15.98 | Average |

Remarks:

1. Emission Level= Antenna Factor + Cable Loss -Amp Factor + Reading.
2. The emission levels that are 20dB below the official limit are not reported.

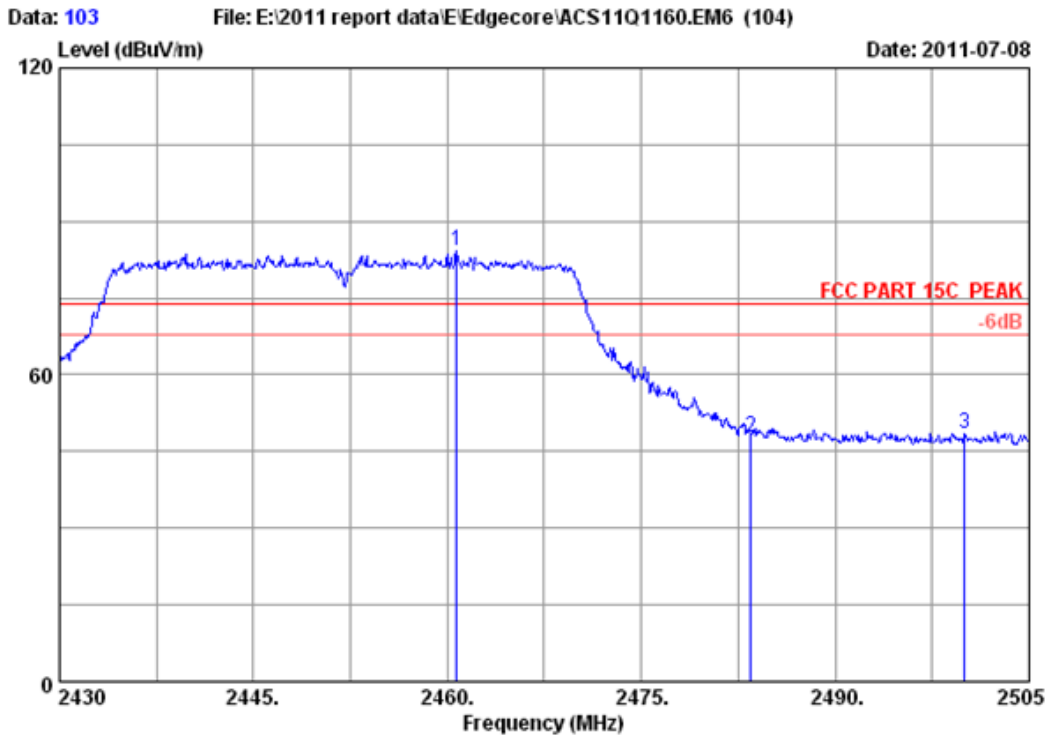

Site no. : 3m Chamber Data no. : 103
 Dis. / Ant. : 3m 3115(0911) Ant. pol. : HORIZONTAL
 Limit : FCC PART 15C PEAK
 Env. / Ins. : 23°C/54% Engineer : Leo-Li
 EUT : 150 Mbps 4-port Wireless Broadband Router
 Power : DC 9V From Adapter input AC 120V/60Hz
 Test mode : IEEE802.11nHT40 CH7 2452MHz Tx
 M/N : SMCWBR14S-N5

| | Freq. (MHz) | Ant. Factor (dB/m) | Cable loss (dB) | Amp. Factor (dB) | Reading (dBuV) | Emission Level (dBuV/m) | Limits (dBuV/m) | Margin (dB) | Remark |
|---|-------------|--------------------|-----------------|------------------|----------------|-------------------------|-----------------|-------------|--------|
| 1 | 2460.750 | 29.48 | 7.54 | 36.61 | 83.75 | 84.16 | 74.00 | -10.16 | Peak |
| 2 | 2483.500 | 29.49 | 7.58 | 36.60 | 47.26 | 47.73 | 74.00 | 26.27 | Peak |
| 3 | 2500.000 | 29.50 | 7.62 | 36.60 | 47.89 | 48.41 | 74.00 | 25.59 | Peak |

Remarks:

1. Emission Level= Antenna Factor + Cable Loss -Amp Factor + Reading.
2. The emission levels that are 20dB below the official limit are not reported.

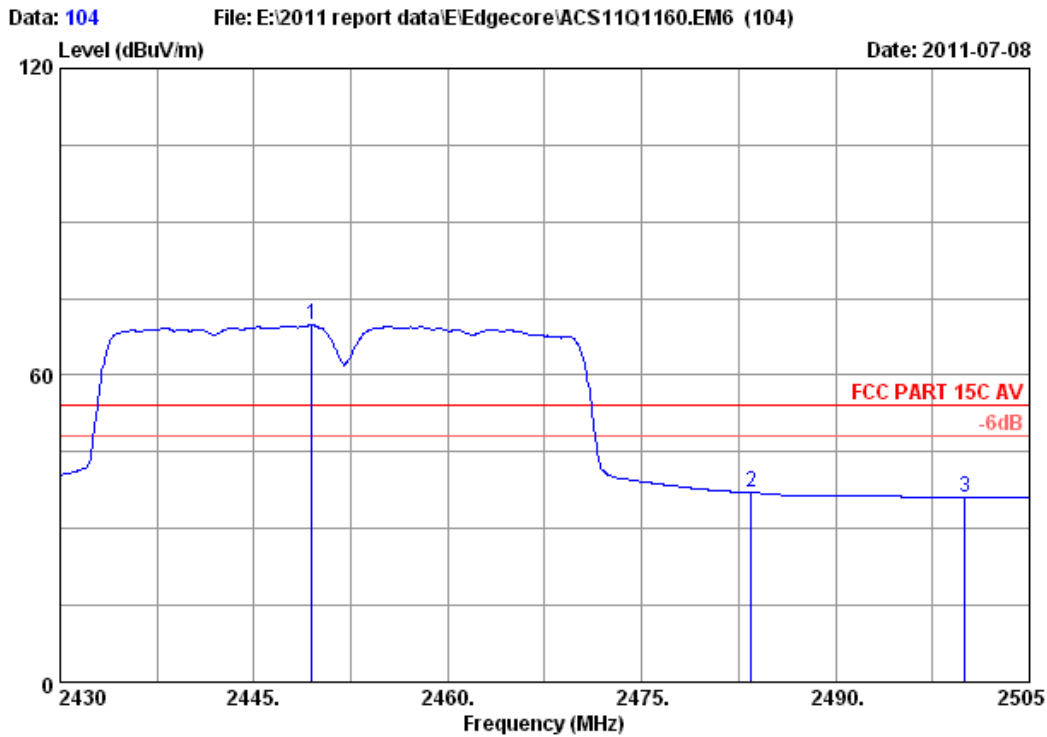

Site no. : 3m Chamber Data no. : 104
 Dis. / Ant. : 3m 3115(0911) Ant. pol. : HORIZONTAL
 Limit : FCC PART 15C AV
 Env. / Ins. : 23*C/54% Engineer : Leo-Li
 EUT : 150 Mbps 4-port Wireless Broadband Router
 Power : DC 9V From Adapter input AC 120V/60Hz
 Test mode : IEEE802.11nHT40 CH7 2452MHz Tx
 M/N : SMCWBR14S-N5

| | Ant. Freq. (MHz) | Ant. Factor (dB/m) | Cable loss (dB) | Amp. Factor (dB) | Reading (dBuV) | Emission Level (dBuV/m) | Limits (dBuV/m) | Margin (dB) | Remark |
|---|------------------|--------------------|-----------------|------------------|----------------|-------------------------|-----------------|-------------|---------|
| 1 | 2449.500 | 29.47 | 7.50 | 36.61 | 69.44 | 69.80 | 54.00 | -15.80 | Average |
| 2 | 2483.500 | 29.49 | 7.58 | 36.60 | 36.56 | 37.03 | 54.00 | 16.97 | Average |
| 3 | 2500.000 | 29.50 | 7.62 | 36.60 | 35.70 | 36.22 | 54.00 | 17.78 | Average |

Remarks:

1. Emission Level= Antenna Factor + Cable Loss -Amp Factor + Reading.
2. The emission levels that are 20dB below the official limit are not reported.

7. 6dB Bandwidth Test

7.1. Test Equipment

| Item | Equipment | Manufacturer | Model No. | Serial No. | Last Cal. | Cal. Interval |
|------|-------------------|--------------|-------------|------------|-----------|---------------|
| 1. | Spectrum Analyzer | Agilent | E4446A | US44300459 | May.08,11 | 1 Year |
| 2. | Attenuator | Agilent | 8491B | MY39262165 | May.08,11 | 1 Year |
| 3. | RF Cable | Hubersuhner | SUCOFLEX102 | 28618/2 | May.08,11 | 1Year |

7.2. Limit

For direct sequence systems, the minimum 6dB bandwidth shall be at least 500kHz

7.3. Test Procedure

The transmitter output was connected to a spectrum analyzer, The bandwidth of the fundamental frequency was measured by spectrum analyzer with 100kHz RBW and 300 kHz VBW. The 6dB bandwidth is defined as the total spectrum the power of which is higher than peak power minus 6dB.

7.4. Test Results

| | | |
|------------------------------------------------|---------------------|---------------------|
| EUT: 150 Mbps 4-port Wireless Broadband Router | | |
| M/N: SMCWBR14S-N5 | | |
| Test date:2011-07-07 | Pressure: 100.6 kpa | Humidity: 60 % |
| Tested by:Sunny-lu | Test site: RF Site | Temperature : 25 °C |

| Cable loss: 0.6 dB | | Attenuator loss: 20 dB | Antenna Gain: 5 dBi |
|--------------------|------|------------------------|---------------------|
| Test Mode | CH | 6dB bandwidth (MHz) | Limit (KHz) |
| 11b | CH1 | 12.134 | >500 |
| | CH6 | 12.113 | >500 |
| | CH11 | 12.607 | >500 |
| 11g | CH1 | 16.605 | >500 |
| | CH6 | 16.550 | >500 |
| | CH11 | 16.601 | >500 |
| 11n HT20 | CH1 | 17.780 | >500 |
| | CH6 | 17.751 | >500 |
| | CH11 | 17.752 | >500 |
| 11n HT40 | CH1 | 36.403 | >500 |
| | CH4 | 36.125 | >500 |
| | CH7 | 36.184 | >500 |
| Conclusion : PASS | | | |

Test Mode: IEEE 802.11b TX
 Test CH1: 2412MHz

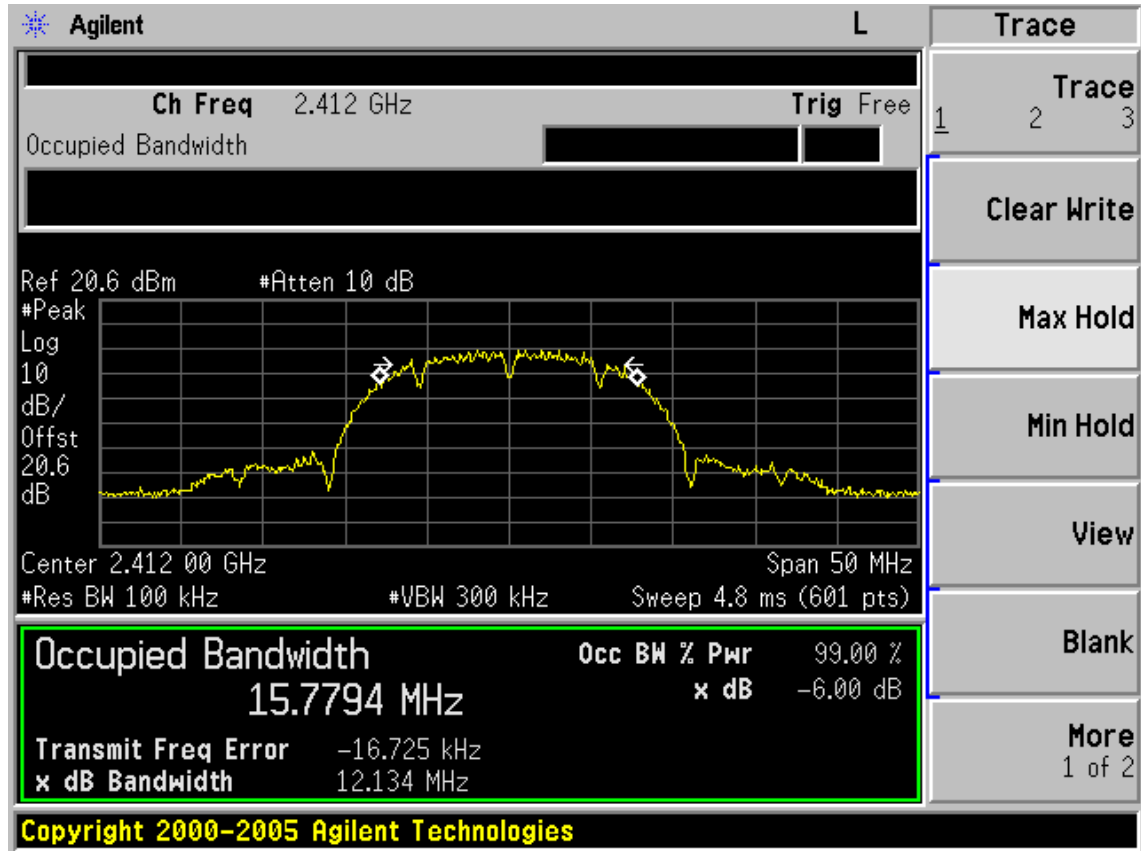

Test CH6: 2437MHz

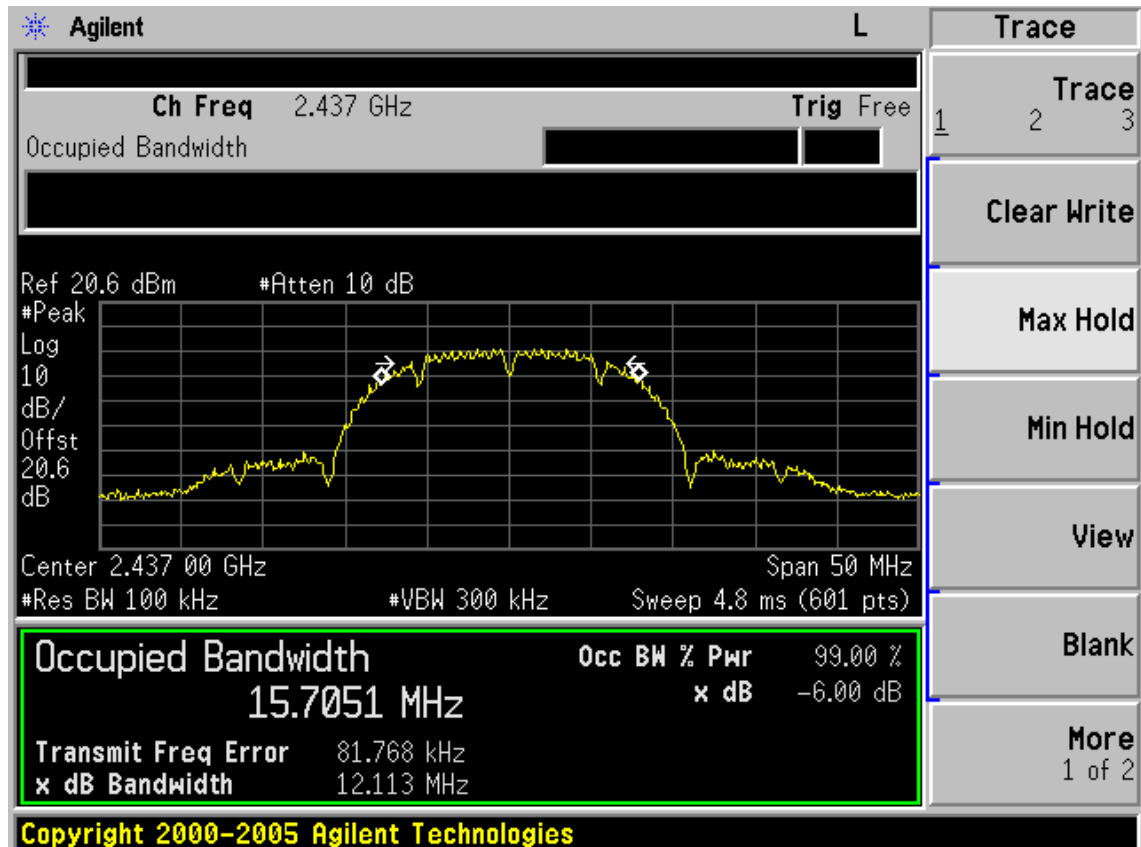

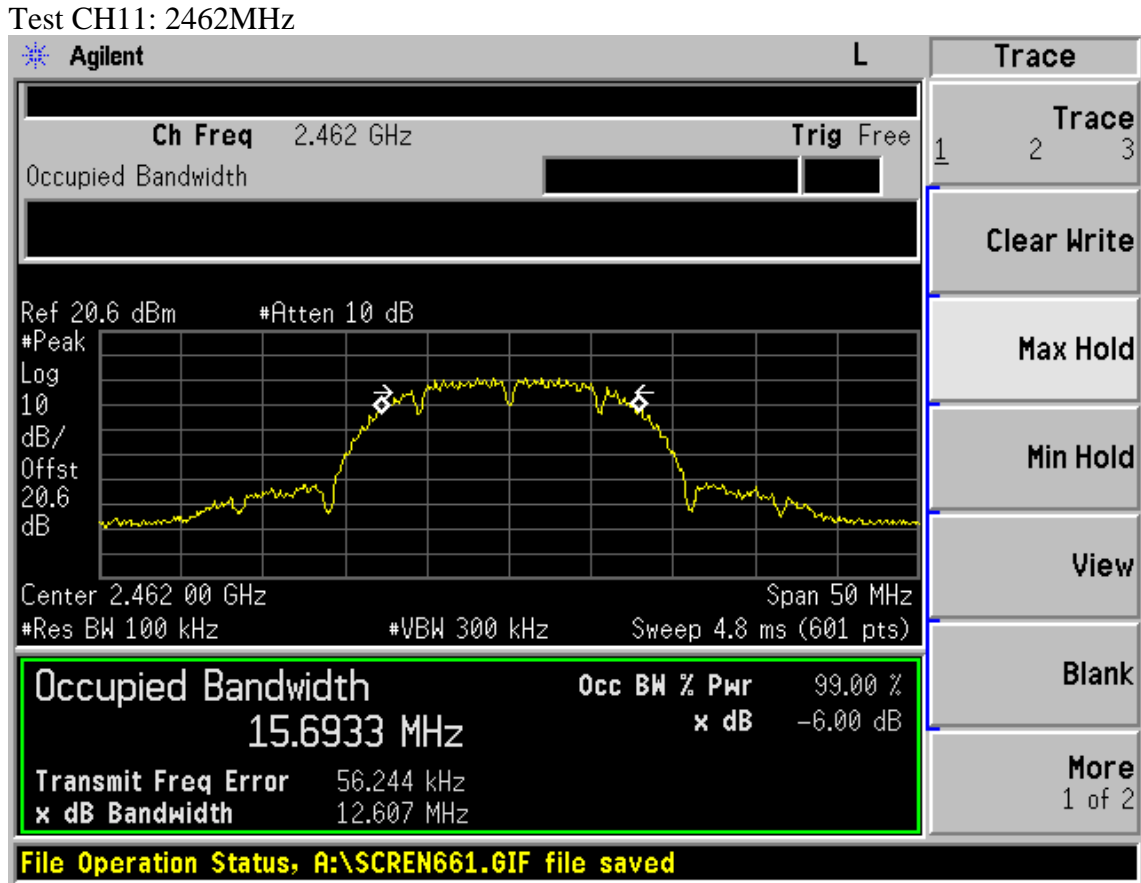

Test Mode: IEEE 802.11g TX
 Test CH1: 2412MHz

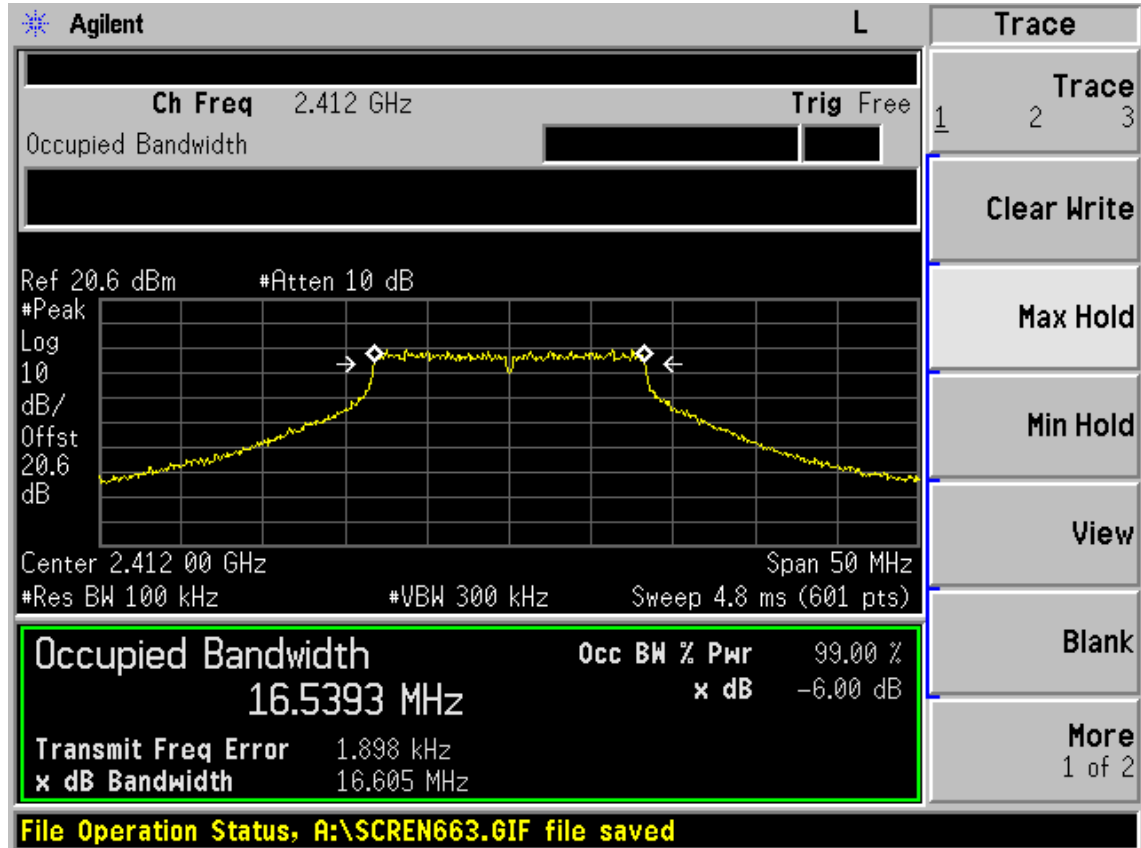

Test CH6: 2437MHz

Agilent
L

Ch Freq 2.437 GHz **Trig** Free

Occupied Bandwidth [] []

Ref 20.6 dBm #Atten 10 dB

#Peak

Log

10

dB/

Offst

20.6

dB

Center 2.437 00 GHz Span 50 MHz

#Res BW 100 kHz #VBW 300 kHz Sweep 4.8 ms (601 pts)

| | | |
|----------------------------|---------------------|----------|
| Occupied Bandwidth | Occ BW % Pwr | 99.00 % |
| 16.4956 MHz | x dB | -6.00 dB |
| Transmit Freq Error | 2.768 kHz | |
| x dB Bandwidth | 16.550 MHz | |

Copyright 2000-2005 Agilent Technologies

Trace

Trace
1 2 3

Clear Write

Max Hold

Min Hold

View

Blank

More
1 of 2

Test CH11: 2462MHz

Agilent
L

Ch Freq 2.462 GHz **Trig** Free

Occupied Bandwidth [] []

Ref 20.6 dBm #Atten 10 dB

#Peak

Log

10

dB/

Offst

20.6

dB

Center 2.462 00 GHz Span 50 MHz

#Res BW 100 kHz #VBW 300 kHz Sweep 4.8 ms (601 pts)

| | | |
|----------------------------|---------------------|----------|
| Occupied Bandwidth | Occ BW % Pwr | 99.00 % |
| 16.5244 MHz | x dB | -6.00 dB |
| Transmit Freq Error | 11.003 kHz | |
| x dB Bandwidth | 16.601 MHz | |

File Operation Status, A:\SCREN667.GIF file saved

Trace

Trace
1 2 3

Clear Write

Max Hold

Min Hold

View

Blank

More
1 of 2

Test Mode: IEEE 802.11n HT20TX

Test CH1: 2412MHz

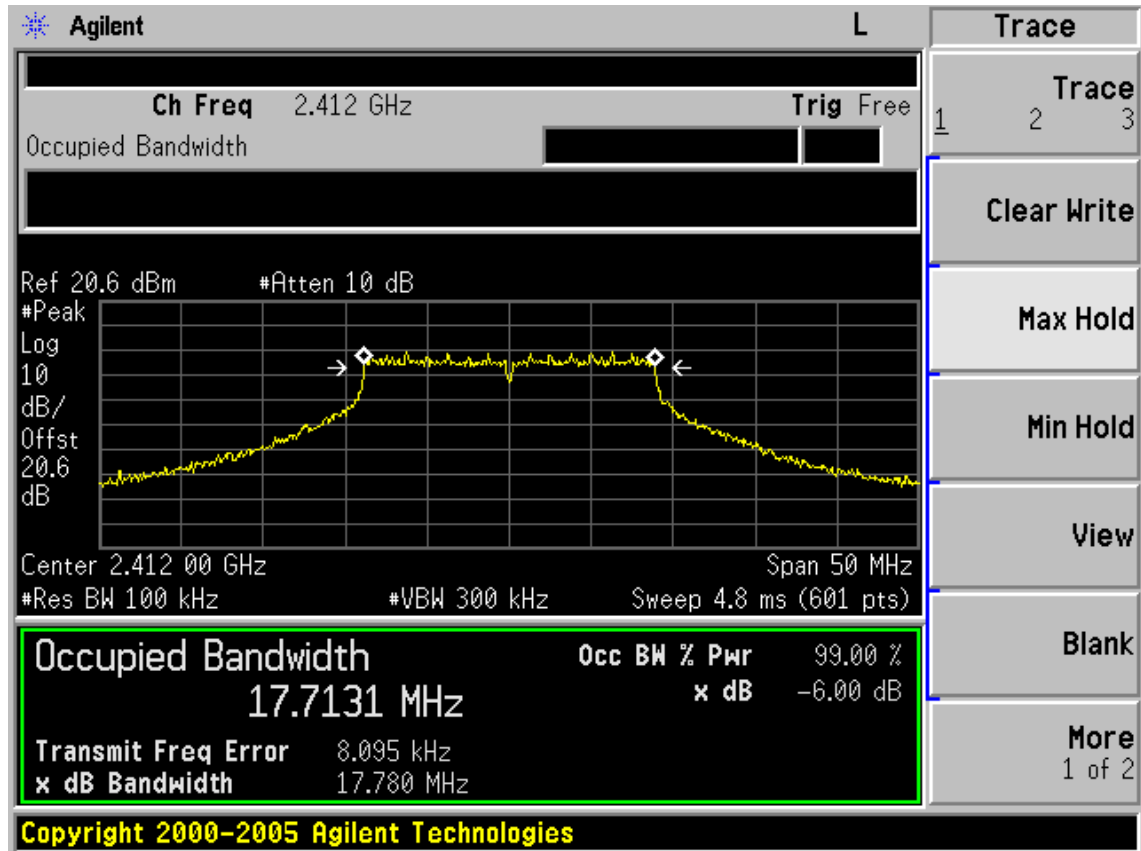

Test CH6: 2437MHz

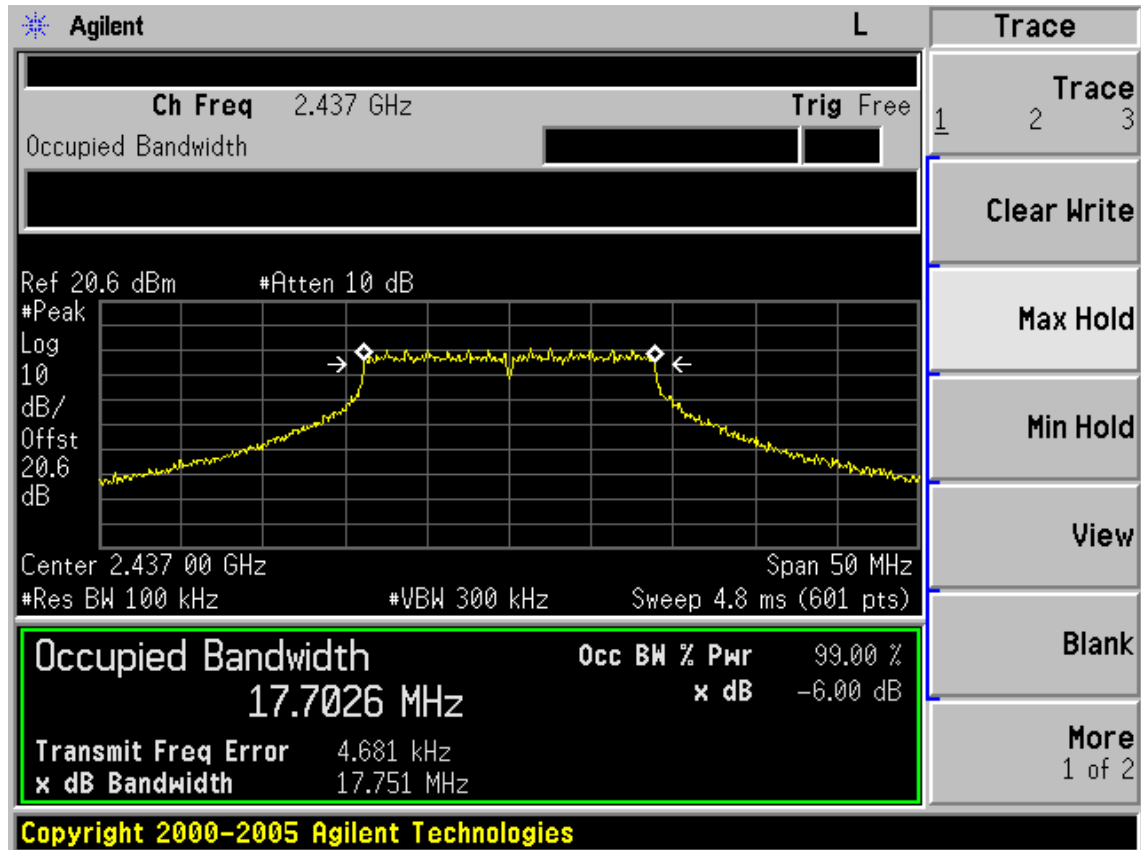

Test CH1: 2462MHz

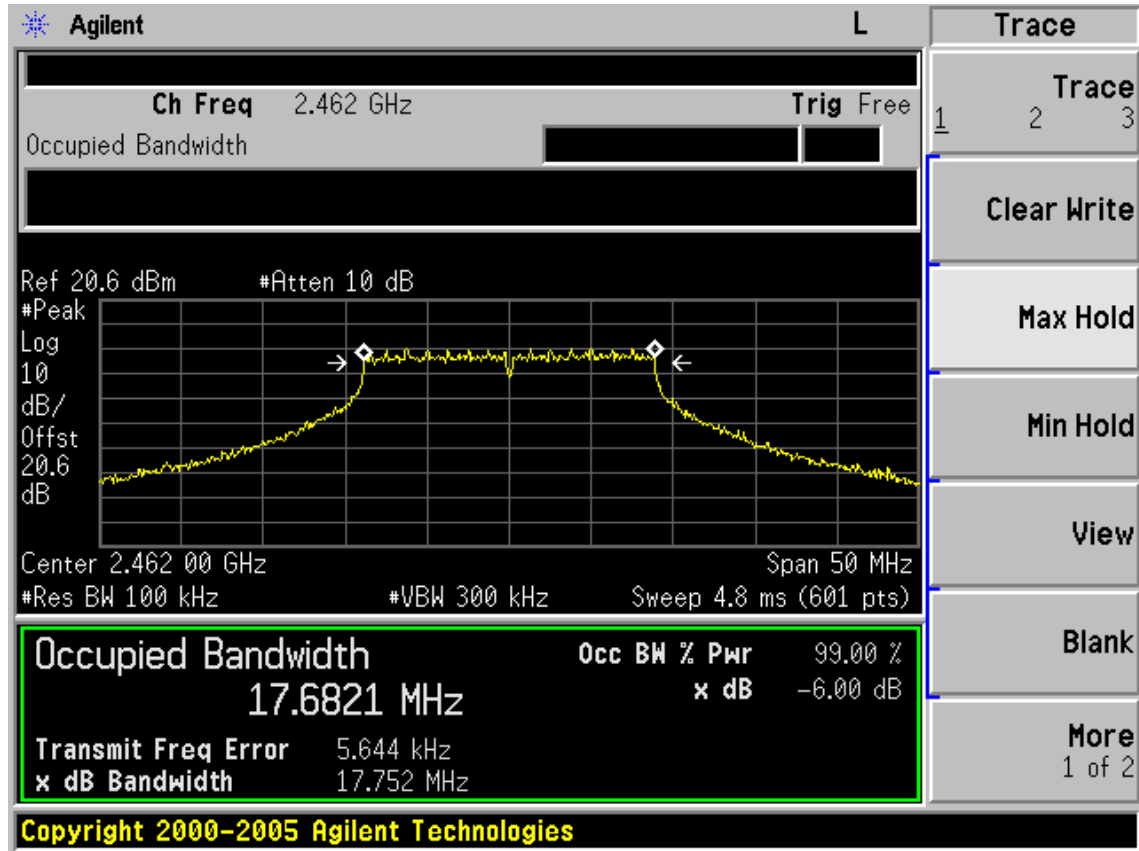

Test Mode: IEEE 802. 11n HT40TX

Test CH1: 2422MHz

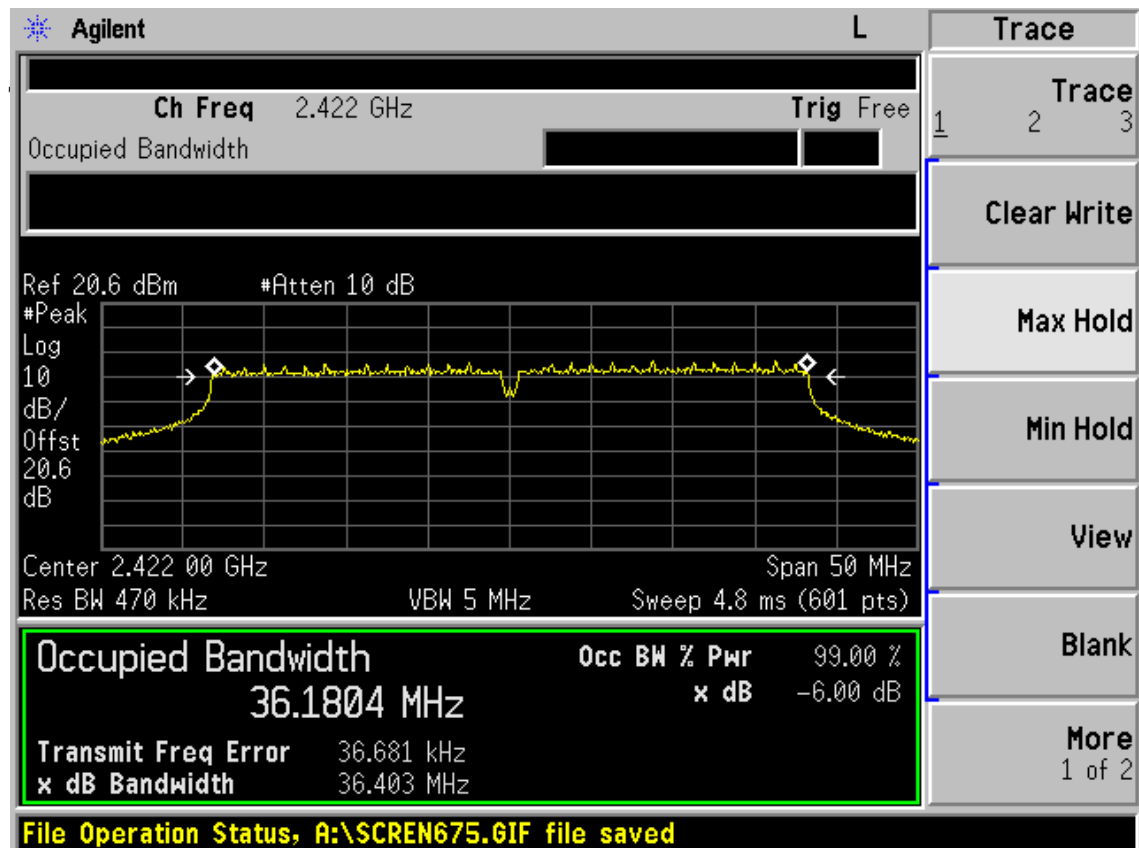

Test CH4: 2437MHz

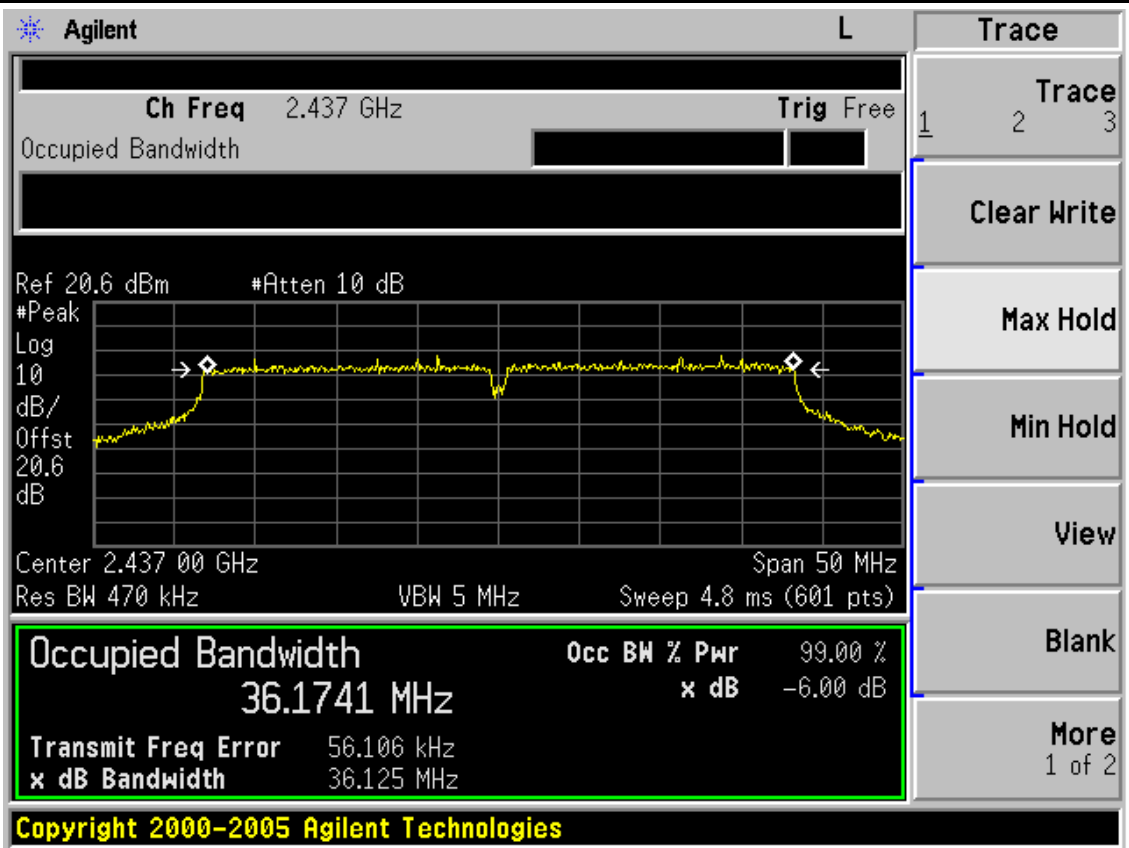

Test CH7: 2452MHz

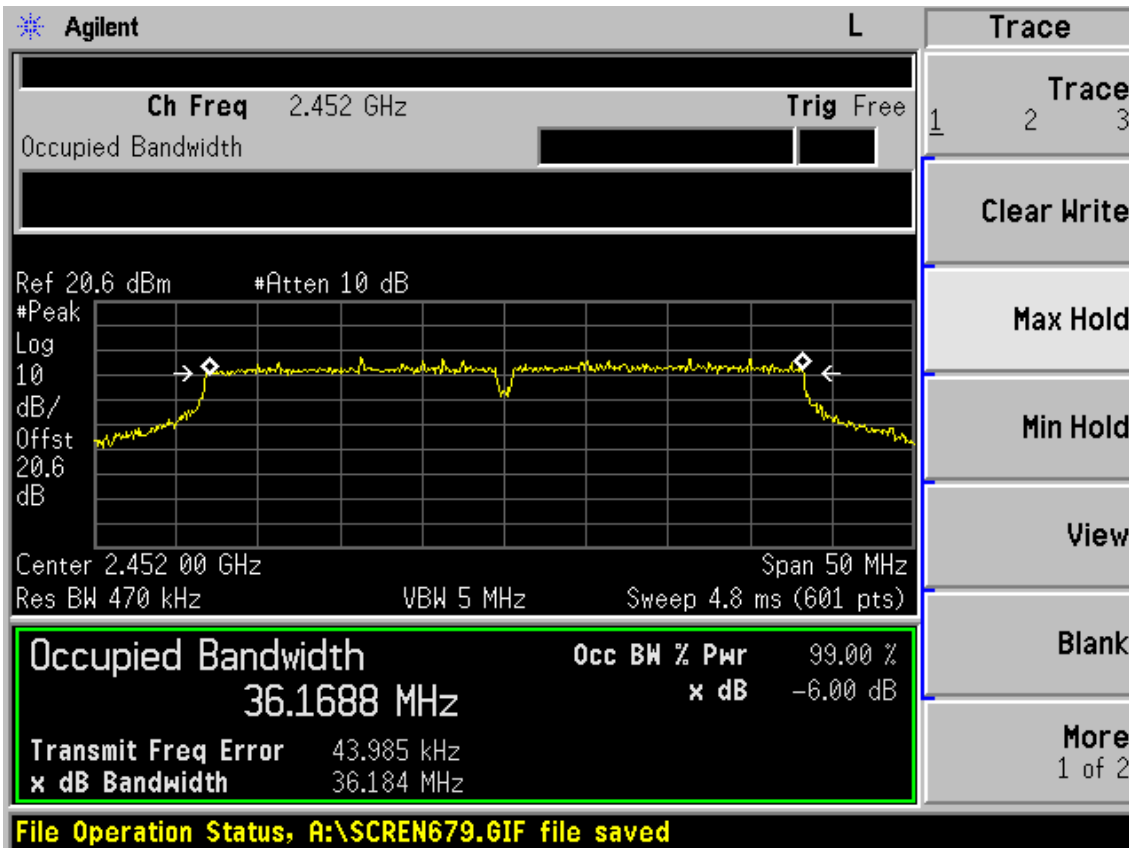

8. OUTPUT POWER TEST

8.1. Test Equipment

| Item | Equipment | Manufacturer | Model No. | Serial No. | Last Cal. | Cal. Interval |
|------|-------------------|--------------|-------------|------------|------------|---------------|
| 1. | Power meter | Anritsu | ML2487A | 6K00002472 | May.08,11 | 1 Year |
| 2. | Power sensor | Anritsu | MA2491A | 0033005 | May.08,11 | 1 Year |
| 3 | Attenuator | Agilent | 8491B | MY39262165 | May.08,11 | 1 Year |
| 4 | Spectrum Analyzer | Agilent | E4446A | US44300459 | May.08, 11 | 1 Year |
| 5 | RF Cable | Hubersuhner | SUCOFLEX102 | 28618/2 | May.08,11 | 1 Year |

8.2. Limit (FCC Part 15C 15.247 b(3))

For systems using digital modulation in the 2400—2483.5MHz, The Peak out put Power shall not exceed 1W(30dBm)

8.3. Test Procedure

- 1, Connected the EUT's antenna port to measure device by 20dB attenuator.
- 2, For IEEE 802.11b/g and IEEE802.11n HT20 mode, use a PK power meter which's bandwidth is 20MHz and above 6dB bandwidth of signal to measure out each test modes' PK output power.
- 3, For IEEE802.11n HT40 mode, because the signal's bandwidth is about 40MHz and above 20MHz bandwidth of power sensor ML2491A. So Bandwidth correction method according to ANSI C63.10 clause 6.10.2.1 part (c) was used:
 - 1) Set the RBW=3MHz and VBW =8MHz
 - 2) Turn averaging off
 - 3) Set sweep to automatic
 - 4) Set the span just large enough to capture the emission
 - 5) Use a peak detector on max hold
 - 6) Record the measured power
 - 7) Calculate Output power of EUT use the formula:

$$\text{Peak output power} = \text{measured power} + 10\log\left[\frac{(\text{6dB bandwidth of emission})}{(\text{analyzer RBW})}\right]$$

Note: The cable loss and attenuator loss were offset into measure device as an amplitude offset.

8.4. Test Results

| | | |
|------------------------------------------------|---------------------|--------------------|
| EUT: 150 Mbps 4-port Wireless Broadband Router | | |
| M/N: SMCWBR14S-N5 | | |
| Test date: 2011-07-07 | Pressure: 100.2 kpa | Humidity: 58% |
| Tested by: Sunny-lu | Test site: RF Site | Temperature : 24°C |

| Cable loss: 0.6 dB | | Attenuator loss: 20 dB | Antenna Gain: 5 dBi |
|--------------------|------|-------------------------|---------------------|
| Test Mode | CH | Peak output Power (dBm) | Limit (dBm) |
| 11b | CH1 | 19.27 | 30 |
| | CH6 | 22.65 | 30 |
| | CH11 | 20.60 | 30 |
| 11g | CH1 | 21.52 | 30 |
| | CH6 | 20.81 | 30 |
| | CH11 | 20.88 | 30 |
| 11n HT20 | CH1 | 20.34 | 30 |
| | CH6 | 21.97 | 30 |
| | CH11 | 17.72 | 30 |

| Mode | CH | Peak power (dBm/3MHz) | Peak output power (dBm) | Limit (dBm) |
|----------|-----|-----------------------|-------------------------|-------------|
| 11n HT40 | CH1 | 0.44 | 11.24 | 30 |
| | CH4 | 9.21 | 20.01 | 30 |
| | CH7 | 3.65 | 14.45 | 30 |

6dB Bandwidth for 11n HT40=36.18MHz

11n HT40 Mode , BW Correction Factor=10log(36.18 /3)=10.8

Conclusion : PASS

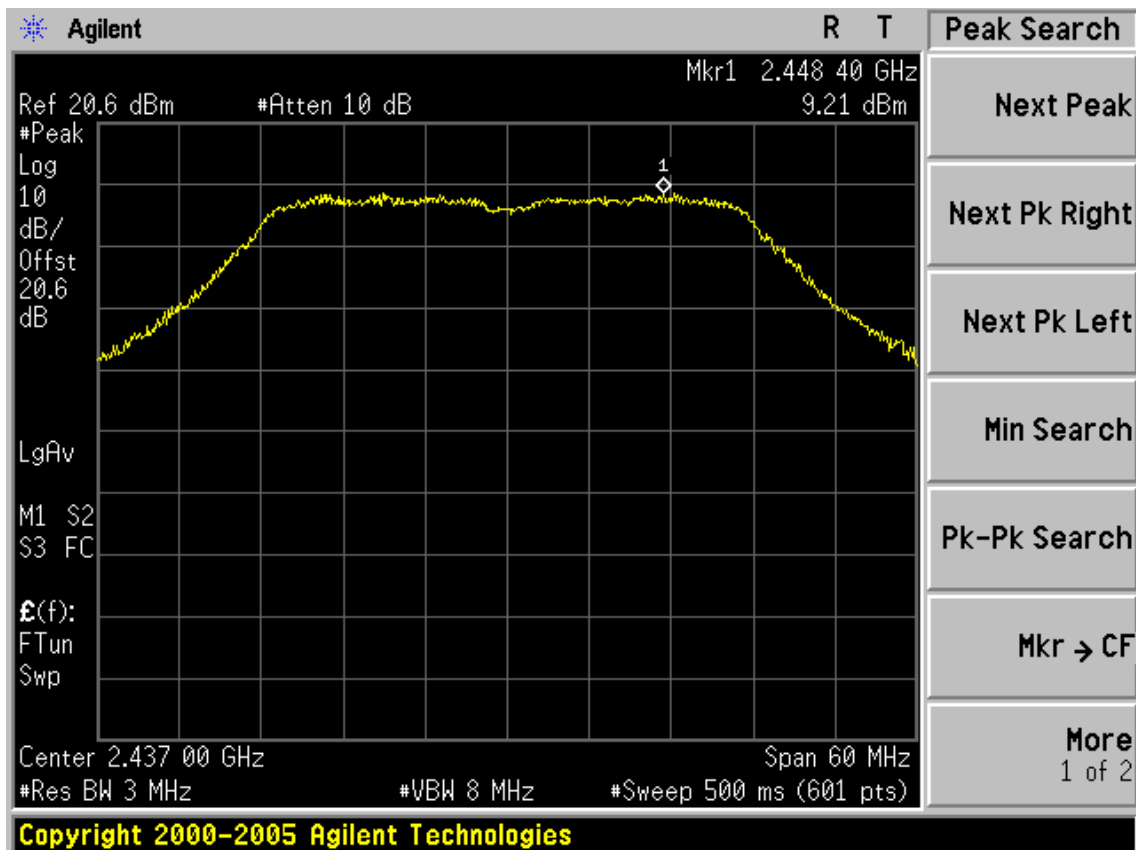
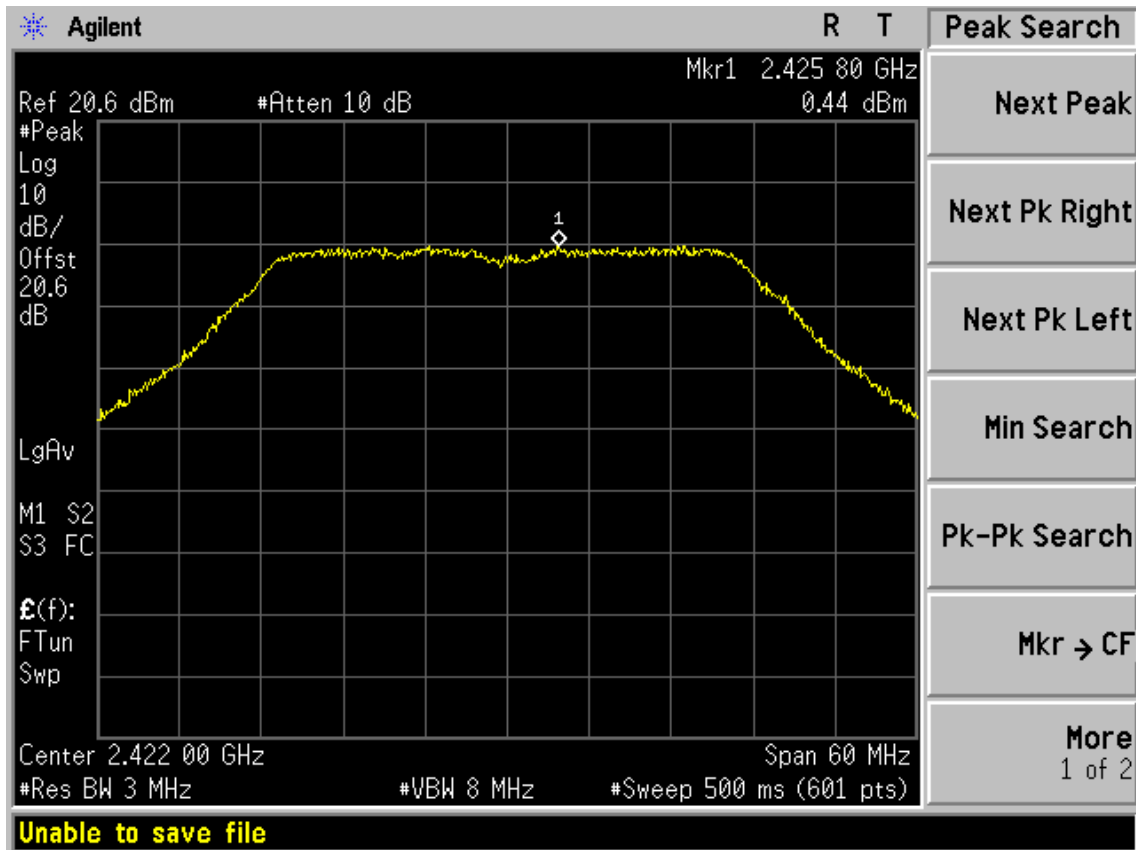

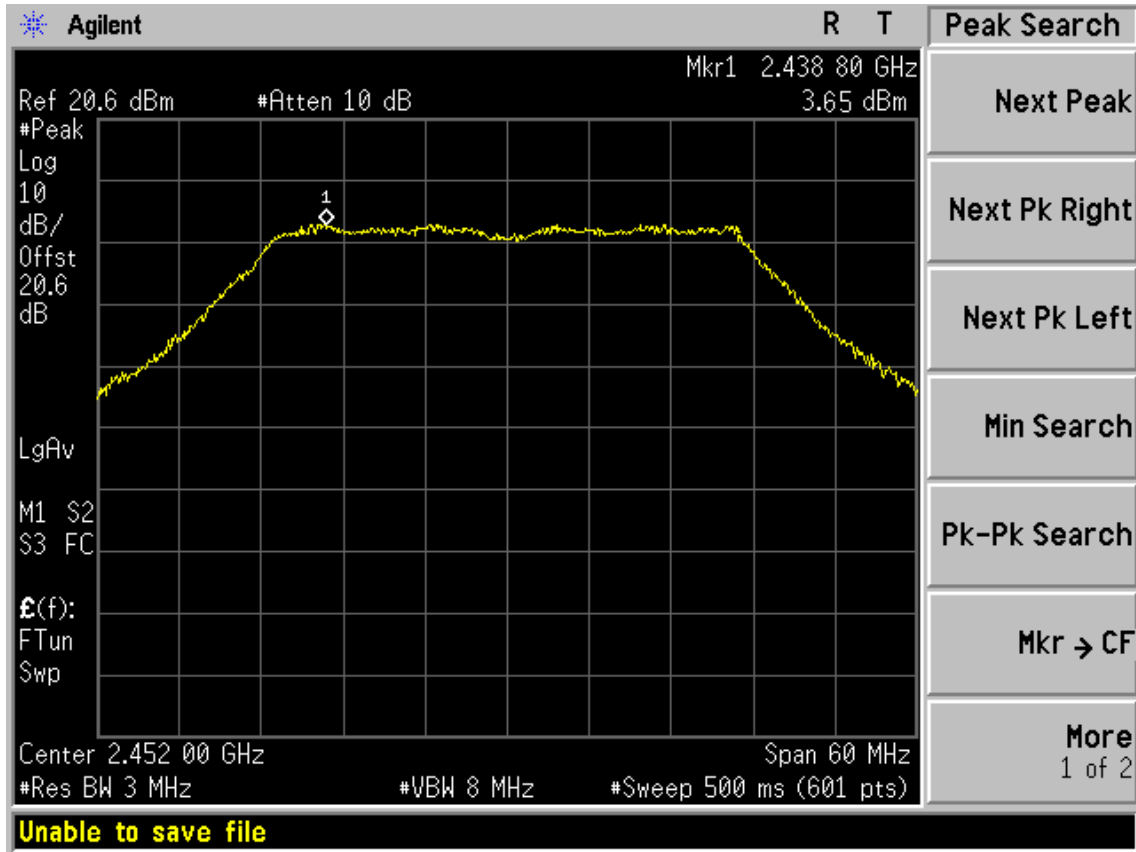

9. POWER SPECTRAL DENSITY TEST

9.1. Test Equipment

| Item | Equipment | Manufacturer | Model No. | Serial No. | Last Cal. | Cal. Interval |
|------|-------------------|--------------|-------------|------------|------------|---------------|
| 1. | Spectrum Analyzer | Agilent | E4446A | US44300459 | May.08, 11 | 1 Year |
| 2. | Attenuator | Agilent | 8491B | MY39262165 | May.08, 11 | 1 Year |
| 3. | RF Cable | Hubersuhner | SUCOFLEX102 | 28618/2 | May.08, 11 | 1 Year |

9.2. Limit

For digitally modulated systems, the power spectral density conducted from the intentional radiator to the antenna shall not be greater than 8dBm in any 3kHz band during any time interval of continuous transmission.

9.3. Test Procedure

- 1, Connected the EUT's antenna port to spectrum analyzer device by 20dB attenuator.
- 2, Follow the test procedure as described in ANSI C.10: 2009 Clause 6.11.2.3 to measure out each test modes and chain's power density with 3KHz.

9.4. Test Results

| | | |
|------------------------------------------------|---------------------|---------------------|
| EUT: 150 Mbps 4-port Wireless Broadband Router | | |
| M/N: SMCWBR14S-N5 | | |
| Test date: 2011-07-07 | Pressure: 100.6 kpa | Humidity: 60 % |
| Tested by: Sunny-lu | Test site: RF Site | Temperature : 25 °C |

| Cable loss: 0.6 dB | | Attenuator loss: 20 dB | Antenna Gain: 5dBi |
|--------------------|------|-----------------------------|---------------------|
| Test Mode | CH | Power density (dBm/3KHz) | Limit (dBm/3KHz) |
| 11b | CH1 | -8.89 | 8 |
| | CH6 | -9.86 | 8 |
| | CH11 | -9.66 | 8 |
| 11g | CH1 | -20.68 | 8 |
| | CH6 | -11.80 | 8 |
| | CH11 | -15.33 | 8 |
| 11n HT20 | CH1 | -13.95 | 8 |
| | CH6 | -12.78 | 8 |
| | CH11 | -16.17 | 8 |
| 11n HT40 | CH1 | -22.16 | 8 |
| | CH4 | -15.32 | 8 |
| | CH7 | -25.31 | 8 |
| Conclusion : PASS | | | |

Test Mode: IEEE 802.11b TX

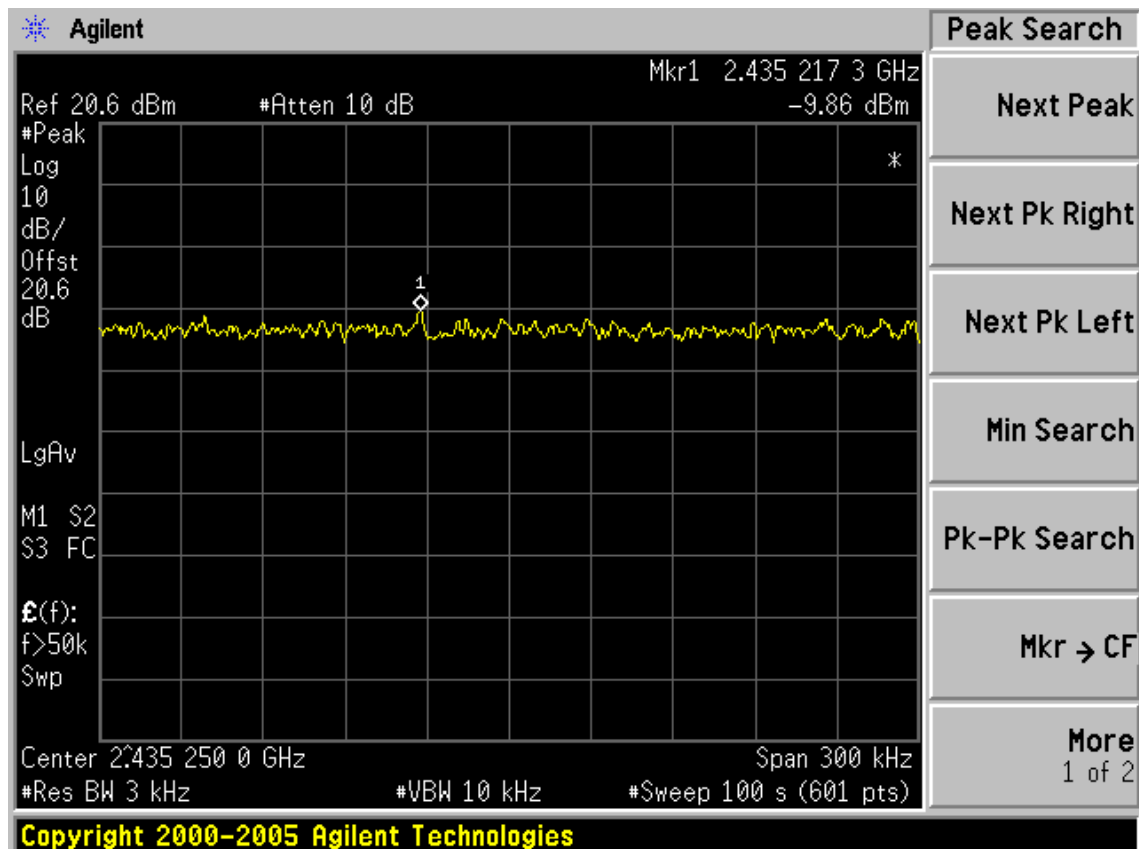
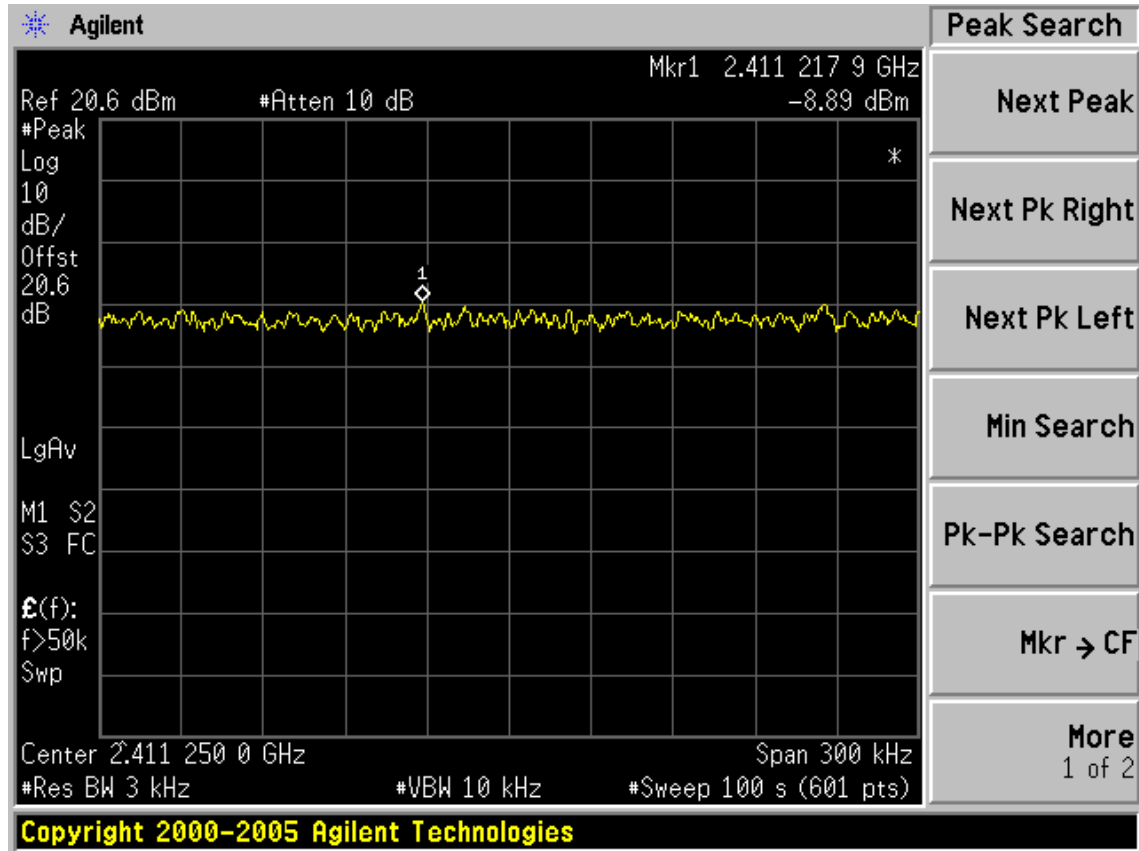

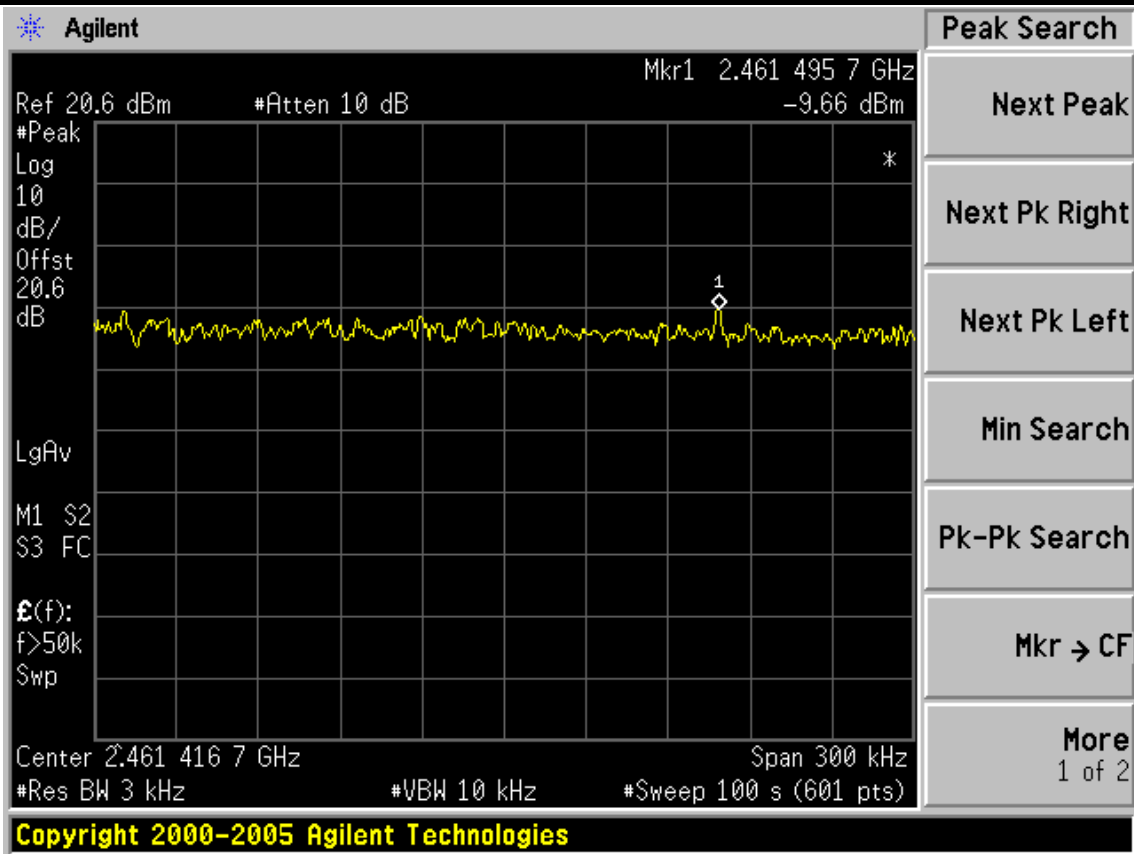

Test Mode: IEEE 802.11g TX

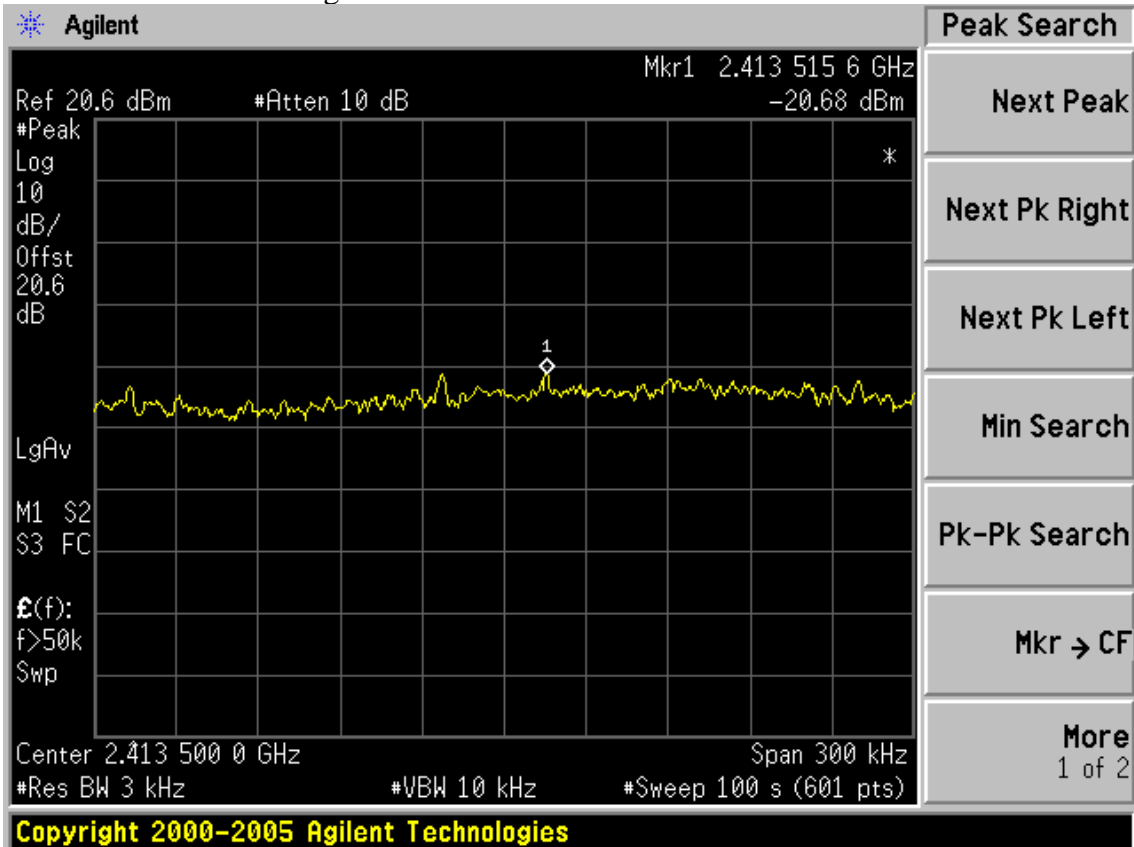

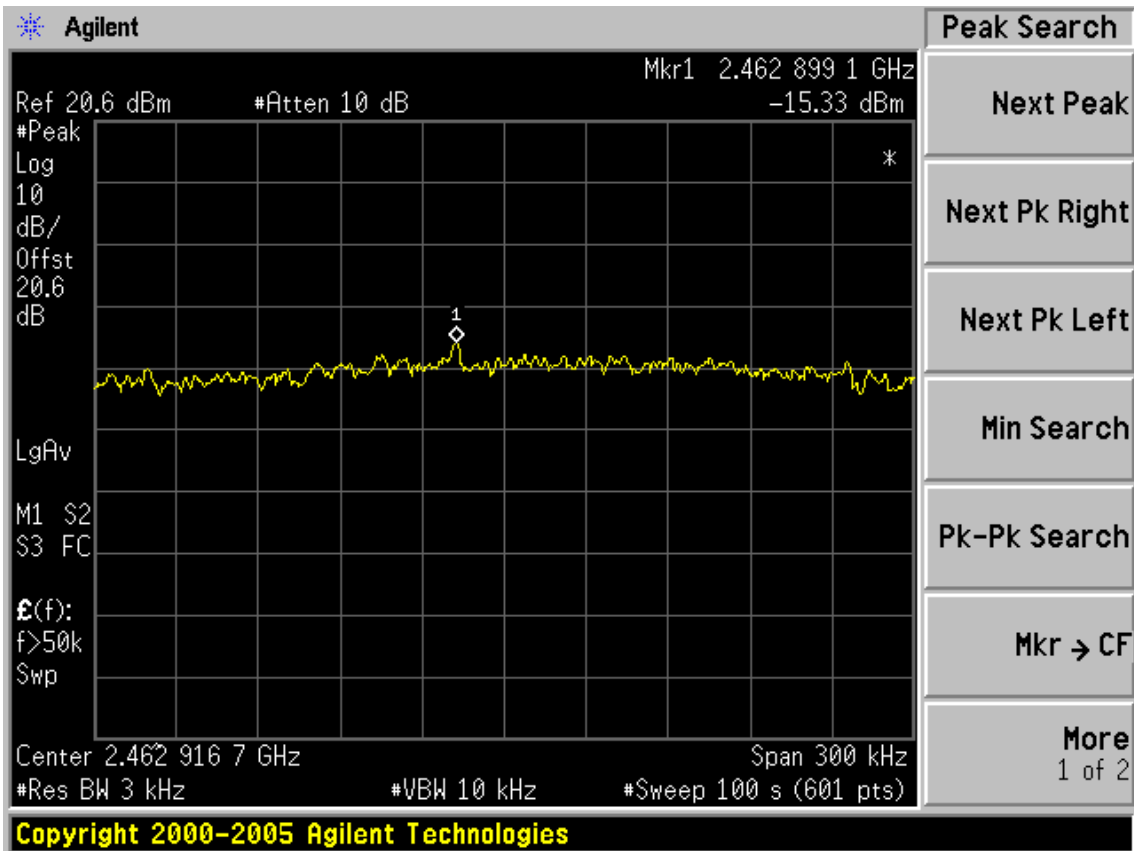
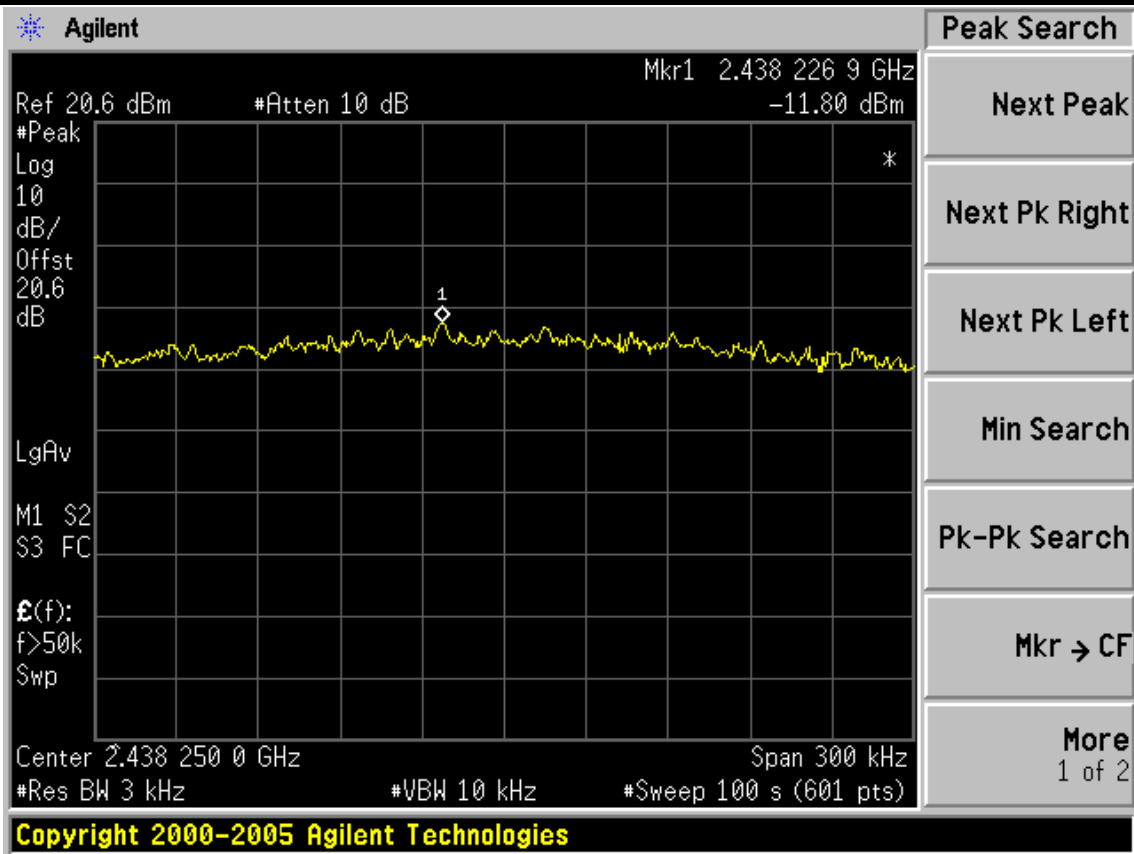

Test Mode: IEEE 802.11n HT20 TX

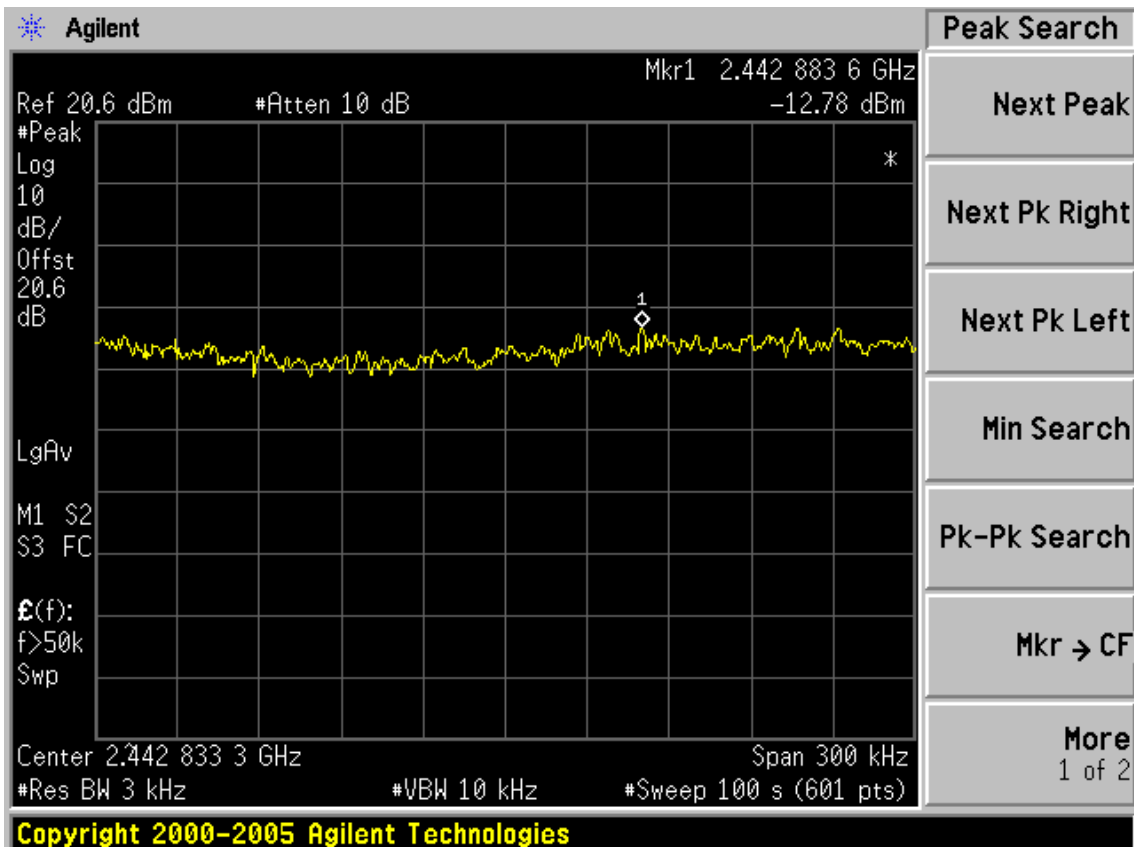
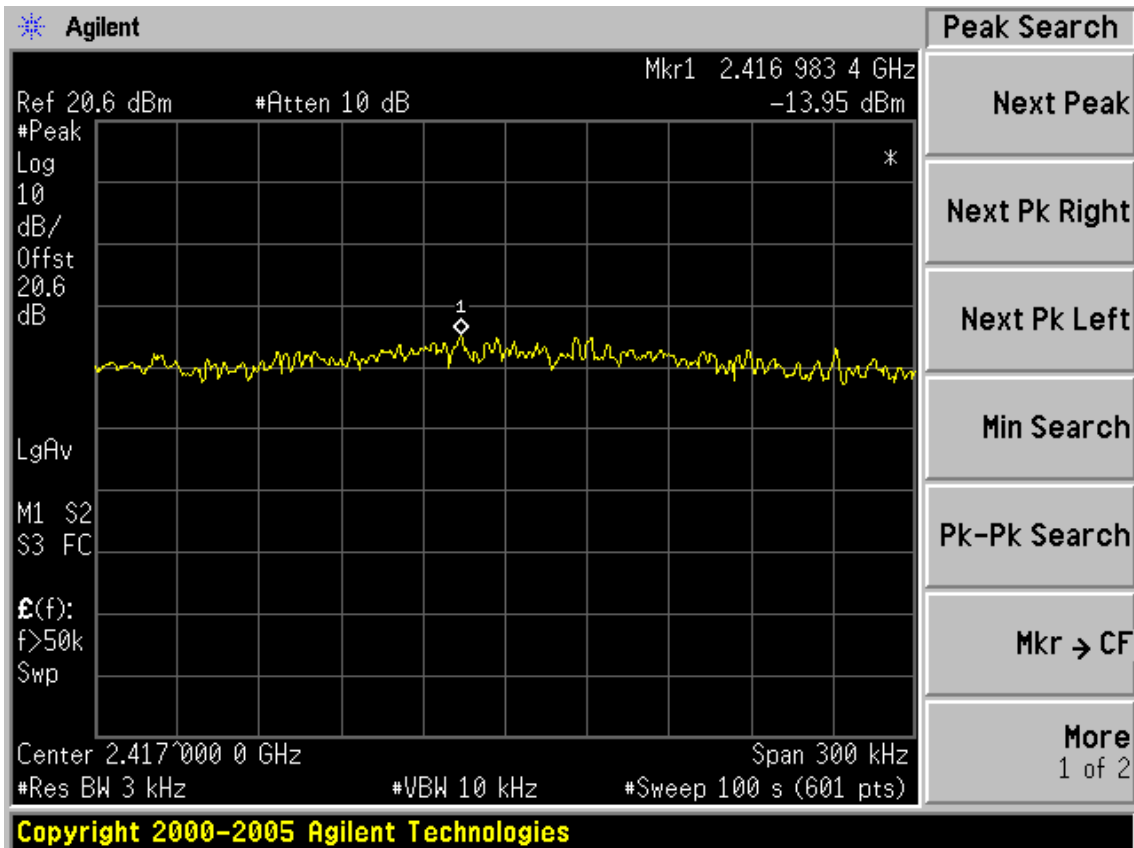

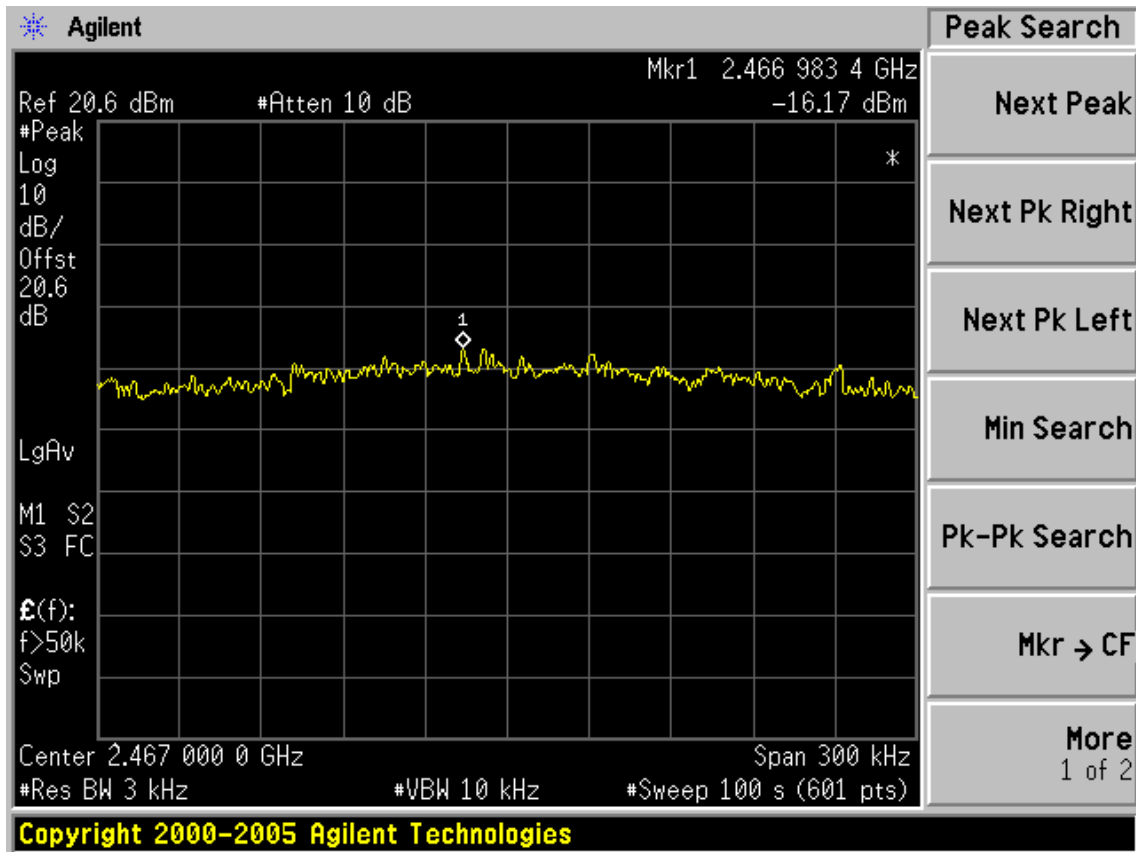

Test Mode: IEEE 802. 11n HT40 TX

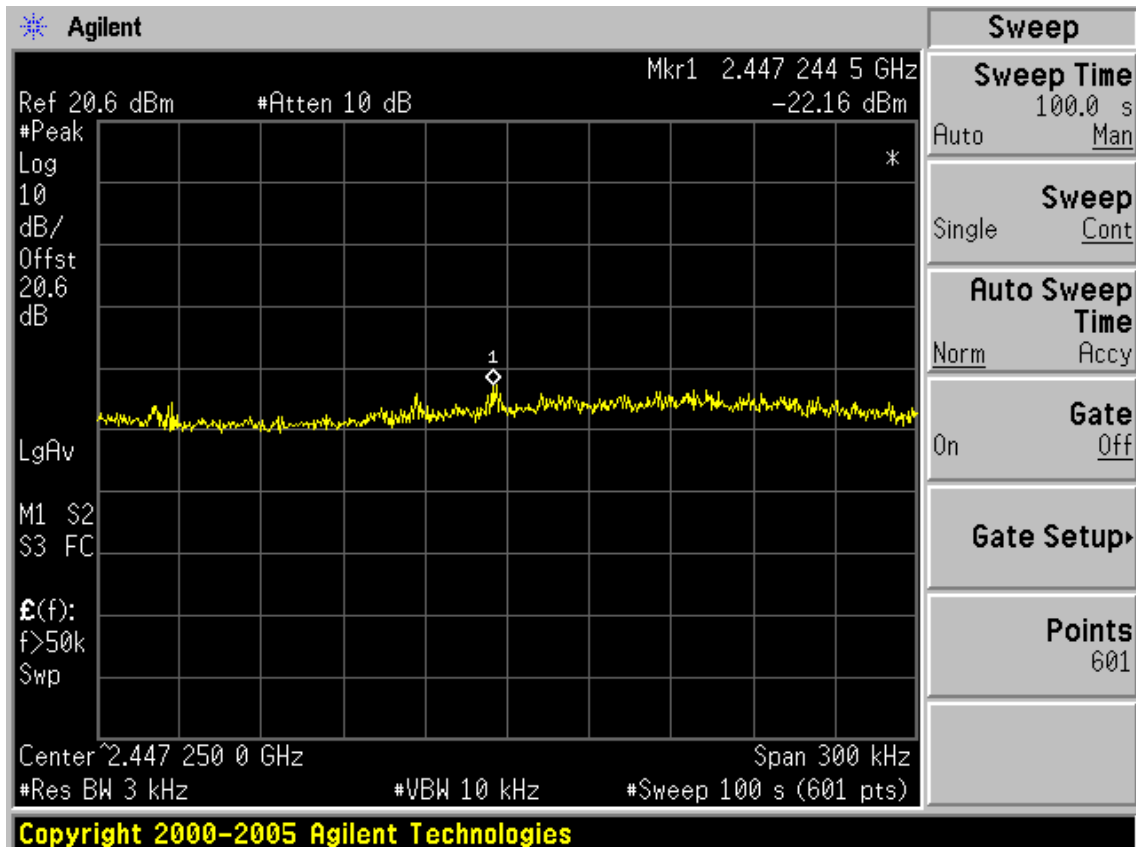

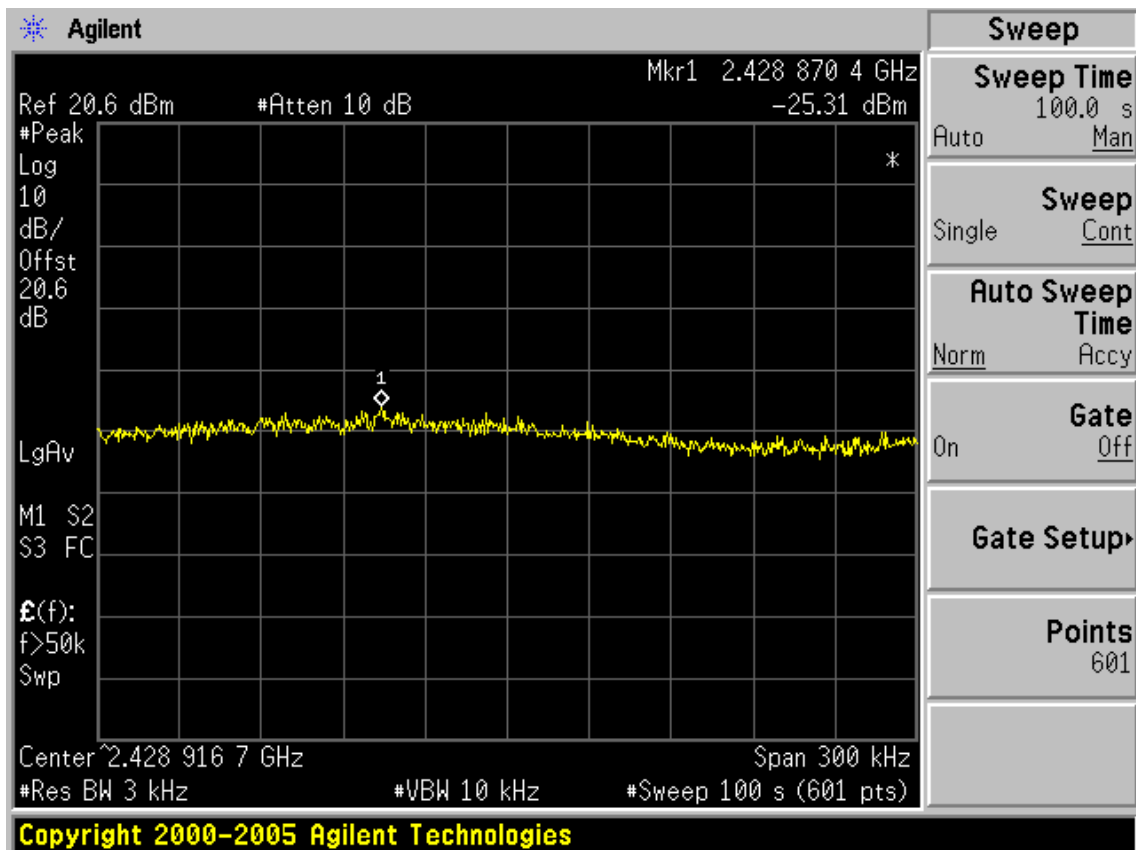
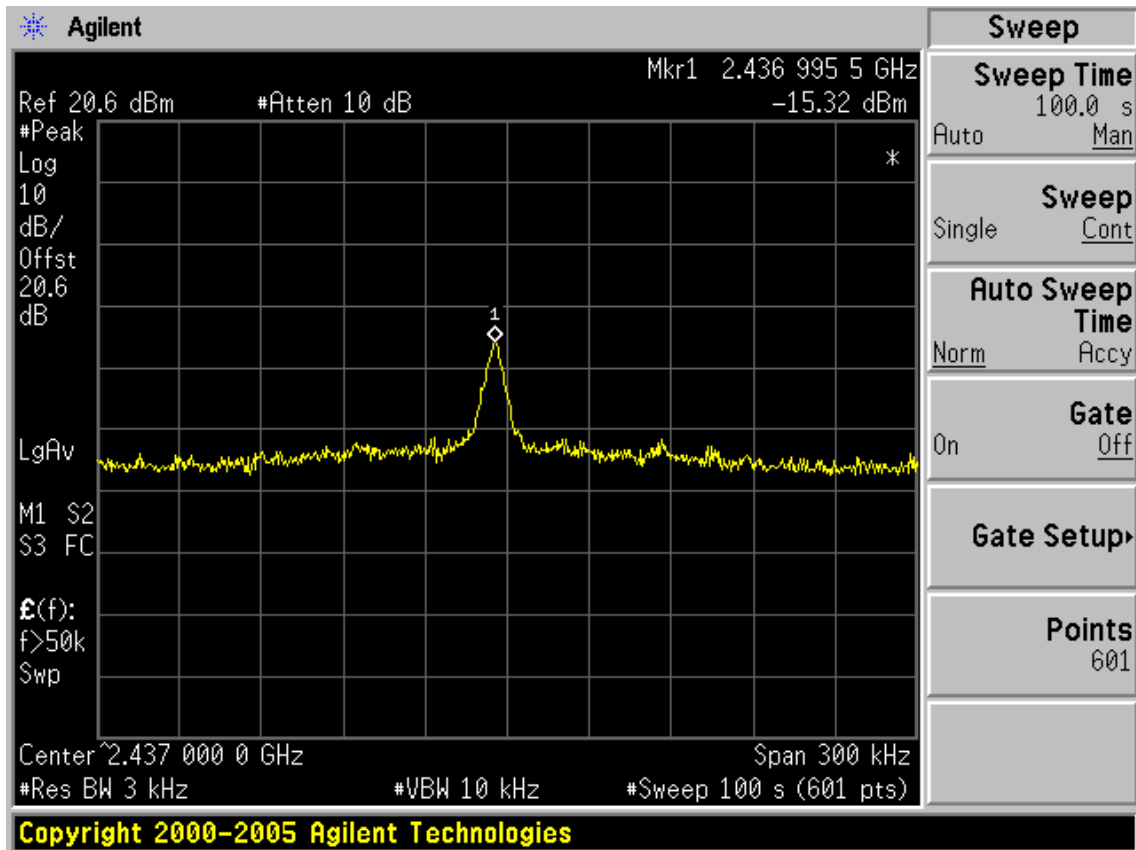

10. ANTENNA REQUIREMENT

10.1. STANDARD APPLICABLE

For intentional device, according to FCC 47 CFR Section 15.203, an intentional radiator shall be designed to ensure that no antenna other than that furnished by the responsible party shall be used with the device. And according to FCC 47 CFR Section 15.247 (b), if transmitting antennas of directional gain greater than 6dBi are used, the power shall be reduced by the amount in dB that the directional gain of the antenna exceeds 6dBi.

10.2. ANTENNA CONNECTED CONSTRUCTION

The antennas used for this product are one integrated PCB antenna and one dipole antenna with SMA-B connector that no antenna other than that furnished by the responsible party shall be used with the device, the maximum peak gain of the transmit antenna is 5dBi.

11.MPE ESTIMATION

11.1.Limit for General Population/ Uncontrolled Exposures

| Frequency | Power density (mW/ cm ²) | Averaging time(minutes) |
|------------------|--------------------------------------|-------------------------|
| 300MHz----1.5GHz | F/1500 | 30 |
| 1.5GHz---100GHz | 1.0 | 30 |

| Frequency(MHz) | Power density (mW/ cm ²) | Averaging time(minutes) |
|----------------|--------------------------------------|-------------------------|
| 2412 | 1 | 30 |
| 2437 | 1 | 30 |
| 2462 | 1 | 30 |

Note: F= Frequency in MHz

11.2.2, Estimation Result

| Mode | CH | Frequency (MHz) | PK Output power (dBm) | Output power (mW) | antenna Gain (dBi) | antenna Gain(linear) | MPE |
|----------|----|-----------------|-----------------------|-------------------|--------------------|----------------------|--------|
| 11b | 1 | 2412 | 19.27 | 84.53 | 5 | 3.16 | 0.0532 |
| | 6 | 2437 | 22.65 | 184.08 | 5 | 3.16 | 0.1159 |
| | 11 | 2462 | 20.60 | 114.82 | 5 | 3.16 | 0.0723 |
| 11g | 1 | 2412 | 21.52 | 141.91 | 5 | 3.16 | 0.0893 |
| | 6 | 2437 | 20.81 | 120.50 | 5 | 3.16 | 0.0758 |
| | 11 | 2462 | 20.88 | 122.46 | 5 | 3.16 | 0.0771 |
| 11n HT20 | 1 | 2412 | 20.34 | 108.14 | 5 | 3.16 | 0.0681 |
| | 6 | 2437 | 21.97 | 157.40 | 5 | 3.16 | 0.0991 |
| | 11 | 2462 | 17.72 | 59.16 | 5 | 3.16 | 0.0372 |
| 11n HT40 | 1 | 2422 | 11.24 | 13.30 | 5 | 3.16 | 0.0084 |
| | 4 | 2437 | 20.01 | 100.23 | 5 | 3.16 | 0.0631 |
| | 7 | 2452 | 14.45 | 27.86 | 5 | 3.16 | 0.0175 |

Note: The estimation distance is 20cm

12. DEVIATION TO TEST SPECIFICATIONS

[NONE]