



FCC RADIO TEST REPORT

FCC ID : YZKOAP100
Equipment : DUAL-BAND 11AC WAVE 2 OUTDOOR AP
Brand Name : Edgecore
Model Name : OAP100
Applicant : Edgecore Networks Corporation
No. 1, Creation Rd. III, Science Park Hsin Chu
30077, Taiwan
Manufacturer (1) : Accton Technology Corporation
No. 1, Creation Rd. III, Science Park Hsin Chu
30077, Taiwan
Manufacturer (2) : Accton Technology Corporation Zhunan Factory
1F.& 5F, No. 1, Keyi St., Zhunan Township, Miaoli
County 350 - TAIWAN
Standard : 47 CFR FCC Part 15.247

The product was received on Jul. 27, 2019, and testing was started from Aug. 15, 2019 and completed on Oct. 09, 2019. We, SPORTON INTERNATIONAL INC. EMC & Wireless Communications Laboratory, would like to declare that the tested sample has been evaluated in accordance with the procedures given in ANSI C63.10-2013 and shown compliance with the applicable technical standards.

The report must not be used by the client to claim product certification, approval, or endorsement by TAF or any agency of government.

The test results in this report apply exclusively to the tested model / sample. Without written approval of SPORTON INTERNATIONAL INC. EMC & Wireless Communications Laboratory, the test report shall not be reproduced except in full.

Approved by: Cliff Chang

SPORTON INTERNATIONAL INC. EMC & Wireless Communications Laboratory

No. 52, Huaya 1st Rd., Guishan Dist., Taoyuan City, Taiwan (R.O.C.)



Table of Contents

History of this test report.....3

Summary of Test Result.....4

1 General Description5

1.1 Information.....5

1.2 Applicable Standards8

1.3 Testing Location Information.....8

1.4 Measurement Uncertainty8

2 Test Configuration of EUT.....9

2.1 Test Channel Mode9

2.2 The Worst Case Measurement Configuration.....10

2.3 EUT Operation during Test11

2.4 Accessories12

2.5 Support Equipment.....12

2.6 Test Setup Diagram13

3 Transmitter Test Result16

3.1 AC Power-line Conducted Emissions16

3.2 DTS Bandwidth18

3.3 Maximum Conducted Output Power19

3.4 Power Spectral Density22

3.5 Emissions in Non-restricted Frequency Bands24

3.6 Emissions in Restricted Frequency Bands.....25

4 Test Equipment and Calibration Data29

Appendix A. Test Results of AC Power-line Conducted Emissions

Appendix B. Test Results of DTS Bandwidth

Appendix C. Test Results of Maximum Conducted Output Power

Appendix D. Test Results of Power Spectral Density

Appendix E. Test Results of Emissions in Non-restricted Frequency Bands

Appendix F. Test Results of Emissions in Restricted Frequency Bands

Appendix G. Test Photos

Photographs of EUT v01



Summary of Test Result

Report Clause	Ref Std. Clause	Test Items	Result (PASS/FAIL)	Remark
1.1.2	15.203	Antenna Requirement	PASS	-
3.1	15.207	AC Power-line Conducted Emissions	PASS	-
3.2	15.247(a)	DTS Bandwidth	PASS	-
3.3	15.247(b)	Maximum Conducted Output Power	PASS	-
3.4	15.247(e)	Power Spectral Density	PASS	-
3.5	15.247(d)	Emissions in Non-restricted Frequency Bands	PASS	-
3.6	15.247(d)	Emissions in Restricted Frequency Bands	PASS	-

Declaration of Conformity:

The test results with all measurement uncertainty excluded are presented in accordance with the regulation limits or requirements declared by manufacturers.

Comments and Explanations:

The declared of product specification for EUT presented in the report are provided by the manufacturer, and the manufacturer takes all the responsibilities for the accuracy of product specification.

Reviewed by: **Sam Chen**
Report Producer: **Sandy Chuang**



1 General Description

1.1 Information

1.1.1 RF General Information

Frequency Range (MHz)	Bluetooth Mode	Ch. Frequency (MHz)	Channel Number
2400-2483.5	LE	2402-2480	0-39 [40]

Band	Mode	BWch (MHz)	Nant
2.4-2.4835GHz	BT-LE(1Mbps)	1.0	1TX

Note:

- ♦ Bluetooth LE uses a GFSK modulation.
- ♦ BWch is the nominal channel bandwidth.
- ♦ Nss-Min is the minimum number of spatial streams.
- ♦ Nant is the number of outputs. e.g., 2(2, 3) means have 2 outputs for port 2 and port 3. 2 means have 2 outputs for port 1 and port 2.



1.1.2 Antenna Information

Ant.	Port	Brand	Model Name	Antenna Type	Connector	Gain (dBi)
1	1/2	ACCTON	OAP 100 -1018-EC	Patch Array Antenna	I-PEX	Note 1
2	1/2	ACCTON	OAP 100 -1018-EC	Patch Array Antenna	I-PEX	
3	1/2	ACCTON	OAP 100 -1018-EC	PCB Dipole Antenna	I-PEX	
4	1/2	ACCTON	OAP 100 -1018-EC	Patch Array Antenna	I-PEX	
5	1	ACCTON	OAP100-1018-EC	PCB Dipole Antenna	I-PEX	
6	1	Master Wave	OAP100-1018-EC	Chip Antenna	I-PEX	
7	1	Master Wave	8615 Outdoor Antenna	External omni antenna	I-PEX	

Note 1

Ant.	Port	Gain (dBi)				
		2.4GHz	5GHz	Bluetooth	GPS	LTE
1	1	-	15.5	-	-	-
2	2	-	11.1	-	-	-
3	1	5.6	-	-	-	-
4	2	10.4	-	-	-	-
5	1	-	-	4.5	-	-
6	1	-	-	-	3.76	-
7	1	-	-	-	-	2.87

Note 2: The above information was declared by manufacturer.

<For 2.4GHz Band>

For IEEE 802.11b/g/n mode (2TX/2RX)

Port 1 and Port 2 can be used as transmitting/receiving antenna.

Port 1 and Port 2 could transmit/receive simultaneously.

<For 5GHz Band>

Because Ant. 1 and Ant. 2 are the same type antennas, only the higher gain antenna "Ant. 1" was tested and recorded in the report.

For IEEE 802.11a/n/ac mode (2TX/2RX)

Port 1 and Port 2 can be used as transmitting/receiving antenna.

Port 1 and Port 2 could transmit/receive simultaneously.

<Bluetooth>

Only Port 1 can be used as transmitting/receiving antenna.



1.1.3 Mode Test Duty Cycle

Mode	DC	DCF(dB)	T(s)	VBW(Hz) ≥ 1/T
BT-LE(1Mbps)	0.628	2.02	405u	3k

Note:

- ♦ DC is Duty Cycle.
- ♦ DCF is Duty Cycle Factor.

1.1.4 EUT Operational Condition

EUT Power Type	From PoE or DC 24V		
Function	<input checked="" type="checkbox"/> Point-to-multipoint	<input type="checkbox"/>	Point-to-point
Test Software Version	QRCT V3.0.264.0		
Support Mode	<input checked="" type="checkbox"/>	LE 1M PHY: 1 Mb/s	
	<input type="checkbox"/>	LE Coded PHY (S=2): 500 Kb/s	
	<input type="checkbox"/>	LE Coded PHY (S=8): 125 Kb/s	
	<input type="checkbox"/>	LE 2M PHY: 2 Mb/s	

Note: The above information was declared by manufacturer.



1.2 Applicable Standards

According to the specifications of the manufacturer, the EUT must comply with the requirements of the following standards:

- ♦ 47 CFR FCC Part 15
- ♦ ANSI C63.10-2013
- ♦ FCC KDB 558074 D01 v05r02
- ♦ FCC KDB 414788 D01 v01r01

1.3 Testing Location Information

Testing Location		
<input type="checkbox"/>	HWA YA	ADD : No. 52, Huaya 1st Rd., Guishan Dist., Taoyuan City, Taiwan (R.O.C.) TEL : 886-3-327-3456 FAX : 886-3-327-0973
<input checked="" type="checkbox"/>	JHUBEI	ADD : No.8, Lane 724, Bo-ai St., Jhubei City, HsinChu County 302, Taiwan, R.O.C. TEL : 886-3-656-9065 FAX : 886-3-656-9085

Test Condition	Test Site No.	Test Engineer	Test Environment	Test Date
RF Conducted	TH02-CB	Owen Hsu	24.5-25.5°C / 56-58 %	Aug. 15, 2019~ Sep. 05, 2019
Radiated (Below 1GHz)	03CH05-CB	Eason Chen	24.9-25.9°C / 59-63 %	Aug. 23, 2019~ Oct. 07, 2019
Radiated (Above 1GHz)	03CH03-CB	Eason Chen	23.8-26.2°C / 59-62 %	Aug. 23, 2019~ Oct. 07, 2019
AC Conduction	CO01-CB	Rick Yeh	25-26°C / 47-48 %	Oct. 09, 2019

Test site Designation No. TW0006 with FCC.
Test site registered number IC 4086D with Industry Canada.

1.4 Measurement Uncertainty

ISO/IEC 17025 requires that an estimate of the measurement uncertainties associated with the emissions test results be included in the report. The measurement uncertainties given below are based on a 95% confidence level (based on a coverage factor (k=2))

Test Items	Uncertainty	Remark
Conducted Emission (150kHz ~ 30MHz)	2.0 dB	Confidence levels of 95%
Radiated Emission (30MHz ~ 1,000MHz)	4.3 dB	Confidence levels of 95%
Radiated Emission (1GHz ~ 18GHz)	4.3 dB	Confidence levels of 95%
Radiated Emission (18GHz ~ 40GHz)	5.1 dB	Confidence levels of 95%
Conducted Emission	2.4 dB	Confidence levels of 95%
Output Power Measurement	1.5 dB	Confidence levels of 95%
Power Density Measurement	2.4 dB	Confidence levels of 95%
Bandwidth Measurement	2%	Confidence levels of 95%



2 Test Configuration of EUT

2.1 Test Channel Mode

Mode	PowerSetting
BT-LE(1Mbps)	-
2402MHz	8
2440MHz	8
2480MHz	8



2.2 The Worst Case Measurement Configuration

The Worst Case Mode for Following Conformance Tests	
Tests Item	AC power-line conducted emissions
Condition	AC power-line conducted measurement for line and neutral
Operating Mode	CTX
1	LTE Band 1+Ant. 3_2.4GHz+PoE 1
2	LTE Band 1+Ant. 3_DC 24V
Mode 1 has been evaluated to be the worst case among Mode 1~2, thus measurement for Mode 3 ~ 5 will follow this same test mode.	
3	LTE Band 1+Ant. 4_2.4GHz+PoE 1
4	LTE Band 1+Ant. 1_5GHz+PoE 1
5	LTE Band 1+Ant. 5_Bluetooth LE+PoE 1
For operating mode 1 is the worst case and it was record in this test report.	

The Worst Case Mode for Following Conformance Tests	
Tests Item	DTS Bandwidth Maximum Conducted Output Power Power Spectral Density Emissions in Non-restricted Frequency Bands
Test Condition	Conducted measurement at transmit chains



The Worst Case Mode for Following Conformance Tests	
Tests Item	Emissions in Restricted Frequency Bands
Test Condition	Radiated measurement If EUT consist of multiple antenna assembly (multiple antenna are used in EUT regardless of spatial multiplexing MIMO configuration), the radiated test should be performed with highest antenna gain of each antenna type.
Operating Mode < 1GHz	CTX
The EUT can be placed in Y-axis and Z-axis. EUT Y axis has been evaluated to be the worst case at Emissions in Restricted Frequency Bands <Above 1GHz>; thus, the measurement will follow this same test configuration.	
1	LTE Band 1+Ant. 3_2.4GHz+PoE 2 - EUT in Y axis
2	LTE Band 1+Ant. 3_DC 24V - EUT in Y axis
Mode 1 has been evaluated to be the worst case among Mode 1~2, thus measurement for Mode 3 ~ 5 will follow this same test mode.	
3	LTE Band 1+Ant. 4_2.4GHz+PoE 2 - EUT in Y axis
4	LTE Band 1+Ant. 1_5GHz+PoE 2 - EUT in Y axis
5	LTE Band 1+Ant. 5_Bluetooth LE+PoE 2 - EUT in Y axis
For operating mode 5 is the worst case and it was record in this test report.	
Operating Mode > 1GHz	CTX
The EUT can be placed in Y-axis and Z-axis. After evaluating, Y-axis was the worst case, so the test will follow this same test configuration.	
1	EUT in Y axis

The Worst Case Mode for Following Conformance Tests	
Tests Item	Simultaneous Transmission Analysis - Co-location RF Exposure Evaluation
Operating Mode	
1	WLAN 2.4GHz + WLAN 5GHz
Refer to Sporton Test Report No.: FA921805 for Co-location RF Exposure Evaluation.	

Note: The PoE below are for measurement only, would not be marketed.

The PoE information as below:

Support Unit	Brand	Model Number
PoE 1	PowerDsine	PD-3501G/AC
PoE 2	GME	GME40B-480135FDA

2.3 EUT Operation during Test

The EUT was programmed to be in continuously transmitting mode.



2.4 Accessories

Wall-mounted rack*1

2.5 Support Equipment

For AC Conduction:

Support Equipment				
No.	Equipment	Brand Name	Model Name	FCC ID
A	PoE 1	PowerDsine	PD-3501G/AC	N/A
B	LTE module	QUECTEL	EC25-J	N/A
C	LAN NB	DELL	E6430	N/A

For Radiated:

Support Equipment				
No.	Equipment	Brand Name	Model Name	FCC ID
A	PoE 2	GME	GME40B-480135FDA	N/A
B	NB	DELL	E4300	N/A

For RF Conducted:

Support Equipment				
No.	Equipment	Brand Name	Model Name	FCC ID
A	NB	DELL	E4300	N/A
B	PoE 2	GME	GME40B-480135FDA	N/A

2.6 Test Setup Diagram

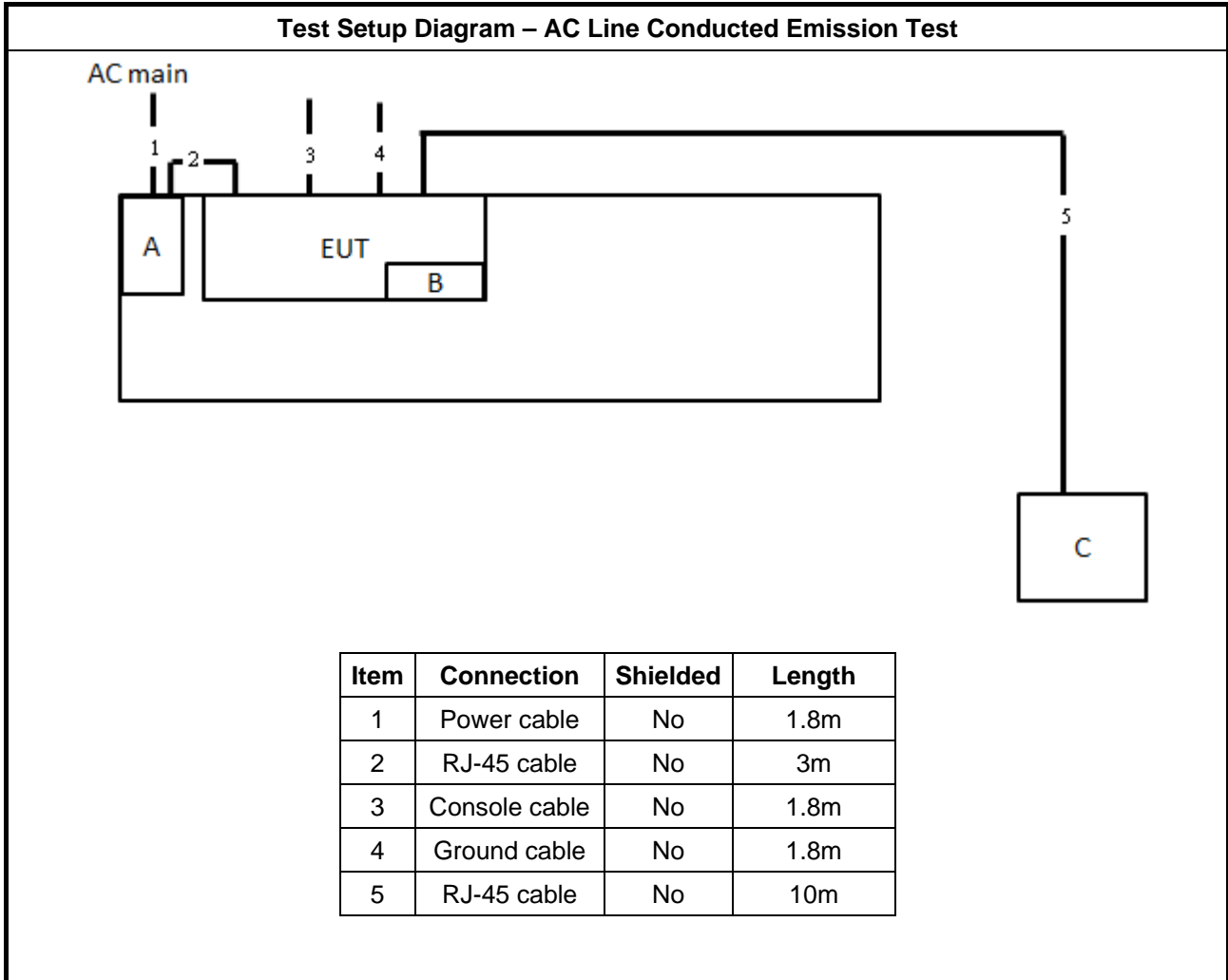



Test Setup Diagram - Radiated Test < 1GHz

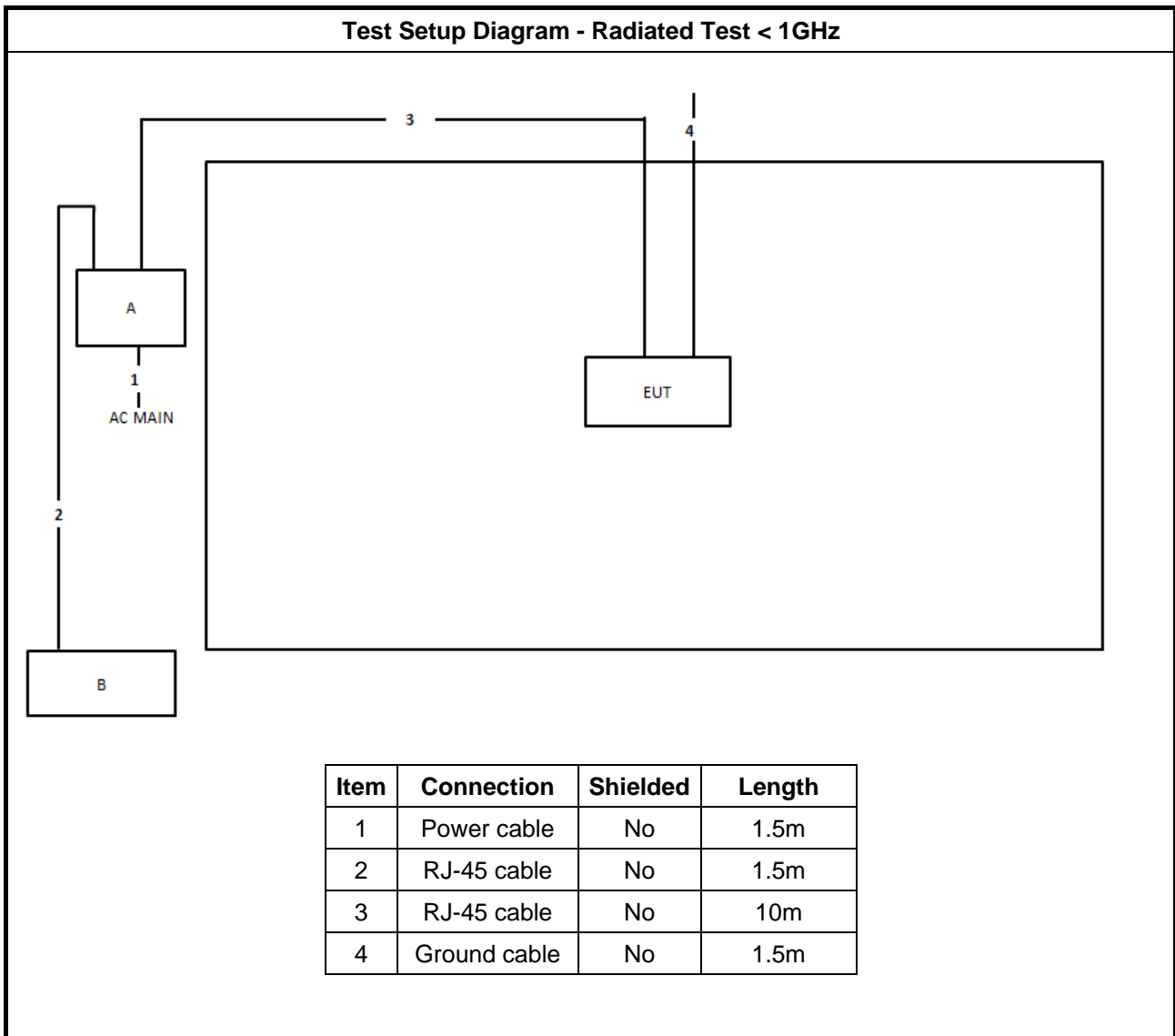

Item	Connection	Shielded	Length
1	Power cable	No	1.5m
2	RJ-45 cable	No	1.5m
3	RJ-45 cable	No	10m
4	Ground cable	No	1.5m

Test Setup Diagram - Radiated Test > 1GHz

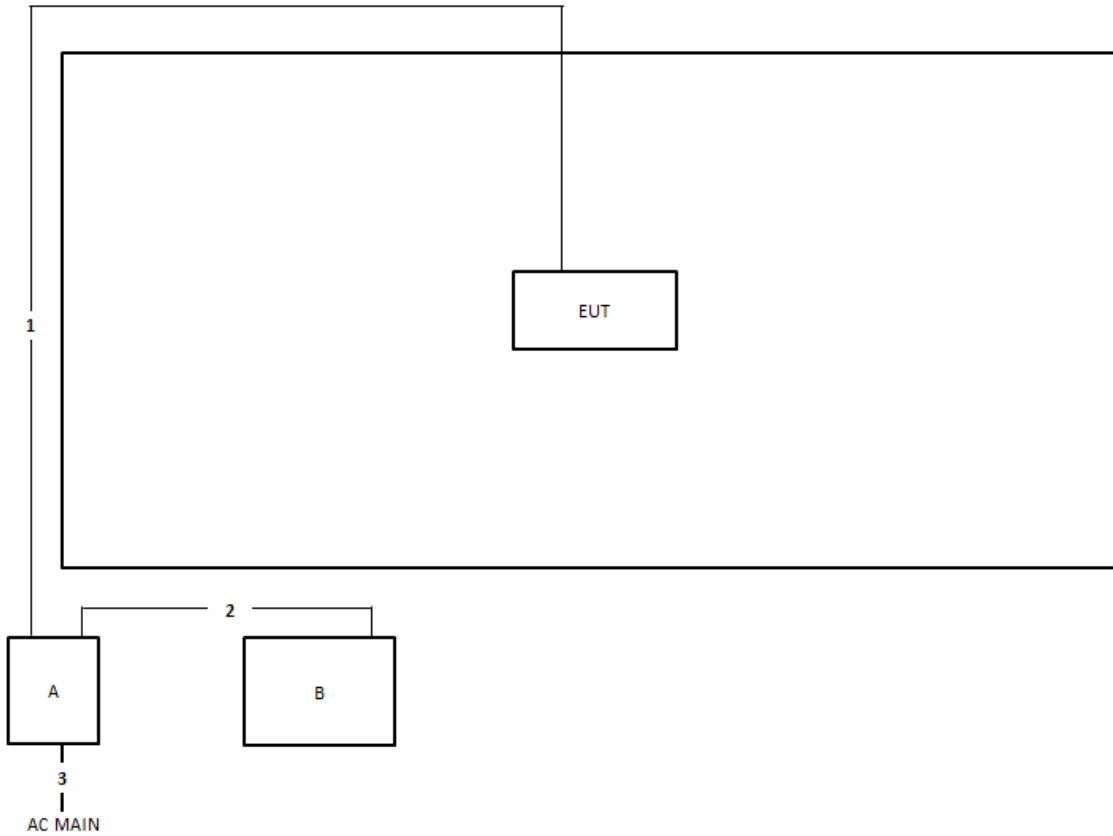

Item	Connection	Shielded	Length
1	RJ-45 cable	No	10m
2	RJ-45 cable	No	1.5m
3	Power cable	No	1.5m



3 Transmitter Test Result

3.1 AC Power-line Conducted Emissions

3.1.1 AC Power-line Conducted Emissions Limit

AC Power-line Conducted Emissions Limit		
Frequency Emission (MHz)	Quasi-Peak	Average
0.15-0.5	66 - 56 *	56 - 46 *
0.5-5	56	46
5-30	60	50

Note 1: * Decreases with the logarithm of the frequency.

3.1.2 Measuring Instruments

Refer a test equipment and calibration data table in this test report.

3.1.3 Test Procedures

Test Method
▪ Refer as ANSI C63.10-2013, clause 6.2 for AC power-line conducted emissions.

3.1.4 Test Setup

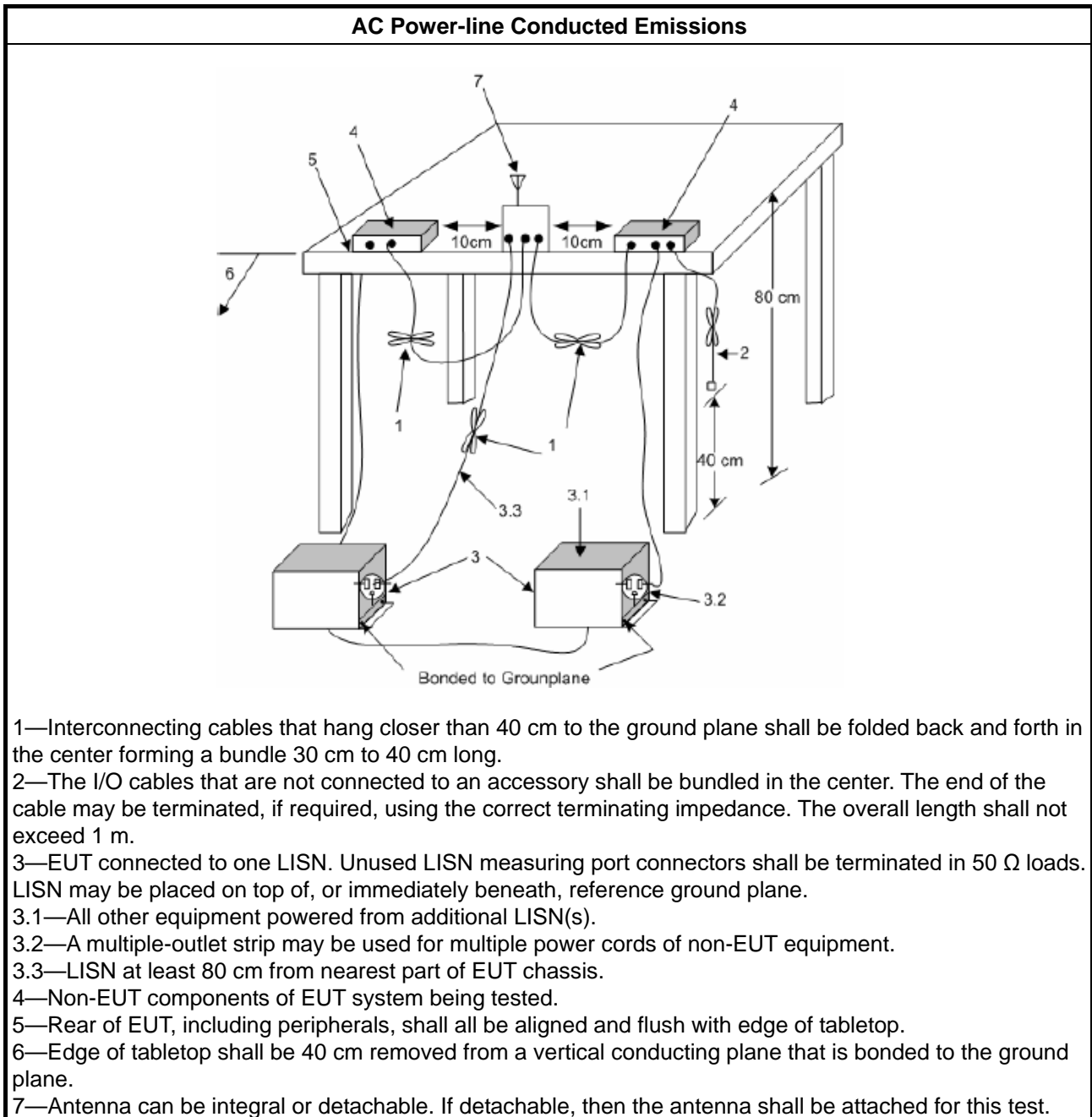

3.1.5 Test Result of AC Power-line Conducted Emissions

Refer as Appendix A



3.2 DTS Bandwidth

3.2.1 6dB Bandwidth Limit

6dB Bandwidth Limit
Systems using digital modulation techniques:
<ul style="list-style-type: none"> 6 dB bandwidth \geq 500 kHz.

3.2.2 Measuring Instruments

Refer a test equipment and calibration data table in this test report.

3.2.3 Test Procedures

Test Method
<ul style="list-style-type: none"> For the emission bandwidth shall be measured using one of the options below:
<input checked="" type="checkbox"/> Refer as FCC KDB 558074, clause 8.2 & C63.10 clause 11.8.1 Option 1 for 6 dB bandwidth measurement.
<input type="checkbox"/> Refer as FCC KDB 558074, clause 8.2 & C63.10 clause 11.8.2 Option 2 for 6 dB bandwidth measurement.
<input type="checkbox"/> Refer as ANSI C63.10, clause 6.9.1 for occupied bandwidth testing.

3.2.4 Test Setup

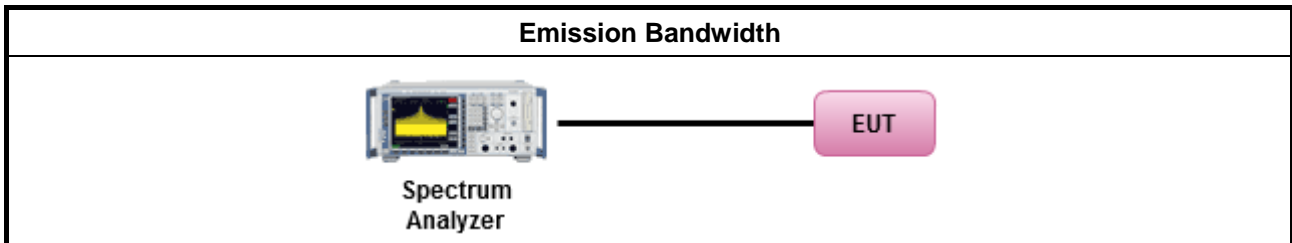

3.2.5 Test Result of Emission Bandwidth

Refer as Appendix B



3.3 Maximum Conducted Output Power

3.3.1 Maximum Conducted Output Power Limit

Maximum Conducted Output Power Limit	
	<ul style="list-style-type: none"> ▪ If $G_{TX} \leq 6$ dBi, then $P_{Out} \leq 30$ dBm (1 W)
	<ul style="list-style-type: none"> ▪ Point-to-multipoint systems (P2M): If $G_{TX} > 6$ dBi, then $P_{Out} = 30 - (G_{TX} - 6)$ dBm
	<ul style="list-style-type: none"> ▪ Point-to-point systems (P2P): If $G_{TX} > 6$ dBi, then $P_{Out} = 30 - (G_{TX} - 6)/3$ dBm
	<ul style="list-style-type: none"> ▪ Smart antenna system (SAS):
	<ul style="list-style-type: none"> - Single beam: If $G_{TX} > 6$ dBi, then $P_{Out} = 30 - (G_{TX} - 6)/3$ dBm
	<ul style="list-style-type: none"> - Overlap beam: If $G_{TX} > 6$ dBi, then $P_{Out} = 30 - (G_{TX} - 6)/3$ dBm
	<ul style="list-style-type: none"> - Aggregate power on all beams: If $G_{TX} > 6$ dBi, then $P_{Out} = 30 - (G_{TX} - 6)/3 + 8$ dB dBm
<p>P_{Out} = maximum peak conducted output power or maximum conducted output power in dBm, G_{TX} = the maximum transmitting antenna directional gain in dBi.</p>	

3.3.2 Measuring Instruments

Refer a test equipment and calibration data table in this test report.



3.3.3 Test Procedures

Test Method	
<ul style="list-style-type: none"> ▪ Maximum Peak Conducted Output Power 	
	<input type="checkbox"/> Refer as FCC KDB 558074, clause 8.3.1.1 & C63.10 clause 11.9.1.1 (RBW ≥ EBW method).
	<input type="checkbox"/> Refer as FCC KDB 558074, clause 8.3.1.3 & C63.10 clause 11.9.1.3 (peak power meter).
<ul style="list-style-type: none"> ▪ Maximum Conducted Output Power 	
	[duty cycle ≥ 98% or external video / power trigger]
	<input type="checkbox"/> Refer as FCC KDB 558074, clause 8.3.2.2 & C63.10 clause 11.9.2.2.2 Method AVGSA-1.
	<input type="checkbox"/> Refer as FCC KDB 558074, clause 8.3.2.2 & C63.10 clause 11.9.2.2.3 Method AVGSA-1A. (alternative)
	duty cycle < 98% and average over on/off periods with duty factor
	<input type="checkbox"/> Refer as FCC KDB 558074, clause 8.3.2.2 & C63.10 clause 11.9.2.2.4 Method AVGSA-2.
	<input type="checkbox"/> Refer as FCC KDB 558074, clause 8.3.2.2 & C63.10 clause 11.9.2.2.5 Method AVGSA-2A (alternative)
	<input type="checkbox"/> Refer as FCC KDB 558074, clause 8.3.2.2 & C63.10 clause 11.9.2.2.6 Method AVGSA-3
	<input type="checkbox"/> Refer as FCC KDB 558074, clause 8.3.2.2 & C63.10 clause 11.9.2.2.7 Method AVGSA-3A (alternative)
	Measurement using a power meter (PM)
	<input checked="" type="checkbox"/> Refer as FCC KDB 558074, clause 8.3.2.3 & C63.10 clause 11.9.2.3.1 Method AVGPM (using an RF average power meter).
	<input type="checkbox"/> Refer as FCC KDB 558074, clause 8.3.2.3 & C63.10 clause 11.9.2.3.2 Method AVGPM-G (using an gate RF average power meter).
<ul style="list-style-type: none"> ▪ For conducted measurement. 	
	<ul style="list-style-type: none"> ▪ If the EUT supports multiple transmit chains using options given below: Refer as FCC KDB 662911, In-band power measurements. Using the measure-and-sum approach, measured all transmit ports individually. Sum the power (in linear power units e.g., mW) of all ports for each individual sample and save them.
	<ul style="list-style-type: none"> ▪ If multiple transmit chains, EIRP calculation could be following as methods: $P_{total} = P_1 + P_2 + \dots + P_n$ (calculated in linear unit [mW] and transfer to log unit [dBm]) $EIRP_{total} = P_{total} + DG$

3.3.4 Test Setup

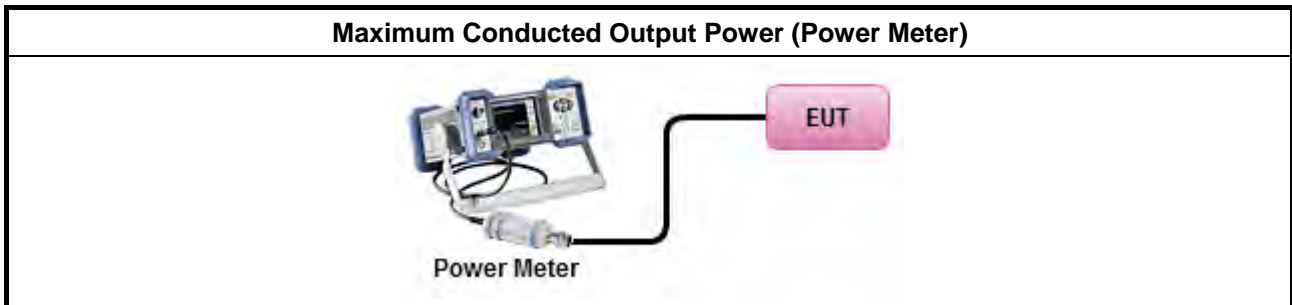

3.3.5 Test Result of Maximum Conducted Output Power

Refer as Appendix C



3.4 Power Spectral Density

3.4.1 Power Spectral Density Limit

Power Spectral Density Limit
<ul style="list-style-type: none"> Power Spectral Density (PSD) ≤ 8 dBm/3kHz

3.4.2 Measuring Instruments

Refer a test equipment and calibration data table in this test report.

3.4.3 Test Procedures

Test Method
<ul style="list-style-type: none"> Peak power spectral density procedures that the same method as used to determine the conducted output power. If maximum peak conducted output power was measured to demonstrate compliance to the output power limit, then the peak PSD procedure below (Method PKPSD) shall be used. If maximum conducted output power was measured to demonstrate compliance to the output power limit, then one of the average PSD procedures shall be used, as applicable based on the following criteria (the peak PSD procedure is also an acceptable option).
<input checked="" type="checkbox"/> Refer as FCC KDB 558074, clause 8.4 & C63.10 clause 11.10.2 Method PKPSD. [duty cycle ≥ 98% or external video / power trigger]
<input type="checkbox"/> Refer as FCC KDB 558074, clause 8.4 & C63.10 clause 11.10.3 Method AVGPSD-1.
<input type="checkbox"/> Refer as FCC KDB 558074, clause 8.4 & C63.10 clause 11.10.5 Method AVGPSD-2.
<input type="checkbox"/> Refer as FCC KDB 558074, clause 8.4 & C63.10 clause 11.10.7 Method AVGPSD-3.
duty cycle < 98% and average over on/off periods with duty factor
<input type="checkbox"/> Refer as FCC KDB 558074, clause 8.4 & C63.10 clause 11.10.4 Method AVGPSD-1A. (alternative).
<input type="checkbox"/> Refer as FCC KDB 558074, clause 8.4 & C63.10 clause 11.10.6 Method AVGPSD-2A. (alternative)
<input type="checkbox"/> Refer as FCC KDB 558074, clause 8.4 & C63.10 clause 11.10.8 Method AVGPSD-3A. (alternative)
<ul style="list-style-type: none"> For conducted measurement. <ul style="list-style-type: none"> If The EUT supports multiple transmit chains using options given below: <ul style="list-style-type: none"> <input checked="" type="checkbox"/> Option 1: Measure and sum the spectra across the outputs. Refer as FCC KDB 662911, In-band power spectral density (PSD). Sample all transmit ports simultaneously using a spectrum analyzer for each transmit port. Where the trace bin-by-bin of each transmit port summing can be performed. (i.e., in the first spectral bin of output 1 is summed with that in the first spectral bin of output 2 and that from the first spectral bin of output 3, and so on up to the NTX output to obtain the value for the first frequency bin of the summed spectrum.). Add up the amplitude (power) values for the different transmit chains and use this as the new data trace. <input type="checkbox"/> Option 2: Measure and sum spectral maxima across the outputs. With this technique, spectra are measured at each output of the device at the required resolution bandwidth. The maximum value (peak) of each spectrum is determined. These maximum values are then summed mathematically in linear power units across the outputs. These operations shall be performed separately over frequency spans that have different out-of-band or spurious emission limits,



Option 3: Measure and add $10 \log(N)$ dB, where N is the number of transmit chains. Refer as FCC KDB 662911, In-band power spectral density (PSD). Performed at each transmit chains and each transmit chains shall be compared with the limit have been reduced with $10 \log(N)$. Or each transmit chains shall be add $10 \log(N)$ to compared with the limit.

3.4.4 Test Setup

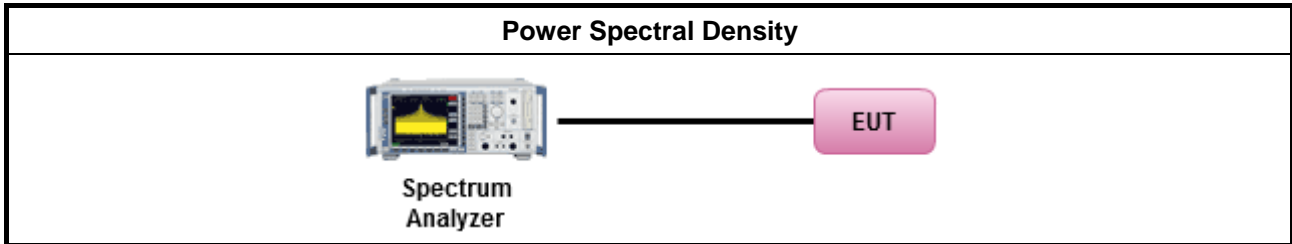

3.4.5 Test Result of Power Spectral Density

Refer as Appendix D

3.5 Emissions in Non-restricted Frequency Bands

3.5.1 Emissions in Non-restricted Frequency Bands Limit

Un-restricted Band Emissions Limit	
RF output power procedure	Limit (dBc)
Peak output power procedure	20
Average output power procedure	30

Note 1: If the peak output power procedure is used to measure the fundamental emission power to demonstrate compliance to requirements, then the peak conducted output power measured within any 100 kHz outside the authorized frequency band shall be attenuated by at least 20 dB relative to the maximum measured in-band peak PSD level.

Note 2: If the average output power procedure is used to measure the fundamental emission power to demonstrate compliance to requirements, then the power in any 100 kHz outside of the authorized frequency band shall be attenuated by at least 30 dB relative to the maximum measured in-band average PSD level.

3.5.2 Measuring Instruments

Refer a test equipment and calibration data table in this test report.

3.5.3 Test Procedures

Test Method
<ul style="list-style-type: none"> Refer as FCC KDB 558074, clause 8.5 for unwanted emissions into non-restricted bands.

3.5.4 Test Setup

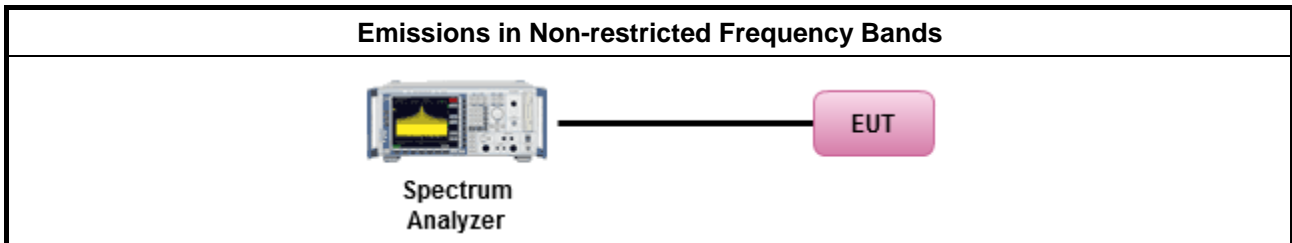

3.5.5 Test Result of Emissions in Non-restricted Frequency Bands

Refer as Appendix E



3.6 Emissions in Restricted Frequency Bands

3.6.1 Emissions in Restricted Frequency Bands Limit

Restricted Band Emissions Limit			
Frequency Range (MHz)	Field Strength (uV/m)	Field Strength (dBuV/m)	Measure Distance (m)
0.009~0.490	2400/F(kHz)	48.5 - 13.8	300
0.490~1.705	24000/F(kHz)	33.8 - 23	30
1.705~30.0	30	29	30
30~88	100	40	3
88~216	150	43.5	3
216~960	200	46	3
Above 960	500	54	3

Note 1: Test distance for frequencies at or above 30 MHz, measurements may be performed at a distance other than the limit distance provided they are not performed in the near field and the emissions to be measured can be detected by the measurement equipment. When performing measurements at a distance other than that specified, the results shall be extrapolated to the specified distance using an extrapolation factor of 20 dB/decade (inverse of linear distance for field-strength measurements, inverse of linear distance-squared for power-density measurements).

Note 2: Test distance for frequencies at below 30 MHz, measurements may be performed at a distance closer than the EUT limit distance; however, an attempt should be made to avoid making measurements in the near field. When performing measurements below 30 MHz at a closer distance than the limit distance, the results shall be extrapolated to the specified distance by either making measurements at a minimum of two or more distances on at least one radial to determine the proper extrapolation factor or by using the square of an inverse linear distance extrapolation factor (40 dB / decade). The test report shall specify the extrapolation method used to determine compliance of the EUT.

Note 3: Using the distance of 1m during the test for above 18 GHz, and the test value to correct for the distance factor at 3m.

3.6.2 Measuring Instruments

Refer a test equipment and calibration data table in this test report.



3.6.3 Test Procedures

Test Method	
<ul style="list-style-type: none"> ▪ The average emission levels shall be measured in [duty cycle \geq 98 or duty factor]. 	
<ul style="list-style-type: none"> ▪ Refer as ANSI C63.10, clause 6.10.3 band-edge testing shall be performed at the lowest frequency channel and highest frequency channel within the allowed operating band. 	
<ul style="list-style-type: none"> ▪ For the transmitter unwanted emissions shall be measured using following options below: 	
	<ul style="list-style-type: none"> ▪ Refer as FCC KDB 558074, clause 8.6 for unwanted emissions into restricted bands.
	<input type="checkbox"/> Refer as FCC KDB 558074, clause 8.6 & C63.10 clause 11.12.2.5.1(trace averaging for duty cycle \geq 98%).
	<input type="checkbox"/> Refer as FCC KDB 558074, clause 8.6 & C63.10 clause 11.12.2.5.2(trace averaging + duty factor).
	<input checked="" type="checkbox"/> Refer as FCC KDB 558074, clause 8.6 & C63.10 clause 11.12.2.5.3(Reduced VBW \geq 1/T).
	<input type="checkbox"/> Refer as ANSI C63.10, clause 11.12.2.5.3 (Reduced VBW). VBW \geq 1/T, where T is pulse time.
	<input type="checkbox"/> Refer as ANSI C63.10, clause 7.5 average value of pulsed emissions.
	<input checked="" type="checkbox"/> Refer as FCC KDB 558074, clause 8.6 & C63.10 clause 11.12.2.4 measurement procedure peak limit.
<ul style="list-style-type: none"> ▪ For the transmitter band-edge emissions shall be measured using following options below: 	
	<ul style="list-style-type: none"> ▪ Refer as FCC KDB 558074 clause 8.7 & c63.10 clause 11.13.1, When the performing peak or average radiated measurements, emissions within 2 MHz of the authorized band edge may be measured using the marker-delta method described below.
	<ul style="list-style-type: none"> ▪ Refer as FCC KDB 558074, clause 8.7 (ANSI C63.10, clause 6.10.6) for marker-delta method for band-edge measurements.
	<ul style="list-style-type: none"> ▪ Refer as FCC KDB 558074, clause 8.7 for narrower resolution bandwidth (100kHz) using the band power and summing the spectral levels (i.e., 1 MHz).
	<ul style="list-style-type: none"> ▪ For conducted unwanted emissions into restricted bands (absolute emission limits). Devices with multiple transmit chains using options given below: (1) Measure and sum the spectra across the outputs or (2) Measure and add 10 log(N) dB
	<ul style="list-style-type: none"> ▪ For FCC KDB 662911 The methodology described here may overestimate array gain, thereby resulting in apparent failures to satisfy the out-of-band limits even if the device is actually compliant. In such cases, compliance may be demonstrated by performing radiated tests around the frequencies at which the apparent failures occurred.

3.6.4 Test Setup

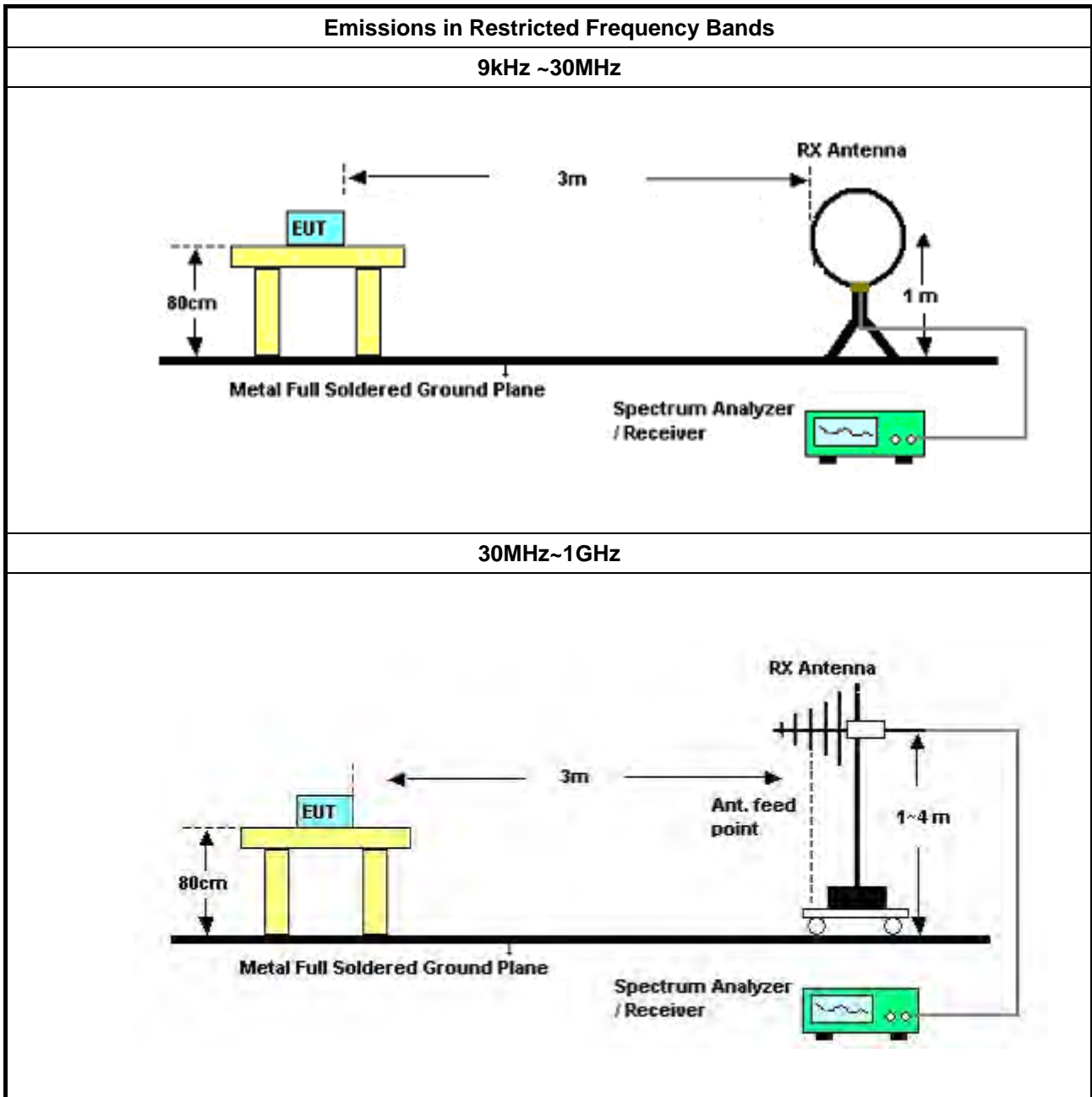

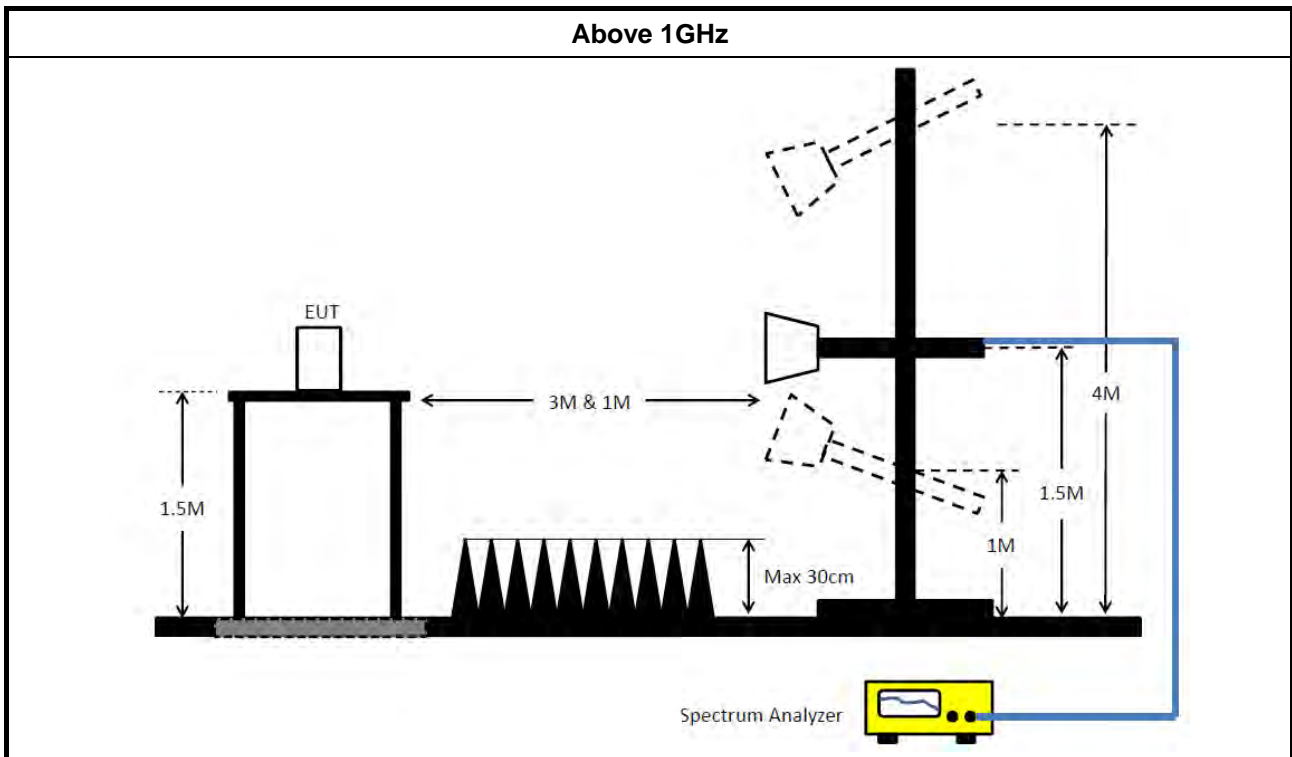

3.6.5 Measurement Results Calculation

The measured Level is calculated using:

Corrected Reading: Antenna Factor + Cable Loss + Read Level - Preamp Factor = Level.

3.6.6 Emissions in Restricted Frequency Bands (Below 30MHz)

There is a comparison data of both open-field test site and alternative test site - semi-Anechoic chamber according to KDB414788 Radiated Test Site, and the result came out very similar.

All amplitude of spurious emissions that are attenuated by more than 20 dB below the permissible value has no need to be reported.

The radiated emissions were investigated from 9 kHz or the lowest frequency generated within the device, up to the 10 harmonic or 40 GHz, whichever is appropriate.

3.6.7 Test Result of Emissions in Restricted Frequency Bands

Refer as Appendix F



4 Test Equipment and Calibration Data

Instrument	Manufacturer	Model No.	Serial No.	Characteristics	Calibration Date	Calibration Due Date	Remark
EMI Receiver	Agilent	N9038A	My52260123	9kHz ~ 8.45GHz	Jan. 28, 2019	Jan. 29, 2020	Conduction (CO01-CB)
LISN	F.C.C.	FCC-LISN-50-16-2	04083	150kHz ~ 100MHz	Dec. 24, 2018	Dec. 23, 2019	Conduction (CO01-CB)
LISN	Schwarzbeck	NSLK 8127	8127647	9kHz ~ 30MHz	Jan. 11, 2019	Jan. 10, 2020	Conduction (CO01-CB)
COND Cable	Woken	Cable	Low cable-CO01	9kHz ~ 30MHz	May 21, 2019	May 20, 2020	Conduction (CO01-CB)
Software	Audix	E3	6.120210n	-	N.C.R.	N.C.R.	Conduction (CO01-CB)
Loop Antenna	Teseq	HLA 6120	24155	9kHz - 30 MHz	Mar. 29, 2019	Mar. 28, 2020	Radiation (03CH05-CB)
Bilog Antenna with 6dB Attenuator	TESE & EMCI	CBL 6112D & N-6-06	35236 & AT-N0610	30MHz ~ 2GHz	Mar. 28, 2019	Mar. 27, 2020	Radiation (03CH05-CB)
Pre-Amplifier	EMCI	EMC330N	980331	20MHz ~ 3GHz	May 02, 2019	May 01, 2020	Radiation (03CH05-CB)
Spectrum Analyzer	R&S	FSP40	100304	9kHz ~ 40GHz	Aug. 15, 2019	Aug. 14, 2020	Radiation (03CH05-CB)
EMI Test Receiver	R&S	ESCS	826547/017	9kHz ~ 2.75GHz	May 15, 2019	May 14, 2020	Radiation (03CH05-CB)
RF Cable-low	Woken	RG402	LOW Cable-04+23	30MHz~1GHz	Oct. 08, 2018	Oct. 07, 2019	Radiation (03CH05-CB)
RF Cable-high	Woken	RG402	High Cable-04+23	30MHz~18GHz	Oct. 08, 2018	Oct. 07, 2019	Radiation (03CH05-CB)
Horn Antenna	ETS · Lindgren	3115	6821	750MHz~18GHz	Jan. 24, 2019	Jan. 23, 2020	Radiation (03CH03-CB)
Horn Antenna	Schwarzbeck	BBHA 9170	BBHA9170252	15GHz ~ 40GHz	Jun. 27, 2019	Jun. 26, 2020	Radiation (03CH03-CB)
Pre-Amplifier	Agilent	8449B	3008A02097	1GHz ~ 26.5GHz	Dec. 20, 2018	Dec. 19, 2019	Radiation (03CH03-CB)
Pre-Amplifier	MITEQ	TTA1840-35-HG	1864479	18GHz ~ 40GHz	Jul. 03, 2019	Jul. 02, 2020	Radiation (03CH03-CB)
Spectrum Analyzer	R&S	FSP40	100019	9kHz ~ 40GHz	Jun. 19, 2019	Jun. 18, 2020	Radiation (03CH03-CB)
RF Cable-high	Woken	RG402	High Cable-20+27	1GHz ~ 18GHz	Oct. 07, 2019	Oct. 06, 2020	Radiation (03CH03-CB)
RF Cable-high	Woken	RG402	High Cable-27	1GHz ~ 18GHz	Oct. 07, 2019	Oct. 06, 2020	Radiation (03CH03-CB)
RF Cable-high	Woken	RG402	High Cable-40G#1	18GHz ~ 40 GHz	Jul. 24, 2019	Jul. 23, 2020	Radiation (03CH03-CB)
RF Cable-high	Woken	RG402	High Cable-40G#2	18GHz ~ 40 GHz	Jul. 24, 2019	Jul. 23, 2020	Radiation (03CH03-CB)
Spectrum analyzer	R&S	FSV40	101027	9kHz~40GHz	Jul. 02, 2019	Jul. 01, 2020	Conducted (TH02-CB)



Instrument	Manufacturer	Model No.	Serial No.	Characteristics	Calibration Date	Calibration Due Date	Remark
Power Sensor	Agilent	E9327A	US40442088	50MHz~18GHz	Jan. 15, 2019	Jan. 14, 2020	Conducted (TH02-CB)
Power Meter	Agilent	E4416A	GB41291199	50MHz~18GHz	Jan. 15, 2019	Jan. 14, 2020	Conducted (TH02-CB)
RF Cable-high	Woken	RG402	High Cable-01	1 GHz – 26.5 GHz	Oct. 08, 2018	Oct. 07, 2019	Conducted (TH02-CB)
RF Cable-high	Woken	RG402	High Cable-02	1 GHz – 26.5 GHz	Oct. 08, 2018	Oct. 07, 2019	Conducted (TH02-CB)
RF Cable-high	Woken	RG402	High Cable-3	1 GHz – 26.5 GHz	Oct. 24, 2018	Oct. 23, 2019	Conducted (TH02-CB)
RF Cable-high	Woken	RG402	High Cable-04	1 GHz – 26.5 GHz	Oct. 08, 2018	Oct. 07, 2019	Conducted (TH02-CB)
RF Cable-high	Woken	RG402	High Cable-05	1 GHz – 26.5 GHz	Oct. 08, 2018	Oct. 07, 2019	Conducted (TH02-CB)
RF Cable-high	Woken	RG402	High Cable-01	1 GHz – 26.5 GHz	Oct. 08, 2018	Oct. 07, 2019	Conducted (TH02-CB)

Note: Calibration Interval of instruments listed above is one year.

NCR means Non-Calibration required.



AC Power-line Conducted Emissions Result

Appendix A

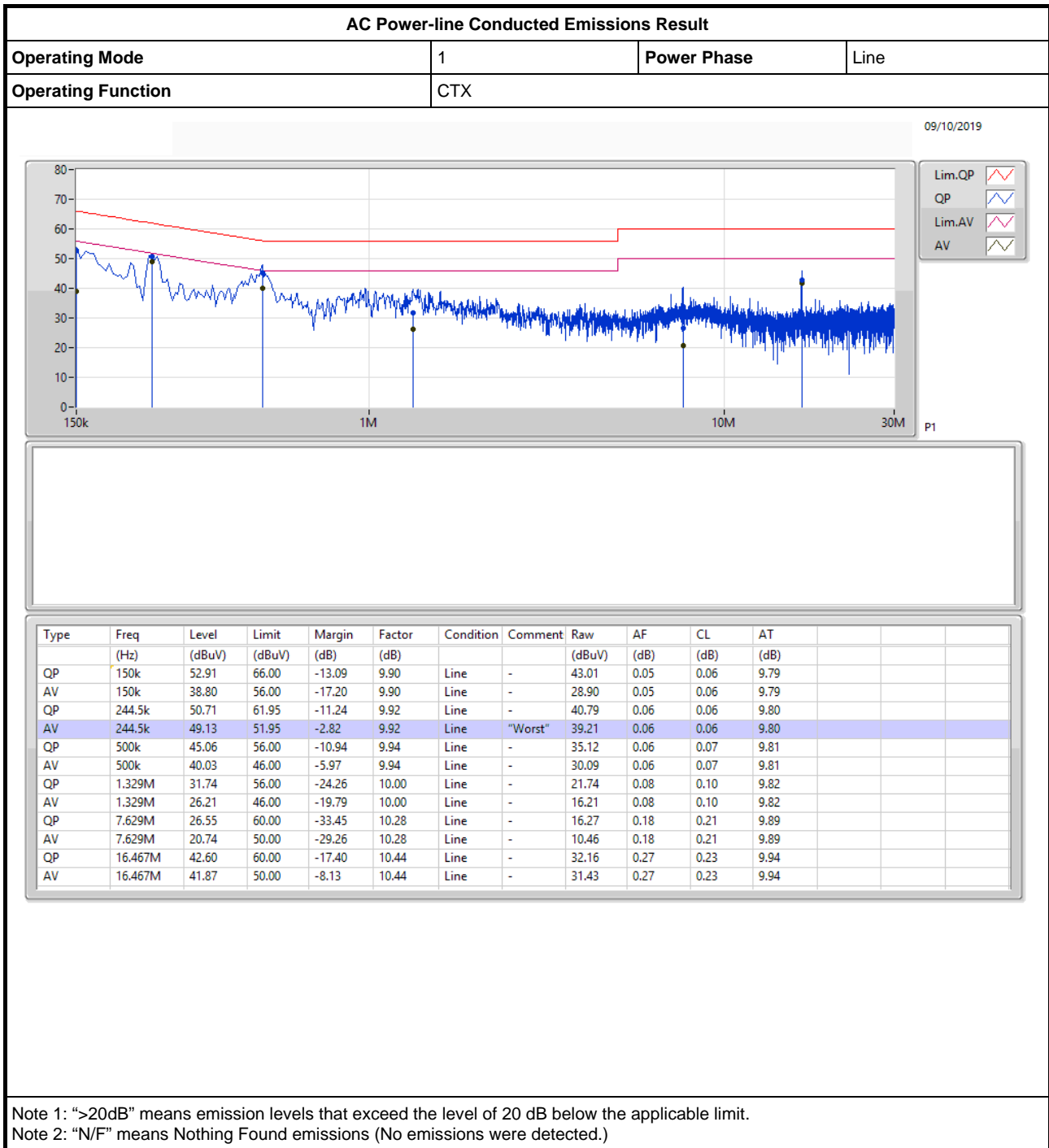



AC Power-line Conducted Emissions Result

Appendix A

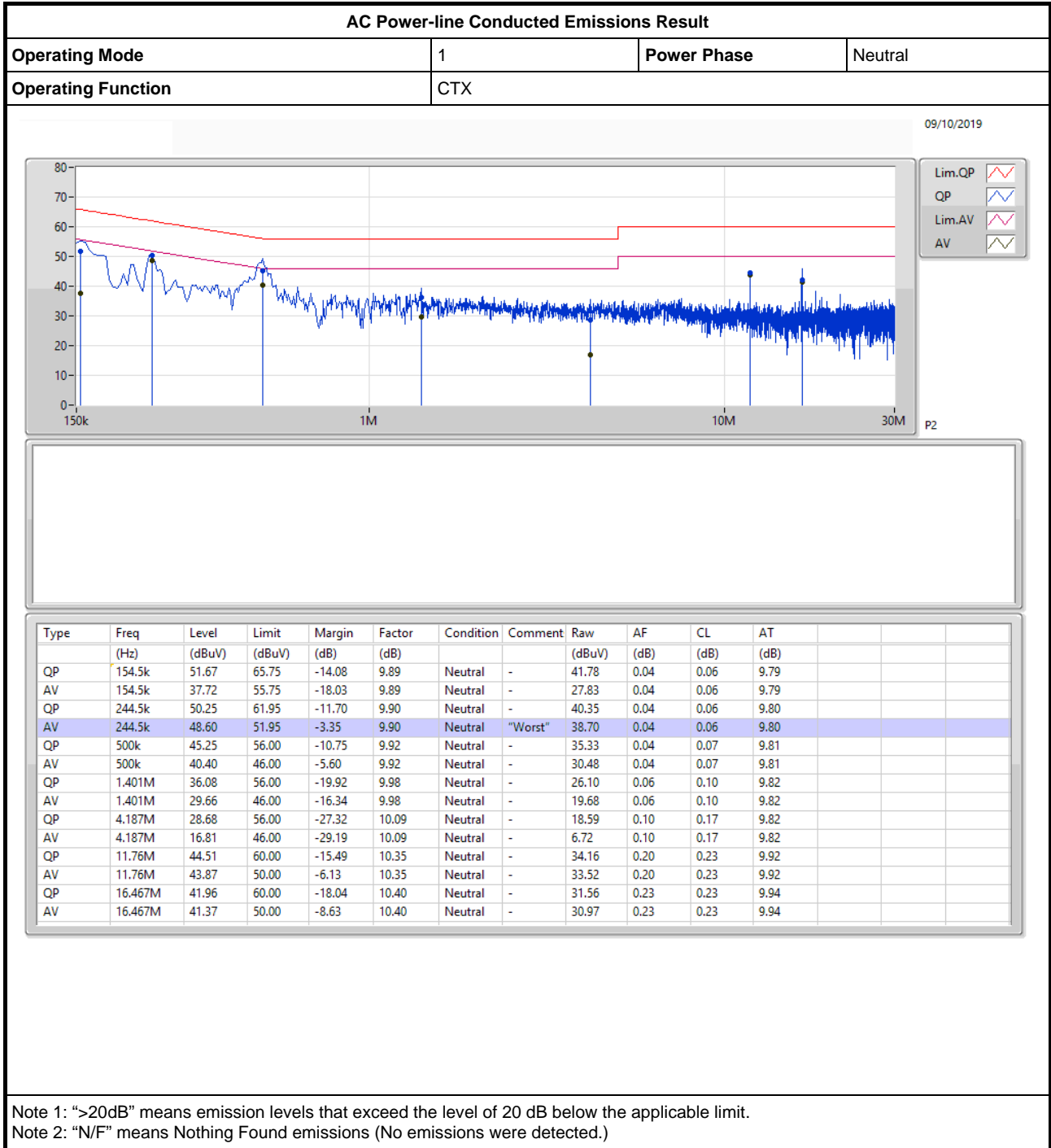



Summary

Mode	Max-N dB (Hz)	Max-OBW (Hz)	ITU-Code	Min-N dB (Hz)	Min-OBW (Hz)
2.4-2.4835GHz	-	-	-	-	-
BT-LE(1Mbps)	702.5k	1.026M	1M03F1D	691.25k	1.026M

Max-N dB = Maximum 6dB down bandwidth; **Max-OBW** = Maximum 99% occupied bandwidth;
Min-N dB = Minimum 6dB down bandwidth; **Min-OBW** = Minimum 99% occupied bandwidth;



Result

Mode	Result	Limit (Hz)	Port 1-N dB (Hz)	Port 1-OBW (Hz)
BT-LE(1Mbps)	-	-	-	-
2402MHz	Pass	500k	697.5k	1.026M
2440MHz	Pass	500k	691.25k	1.026M
2480MHz	Pass	500k	702.5k	1.026M

Port X-N dB = Port X 6dB down bandwidth; Port X-OBW = Port X 99% occupied bandwidth;

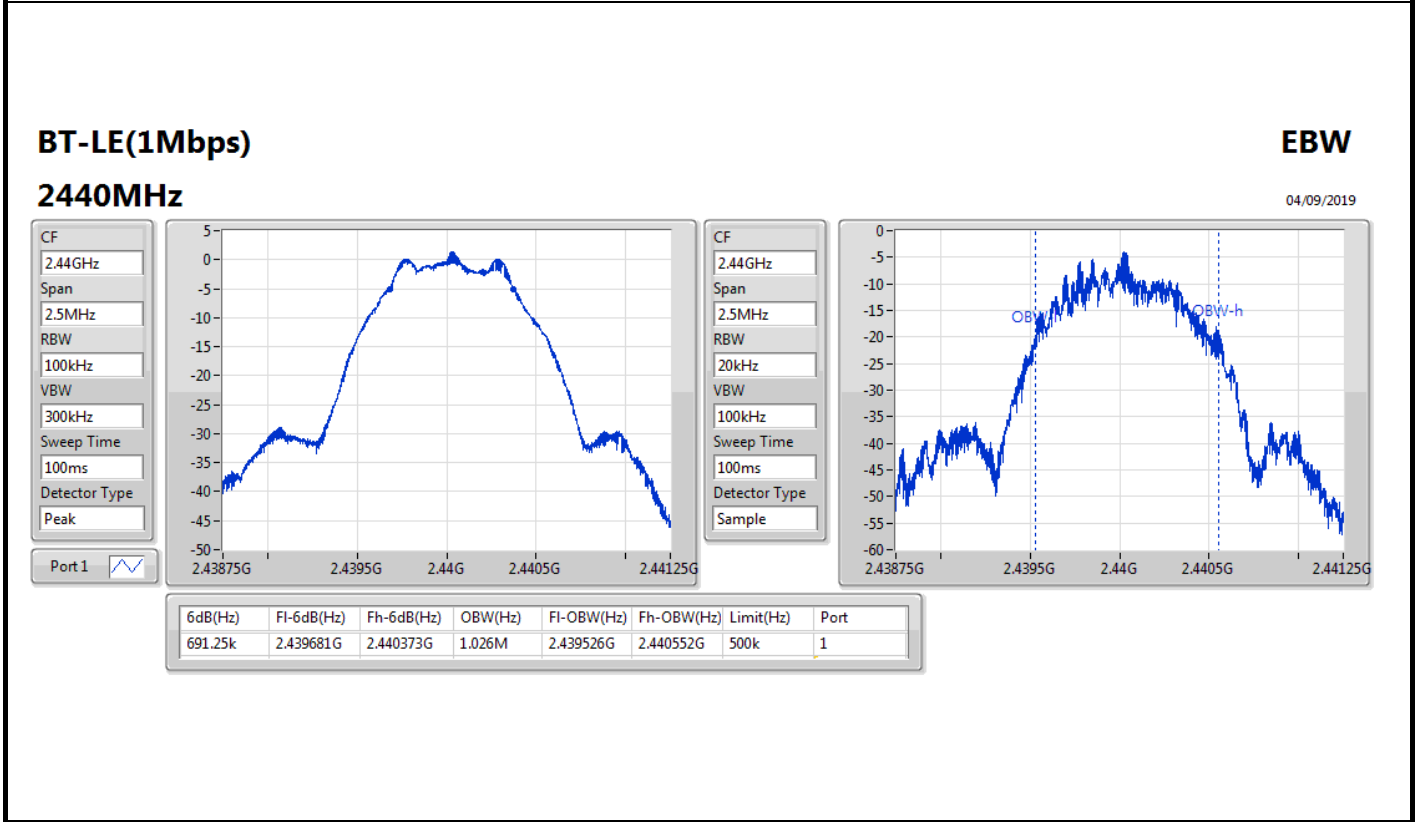
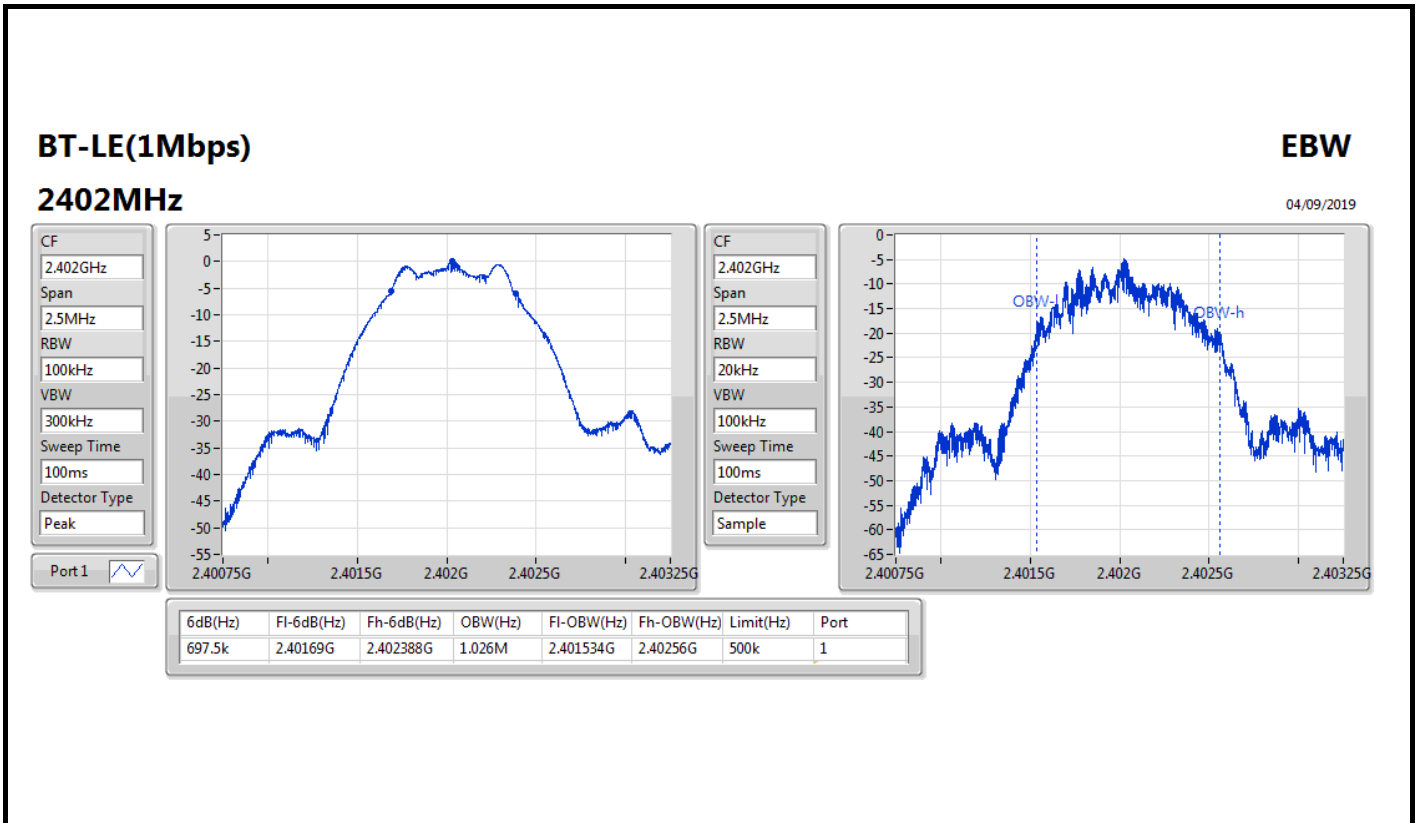

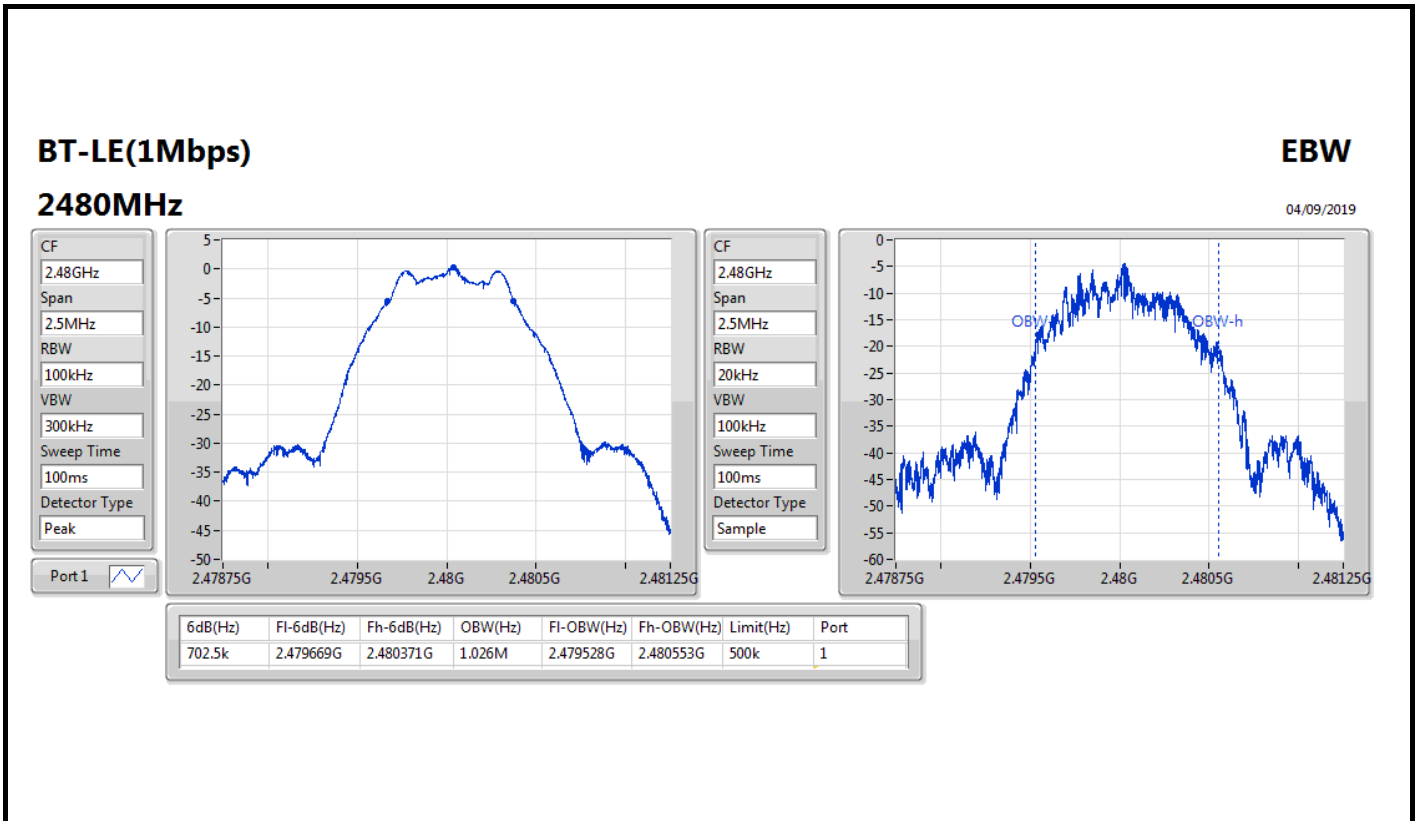



Summary

Mode	Power (dBm)	Power (W)
2.4-2.4835GHz	-	-
BT-LE(1Mbps)	1.12	0.00129



Result

Mode	Result	Gain (dBi)	Power (dBm)	Power Limit (dBm)
BT-LE(1Mbps)	-	-	-	-
2402MHz	Pass	4.50	0.27	30.00
2440MHz	Pass	4.50	1.12	30.00
2480MHz	Pass	4.50	0.67	30.00

DG = Directional Gain; **Port X** = Port X output power



Summary

Mode	PD (dBm/RBW)
2.4-2.4835GHz	-
BT-LE(1Mbps)	-15.43

RBW=3 kHz.



Result

Mode	Result	Gain (dBi)	PD (dBm/RBW)	PD Limit (dBm/RBW)
BT-LE(1Mbps)	-	-	-	-
2402MHz	Pass	4.50	-15.43	8.00
2440MHz	Pass	4.50	-15.76	8.00
2480MHz	Pass	4.50	-15.64	8.00

DG = Directional Gain; RBW=3 kHz;

PD = trace bin-by-bin of each transmits port summing can be performed maximum power density; Port X = Port X power density;

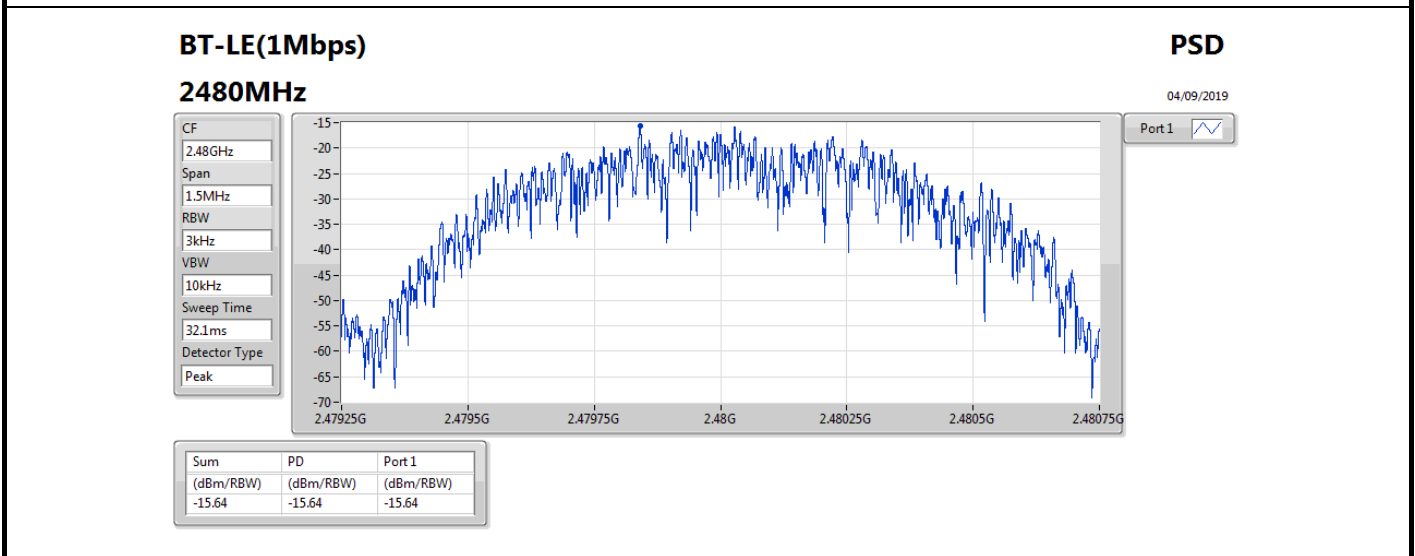
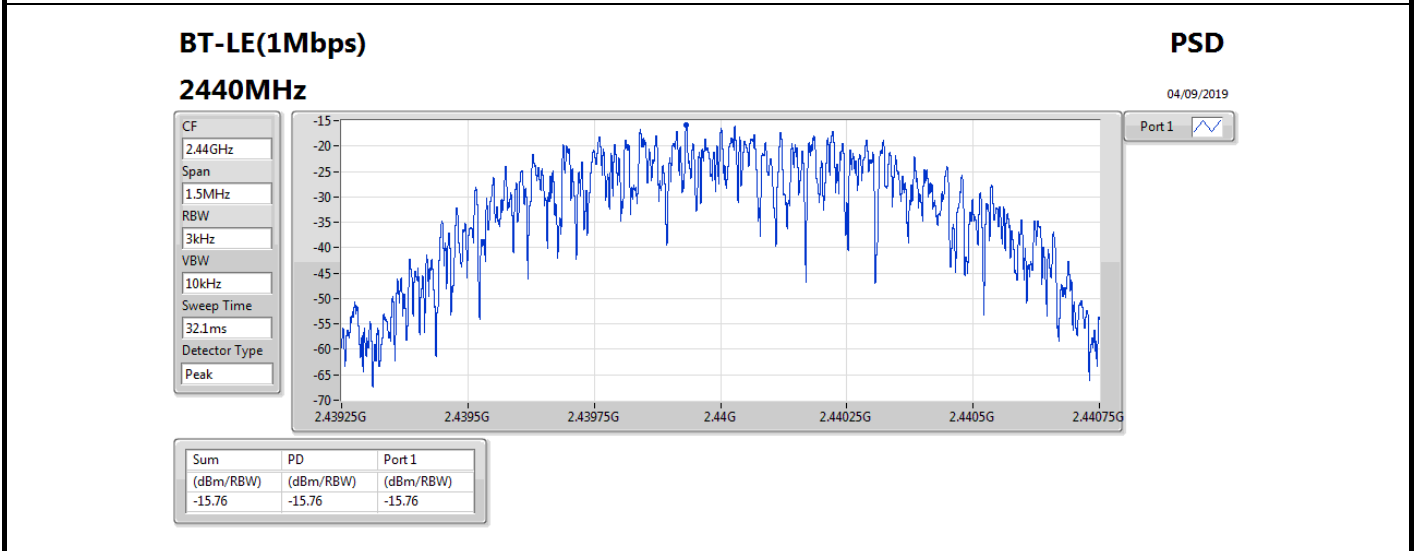
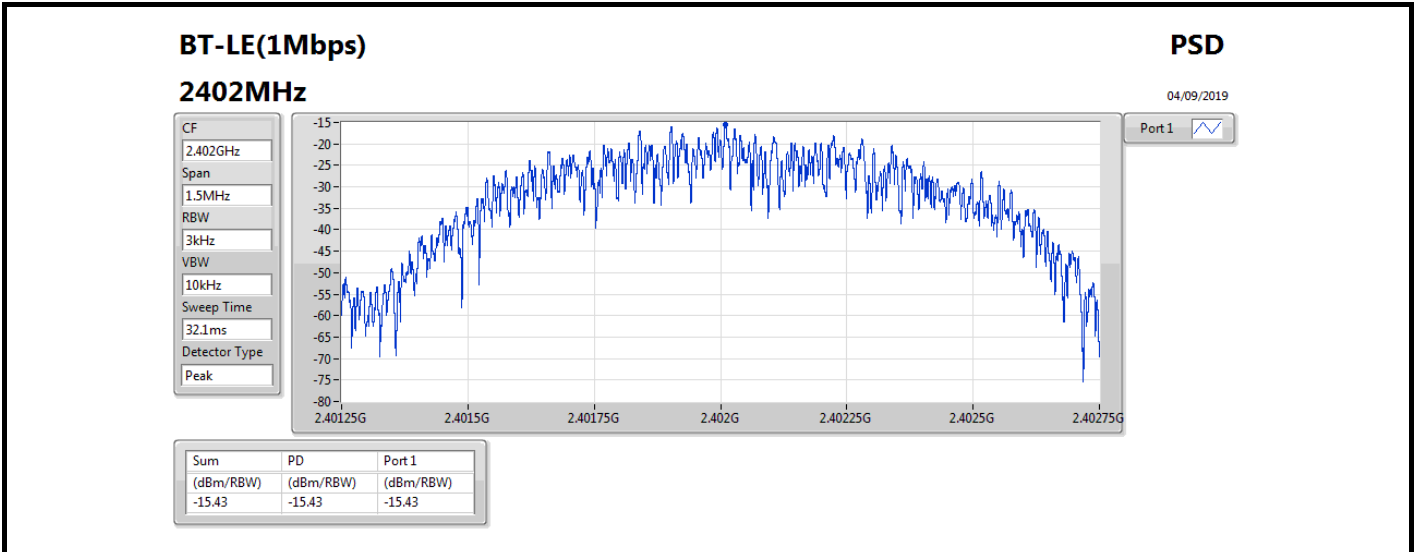



Summary

Mode	Result	Ref (Hz)	Ref (dBm)	Limit (dBm)	Freq (Hz)	Level (dBm)	Freq (Hz)	Level (dBm)	Freq (Hz)	Level (dBm)	Freq (Hz)	Level (dBm)	Port
2.4-2.4835GHz	-	-	-	-	-	-	-	-	-	-	-	-	-
BT-LE(1Mbps)	Pass	2.44G	0.40	-29.60	95.71M	-41.48	2.39923G	-51.87	2.48504G	-51.57	24.45965G	-46.66	1



Result

Mode	Result	Ref (Hz)	Ref (dBm)	Limit (dBm)	Freq (Hz)	Level (dBm)	Freq (Hz)	Level (dBm)	Freq (Hz)	Level (dBm)	Freq (Hz)	Level (dBm)	Port
BT-LE(1Mbps)	-	-	-	-	-	-	-	-	-	-	-	-	-
2402MHz	Pass	2.44G	0.40	-29.60	543.86M	-41.91	2.39999G	-44.09	2.48371G	-51.36	14.82345G	-46.12	1
2440MHz	Pass	2.44G	0.40	-29.60	95.71M	-41.48	2.39923G	-51.87	2.48504G	-51.57	24.45965G	-46.66	1
2480MHz	Pass	2.44G	0.40	-29.60	543.86M	-42.35	2.39932G	-52.08	2.48351G	-50.47	17.48016G	-46.52	1

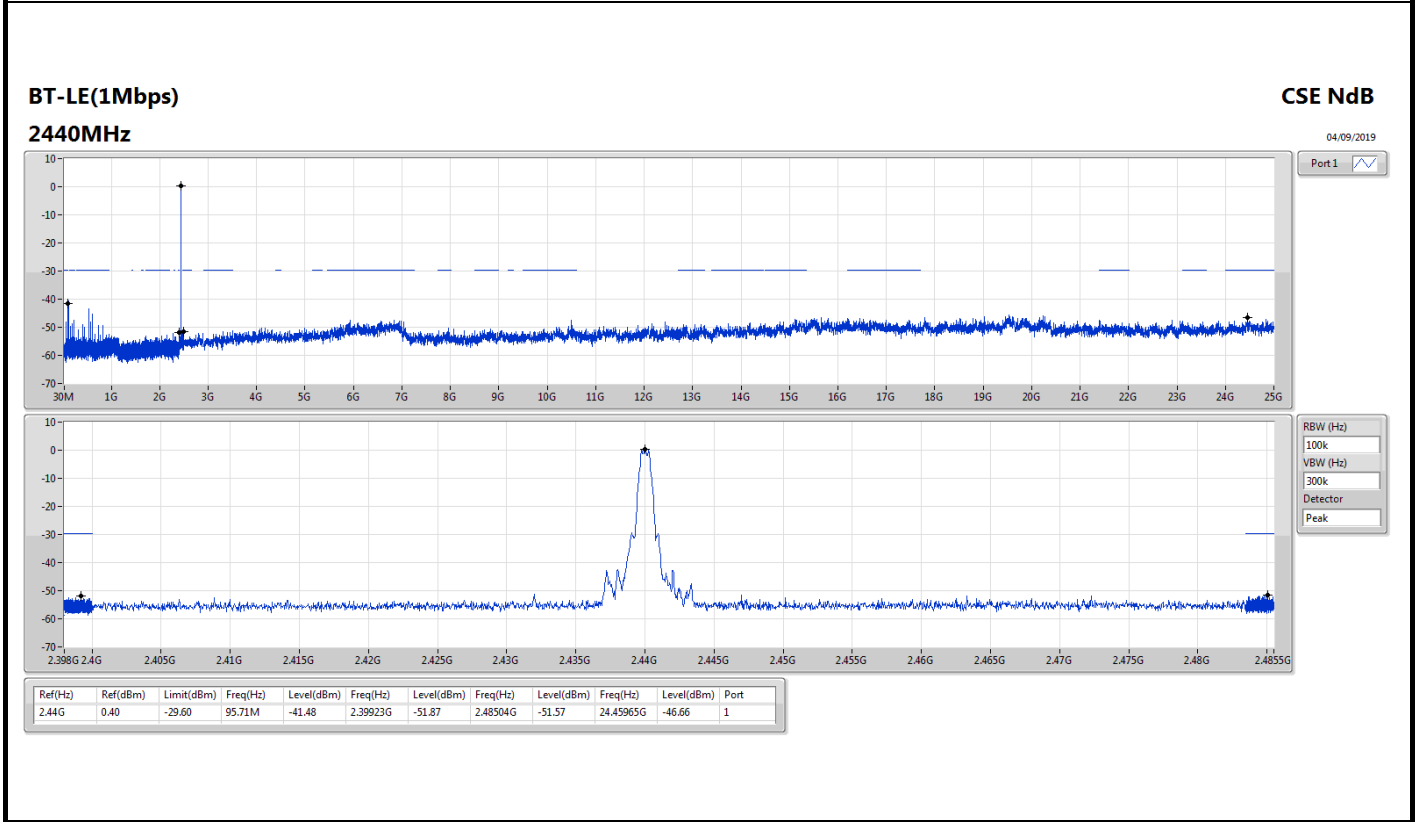
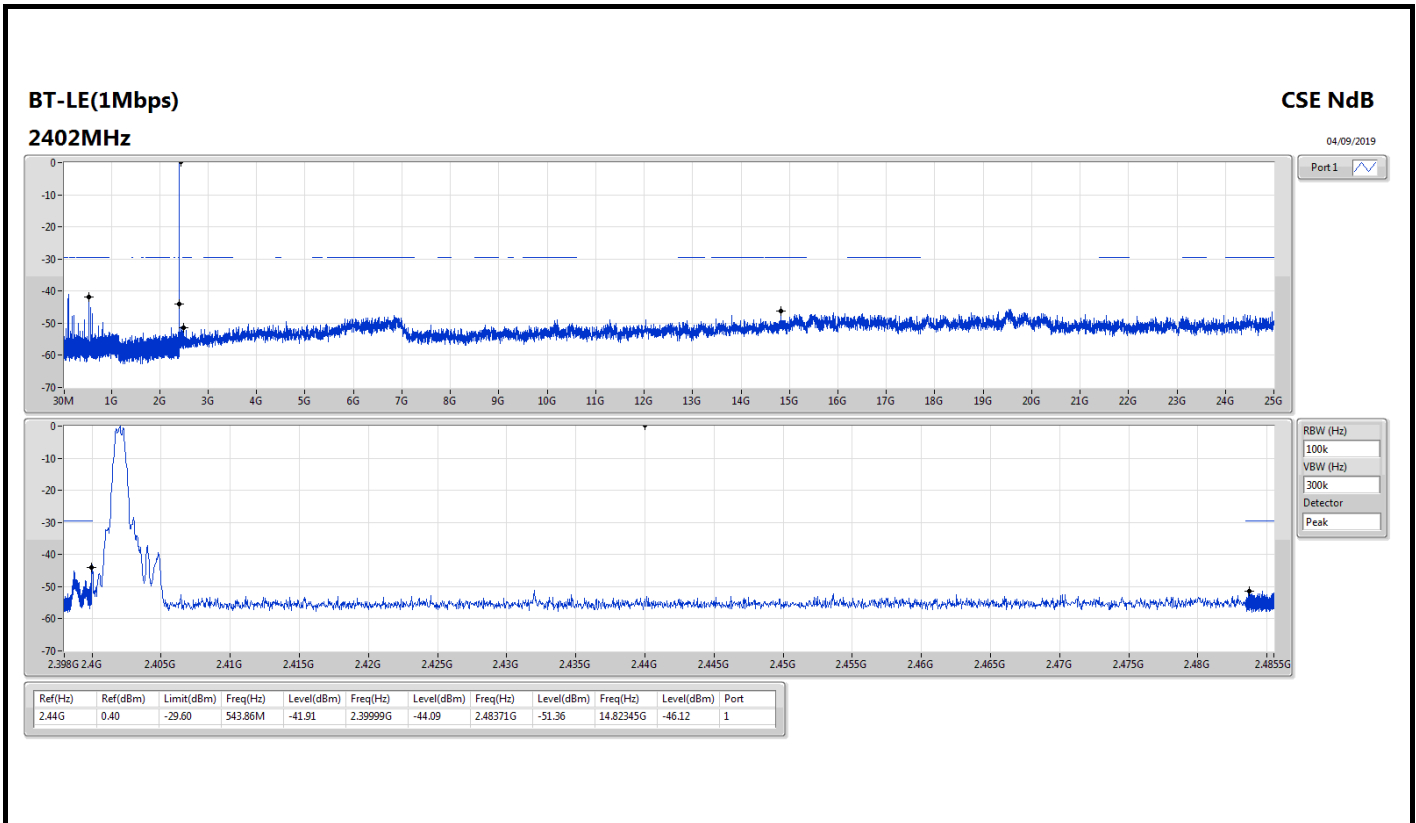

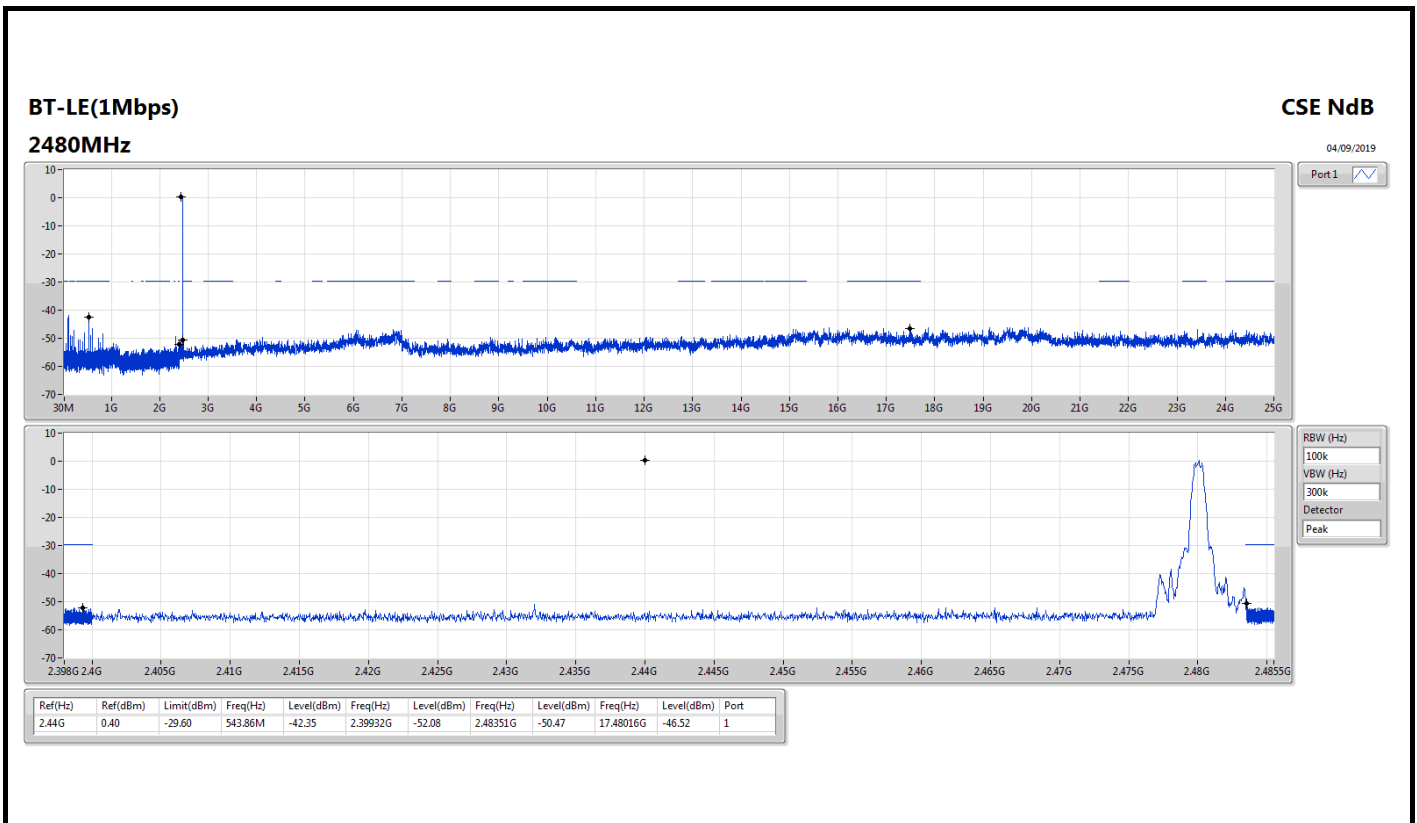



RSE below 1GHz Result											
Operating Mode	5			Polarization	Vertical						
Operating Function	CTX										
	Freq	Level	Limit	Over	Read	CableAntenna	Preamp	A/Pos	T/Pos	Remark	Pol/Phase
	MHz	dBuV/m	dBuV/m	dB	dBuV	dB	dB/m	dB	cm	deg	
1	31.94	35.84	40.00	-4.16	42.16	0.71	24.51	31.54	100	186 QP	VERTICAL
2	54.25	33.69	40.00	-6.31	50.73	0.92	13.83	31.79	150	356 QP	VERTICAL
3	575.14	37.49	46.00	-8.51	41.86	3.20	24.75	32.32	150	178 QP	VERTICAL
4	673.11	34.36	46.00	-11.64	37.98	3.35	25.55	32.52	150	183 QP	VERTICAL
5	696.39	34.02	46.00	-11.98	37.46	3.45	25.60	32.49	125	1 QP	VERTICAL
6	958.29	45.39	46.00	-0.61	45.28	4.12	28.06	32.07	100	181 QP	VERTICAL

Note 1: ">20dB" means emission levels that exceed the level of 20 dB below the applicable limit.
 Note 2: "N/F" means Nothing Found emissions (No emissions were detected.)

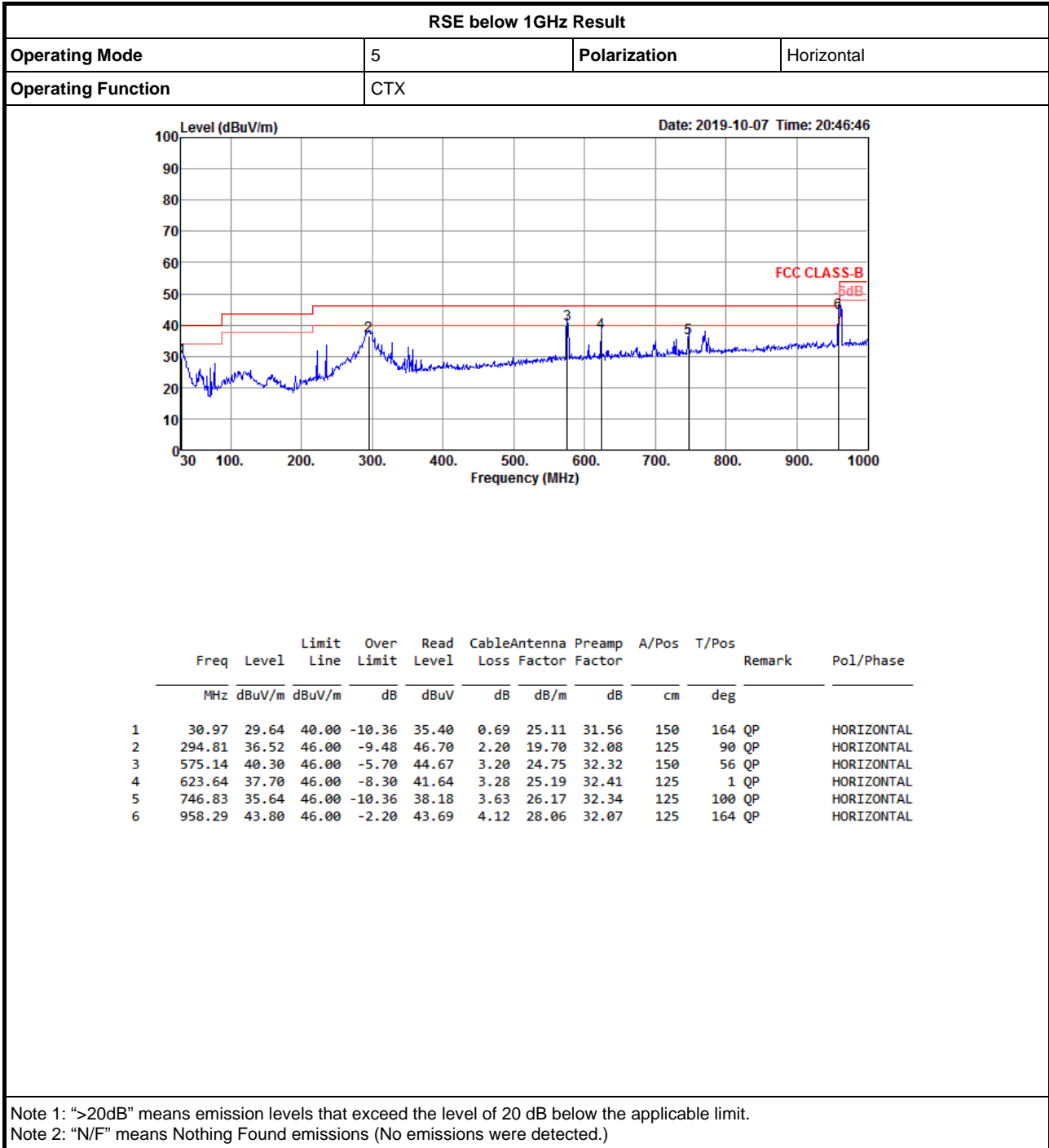



Summary

Mode	Result	Type	Freq (Hz)	Level (dBuV/m)	Limit (dBuV/m)	Margin (dB)	Factor (dB)	Dist (m)	Condition	Azimuth (°)	Height (m)	Comments
2.4-2.4835GHz	-	-	-	-	-	-	-	-	-	-	-	-
BT-LE(1Mbps)	Pass	AV	2.4835G	50.43	54.00	-3.57	32.25	3	Horizontal	90	1.18	-

BT-LE(1Mbps)

04/09/2019

2402MHz_TX

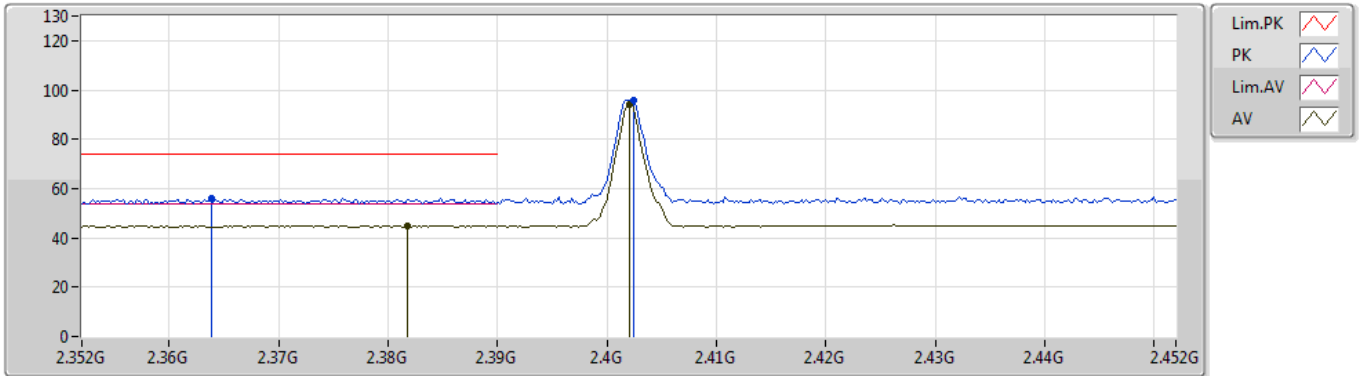

EUT_Y_1TX
Setting 8
03-W-3
FSP(100080)

Type	Freq (Hz)	Level (dBuV/m)	Limit (dBuV/m)	Margin (dB)	Factor (dB)	Dist (m)	Condition	Azimuth (°)	Height (m)	Comment	Raw (dBuV)
PK	2.3638G	56.21	74.00	-17.79	31.86	3	Vertical	20	2.63	-	24.35
AV	2.3818G	44.91	54.00	-9.09	31.91	3	Vertical	20	2.63	-	13.00
PK	2.4024G	95.79	Inf	-Inf	31.97	3	Vertical	20	2.63	-	63.82
AV	2.402G	94.30	Inf	-Inf	31.97	3	Vertical	20	2.63	-	62.33

BT-LE(1Mbps)

04/09/2019

2402MHz_TX

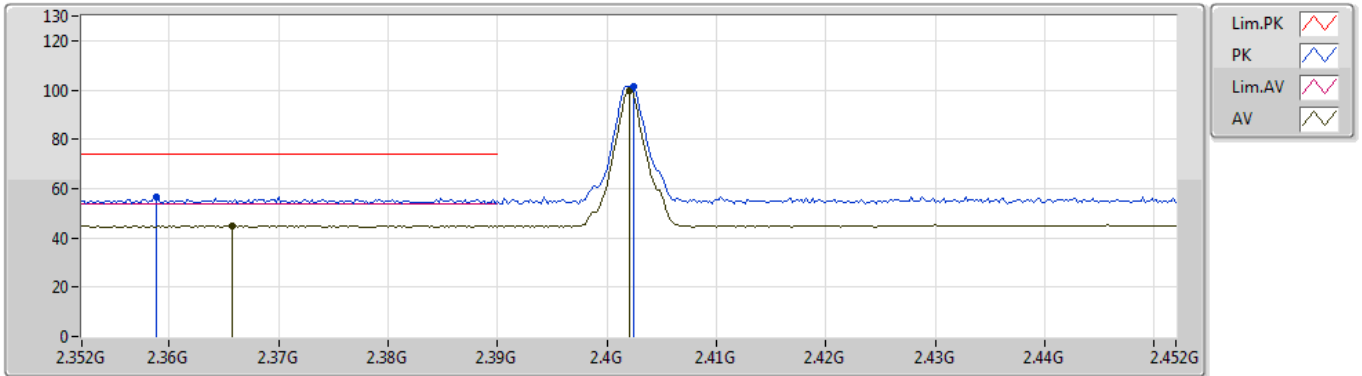

EUT_Y_1TX
Setting 8
03-W-3
FSP(100080)

Type	Freq (Hz)	Level (dBuV/m)	Limit (dBuV/m)	Margin (dB)	Factor (dB)	Dist (m)	Condition	Azimuth (°)	Height (m)	Comment	Raw (dBuV)
PK	2.3588G	56.58	74.00	-17.42	31.85	3	Horizontal	111	2.19	-	24.73
AV	2.3658G	44.94	54.00	-9.06	31.86	3	Horizontal	111	2.19	-	13.08
PK	2.4024G	101.35	Inf	-Inf	31.97	3	Horizontal	111	2.19	-	69.38
AV	2.402G	99.87	Inf	-Inf	31.97	3	Horizontal	111	2.19	-	67.90

BT-LE(1Mbps)

04/09/2019

2402MHz_TX

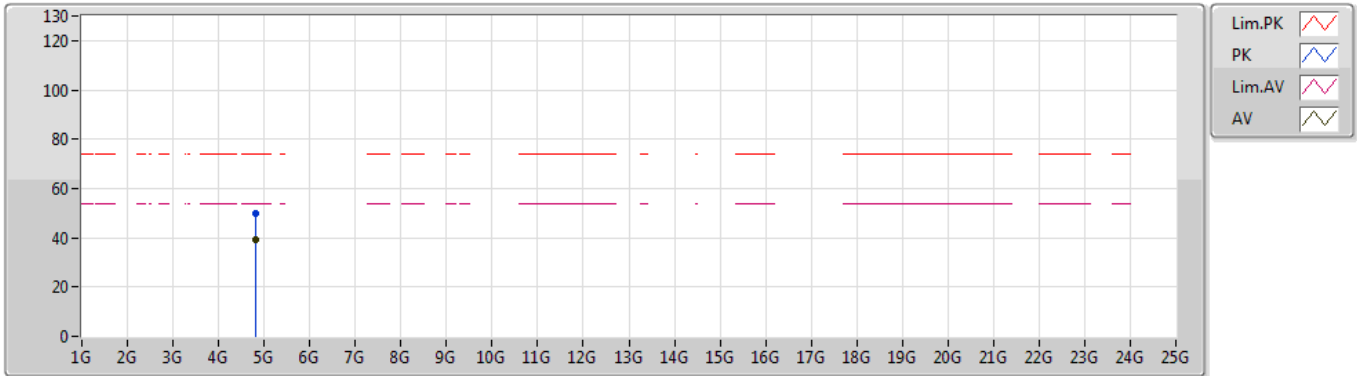

EUT Y_1TX
Setting 8
03-W-3
FSP(100080)

Type	Freq (Hz)	Level (dBuV/m)	Limit (dBuV/m)	Margin (dB)	Factor (dB)	Dist (m)	Condition	Azimuth (°)	Height (m)	Comment	Raw (dBuV)
PK	4.80373G	49.71	74.00	-24.29	4.67	3	Vertical	165	1.27	-	45.04
AV	4.80405G	39.33	54.00	-14.67	4.67	3	Vertical	165	1.27	-	34.66

BT-LE(1Mbps)

04/09/2019

2402MHz_TX

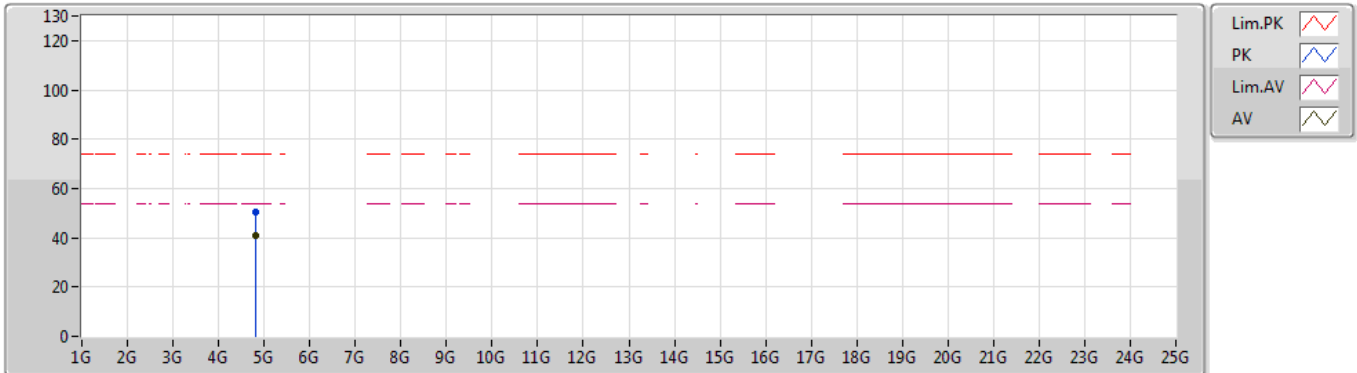

EUT Y_1TX
Setting 8
03-W-3
FSP(100080)

Type	Freq (Hz)	Level (dBuV/m)	Limit (dBuV/m)	Margin (dB)	Factor (dB)	Dist (m)	Condition	Azimuth (°)	Height (m)	Comment	Raw (dBuV)
PK	4.80348G	50.46	74.00	-23.54	4.67	3	Horizontal	5	1.63	-	45.79
AV	4.80348G	40.65	54.00	-13.35	4.67	3	Horizontal	5	1.63	-	35.98

BT-LE(1Mbps)

04/09/2019

2440MHz_TX

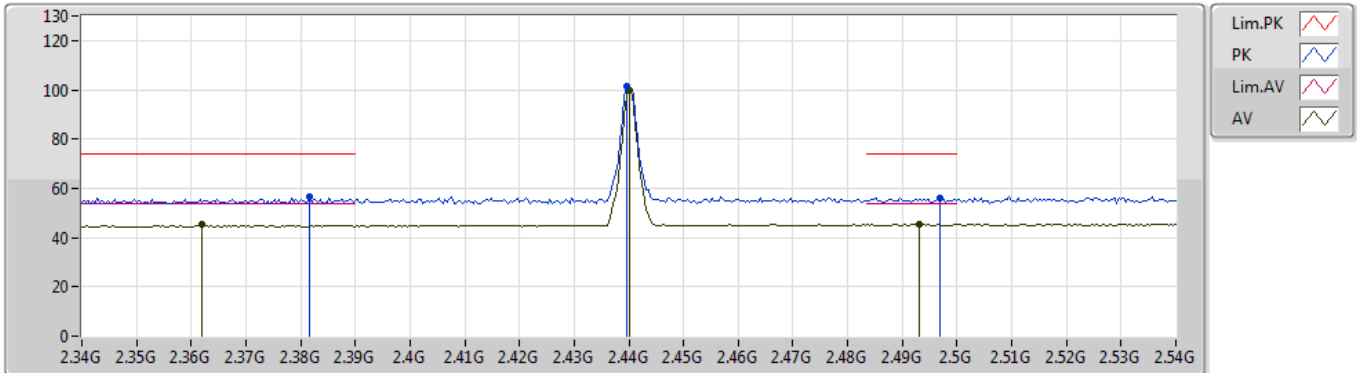

EUT Y_1TX
Setting 8
03-E-2
FSP(100080)

Type	Freq (Hz)	Level (dBuV/m)	Limit (dBuV/m)	Margin (dB)	Factor (dB)	Dist (m)	Condition	Azimuth (°)	Height (m)	Comment	Raw (dBuV)
PK	2.3816G	56.44	74.00	-17.56	31.91	3	Vertical	188	1.50	-	24.53
AV	2.362G	45.24	54.00	-8.76	31.85	3	Vertical	188	1.50	-	13.39
PK	2.4396G	101.37	Inf	-Inf	32.10	3	Vertical	188	1.50	-	69.27
AV	2.44G	99.83	Inf	-Inf	32.10	3	Vertical	188	1.50	-	67.73
PK	2.4968G	56.00	74.00	-18.00	32.30	3	Vertical	188	1.50	-	23.70
AV	2.4932G	45.36	54.00	-8.64	32.29	3	Vertical	188	1.50	-	13.07

BT-LE(1Mbps)

04/09/2019

2440MHz_TX

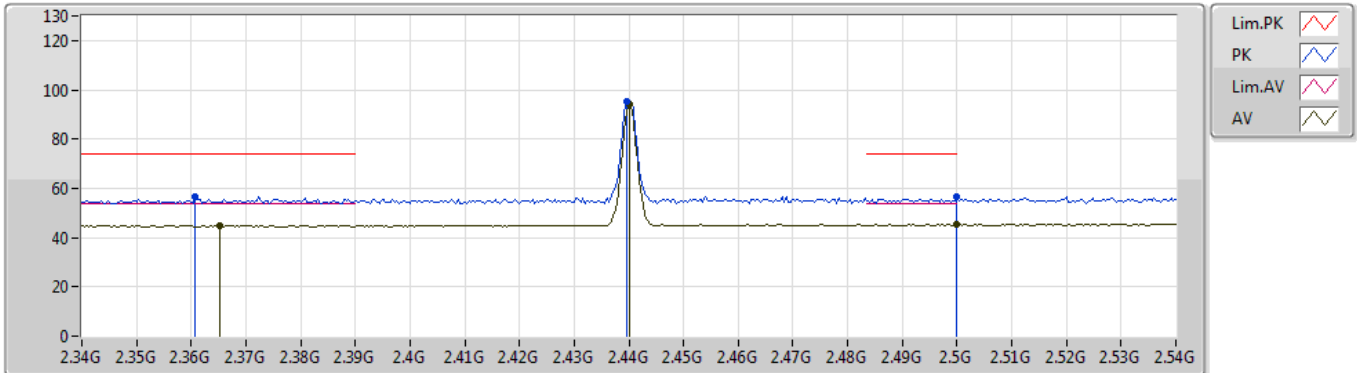

EUT Y_1TX
Setting 8
03-E-2
FSP(100080)

Type	Freq (Hz)	Level (dBuV/m)	Limit (dBuV/m)	Margin (dB)	Factor (dB)	Dist (m)	Condition	Azimuth (°)	Height (m)	Comment	Raw (dBuV)
PK	2.3608G	56.44	74.00	-17.56	31.85	3	Horizontal	119	1.21	-	24.59
AV	2.3652G	44.88	54.00	-9.12	31.86	3	Horizontal	119	1.21	-	13.02
PK	2.4396G	95.42	Inf	-Inf	32.10	3	Horizontal	119	1.21	-	63.32
AV	2.44G	93.89	Inf	-Inf	32.10	3	Horizontal	119	1.21	-	61.79
PK	2.5G	56.38	74.00	-17.62	32.31	3	Horizontal	119	1.21	-	24.07
AV	2.5G	45.31	54.00	-8.69	32.31	3	Horizontal	119	1.21	-	13.00

BT-LE(1Mbps)

04/09/2019

2440MHz_TX

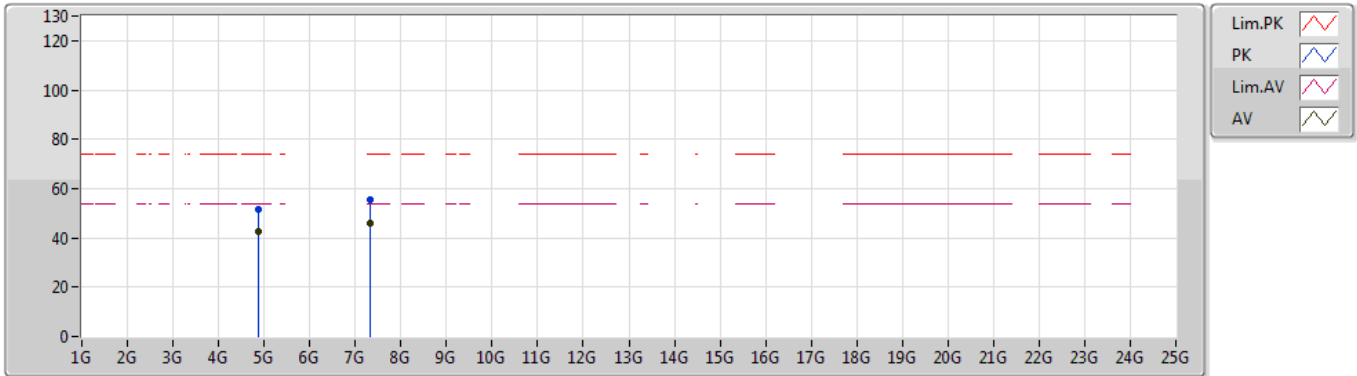

EUT_Y_1TX
Setting 8
03-E-2
FSP(100080)

Type	Freq (Hz)	Level (dBuV/m)	Limit (dBuV/m)	Margin (dB)	Factor (dB)	Dist (m)	Condition	Azimuth (°)	Height (m)	Comment	Raw (dBuV)
PK	4.87958G	51.64	74.00	-22.36	4.81	3	Vertical	177	1.01	-	46.83
AV	4.88G	42.36	54.00	-11.64	4.81	3	Vertical	177	1.01	-	37.55
PK	7.31916G	55.40	74.00	-18.60	9.01	3	Vertical	156	1.05	-	46.39
AV	7.31934G	45.88	54.00	-8.12	9.01	3	Vertical	156	1.05	-	36.87

BT-LE(1Mbps)

04/09/2019

2440MHz_TX

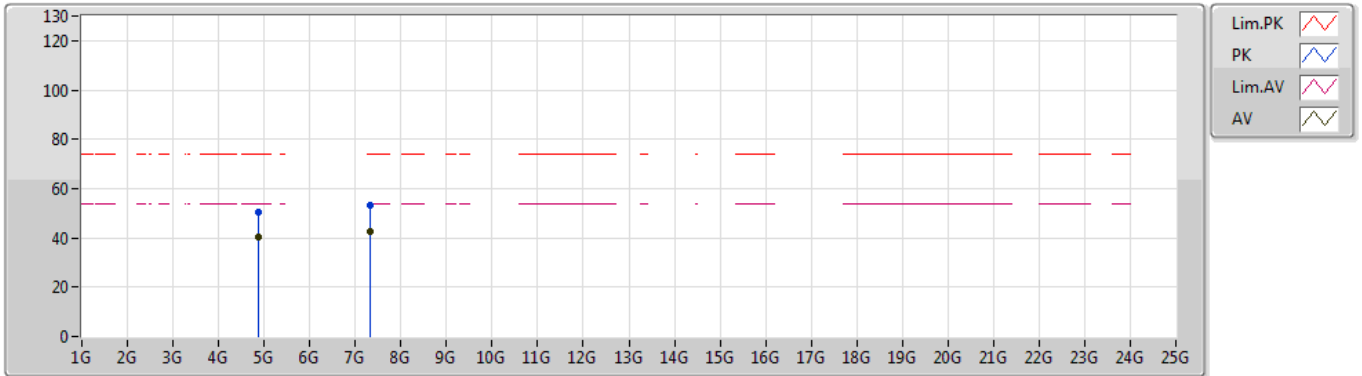

EUT_Y_1TX
Setting 8
03-E-2
FSP(100080)

Type	Freq (Hz)	Level (dBuV/m)	Limit (dBuV/m)	Margin (dB)	Factor (dB)	Dist (m)	Condition	Azimuth (°)	Height (m)	Comment	Raw (dBuV)
PK	4.87946G	50.24	74.00	-23.76	4.81	3	Horizontal	112	1.06	-	45.43
AV	4.88012G	40.35	54.00	-13.65	4.81	3	Horizontal	112	1.06	-	35.54
PK	7.31939G	53.06	74.00	-20.94	9.01	3	Horizontal	251	1.24	-	44.05
AV	7.3194G	42.39	54.00	-11.61	9.01	3	Horizontal	251	1.24	-	33.38

BT-LE(1Mbps)

04/09/2019

2480MHz_TX

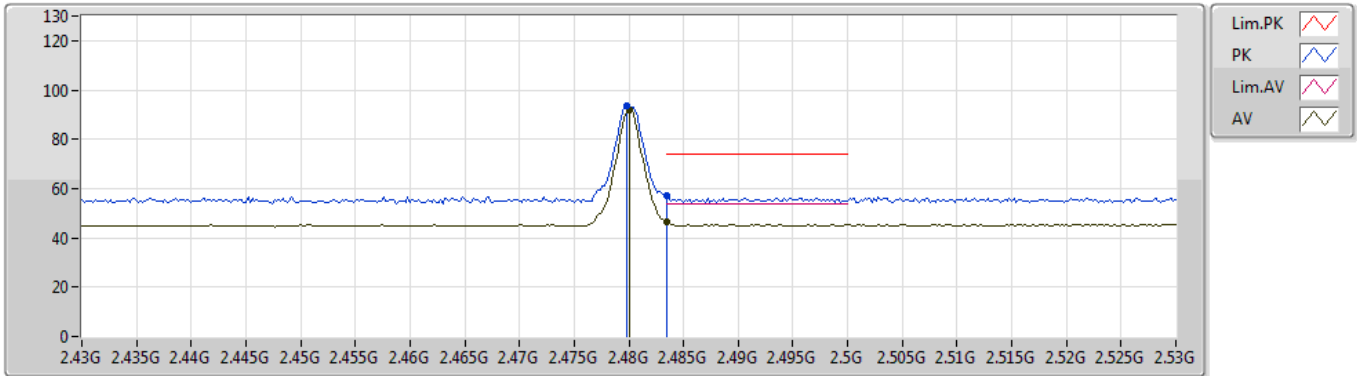

EUT_Y_1TX
Setting 8
03-W-3
FSP(100080)

Type	Freq (Hz)	Level (dBuV/m)	Limit (dBuV/m)	Margin (dB)	Factor (dB)	Dist (m)	Condition	Azimuth (°)	Height (m)	Comment	Raw (dBuV)
PK	2.4798G	93.45	Inf	-Inf	32.24	3	Vertical	31	1.58	-	61.21
AV	2.48G	91.77	Inf	-Inf	32.24	3	Vertical	31	1.58	-	59.53
PK	2.4835G	57.27	74.00	-16.73	32.25	3	Vertical	31	1.58	-	25.02
AV	2.4835G	46.50	54.00	-7.50	32.25	3	Vertical	31	1.58	-	14.25

BT-LE(1Mbps)

04/09/2019

2480MHz_TX

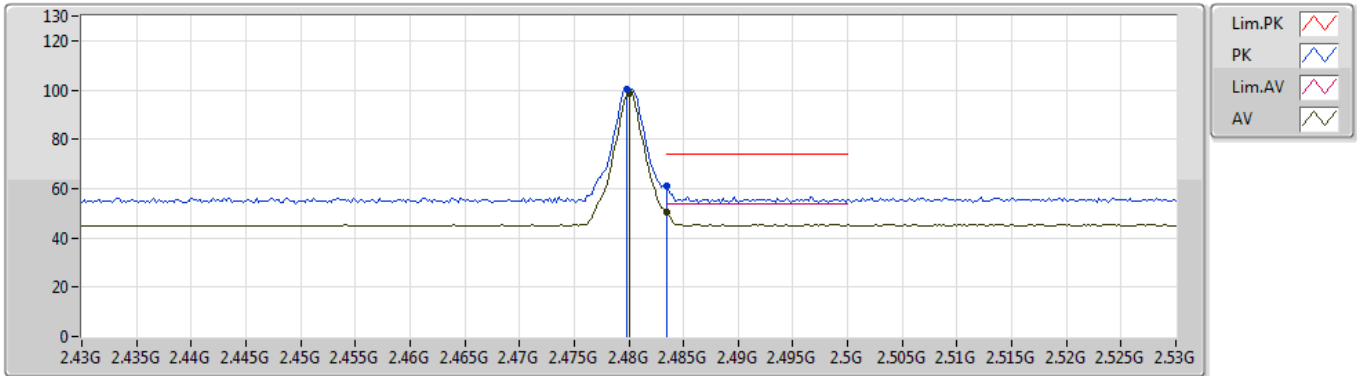

EUT Y_1TX
Setting 8
03-W-3
FSP(100080)

Type	Freq (Hz)	Level (dBuV/m)	Limit (dBuV/m)	Margin (dB)	Factor (dB)	Dist (m)	Condition	Azimuth (°)	Height (m)	Comment	Raw (dBuV)
PK	2.4798G	100.25	Inf	-Inf	32.24	3	Horizontal	90	1.18	-	68.01
AV	2.48G	98.73	Inf	-Inf	32.24	3	Horizontal	90	1.18	-	66.49
PK	2.4835G	60.80	74.00	-13.20	32.25	3	Horizontal	90	1.18	-	28.55
AV	2.4835G	50.43	54.00	-3.57	32.25	3	Horizontal	90	1.18	-	18.18

BT-LE(1Mbps)

04/09/2019

2480MHz_TX

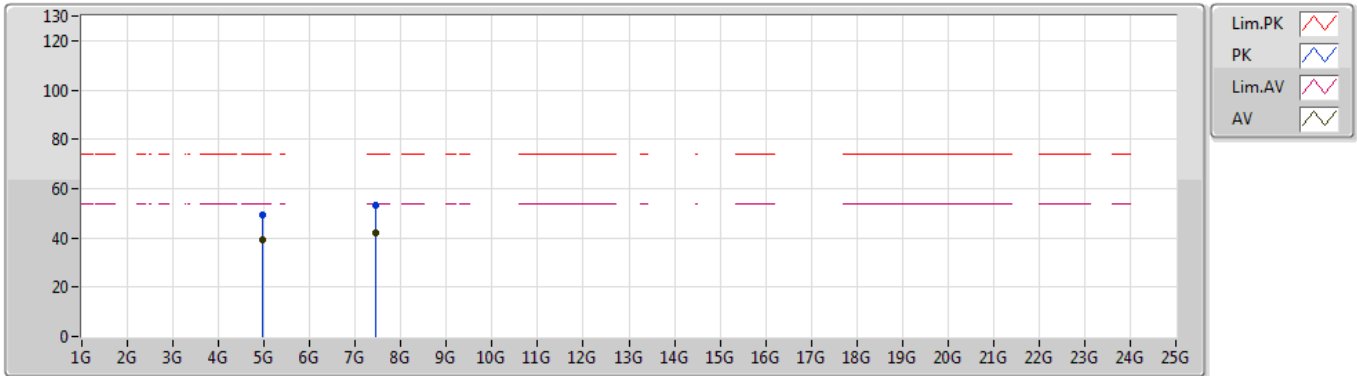

EUT_Y_1TX
Setting 8
03-W-3
FSP(100080)

Type	Freq (Hz)	Level (dBuV/m)	Limit (dBuV/m)	Margin (dB)	Factor (dB)	Dist (m)	Condition	Azimuth (°)	Height (m)	Comment	Raw (dBuV)
PK	4.95952G	49.50	74.00	-24.50	4.96	3	Vertical	170	1.34	-	44.54
AV	4.95983G	39.02	54.00	-14.98	4.96	3	Vertical	170	1.34	-	34.06
PK	7.43979G	53.40	74.00	-20.60	9.14	3	Vertical	32	2.09	-	44.26
AV	7.43923G	42.11	54.00	-11.89	9.14	3	Vertical	32	2.09	-	32.97

BT-LE(1Mbps)

04/09/2019

2480MHz_TX

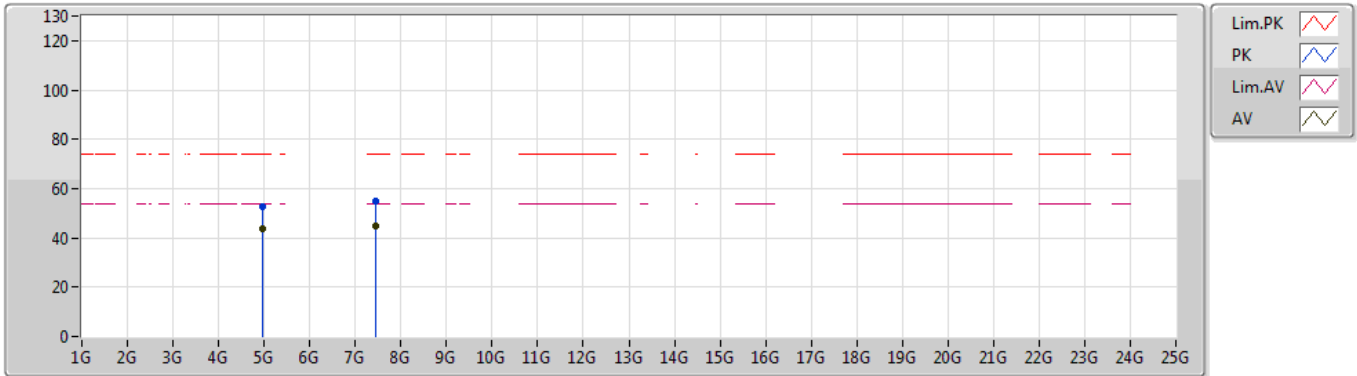

EUT_Y_1TX
Setting 8
03-W-3
FSP(100080)

Type	Freq (Hz)	Level (dBuV/m)	Limit (dBuV/m)	Margin (dB)	Factor (dB)	Dist (m)	Condition	Azimuth (°)	Height (m)	Comment	Raw (dBuV)
PK	4.96042G	52.49	74.00	-21.51	4.96	3	Horizontal	33	1.84	-	47.53
AV	4.95996G	43.65	54.00	-10.35	4.96	3	Horizontal	33	1.84	-	38.69
PK	7.4392G	54.69	74.00	-19.31	9.14	3	Horizontal	34	1.47	-	45.55
AV	7.43949G	44.87	54.00	-9.13	9.14	3	Horizontal	34	1.47	-	35.73