



FCC RADIO TEST REPORT

FCC ID : YZKOAP100
Equipment : DUAL-BAND 11AC WAVE 2 OUTDOOR AP
Brand Name : Edgecore
Model Name : OAP100
Applicant : Edgecore Networks Corporation
 No. 1, Creation Rd. III, Science Park Hsin Chu
 30077, Taiwan
Manufacturer (1) : Accton Technology Corporation
 No. 1, Creation Rd. III, Science Park Hsin Chu
 30077, Taiwan
Manufacturer (2) : Accton Technology Corporation Zhunan Factory
 1F.& 5F, No. 1, Keyi St., Zhunan Township, Miaoli
 County 350 - TAIWAN
Standard : 47 CFR FCC Part 15.407

The product was received on Jul. 27, 2019, and testing was started from Aug. 15, 2019 and completed on Oct. 09, 2019. We, SPORTON INTERNATIONAL INC. EMC & Wireless Communications Laboratory, would like to declare that the tested sample has been evaluated in accordance with the procedures given in ANSI C63.10-2013 and shown compliance with the applicable technical standards.

The report must not be used by the client to claim product certification, approval, or endorsement by TAF or any agency of government.

The test results in this report apply exclusively to the tested model / sample. Without written approval of SPORTON INTERNATIONAL INC. EMC & Wireless Communications Laboratory, the test report shall not be reproduced except in full.

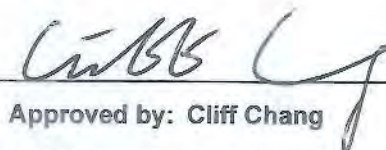
 Approved by: Cliff Chang

SPORTON INTERNATIONAL INC. EMC & Wireless Communications Laboratory
 No. 52, Huaya 1st Rd., Guishan Dist., Taoyuan City, Taiwan (R.O.C.)



Table of Contents

History of this test report.....3

Summary of Test Result.....4

1 General Description5

1.1 Information.....5

1.2 Applicable Standards8

1.3 Testing Location Information.....8

1.4 Measurement Uncertainty8

2 Test Configuration of EUT9

2.1 Test Channel Mode9

2.2 The Worst Case Measurement Configuration.....10

2.3 EUT Operation during Test11

2.4 Accessories12

2.5 Support Equipment.....12

2.6 Test Setup Diagram13

3 Transmitter Test Result16

3.1 AC Power-line Conducted Emissions16

3.2 Emission Bandwidth18

3.3 Maximum Conducted Output Power19

3.4 Peak Power Spectral Density.....21

3.5 Unwanted Emissions.....24

4 Test Equipment and Calibration Data28

Appendix A. Test Results of AC Power-line Conducted Emissions

Appendix B. Test Results of Emission Bandwidth

Appendix C. Test Results of Maximum Conducted Output Power

Appendix D. Test Results of Peak Power Spectral Density

Appendix E. Test Results of Unwanted Emissions

Appendix F. Test Photos

Photographs of EUT v01



Summary of Test Result

Report Clause	Ref Std. Clause	Test Items	Result (PASS/FAIL)	Remark
1.1.2	15.203	Antenna Requirement	PASS	-
3.1	15.207	AC Power-line Conducted Emissions	PASS	-
3.2	15.407(a)	Emission Bandwidth	PASS	-
3.3	15.407(a)	Maximum Conducted Output Power	PASS	-
3.4	15.407(a)	Peak Power Spectral Density	PASS	-
3.5	15.407(b)	Unwanted Emissions	PASS	-

Declaration of Conformity:

The test results with all measurement uncertainty excluded are presented in accordance with the regulation limits or requirements declared by manufacturers.

Comments and Explanations:

The declared of product specification for EUT presented in the report are provided by the manufacturer, and the manufacturer takes all the responsibilities for the accuracy of product specification.

Reviewed by: **Sam Chen**

Report Producer: **Sandy Chuang**



1 General Description

1.1 Information

1.1.1 RF General Information

Frequency Range (MHz)	IEEE Std. 802.11	Ch. Frequency (MHz)	Channel Number
5150-5250	a, n (HT20), ac (VHT20)	5180-5240	36-48 [4]
5725-5850		5745-5825	149-165 [5]
5150-5250	n (HT40), ac (VHT40),	5190-5230	38-46 [2]
5725-5850		5755-5795	151-159 [2]
5150-5250	ac (VHT80)	5210	42 [1]
5725-5850		5775	155 [1]

Band	Mode	BWch (MHz)	Nant
5.15-5.25GHz	802.11a	20	2TX
5.15-5.25GHz	802.11ac VHT20	20	2TX
5.15-5.25GHz	802.11ac VHT40	40	2TX
5.15-5.25GHz	802.11ac VHT80	80	2TX
5.725-5.85GHz	802.11a	20	2TX
5.725-5.85GHz	802.11ac VHT20	20	2TX
5.725-5.85GHz	802.11ac VHT40	40	2TX
5.725-5.85GHz	802.11ac VHT80	80	2TX

Note:

- ♦ 11a, HT20 and HT40 use a combination of OFDM-BPSK, QPSK, 16QAM, 64QAM modulation.
- ♦ VHT20, VHT40, VHT80 use a combination of OFDM-BPSK, QPSK, 16QAM, 64QAM, 256QAM modulation.
- ♦ BWch is the nominal channel bandwidth.
- ♦ Nss-Min is the minimum number of spatial streams.
- ♦ Nant is the number of outputs. e.g., 2(2,3) means have 2 outputs for port 2 and port 3. 2 means have 2 outputs for port 1 and port 2.



1.1.2 Antenna Information

Ant.	Port	Brand	Model Name	Antenna Type	Connector	Gain (dBi)
1	1/2	ACCTON	OAP 100 -1018-EC	Patch Array Antenna	I-PEX	Note 1
2	1/2	ACCTON	OAP 100 -1018-EC	Patch Array Antenna	I-PEX	
3	1/2	ACCTON	OAP 100 -1018-EC	PCB Dipole Antenna	I-PEX	
4	1/2	ACCTON	OAP 100 -1018-EC	Patch Array Antenna	I-PEX	
5	1	ACCTON	OAP100-1018-EC	PCB Dipole Antenna	I-PEX	
6	1	Master Wave	OAP100-1018-EC	Chip Antenna	I-PEX	
7	1	Master Wave	8615 Outdoor Antenna	External omni antenna	I-PEX	

Note 1

Ant.	Port	Gain (dBi)				
		2.4GHz	5GHz	Bluetooth	GPS	LTE
1	1	-	15.5	-	-	-
2	2	-	11.1	-	-	-
3	1	5.6	-	-	-	-
4	2	10.4	-	-	-	-
5	1	-	-	4.5	-	-
6	1	-	-	-	3.76	-
7	1	-	-	-	-	2.87

Note 2: The above information was declared by manufacturer.

<For 2.4GHz Band>

For IEEE 802.11b/g/n mode (2TX/2RX)

Port 1 and Port 2 can be used as transmitting/receiving antenna.

Port 1 and Port 2 could transmit/receive simultaneously.

<For 5GHz Band>

Because Ant. 1 and Ant. 2 are the same type antennas, only the higher gain antenna “Ant. 1” was tested and recorded in the report.

For IEEE 802.11a/n/ac mode (2TX/2RX)

Port 1 and Port 2 can be used as transmitting/receiving antenna.

Port 1 and Port 2 could transmit/receive simultaneously.

<Bluetooth>

Only Port 1 can be used as transmitting/receiving antenna.



1.1.3 Mode Test Duty Cycle

Mode	DC	DCF(dB)	T(s)	VBW(Hz) ≥ 1/T
802.11a	0.96	0.18	2.068m	1k
802.11ac VHT20	0.985	0.07	n/a (DC>=0.98)	n/a (DC>=0.98)
802.11ac VHT40	0.97	0.13	2.44m	1k
802.11ac VHT80	0.938	0.28	1.153m	1k

Note:

- ◆ DC is Duty Cycle.
- ◆ DCF is Duty Cycle Factor.

1.1.4 EUT Operational Condition

EUT Power Type	From PoE or DC 24V		
Beamforming Function	<input type="checkbox"/> With beamforming	<input checked="" type="checkbox"/> Without beamforming	
Function	<input checked="" type="checkbox"/> Outdoor P2M	<input type="checkbox"/> Indoor P2M	
	<input type="checkbox"/> Fixed P2P	<input type="checkbox"/> Client	
Test Software Version	QRCT V3.0.264.0		

Note: The above information was declared by manufacturer.



1.2 Applicable Standards

According to the specifications of the manufacturer, the EUT must comply with the requirements of the following standards:

- ◆ 47 CFR FCC Part 15
- ◆ ANSI C63.10-2013
- ◆ FCC KDB 789033 D02 v02r01
- ◆ FCC KDB 662911 D01 v02r01
- ◆ FCC KDB 412172 D01 v01r01
- ◆ FCC KDB 414788 D01 v01r01

1.3 Testing Location Information

Testing Location		
<input type="checkbox"/>	HWA YA	ADD : No. 52, Huaya 1st Rd., Guishan Dist., Taoyuan City, Taiwan (R.O.C.) TEL : 886-3-327-3456 FAX : 886-3-327-0973
<input checked="" type="checkbox"/>	JHUBEI	ADD : No.8, Lane 724, Bo-ai St., Jhubei City, HsinChu County 302, Taiwan, R.O.C. TEL : 886-3-656-9065 FAX : 886-3-656-9085

Test Condition	Test Site No.	Test Engineer	Test Environment	Test Date
RF Conducted	TH02-CB	Owen Hsu	24.5-25.5°C / 56-58 %	Aug. 15, 2019~ Sep. 05, 2019
Radiated (Below 1GHz)	03CH05-CB	Eason Chen	24.9-25.9°C / 59-63 %	Aug. 23, 2019~ Oct. 07, 2019
Radiated (Above 1GHz)	03CH03-CB	Eason Chen	23.8-26.2°C / 59-62 %	Aug. 23, 2019~ Oct. 07, 2019
AC Conduction	CO01-CB	Rick Yeh	25-26°C / 47-48 %	Oct. 09, 2019

Test site Designation No. TW0006 with FCC.
Test site registered number IC 4086D with Industry Canada.

1.4 Measurement Uncertainty

ISO/IEC 17025 requires that an estimate of the measurement uncertainties associated with the emissions test results be included in the report. The measurement uncertainties given below are based on a 95% confidence level (based on a coverage factor (k=2))

Test Items	Uncertainty	Remark
Conducted Emission (150kHz ~ 30MHz)	2.0 dB	Confidence levels of 95%
Radiated Emission (30MHz ~ 1,000MHz)	4.3 dB	Confidence levels of 95%
Radiated Emission (1GHz ~ 18GHz)	4.3 dB	Confidence levels of 95%
Radiated Emission (18GHz ~ 40GHz)	5.1 dB	Confidence levels of 95%
Conducted Emission	2.4 dB	Confidence levels of 95%
Output Power Measurement	1.5 dB	Confidence levels of 95%
Power Density Measurement	2.4 dB	Confidence levels of 95%
Bandwidth Measurement	2%	Confidence levels of 95%



2 Test Configuration of EUT

2.1 Test Channel Mode

Mode	PowerSetting
802.11a_Nss1,(6Mbps)_2TX	-
5180MHz	8
5200MHz	8
5240MHz	8
5745MHz	15.5
5785MHz	16
5825MHz	16
802.11ac VHT20_Nss1,(MCS0)_2TX	-
5180MHz	8
5200MHz	8
5240MHz	8
5745MHz	15
5785MHz	15.5
5825MHz	16
802.11ac VHT40_Nss1,(MCS0)_2TX	-
5190MHz	8
5230MHz	8
5755MHz	15.5
5795MHz	15.5
802.11ac VHT80_Nss1,(MCS0)_2TX	-
5210MHz	8
5775MHz	15.5

Note:

- ♦ VHT20/VHT40 covers HT20/HT40, due to same modulation. The power setting for 802.11n HT20 and HT40 are the same or lower than 802.11ac VHT20 and VHT40.



2.2 The Worst Case Measurement Configuration

The Worst Case Mode for Following Conformance Tests	
Tests Item	AC power-line conducted emissions
Condition	AC power-line conducted measurement for line and neutral
Operating Mode	CTX
1	LTE Band 1+Ant. 3_2.4GHz+PoE 1
2	LTE Band 1+Ant. 3_DC 24V
Mode 1 has been evaluated to be the worst case among Mode 1~2, thus measurement for Mode 3 ~ 5 will follow this same test mode.	
3	LTE Band 1+Ant. 4_2.4GHz+PoE 1
4	LTE Band 1+Ant. 1_5GHz+PoE 1
5	LTE Band 1+Ant. 5_Bluetooth LE+PoE 1
For operating mode 1 is the worst case and it was record in this test report.	

The Worst Case Mode for Following Conformance Tests	
Tests Item	Emission Bandwidth Maximum Conducted Output Power Peak Power Spectral Density Unwanted Emissions
Test Condition	Conducted measurement at transmit chains



The Worst Case Mode for Following Conformance Tests	
Tests Item	Unwanted Emissions
Test Condition	Radiated measurement If EUT consist of multiple antenna assembly (multiple antenna are used in EUT regardless of spatial multiplexing MIMO configuration), the radiated test should be performed with highest antenna gain of each antenna type.
Operating Mode < 1GHz	CTX
The EUT can be placed in Y-axis and Z-axis. EUT Y axis has been evaluated to be the worst case at Unwanted Emissions <Above 1GHz>; thus, the measurement will follow this same test configuration.	
1	LTE Band 1+Ant. 3_2.4GHz+PoE 2 - EUT in Y axis
2	LTE Band 1+Ant. 3_DC 24V - EUT in Y axis
Mode 1 has been evaluated to be the worst case among Mode 1~2, thus measurement for Mode 3 ~ 5 will follow this same test mode.	
3	LTE Band 1+Ant. 4_2.4GHz+PoE 2 - EUT in Y axis
4	LTE Band 1+Ant. 1_5GHz+PoE 2 - EUT in Y axis
5	LTE Band 1+Ant. 5_Bluetooth LE+PoE 2 - EUT in Y axis
For operating mode 5 is the worst case and it was record in this test report.	
Operating Mode > 1GHz	CTX
The EUT can be placed in Y-axis and Z-axis. After evaluating, Y-axis was the worst case, so the test will follow this same test configuration.	
1	EUT in Y axis

The Worst Case Mode for Following Conformance Tests	
Tests Item	Simultaneous Transmission Analysis - Co-location RF Exposure Evaluation
Operating Mode	
1	WLAN 2.4GHz + WLAN 5GHz
Refer to Sporton Test Report No.: FA921805 for Co-location RF Exposure Evaluation.	

Note: The PoE below are for measurement only, would not be marketed.

The PoE information as below:

Support Unit	Brand	Model Number
PoE 1	PowerDsine	PD-3501G/AC
PoE 2	GME	GME40B-480135FDA

2.3 EUT Operation during Test

The EUT was programmed to be in continuously transmitting mode.



2.4 Accessories

Wall-mounted rack*1

2.5 Support Equipment

For AC Conduction:

Support Equipment				
No.	Equipment	Brand Name	Model Name	FCC ID
A	PoE 1	PowerDsine	PD-3501G/AC	N/A
B	LTE module	QUECTEL	EC25-J	N/A
C	LAN NB	DELL	E6430	N/A

For Radiated:

Support Equipment				
No.	Equipment	Brand Name	Model Name	FCC ID
A	PoE 2	GME	GME40B-480135FDA	N/A
B	NB	DELL	E4300	N/A

For RF Conducted:

Support Equipment				
No.	Equipment	Brand Name	Model Name	FCC ID
A	NB	DELL	E4300	N/A
B	PoE 2	GME	GME40B-480135FDA	N/A

2.6 Test Setup Diagram

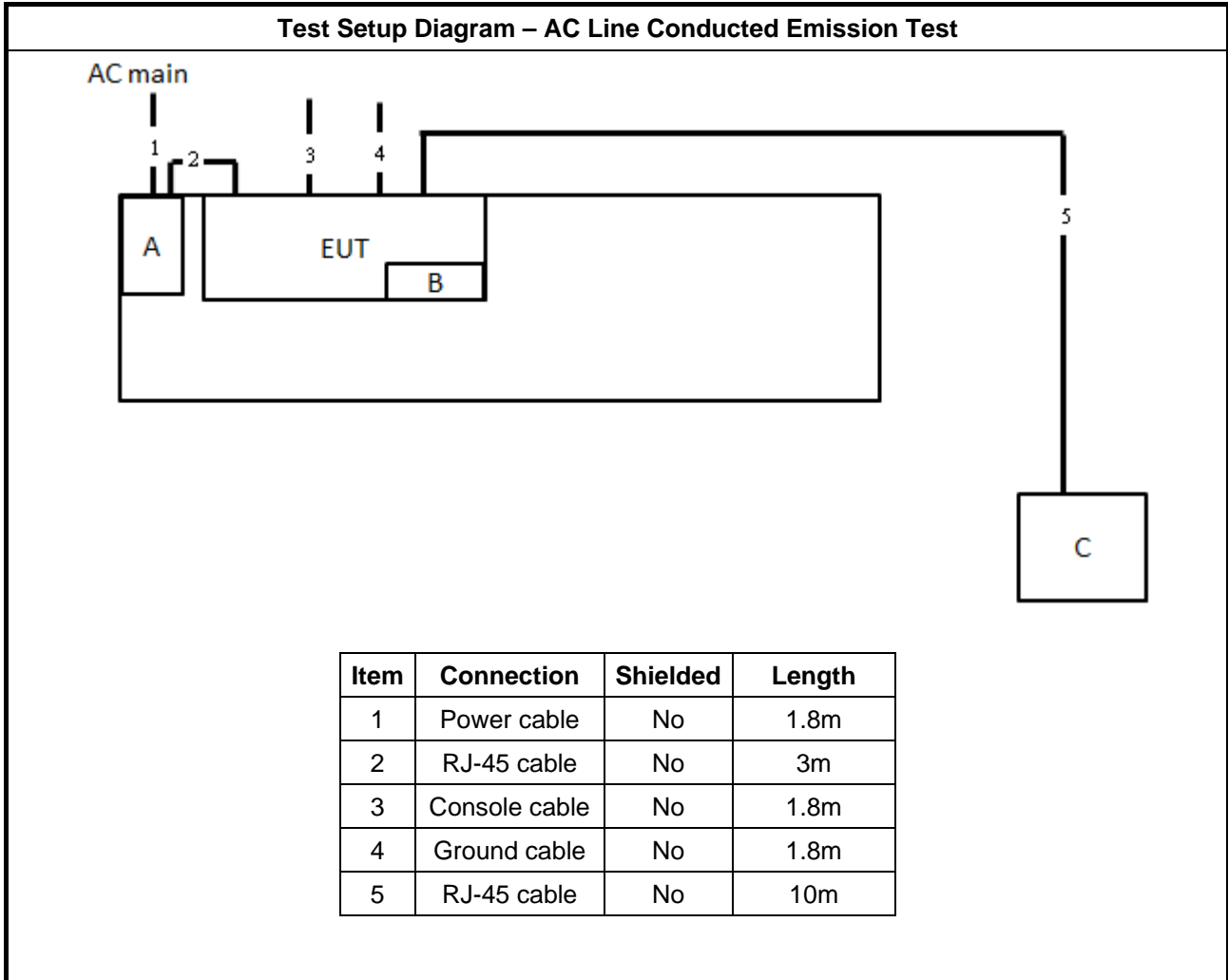



Test Setup Diagram - Radiated Test < 1GHz

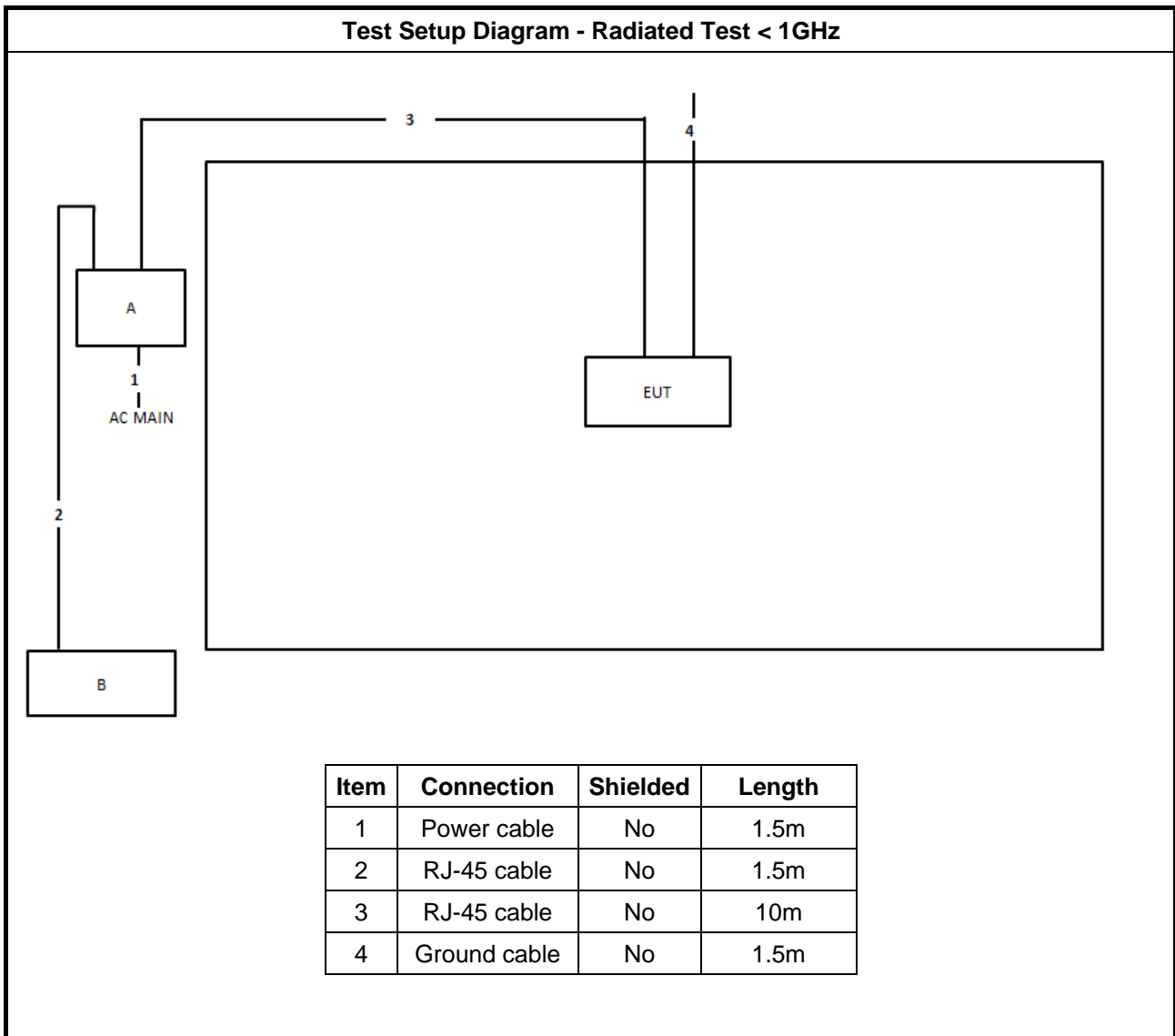



Test Setup Diagram - Radiated Test > 1GHz

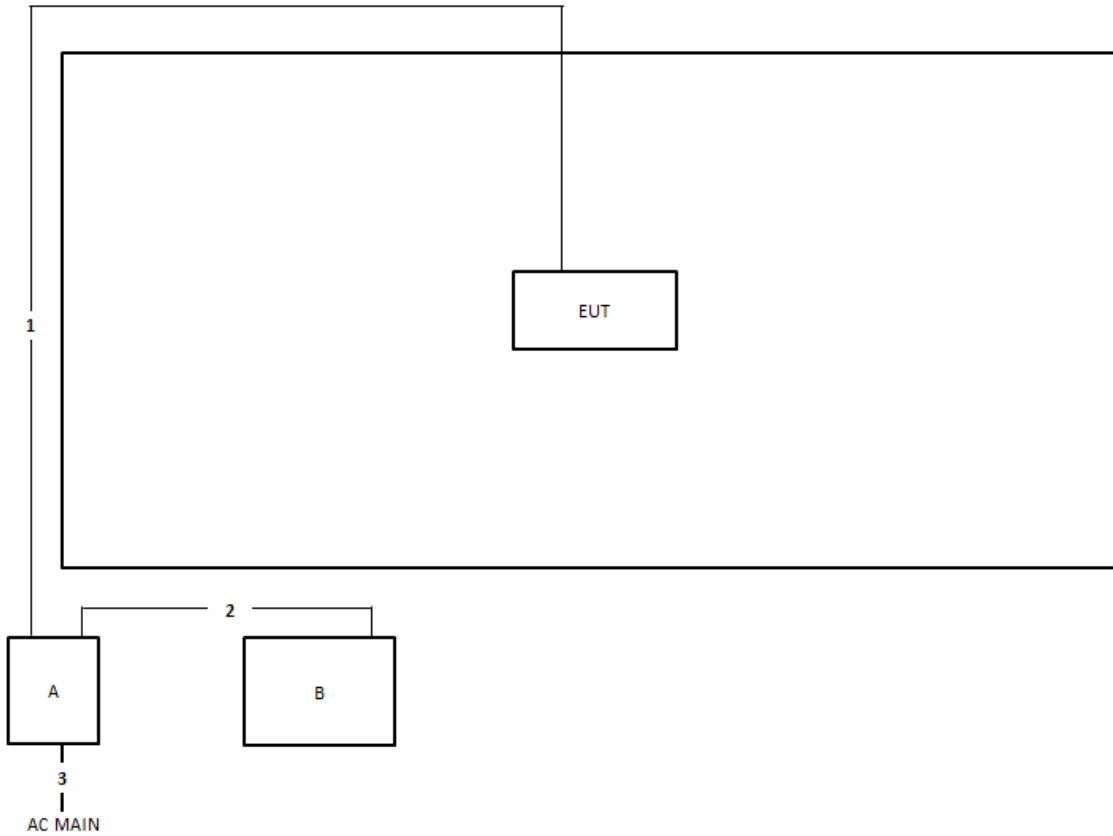

Item	Connection	Shielded	Length
1	RJ-45 cable	No	10m
2	RJ-45 cable	No	1.5m
3	Power cable	No	1.5m



3 Transmitter Test Result

3.1 AC Power-line Conducted Emissions

3.1.1 AC Power-line Conducted Emissions Limit

AC Power-line Conducted Emissions Limit		
Frequency Emission (MHz)	Quasi-Peak	Average
0.15-0.5	66 - 56 *	56 - 46 *
0.5-5	56	46
5-30	60	50

Note 1: * Decreases with the logarithm of the frequency.

3.1.2 Measuring Instruments

Refer a test equipment and calibration data table in this test report.

3.1.3 Test Procedures

Test Method
<input checked="" type="checkbox"/> Refer as ANSI C63.10-2013, clause 6.2 for AC power-line conducted emissions.

3.1.4 Test Setup

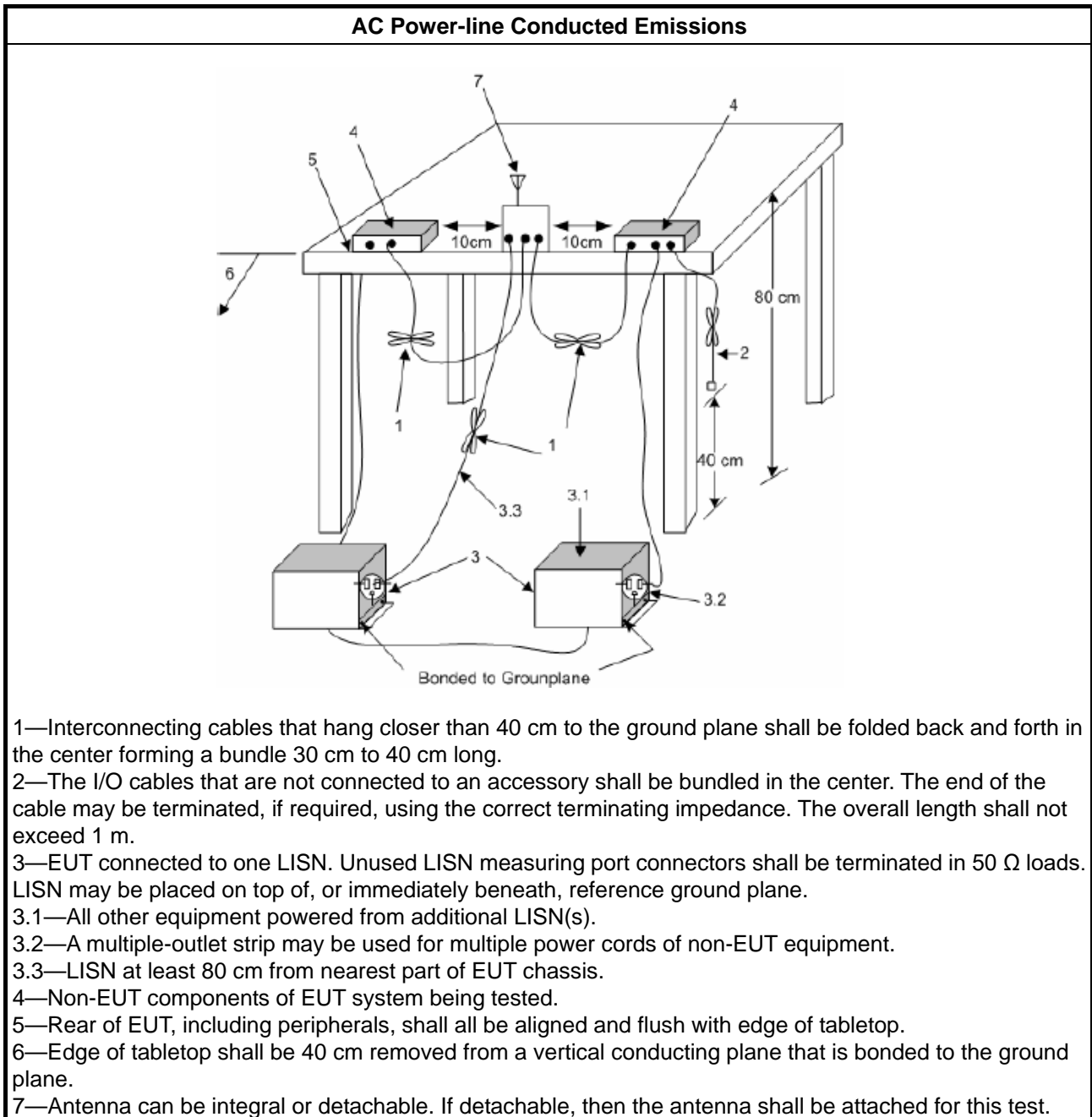

3.1.5 Test Result of AC Power-line Conducted Emissions

Refer as Appendix A

3.2 Emission Bandwidth

3.2.1 Emission Bandwidth Limit

Emission Bandwidth Limit	
UNII Devices	
<input checked="" type="checkbox"/>	For the 5.15-5.25 GHz band, N/A
<input type="checkbox"/>	For the 5.25-5.35 GHz band, the maximum conducted output power shall not exceed the lesser of 250 mW or 11 dBm + 10 log B, where B is the 26 dB emission bandwidth in MHz.
<input type="checkbox"/>	For the 5.47-5.725 GHz band, the maximum conducted output power shall not exceed the lesser of 250 mW or 11 dBm + 10 log B, where B is the 26 dB emission bandwidth in MHz.
<input checked="" type="checkbox"/>	For the 5.725-5.85 GHz band, 6 dB emission bandwidth \geq 500kHz.
LE-LAN Devices	
<input type="checkbox"/>	For the band 5.15-5.25 GHz, the maximum e.i.r.p. shall not exceed 200 mW or 10 + 10 log B, dBm, whichever power is less. B is the 99% emission bandwidth in MHz.
<input type="checkbox"/>	For the 5.25-5.35 GHz band, the maximum e.i.r.p. shall not exceed 1.0 W or 17 + 10 log B, dBm, whichever power is less. B is the 99% emission bandwidth in MHz
<input type="checkbox"/>	For the 5.47-5.6 GHz band and 5.65-5.725 GHz band, the maximum e.i.r.p. shall not exceed 1.0 W or 17 + 10 log B, dBm, whichever power is less. B is the 99% emission bandwidth in MHz
<input type="checkbox"/>	For the 5.725-5.85 GHz band, 6 dB emission bandwidth \geq 500kHz.

3.2.2 Measuring Instruments

Refer a test equipment and calibration data table in this test report.

3.2.3 Test Procedures

Test Method							
<ul style="list-style-type: none"> ▪ For the emission bandwidth shall be measured using one of the options below: <table border="1" style="width: 100%; border-collapse: collapse;"> <tr> <td style="width: 30px;"><input checked="" type="checkbox"/></td> <td>Refer as FCC KDB 789033, clause C for EBW and clause D for OBW measurement.</td> </tr> <tr> <td><input type="checkbox"/></td> <td>Refer as ANSI C63.10, clause 6.9.1 for occupied bandwidth testing.</td> </tr> <tr> <td><input type="checkbox"/></td> <td>Refer as IC RSS-Gen, clause 4.6 for bandwidth testing.</td> </tr> </table> 		<input checked="" type="checkbox"/>	Refer as FCC KDB 789033, clause C for EBW and clause D for OBW measurement.	<input type="checkbox"/>	Refer as ANSI C63.10, clause 6.9.1 for occupied bandwidth testing.	<input type="checkbox"/>	Refer as IC RSS-Gen, clause 4.6 for bandwidth testing.
<input checked="" type="checkbox"/>	Refer as FCC KDB 789033, clause C for EBW and clause D for OBW measurement.						
<input type="checkbox"/>	Refer as ANSI C63.10, clause 6.9.1 for occupied bandwidth testing.						
<input type="checkbox"/>	Refer as IC RSS-Gen, clause 4.6 for bandwidth testing.						

3.2.4 Test Setup

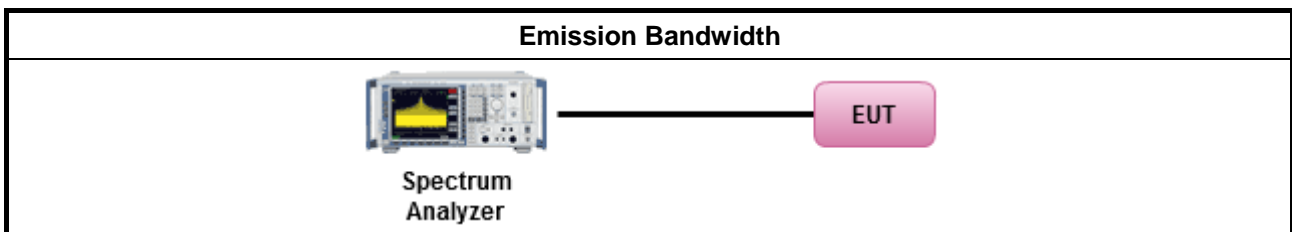

3.2.5 Test Result of Emission Bandwidth

Refer as Appendix B



3.3 Maximum Conducted Output Power

3.3.1 Maximum Conducted Output Power Limit

Maximum Conducted Output Power Limit	
UNII Devices	
<input checked="" type="checkbox"/> For the 5.15-5.25 GHz band:	
	<ul style="list-style-type: none"> ▪ Outdoor AP: the maximum conducted output power (P_{Out}) shall not exceed the lesser of 1 W. If $G_{TX} > 6$ dBi, then $P_{Out} = 30 - (G_{TX} - 6)$. e.i.r.p. at any elevation angle above 30 degrees $\leq 125mW$ [21dBm] ▪ Indoor AP: the maximum conducted output power (P_{Out}) shall not exceed the lesser of 1 W. If $G_{TX} > 6$ dBi, then $P_{Out} = 30 - (G_{TX} - 6)$ ▪ Point-to-point AP: the maximum conducted output power (P_{Out}) shall not exceed the lesser of 1 W. If $G_{TX} > 23$ dBi, then $P_{Out} = 30 - (G_{TX} - 23)$. ▪ Mobile or Portable Client: the maximum conducted output power (P_{Out}) shall not exceed the lesser of 250 mW. If $G_{TX} > 6$ dBi, then $P_{Out} = 24 - (G_{TX} - 6)$.
<input type="checkbox"/> For the 5.25-5.35 GHz band, the maximum conducted output power (P_{Out}) shall not exceed the lesser of 250 mW or $11 \text{ dBm} + 10 \log B$, where B is the 26 dB emission bandwidth in MHz. If $G_{TX} > 6$ dBi, then $P_{Out} = 24 - (G_{TX} - 6)$.	
<input type="checkbox"/> For the 5.47-5.725 GHz band, the maximum conducted output power (P_{Out}) shall not exceed the lesser of 250 mW or $11 \text{ dBm} + 10 \log B$, where B is the 26 dB emission bandwidth in MHz. If $G_{TX} > 6$ dBi, then $P_{Out} = 24 - (G_{TX} - 6)$.	
<input checked="" type="checkbox"/> For the 5.725-5.85 GHz band:	
	<ul style="list-style-type: none"> ▪ Point-to-multipoint systems (P2M): the maximum conducted output power (P_{Out}) shall not exceed the lesser of 1 W. If $G_{TX} > 6$ dBi, then $P_{Out} = 30 - (G_{TX} - 6)$. ▪ Point-to-point systems (P2P): the maximum conducted output power (P_{Out}) shall not exceed the lesser of 1 W.
LE-LAN Devices	
<input type="checkbox"/> For the 5.15-5.25 GHz band, the maximum e.i.r.p. shall not exceed 200 mW or $10 + 10 \log B$, dBm, whichever power is less. B is the 99% emission bandwidth in MHz.	
<input type="checkbox"/> For the 5.25-5.35 GHz band, the maximum e.i.r.p. shall not exceed 1.0 W or $17 + 10 \log B$, dBm, whichever power is less. B is the 99% emission bandwidth in MHz	
<input type="checkbox"/> For the 5.47-5.6 GHz band and 5.65-5.725 GHz band, the maximum e.i.r.p. shall not exceed 1.0 W or $17 + 10 \log B$, dBm, whichever power is less. B is the 99% emission bandwidth in MHz	
<input type="checkbox"/> For the 5.725-5.85 GHz band:	
	<ul style="list-style-type: none"> ▪ Point-to-multipoint systems (P2M): the maximum conducted output power (P_{Out}) shall not exceed the lesser of 1 W. If $G_{TX} > 6$ dBi, then $P_{Out} = 30 - (G_{TX} - 6)$. ▪ Point-to-point systems (P2P): the maximum conducted output power (P_{Out}) shall not exceed the lesser of 1 W.
P_{Out} = maximum conducted output power in dBm, G_{TX} = the maximum transmitting antenna directional gain in dBi.	

3.3.2 Measuring Instruments

Refer a test equipment and calibration data table in this test report.

3.3.3 Test Procedures

Test Method	
<ul style="list-style-type: none"> ▪ Maximum Conducted Output Power 	
Average over on/off periods with duty factor	
<input type="checkbox"/>	Refer as FCC KDB 789033, clause E Method SA-2 (spectral trace averaging).
<input type="checkbox"/>	Refer as FCC KDB 789033, clause E Method SA-2 Alt. (RMS detection with slow sweep speed)
Wideband RF power meter and average over on/off periods with duty factor	
<input checked="" type="checkbox"/>	Refer as FCC KDB 789033, clause E Method PM-G (using an RF average power meter).
<ul style="list-style-type: none"> ▪ For conducted measurement. 	
<ul style="list-style-type: none"> ▪ If the EUT supports multiple transmit chains using options given below: Refer as FCC KDB 662911, In-band power measurements. Using the measure-and-sum approach, measured all transmit ports individually. Sum the power (in linear power units e.g., mW) of all ports for each individual sample and save them. 	
<ul style="list-style-type: none"> ▪ If multiple transmit chains, EIRP calculation could be following as methods: $P_{total} = P_1 + P_2 + \dots + P_n$ (calculated in linear unit [mW] and transfer to log unit [dBm]) $EIRP_{total} = P_{total} + DG$ 	

3.3.4 Test Setup

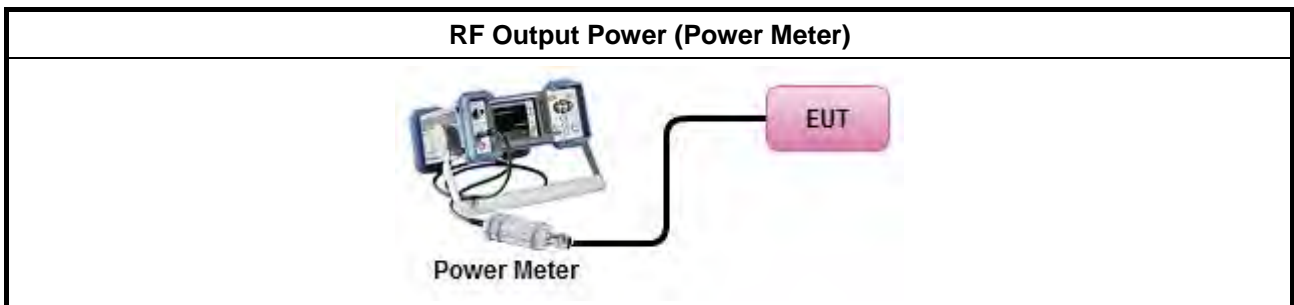

3.3.5 Test Result of Maximum Conducted Output Power

Refer as Appendix C



3.4 Peak Power Spectral Density

3.4.1 Peak Power Spectral Density Limit

Peak Power Spectral Density Limit	
UNII Devices	
<input checked="" type="checkbox"/> For the 5.15-5.25 GHz band:	
<input type="checkbox"/>	<ul style="list-style-type: none"> ▪ Outdoor AP: the peak power spectral density (PPSD) shall not exceed the lesser of 17dBm/MHz. If $G_{TX} > 6$ dBi, then $P_{Out} = 17 - (G_{TX} - 6)$. ▪ Indoor AP: the peak power spectral density (PPSD) shall not exceed the lesser of 17dBm/MHz. If $G_{TX} > 6$ dBi, then $P_{Out} = 17 - (G_{TX} - 6)$. ▪ Point-to-point AP: the peak power spectral density (PPSD) shall not exceed the lesser of 17dBm/MHz. If $G_{TX} > 23$ dBi, then $P_{Out} = 17 - (G_{TX} - 23)$. ▪ Mobile or Portable Client: the peak power spectral density (PPSD) ≤ 11 dBm/MHz. If $G_{TX} > 6$ dBi, then $PPSD = 11 - (G_{TX} - 6)$.
<input type="checkbox"/>	For the 5.25-5.35 GHz band, the peak power spectral density (PPSD) ≤ 11 dBm/MHz. If $G_{TX} > 6$ dBi, then $PPSD = 11 - (G_{TX} - 6)$.
<input type="checkbox"/>	For the 5.47-5.725 GHz band, the peak power spectral density (PPSD) ≤ 11 dBm/MHz. If $G_{TX} > 6$ dBi, then $PPSD = 11 - (G_{TX} - 6)$.
<input checked="" type="checkbox"/> For the 5.725-5.85 GHz band:	
<input type="checkbox"/>	<ul style="list-style-type: none"> ▪ Point-to-multipoint systems (P2M): the peak power spectral density (PPSD) ≤ 30 dBm/500kHz. If $G_{TX} > 6$ dBi, then $PPSD = 30 - (G_{TX} - 6)$. ▪ Point-to-point systems (P2P): the peak power spectral density (PPSD) ≤ 30 dBm/500kHz.
LE-LAN Devices	
<input type="checkbox"/>	For the 5.15-5.25 GHz band, the e.i.r.p. peak power spectral density (PPSD) ≤ 10 dBm/MHz.
<input type="checkbox"/>	For the 5.25-5.35 GHz band, the peak power spectral density (PPSD) ≤ 11 dBm/MHz.
<input type="checkbox"/>	<ul style="list-style-type: none"> ▪ e.i.r.p. greater than 200 mW shall comply with the following e.i.r.p. at different elevations, where θ is the angle above the local horizontal plane (of the Earth) as shown below: -13 dBW/MHz for $0^\circ \leq \theta < 8^\circ$; -13 - 0.716 ($\theta-8$) dBW/MHz for $8^\circ \leq \theta < 40^\circ$ -35.9 - 1.22 ($\theta-40$) dBW/MHz for $40^\circ \leq \theta \leq 45^\circ$; -42 dBW/MHz for $\theta > 45^\circ$
<input type="checkbox"/>	For the 5.47-5.6 GHz band and 5.65-5.725 GHz band, the peak power spectral density (PPSD) ≤ 11 dBm/MHz.
<input type="checkbox"/> For the 5.725-5.85 GHz band:	
<input type="checkbox"/>	<ul style="list-style-type: none"> ▪ Point-to-multipoint systems (P2M): the peak power spectral density (PPSD) ≤ 30 dBm/500kHz. If $G_{TX} > 6$ dBi, then $PPSD = 30 - (G_{TX} - 6)$. ▪ Point-to-point systems (P2P): the peak power spectral density (PPSD) ≤ 30 dBm/500kHz.
<p>PPSD = peak power spectral density that he same method as used to determine the conducted output power shall be used to determine the power spectral density. And power spectral density in dBm/MHz G_{TX} = the maximum transmitting antenna directional gain in dBi.</p>	



3.4.2 Measuring Instruments

Refer a test equipment and calibration data table in this test report.

3.4.3 Test Procedures

Test Method	
<ul style="list-style-type: none"> ▪ Peak power spectral density procedures that the same method as used to determine the conducted output power shall be used to determine the peak power spectral density and use the peak search function on the spectrum analyzer to find the peak of the spectrum. For the peak power spectral density shall be measured using below options: 	
	<input type="checkbox"/> Refer as FCC KDB 789033, F)5) power spectral density can be measured using resolution bandwidths < 1 MHz provided that the results are integrated over 1 MHz bandwidth [duty cycle ≥ 98% or external video / power trigger]
	<input checked="" type="checkbox"/> Refer as FCC KDB 789033, clause E Method SA-1 (spectral trace averaging).
	<input type="checkbox"/> Refer as FCC KDB 789033, clause E Method SA-1 Alt. (RMS detection with slow sweep speed) duty cycle < 98% and average over on/off periods with duty factor
	<input checked="" type="checkbox"/> Refer as FCC KDB 789033, clause E Method SA-2 (spectral trace averaging).
	<input type="checkbox"/> Refer as FCC KDB 789033, clause E Method SA-2 Alt. (RMS detection with slow sweep speed)
<ul style="list-style-type: none"> ▪ For conducted measurement. 	
	<ul style="list-style-type: none"> ▪ If the EUT supports multiple transmit chains using options given below:
	<input checked="" type="checkbox"/> Option 1: Measure and sum the spectra across the outputs. Refer as FCC KDB 662911, In-band power spectral density (PSD). Sample all transmit ports simultaneously using a spectrum analyzer for each transmit port. Where the trace bin-by-bin of each transmit port summing can be performed. (i.e., in the first spectral bin of output 1 is summed with that in the first spectral bin of output 2 and that from the first spectral bin of output 3, and so on up to the NTX output to obtain the value for the first frequency bin of the summed spectrum.). Add up the amplitude (power) values for the different transmit chains and use this as the new data trace.
	<input type="checkbox"/> Option 2: Measure and sum spectral maxima across the outputs. With this technique, spectra are measured at each output of the device at the required resolution bandwidth. The maximum value (peak) of each spectrum is determined. These maximum values are then summed mathematically in linear power units across the outputs. These operations shall be performed separately over frequency spans that have different out-of-band or spurious emission limits,
	<input type="checkbox"/> Option 3: Measure and add 10 log(N) dB, where N is the number of transmit chains. Refer as FCC KDB 662911, In-band power spectral density (PSD). Performed at each transmit chains and each transmit chains shall be compared with the limit have been reduced with 10 log(N). Or each transmit chains shall be add 10 log(N) to compared with the limit.
	<ul style="list-style-type: none"> ▪ If multiple transmit chains, EIRP PPSD calculation could be following as methods: $PPSD_{total} = PPSD_1 + PPSD_2 + \dots + PPSD_n$ (calculated in linear unit [mW] and transfer to log unit [dBm]) $EIRP_{total} = PPSD_{total} + DG$

3.4.4 Test Setup

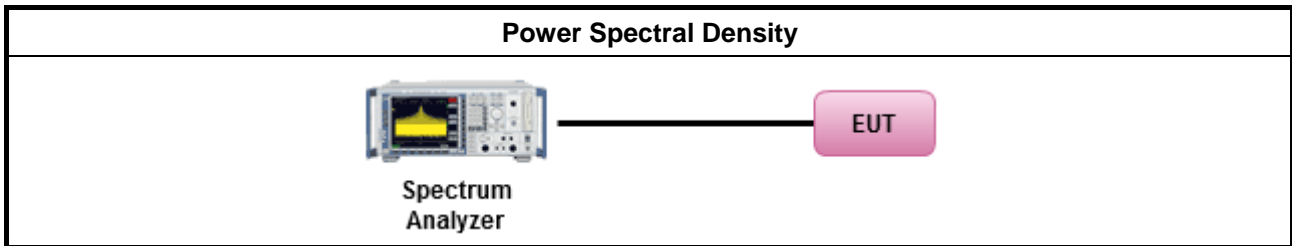

3.4.5 Test Result of Peak Power Spectral Density

Refer as Appendix D



3.5 Unwanted Emissions

3.5.1 Transmitter Unwanted Emissions Limit

Unwanted emissions below 1 GHz and restricted band emissions above 1GHz limit			
Frequency Range (MHz)	Field Strength (uV/m)	Field Strength (dBuV/m)	Measure Distance (m)
0.009~0.490	2400/F(kHz)	48.5 - 13.8	300
0.490~1.705	24000/F(kHz)	33.8 - 23	30
1.705~30.0	30	29	30
30~88	100	40	3
88~216	150	43.5	3
216~960	200	46	3
Above 960	500	54	3

Note 1: Test distance for frequencies at or above 30 MHz, measurements may be performed at a distance other than the limit distance provided they are not performed in the near field and the emissions to be measured can be detected by the measurement equipment. When performing measurements at a distance other than that specified, the results shall be extrapolated to the specified distance using an extrapolation factor of 20 dB/decade (inverse of linear distance for field-strength measurements, inverse of linear distance-squared for power-density measurements).

Note 2: Test distance for frequencies at below 30 MHz, measurements may be performed at a distance closer than the EUT limit distance; however, an attempt should be made to avoid making measurements in the near field. When performing measurements below 30 MHz at a closer distance than the limit distance, the results shall be extrapolated to the specified distance by either making measurements at a minimum of two or more distances on at least one radial to determine the proper extrapolation factor or by using the square of an inverse linear distance extrapolation factor (40 dB/decade). The test report shall specify the extrapolation method used to determine compliance of the EUT.

Note 3: Using the distance of 1m during the test for above 18 GHz, and the test value to correct for the distance factor at 3m.

Un-restricted band emissions above 1GHz Limit	
Operating Band	Limit
<input checked="" type="checkbox"/> 5.15 - 5.25 GHz	e.i.r.p. -27 dBm [68.2 dBuV/m@3m]
<input type="checkbox"/> 5.25 - 5.35 GHz	e.i.r.p. -27 dBm [68.2 dBuV/m@3m]
<input type="checkbox"/> 5.47 - 5.725 GHz	e.i.r.p. -27 dBm [68.2 dBuV/m@3m]
<input checked="" type="checkbox"/> 5.725 - 5.85 GHz	all emissions shall be limited to a level of -27 dBm/MHz at 75 MHz or more above or below the band edge increasing linearly to 10 dBm/MHz at 25 MHz above or below the band edge, and from 25 MHz above or below the band edge increasing linearly to a level of 15.6 dBm/MHz at 5 MHz above or below the band edge, and from 5 MHz above or below the band edge increasing linearly to a level of 27 dBm/MHz at the band edge.

Note 1: Measurements may be performed at a distance other than the limit distance provided they are not performed in the near field and the emissions to be measured can be detected by the measurement equipment. When performing measurements at a distance other than that specified, the results shall be extrapolated to the specified distance using an extrapolation factor of 20 dB/decade (inverse of



linear distance for field-strength measurements, inverse of linear distance-squared for power-density measurements).

3.5.2 Measuring Instruments

Refer a test equipment and calibration data table in this test report.

3.5.3 Test Procedures

Test Method													
	<ul style="list-style-type: none"> ▪ Measurements may be performed at a distance other than the limit distance provided they are not performed in the near field and the emissions to be measured can be detected by the measurement equipment. Measurements shall not be performed at a distance greater than 30 m for frequencies above 30 MHz, unless it can be further demonstrated that measurements at a distance of 30 m or less are impractical. When performing measurements at a distance other than that specified, the results shall be extrapolated to the specified distance using an extrapolation factor of 20 dB/decade (inverse of linear distance for field-strength measurements, inverse of linear distance-squared for power-density measurements). 												
	<ul style="list-style-type: none"> ▪ The average emission levels shall be measured in [duty cycle ≥ 98 or duty factor]. 												
	<ul style="list-style-type: none"> ▪ For the transmitter unwanted emissions shall be measured using following options below: 												
	<ul style="list-style-type: none"> ▪ Refer as FCC KDB 789033, clause G)2) for unwanted emissions into non-restricted bands. ▪ Refer as FCC KDB 789033, clause G)1) for unwanted emissions into restricted bands. 												
	<table border="1" style="width: 100%; border-collapse: collapse;"> <tr> <td style="width: 5%; text-align: center;"><input type="checkbox"/></td> <td>Refer as FCC KDB 789033, G)6) Method AD (Trace Averaging).</td> </tr> <tr> <td style="text-align: center;"><input checked="" type="checkbox"/></td> <td>Refer as FCC KDB 789033, G)6) Method VB (Reduced VBW).</td> </tr> <tr> <td style="text-align: center;"><input type="checkbox"/></td> <td>Refer as ANSI C63.10, clause 11.12.2.5.3 (Reduced VBW). VBW ≥ 1/T, where T is pulse time.</td> </tr> <tr> <td style="text-align: center;"><input type="checkbox"/></td> <td>Refer as ANSI C63.10, clause 7.5 average value of pulsed emissions.</td> </tr> <tr> <td style="text-align: center;"><input checked="" type="checkbox"/></td> <td>Refer as FCC KDB 789033, clause G)5) measurement procedure peak limit.</td> </tr> <tr> <td style="text-align: center;"><input type="checkbox"/></td> <td>Refer as ANSI C63.10, clause 4.1.4.2.2 measurement procedure peak limit.</td> </tr> </table>	<input type="checkbox"/>	Refer as FCC KDB 789033, G)6) Method AD (Trace Averaging).	<input checked="" type="checkbox"/>	Refer as FCC KDB 789033, G)6) Method VB (Reduced VBW).	<input type="checkbox"/>	Refer as ANSI C63.10, clause 11.12.2.5.3 (Reduced VBW). VBW ≥ 1/T, where T is pulse time.	<input type="checkbox"/>	Refer as ANSI C63.10, clause 7.5 average value of pulsed emissions.	<input checked="" type="checkbox"/>	Refer as FCC KDB 789033, clause G)5) measurement procedure peak limit.	<input type="checkbox"/>	Refer as ANSI C63.10, clause 4.1.4.2.2 measurement procedure peak limit.
<input type="checkbox"/>	Refer as FCC KDB 789033, G)6) Method AD (Trace Averaging).												
<input checked="" type="checkbox"/>	Refer as FCC KDB 789033, G)6) Method VB (Reduced VBW).												
<input type="checkbox"/>	Refer as ANSI C63.10, clause 11.12.2.5.3 (Reduced VBW). VBW ≥ 1/T, where T is pulse time.												
<input type="checkbox"/>	Refer as ANSI C63.10, clause 7.5 average value of pulsed emissions.												
<input checked="" type="checkbox"/>	Refer as FCC KDB 789033, clause G)5) measurement procedure peak limit.												
<input type="checkbox"/>	Refer as ANSI C63.10, clause 4.1.4.2.2 measurement procedure peak limit.												
	<ul style="list-style-type: none"> ▪ For radiated measurement. 												
	<table border="1" style="width: 100%; border-collapse: collapse;"> <tr> <td style="width: 5%;"></td> <td> <ul style="list-style-type: none"> ▪ Refer as ANSI C63.10, clause 6.4 for radiated emissions below 30 MHz and test distance is 3m. ▪ Refer as ANSI C63.10, clause 6.5 for radiated emissions 30 MHz to 1 GHz and test distance is 3m. ▪ Refer as ANSI C63.10, clause 6.6 for radiated emissions above 1GHz. </td> </tr> </table>		<ul style="list-style-type: none"> ▪ Refer as ANSI C63.10, clause 6.4 for radiated emissions below 30 MHz and test distance is 3m. ▪ Refer as ANSI C63.10, clause 6.5 for radiated emissions 30 MHz to 1 GHz and test distance is 3m. ▪ Refer as ANSI C63.10, clause 6.6 for radiated emissions above 1GHz. 										
	<ul style="list-style-type: none"> ▪ Refer as ANSI C63.10, clause 6.4 for radiated emissions below 30 MHz and test distance is 3m. ▪ Refer as ANSI C63.10, clause 6.5 for radiated emissions 30 MHz to 1 GHz and test distance is 3m. ▪ Refer as ANSI C63.10, clause 6.6 for radiated emissions above 1GHz. 												
	<ul style="list-style-type: none"> ▪ The any unwanted emissions level shall not exceed the fundamental emission level. 												
	<ul style="list-style-type: none"> ▪ All amplitude of spurious emissions that are attenuated by more than 20 dB below the permissible value has no need to be reported. 												

3.5.4 Test Setup

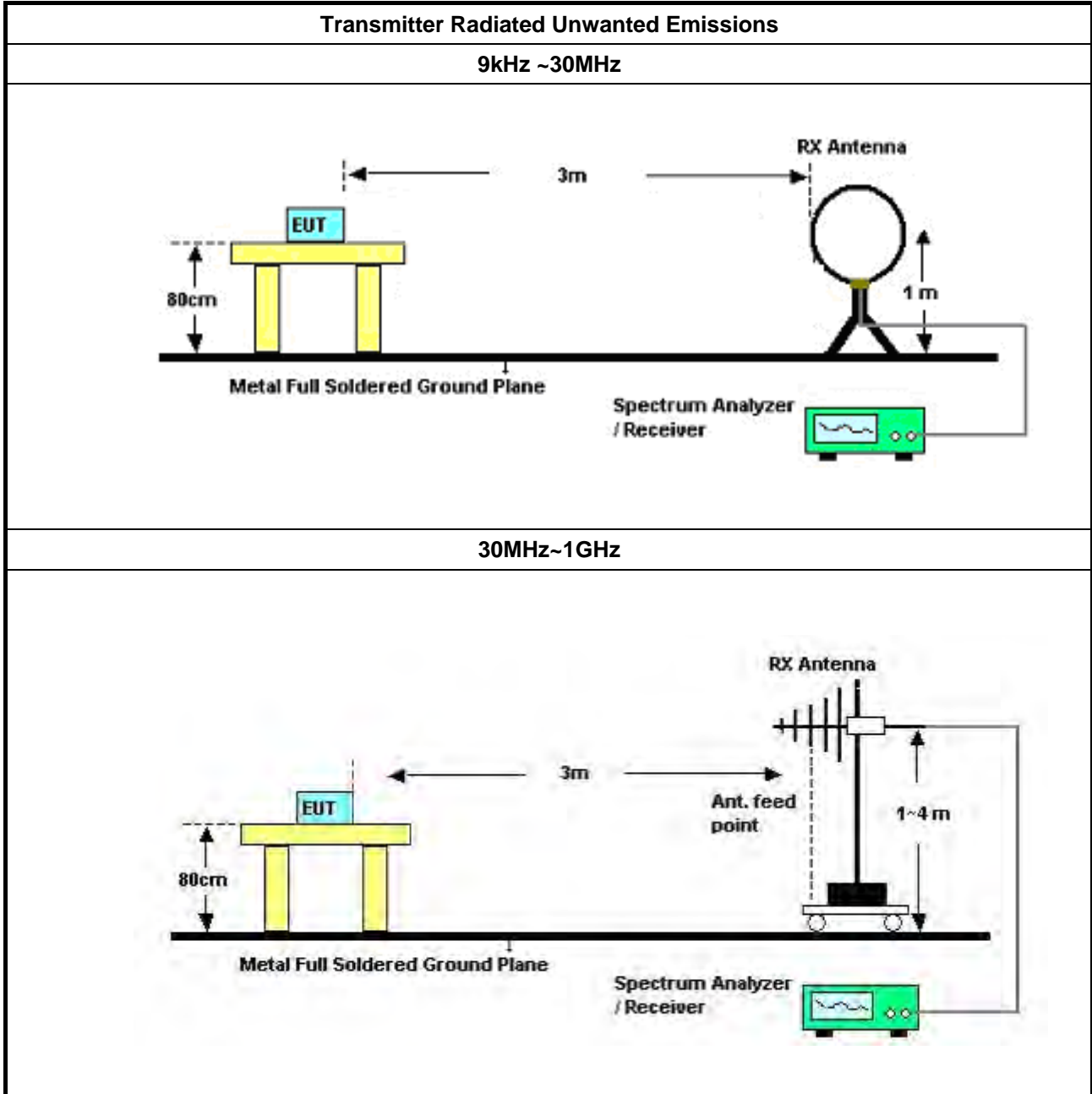

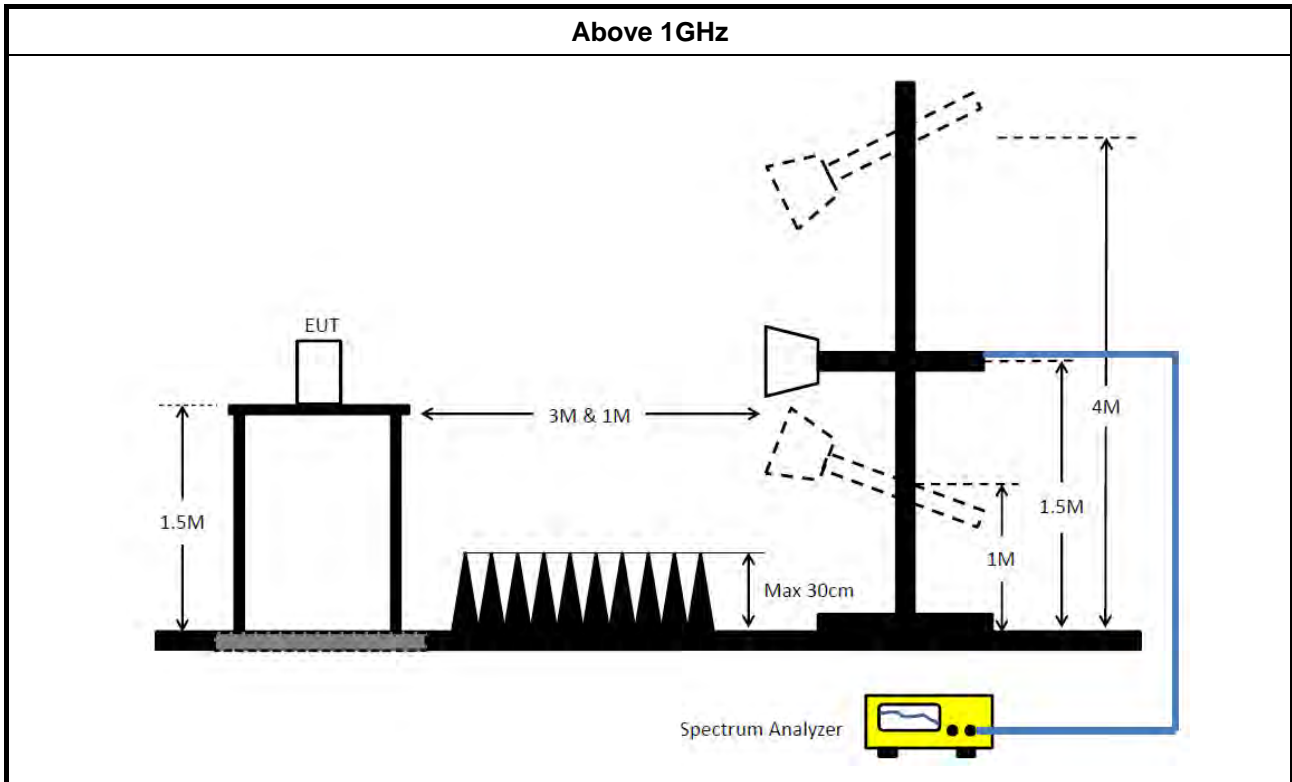

3.5.5 Measurement Results Calculation

The measured Level is calculated using:

Corrected Reading: Antenna Factor + Cable Loss + Read Level - Preamp Factor = Level.

3.5.6 Transmitter Unwanted Emissions (Below 30MHz)

There is a comparison data of both open-field test site and alternative test site - semi-Anechoic chamber according to KDB414788 Radiated Test Site, and the result came out very similar.

All amplitude of spurious emissions that are attenuated by more than 20 dB below the permissible value has no need to be reported.

The radiated emissions were investigated from 9 kHz or the lowest frequency generated within the device, up to the 10 harmonic or 40 GHz, whichever is appropriate.

3.5.7 Test Result of Transmitter Unwanted Emissions

Refer as Appendix E



4 Test Equipment and Calibration Data

Instrument	Manufacturer	Model No.	Serial No.	Characteristics	Calibration Date	Calibration Due Date	Remark
EMI Receiver	Agilent	N9038A	My52260123	9kHz ~ 8.45GHz	Jan. 28, 2019	Jan. 29, 2020	Conduction (CO01-CB)
LISN	F.C.C.	FCC-LISN-50-16-2	04083	150kHz ~ 100MHz	Dec. 24, 2018	Dec. 23, 2019	Conduction (CO01-CB)
LISN	Schwarzbeck	NSLK 8127	8127647	9kHz ~ 30MHz	Jan. 11, 2019	Jan. 10, 2020	Conduction (CO01-CB)
COND Cable	Woken	Cable	Low cable-CO01	9kHz ~ 30MHz	May 21, 2019	May 20, 2020	Conduction (CO01-CB)
Software	Audix	E3	6.120210n	-	N.C.R.	N.C.R.	Conduction (CO01-CB)
Loop Antenna	Teseq	HLA 6120	24155	9kHz - 30 MHz	Mar. 29, 2019	Mar. 28, 2020	Radiation (03CH05-CB)
Bilog Antenna with 6dB Attenuator	TESE & EMCI	CBL 6112D & N-6-06	35236 & AT-N0610	30MHz ~ 2GHz	Mar. 28, 2019	Mar. 27, 2020	Radiation (03CH05-CB)
Pre-Amplifier	EMCI	EMC330N	980331	20MHz ~ 3GHz	May 02, 2019	May 01, 2020	Radiation (03CH05-CB)
Spectrum Analyzer	R&S	FSP40	100304	9kHz ~ 40GHz	Aug. 15, 2019	Aug. 14, 2020	Radiation (03CH05-CB)
EMI Test Receiver	R&S	ESCS	826547/017	9kHz ~ 2.75GHz	May 15, 2019	May 14, 2020	Radiation (03CH05-CB)
RF Cable-low	Woken	RG402	LOW Cable-04+23	30MHz~1GHz	Oct. 08, 2018	Oct. 07, 2019	Radiation (03CH05-CB)
RF Cable-high	Woken	RG402	High Cable-04+23	30MHz~18GHz	Oct. 08, 2018	Oct. 07, 2019	Radiation (03CH05-CB)
Horn Antenna	ETS · Lindgren	3115	6821	750MHz~18GHz	Jan. 24, 2019	Jan. 23, 2020	Radiation (03CH03-CB)
Horn Antenna	Schwarzbeck	BBHA 9170	BBHA9170252	15GHz ~ 40GHz	Jun. 27, 2019	Jun. 26, 2020	Radiation (03CH03-CB)
Pre-Amplifier	Agilent	8449B	3008A02097	1GHz ~ 26.5GHz	Dec. 20, 2018	Dec. 19, 2019	Radiation (03CH03-CB)
Pre-Amplifier	MITEQ	TTA1840-35-HG	1864479	18GHz ~ 40GHz	Jul. 03, 2019	Jul. 02, 2020	Radiation (03CH03-CB)
Spectrum Analyzer	R&S	FSP40	100019	9kHz ~ 40GHz	Jun. 19, 2019	Jun. 18, 2020	Radiation (03CH03-CB)
RF Cable-high	Woken	RG402	High Cable-20+27	1GHz ~ 18GHz	Oct. 07, 2019	Oct. 06, 2020	Radiation (03CH03-CB)
RF Cable-high	Woken	RG402	High Cable-27	1GHz ~ 18GHz	Oct. 07, 2019	Oct. 06, 2020	Radiation (03CH03-CB)
RF Cable-high	Woken	RG402	High Cable-40G#1	18GHz ~ 40 GHz	Jul. 24, 2019	Jul. 23, 2020	Radiation (03CH03-CB)
RF Cable-high	Woken	RG402	High Cable-40G#2	18GHz ~ 40 GHz	Jul. 24, 2019	Jul. 23, 2020	Radiation (03CH03-CB)
Spectrum analyzer	R&S	FSV40	101027	9kHz~40GHz	Jul. 02, 2019	Jul. 01, 2020	Conducted (TH02-CB)



Instrument	Manufacturer	Model No.	Serial No.	Characteristics	Calibration Date	Calibration Due Date	Remark
Power Sensor	Agilent	E9327A	US40442088	50MHz~18GHz	Jan. 15, 2019	Jan. 14, 2020	Conducted (TH02-CB)
Power Meter	Agilent	E4416A	GB41291199	50MHz~18GHz	Jan. 15, 2019	Jan. 14, 2020	Conducted (TH02-CB)
RF Cable-high	Woken	RG402	High Cable-01	1 GHz – 26.5 GHz	Oct. 08, 2018	Oct. 07, 2019	Conducted (TH02-CB)
RF Cable-high	Woken	RG402	High Cable-02	1 GHz – 26.5 GHz	Oct. 08, 2018	Oct. 07, 2019	Conducted (TH02-CB)
RF Cable-high	Woken	RG402	High Cable-3	1 GHz – 26.5 GHz	Oct. 24, 2018	Oct. 23, 2019	Conducted (TH02-CB)
RF Cable-high	Woken	RG402	High Cable-04	1 GHz – 26.5 GHz	Oct. 08, 2018	Oct. 07, 2019	Conducted (TH02-CB)
RF Cable-high	Woken	RG402	High Cable-05	1 GHz – 26.5 GHz	Oct. 08, 2018	Oct. 07, 2019	Conducted (TH02-CB)
RF Cable-high	Woken	RG402	High Cable-01	1 GHz – 26.5 GHz	Oct. 08, 2018	Oct. 07, 2019	Conducted (TH02-CB)

Note: Calibration Interval of instruments listed above is one year.

NCR means Non-Calibration required.



AC Power-line Conducted Emissions Result

Appendix A

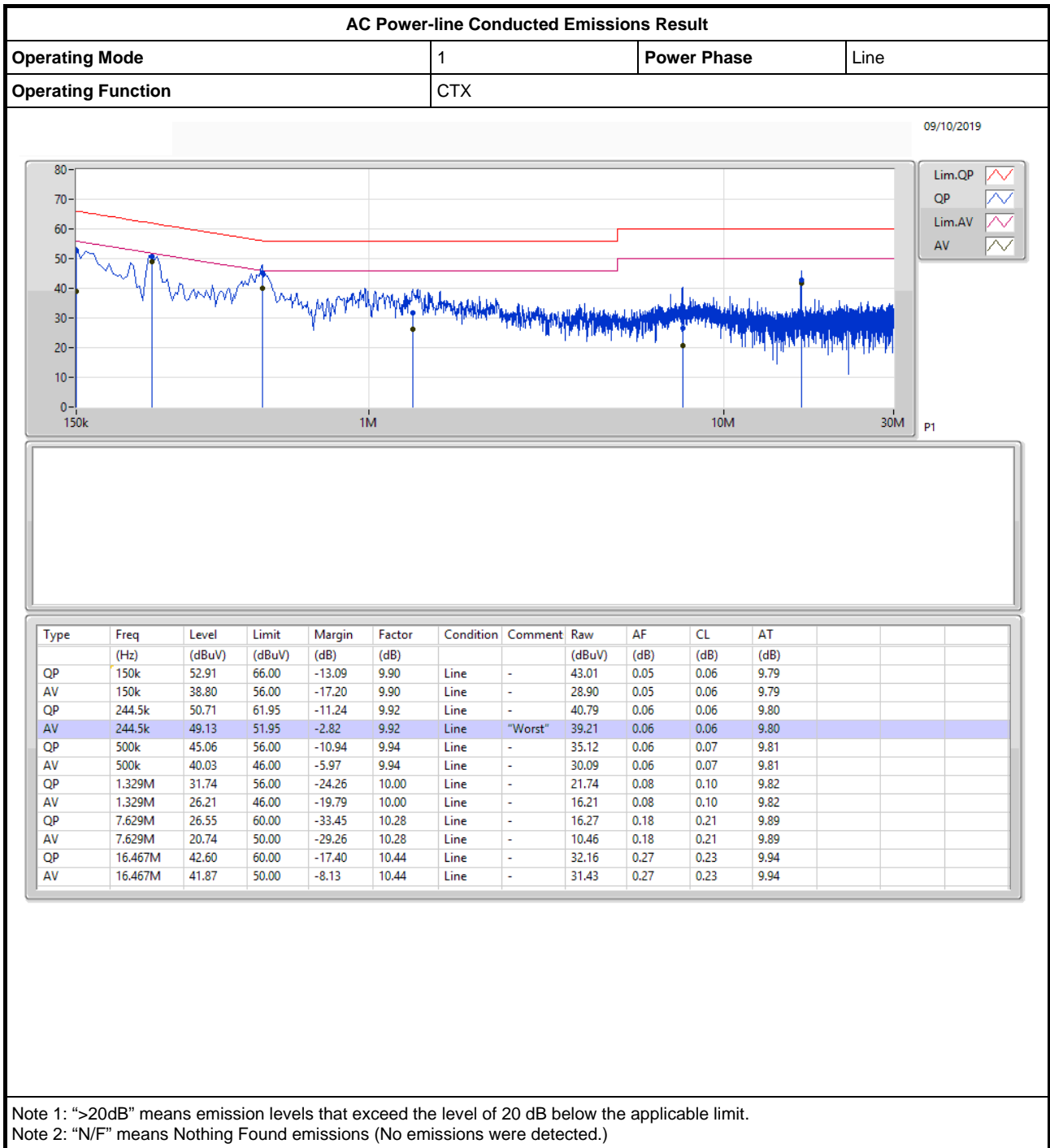



AC Power-line Conducted Emissions Result

Appendix A

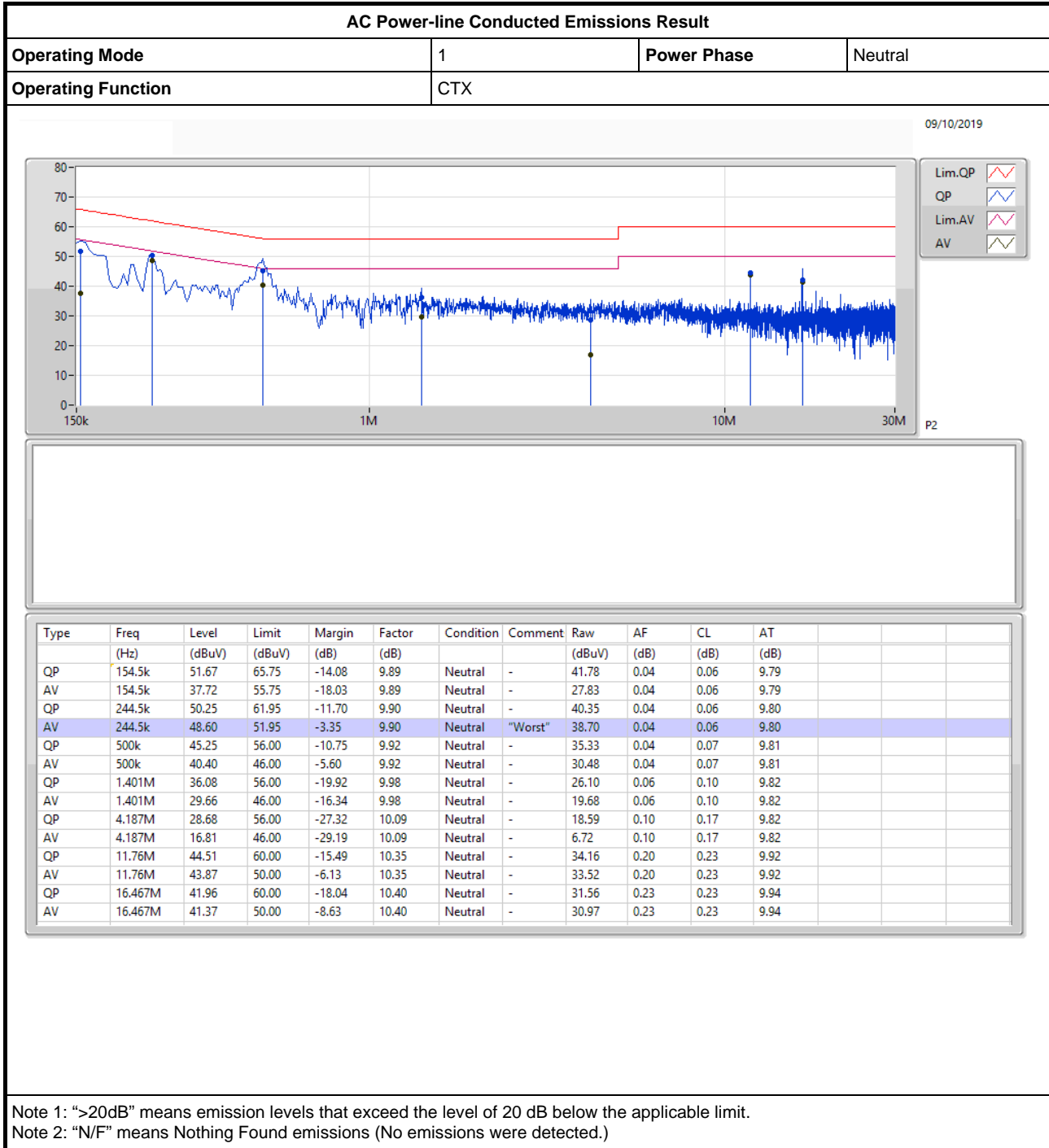



Summary

Mode	Max-N dB (Hz)	Max-OBW (Hz)	ITU-Code	Min-N dB (Hz)	Min-OBW (Hz)
5.15-5.25GHz	-	-	-	-	-
802.11a_Nss1,(6Mbps)_2TX	19.11M	16.442M	16M4D1D	18.87M	16.398M
802.11ac VHT20_Nss1,(MCS0)_2TX	19.83M	17.634M	17M6D1D	19.74M	17.605M
802.11ac VHT40_Nss1,(MCS0)_2TX	39.6M	35.994M	36M0D1D	39.3M	35.905M
802.11ac VHT80_Nss1,(MCS0)_2TX	82.68M	75.649M	75M6D1D	82.56M	75.558M
5.725-5.85GHz	-	-	-	-	-
802.11a_Nss1,(6Mbps)_2TX	16.32M	16.418M	16M4D1D	16.29M	16.385M
802.11ac VHT20_Nss1,(MCS0)_2TX	17.58M	17.623M	17M6D1D	17.52M	17.605M
802.11ac VHT40_Nss1,(MCS0)_2TX	35.22M	36.024M	36M0D1D	34.08M	35.941M
802.11ac VHT80_Nss1,(MCS0)_2TX	75.96M	75.888M	75M9D1D	75.48M	75.796M

Max-N dB = Maximum 6dB down bandwidth for 5.725-5.85GHz band / Maximum 26dB down bandwidth for other band;

Max-OBW = Maximum 99% occupied bandwidth;

Min-N dB = Minimum 6dB down bandwidth for 5.725-5.85GHz band / Maximum 26dB down bandwidth for other band;

Min-OBW = Minimum 99% occupied bandwidth;

Result

Mode	Result	Limit (Hz)	Port 1-N dB (Hz)	Port 1-OBW (Hz)	Port 2-N dB (Hz)	Port 2-OBW (Hz)
802.11a_Nss1,(6Mbps)_2TX	-	-	-	-	-	-
5180MHz	Pass	Inf	19.02M	16.402M	18.9M	16.442M
5200MHz	Pass	Inf	19.11M	16.41M	18.87M	16.398M
5240MHz	Pass	Inf	19.05M	16.409M	18.87M	16.398M
5745MHz	Pass	500k	16.29M	16.399M	16.32M	16.418M
5785MHz	Pass	500k	16.32M	16.404M	16.32M	16.396M
5825MHz	Pass	500k	16.32M	16.385M	16.32M	16.387M
802.11ac VHT20_Nss1,(MCS0)_2TX	-	-	-	-	-	-
5180MHz	Pass	Inf	19.74M	17.608M	19.8M	17.634M
5200MHz	Pass	Inf	19.83M	17.616M	19.77M	17.605M
5240MHz	Pass	Inf	19.74M	17.616M	19.83M	17.624M
5745MHz	Pass	500k	17.52M	17.61M	17.55M	17.606M
5785MHz	Pass	500k	17.55M	17.606M	17.58M	17.623M
5825MHz	Pass	500k	17.55M	17.612M	17.55M	17.605M
802.11ac VHT40_Nss1,(MCS0)_2TX	-	-	-	-	-	-
5190MHz	Pass	Inf	39.42M	35.96M	39.3M	35.905M
5230MHz	Pass	Inf	39.6M	35.994M	39.42M	35.953M
5755MHz	Pass	500k	34.44M	35.971M	35.04M	35.961M
5795MHz	Pass	500k	35.22M	36.024M	34.08M	35.941M
802.11ac VHT80_Nss1,(MCS0)_2TX	-	-	-	-	-	-
5210MHz	Pass	Inf	82.56M	75.558M	82.68M	75.649M
5775MHz	Pass	500k	75.48M	75.796M	75.96M	75.888M

Port X-N dB = Port X 6dB down bandwidth for 5.725-5.85GHz band / 26dB down bandwidth for other band

Port X-OBW = Port X 99% occupied bandwidth;

802.11a_Nss1,(6Mbps)_2TX

EBW

5180MHz

03/09/2019

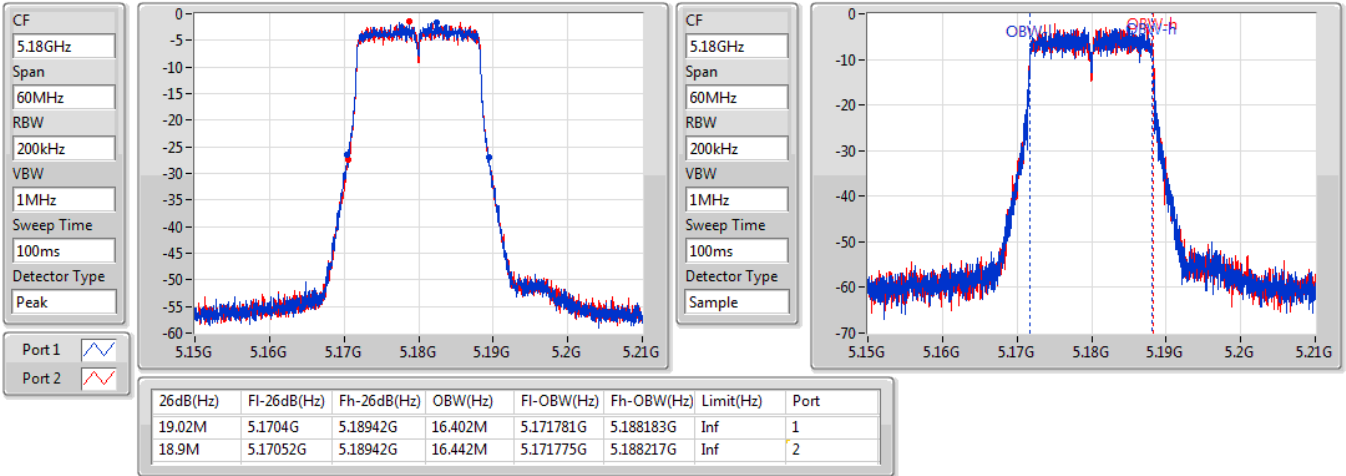

802.11a_Nss1,(6Mbps)_2TX

EBW

5200MHz

03/09/2019

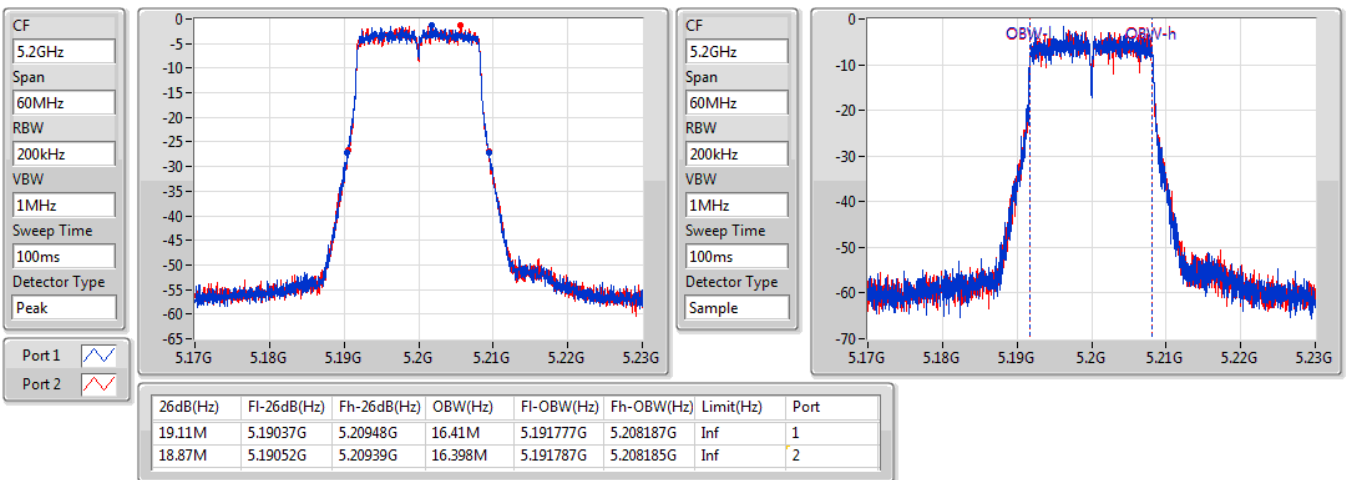

802.11a_Nss1,(6Mbps)_2TX

EBW

5240MHz

03/09/2019

CF
5.24GHz
Span
60MHz
RBW
200kHz
VBW
1MHz
Sweep Time
100ms
Detector Type
Peak

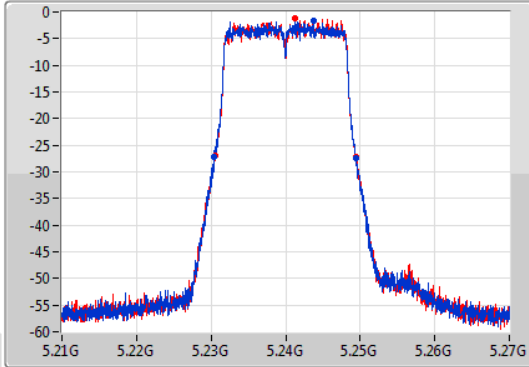

CF
5.24GHz
Span
60MHz
RBW
200kHz
VBW
1MHz
Sweep Time
100ms
Detector Type
Sample

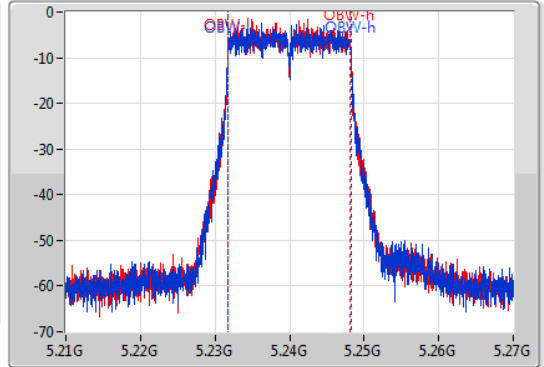

26dB(Hz)	Fl-26dB(Hz)	Fh-26dB(Hz)	OBW(Hz)	Fl-OBW(Hz)	Fh-OBW(Hz)	Limit(Hz)	Port
19.05M	5.23037G	5.24942G	16.409M	5.231782G	5.24819G	Inf	1
18.87M	5.23055G	5.24942G	16.398M	5.231774G	5.248172G	Inf	2

802.11a_Nss1,(6Mbps)_2TX

EBW

5745MHz

24/08/2019

CF
5.745GHz
Span
60MHz
RBW
100kHz
VBW
300kHz
Sweep Time
100ms
Detector Type
Peak

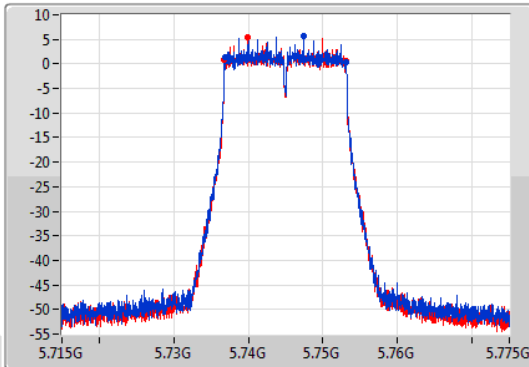

CF
5.745GHz
Span
60MHz
RBW
200kHz
VBW
1MHz
Sweep Time
100ms
Detector Type
Sample

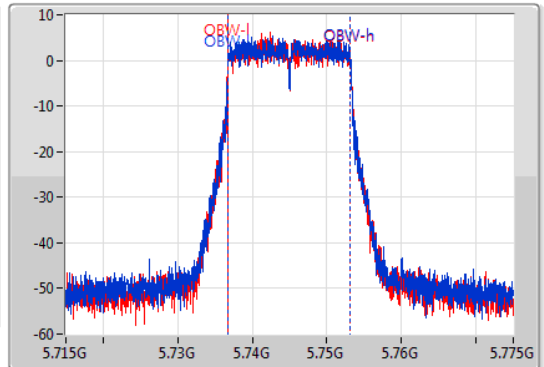

6dB(Hz)	Fl-6dB(Hz)	Fh-6dB(Hz)	OBW(Hz)	Fl-OBW(Hz)	Fh-OBW(Hz)	Limit(Hz)	Port
16.29M	5.73684G	5.75313G	16.399M	5.73678G	5.753178G	500k	1
16.32M	5.73681G	5.75313G	16.418M	5.736768G	5.753186G	500k	2

802.11a_Nss1,(6Mbps)_2TX

EBW

5785MHz

24/08/2019

CF
5.785GHz
Span
60MHz
RBW
100kHz
VBW
300kHz
Sweep Time
100ms
Detector Type
Peak

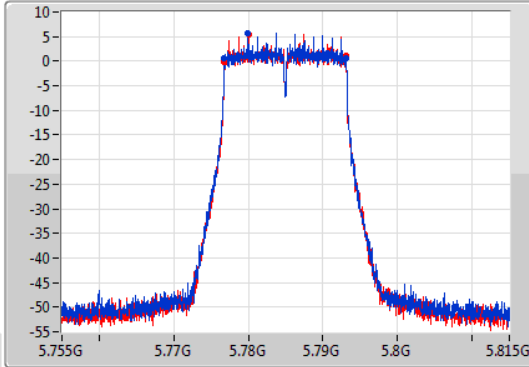

CF
5.785GHz
Span
60MHz
RBW
200kHz
VBW
1MHz
Sweep Time
100ms
Detector Type
Sample

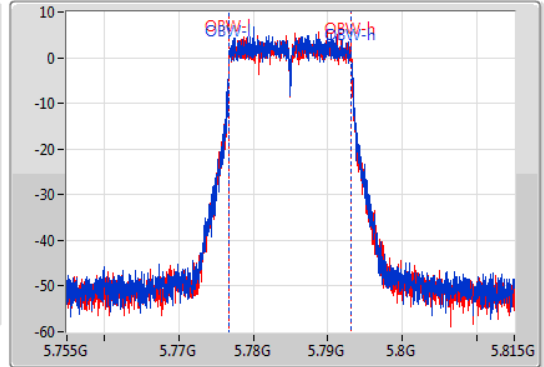

6dB(Hz)	Fl-6dB(Hz)	Fh-6dB(Hz)	OBW(Hz)	Fl-OBW(Hz)	Fh-OBW(Hz)	Limit(Hz)	Port
16.32M	5.77681G	5.79313G	16.404M	5.77677G	5.793175G	500k	1
16.32M	5.77681G	5.79313G	16.396M	5.776773G	5.793169G	500k	2

802.11a_Nss1,(6Mbps)_2TX

EBW

5825MHz

24/08/2019

CF
5.825GHz
Span
60MHz
RBW
100kHz
VBW
300kHz
Sweep Time
100ms
Detector Type
Peak

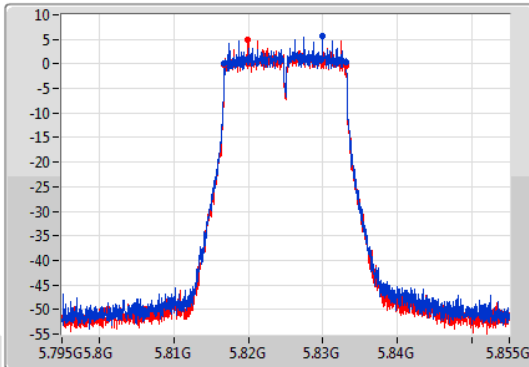

CF
5.825GHz
Span
60MHz
RBW
200kHz
VBW
1MHz
Sweep Time
100ms
Detector Type
Sample

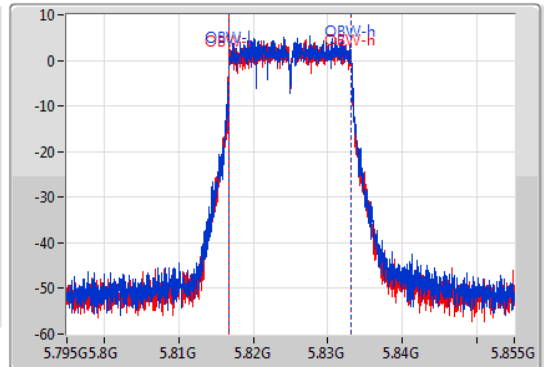

6dB(Hz)	Fl-6dB(Hz)	Fh-6dB(Hz)	OBW(Hz)	Fl-OBW(Hz)	Fh-OBW(Hz)	Limit(Hz)	Port
16.32M	5.81681G	5.83313G	16.385M	5.816786G	5.833171G	500k	1
16.32M	5.81681G	5.83313G	16.387M	5.816785G	5.833172G	500k	2

802.11ac VHT20_Nss1,(MCS0)_2TX

EBW

5180MHz

03/09/2019

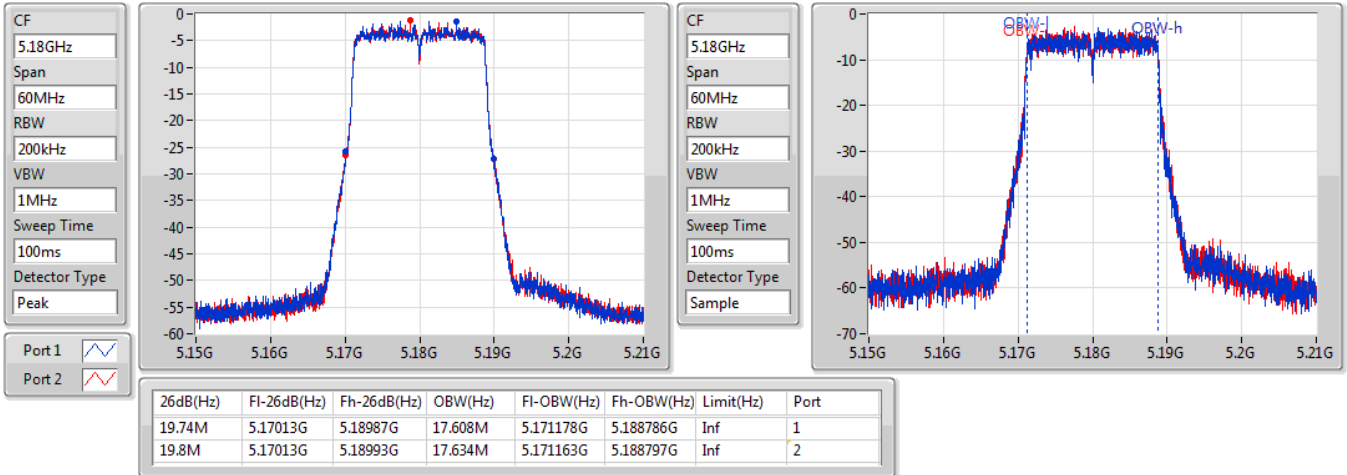

802.11ac VHT20_Nss1,(MCS0)_2TX

EBW

5200MHz

03/09/2019

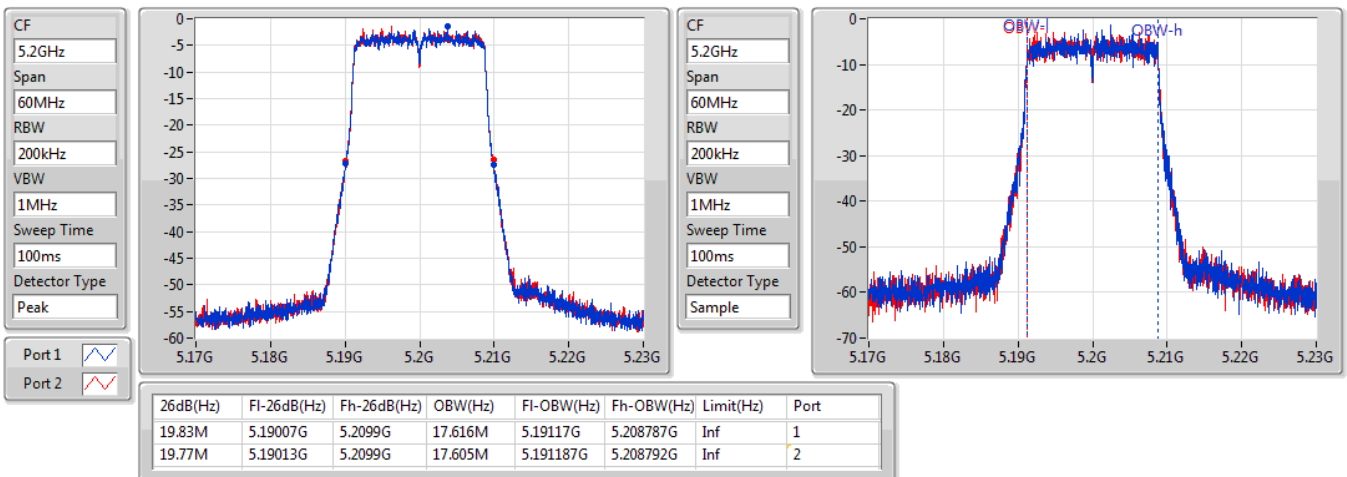

802.11ac VHT20_Nss1,(MCS0)_2TX

EBW

5240MHz

03/09/2019

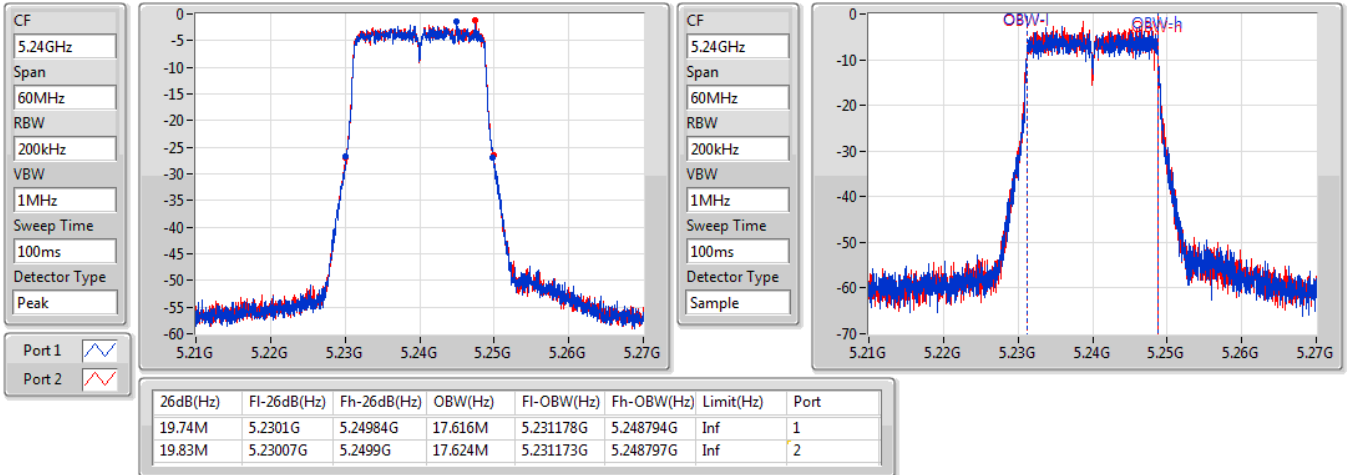

802.11ac VHT20_Nss1,(MCS0)_2TX

EBW

5745MHz

24/08/2019

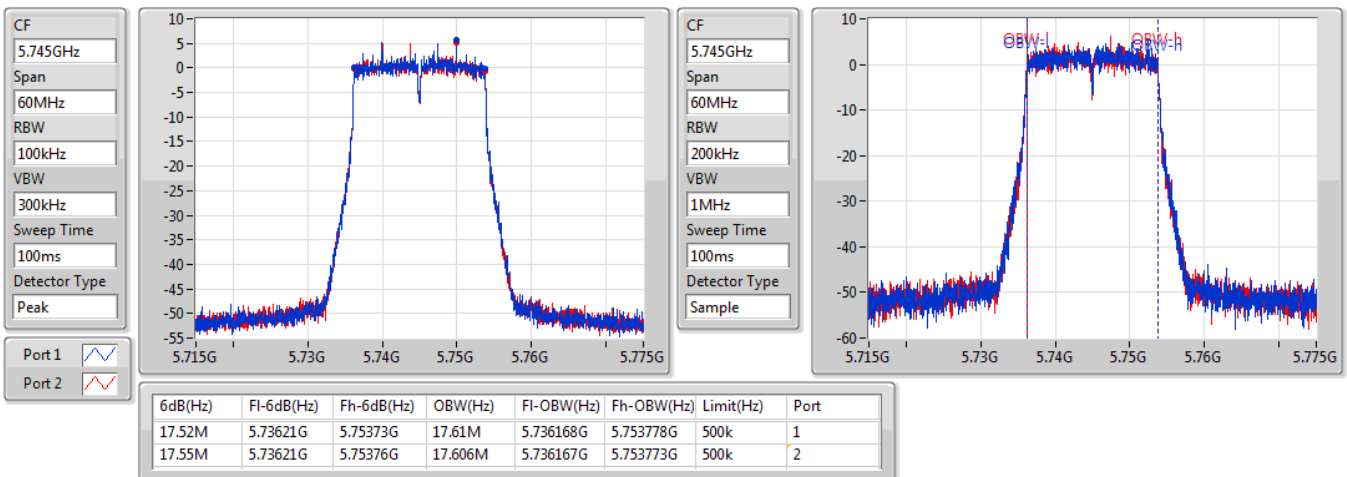

802.11ac VHT20_Nss1,(MCS0)_2TX

EBW

5785MHz

24/08/2019

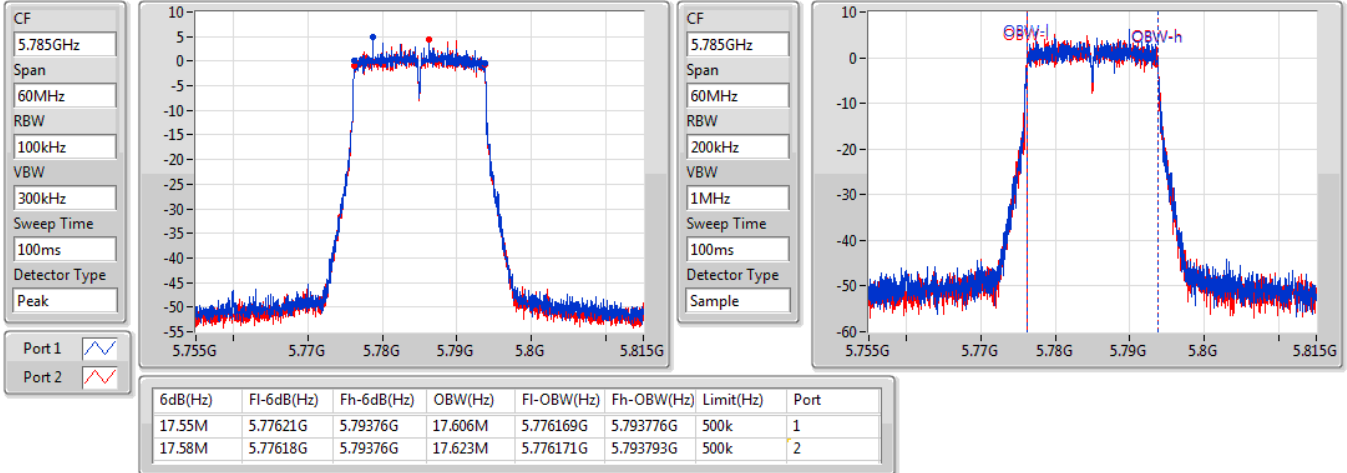

802.11ac VHT20_Nss1,(MCS0)_2TX

EBW

5825MHz

24/08/2019

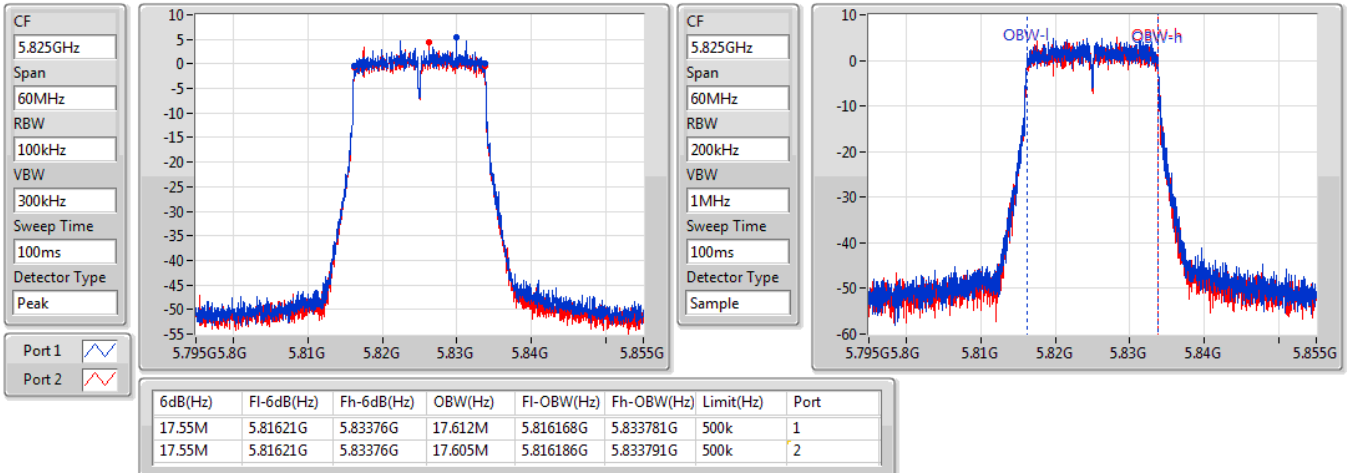

802.11ac VHT40_Nss1,(MCS0)_2TX

EBW

5190MHz

03/09/2019

CF
5.19GHz
Span
120MHz
RBW
510kHz
VBW
2MHz
Sweep Time
100ms
Detector Type
Peak

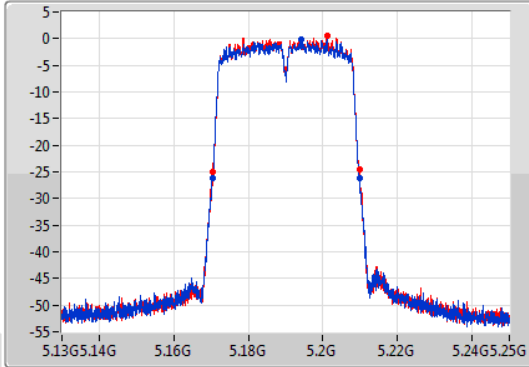

CF
5.19GHz
Span
120MHz
RBW
510kHz
VBW
2MHz
Sweep Time
100ms
Detector Type
Sample

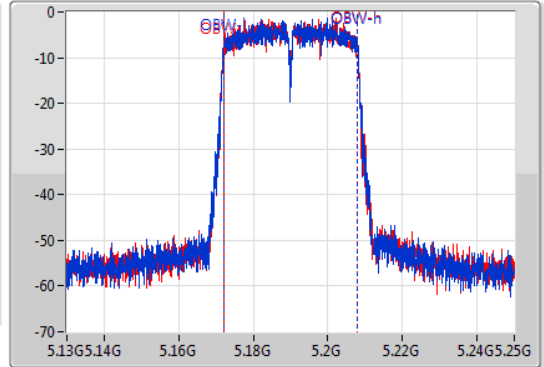

26dB(Hz)	Fl-26dB(Hz)	Fh-26dB(Hz)	OBW(Hz)	Fl-OBW(Hz)	Fh-OBW(Hz)	Limit(Hz)	Port
39.42M	5.17038G	5.2098G	35.96M	5.17202G	5.207981G	Inf	1
39.3M	5.1705G	5.2098G	35.905M	5.172079G	5.207984G	Inf	2

802.11ac VHT40_Nss1,(MCS0)_2TX

EBW

5230MHz

03/09/2019

CF
5.23GHz
Span
120MHz
RBW
510kHz
VBW
2MHz
Sweep Time
100ms
Detector Type
Peak

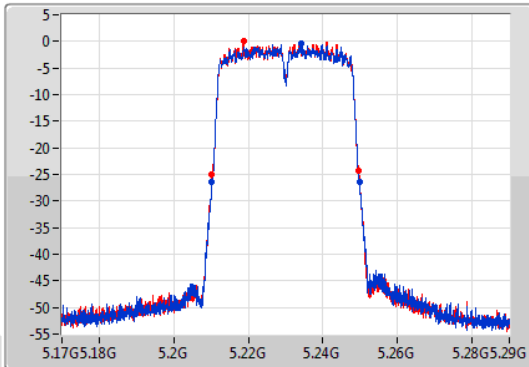

CF
5.23GHz
Span
120MHz
RBW
510kHz
VBW
2MHz
Sweep Time
100ms
Detector Type
Sample

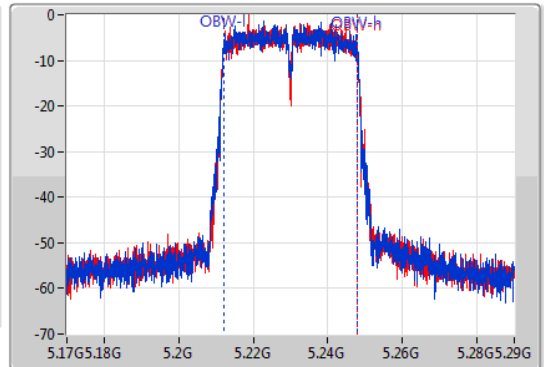

26dB(Hz)	Fl-26dB(Hz)	Fh-26dB(Hz)	OBW(Hz)	Fl-OBW(Hz)	Fh-OBW(Hz)	Limit(Hz)	Port
39.6M	5.21026G	5.24986G	35.994M	5.211977G	5.24797G	Inf	1
39.42M	5.21026G	5.24968G	35.953M	5.211993G	5.247946G	Inf	2

802.11ac VHT40_Nss1,(MCS0)_2TX

EBW

5755MHz

24/08/2019

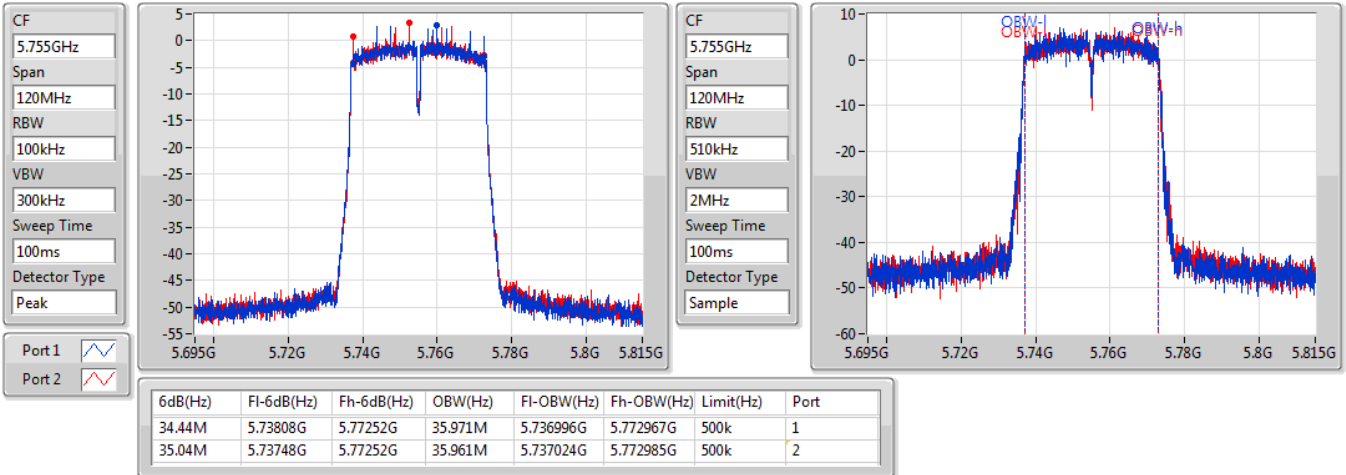

802.11ac VHT40_Nss1,(MCS0)_2TX

EBW

5795MHz

24/08/2019

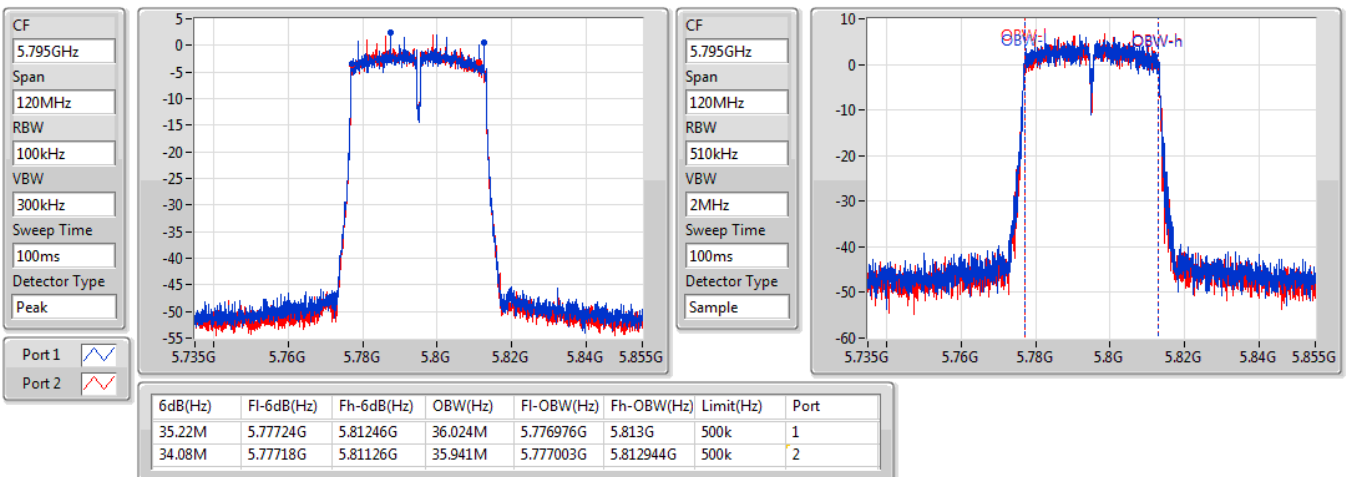

802.11ac VHT80_Nss1,(MCS0)_2TX

EBW

5210MHz

03/09/2019

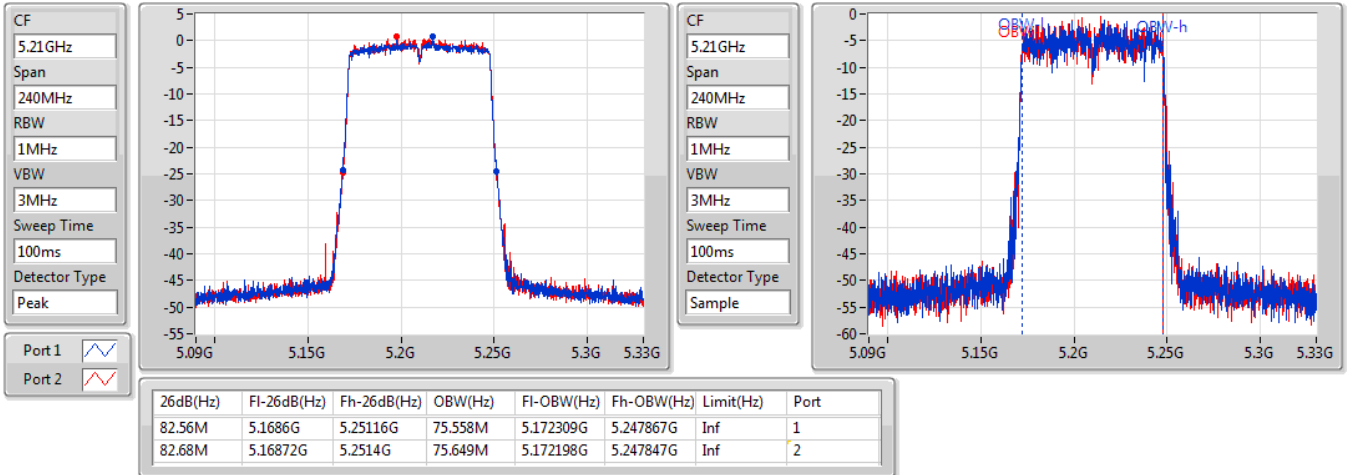

802.11ac VHT80_Nss1,(MCS0)_2TX

EBW

5775MHz

24/08/2019

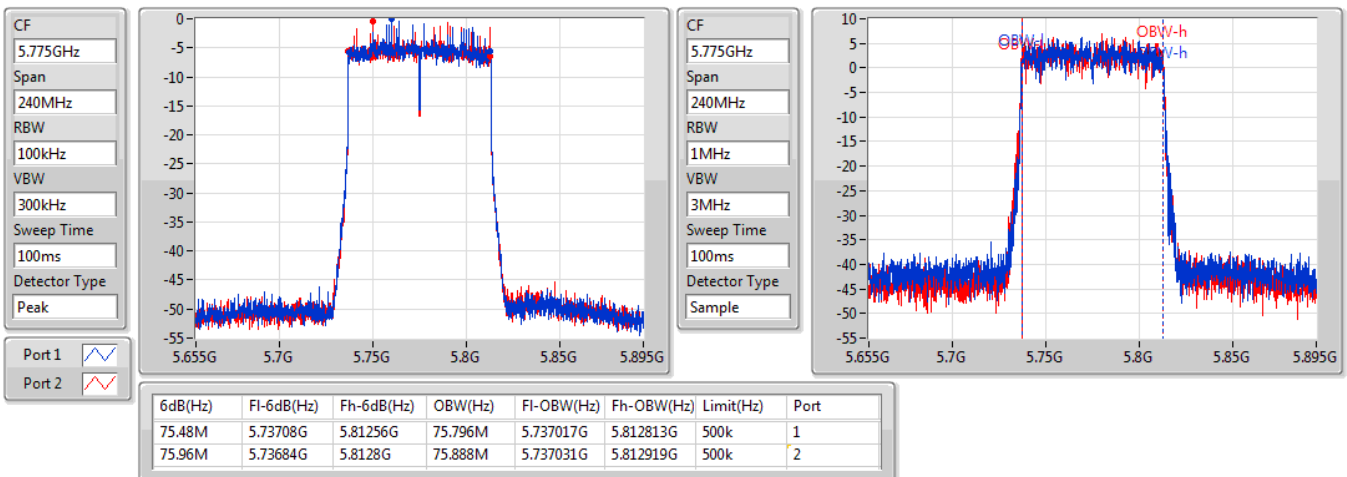



Summary

Mode	Total Power (dBm)	Total Power (W)	EIRP (dBm)	EIRP (W)
5.15-5.25GHz	-	-	-	-
802.11a_Nss1,(6Mbps)_2TX	12.96	0.01977	28.46/20.89	0.70146/0.12274
802.11ac VHT20_Nss1,(MCS0)_2TX	13.06	0.02023	28.56/20.99	0.71779/0.12560
802.11ac VHT40_Nss1,(MCS0)_2TX	12.99	0.01991	28.49/20.92	0.70632/0.12359
802.11ac VHT80_Nss1,(MCS0)_2TX	12.91	0.01954	28.41/20.84	0.69343/0.12134
5.725-5.85GHz	-	-	-	-
802.11a_Nss1,(6Mbps)_2TX	20.48	0.11169	35.98	3.96278
802.11ac VHT20_Nss1,(MCS0)_2TX	20.32	0.10765	35.82	3.81944
802.11ac VHT40_Nss1,(MCS0)_2TX	20.23	0.10544	35.73	3.74111
802.11ac VHT80_Nss1,(MCS0)_2TX	20.14	0.10328	35.64	3.66438



Result

Mode	Result	DG (dBi)	Port 1 (dBm)	Port 2 (dBm)	Total Power (dBm)	Power Limit (dBm)	EIRP (dBm)	EIRP Limit (dBm)
802.11a_Nss1,(6Mbps)_2TX	-	-	-	-	-	-	-	-
5180MHz	Pass	15.50	9.72	9.84	12.79	20.50	28.29/20.72	36.00/21.00
5200MHz	Pass	15.50	9.76	10.09	12.94	20.50	28.44/20.87	36.00/21.00
5240MHz	Pass	15.50	9.76	10.14	12.96	20.50	28.46/20.89	36.00/21.00
5745MHz	Pass	15.50	17.68	17.20	20.46	20.50	35.96	36.00
5785MHz	Pass	15.50	17.58	17.35	20.48	20.50	35.98	36.00
5825MHz	Pass	15.50	17.54	17.10	20.34	20.50	35.84	36.00
802.11ac VHT20_Nss1,(MCS0)_2TX	-	-	-	-	-	-	-	-
5180MHz	Pass	15.50	9.63	10.09	12.88	20.50	28.38/20.81	36.00/21.00
5200MHz	Pass	15.50	9.90	10.11	13.02	20.50	28.52/20.95	36.00/21.00
5240MHz	Pass	15.50	9.76	10.33	13.06	20.50	28.56/20.99	36.00/21.00
5745MHz	Pass	15.50	17.15	17.05	20.11	20.50	35.61	36.00
5785MHz	Pass	15.50	17.18	17.00	20.10	20.50	35.60	36.00
5825MHz	Pass	15.50	17.49	17.12	20.32	20.50	35.82	36.00
802.11ac VHT40_Nss1,(MCS0)_2TX	-	-	-	-	-	-	-	-
5190MHz	Pass	15.50	9.92	9.98	12.96	20.50	28.46/20.89	36.00/21.00
5230MHz	Pass	15.50	9.97	9.98	12.99	20.50	28.49/20.92	36.00/21.00
5755MHz	Pass	15.50	17.34	17.10	20.23	20.50	35.73	36.00
5795MHz	Pass	15.50	17.05	17.11	20.09	20.50	35.59	36.00
802.11ac VHT80_Nss1,(MCS0)_2TX	-	-	-	-	-	-	-	-
5210MHz	Pass	15.50	9.85	9.95	12.91	20.50	28.41/20.84	36.00/21.00
5775MHz	Pass	15.50	17.16	17.09	20.14	20.50	35.64	36.00

DG = Directional Gain; Port X = Port X output power



Result

Mode	Result	Gain- Elevation 30° (dBi)	Total Power (dBm)	EIRP- Elevation 30° (dBm)	EIRP Limit- Elevation 30° (dBm)
802.11a_Nss1,(6Mbps)_2TX_5180MHz	Pass	7.93	12.79	20.72	21.00
802.11a_Nss1,(6Mbps)_2TX_5200MHz	Pass	7.93	12.94	20.87	21.00
802.11a_Nss1,(6Mbps)_2TX_5240MHz	Pass	7.93	12.96	20.89	21.00
802.11ac VHT20_Nss1,(MCS0)_2TX_5180MHz	Pass	7.93	12.88	20.81	21.00
802.11ac VHT20_Nss1,(MCS0)_2TX_5200MHz	Pass	7.93	13.02	20.95	21.00
802.11ac VHT20_Nss1,(MCS0)_2TX_5240MHz	Pass	7.93	13.06	20.99	21.00
802.11ac VHT40_Nss1,(MCS0)_2TX_5190MHz	Pass	7.93	12.96	20.89	21.00
802.11ac VHT40_Nss1,(MCS0)_2TX_5230MHz	Pass	7.93	12.99	20.92	21.00
802.11ac VHT80_Nss1,(MCS0)_2TX_5210MHz	Pass	7.93	12.91	20.84	21.00



Elevation angle above 30 degree Max Gain

Elevation angle above 30 degree Max Gain(dB)		793
Freq. (MHz)	Gain(dB)	Elevation Angle Define
-180	-22.82	Above 30 degree
-179	-23.49	
-178	-24.45	
-177	-25.47	
-176	-26.37	
-175	-27.91	
-174	-27.73	
-173	-21.95	
-172	-20.50	
-171	-16.93	
-170	-16.91	
-169	-15.97	
-168	-15.97	
-167	-15.41	
-166	-14.91	
-165	-15.83	
-164	-14.51	
-163	-14.18	
-162	-14.62	
-161	-13.53	
-160	-13.25	
-159	-13.85	
-158	-16.14	
-157	-16.49	
-156	-19.75	
-155	-19.50	
-154	-19.12	
-153	-17.12	
-152	-16.30	
-151	-16.68	
-150	-16.69	
-149	-18.31	
-148	-18.86	
-147	-17.56	
-146	-17.37	
-145	-14.39	
-144	-14.32	
-143	-12.52	
-142	-15.17	
-141	-13.86	
-140	-16.20	
-139	-16.22	
-138	-16.12	
-137	-16.01	
-136	-13.91	
-135	-15.27	
-134	-17.98	
-133	-17.16	
-132	-18.44	
-131	-21.01	
-130	-21.48	
-129	-19.16	
-128	-17.71	
-127	-19.69	
-126	-15.00	
-125	-13.60	
-124	-14.59	
-123	-14.73	
-122	-14.21	
-121	-13.18	
-120	-12.53	
-119	-11.72	
-118	-11.51	
-117	-10.73	
-116	-11.48	
-115	-11.31	
-114	-11.00	
-113	-10.80	
-112	-10.84	
-111	-10.30	
-110	-9.54	
-109	-16.08	
-108	-10.59	
-107	-10.46	
-106	-10.43	
-105	-9.75	
-104	-10.92	
-103	-10.27	
-102	-10.65	
-101	-10.58	
-100	-9.92	
-99	-10.00	
-98	-9.17	
-97	-9.27	
-96	-8.35	
-95	-8.01	
-94	-7.51	
-93	-7.22	
-92	-7.48	
-91	-6.11	
-90	-5.56	
-89	-5.42	
-88	-4.90	
-87	-4.81	
-86	-4.33	
-85	-3.64	
-84	-3.59	
-83	-3.13	
-82	-2.70	
-81	-2.55	
-80	-2.61	
-79	-2.11	
-78	-1.43	
-77	-1.18	
-76	-1.08	
-75	-0.86	
-74	-0.89	
-73	-0.72	
-72	-0.21	
-71	-0.27	
-70	0.08	
-69	0.18	
-68	0.28	
-67	0.05	
-66	0.17	
-65	0.38	
-64	0.30	
-63	0.30	
-62	0.37	
-61	0.06	
-60	0.12	
-59	0.40	
-58	0.38	
-57	0.99	
-56	0.16	
-55	0.25	
-54	0.11	
-53	0.36	
-52	0.47	
-51	0.63	
-50	0.83	
-49	0.98	
-48	1.29	
-47	1.58	
-46	2.28	
-45	2.35	
-44	3.13	
-43	4.01	
-42	4.68	
-41	4.72	
-40	4.72	
-39	5.52	
-38	6.11	
-37	6.10	
-36	6.59	
-35	7.12	
-34	7.24	
-33	7.62	
-32	7.61	
-31	7.93	
-30	8.19	
-29	8.16	
-28	8.33	
-27	8.37	
-26	8.54	
-25	8.64	
-24	8.75	
-23	8.72	
-22	8.67	
-21	8.73	
-20	8.67	
-19	8.69	
-18	8.52	
-17	8.45	
-16	8.46	
-15	8.39	
-14	8.32	
-13	8.30	
-12	8.25	
-11	8.24	
-10	8.31	
-9	8.27	
-8	8.42	
-7	8.66	
-6	8.36	
-5	8.62	
-4	8.81	
-3	8.82	
-2	8.97	
-1	9.04	
0	9.03	
1	9.13	
2	9.15	
3	9.16	
4	9.21	
5	8.81	
6	8.75	
7	8.76	
8	8.63	
9	8.38	
10	8.31	
11	8.25	
12	7.91	
13	7.74	
14	7.98	

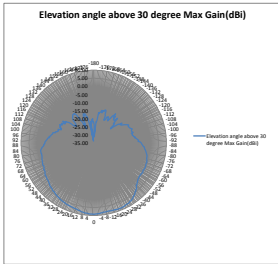



Elevation angle above 30 degree Max Gain

Angle	Gain	Label
15	7.39	0° - 30°
16	7.38	
17	7.33	
18	7.28	
19	7.24	
20	7.21	
21	6.82	
22	6.81	
23	6.82	
24	6.59	
25	6.52	
26	6.14	
27	6.14	
28	6.07	
29	5.83	
30	5.85	
31	5.55	Above 30 degree
32	5.43	
33	5.28	
34	5.04	
35	4.81	
36	4.76	
37	4.55	
38	4.33	
39	4.01	
40	4.17	
41	3.83	
42	3.65	
43	3.42	
44	3.28	
45	3.13	
46	2.88	
47	2.41	
48	2.33	
49	2.27	
50	1.88	
51	1.74	
52	1.54	
53	1.45	
54	1.19	
55	1.09	
56	1.21	
57	0.93	
58	0.78	
59	0.78	
60	-0.13	
61	-0.17	
62	0.19	
63	-0.61	
64	-0.69	
65	-0.90	
66	-0.66	
67	-0.71	
68	-0.87	
69	-1.17	
70	-1.12	
71	-1.37	
72	-1.59	
73	-1.54	
74	-1.54	
75	-1.72	
76	-1.89	
77	-1.84	
78	-1.93	
79	-1.85	
80	-1.87	
81	-1.79	
82	-1.81	
83	-2.19	
84	-2.47	
85	-2.41	
86	-3.54	
87	-4.11	
88	-3.39	
89	-4.75	
90	-2.65	
91	-4.87	
92	-5.21	
93	-6.44	
94	-6.97	
95	-6.26	
96	-6.60	
97	-7.81	
98	-7.11	
99	-8.09	
100	-8.39	
101	-8.95	
102	-8.95	
103	-7.78	
104	-8.94	
105	-16.45	
106	-16.24	
107	-11.30	
108	-11.62	
109	-11.66	
110	-11.37	
111	-11.46	
112	-13.37	
113	-12.89	
114	-13.05	
115	-11.57	
116	-11.90	
117	-12.02	
118	-11.11	
119	-12.30	
120	-12.56	
121	-11.87	
122	-12.00	
123	-13.25	
124	-13.69	
125	-11.72	
126	-13.68	
127	-13.11	
128	-14.15	
129	-16.09	
130	-16.68	
131	-16.97	
132	-18.89	
133	-18.63	
134	-20.15	
135	-19.06	
136	-18.79	
137	-17.26	
138	-16.96	
139	-15.14	
140	-14.37	
141	-14.55	
142	-13.83	
143	-13.29	
144	-13.36	
145	-13.99	
146	-13.11	
147	-13.64	
148	-16.09	
149	-16.41	
150	-18.44	
151	-18.51	
152	-24.79	
153	-25.37	
154	-21.67	
155	-23.05	
156	-22.09	
157	-18.12	
158	-18.90	
159	-16.97	
160	-15.96	
161	-17.55	
162	-16.01	
163	-16.17	
164	-17.68	
165	-18.69	
166	-18.36	
167	-28.66	
168	-28.52	
169	-32.27	
170	-33.66	
171	-23.11	
172	-25.72	
173	-21.48	
174	-23.15	
175	-20.72	
176	-20.86	
177	-19.99	
178	-21.89	
179	-22.51	



Summary

Mode	PD (dBm/RBW)	EIRP PD (dBm/RBW)
5.15-5.25GHz	-	-
802.11a_Nss1,(6Mbps)_2TX	-0.50	18.01
802.11ac VHT20_Nss1,(MCS0)_2TX	-0.89	17.62
802.11ac VHT40_Nss1,(MCS0)_2TX	-3.64	14.87
802.11ac VHT80_Nss1,(MCS0)_2TX	-7.20	11.31
5.725-5.85GHz	-	-
802.11a_Nss1,(6Mbps)_2TX	6.19	24.70
802.11ac VHT20_Nss1,(MCS0)_2TX	5.57	24.08
802.11ac VHT40_Nss1,(MCS0)_2TX	3.24	21.75
802.11ac VHT80_Nss1,(MCS0)_2TX	-0.69	17.82

RBW = 500 kHz for 5.725-5.85GHz band / 1MHz for other band;

Result

Mode	Result	DG (dBi)	Port 1 (dBm/RBW)	Port 2 (dBm/RBW)	PD (dBm/RBW)	PD Limit (dBm/RBW)	EIRP PD (dBm/RBW)	EIRP PD Limit (dBm/RBW)
802.11a_Nss1,(6Mbps)_2TX	-	-	-	-	-	-	-	-
5180MHz	Pass	18.51	-3.88	-3.50	-0.78	4.49	17.73	Inf
5200MHz	Pass	18.51	-3.69	-3.26	-0.50	4.49	18.01	Inf
5240MHz	Pass	18.51	-3.74	-3.32	-0.67	4.49	17.84	Inf
5745MHz	Pass	18.51	3.36	3.17	6.19	17.49	24.70	Inf
5785MHz	Pass	18.51	3.22	3.19	6.05	17.49	24.56	Inf
5825MHz	Pass	18.51	3.09	2.78	5.89	17.49	24.40	Inf
802.11ac VHT20_Nss1,(MCS0)_2TX	-	-	-	-	-	-	-	-
5180MHz	Pass	18.51	-3.96	-3.94	-0.98	4.49	17.53	Inf
5200MHz	Pass	18.51	-3.90	-3.89	-1.01	4.49	17.50	Inf
5240MHz	Pass	18.51	-4.06	-3.69	-0.89	4.49	17.62	Inf
5745MHz	Pass	18.51	2.54	2.37	5.34	17.49	23.85	Inf
5785MHz	Pass	18.51	2.62	2.35	5.30	17.49	23.81	Inf
5825MHz	Pass	18.51	2.87	2.51	5.57	17.49	24.08	Inf
802.11ac VHT40_Nss1,(MCS0)_2TX	-	-	-	-	-	-	-	-
5190MHz	Pass	18.51	-6.71	-6.41	-3.64	4.49	14.87	Inf
5230MHz	Pass	18.51	-7.01	-6.86	-4.08	4.49	14.43	Inf
5755MHz	Pass	18.51	0.29	0.25	3.24	17.49	21.75	Inf
5795MHz	Pass	18.51	-0.28	-0.31	2.69	17.49	21.20	Inf
802.11ac VHT80_Nss1,(MCS0)_2TX	-	-	-	-	-	-	-	-
5210MHz	Pass	18.51	-10.19	-10.08	-7.20	4.49	11.31	Inf
5775MHz	Pass	18.51	-3.48	-3.54	-0.69	17.49	17.82	Inf

DG = Directional Gain; RBW = 500 kHz for 5.725-5.85GHz band / 1MHz for other band;

PD = trace bin-by-bin of each transmits port summing can be performed maximum power density; Port X = Port X power density;

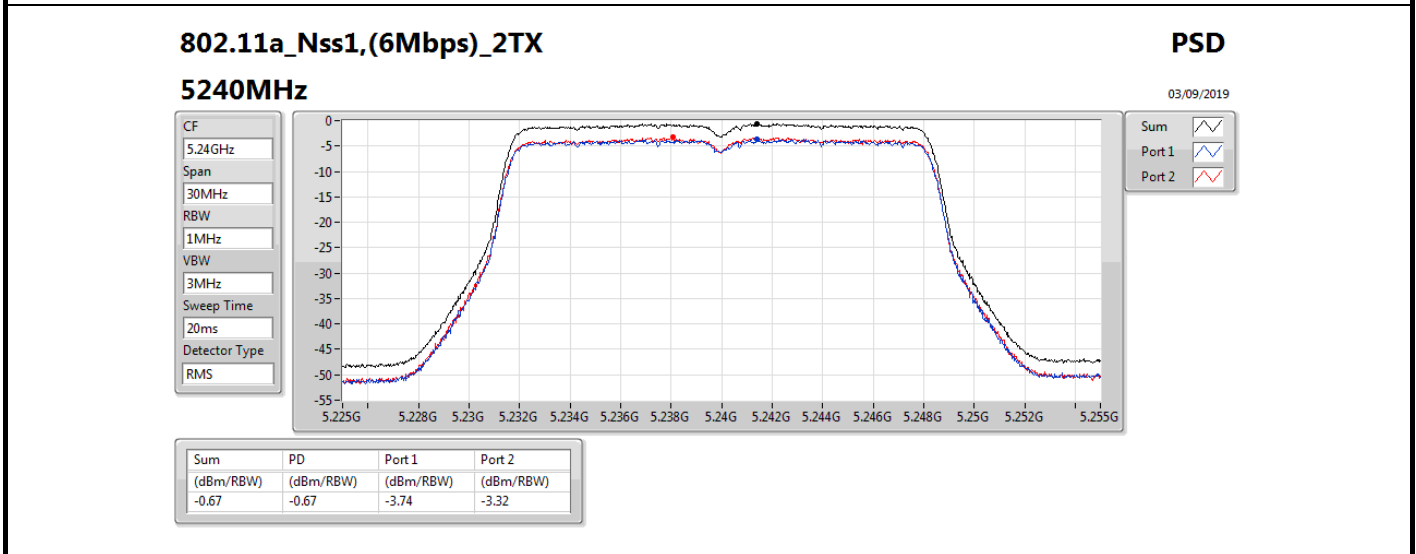
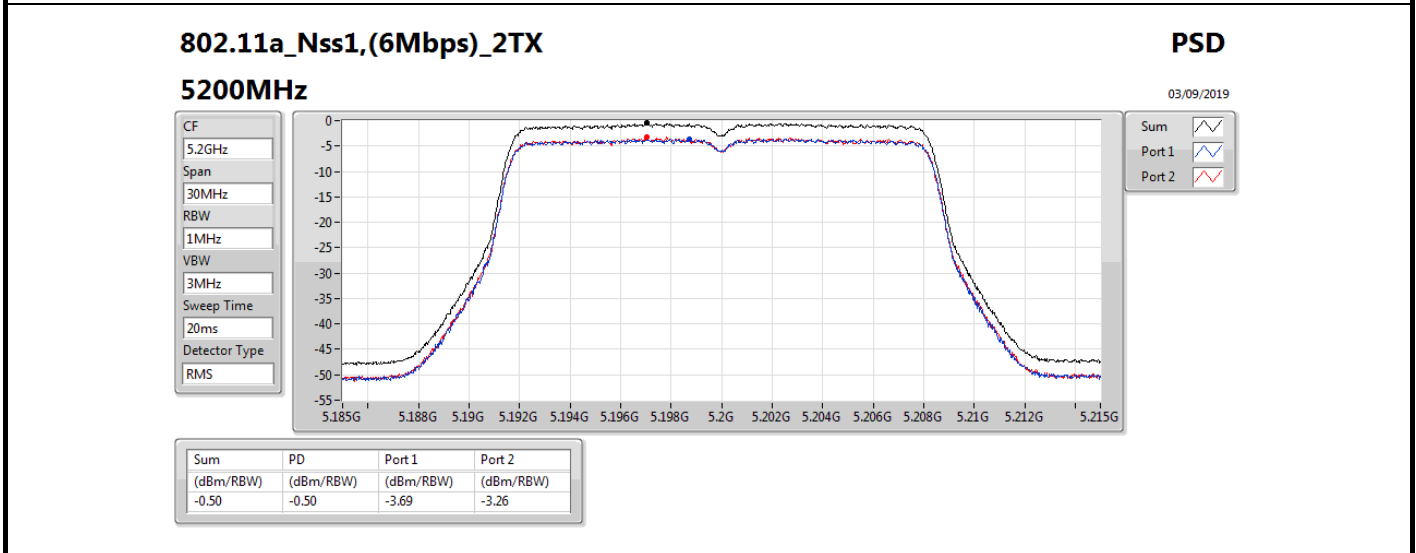
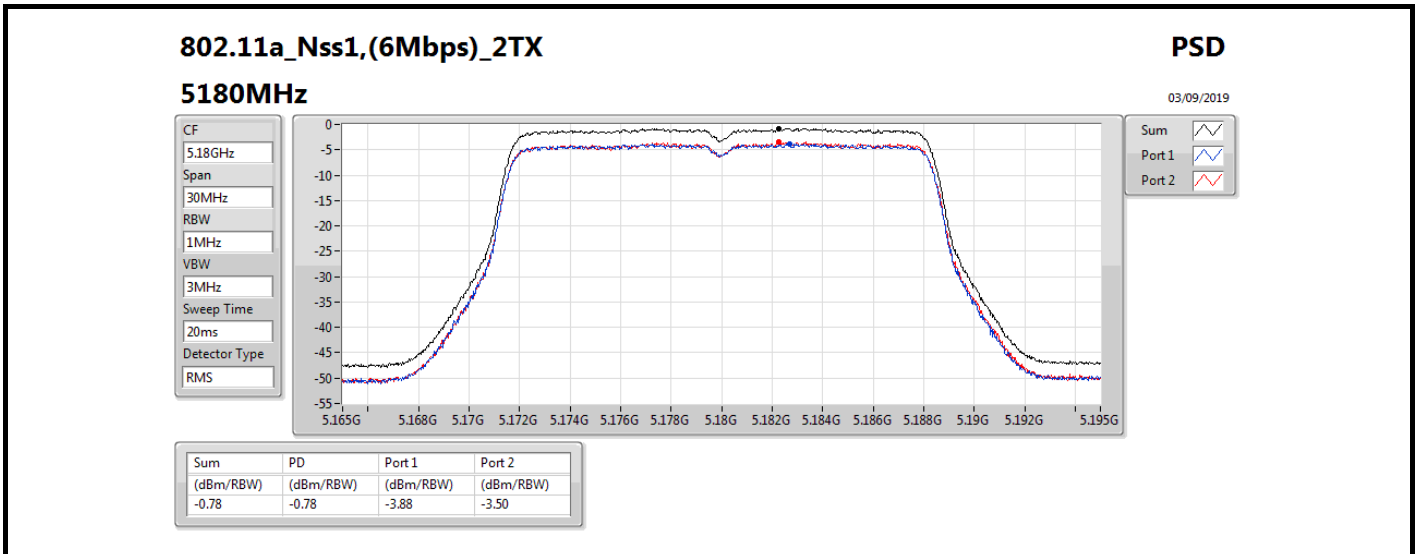

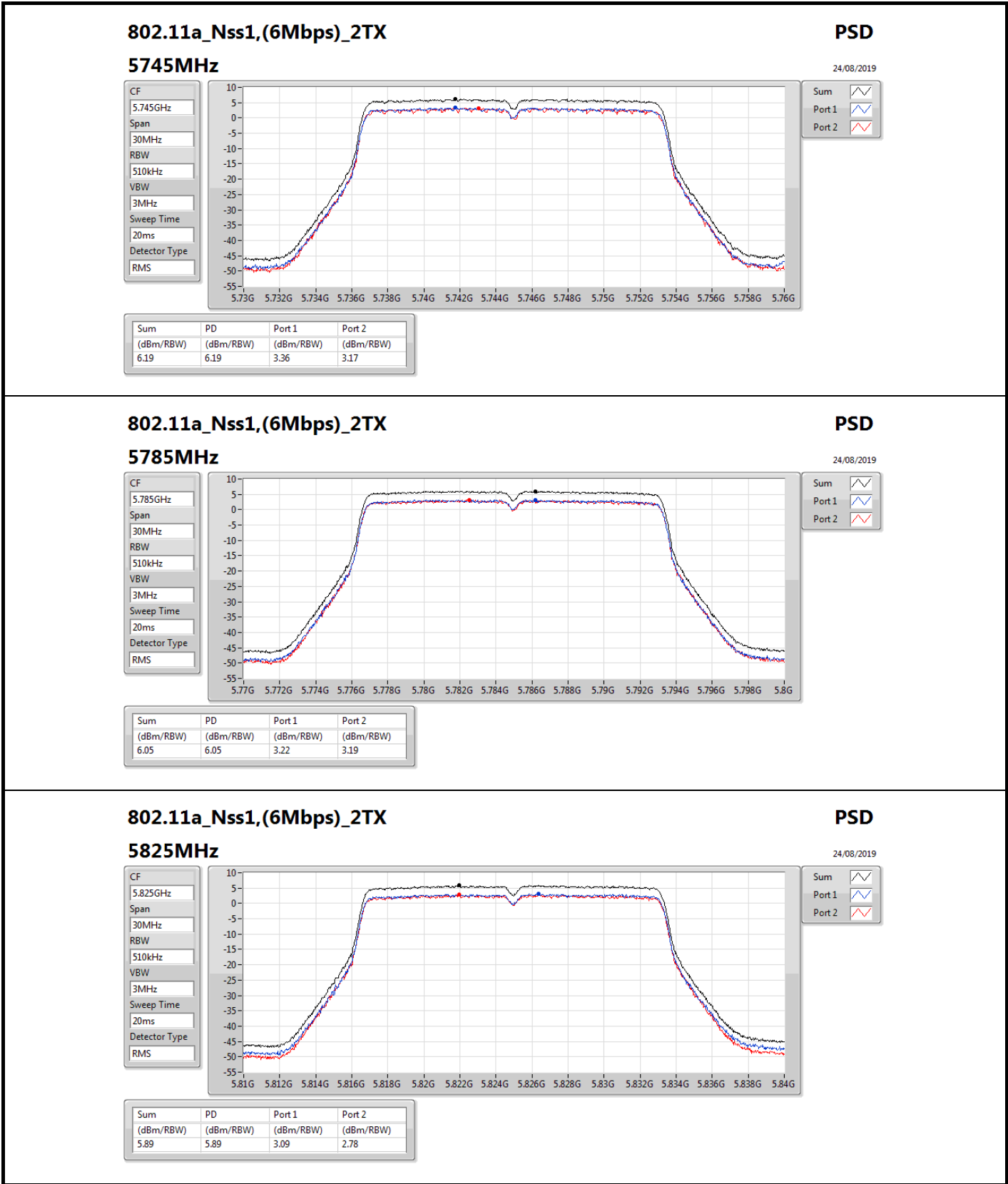

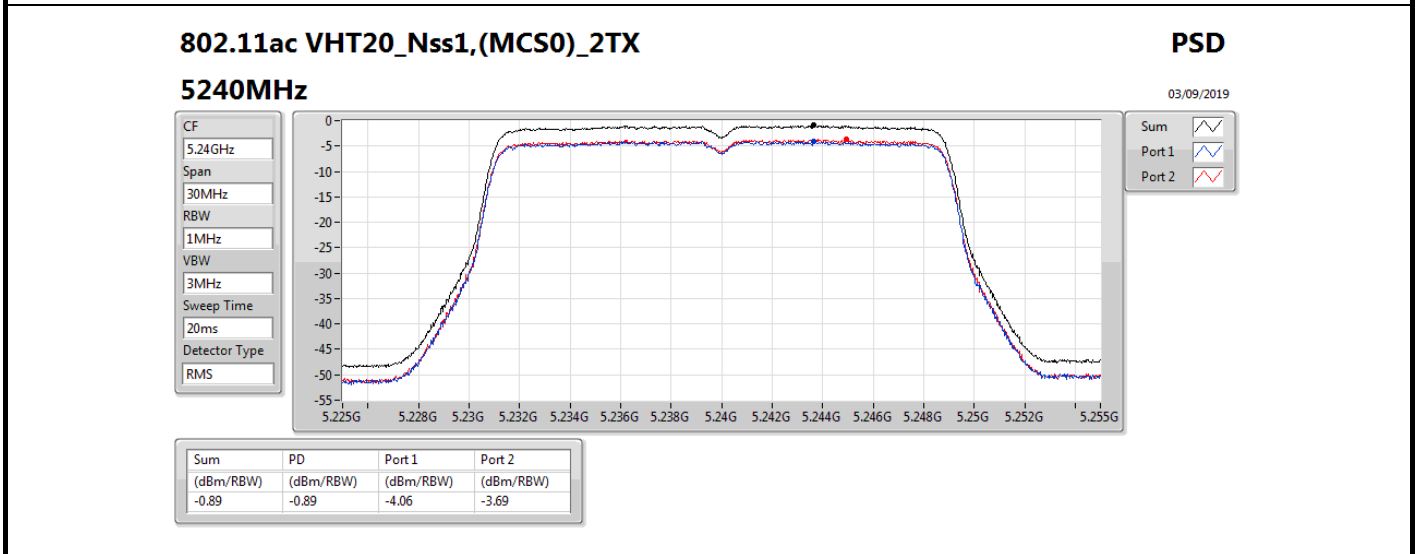
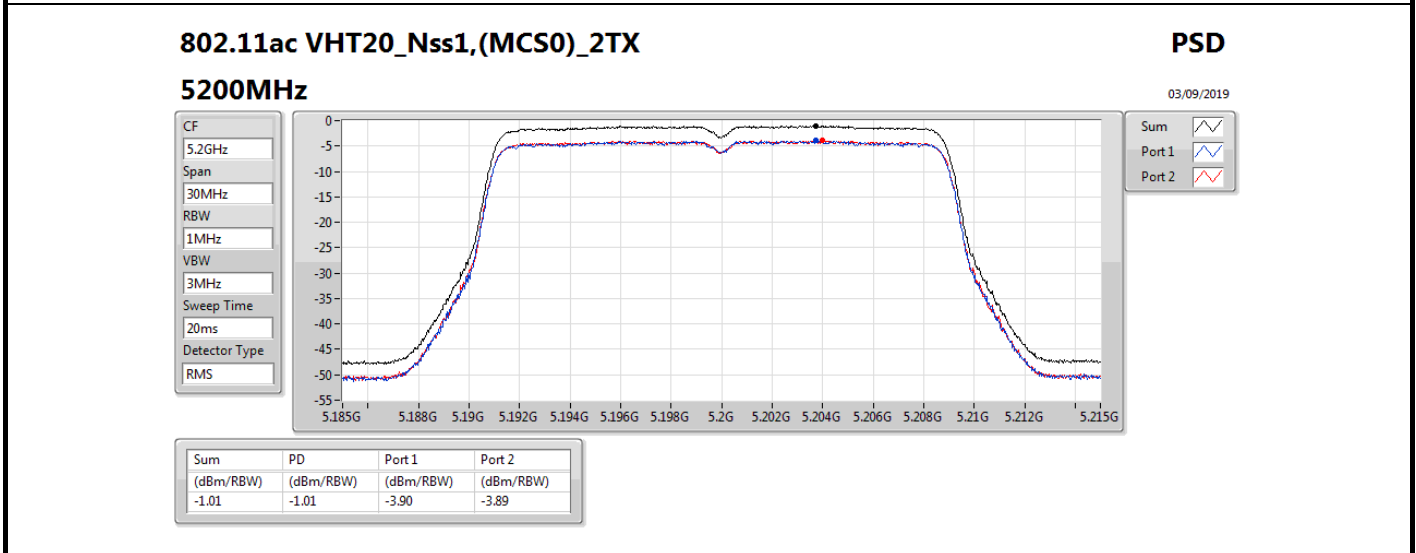
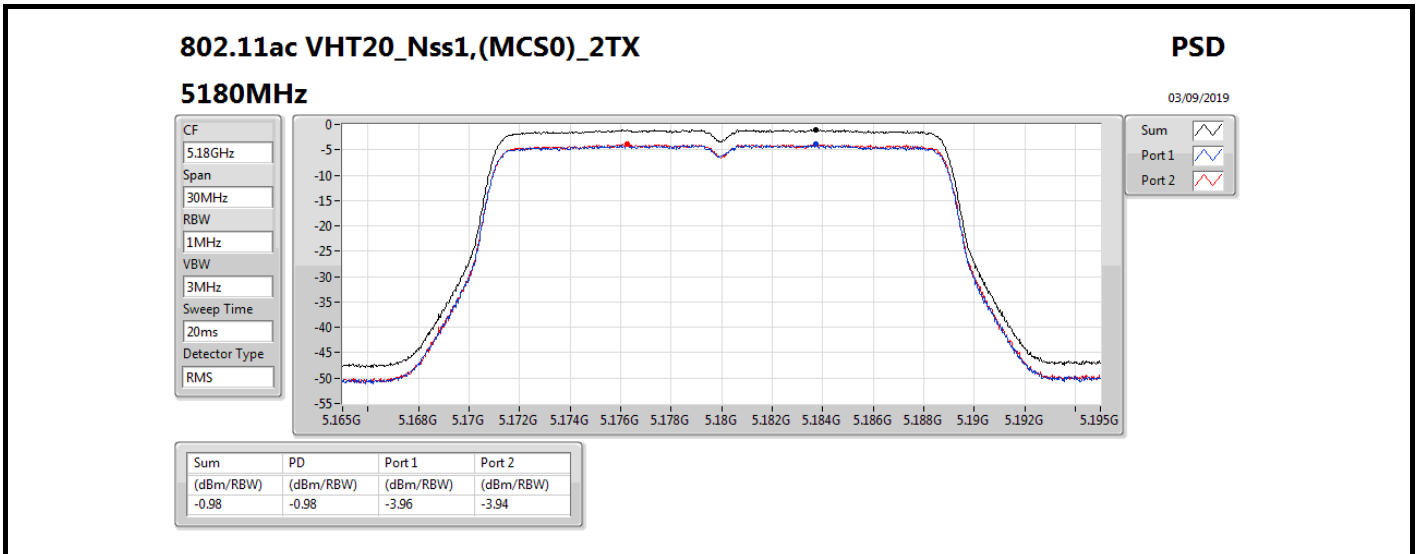

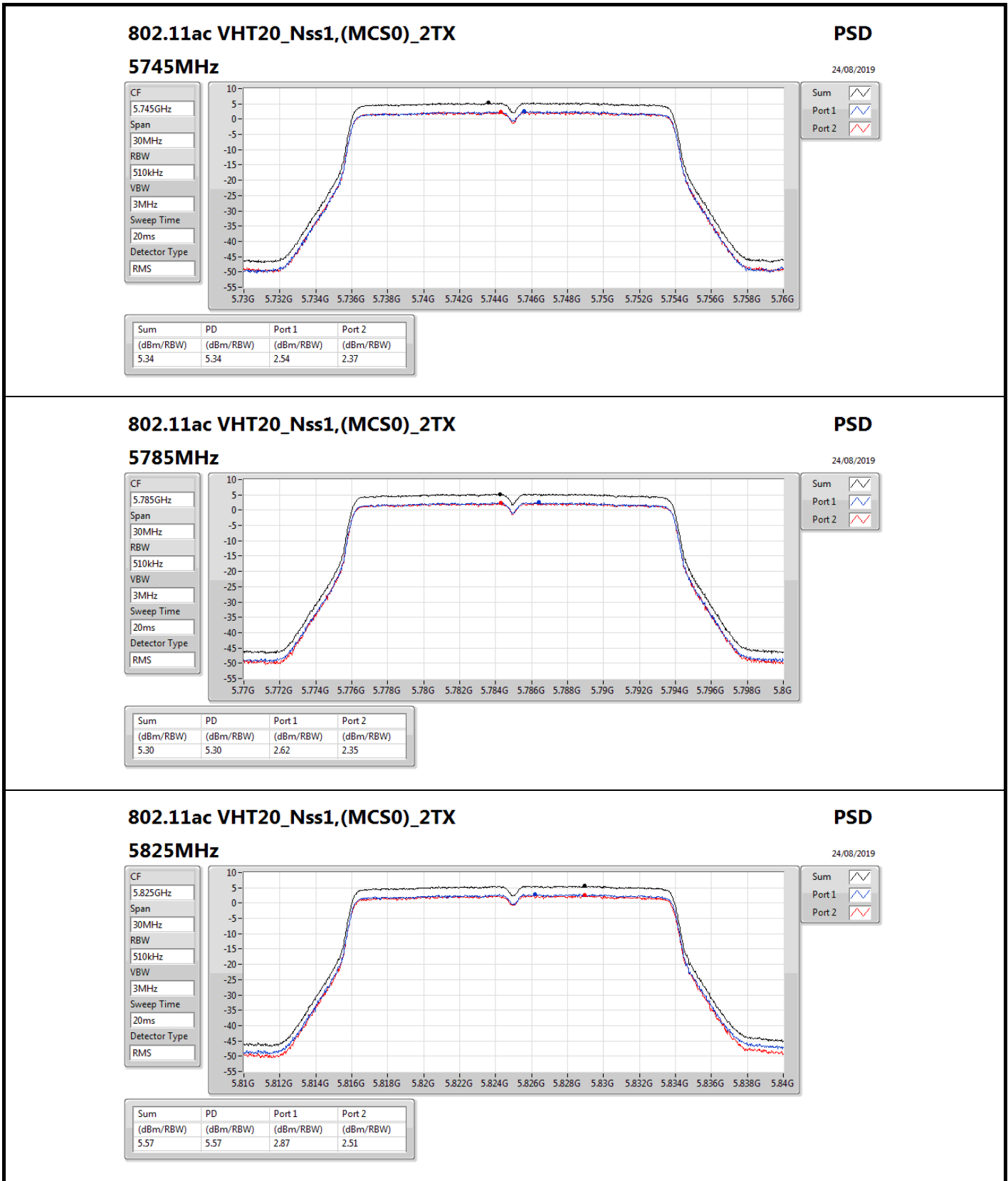

802.11ac VHT20_Nss1,(MCS0)_2TX

5825MHz

PSD

24/08/2019

CF

5.825GHz

Span

30MHz

RBW

510kHz

VBW

3MHz

Sweep Time

20ms

Detector Type

RMS



Sum

Port 1

Port 2

Sum	PD	Port 1	Port 2
(dBm/RBW)	(dBm/RBW)	(dBm/RBW)	(dBm/RBW)
5.57	5.57	2.87	2.51

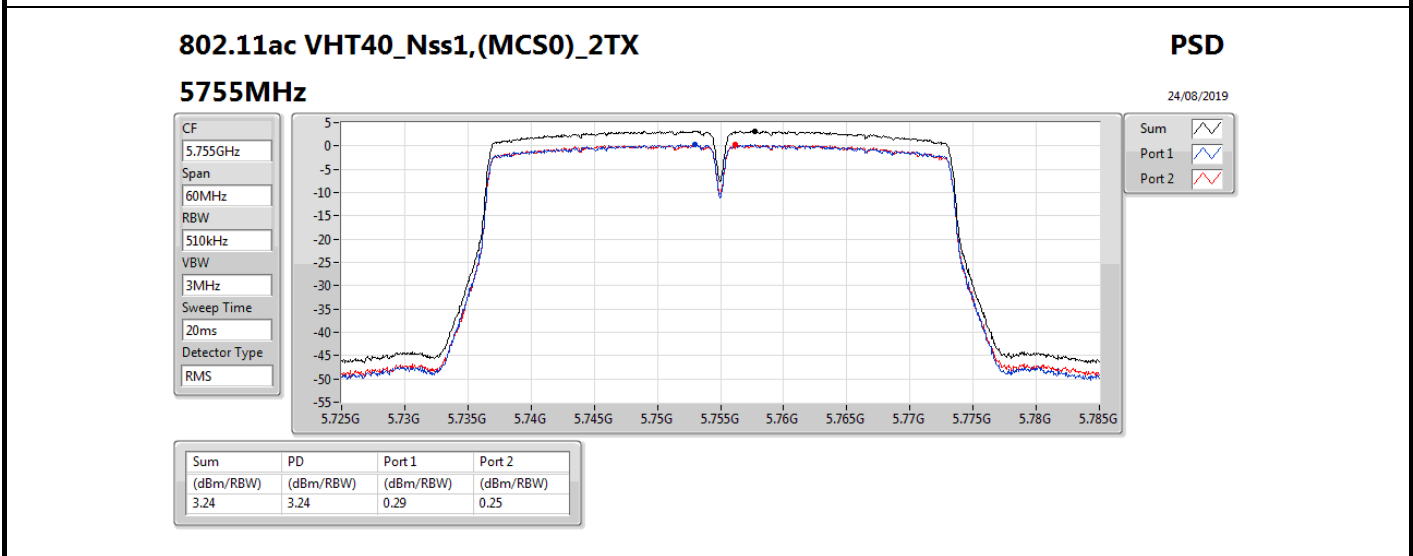
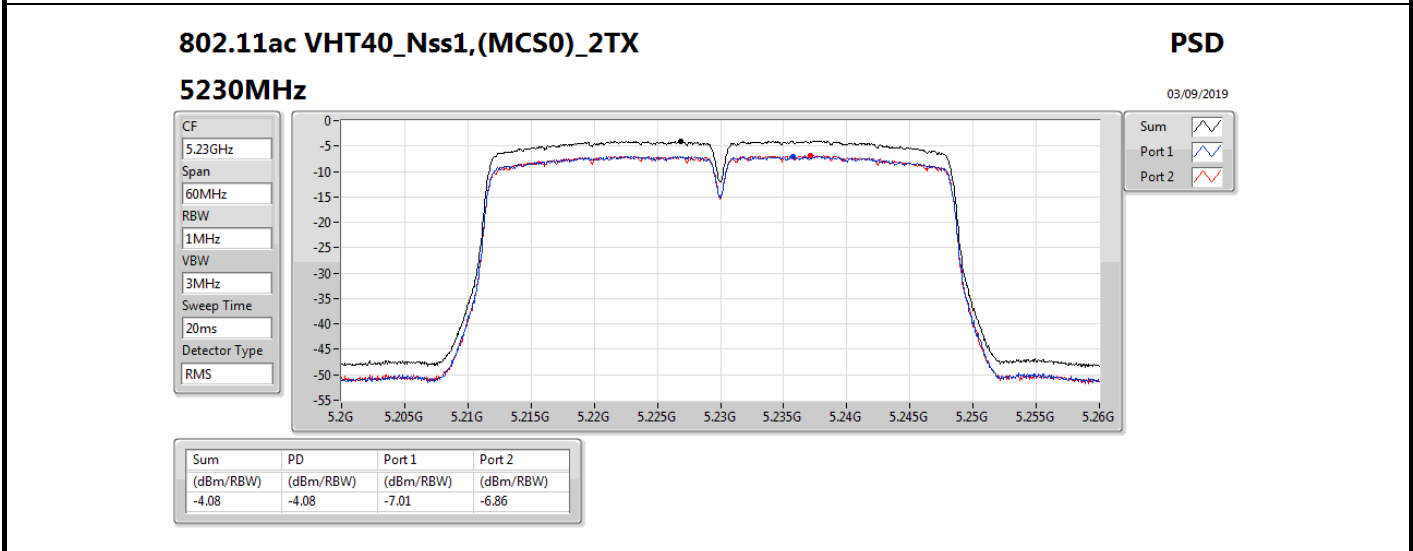
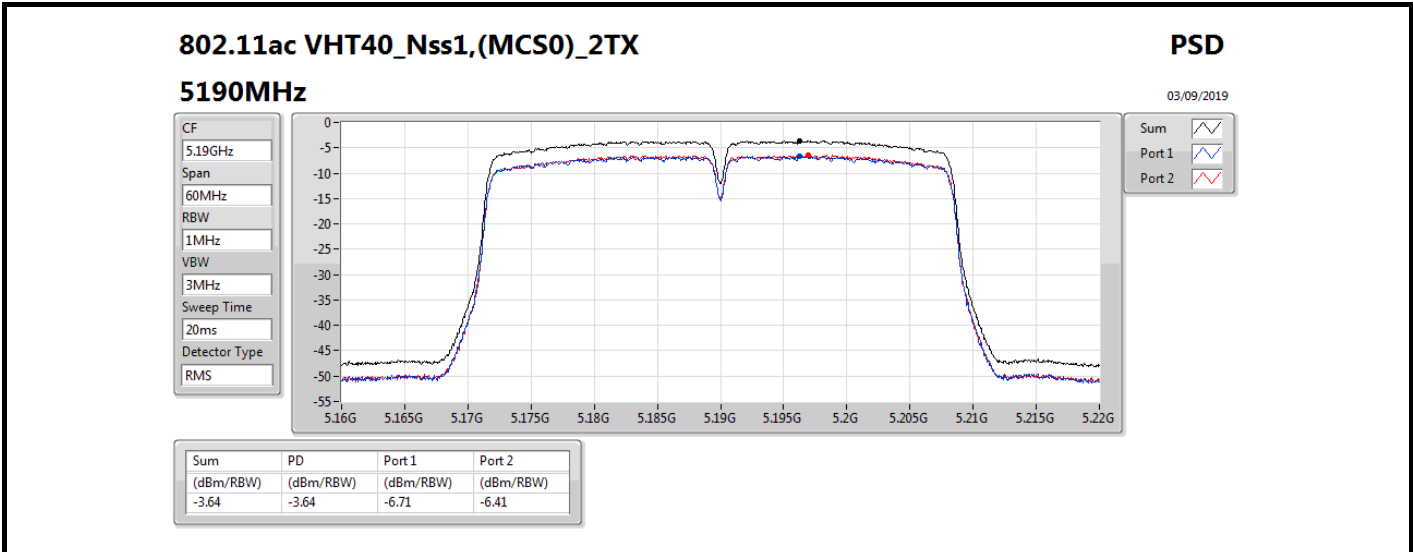

802.11ac VHT40_Nss1,(MCS0)_2TX

PSD

5795MHz

24/08/2019

CF
5.795GHz
Span
60MHz
RBW
510kHz
VBW
3MHz
Sweep Time
20ms
Detector Type
RMS

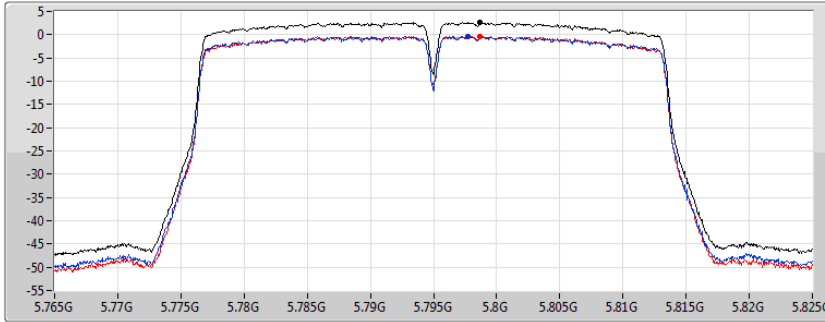

Sum
Port 1
Port 2

Sum	PD	Port 1	Port 2
(dBm/RBW)	(dBm/RBW)	(dBm/RBW)	(dBm/RBW)
2.69	2.69	-0.28	-0.31

802.11ac VHT80_Nss1,(MCS0)_2TX

PSD

5210MHz

03/09/2019

CF
5.21GHz
Span
120MHz
RBW
1MHz
VBW
3MHz
Sweep Time
20ms
Detector Type
RMS

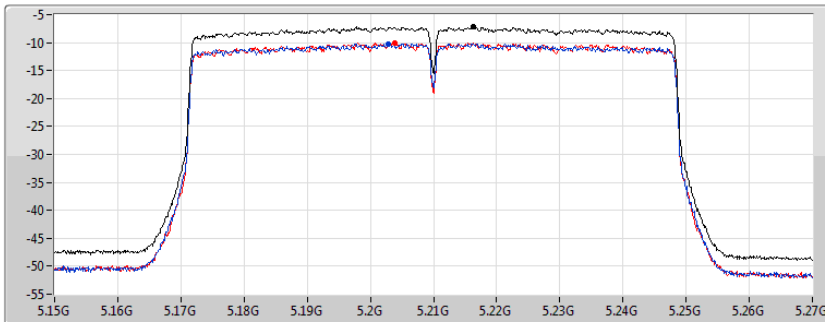

Sum
Port 1
Port 2

Sum	PD	Port 1	Port 2
(dBm/RBW)	(dBm/RBW)	(dBm/RBW)	(dBm/RBW)
-7.20	-7.20	-10.19	-10.08

802.11ac VHT80_Nss1,(MCS0)_2TX

PSD

5775MHz

24/08/2019

CF
5.775GHz
Span
120MHz
RBW
510kHz
VBW
3MHz
Sweep Time
20ms
Detector Type
RMS

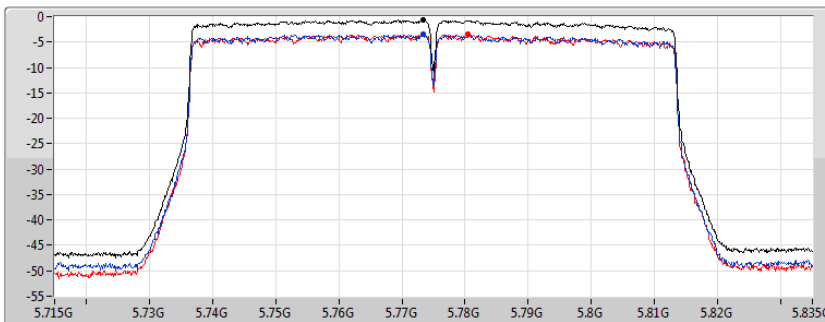

Sum
Port 1
Port 2

Sum	PD	Port 1	Port 2
(dBm/RBW)	(dBm/RBW)	(dBm/RBW)	(dBm/RBW)
-0.69	-0.69	-3.48	-3.54



RSE below 1GHz Result

RSE below 1GHz Result											
Operating Mode	5				Polarization	Vertical					
Operating Function	CTX										
	Freq	Level	Limit	Over	Read	CableAntenna	Preamp	A/Pos	T/Pos	Remark	Pol/Phase
	MHz	dBuV/m	dBuV/m	dB	dBuV	dB	dB/m	dB	cm	deg	
1	31.94	35.84	40.00	-4.16	42.16	0.71	24.51	31.54	100	186 QP	VERTICAL
2	54.25	33.69	40.00	-6.31	50.73	0.92	13.83	31.79	150	356 QP	VERTICAL
3	575.14	37.49	46.00	-8.51	41.86	3.20	24.75	32.32	150	178 QP	VERTICAL
4	673.11	34.36	46.00	-11.64	37.98	3.35	25.55	32.52	150	183 QP	VERTICAL
5	696.39	34.02	46.00	-11.98	37.46	3.45	25.60	32.49	125	1 QP	VERTICAL
6	958.29	45.39	46.00	-0.61	45.28	4.12	28.06	32.07	100	181 QP	VERTICAL

Note 1: ">20dB" means emission levels that exceed the level of 20 dB below the applicable limit.
 Note 2: "N/F" means Nothing Found emissions (No emissions were detected.)



RSE below 1GHz Result

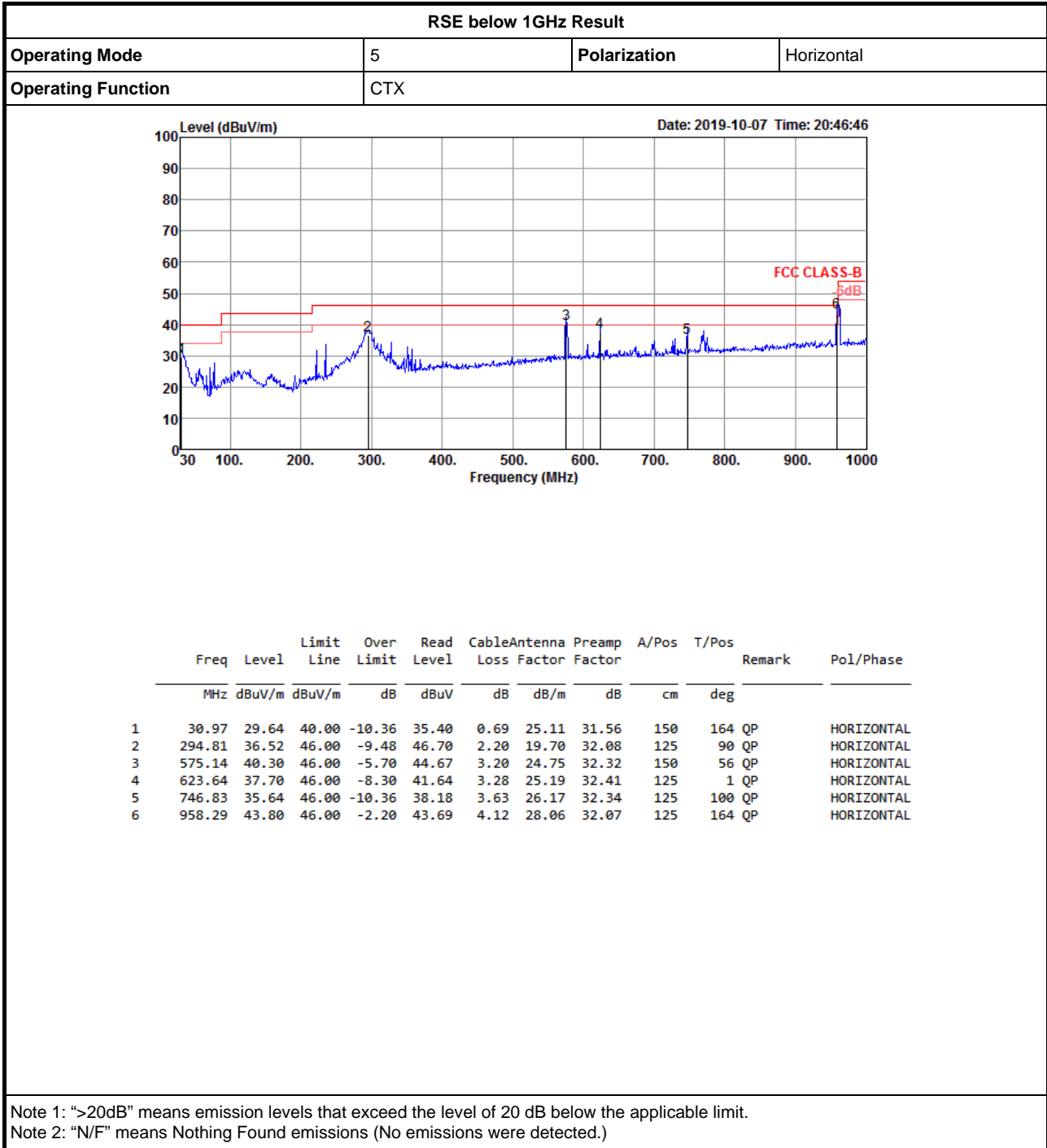



Summary

Mode	Result	Type	Freq (Hz)	Level (dBuV/m)	Limit (dBuV/m)	Margin (dB)	Factor (dB)	Dist (m)	Condition	Azimuth (°)	Height (m)	Comments
5.15-5.25GHz	-	-	-	-	-	-	-	-	-	-	-	-
802.11ac VHT80_Nss1,(MCS0)_2TX	Pass	AV	5.1388G	53.88	54.00	-0.12	7.92	3	Horizontal	12	2.24	-

802.11a_Nss1,(6Mbps)_2TX

23/08/2019

5180MHz_TX

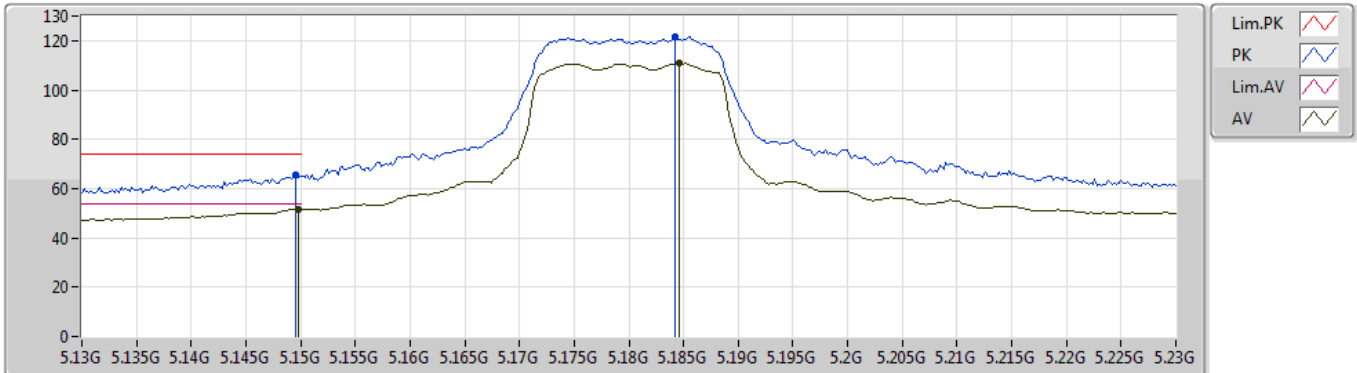

EUT_Y_2TX ANT_H
Setting 19.5
02-B-4-10
FSU(100015)

Type	Freq (Hz)	Level (dBuV/m)	Limit (dBuV/m)	Margin (dB)	Factor (dB)	Dist (m)	Condition	Azimuth (°)	Height (m)	Comment	Raw (dBuV)
PK	5.1496G	65.47	74.00	-8.53	7.94	3	Vertical	11	1.82	-	57.53
AV	5.1498G	51.69	54.00	-2.31	7.94	3	Vertical	11	1.82	-	43.75
PK	5.1842G	121.33	Inf	-Inf	8.03	3	Vertical	11	1.82	-	113.30
AV	5.1846G	110.80	Inf	-Inf	8.03	3	Vertical	11	1.82	-	102.77

802.11a_Nss1,(6Mbps)_2TX

23/08/2019

5180MHz_TX

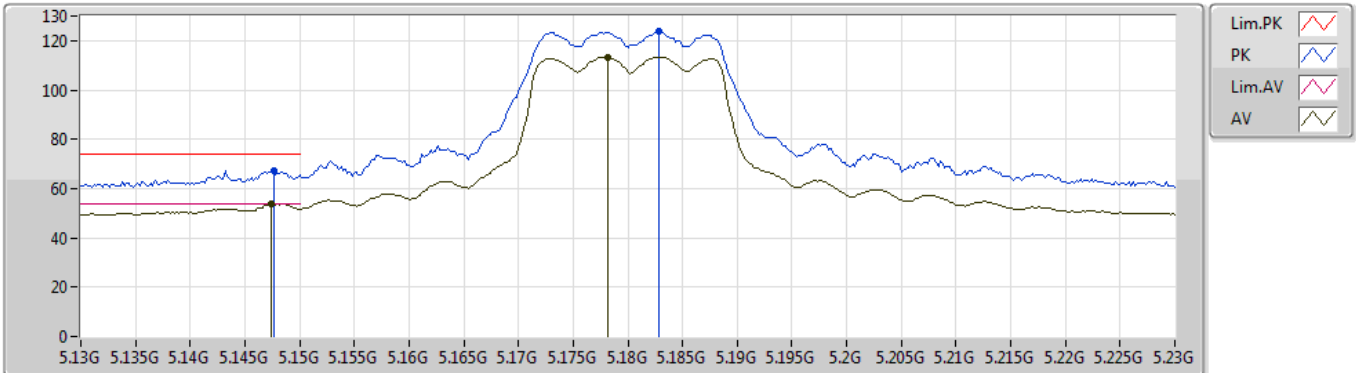

EUT_Y_2TX ANT_H
Setting 19.5
02-B-4-10
FSU(100015)

Type	Freq (Hz)	Level (dBuV/m)	Limit (dBuV/m)	Margin (dB)	Factor (dB)	Dist (m)	Condition	Azimuth (°)	Height (m)	Comment	Raw (dBuV)
PK	5.1476G	67.25	74.00	-6.75	7.94	3	Horizontal	11	2.31	-	59.31
AV	5.1474G	53.71	54.00	-0.29	7.94	3	Horizontal	11	2.31	-	45.77
PK	5.1828G	123.56	Inf	-Inf	8.02	3	Horizontal	11	2.31	-	115.54
AV	5.1782G	113.38	Inf	-Inf	8.02	3	Horizontal	11	2.31	-	105.36

802.11a_Nss1,(6Mbps)_2TX

23/08/2019

5180MHz_TX

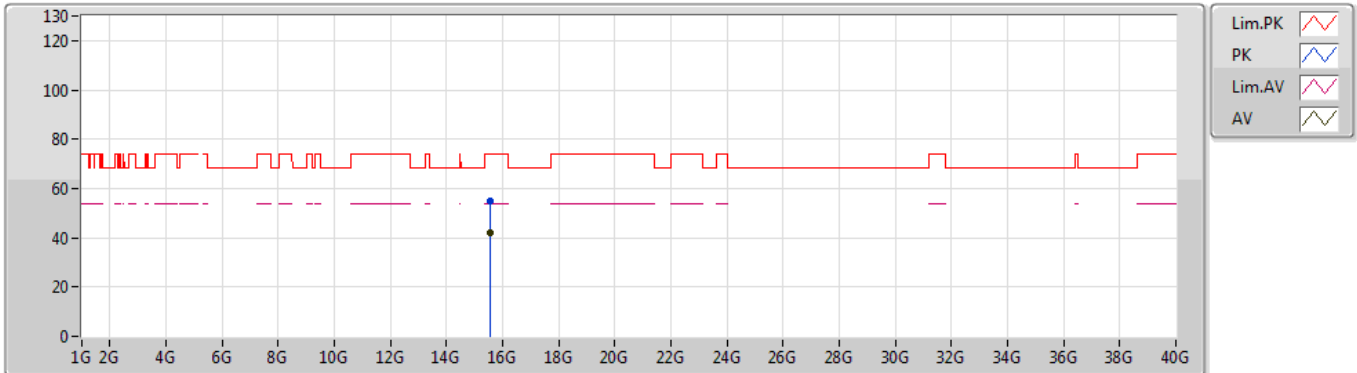

EUT_Y_2TX ANT_H
 Setting 19.5
 02-B-4
 FSU(100015)

Type	Freq (Hz)	Level (dBuV/m)	Limit (dBuV/m)	Margin (dB)	Factor (dB)	Dist (m)	Condition	Azimuth (°)	Height (m)	Comment	Raw (dBuV)
PK	15.54438G	54.92	74.00	-19.08	16.06	3	Vertical	114	1.47	-	38.86
AV	15.54022G	41.80	54.00	-12.20	16.07	3	Vertical	114	1.47	-	25.73

802.11a_Nss1,(6Mbps)_2TX

23/08/2019

5180MHz_TX

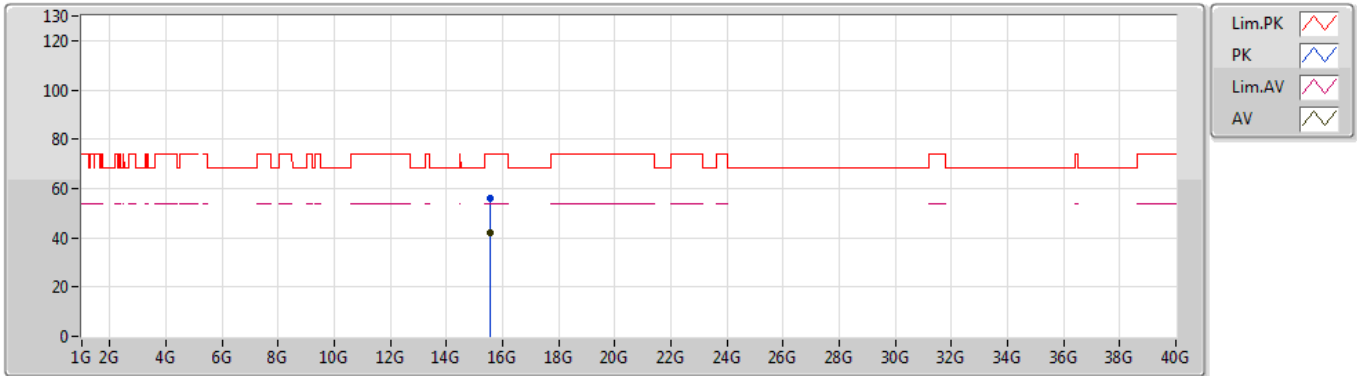

EUT Y_2TX ANT_H
Setting 19.5
02-B-4
FSU(100015)

Type	Freq (Hz)	Level (dBuV/m)	Limit (dBuV/m)	Margin (dB)	Factor (dB)	Dist (m)	Condition	Azimuth (°)	Height (m)	Comment	Raw (dBuV)
PK	15.54272G	55.82	74.00	-18.18	16.07	3	Horizontal	260	2.43	-	39.75
AV	15.54606G	41.77	54.00	-12.23	16.06	3	Horizontal	260	2.43	-	25.71

802.11a_Nss1,(6Mbps)_2TX

23/08/2019

5200MHz_TX

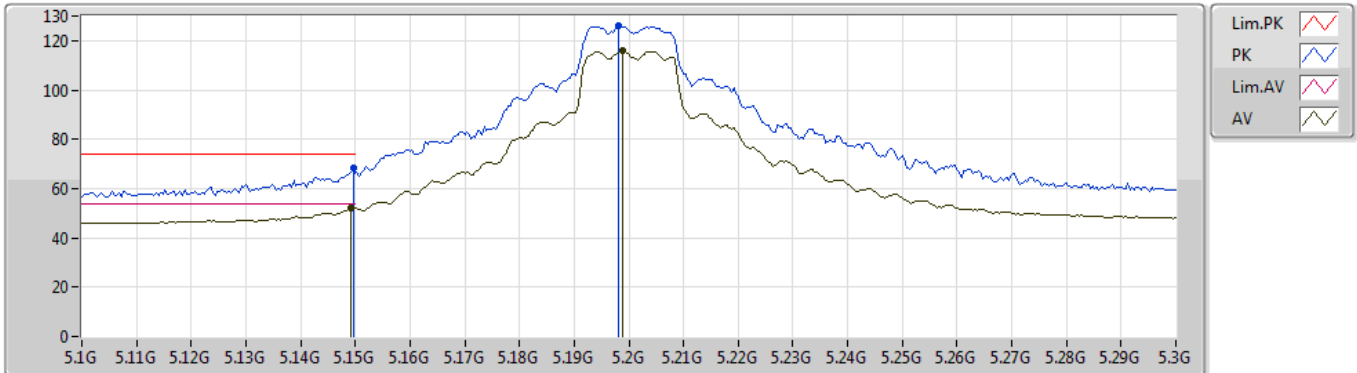

EUT Y_2TX ANT_H
 Setting 25
 02-B-4-10
 FSU(100015)

Type	Freq (Hz)	Level (dBuV/m)	Limit (dBuV/m)	Margin (dB)	Factor (dB)	Dist (m)	Condition	Azimuth (°)	Height (m)	Comment	Raw (dBuV)
PK	5.1496G	68.41	74.00	-5.59	7.94	3	Vertical	6	1.90	-	60.47
AV	5.1492G	51.97	54.00	-2.03	7.94	3	Vertical	6	1.90	-	44.03
PK	5.198G	126.24	Inf	-Inf	8.06	3	Vertical	6	1.90	-	118.18
AV	5.1988G	115.87	Inf	-Inf	8.06	3	Vertical	6	1.90	-	107.81

802.11a_Nss1,(6Mbps)_2TX

23/08/2019

5200MHz_TX

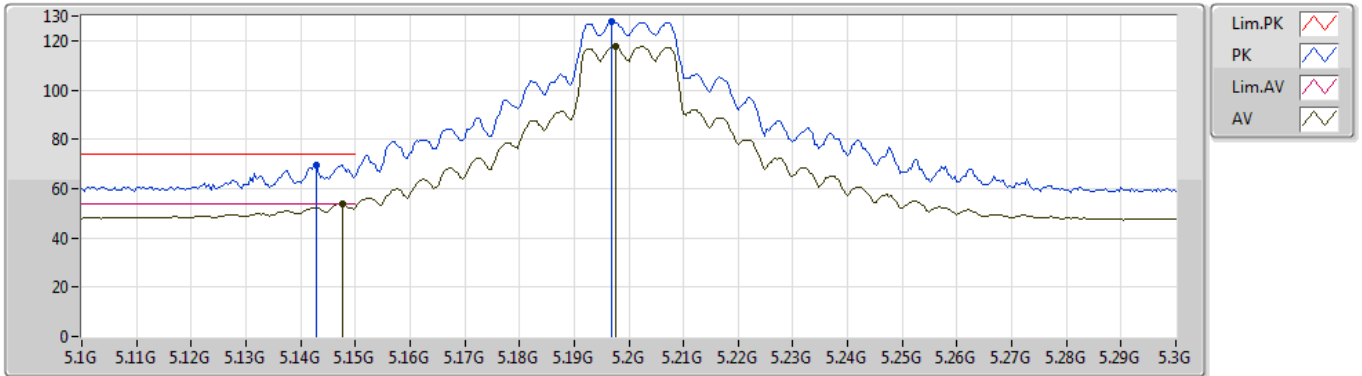

EUT Y_2TX ANT_H
 Setting 25
 02-B-4-10
 FSU(100015)

Type	Freq (Hz)	Level (dBuV/m)	Limit (dBuV/m)	Margin (dB)	Factor (dB)	Dist (m)	Condition	Azimuth (°)	Height (m)	Comment	Raw (dBuV)
PK	5.1428G	69.24	74.00	-4.76	7.94	3	Horizontal	9	2.31	-	61.30
AV	5.1476G	53.81	54.00	-0.19	7.94	3	Horizontal	9	2.31	-	45.87
PK	5.1968G	127.74	Inf	-Inf	8.06	3	Horizontal	9	2.31	-	119.68
AV	5.1976G	117.46	Inf	-Inf	8.06	3	Horizontal	9	2.31	-	109.40

802.11a_Nss1,(6Mbps)_2TX

23/08/2019

5200MHz_TX

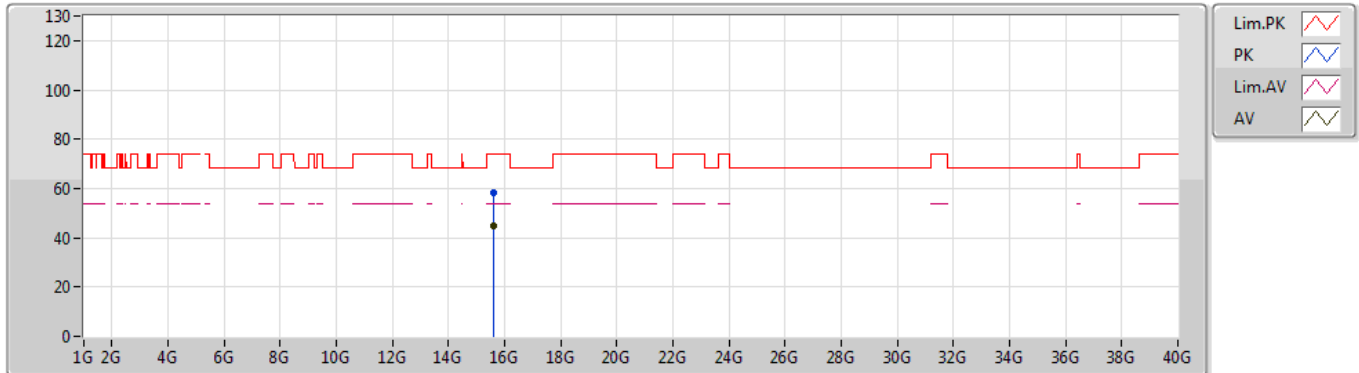

EUT Y_2TX ANT_H
 Setting 25
 02-B-4
 FSU(100015)

Type	Freq (Hz)	Level (dBuV/m)	Limit (dBuV/m)	Margin (dB)	Factor (dB)	Dist (m)	Condition	Azimuth (°)	Height (m)	Comment	Raw (dBuV)
PK	15.60342G	58.00	74.00	-16.00	15.90	3	Vertical	322	1.54	-	42.10
AV	15.6031G	44.75	54.00	-9.25	15.90	3	Vertical	322	1.54	-	28.85

802.11a_Nss1,(6Mbps)_2TX

23/08/2019

5200MHz_TX

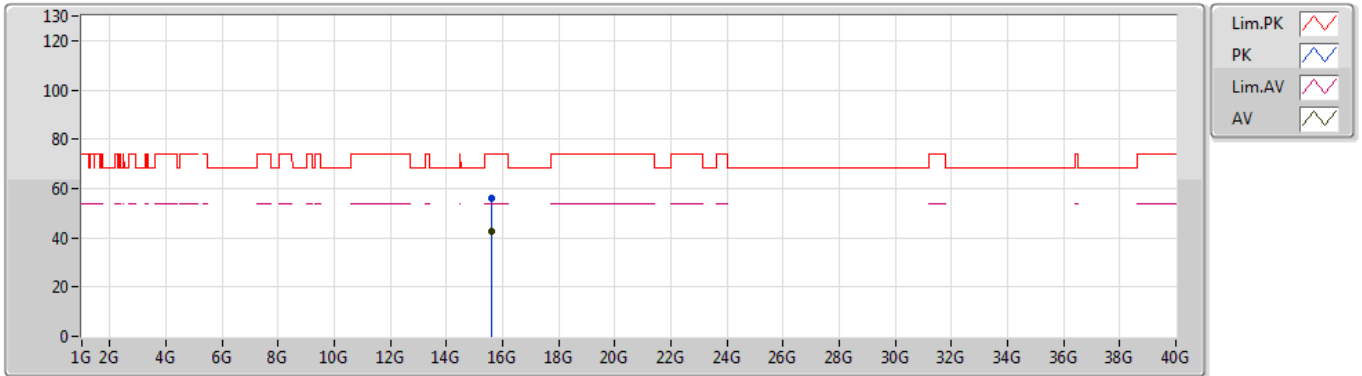

EUT Y_2TX ANT_H
 Setting 25
 02-B-4
 FSU(100015)

Type	Freq (Hz)	Level (dBuV/m)	Limit (dBuV/m)	Margin (dB)	Factor (dB)	Dist (m)	Condition	Azimuth (°)	Height (m)	Comment	Raw (dBuV)
PK	15.60288G	56.02	74.00	-17.98	15.90	3	Horizontal	331	1.53	-	40.12
AV	15.60232G	42.61	54.00	-11.39	15.90	3	Horizontal	331	1.53	-	26.71

802.11a_Nss1,(6Mbps)_2TX

23/08/2019

5240MHz_TX

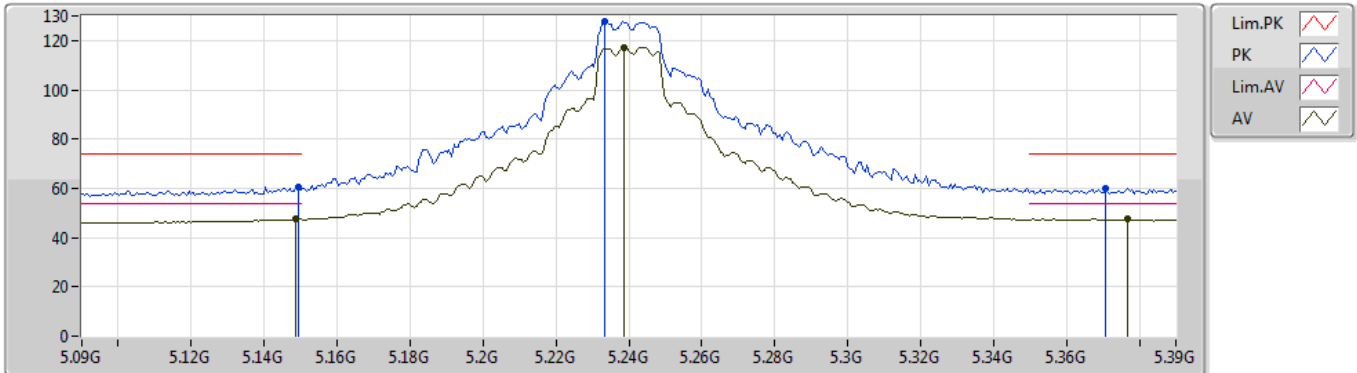

EUT_Y_2TX ANT_H
Setting 26
02-B-4-10
FSU(100015)

Type	Freq (Hz)	Level (dBuV/m)	Limit (dBuV/m)	Margin (dB)	Factor (dB)	Dist (m)	Condition	Azimuth (°)	Height (m)	Comment	Raw (dBuV)
PK	5.1494G	60.69	74.00	-13.31	7.94	3	Vertical	14	1.88	-	52.75
AV	5.1488G	47.59	54.00	-6.41	7.94	3	Vertical	14	1.88	-	39.65
PK	5.2334G	128.02	Inf	-Inf	8.11	3	Vertical	14	1.88	-	119.91
AV	5.2388G	117.38	Inf	-Inf	8.12	3	Vertical	14	1.88	-	109.26
PK	5.3708G	60.20	74.00	-13.80	8.30	3	Vertical	14	1.88	-	51.90
AV	5.3768G	47.71	54.00	-6.29	8.31	3	Vertical	14	1.88	-	39.40

802.11a_Nss1,(6Mbps)_2TX

23/08/2019

5240MHz_TX

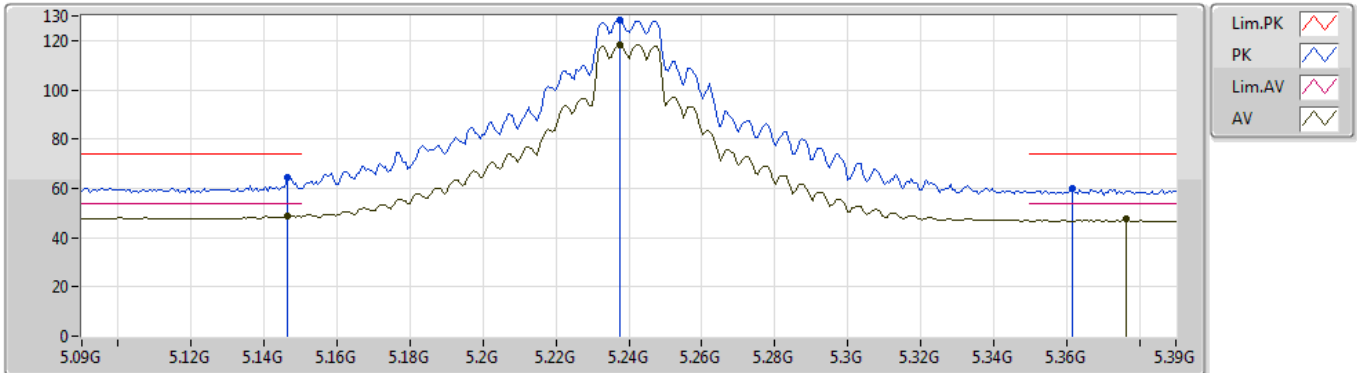

EUT_Y_2TX ANT_H
Setting 26
02-B-4-10
FSU(100015)

Type	Freq (Hz)	Level (dBuV/m)	Limit (dBuV/m)	Margin (dB)	Factor (dB)	Dist (m)	Condition	Azimuth (°)	Height (m)	Comment	Raw (dBuV)
PK	5.1464G	64.65	74.00	-9.35	7.94	3	Horizontal	7	2.54	-	56.71
AV	5.1464G	48.72	54.00	-5.28	7.94	3	Horizontal	7	2.54	-	40.78
PK	5.2376G	128.44	Inf	-Inf	8.12	3	Horizontal	7	2.54	-	120.32
AV	5.2376G	118.26	Inf	-Inf	8.12	3	Horizontal	7	2.54	-	110.14
PK	5.3618G	59.92	74.00	-14.08	8.29	3	Horizontal	7	2.54	-	51.63
AV	5.3762G	47.69	54.00	-6.31	8.31	3	Horizontal	7	2.54	-	39.38

802.11a_Nss1,(6Mbps)_2TX

23/08/2019

5240MHz_TX

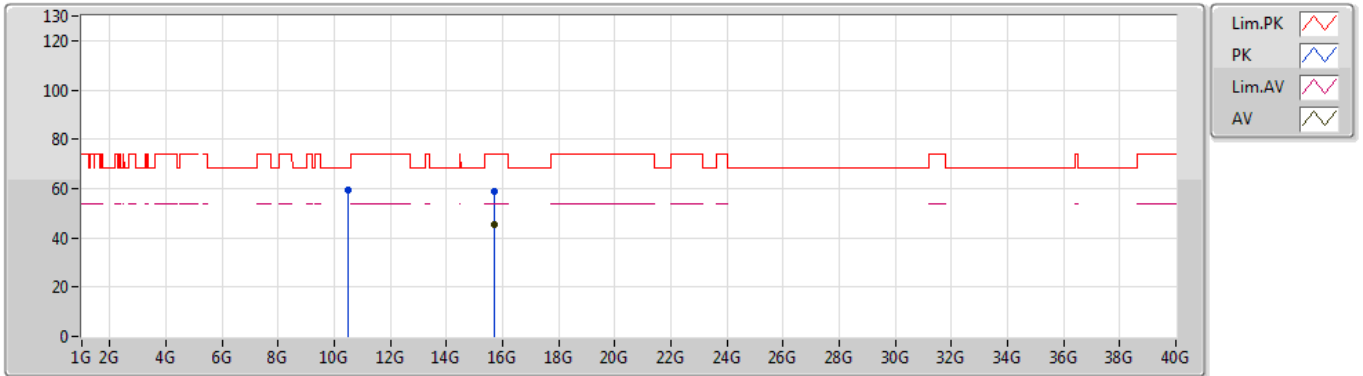

EUT Y_2TX ANT_H
Setting 26
02-B-4
FSU(100015)

Type	Freq (Hz)	Level (dBuV/m)	Limit (dBuV/m)	Margin (dB)	Factor (dB)	Dist (m)	Condition	Azimuth (°)	Height (m)	Comment	Raw (dBuV)
PK	10.48096G	59.45	68.20	-8.75	14.58	3	Vertical	348	2.82	-	44.87
PK	15.71382G	59.06	74.00	-14.94	15.62	3	Vertical	319	1.77	-	43.44
AV	15.71832G	45.66	54.00	-8.34	15.61	3	Vertical	319	1.77	-	30.05

802.11a_Nss1,(6Mbps)_2TX

23/08/2019

5240MHz_TX

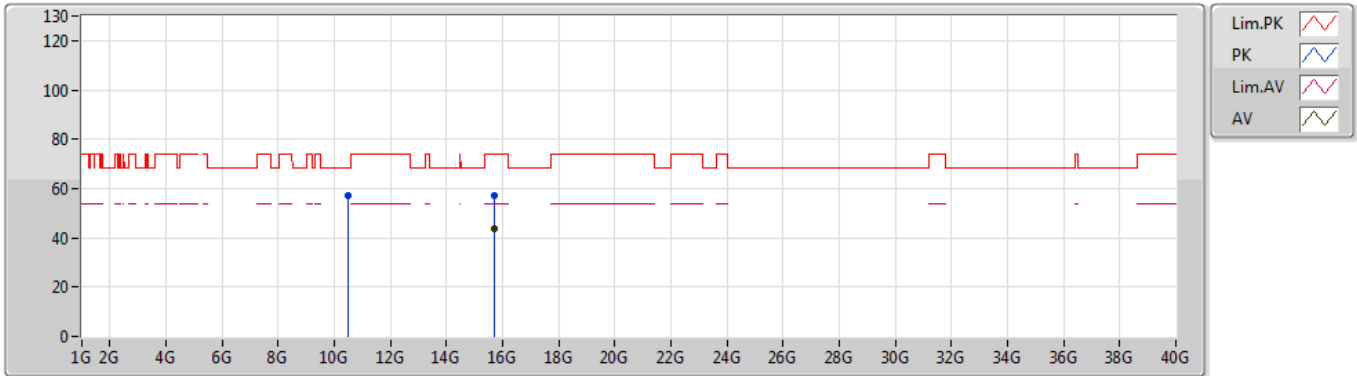

EUT_Y_2TX ANT_H
Setting 26
02-B-4
FSU(100015)

Type	Freq (Hz)	Level (dBuV/m)	Limit (dBuV/m)	Margin (dB)	Factor (dB)	Dist (m)	Condition	Azimuth (°)	Height (m)	Comment	Raw (dBuV)
PK	10.48072G	57.33	68.20	-10.87	14.58	3	Horizontal	130	2.29	-	42.75
PK	15.72012G	57.23	74.00	-16.77	15.60	3	Horizontal	45	1.68	-	41.63
AV	15.72024G	43.51	54.00	-10.49	15.60	3	Horizontal	45	1.68	-	27.91

802.11a_Nss1,(6Mbps)_2TX

23/08/2019

5745MHz_TX

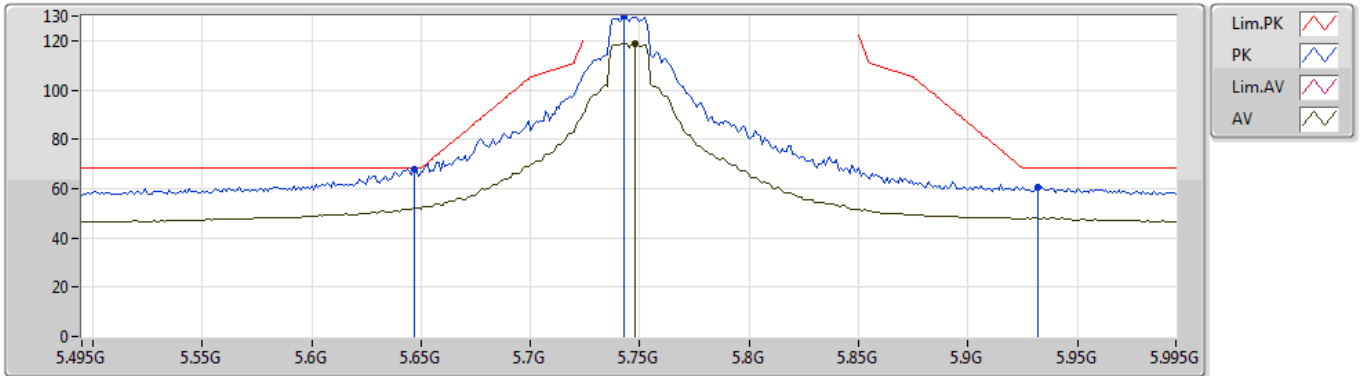

EUT_Y_2TX ANT_H
 Setting 25.5
 02-B-4-10
 FSU(100015)

Type	Freq (Hz)	Level (dBuV/m)	Limit (dBuV/m)	Margin (dB)	Factor (dB)	Dist (m)	Condition	Azimuth (°)	Height (m)	Comment	Raw (dBuV)
PK	5.743G	129.84	Inf	-Inf	8.82	3	Vertical	357	1.81	-	121.02
AV	5.748G	119.07	Inf	-Inf	8.82	3	Vertical	357	1.81	-	110.25
PK	5.932G	60.65	68.20	-7.55	8.93	3	Vertical	357	1.81	-	51.72
PK	5.647G	68.04	68.20	-0.16	8.67	3	Vertical	357	1.81	-	59.37

802.11a_Nss1,(6Mbps)_2TX

23/08/2019

5745MHz_TX

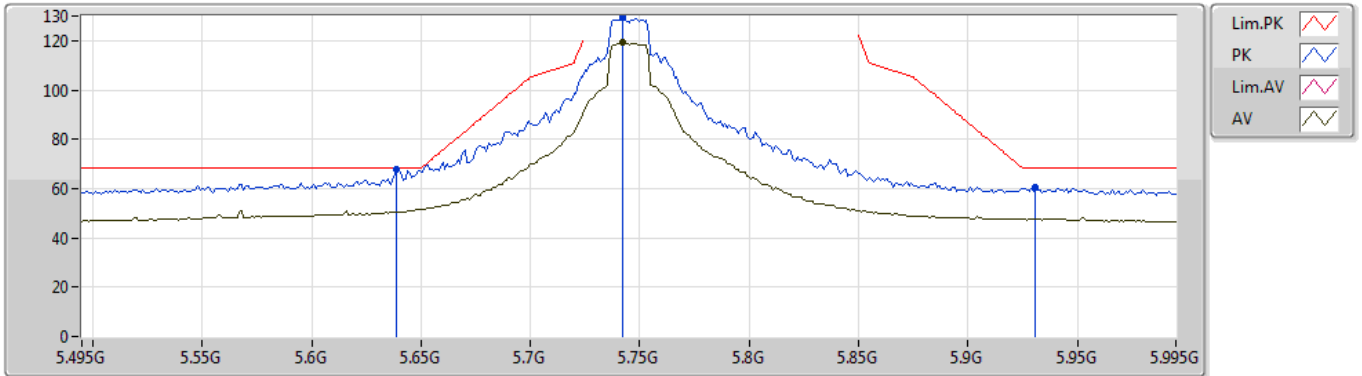

EUT Y_2TX ANT_H
 Setting 25.5
 02-B-4-10
 FSU(100015)

Type	Freq (Hz)	Level (dBuV/m)	Limit (dBuV/m)	Margin (dB)	Factor (dB)	Dist (m)	Condition	Azimuth (°)	Height (m)	Comment	Raw (dBuV)
PK	5.639G	67.83	68.20	-0.37	8.64	3	Horizontal	4	1.71	-	59.19
PK	5.742G	129.47	Inf	-Inf	8.81	3	Horizontal	4	1.71	-	120.66
AV	5.742G	119.20	Inf	-Inf	8.81	3	Horizontal	4	1.71	-	110.39
PK	5.931G	60.55	68.20	-7.65	8.93	3	Horizontal	4	1.71	-	51.62

802.11a_Nss1,(6Mbps)_2TX

23/08/2019

5745MHz_TX

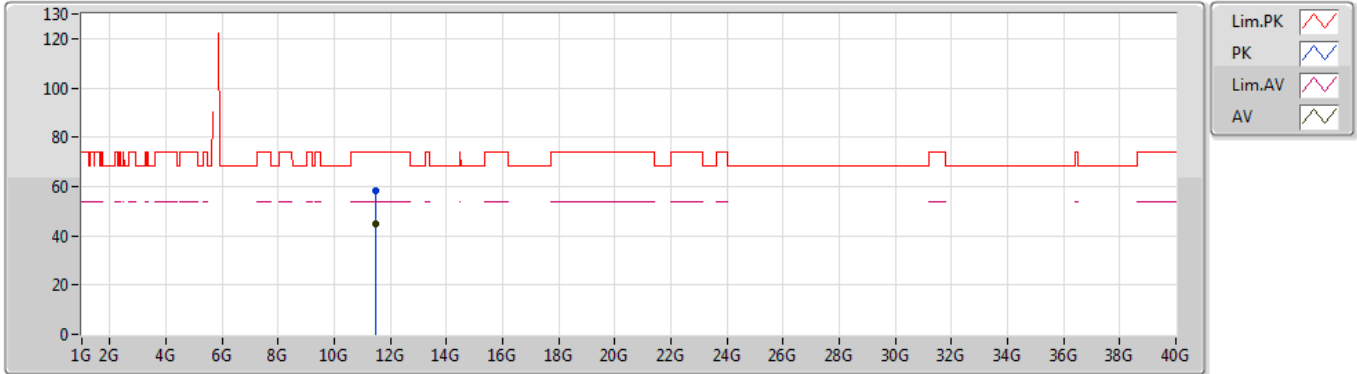

EUT Y_2TX ANT_H
 Setting 25.5
 02-B-4
 FSU(100015)

Type	Freq (Hz)	Level (dBuV/m)	Limit (dBuV/m)	Margin (dB)	Factor (dB)	Dist (m)	Condition	Azimuth (°)	Height (m)	Comment	Raw (dBuV)
PK	11.49336G	58.06	74.00	-15.94	14.89	3	Vertical	1	1.46	-	43.17
AV	11.48796G	44.74	54.00	-9.26	14.89	3	Vertical	1	1.46	-	29.85

802.11a_Nss1,(6Mbps)_2TX

23/08/2019

5745MHz_TX

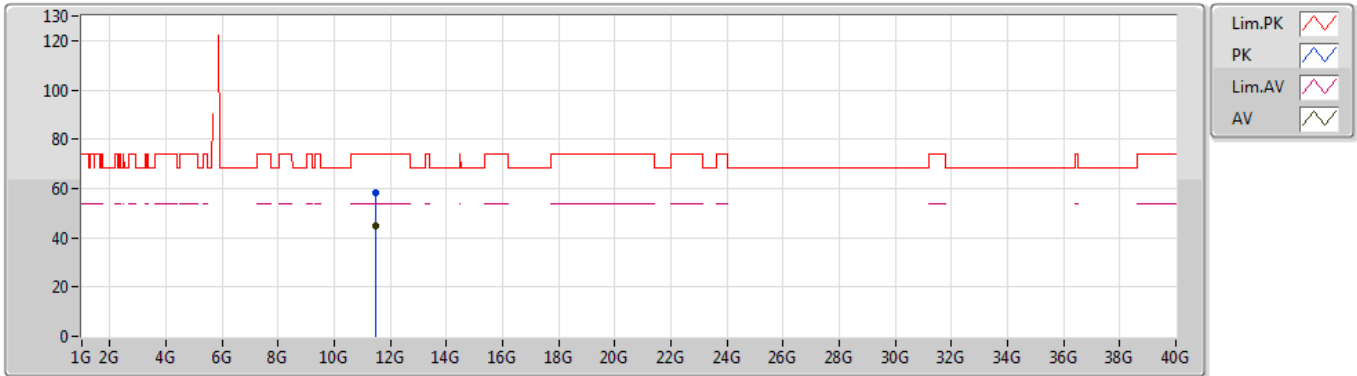

EUT Y_2TX ANT_H
 Setting 25.5
 02-B-4
 FSU(100015)

Type	Freq (Hz)	Level (dBuV/m)	Limit (dBuV/m)	Margin (dB)	Factor (dB)	Dist (m)	Condition	Azimuth (°)	Height (m)	Comment	Raw (dBuV)
PK	11.49078G	58.34	74.00	-15.66	14.89	3	Horizontal	3	1.58	-	43.45
AV	11.49084G	44.59	54.00	-9.41	14.89	3	Horizontal	3	1.58	-	29.70

802.11a_Nss1,(6Mbps)_2TX

23/08/2019

5785MHz_TX

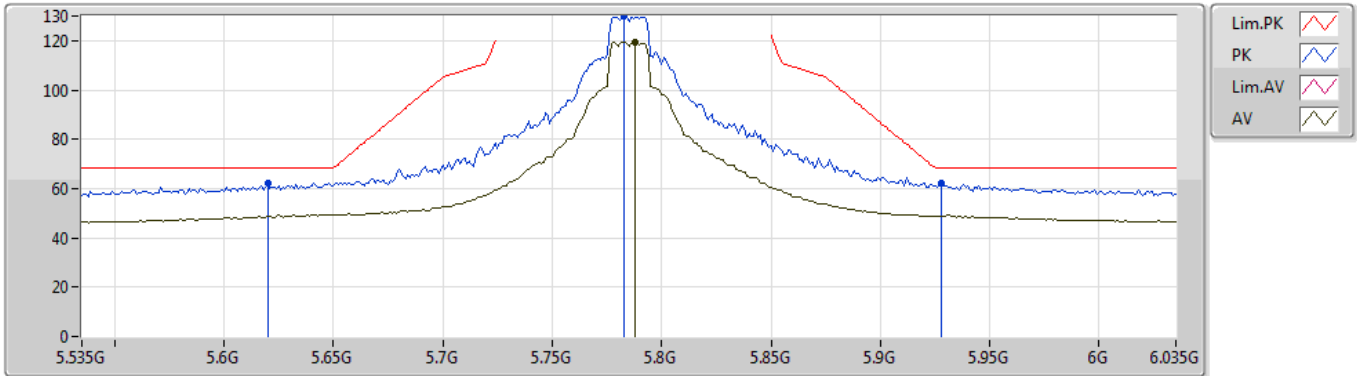

EUT Y_2TX ANT_H
Setting 26
02-B-4-10
FSU(100015)

Type	Freq (Hz)	Level (dBuV/m)	Limit (dBuV/m)	Margin (dB)	Factor (dB)	Dist (m)	Condition	Azimuth (°)	Height (m)	Comment	Raw (dBuV)
PK	5.62G	62.32	68.20	-5.88	8.61	3	Vertical	6	1.98	-	53.71
PK	5.783G	130.07	Inf	-Inf	8.88	3	Vertical	6	1.98	-	121.19
AV	5.788G	119.30	Inf	-Inf	8.87	3	Vertical	6	1.98	-	110.43
PK	5.928G	61.94	68.20	-6.26	8.93	3	Vertical	6	1.98	-	53.01

802.11a_Nss1,(6Mbps)_2TX

23/08/2019

5785MHz_TX

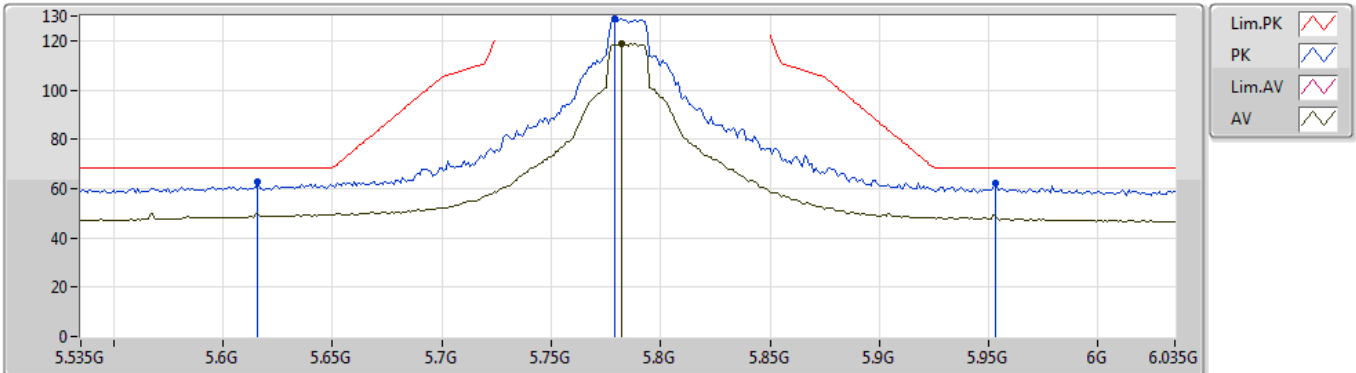

EUT_Y_2TX ANT_H
 Setting 26
 02-B-4-10
 FSU(100015)

Type	Freq (Hz)	Level (dBuV/m)	Limit (dBuV/m)	Margin (dB)	Factor (dB)	Dist (m)	Condition	Azimuth (°)	Height (m)	Comment	Raw (dBuV)
PK	5.616G	62.97	68.20	-5.23	8.61	3	Horizontal	6	1.67	-	54.36
PK	5.779G	128.83	Inf	-Inf	8.87	3	Horizontal	6	1.67	-	119.96
AV	5.782G	118.60	Inf	-Inf	8.88	3	Horizontal	6	1.67	-	109.72
PK	5.953G	62.44	68.20	-5.76	8.92	3	Horizontal	6	1.67	-	53.52

802.11a_Nss1,(6Mbps)_2TX

23/08/2019

5785MHz_TX

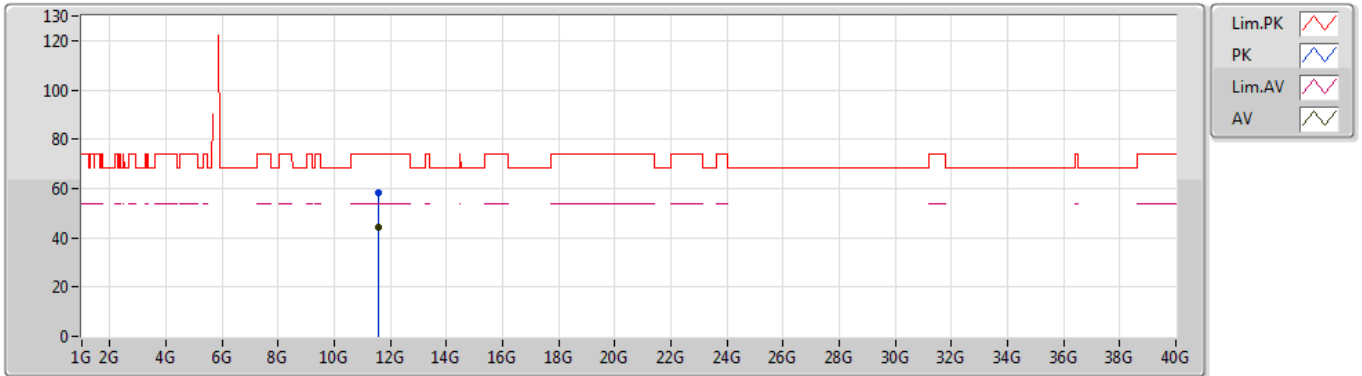

EUT Y_2TX ANT_H
Setting 26
02-B-4
FSU(100015)

Type	Freq (Hz)	Level (dBuV/m)	Limit (dBuV/m)	Margin (dB)	Factor (dB)	Dist (m)	Condition	Azimuth (°)	Height (m)	Comment	Raw (dBuV)
PK	11.56814G	58.42	74.00	-15.58	14.99	3	Vertical	355	1.05	-	43.43
AV	11.56862G	44.50	54.00	-9.50	14.99	3	Vertical	355	1.05	-	29.51

802.11a_Nss1,(6Mbps)_2TX

23/08/2019

5785MHz_TX

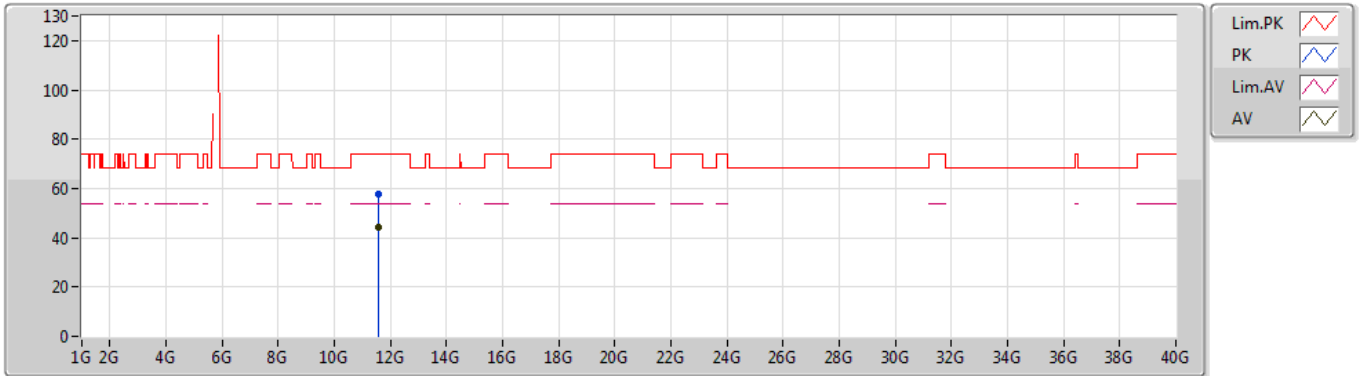

EUT_Y_2TX ANT_H
Setting 26
02-B-4
FSU(100015)

Type	Freq (Hz)	Level (dBuV/m)	Limit (dBuV/m)	Margin (dB)	Factor (dB)	Dist (m)	Condition	Azimuth (°)	Height (m)	Comment	Raw (dBuV)
PK	11.56424G	57.71	74.00	-16.29	14.99	3	Horizontal	1	1.50	-	42.72
AV	11.56988G	44.44	54.00	-9.56	15.00	3	Horizontal	1	1.50	-	29.44

802.11a_Nss1,(6Mbps)_2TX

23/08/2019

5825MHz_TX

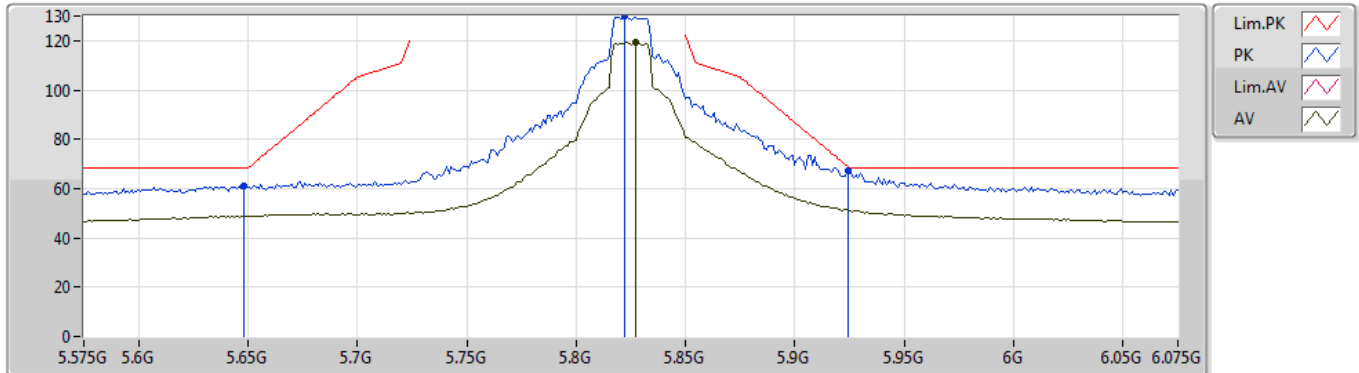

EUT Y_2TX ANT_H
 Setting 26
 02-B-4-10
 FSU(100015)

Type	Freq (Hz)	Level (dBuV/m)	Limit (dBuV/m)	Margin (dB)	Factor (dB)	Dist (m)	Condition	Azimuth (°)	Height (m)	Comment	Raw (dBuV)
PK	5.648G	60.99	68.20	-7.21	8.67	3	Vertical	360	1.96	-	52.32
PK	5.822G	129.88	Inf	-Inf	8.90	3	Vertical	360	1.96	-	120.98
AV	5.827G	119.28	Inf	-Inf	8.91	3	Vertical	360	1.96	-	110.37
PK	5.924G	67.02	68.94	-1.92	8.92	3	Vertical	360	1.96	-	58.10

802.11a_Nss1,(6Mbps)_2TX

23/08/2019

5825MHz_TX

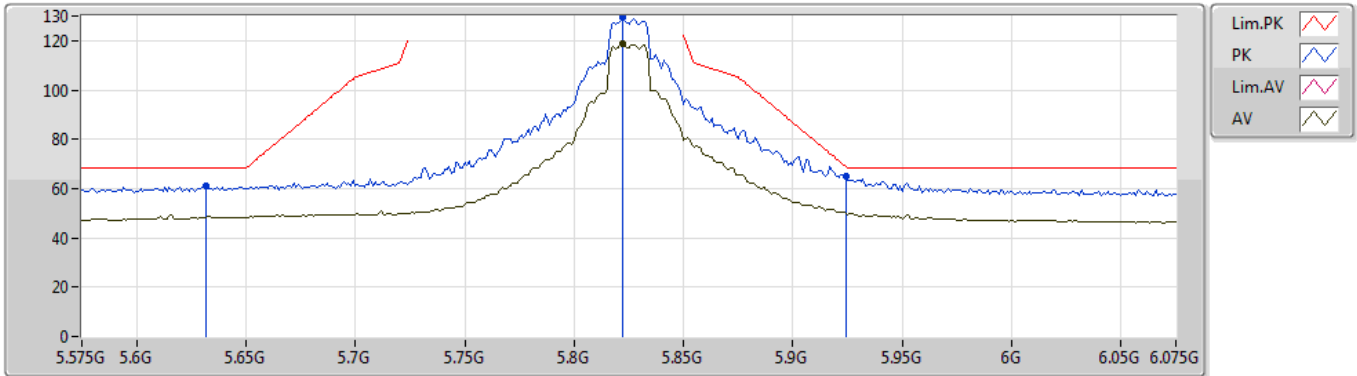

EUT Y_2TX ANT_H
Setting 26
02-B-4-10
FSU(100015)

Type	Freq (Hz)	Level (dBuV/m)	Limit (dBuV/m)	Margin (dB)	Factor (dB)	Dist (m)	Condition	Azimuth (°)	Height (m)	Comment	Raw (dBuV)
PK	5.632G	61.14	68.20	-7.06	8.63	3	Horizontal	3	1.87	-	52.51
PK	5.822G	129.25	Inf	-Inf	8.90	3	Horizontal	3	1.87	-	120.35
AV	5.822G	118.76	Inf	-Inf	8.90	3	Horizontal	3	1.87	-	109.86
PK	5.924G	64.80	68.94	-4.14	8.92	3	Horizontal	3	1.87	-	55.88

802.11a_Nss1,(6Mbps)_2TX

23/08/2019

5825MHz_TX

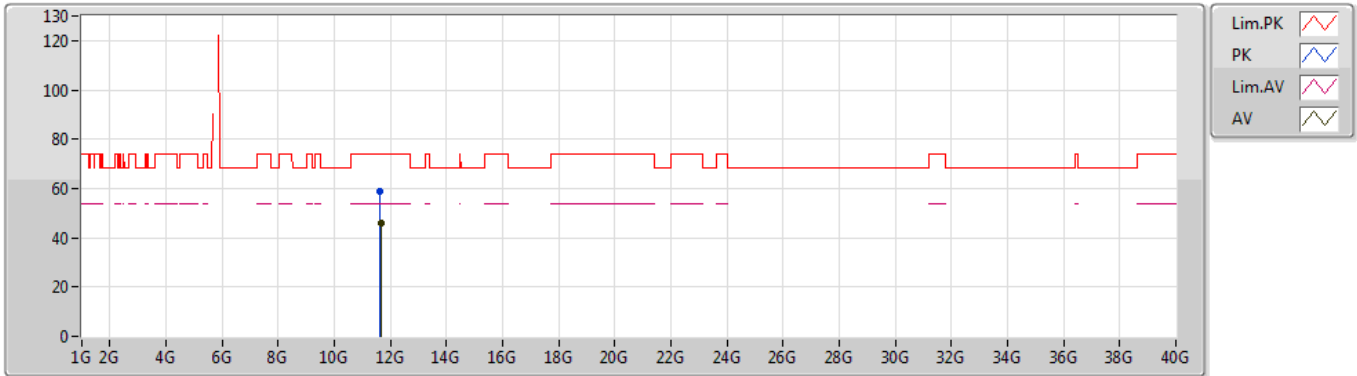

EUT Y_2TX ANT_H
Setting 26
02-B-4
FSU(100015)

Type	Freq (Hz)	Level (dBuV/m)	Limit (dBuV/m)	Margin (dB)	Factor (dB)	Dist (m)	Condition	Azimuth (°)	Height (m)	Comment	Raw (dBuV)
PK	11.64694G	58.89	74.00	-15.11	15.09	3	Vertical	16	1.65	-	43.80
AV	11.65222G	46.07	54.00	-7.93	15.10	3	Vertical	16	1.65	-	30.97

802.11a_Nss1,(6Mbps)_2TX

23/08/2019

5825MHz_TX

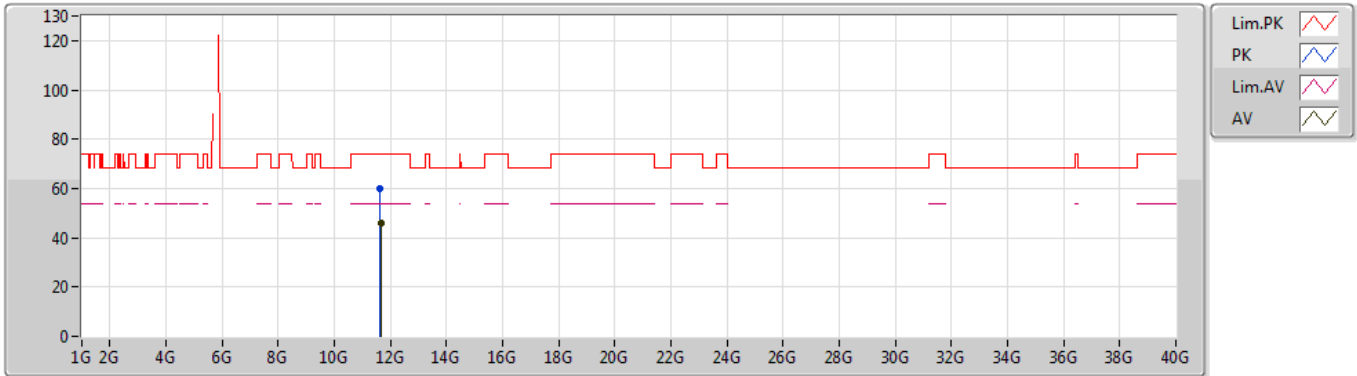

EUT Y_2TX ANT_H
Setting 26
02-B-4
FSU(100015)

Type	Freq (Hz)	Level (dBuV/m)	Limit (dBuV/m)	Margin (dB)	Factor (dB)	Dist (m)	Condition	Azimuth (°)	Height (m)	Comment	Raw (dBuV)
PK	11.64436G	59.82	74.00	-14.18	15.09	3	Horizontal	2	1.54	-	44.73
AV	11.64988G	45.67	54.00	-8.33	15.09	3	Horizontal	2	1.54	-	30.58

802.11ac VHT20_Nss1,(MCS0)_2TX

24/08/2019

5180MHz_TX

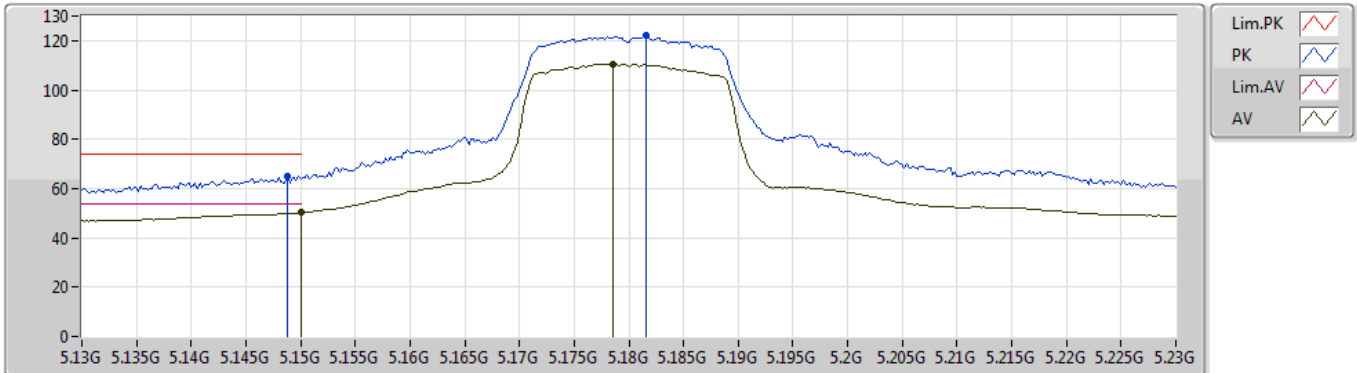

EUT Y_2TX ANT_H
Setting 20
02-B-4-10
FSU(100015)

Type	Freq (Hz)	Level (dBuV/m)	Limit (dBuV/m)	Margin (dB)	Factor (dB)	Dist (m)	Condition	Azimuth (°)	Height (m)	Comment	Raw (dBuV)
PK	5.1488G	65.09	74.00	-8.91	7.94	3	Vertical	11	1.88	-	57.15
AV	5.15G	50.17	54.00	-3.83	7.94	3	Vertical	11	1.88	-	42.23
PK	5.1816G	121.91	Inf	-Inf	8.02	3	Vertical	11	1.88	-	113.89
AV	5.1786G	110.66	Inf	-Inf	8.02	3	Vertical	11	1.88	-	102.64

802.11ac VHT20_Nss1,(MCS0)_2TX

24/08/2019

5180MHz_TX

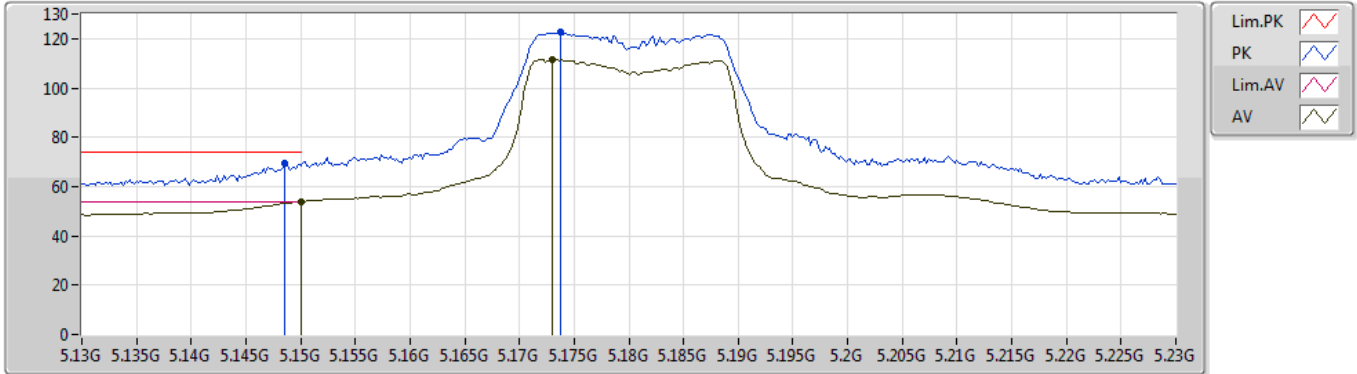

EUT Y_2TX ANT_H
Setting 20
02-B-4-10
FSU(100015)

Type	Freq (Hz)	Level (dBuV/m)	Limit (dBuV/m)	Margin (dB)	Factor (dB)	Dist (m)	Condition	Azimuth (°)	Height (m)	Comment	Raw (dBuV)
PK	5.1486G	69.41	74.00	-4.59	7.94	3	Horizontal	3	2.66	-	61.47
AV	5.15G	53.78	54.00	-0.22	7.94	3	Horizontal	3	2.66	-	45.84
PK	5.1738G	122.51	Inf	-Inf	8.00	3	Horizontal	3	2.66	-	114.51
AV	5.173G	111.53	Inf	-Inf	8.00	3	Horizontal	3	2.66	-	103.53

802.11ac VHT20_Nss1,(MCS0)_2TX

24/08/2019

5180MHz_TX

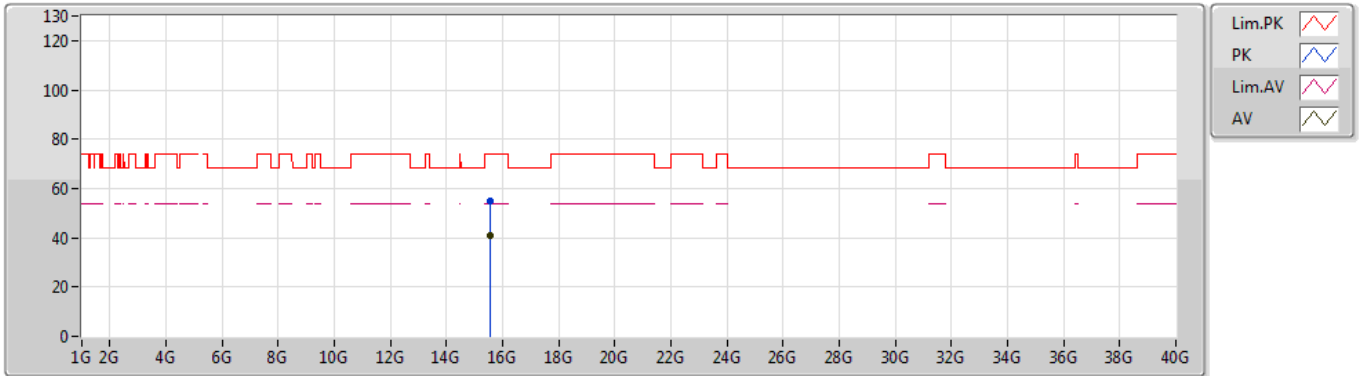

EUT Y_2TX ANT_H
Setting 20
02-B-4
FSU(100015)

Type	Freq (Hz)	Level (dBuV/m)	Limit (dBuV/m)	Margin (dB)	Factor (dB)	Dist (m)	Condition	Azimuth (°)	Height (m)	Comment	Raw (dBuV)
PK	15.54458G	55.17	74.00	-18.83	16.06	3	Vertical	264	1.40	-	39.11
AV	15.54432G	41.00	54.00	-13.00	16.06	3	Vertical	264	1.40	-	24.94

802.11ac VHT20_Nss1,(MCS0)_2TX

24/08/2019

5180MHz_TX

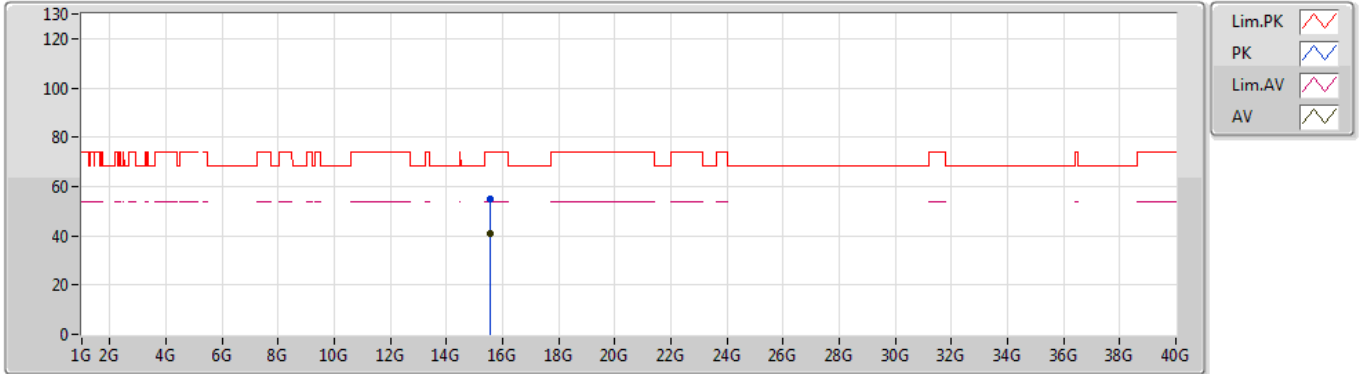

EUT Y_2TX ANT_H
Setting 20
02-B-4
FSU(100015)

Type	Freq (Hz)	Level (dBuV/m)	Limit (dBuV/m)	Margin (dB)	Factor (dB)	Dist (m)	Condition	Azimuth (°)	Height (m)	Comment	Raw (dBuV)
PK	15.53456G	54.94	74.00	-19.06	16.09	3	Horizontal	309	1.63	-	38.85
AV	15.53486G	40.88	54.00	-13.12	16.09	3	Horizontal	309	1.63	-	24.79

802.11ac VHT20_Nss1,(MCS0)_2TX

23/08/2019

5200MHz_TX

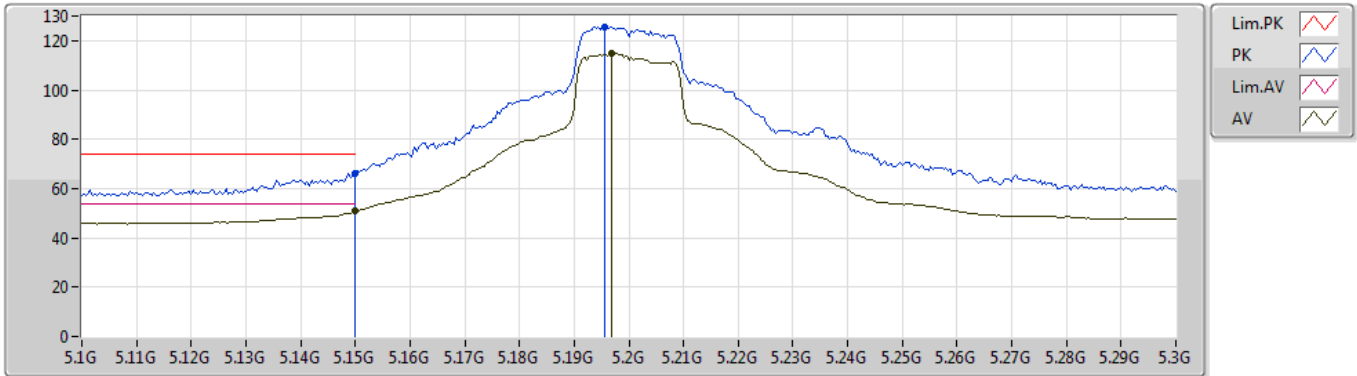

EUT Y_2TX ANT_H
Setting 24.5
02-B-4-10
FSU(100015)

Type	Freq (Hz)	Level (dBuV/m)	Limit (dBuV/m)	Margin (dB)	Factor (dB)	Dist (m)	Condition	Azimuth (°)	Height (m)	Comment	Raw (dBuV)
PK	5.15G	65.96	74.00	-8.04	7.94	3	Vertical	10	1.93	-	58.02
AV	5.15G	50.74	54.00	-3.26	7.94	3	Vertical	10	1.93	-	42.80
PK	5.1956G	125.37	Inf	-Inf	8.06	3	Vertical	10	1.93	-	117.31
AV	5.1968G	114.70	Inf	-Inf	8.06	3	Vertical	10	1.93	-	106.64

802.11ac VHT20_Nss1,(MCS0)_2TX

23/08/2019

5200MHz_TX

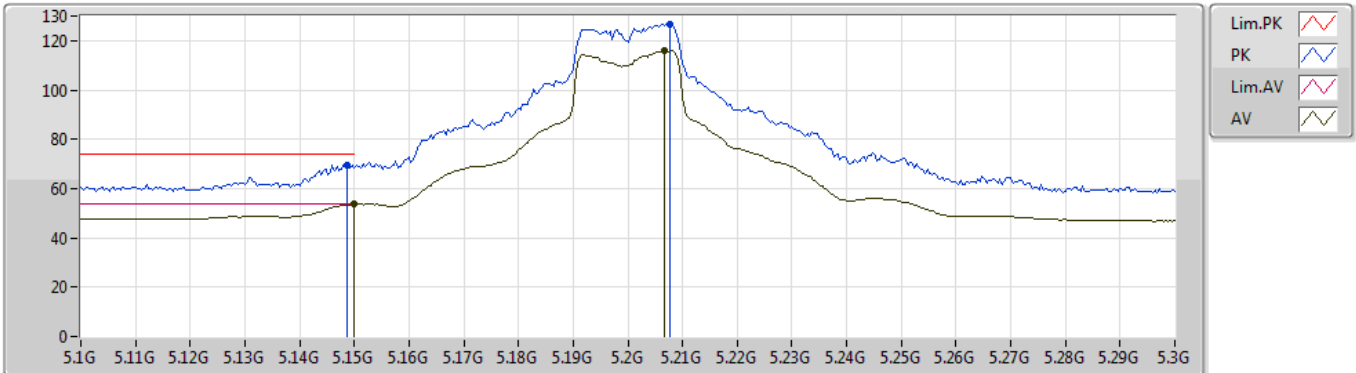

EUT Y_2TX ANT_H
Setting 24.5
02-B-4-10
FSU(100015)

Type	Freq (Hz)	Level (dBuV/m)	Limit (dBuV/m)	Margin (dB)	Factor (dB)	Dist (m)	Condition	Azimuth (°)	Height (m)	Comment	Raw (dBuV)
PK	5.1488G	69.63	74.00	-4.37	7.94	3	Horizontal	8	2.49	-	61.69
AV	5.15G	53.81	54.00	-0.19	7.94	3	Horizontal	8	2.49	-	45.87
PK	5.2076G	126.69	Inf	-Inf	8.07	3	Horizontal	8	2.49	-	118.62
AV	5.2068G	115.76	Inf	-Inf	8.07	3	Horizontal	8	2.49	-	107.69

802.11ac VHT20_Nss1,(MCS0)_2TX

23/08/2019

5200MHz_TX

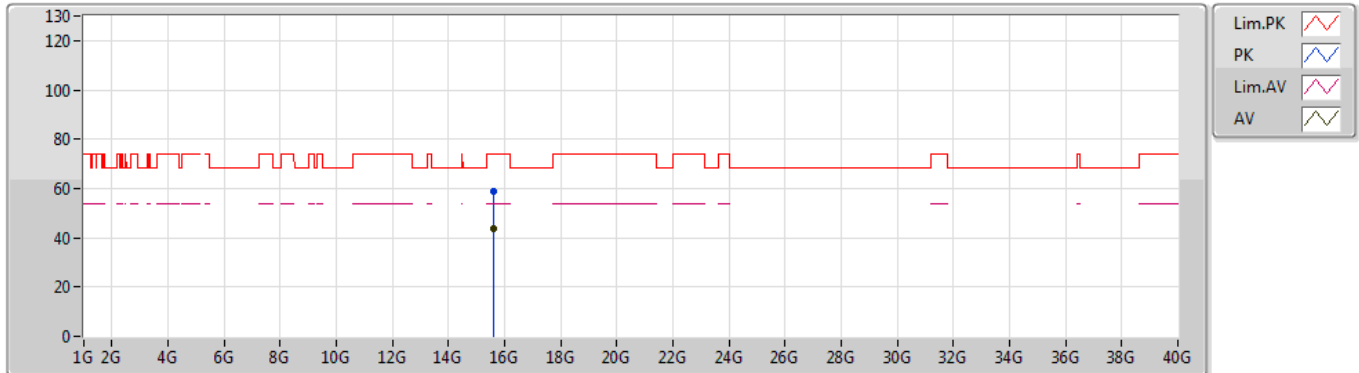

EUT Y_2TX ANT_H
 Setting 24.5
 02-B-4
 FSU(100015)

Type	Freq (Hz)	Level (dBuV/m)	Limit (dBuV/m)	Margin (dB)	Factor (dB)	Dist (m)	Condition	Azimuth (°)	Height (m)	Comment	Raw (dBuV)
PK	15.59562G	58.82	74.00	-15.18	15.92	3	Vertical	326	1.48	-	42.90
AV	15.59556G	43.65	54.00	-10.35	15.92	3	Vertical	326	1.48	-	27.73

802.11ac VHT20_Nss1,(MCS0)_2TX

23/08/2019

5200MHz_TX

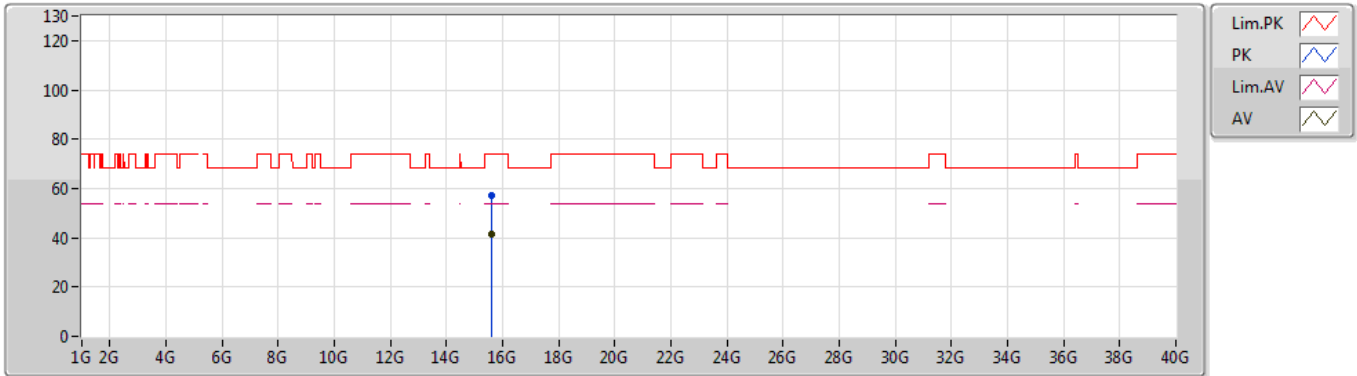

EUT Y_2TX ANT_H
 Setting 24.5
 02-B-4
 FSU(100015)

Type	Freq (Hz)	Level (dBuV/m)	Limit (dBuV/m)	Margin (dB)	Factor (dB)	Dist (m)	Condition	Azimuth (°)	Height (m)	Comment	Raw (dBuV)
PK	15.60678G	56.98	74.00	-17.02	15.89	3	Horizontal	325	1.22	-	41.09
AV	15.60318G	41.73	54.00	-12.27	15.90	3	Horizontal	325	1.22	-	25.83

802.11ac VHT20_Nss1,(MCS0)_2TX

23/08/2019

5240MHz_TX

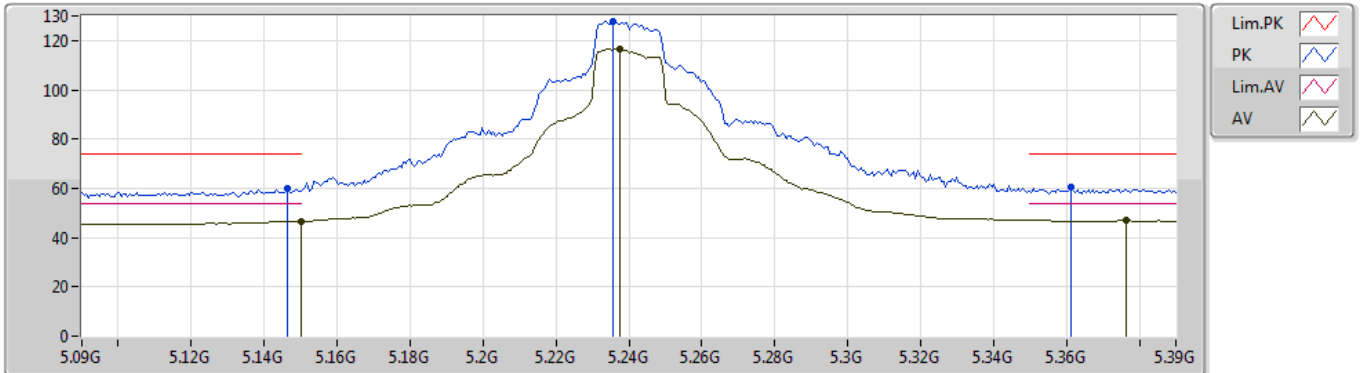

EUT_Y_2TX ANT_H
Setting 26
02-B-4-10
FSU(100015)

Type	Freq (Hz)	Level (dBuV/m)	Limit (dBuV/m)	Margin (dB)	Factor (dB)	Dist (m)	Condition	Azimuth (°)	Height (m)	Comment	Raw (dBuV)
PK	5.1464G	59.81	74.00	-14.19	7.94	3	Vertical	7	1.84	-	51.87
AV	5.15G	46.52	54.00	-7.48	7.94	3	Vertical	7	1.84	-	38.58
PK	5.2358G	127.53	Inf	-Inf	8.11	3	Vertical	7	1.84	-	119.42
AV	5.2376G	116.72	Inf	-Inf	8.12	3	Vertical	7	1.84	-	108.60
PK	5.3612G	60.42	74.00	-13.58	8.29	3	Vertical	7	1.84	-	52.13
AV	5.3762G	47.26	54.00	-6.74	8.31	3	Vertical	7	1.84	-	38.95

802.11ac VHT20_Nss1,(MCS0)_2TX

23/08/2019

5240MHz_TX

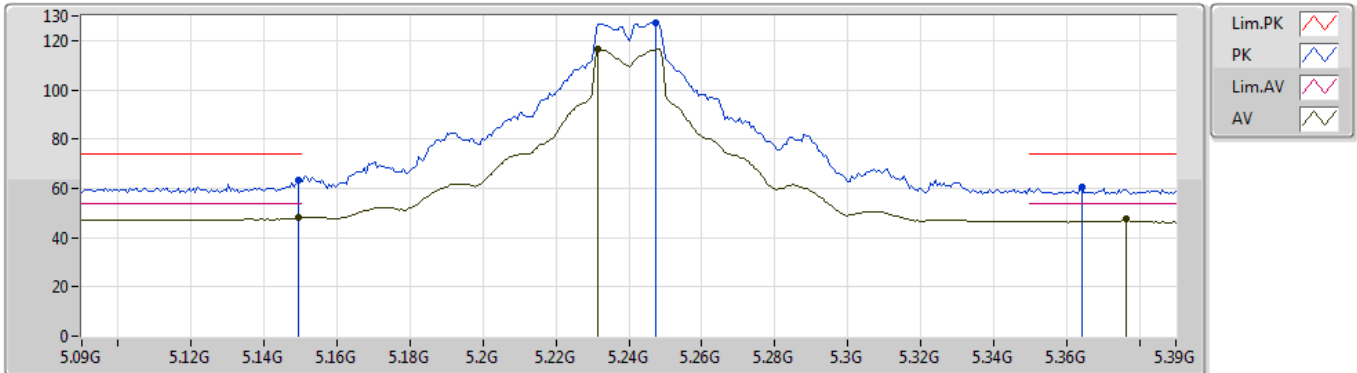

EUT_Y_2TX ANT_H
Setting 26
02-B-4-10
FSU(100015)

Type	Freq (Hz)	Level (dBuV/m)	Limit (dBuV/m)	Margin (dB)	Factor (dB)	Dist (m)	Condition	Azimuth (°)	Height (m)	Comment	Raw (dBuV)
PK	5.1494G	63.50	74.00	-10.50	7.94	3	Horizontal	12	2.43	-	55.56
AV	5.1494G	47.98	54.00	-6.02	7.94	3	Horizontal	12	2.43	-	40.04
PK	5.2472G	127.47	Inf	-Inf	8.13	3	Horizontal	12	2.43	-	119.34
AV	5.2316G	116.52	Inf	-Inf	8.11	3	Horizontal	12	2.43	-	108.41
PK	5.3642G	60.24	74.00	-13.76	8.29	3	Horizontal	12	2.43	-	51.95
AV	5.3762G	47.55	54.00	-6.45	8.31	3	Horizontal	12	2.43	-	39.24

802.11ac VHT20_Nss1,(MCS0)_2TX

23/08/2019

5240MHz_TX

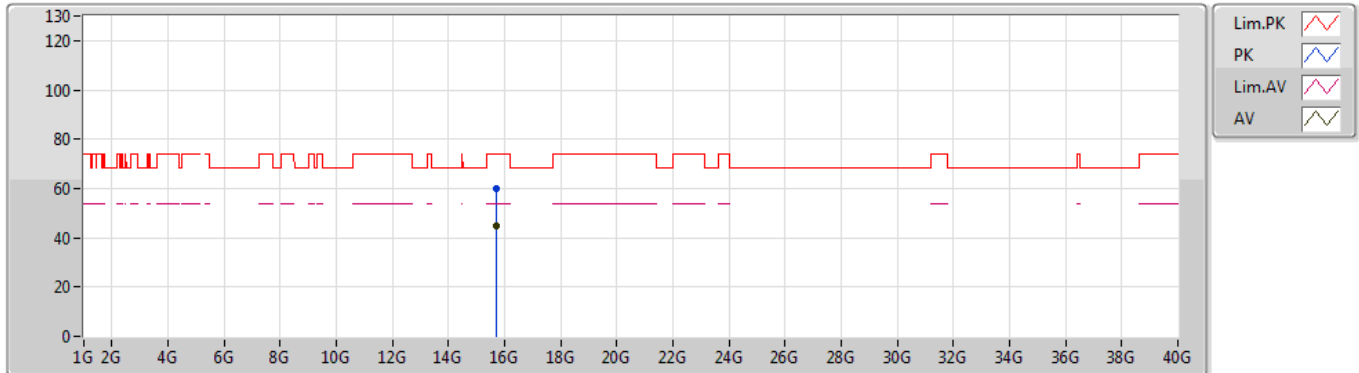

EUT Y_2TX ANT_H
Setting 26
02-B-4
FSU(100015)

Type	Freq (Hz)	Level (dBuV/m)	Limit (dBuV/m)	Margin (dB)	Factor (dB)	Dist (m)	Condition	Azimuth (°)	Height (m)	Comment	Raw (dBuV)
PK	15.71598G	59.90	74.00	-14.10	15.61	3	Vertical	320	1.01	-	44.29
AV	15.71538G	45.01	54.00	-8.99	15.62	3	Vertical	320	1.01	-	29.39

802.11ac VHT20_Nss1,(MCS0)_2TX

23/08/2019

5240MHz_TX

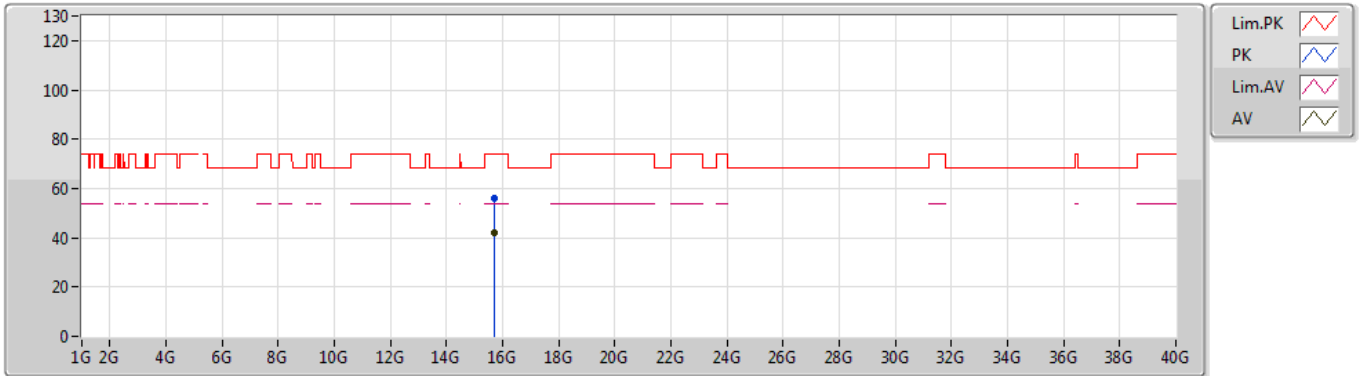

EUT Y_2TX ANT_H
Setting 26
02-B-4
FSU(100015)

Type	Freq (Hz)	Level (dBuV/m)	Limit (dBuV/m)	Margin (dB)	Factor (dB)	Dist (m)	Condition	Azimuth (°)	Height (m)	Comment	Raw (dBuV)
PK	15.71736G	56.08	74.00	-17.92	15.61	3	Horizontal	327	1.48	-	40.47
AV	15.7158G	41.85	54.00	-12.15	15.61	3	Horizontal	327	1.48	-	26.24

802.11ac VHT20_Nss1,(MCS0)_2TX

23/08/2019

5745MHz_TX

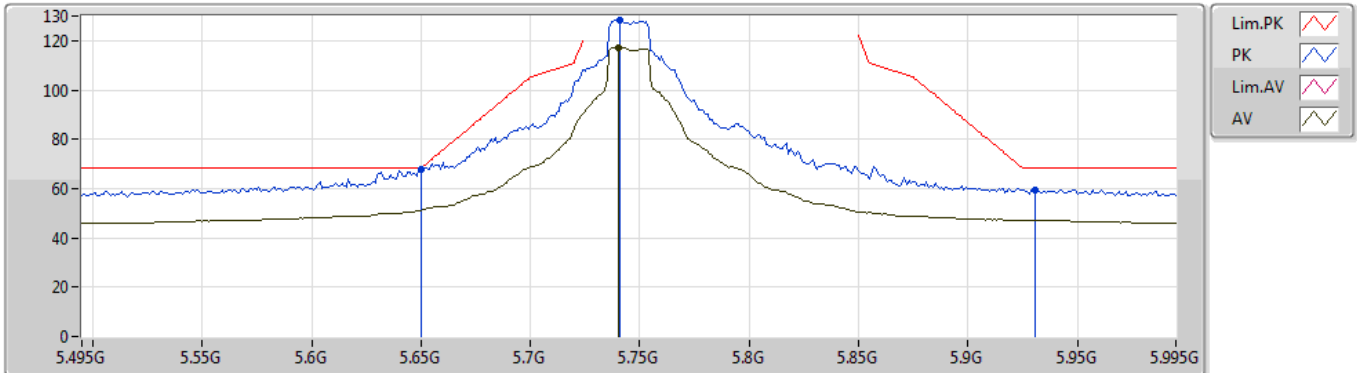

EUT Y_2TX ANT_H
 Setting 25.5
 02-B-4-10
 FSU(100015)

Type	Freq (Hz)	Level (dBuV/m)	Limit (dBuV/m)	Margin (dB)	Factor (dB)	Dist (m)	Condition	Azimuth (°)	Height (m)	Comment	Raw (dBuV)
PK	5.65G	67.87	68.20	-0.33	8.66	3	Vertical	8	1.99	-	59.21
PK	5.741G	128.36	Inf	-Inf	8.80	3	Vertical	8	1.99	-	119.56
AV	5.74G	117.39	Inf	-Inf	8.80	3	Vertical	8	1.99	-	108.59
PK	5.931G	59.59	68.20	-8.61	8.93	3	Vertical	8	1.99	-	50.66

802.11ac VHT20_Nss1,(MCS0)_2TX

23/08/2019

5745MHz_TX

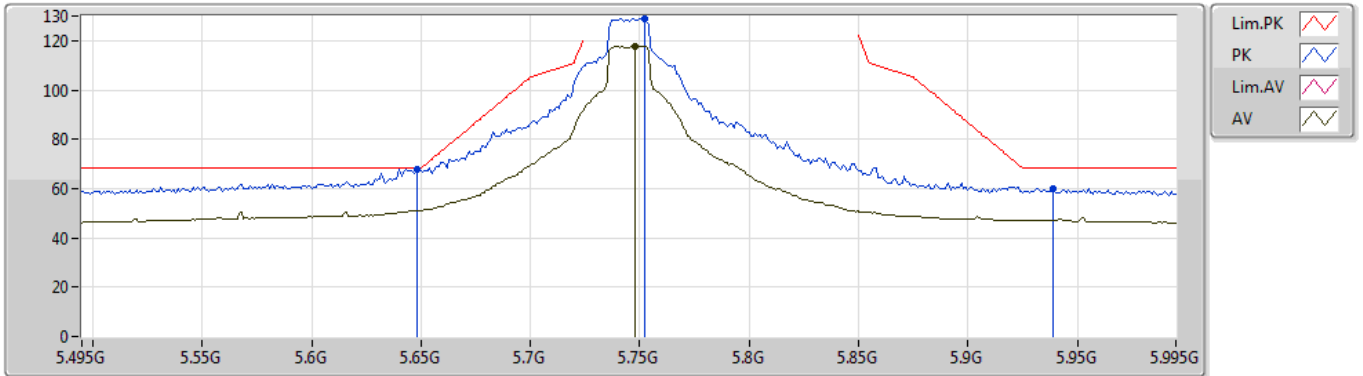

EUT Y_2TX ANT_H
Setting 25.5
02-B-4-10
FSU(100015)

Type	Freq (Hz)	Level (dBuV/m)	Limit (dBuV/m)	Margin (dB)	Factor (dB)	Dist (m)	Condition	Azimuth (°)	Height (m)	Comment	Raw (dBuV)
PK	5.648G	68.03	68.20	-0.17	8.67	3	Horizontal	1	1.71	-	59.36
PK	5.752G	128.78	Inf	-Inf	8.83	3	Horizontal	1	1.71	-	119.95
AV	5.748G	117.77	Inf	-Inf	8.82	3	Horizontal	1	1.71	-	108.95
PK	5.939G	59.89	68.20	-8.31	8.93	3	Horizontal	1	1.71	-	50.96

802.11ac VHT20_Nss1,(MCS0)_2TX

23/08/2019

5745MHz_TX

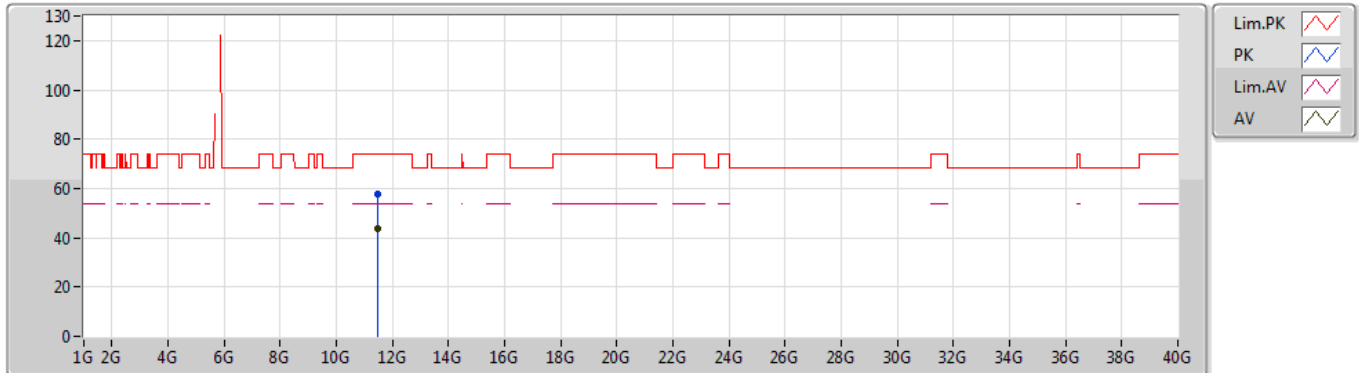

EUT_Y_2TX ANT_H
 Setting 25.5
 02-B-4
 FSU(100015)

Type	Freq (Hz)	Level (dBuV/m)	Limit (dBuV/m)	Margin (dB)	Factor (dB)	Dist (m)	Condition	Azimuth (°)	Height (m)	Comment	Raw (dBuV)
PK	11.4924G	57.75	74.00	-16.25	14.89	3	Vertical	14	2.25	-	42.86
AV	11.49336G	43.78	54.00	-10.22	14.89	3	Vertical	14	2.25	-	28.89

802.11ac VHT20_Nss1,(MCS0)_2TX

23/08/2019

5745MHz_TX

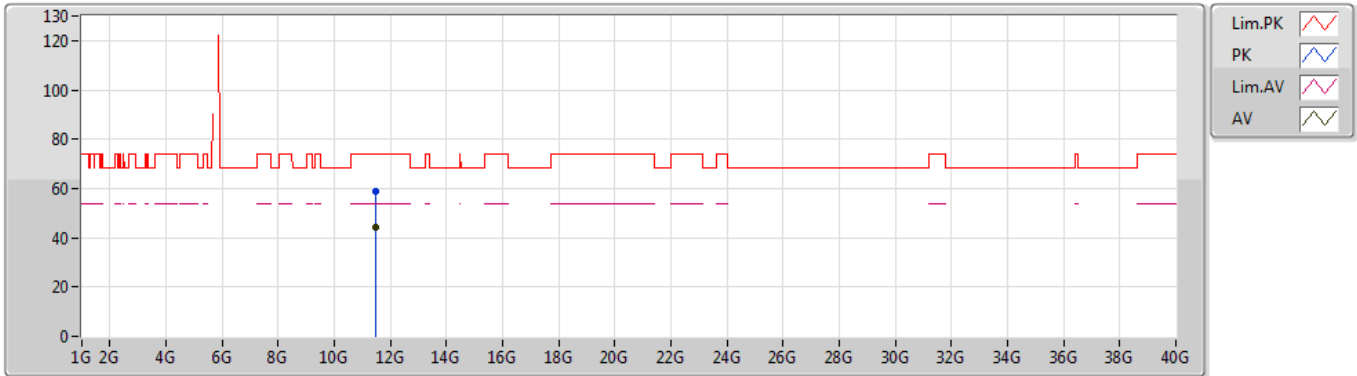

EUT Y_2TX ANT_H
 Setting 25.5
 02-B-4
 FSU(100015)

Type	Freq (Hz)	Level (dBuV/m)	Limit (dBuV/m)	Margin (dB)	Factor (dB)	Dist (m)	Condition	Azimuth (°)	Height (m)	Comment	Raw (dBuV)
PK	11.49258G	58.93	74.00	-15.07	14.89	3	Horizontal	3	1.58	-	44.04
AV	11.49306G	44.44	54.00	-9.56	14.89	3	Horizontal	3	1.58	-	29.55

802.11ac VHT20_Nss1,(MCS0)_2TX

23/08/2019

5785MHz_TX

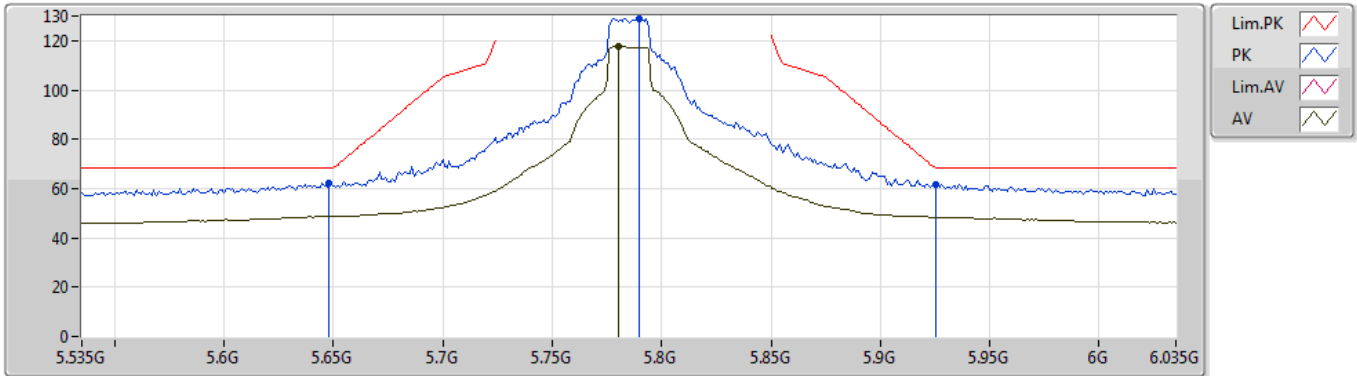

EUT_Y_2TX ANT_H
Setting 26
02-B-4-10
FSU(100015)

Type	Freq (Hz)	Level (dBuV/m)	Limit (dBuV/m)	Margin (dB)	Factor (dB)	Dist (m)	Condition	Azimuth (°)	Height (m)	Comment	Raw (dBuV)
PK	5.648G	61.93	68.20	-6.27	8.67	3	Vertical	6	2.12	-	53.26
PK	5.79G	128.87	Inf	-Inf	8.88	3	Vertical	6	2.12	-	119.99
AV	5.78G	117.94	Inf	-Inf	8.87	3	Vertical	6	2.12	-	109.07
PK	5.925G	61.86	68.20	-6.34	8.93	3	Vertical	6	2.12	-	52.93

802.11ac VHT20_Nss1,(MCS0)_2TX

23/08/2019

5785MHz_TX

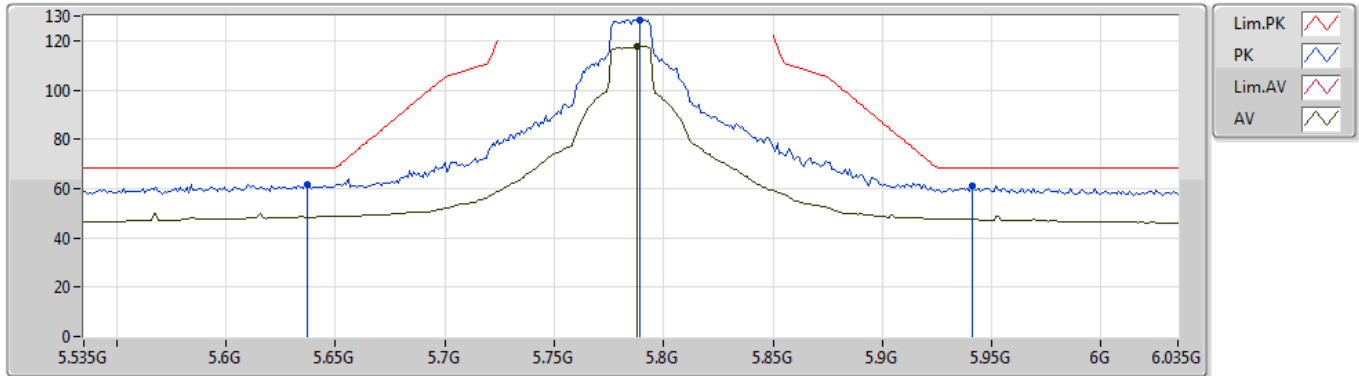

EUT_Y_2TX ANT_H
 Setting 26
 02-B-4-10
 FSU(100015)

Type	Freq (Hz)	Level (dBuV/m)	Limit (dBuV/m)	Margin (dB)	Factor (dB)	Dist (m)	Condition	Azimuth (°)	Height (m)	Comment	Raw (dBuV)
PK	5.637G	61.88	68.20	-6.32	8.64	3	Horizontal	4	1.76	-	53.24
PK	5.789G	128.54	Inf	-Inf	8.88	3	Horizontal	4	1.76	-	119.66
AV	5.788G	117.89	Inf	-Inf	8.87	3	Horizontal	4	1.76	-	109.02
PK	5.941G	61.15	68.20	-7.05	8.93	3	Horizontal	4	1.76	-	52.22

802.11ac VHT20_Nss1,(MCS0)_2TX

23/08/2019

5785MHz_TX

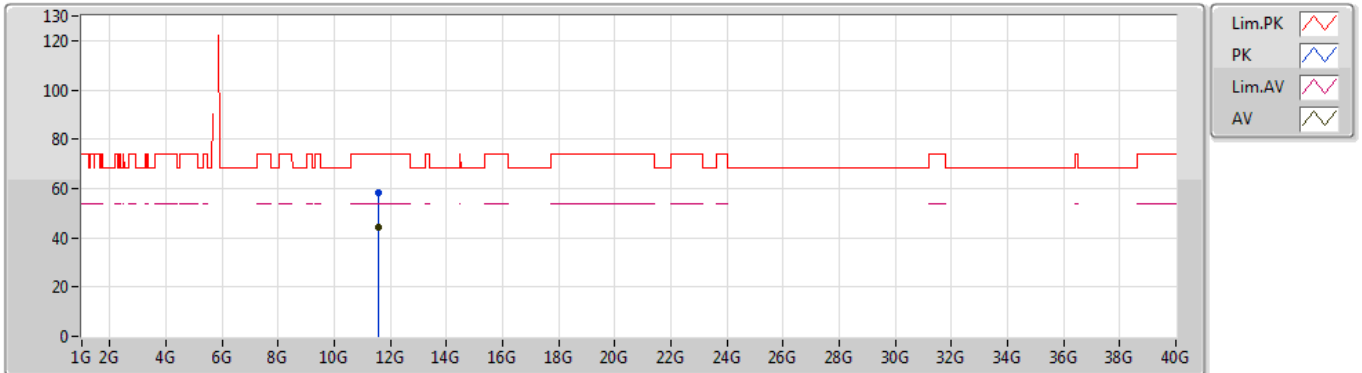

EUT Y_2TX ANT_H
 Setting 26
 02-B-4
 FSU(100015)

Type	Freq (Hz)	Level (dBuV/m)	Limit (dBuV/m)	Margin (dB)	Factor (dB)	Dist (m)	Condition	Azimuth (°)	Height (m)	Comment	Raw (dBuV)
PK	11.56862G	58.36	74.00	-15.64	14.99	3	Vertical	1	1.03	-	43.37
AV	11.56682G	44.05	54.00	-9.95	14.99	3	Vertical	1	1.03	-	29.06

802.11ac VHT20_Nss1,(MCS0)_2TX

23/08/2019

5785MHz_TX

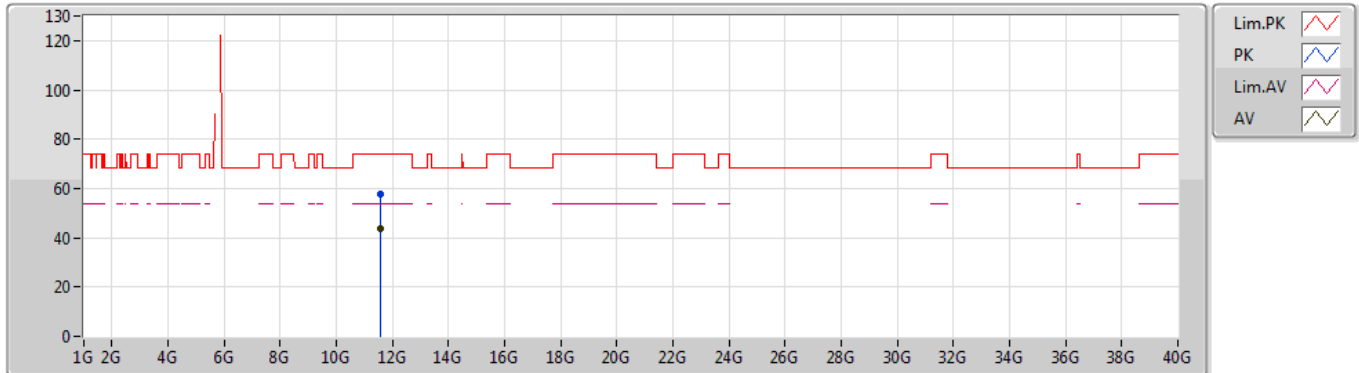

EUT Y_2TX ANT_H
 Setting 26
 02-B-4
 FSU(100015)

Type	Freq (Hz)	Level (dBuV/m)	Limit (dBuV/m)	Margin (dB)	Factor (dB)	Dist (m)	Condition	Azimuth (°)	Height (m)	Comment	Raw (dBuV)
PK	11.56928G	57.70	74.00	-16.30	15.00	3	Horizontal	1	1.52	-	42.70
AV	11.56862G	43.63	54.00	-10.37	14.99	3	Horizontal	1	1.52	-	28.64

802.11ac VHT20_Nss1,(MCS0)_2TX

23/08/2019

5825MHz_TX

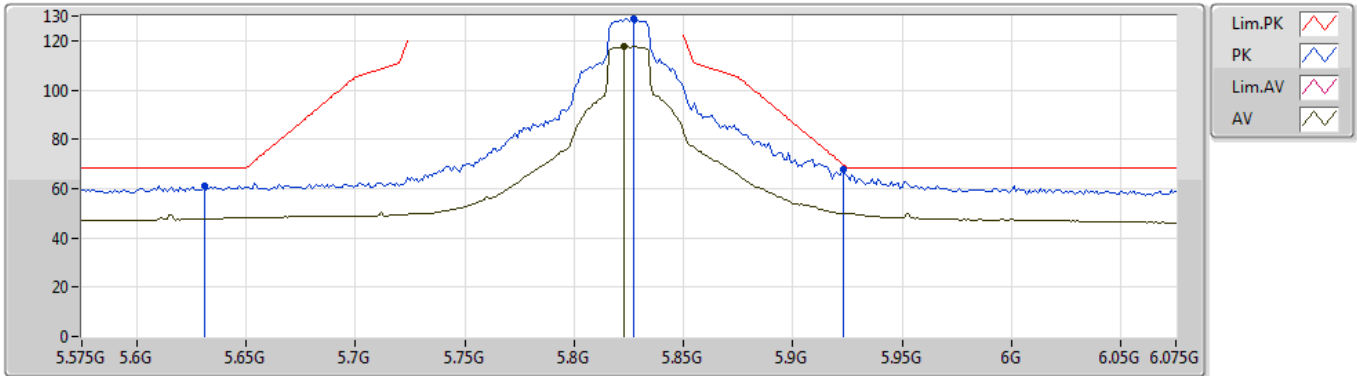

EUT Y_2TX ANT_H
 Setting 25.5
 02-B-4-10
 FSU(100015)

Type	Freq (Hz)	Level (dBuV/m)	Limit (dBuV/m)	Margin (dB)	Factor (dB)	Dist (m)	Condition	Azimuth (°)	Height (m)	Comment	Raw (dBuV)
PK	5.631G	61.15	68.20	-7.05	8.63	3	Vertical	4	1.55	-	52.52
PK	5.827G	128.77	Inf	-Inf	8.91	3	Vertical	4	1.55	-	119.86
AV	5.823G	117.77	Inf	-Inf	8.90	3	Vertical	4	1.55	-	108.87
PK	5.923G	67.69	69.68	-1.99	8.92	3	Vertical	4	1.55	-	58.77

802.11ac VHT20_Nss1,(MCS0)_2TX

23/08/2019

5825MHz_TX

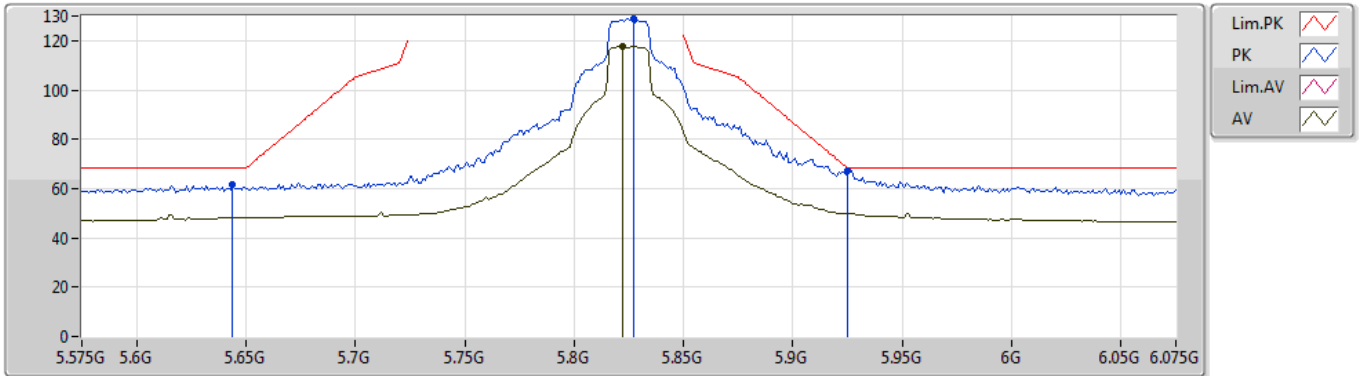

EUT Y_2TX ANT_H
 Setting 25.5
 02-B-4-10
 FSU(100015)

Type	Freq (Hz)	Level (dBuV/m)	Limit (dBuV/m)	Margin (dB)	Factor (dB)	Dist (m)	Condition	Azimuth (°)	Height (m)	Comment	Raw (dBuV)
PK	5.644G	61.56	68.20	-6.64	8.66	3	Horizontal	3	1.53	-	52.90
PK	5.827G	128.90	Inf	-Inf	8.91	3	Horizontal	3	1.53	-	119.99
AV	5.822G	117.78	Inf	-Inf	8.90	3	Horizontal	3	1.53	-	108.88
PK	5.925G	67.46	68.20	-0.74	8.93	3	Horizontal	3	1.53	-	58.53

802.11ac VHT20_Nss1,(MCS0)_2TX

23/08/2019

5825MHz_TX

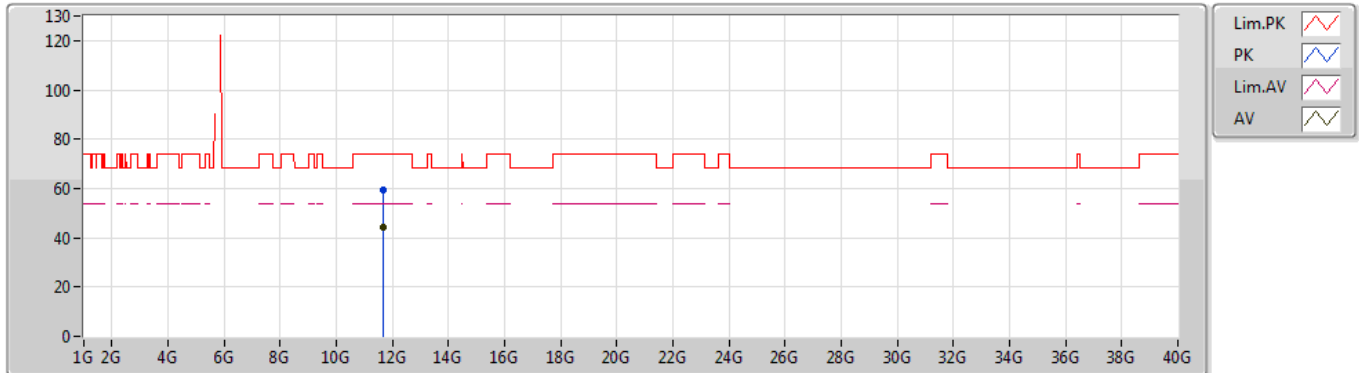

EUT Y_2TX ANT_H
 Setting 25.5
 02-B-4
 FSU(100015)

Type	Freq (Hz)	Level (dBuV/m)	Limit (dBuV/m)	Margin (dB)	Factor (dB)	Dist (m)	Condition	Azimuth (°)	Height (m)	Comment	Raw (dBuV)
PK	11.64874G	59.38	74.00	-14.62	15.09	3	Vertical	4	1.48	-	44.29
AV	11.64982G	44.26	54.00	-9.74	15.09	3	Vertical	4	1.48	-	29.17

802.11ac VHT20_Nss1,(MCS0)_2TX

23/08/2019

5825MHz_TX

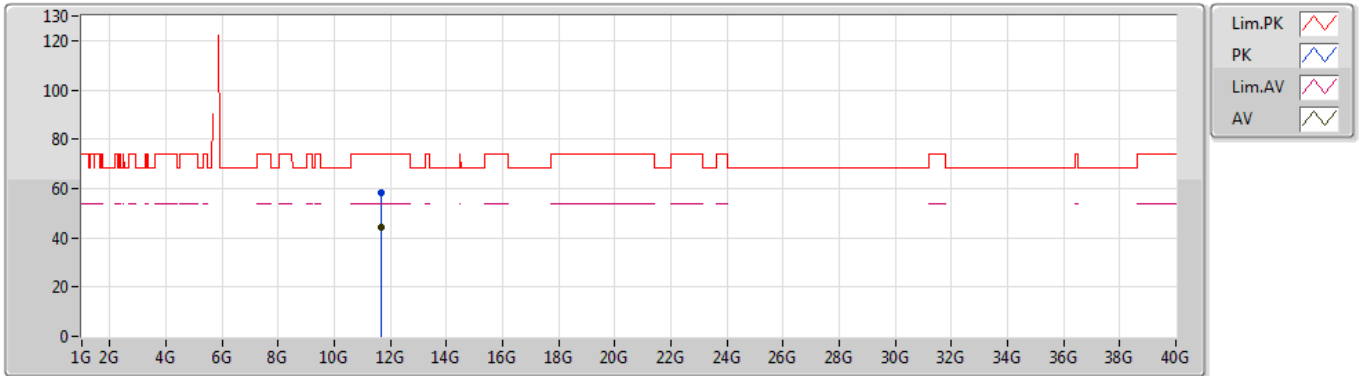

EUT Y_2TX ANT_H
 Setting 25.5
 02-B-4
 FSU(100015)

Type	Freq (Hz)	Level (dBuV/m)	Limit (dBuV/m)	Margin (dB)	Factor (dB)	Dist (m)	Condition	Azimuth (°)	Height (m)	Comment	Raw (dBuV)
PK	11.6491G	58.38	74.00	-15.62	15.09	3	Horizontal	7	1.51	-	43.29
AV	11.64994G	44.34	54.00	-9.66	15.09	3	Horizontal	7	1.51	-	29.25

802.11ac VHT40_Nss1,(MCS0)_2TX

24/08/2019

5190MHz_TX

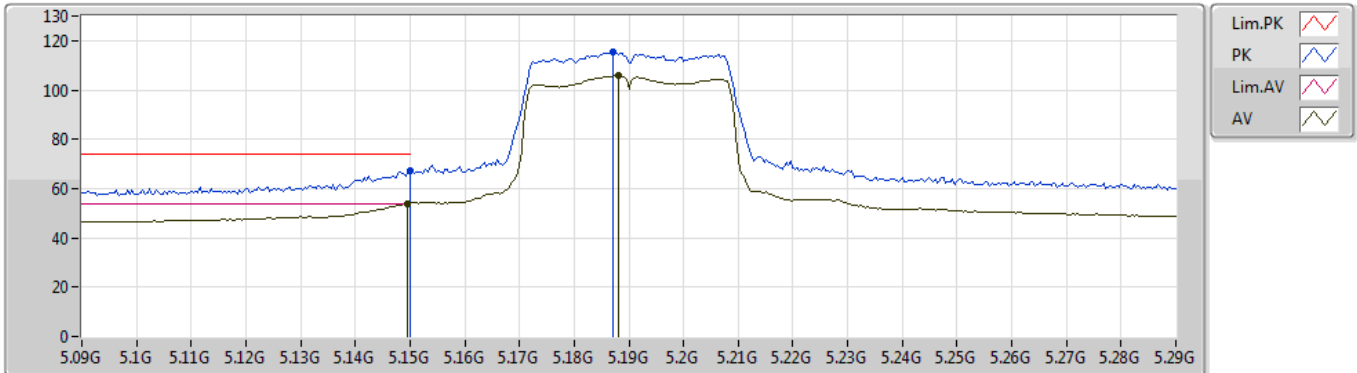

EUT Y_2TX ANT_H
Setting 17
02-B-4-10
FSU(100015)

Type	Freq (Hz)	Level (dBuV/m)	Limit (dBuV/m)	Margin (dB)	Factor (dB)	Dist (m)	Condition	Azimuth (°)	Height (m)	Comment	Raw (dBuV)
PK	5.15G	67.20	74.00	-6.80	7.94	3	Vertical	10	1.98	-	59.26
AV	5.1496G	53.84	54.00	-0.16	7.94	3	Vertical	10	1.98	-	45.90
PK	5.1872G	115.61	Inf	-Inf	8.04	3	Vertical	10	1.98	-	107.57
AV	5.188G	105.70	Inf	-Inf	8.04	3	Vertical	10	1.98	-	97.66

802.11ac VHT40_Nss1,(MCS0)_2TX

24/08/2019

5190MHz_TX

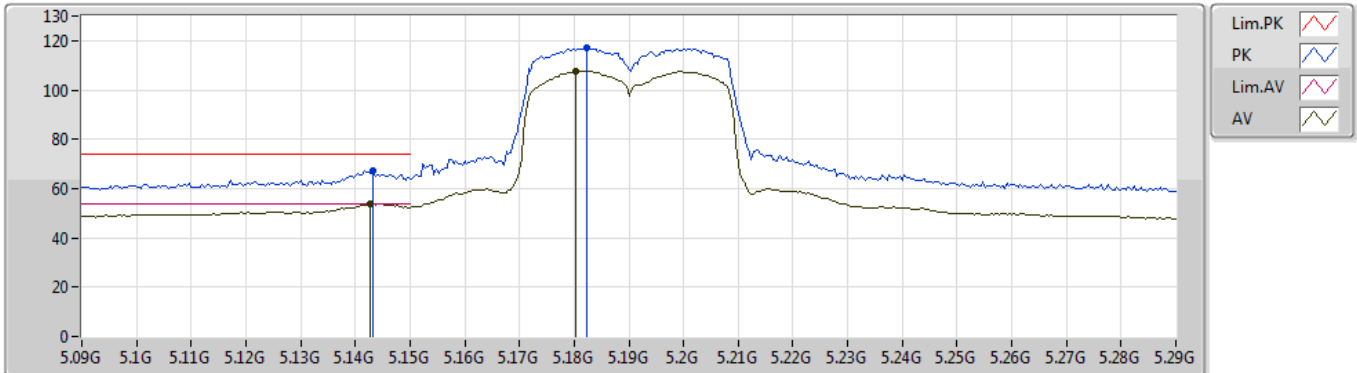

EUT Y_2TX ANT_H
Setting 17
02-B-4-10
FSU(100015)

Type	Freq (Hz)	Level (dBuV/m)	Limit (dBuV/m)	Margin (dB)	Factor (dB)	Dist (m)	Condition	Azimuth (°)	Height (m)	Comment	Raw (dBuV)
PK	5.1432G	67.46	74.00	-6.54	7.94	3	Horizontal	8	2.28	-	59.52
AV	5.1428G	53.87	54.00	-0.13	7.94	3	Horizontal	8	2.28	-	45.93
PK	5.1824G	117.00	Inf	-Inf	8.02	3	Horizontal	8	2.28	-	108.98
AV	5.1804G	107.63	Inf	-Inf	8.02	3	Horizontal	8	2.28	-	99.61

802.11ac VHT40_Nss1,(MCS0)_2TX

24/08/2019

5190MHz_TX

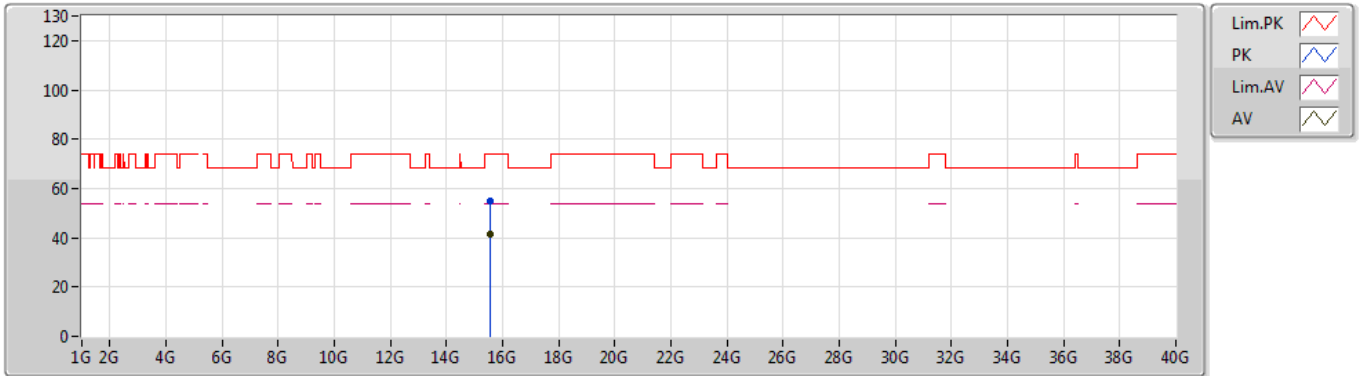

EUT Y_2TX ANT_H
Setting 17
02-B-4
FSU(100015)

Type	Freq (Hz)	Level (dBuV/m)	Limit (dBuV/m)	Margin (dB)	Factor (dB)	Dist (m)	Condition	Azimuth (°)	Height (m)	Comment	Raw (dBuV)
PK	15.57016G	54.70	74.00	-19.30	16.00	3	Vertical	269	1.04	-	38.70
AV	15.57064G	41.56	54.00	-12.44	16.00	3	Vertical	269	1.04	-	25.56

802.11ac VHT40_Nss1,(MCS0)_2TX

24/08/2019

5190MHz_TX

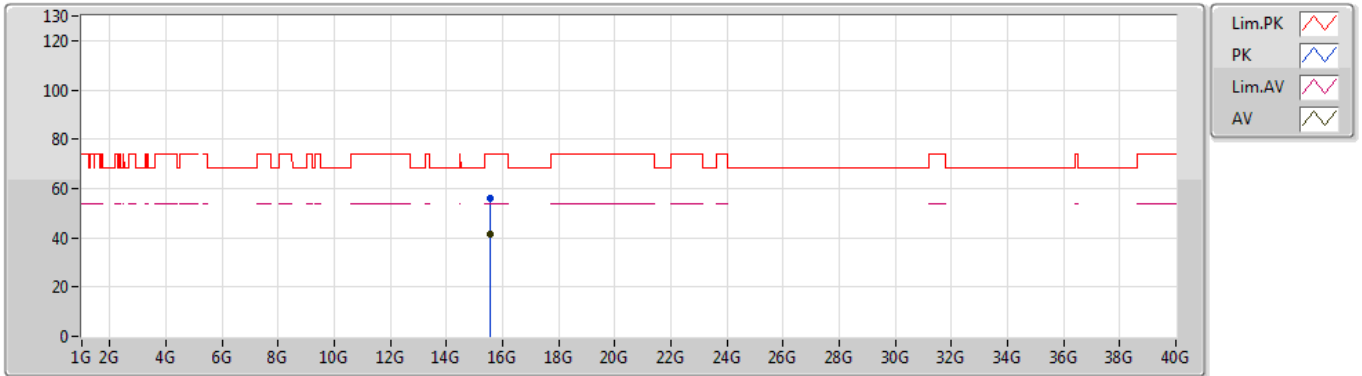

EUT Y_2TX ANT_H
Setting 17
02-B-4
FSU(100015)

Type	Freq (Hz)	Level (dBuV/m)	Limit (dBuV/m)	Margin (dB)	Factor (dB)	Dist (m)	Condition	Azimuth (°)	Height (m)	Comment	Raw (dBuV)
PK	15.57544G	56.00	74.00	-18.00	15.98	3	Horizontal	292	1.34	-	40.02
AV	15.57616G	41.45	54.00	-12.55	15.98	3	Horizontal	292	1.34	-	25.47

802.11ac VHT40_Nss1,(MCS0)_2TX

24/08/2019

5230MHz_TX

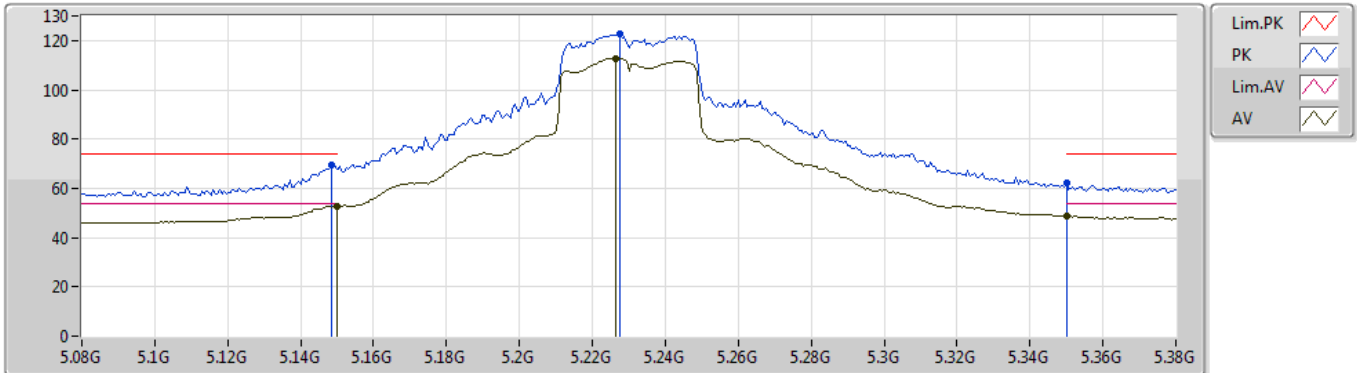

EUT Y_2TX ANT_H
Setting 23
02-B-4-10
FSU(100015)

Type	Freq (Hz)	Level (dBuV/m)	Limit (dBuV/m)	Margin (dB)	Factor (dB)	Dist (m)	Condition	Azimuth (°)	Height (m)	Comment	Raw (dBuV)
PK	5.1484G	69.60	74.00	-4.40	7.94	3	Vertical	10	1.87	-	61.66
AV	5.15G	52.81	54.00	-1.19	7.94	3	Vertical	10	1.87	-	44.87
PK	5.2276G	122.50	Inf	-Inf	8.10	3	Vertical	10	1.87	-	114.40
AV	5.2264G	112.70	Inf	-Inf	8.10	3	Vertical	10	1.87	-	104.60
PK	5.35G	61.93	74.00	-12.07	8.28	3	Vertical	10	1.87	-	53.65
AV	5.35G	48.57	54.00	-5.43	8.28	3	Vertical	10	1.87	-	40.29

802.11ac VHT40_Nss1,(MCS0)_2TX

24/08/2019

5230MHz_TX

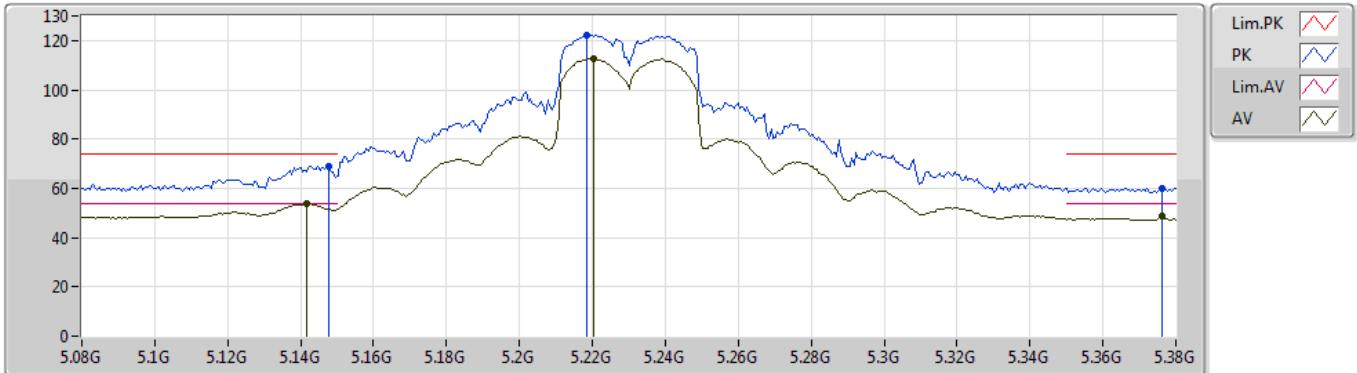

EUT Y_2TX ANT_H
Setting 23
02-B-4-10
FSU(100015)

Type	Freq (Hz)	Level (dBuV/m)	Limit (dBuV/m)	Margin (dB)	Factor (dB)	Dist (m)	Condition	Azimuth (°)	Height (m)	Comment	Raw (dBuV)
PK	5.1478G	69.06	74.00	-4.94	7.94	3	Horizontal	15	2.28	-	61.12
AV	5.1418G	53.80	54.00	-0.20	7.94	3	Horizontal	15	2.28	-	45.86
PK	5.2186G	122.39	Inf	-Inf	8.09	3	Horizontal	15	2.28	-	114.30
AV	5.2204G	112.70	Inf	-Inf	8.09	3	Horizontal	15	2.28	-	104.61
PK	5.3764G	60.18	74.00	-13.82	8.31	3	Horizontal	15	2.28	-	51.87
AV	5.3764G	48.97	54.00	-5.03	8.31	3	Horizontal	15	2.28	-	40.66

802.11ac VHT40_Nss1,(MCS0)_2TX

24/08/2019

5230MHz_TX

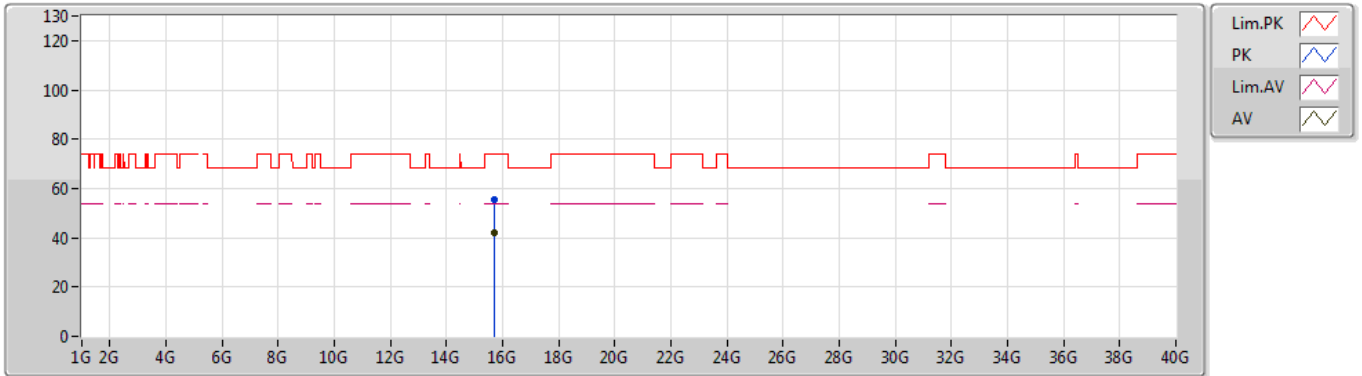

EUT Y_2TX ANT_H
Setting 23
02-B-4
FSU(100015)

Type	Freq (Hz)	Level (dBuV/m)	Limit (dBuV/m)	Margin (dB)	Factor (dB)	Dist (m)	Condition	Azimuth (°)	Height (m)	Comment	Raw (dBuV)
PK	15.70536G	55.28	74.00	-18.72	15.63	3	Vertical	331	1.52	-	39.65
AV	15.68696G	41.91	54.00	-12.09	15.69	3	Vertical	331	1.52	-	26.22

802.11ac VHT40_Nss1,(MCS0)_2TX

24/08/2019

5230MHz_TX

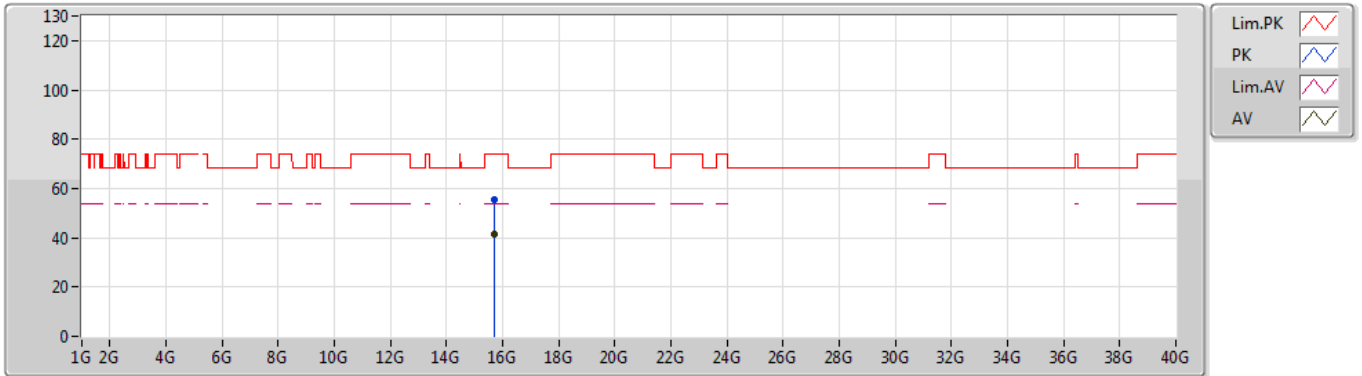

EUT Y_2TX ANT_H
Setting 23
02-B-4
FSU(100015)

Type	Freq (Hz)	Level (dBuV/m)	Limit (dBuV/m)	Margin (dB)	Factor (dB)	Dist (m)	Condition	Azimuth (°)	Height (m)	Comment	Raw (dBuV)
PK	15.68712G	55.23	74.00	-18.77	15.69	3	Horizontal	323	1.29	-	39.54
AV	15.68264G	41.50	54.00	-12.50	15.70	3	Horizontal	323	1.29	-	25.80

802.11ac VHT40_Nss1,(MCS0)_2TX

24/08/2019

5755MHz_TX

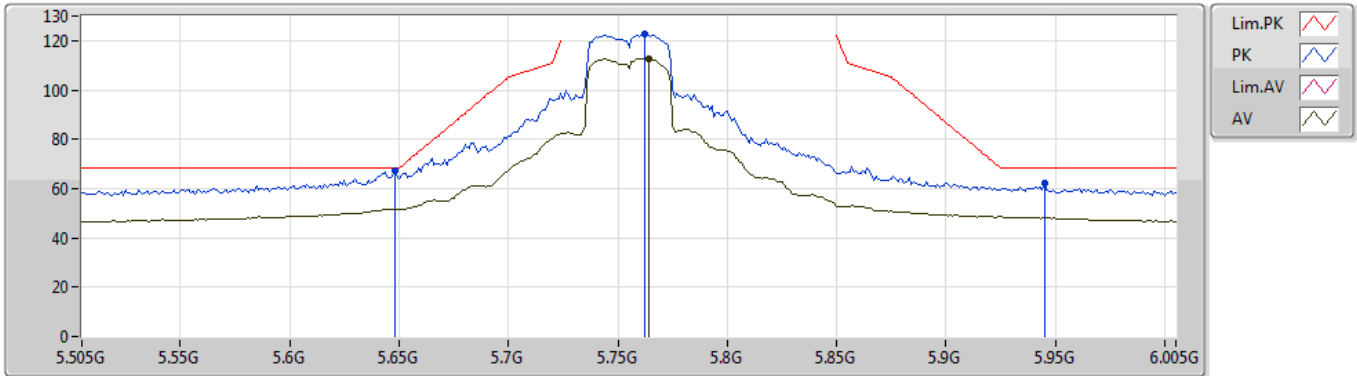

EUT Y_2TX ANT_H
 Setting 23
 02-B-4-10
 FSU(100015)

Type	Freq (Hz)	Level (dBuV/m)	Limit (dBuV/m)	Margin (dB)	Factor (dB)	Dist (m)	Condition	Azimuth (°)	Height (m)	Comment	Raw (dBuV)
PK	5.648G	66.97	68.20	-1.23	8.67	3	Vertical	9	1.85	-	58.30
PK	5.762G	122.50	Inf	-Inf	8.85	3	Vertical	9	1.85	-	113.65
AV	5.764G	112.90	Inf	-Inf	8.84	3	Vertical	9	1.85	-	104.06
PK	5.945G	62.07	68.20	-6.13	8.94	3	Vertical	9	1.85	-	53.13

802.11ac VHT40_Nss1,(MCS0)_2TX

26/08/2019

5755MHz_TX

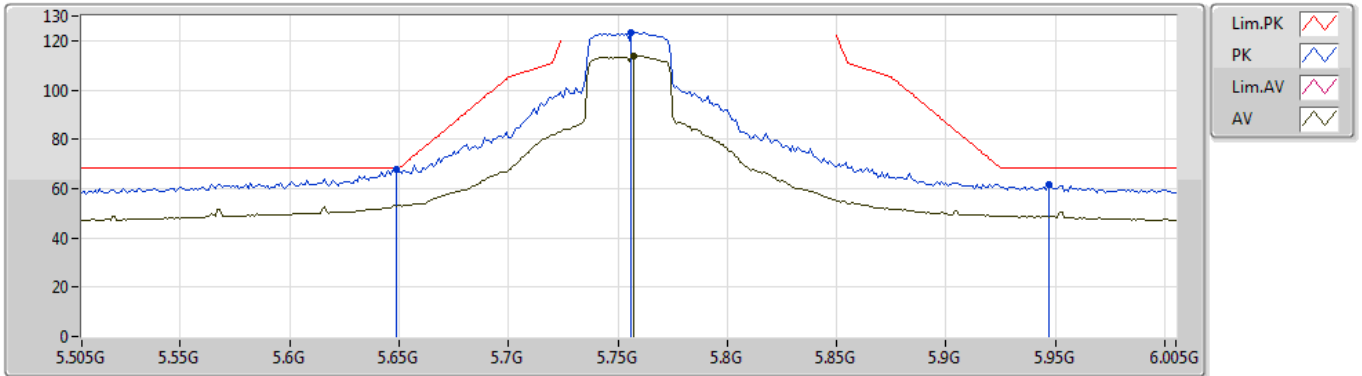

EUT Y_2TX ANT_H
 Setting 23
 02-B-4-10
 FSU(100015)

Type	Freq (Hz)	Level (dBuV/m)	Limit (dBuV/m)	Margin (dB)	Factor (dB)	Dist (m)	Condition	Azimuth (°)	Height (m)	Comment	Raw (dBuV)
PK	5.649G	67.88	68.20	-0.32	8.67	3	Horizontal	359	1.70	-	59.21
PK	5.756G	123.14	Inf	-Inf	8.83	3	Horizontal	359	1.70	-	114.31
AV	5.757G	114.02	Inf	-Inf	8.83	3	Horizontal	359	1.70	-	105.19
PK	5.947G	61.65	68.20	-6.55	8.94	3	Horizontal	359	1.70	-	52.71

802.11ac VHT40_Nss1,(MCS0)_2TX

24/08/2019

5755MHz_TX

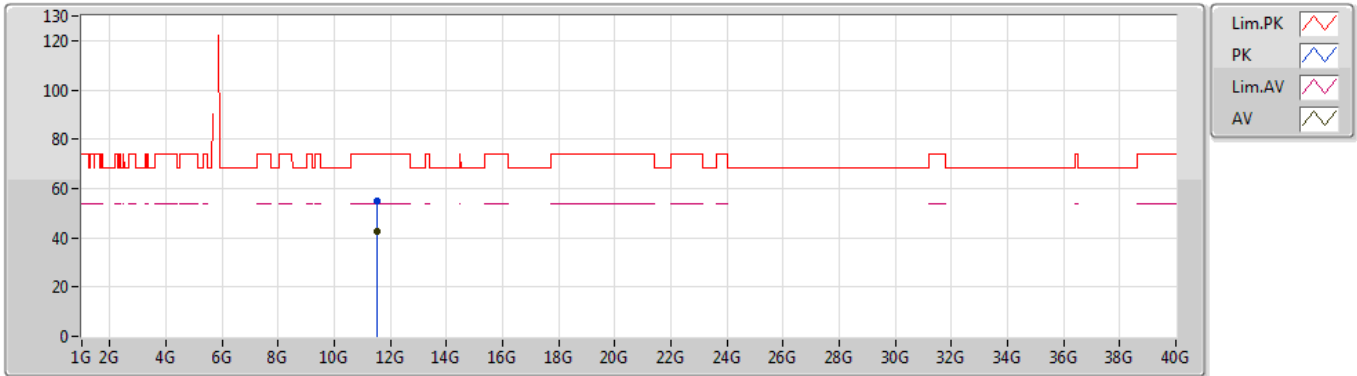

EUT Y_2TX ANT_H
Setting 23
02-B-4
FSU(100015)

Type	Freq (Hz)	Level (dBuV/m)	Limit (dBuV/m)	Margin (dB)	Factor (dB)	Dist (m)	Condition	Azimuth (°)	Height (m)	Comment	Raw (dBuV)
PK	11.5132G	54.97	74.00	-19.03	14.92	3	Vertical	0	1.33	-	40.05
AV	11.50984G	42.39	54.00	-11.61	14.92	3	Vertical	0	1.33	-	27.47

802.11ac VHT40_Nss1,(MCS0)_2TX

24/08/2019

5755MHz_TX

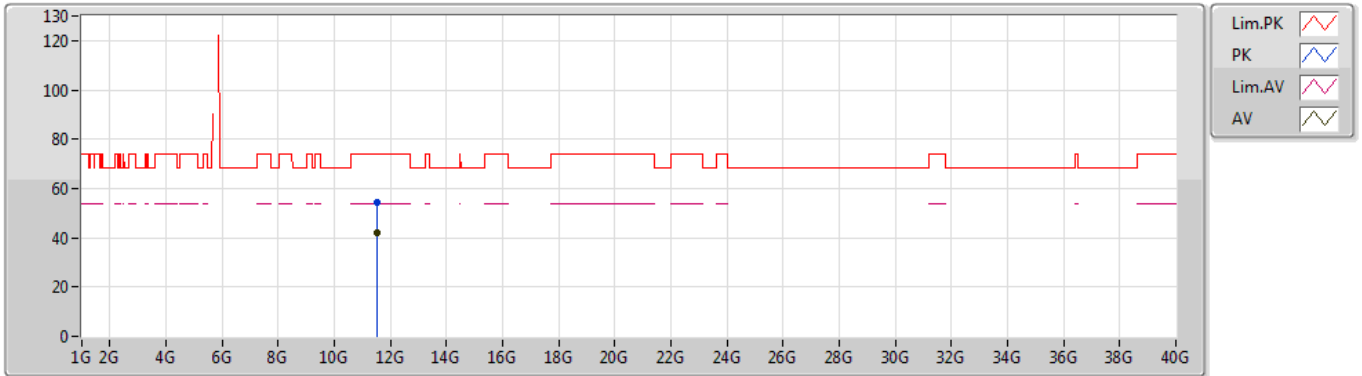

EUT Y_2TX ANT_H
Setting 23
02-B-4
FSU(100015)

Type	Freq (Hz)	Level (dBuV/m)	Limit (dBuV/m)	Margin (dB)	Factor (dB)	Dist (m)	Condition	Azimuth (°)	Height (m)	Comment	Raw (dBuV)
PK	11.50776G	54.57	74.00	-19.43	14.92	3	Horizontal	5	1.51	-	39.65
AV	11.50992G	42.12	54.00	-11.88	14.92	3	Horizontal	5	1.51	-	27.20

802.11ac VHT40_Nss1,(MCS0)_2TX

24/08/2019

5795MHz_TX

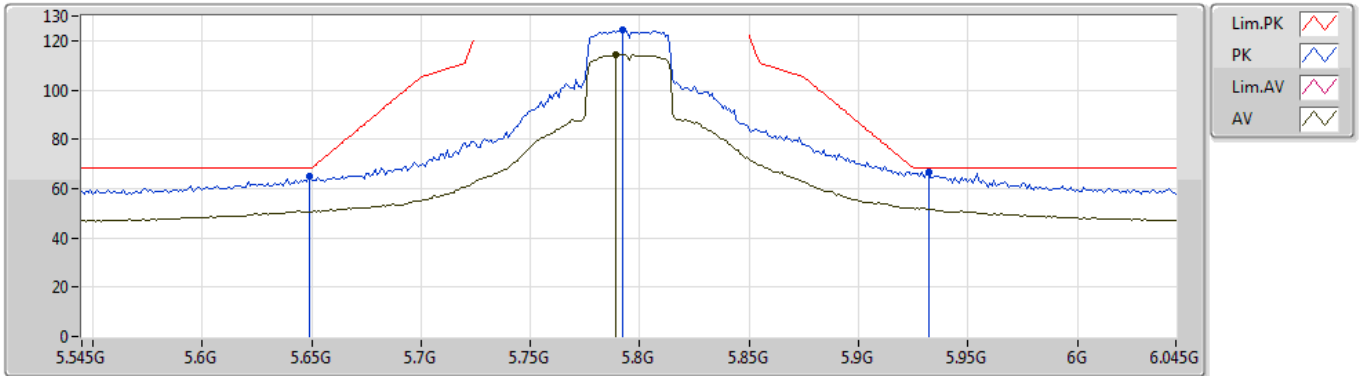

EUT Y_2TX ANT_H
Setting 23
02-B-4-10
FSU(100015)

Type	Freq (Hz)	Level (dBuV/m)	Limit (dBuV/m)	Margin (dB)	Factor (dB)	Dist (m)	Condition	Azimuth (°)	Height (m)	Comment	Raw (dBuV)
PK	5.649G	64.96	68.20	-3.24	8.67	3	Vertical	2	2.03	-	56.29
PK	5.792G	124.42	Inf	-Inf	8.89	3	Vertical	2	2.03	-	115.53
AV	5.789G	114.34	Inf	-Inf	8.88	3	Vertical	2	2.03	-	105.46
PK	5.932G	66.77	68.20	-1.43	8.93	3	Vertical	2	2.03	-	57.84

802.11ac VHT40_Nss1,(MCS0)_2TX

24/08/2019

5795MHz_TX

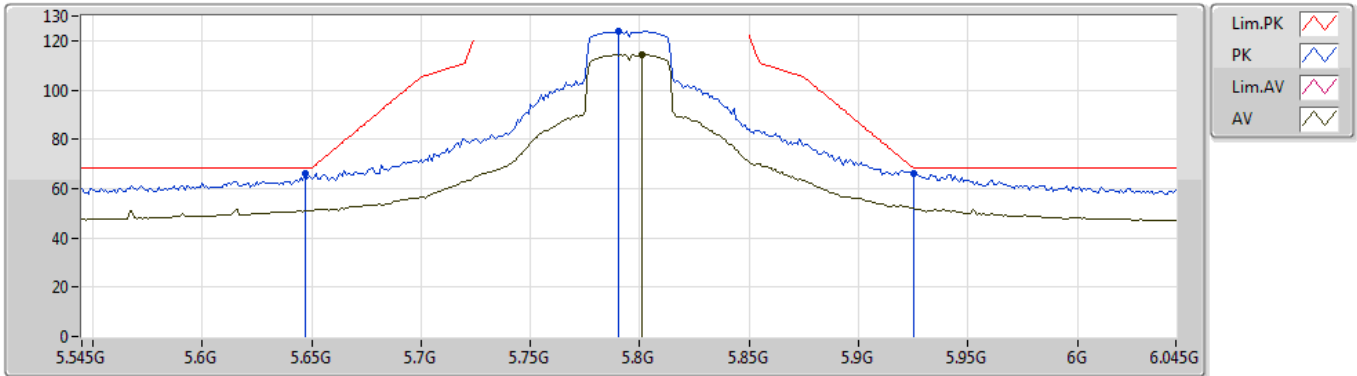

EUT Y_2TX ANT_H
Setting 23
02-B-4-10
FSU(100015)

Type	Freq (Hz)	Level (dBuV/m)	Limit (dBuV/m)	Margin (dB)	Factor (dB)	Dist (m)	Condition	Azimuth (°)	Height (m)	Comment	Raw (dBuV)
PK	5.647G	66.22	68.20	-1.98	8.67	3	Horizontal	4	1.57	-	57.55
PK	5.79G	124.01	Inf	-Inf	8.88	3	Horizontal	4	1.57	-	115.13
AV	5.801G	114.35	Inf	-Inf	8.90	3	Horizontal	4	1.57	-	105.45
PK	5.925G	65.89	68.20	-2.31	8.93	3	Horizontal	4	1.57	-	56.96

802.11ac VHT40_Nss1,(MCS0)_2TX

24/08/2019

5795MHz_TX

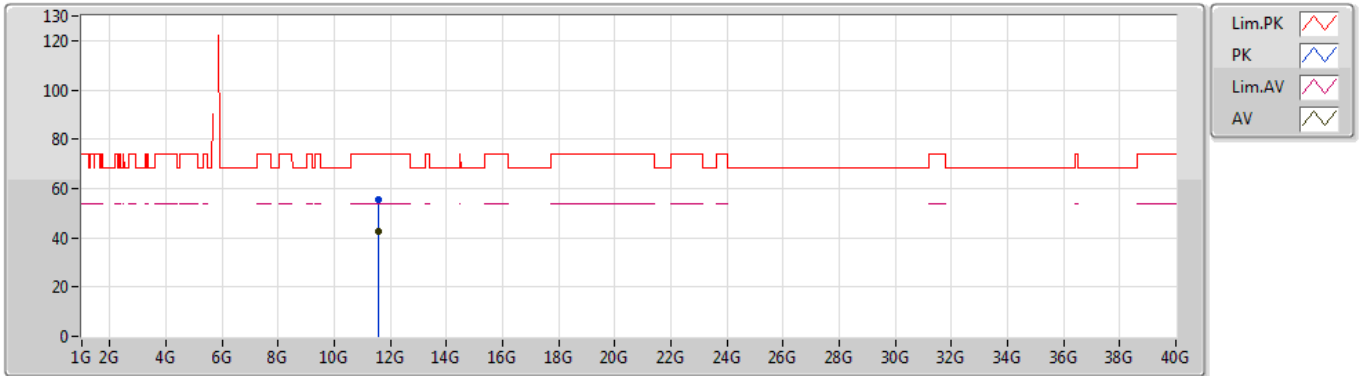

EUT Y_2TX ANT_H
Setting 23
02-B-4
FSU(100015)

Type	Freq (Hz)	Level (dBuV/m)	Limit (dBuV/m)	Margin (dB)	Factor (dB)	Dist (m)	Condition	Azimuth (°)	Height (m)	Comment	Raw (dBuV)
PK	11.59024G	55.24	74.00	-18.76	15.02	3	Vertical	9	1.68	-	40.22
AV	11.59008G	42.73	54.00	-11.27	15.02	3	Vertical	9	1.68	-	27.71

802.11ac VHT40_Nss1,(MCS0)_2TX

24/08/2019

5795MHz_TX

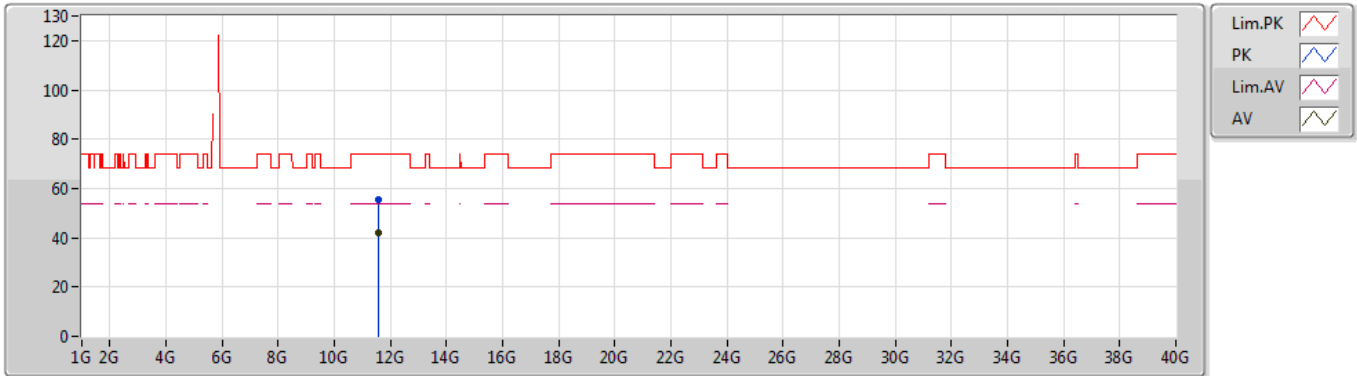

EUT Y_2TX ANT_H
Setting 23
02-B-4
FSU(100015)

Type	Freq (Hz)	Level (dBuV/m)	Limit (dBuV/m)	Margin (dB)	Factor (dB)	Dist (m)	Condition	Azimuth (°)	Height (m)	Comment	Raw (dBuV)
PK	11.5916G	55.30	74.00	-18.70	15.02	3	Horizontal	2	1.57	-	40.28
AV	11.58936G	42.24	54.00	-11.76	15.02	3	Horizontal	2	1.57	-	27.22

802.11ac VHT80_Nss1,(MCS0)_2TX

24/08/2019

5210MHz_TX

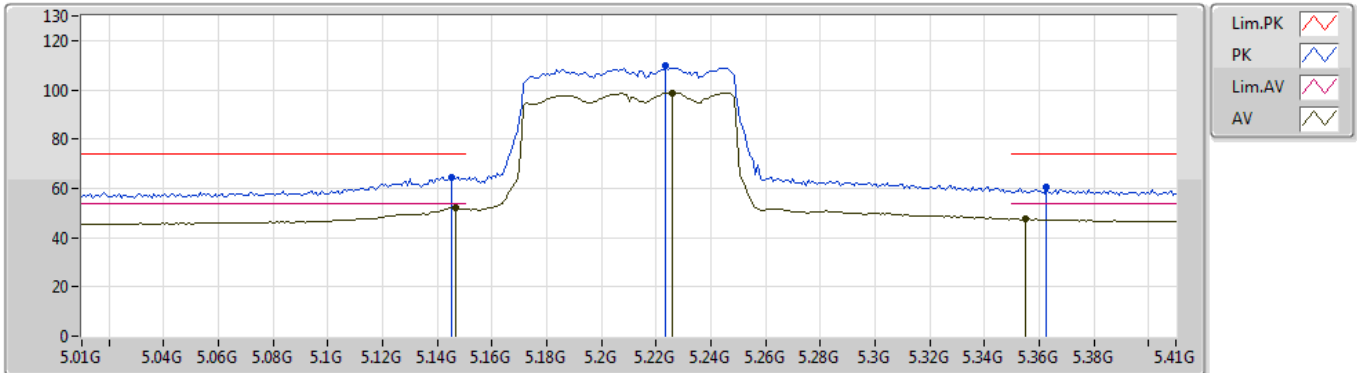

EUT Y_2TX ANT_H
Setting 14
02-B-4-10
FSU(100015)

Type	Freq (Hz)	Level (dBuV/m)	Limit (dBuV/m)	Margin (dB)	Factor (dB)	Dist (m)	Condition	Azimuth (°)	Height (m)	Comment	Raw (dBuV)
PK	5.1452G	64.67	74.00	-9.33	7.94	3	Vertical	13	1.88	-	56.73
AV	5.1468G	52.31	54.00	-1.69	7.94	3	Vertical	13	1.88	-	44.37
PK	5.2236G	109.60	Inf	-Inf	8.10	3	Vertical	13	1.88	-	101.50
AV	5.226G	98.90	Inf	-Inf	8.10	3	Vertical	13	1.88	-	90.80
PK	5.3628G	60.24	74.00	-13.76	8.29	3	Vertical	13	1.88	-	51.95
AV	5.3548G	47.58	54.00	-6.42	8.28	3	Vertical	13	1.88	-	39.30

802.11ac VHT80_Nss1,(MCS0)_2TX

24/08/2019

5210MHz_TX

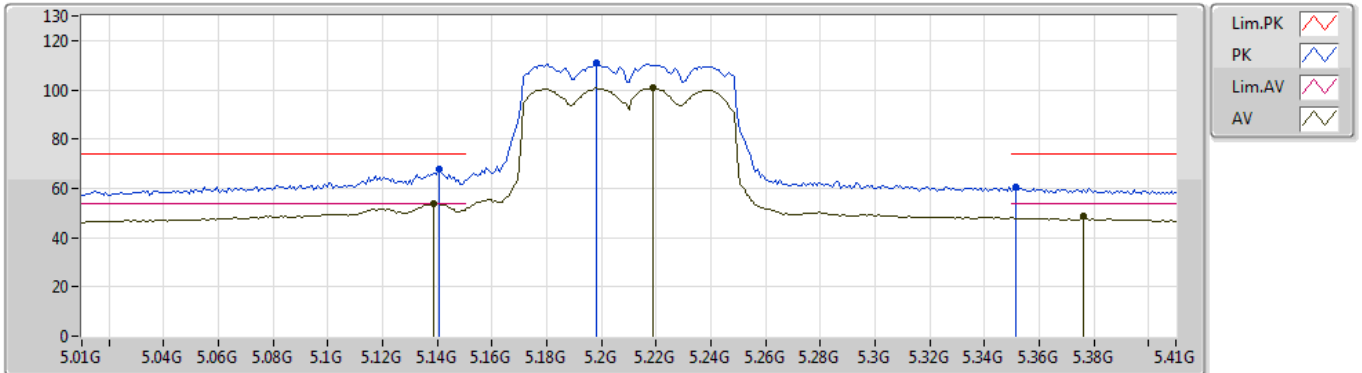

EUT_Y_2TX ANT_H
Setting 14
02-B-4-10
FSU(100015)

Type	Freq (Hz)	Level (dBuV/m)	Limit (dBuV/m)	Margin (dB)	Factor (dB)	Dist (m)	Condition	Azimuth (°)	Height (m)	Comment	Raw (dBuV)
PK	5.1404G	67.96	74.00	-6.04	7.93	3	Horizontal	12	2.24	-	60.03
AV	5.1388G	53.88	54.00	-0.12	7.92	3	Horizontal	12	2.24	-	45.96
PK	5.198G	110.70	Inf	-Inf	8.06	3	Horizontal	12	2.24	-	102.64
AV	5.2188G	100.61	Inf	-Inf	8.09	3	Horizontal	12	2.24	-	92.52
PK	5.3516G	60.54	74.00	-13.46	8.28	3	Horizontal	12	2.24	-	52.26
AV	5.3764G	48.71	54.00	-5.29	8.31	3	Horizontal	12	2.24	-	40.40

802.11ac VHT80_Nss1,(MCS0)_2TX

24/08/2019

5210MHz_TX

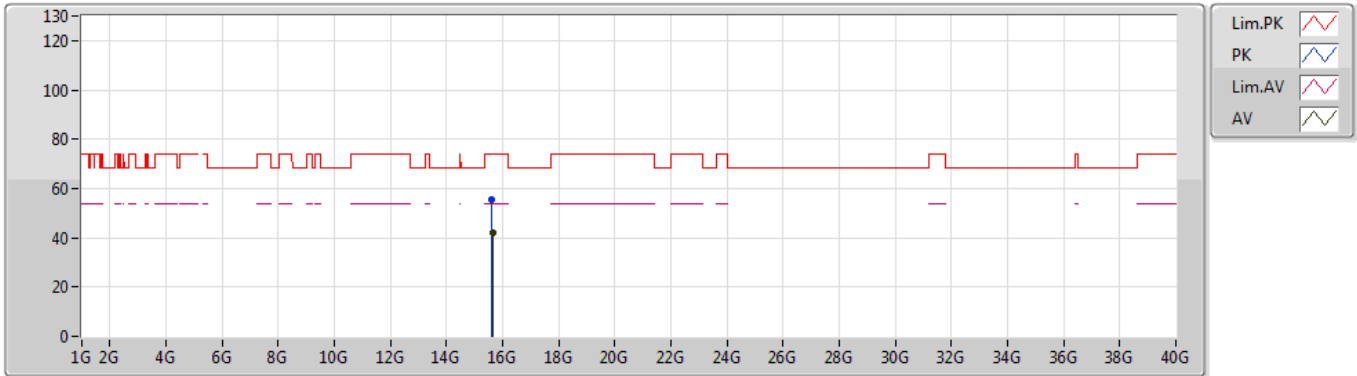

EUT Y_2TX ANT_H
Setting 14
02-B-4
FSU(100015)

Type	Freq (Hz)	Level (dBuV/m)	Limit (dBuV/m)	Margin (dB)	Factor (dB)	Dist (m)	Condition	Azimuth (°)	Height (m)	Comment	Raw (dBuV)
PK	15.63112G	55.59	74.00	-18.41	15.83	3	Vertical	336	1.32	-	39.76
AV	15.63236G	41.75	54.00	-12.25	15.83	3	Vertical	336	1.32	-	25.92

802.11ac VHT80_Nss1,(MCS0)_2TX

24/08/2019

5210MHz_TX

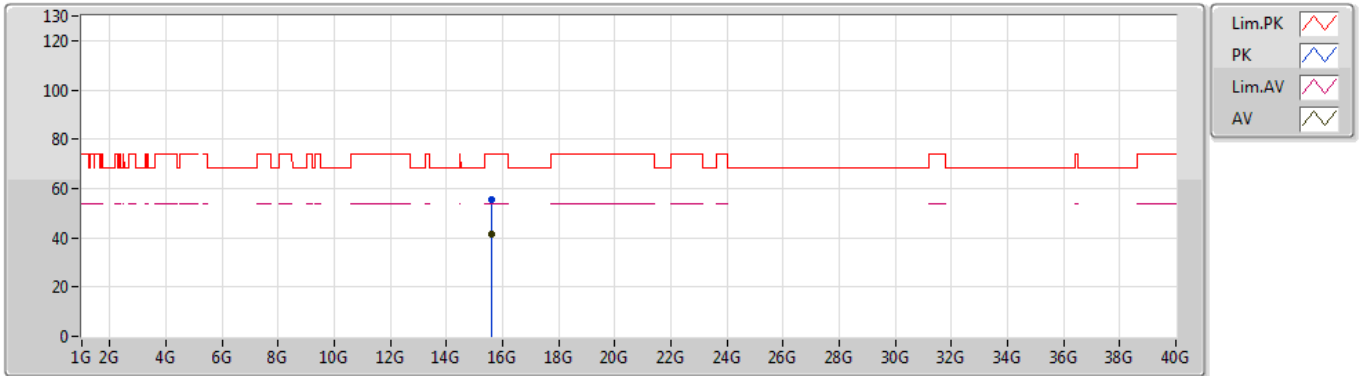

EUT Y_2TX ANT_H
Setting 14
02-B-4
FSU(100015)

Type	Freq (Hz)	Level (dBuV/m)	Limit (dBuV/m)	Margin (dB)	Factor (dB)	Dist (m)	Condition	Azimuth (°)	Height (m)	Comment	Raw (dBuV)
PK	15.6286G	55.44	74.00	-18.56	15.84	3	Horizontal	317	1.79	-	39.60
AV	15.62898G	41.46	54.00	-12.54	15.84	3	Horizontal	317	1.79	-	25.62

802.11ac VHT80_Nss1,(MCS0)_2TX

24/08/2019

5775MHz_TX

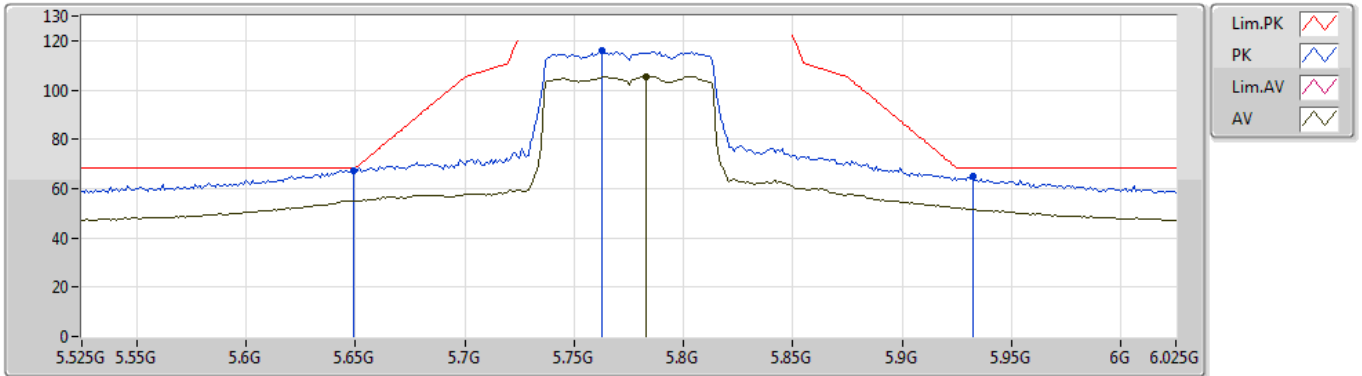

EUT Y_2TX ANT_H
Setting 18
02-B-4-10
FSU(100015)

Type	Freq (Hz)	Level (dBuV/m)	Limit (dBuV/m)	Margin (dB)	Factor (dB)	Dist (m)	Condition	Azimuth (°)	Height (m)	Comment	Raw (dBuV)
PK	5.649G	67.52	68.20	-0.68	8.67	3	Vertical	9	1.94	-	58.85
PK	5.763G	116.09	Inf	-Inf	8.84	3	Vertical	9	1.94	-	107.25
AV	5.783G	105.41	Inf	-Inf	8.88	3	Vertical	9	1.94	-	96.53
PK	5.932G	65.28	68.20	-2.92	8.93	3	Vertical	9	1.94	-	56.35

802.11ac VHT80_Nss1,(MCS0)_2TX

24/08/2019

5775MHz_TX

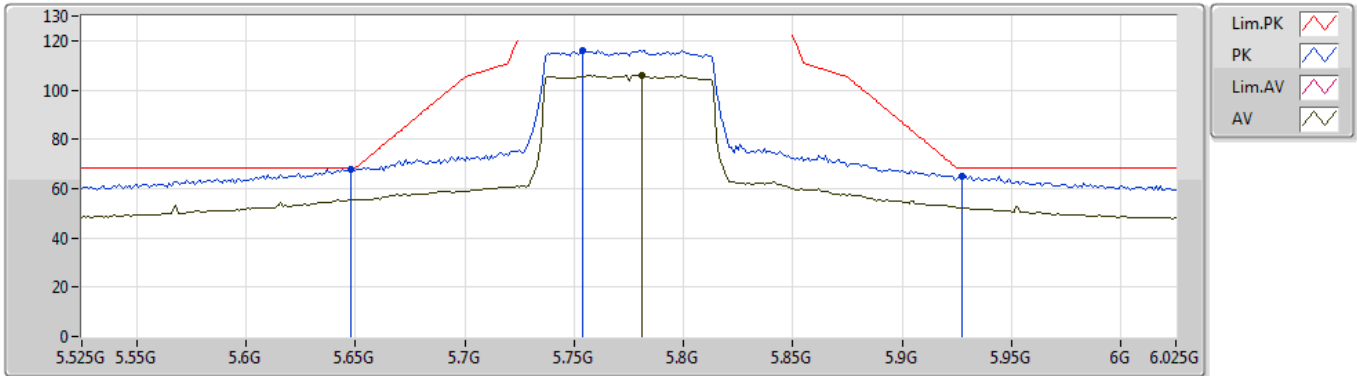

EUT Y_2TX ANT_H
Setting 18
02-B-4-10
FSU(100015)

Type	Freq (Hz)	Level (dBuV/m)	Limit (dBuV/m)	Margin (dB)	Factor (dB)	Dist (m)	Condition	Azimuth (°)	Height (m)	Comment	Raw (dBuV)
PK	5.648G	67.86	68.20	-0.34	8.67	3	Horizontal	3	1.70	-	59.19
PK	5.754G	116.01	Inf	-Inf	8.83	3	Horizontal	3	1.70	-	107.18
AV	5.781G	105.94	Inf	-Inf	8.88	3	Horizontal	3	1.70	-	97.06
PK	5.927G	65.10	68.20	-3.10	8.93	3	Horizontal	3	1.70	-	56.17

802.11ac VHT80_Nss1,(MCS0)_2TX

24/08/2019

5775MHz_TX

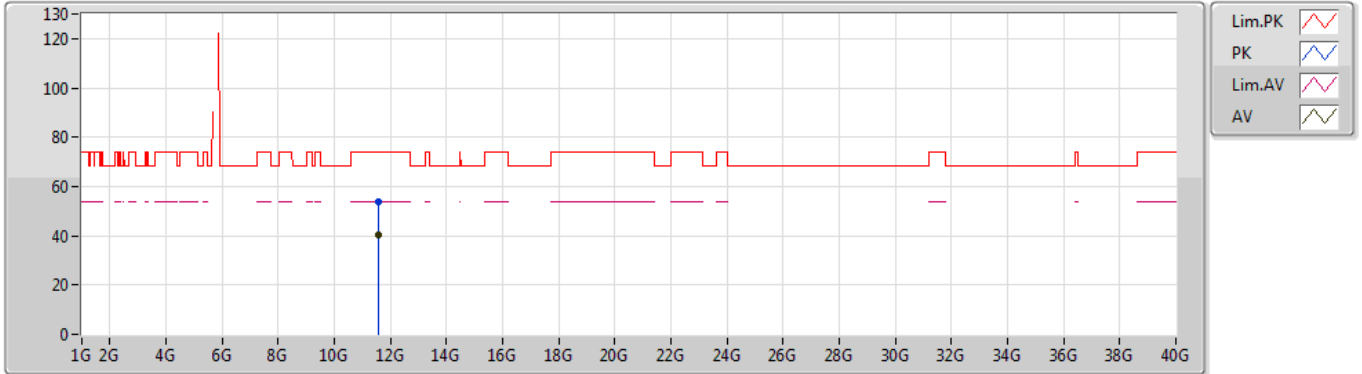

EUT Y_2TX ANT_H
Setting 18
02-B-4
FSU(100015)

Type	Freq (Hz)	Level (dBuV/m)	Limit (dBuV/m)	Margin (dB)	Factor (dB)	Dist (m)	Condition	Azimuth (°)	Height (m)	Comment	Raw (dBuV)
PK	11.55008G	53.77	74.00	-20.23	14.97	3	Vertical	306	1.07	-	38.80
AV	11.55038G	40.39	54.00	-13.61	14.97	3	Vertical	306	1.07	-	25.42

802.11ac VHT80_Nss1,(MCS0)_2TX

24/08/2019

5775MHz_TX

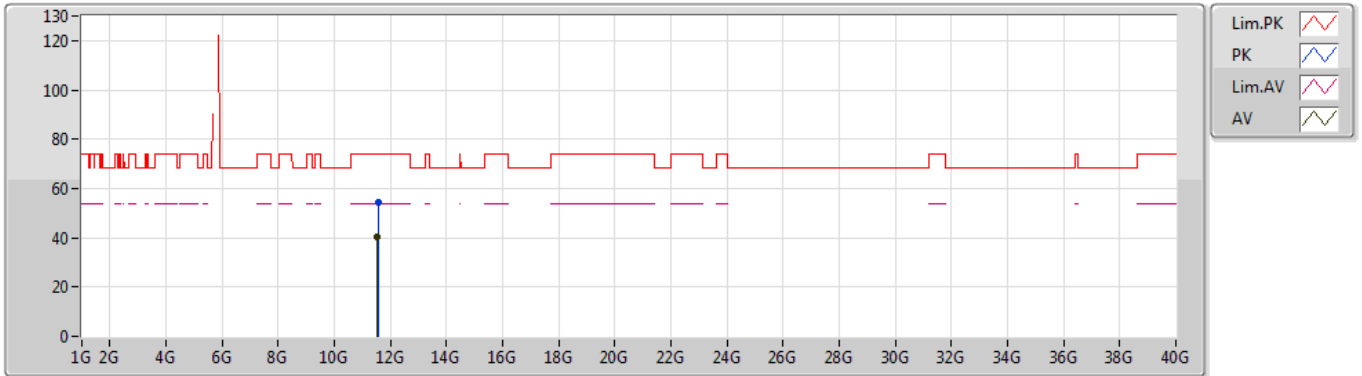

EUT Y_2TX ANT_H
 Setting 18
 02-B-4
 FSU(100015)

Type	Freq (Hz)	Level (dBuV/m)	Limit (dBuV/m)	Margin (dB)	Factor (dB)	Dist (m)	Condition	Azimuth (°)	Height (m)	Comment	Raw (dBuV)
PK	11.55056G	54.18	74.00	-19.82	14.97	3	Horizontal	171	1.02	-	39.21
AV	11.54808G	40.37	54.00	-13.63	14.97	3	Horizontal	171	1.02	-	25.40