

FCC Test Report

Report No.: RF160315E16-1

FCC ID: YZKECWO7220L

Test Model: ECWO7220-L

Received Date: Mar. 15, 2016

Test Date: Mar. 30 to May 20, 2016

Issued Date: June 01, 2016

Applicant: Edgecore Networks Corporation.

Address: No.1, Creation Rd. III, Hsinchu Science Park, Hsinchu 30077, Taiwan, R.O.C

Issued By: Bureau Veritas Consumer Products Services (H.K.) Ltd., Taoyuan Branch
Hsin Chu Laboratory

Lab Address: E-2, No.1, Li Hsin 1st Road, Hsinchu Science Park, Hsinchu City 300,
Taiwan R.O.C.

Test Location (1): E-2, No.1, Li Hsin 1st Road, Hsinchu Science Park, Hsinchu City 300,
Taiwan R.O.C.

Test Location (2): No. 49, Ln. 206, Wende Rd., Shangshan Tsuen, Chiung Lin Hsiang, Hsin
Chu Hsien 307, Taiwan R.O.C.



This report is for your exclusive use. Any copying or replication of this report to or for any other person or entity, or use of our name or trademark, is permitted only with our prior written permission. This report sets forth our findings solely with respect to the test samples identified herein. The results set forth in this report are not indicative or representative of the quality or characteristics of the lot from which a test sample was taken or any similar or identical product unless specifically and expressly noted. Our report includes all of the tests requested by you and the results thereof based upon the information that you provided to us. You have 60 days from date of issuance of this report to notify us of any material error or omission caused by our negligence, provided, however, that such notice shall be in writing and shall specifically address the issue you wish to raise. A failure to raise such issue within the prescribed time shall constitute your unqualified acceptance of the completeness of this report, the tests conducted and the correctness of the report contents. Unless specific mention, the uncertainty of measurement has been explicitly taken into account to declare the compliance or non-compliance to the specification. The report must not be used by the client to claim product certification, approval, or endorsement by TAF or any government agencies.

Table of Contents

Release Control Record	4
1 Certificate of Conformity	5
2 Summary of Test Results	6
2.1 Measurement Uncertainty	6
2.2 Modification Record	6
3 General Information	7
3.1 General Description of EUT	7
3.2 Description of Test Modes	10
3.2.1 Test Mode Applicability and Tested Channel Detail	11
3.3 Duty Cycle of Test Signal	13
3.4 Description of Support Units	14
3.4.1 Configuration of System under Test	15
3.5 General Description of Applied Standard	16
4 Test Types and Results	17
4.1 Radiated Emission and Bandedge Measurement	17
4.1.1 Limits of Radiated Emission and Bandedge Measurement	17
4.1.2 Test Instruments	19
4.1.3 Test Procedure	20
4.1.4 Deviation from Test Standard	20
4.1.5 Test Setup	21
4.1.6 EUT Operating Condition	21
4.1.7 Test Results	22
4.2 Conducted Emission Measurement	41
4.2.1 Limits of Conducted Emission Measurement	41
4.2.2 Test Instruments	41
4.2.3 Test Procedure	42
4.2.4 Deviation from Test Standard	42
4.2.5 Test Setup	42
4.2.6 EUT Operating Condition	42
4.2.7 Test Results	43
4.3 Transmit Power Measurement	45
4.3.1 Limits of Transmit Power Measurement	45
4.3.2 Test Setup	45
4.3.3 Test Instruments	45
4.3.4 Test Procedure	45
4.3.5 Deviation from Test Standard	45
4.3.6 EUT Operating Condition	46
4.3.7 Test Result	47
4.4 Peak Power Spectral Density Measurement	51
4.4.1 Limits of Peak Power Spectral Density Measurement	51
4.4.2 Test Setup	51
4.4.3 Test Instruments	51
4.4.4 Test Procedure	52
4.4.5 Deviation from Test Standard	52
4.4.6 EUT Operating Condition	52
4.4.7 Test Results	53
4.5 Frequency Stability Measurement	59
4.5.1 Limits of Frequency Stability Measurement	59
4.5.2 Test Setup	59
4.5.3 Test Instruments	59
4.5.4 Test Procedure	59
4.5.5 Deviation from Test Standard	59
4.5.6 EUT Operating Condition	59

4.5.7 Test Results	60
4.6 6dB Bandwidth Measurement	61
4.6.1 Limits of 6dB Bandwidth Measurement	61
4.6.2 Test Setup	61
4.6.3 Test Instruments	61
4.6.4 Test Procedure	61
4.6.5 Deviation from Test Standard	61
4.6.6 EUT Operating Condition	61
4.6.7 Test Results	62
5 Pictures of Test Arrangements	64
Annex A- Radiated Out of Band Emisison (OOBE) Measurement (For U-NII-3 band)	65
Appendix – Information on the Testing Laboratories	68

Release Control Record

Issue No.	Description	Date Issued
RF160315E16-1	Original release.	June 01, 2016

1 Certificate of Conformity

Product: 802.11a/ac/b/g/n Outdoor Wireless Access Point

Brand: Edge-corE

Test Model: ECWO7220-L

Sample Status: MASS-PRODUCTION

Applicant: Edgecore Networks Corporation.

Test Date: Mar. 30 to May 20, 2016

Standard: 47 CFR FCC Part 15, Subpart E (Section 15.407)
ANSI C63.10: 2013

The above equipment has been tested by **Bureau Veritas Consumer Products Services (H.K.) Ltd., Taoyuan Branch**, and found compliance with the requirement of the above standards. The test record, data evaluation & Equipment Under Test (EUT) configurations represented herein are true and accurate accounts of the measurements of the sample's EMC characteristics under the conditions specified in this report.

Prepared by : Wendy Wu, **Date:** June 01, 2016
Wendy Wu / Specialist

Approved by : May Chen, **Date:** June 01, 2016
May Chen / Manager

2 Summary of Test Results

47 CFR FCC Part 15, Subpart E (SECTION 15.407)			
FCC Clause	Test Item	Result	Remarks
15.407(b)(6)	AC Power Conducted Emissions	Pass	Meet the requirement of limit. Minimum passing margin is -1.28dB at 12.07813MHz.
15.407(b)(1/2/3/4(i/ii)/6)	Radiated Emissions & Band Edge Measurement*	Pass	Meet the requirement of limit. Minimum passing margin is -0.1dB at 5586.10MHz.
15.407(a)(1/2/3)	Max Average Transmit Power	Pass	Meet the requirement of limit.
15.407(a)(1/2/3)	Peak Power Spectral Density	Pass	Meet the requirement of limit.
15.407(e)	6dB bandwidth	Pass	Meet the requirement of limit. (U-NII-3 Band only)
15.407(g)	Frequency Stability	Pass	Meet the requirement of limit.
15.203	Antenna Requirement	Pass	Antenna connector is MMCX not a standard connector.

*For U-NII-3 band compliance with rule part 15.407(b)(i), the OOB test plots were recorded in Annex A.

NOTE: 1. For WLAN: The EUT was operating in 2.412 ~ 2.462GHz, 5.18~5.24 GHz and 5.745~5.825GHz frequencies. This report was recorded the RF parameters including 5.18~5.24 GHz and 5.745~5.825GHz. For the 2.412 ~ 2.462GHz RF parameters was recorded in another test report.

2.1 Measurement Uncertainty

Where relevant, the following measurement uncertainty levels have been estimated for tests performed on the EUT as specified in CISPR 16-4-2:

Measurement	Frequency	Expanded Uncertainty (k=2) (±)
Conducted Emissions at mains ports	150kHz ~ 30MHz	1.83 dB
Radiated Emissions up to 1 GHz	30MHz ~ 1GHz	5.31 dB
Radiated Emissions above 1 GHz	1GHz ~ 6GHz	3.40 dB
	6GHz ~ 18GHz	3.73 dB
	18GHz ~ 40GHz	4.11 dB

2.2 Modification Record

There were no modifications required for compliance.

3 General Information

3.1 General Description of EUT

Product	802.11a/ac/b/g/n Outdoor Wireless Access Point
Brand	Edge-corE
Test Model	ECWO7220-L
Status of EUT	MASS-PRODUCTION
Power Supply Rating	DC 42.5~57V from POE
Modulation Type	CCK, DQPSK, DBPSK for DSSS 64QAM, 16QAM, QPSK, BPSK for OFDM 256QAM for OFDM in 11ac mode and VHT (20/40) mode in 2.4GHz
Modulation Technology	DSSS,OFDM
Transfer Rate	802.11b: up to 11Mbps 802.11a/g: up to 54Mbps 802.11n: up to 600Mbps 802.11ac: up to 1300Mbps
Operating Frequency	For 15.247: 2.412 ~ 2.462GHz For 15.407: 5.18GHz ~ 5.24GHz and 5.745GHz ~ 5.825GHz
Number of Channel	For 15.247: 802.11b, 802.11g, 802.11n (HT20), (VHT20): 11 802.11n (HT40), (VHT40): 7 For 15.407: 802.11a, 802.11n (HT20), 802.11ac (VHT20): 9 802.11n (HT40), 802.11ac (VHT40): 4 802.11ac (VHT80):2
Output Power	For 15.247: 462.001mW For 15.407: 5.18GHz ~ 5.24GHz 31.49mW 5.745GHz ~ 5.825GHz 858.399mW
Antenna Type	Refer to Note
Antenna Connector	Refer to Note
Accessory Device	NA
Data Cable Supplied	NA

Note:

- 2.4GHz and 5GHz technology can transmit at same time.
- The EUT power needs to be supplied from POE, the information is as below table:

POE (Only for test not for sale)		
Brand	Model No.	Spec.
Power Dsine	PD-9501G/AC	Input: 100-240V, 1.5A, 50-60Hz Output: 55V, 1.35A

3. The antennas provided to the EUT, please refer to the following table:

For 2.4GHz								
Antenna No	PCB Chain No.	Brand	Model	Antenna Type	Antenna Connector	Gain (dBi)	Cable Length (mm)	Frequency (GHz to GHz)
1	Chain 0	Accton	OAP1122B-0614-EC 3X3 SKU	Dipole	MMCX	6	175	2.4~2.4835
2	Chain 1	Accton		Dipole	MMCX	5.7	70	2.4~2.4835
3	Chain 2	Accton		Dipole	MMCX	5.4	170	2.4~2.4835
For 5GHz								
Antenna No	PCB Chain No.	Brand	Model	Antenna Type	Antenna Connector	Gain (dBi)	Cable Length (mm)	Frequency (GHz to GHz)
1	Chain 0	Accton	OAP1122B-0614-EC 3X3 SKU	Dipole	MMCX	5.6	205	5.15~5.25
						5.1		5.25~5.35
						5.1		5.47~5.725
						6		5.725~5.85
2	Chain 1	Accton		Dipole	MMCX	5.9	150	5.15~5.25
						5.7		5.25~5.35
						6		5.47~5.725
						5.5		5.725~5.85
3	Chain 2	Accton		Dipole	MMCX	6	75	5.15~5.25
						5.5		5.25~5.35
						5.9		5.47~5.725
						5.5		5.725~5.85

4. The EUT incorporates a MIMO function.

2.4GHz Band			
MODULATION MODE	DATA RATE (MCS)	TX & RX CONFIGURATION	
802.11b	1 ~ 11Mbps	3TX	3RX
802.11g	6 ~ 54Mbps	3TX	3RX
802.11n (HT20)	MCS 0~7	3TX	3RX
	MCS 8~15	3TX	3RX
	MCS 16~23	3TX	3RX
802.11n (HT40)	MCS 0~7	3TX	3RX
	MCS 8~15	3TX	3RX
	MCS 16~23	3TX	3RX
VHT20	MCS0~8 Nss=1	3TX	3RX
	MCS0~8 Nss=2	3TX	3RX
	MCS0~9 Nss=3	3TX	3RX
VHT40	MCS0~9 Nss=1	3TX	3RX
	MCS0~9 Nss=2	3TX	3RX
	MCS0~9 Nss=3	3TX	3RX
5GHz Band			
MODULATION MODE	DATA RATE (MCS)	TX & RX CONFIGURATION	
802.11a	6 ~ 54Mbps	3TX	3RX
802.11n (HT20)	MCS 0~7	3TX	3RX
	MCS 8~15	3TX	3RX
	MCS 16~23	3TX	3RX
802.11n (HT40)	MCS 0~7	3TX	3RX
	MCS 8~15	3TX	3RX
	MCS 16~23	3TX	3RX
802.11ac (VHT20)	MCS0~8 Nss=1	3TX	3RX
	MCS0~8 Nss=2	3TX	3RX
	MCS0~9 Nss=3	3TX	3RX
802.11ac (VHT40)	MCS0~9 Nss=1	3TX	3RX
	MCS0~9 Nss=2	3TX	3RX
	MCS0~9 Nss=3	3TX	3RX
802.11ac (VHT80)	MCS0~9 Nss=1	3TX	3RX
	MCS0~9 Nss=2	3TX	3RX
	MCS0~9 Nss=3	3TX	3RX

Note: 1. The modulation and bandwidth are similar for 802.11n mode for 20MHz (40MHz) and 802.11ac mode for 20MHz (40MHz), therefore investigated worst case to representative mode in test report. (Final test mode refer section 3.2.1)

5. The above EUT information is declared by manufacturer and for more detailed features description, please refer to the manufacturer's specifications or user's manual.

3.2 Description of Test Modes

FOR 5180 ~ 5240MHz

4 channels are provided for 802.11a, 802.11n (HT20), 802.11ac (VHT20):

Channel	Frequency	Channel	Frequency
36	5180 MHz	44	5220 MHz
40	5200 MHz	48	5240 MHz

2 channels are provided for 802.11n (HT40), 802.11ac (VHT40):

Channel	Frequency	Channel	Frequency
38	5190 MHz	46	5230 MHz

1 channel is provided for 802.11ac (VHT80):

Channel	Frequency
42	5210MHz

FOR 5745 ~ 5825MHz:

5 channels are provided for 802.11a, 802.11n (HT20), 802.11ac (VHT20):

Channel	Frequency	Channel	Frequency
149	5745MHz	161	5805MHz
153	5765MHz	165	5825MHz
157	5785MHz		

2 channels are provided for 802.11n (HT40), 802.11ac (VHT40):

Channel	Frequency	Channel	Frequency
151	5755MHz	159	5795MHz

1 channel is provided for 802.11ac (VHT80):

Channel	Frequency
155	5775MHz

3.2.1 Test Mode Applicability and Tested Channel Detail

EUT Configure Mode	Applicable To				Description
	RE≥1G	RE<1G	PLC	APCM	
-	√	√	√	√	-

Where **RE≥1G**: Radiated Emission above 1GHz **RE<1G**: Radiated Emission below 1GHz
PLC: Power Line Conducted Emission **APCM**: Antenna Port Conducted Measurement

Radiated Emission Test (Above 1GHz):

- Pre-Scan has been conducted to determine the worst-case mode from all possible combinations between available modulations, data rates and antenna ports (if EUT with antenna diversity architecture).
- Following channel(s) was (were) selected for the final test as listed below.

Mode	FREQ. Band (MHz)	Available Channel	Tested Channel	Modulation Technology	Modulation Type	Data Rate (Mbps)
802.11a	5180-5240	36 to 48	36, 40, 48	OFDM	BPSK	6
802.11ac (VHT20)		36 to 48	36, 40, 48	OFDM	BPSK	6.5
802.11ac (VHT40)		38 to 46	38, 46	OFDM	BPSK	13.5
802.11ac (VHT80)		42	42	OFDM	BPSK	29.3
802.11a	5745-5825	149 to 165	149, 157, 165	OFDM	BPSK	6
802.11ac (VHT20)		149 to 165	149, 157, 165	OFDM	BPSK	6.5
802.11ac (VHT40)		151 to 159	151, 159	OFDM	BPSK	13.5
802.11ac (VHT80)		155	155	OFDM	BPSK	29.3

Radiated Emission Test (Below 1GHz):

- Pre-Scan has been conducted to determine the worst-case mode from all possible combinations between available modulations, data rates and antenna ports (if EUT with antenna diversity architecture).
- Following channel(s) was (were) selected for the final test as listed below.

Mode	FREQ. Band (MHz)	Available Channel	Tested Channel	Modulation Technology	Modulation Type	Data Rate (Mbps)
802.11ac (VHT40)	5745-5825	151 to 159	159	OFDM	BPSK	13.5

Power Line Conducted Emission Test:

- Pre-Scan has been conducted to determine the worst-case mode from all possible combinations between available modulations, data rates and antenna ports (if EUT with antenna diversity architecture).
- Following channel(s) was (were) selected for the final test as listed below.

Mode	FREQ. Band (MHz)	Available Channel	Tested Channel	Modulation Technology	Modulation Type	Data Rate (Mbps)
802.11ac (VHT40)	5745-5825	151 to 159	159	OFDM	BPSK	13.5

Antenna Port Conducted Measurement:

- This item includes all test value of each mode, but only includes spectrum plot of worst value of each mode.
- Pre-Scan has been conducted to determine the worst-case mode from all possible combinations between available modulations, data rates and antenna ports (if EUT with antenna diversity architecture).
- Following channel(s) was (were) selected for the final test as listed below.

Mode	FREQ. Band (MHz)	Available Channel	Tested Channel	Modulation Technology	Modulation Type	Data Rate (Mbps)
802.11a	5180-5240	36 to 48	36, 40, 48	OFDM	BPSK	6
802.11ac (VHT20)		36 to 48	36, 40, 48	OFDM	BPSK	6.5
802.11ac (VHT40)		38 to 46	38, 46	OFDM	BPSK	13.5
802.11ac (VHT80)		42	42	OFDM	BPSK	29.3
802.11a	5745-5825	149 to 165	149, 157, 165	OFDM	BPSK	6
802.11ac (VHT20)		149 to 165	149, 157, 165	OFDM	BPSK	6.5
802.11ac (VHT40)		151 to 159	151, 159	OFDM	BPSK	13.5
802.11ac (VHT80)		155	155	OFDM	BPSK	29.3

Test Condition:

APPLICABLE TO	ENVIRONMENTAL CONDITIONS	INPUT POWER	TESTED BY	TEST LOCATION
RE \geq 1G	25deg. C, 74%RH	120Vac, 60Hz	Andy Ho	1
RE $<$ 1G	25deg. C, 73%RH	120Vac, 60Hz	Andy Ho	1
PLC	25deg. C, 62%RH	120Vac, 60Hz	Eagle Chen	2
APCM	21deg. C, 60%RH	120Vac, 60Hz	Anderson Chen	1

3.3 Duty Cycle of Test Signal

If duty cycle of test signal is $\geq 98\%$, duty factor is not required.

If duty cycle of test signal is $< 98\%$, duty factor shall be considered.

802.11a: Duty cycle = $2.064 \text{ ms} / 2.083 \text{ ms} = 0.991$

802.11ac (VHT20): Duty cycle = $1.919 \text{ ms} / 1.94 \text{ ms} = 0.989$

802.11ac (VHT40): Duty cycle = $0.941 \text{ ms} / 0.965 \text{ ms} = 0.975$, Duty factor = $10 * \log(1/0.975) = 0.11$

802.11ac (VHT80): Duty cycle = $0.458 \text{ ms} / 0.483 \text{ ms} = 0.948$, Duty factor = $10 * \log(1/0.948) = 0.23$

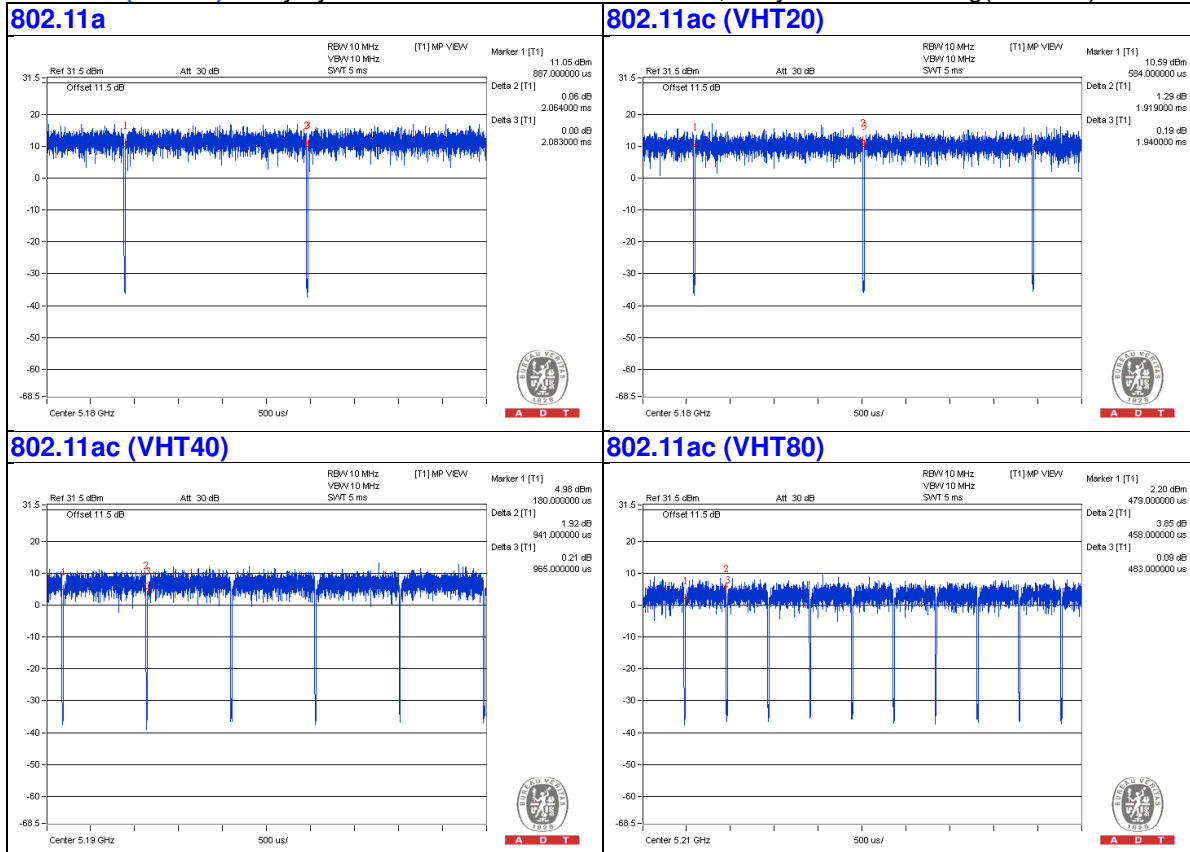

3.4 Description of Support Units

The EUT has been tested as an independent unit together with other necessary accessories or support units. The following support units or accessories were used to form a representative test configuration during the tests.

ID	Product	Brand	Model No.	Serial No.	FCC ID	Remarks
A.	Notebook Computer	DELL	E6420	B92T3R1	FCC DoC	Provided by Lab
B.	PoE Adapter	Power Dsine	PD-9501G/AC	NA	NA	Supplied by Client
C.	HUB	PCI	FX-05EA	NA	NA	Provided by Lab

Note:

1. All power cords of the above support units are non-shielded (1.8m).

ID	Descriptions	Qty.	Length (m)	Shielding (Yes/No)	Cores (Qty.)	Remarks
1.	RJ45 cable	1	10	No	0	Provided by Lab
2.	RJ45 cable	1	3	No	0	Provided by Lab
3.	RJ45 cable	1	10	No	0	Provided by Lab
4.	Cable	1	3	No	0	Provided by Lab

3.4.1 Configuration of System under Test

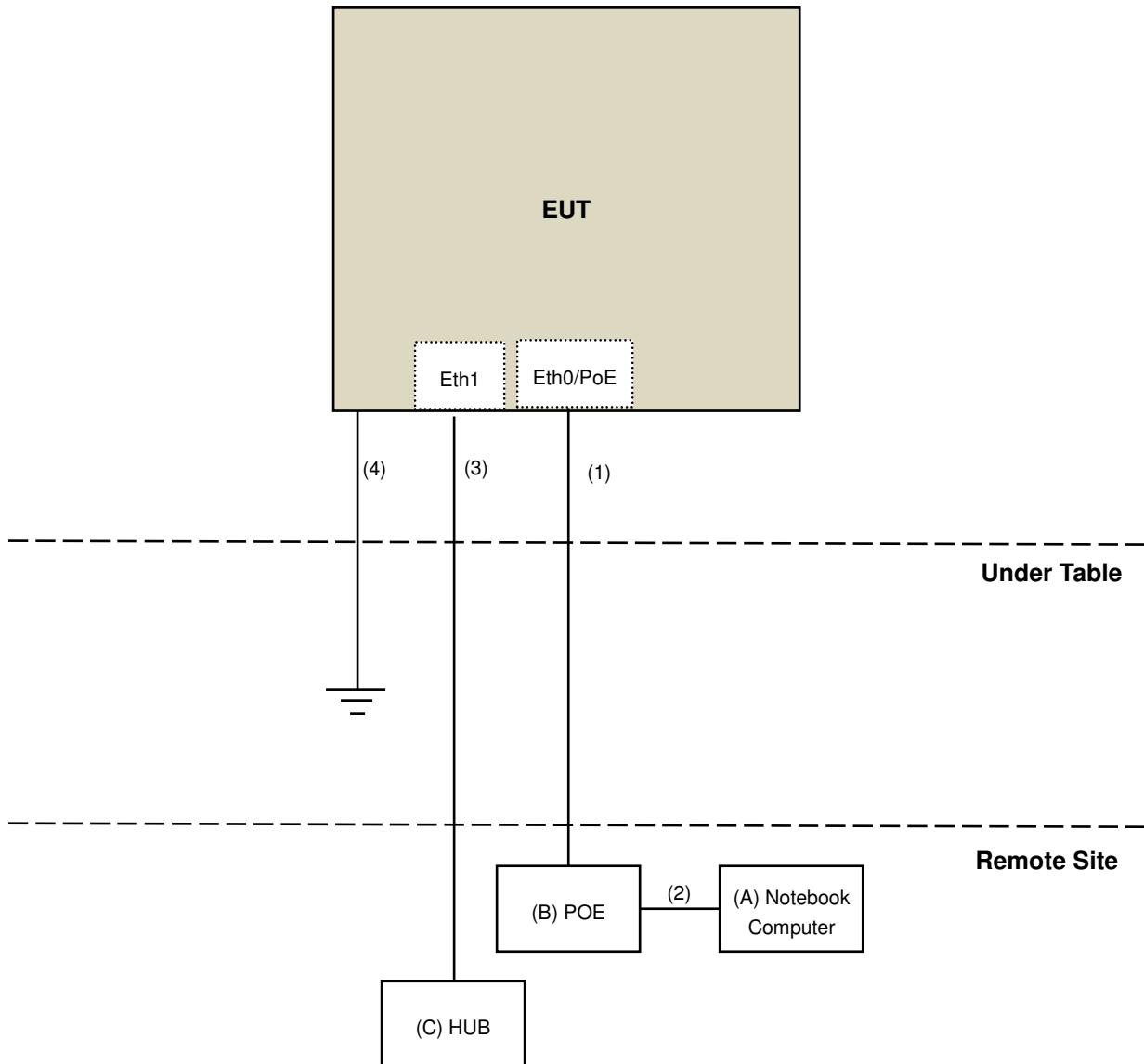

3.5 General Description of Applied Standard

The EUT is a RF Product. According to the specifications of the manufacturer, it must comply with the requirements of the following standards:

FCC Part 15, Subpart E (15.407)

KDB 789033 D02 General UNII Test Procedure New Rules v01r02

KDB 662911 D01 Multiple Transmitter Output v02r01

ANSI C63.10-2013

All test items have been performed and recorded as per the above standards.

NOTE: The EUT has been verified to comply with the requirements of FCC Part 15, Subpart B, Class B (DoC). The test report has been issued separately.

4 Test Types and Results

4.1 Radiated Emission and Bandedge Measurement

4.1.1 Limits of Radiated Emission and Bandedge Measurement

Radiated emissions which fall in the restricted bands must comply with the radiated emission limits specified as below table.

Frequencies (MHz)	Field Strength (microvolts/meter)	Measurement Distance (meters)
0.009 ~ 0.490	2400/F(kHz)	300
0.490 ~ 1.705	24000/F(kHz)	30
1.705 ~ 30.0	30	30
30 ~ 88	100	3
88 ~ 216	150	3
216 ~ 960	200	3
Above 960	500	3

NOTE:

1. The lower limit shall apply at the transition frequencies.
2. Emission level (dBuV/m) = 20 log Emission level (uV/m).
3. For frequencies above 1000MHz, the field strength limits are based on average detector, however, the peak field strength of any emission shall not exceed the maximum permitted average limits, specified above by more than 20dB under any condition of modulation.

Limits OF UNWANTED EMISSION OUT OF THE RESTRICTED Bands

Applicable To	Limit	
789033 D02 General UNII Test Procedure New Rules v01r02	FIELD STRENGTH at 3m	
	PK:74 (dBμV/m)	AV:54 (dBμV/m)
Applicable To	EIRP Limit	Equivalent Field Strength at 3m
15.407(b)(1)	PK:-27 (dBm/MHz)	PK:68.2(dBμV/m)
15.407(b)(2)		
15.407(b)(3)		
15.407(b)(4)(i)	PK:-27 (dBm/MHz) ^{*1} PK:10 (dBm/MHz) ^{*2} PK:15.6 (dBm/MHz) ^{*3} PK:27 (dBm/MHz) ^{*4}	PK: 68.2(dBμV/m) ^{*1} PK:105.2 (dBμV/m) ^{*2} PK: 110.8(dBμV/m) ^{*3} PK:122.2 (dBμV/m) ^{*4}
15.407(b)(4)(ii)	FIELD STRENGTH at 3m / § 15.247(d),	
	PK:74 (dBμV/m)	AV:54 (dBμV/m)
^{*1} beyond 75 MHz or more above of the band edge. ^{*2} below the band edge increasing linearly to 10 dBm/MHz at 25 MHz above. ^{*3} below the band edge increasing linearly to a level of 15.6 dBm/MHz at 5 MHz above. ^{*4} from 5 MHz above or below the band edge increasing linearly to a level of 27 dBm/MHz at the band edge.		

NOTE:

The following formula is used to convert the equipment isotropic radiated power (eirp) to field strength:

$$E = \frac{1000000\sqrt{30P}}{3} \mu\text{V/m, where } P \text{ is the eirp (Watts).}$$

4.1.2 Test Instruments

DESCRIPTION & MANUFACTURER	MODEL NO.	SERIAL NO.	CALIBRATED DATE	CALIBRATED UNTIL
Test Receiver Agilent	N9038A	MY50010156	Aug. 12, 2015	Aug. 11, 2016
Pre-Amplifier ^(*) EMCI	EMC001340	980142	Jan. 20, 2016	Jan. 19, 2018
Loop Antenna ^(*) Electro-Metrics	EM-6879	264	Dec. 16, 2014	Dec. 15, 2016
RF Cable	NA	LOOPCAB-001 LOOPCAB-002	Jan. 18, 2016	Jan. 17, 2017
Pre-Amplifier Mini-Circuits	ZFL-1000VH2B	AMP-ZFL-07	May 07, 2016	May 06, 2017
Trilog Broadband Antenna SCHWARZBECK	VULB 9168	9168-156	Jan. 04, 2016	Jan. 03, 2017
RF Cable	8D	966-3-1 966-3-2 966-3-3	Apr. 02, 2016	Apr. 01, 2017
Horn Antenna SCHWARZBECK	BBHA9120-D	9120D-406	Jan. 20, 2016	Jan. 19, 2017
Pre-Amplifier Agilent	8449B	3008A02465	Apr. 05, 2016	Apr. 04, 2017
RF Cable	EMC104-SM-SM-2000 EMC104-SM-SM-5000 EMC104-SM-SM-5000	150317 150321 150322	Mar. 30, 2016	Mar. 29, 2017
Spectrum Analyzer Keysight	N9030A	MY54490520	July 26, 2015	July 25, 2016
Pre-Amplifier EMCI	EMC184045	980143	Jan. 15, 2016	Jan. 14, 2017
Horn Antenna SCHWARZBECK	BBHA 9170	BBHA9170608	Jan. 08, 2016	Jan. 07, 2017
RF Cable	SUCOFLEX 102	36432/2 36441/2	Jan. 16, 2016	Jan. 15, 2017
Software	ADT_Radiated_V8.7.07	NA	NA	NA
Antenna Tower & Turn Table Max-Full	MF-7802	MF780208406	NA	NA
Boresight Antenna Fixture	FBA-01	FBA-SIP01	NA	NA
Spectrum Analyzer R&S	FSP40	100060	May 11, 2016	May 10, 2017
Power meter Anritsu	ML2495A	1014008	May 5, 2016	May 4, 2017
Power sensor Anritsu	MA2411B	0917122	May 5, 2016	May 4, 2017
Temperature & Humidity Chamber Giant Force	GTH-150-40-SP-AR	MAA0812-008	Jan. 15, 2016	Jan. 14, 2017

Note:

1. The calibration interval of the above test instruments is 12 months and the calibrations are traceable to NML/ROC and NIST/USA.
2. *The calibration interval of the above test instruments is 24 months and the calibrations are traceable to NML/ROC and NIST/USA.
3. The test was performed in 966 Chamber No. 3.
4. The FCC Site Registration No. is 147459
5. Loop antenna was used for all emissions below 30 MHz.
6. The CANADA Site Registration No. is 20331-1
7. Tested Date: May 13 to 20, 2016

4.1.3 Test Procedure

- a. The EUT was placed on the top of a rotating table 0.8 meters (for below 1GHz) / 1.5 meters (for above 1GHz) above the ground at 3 meter chamber room for test. The table was rotated 360 degrees to determine the position of the highest radiation.
- b. The EUT was set 3 meters away from the interference-receiving antenna, which was mounted on the top of a variable-height antenna tower.
- c. The height of antenna is varied from one meter to four meters above the ground to determine the maximum value of the field strength. Both horizontal and vertical polarizations of the antenna are set to make the measurement.
- d. For each suspected emission, the EUT was arranged to its worst case and then the antenna was tuned to heights from 1 meter to 4 meters and the rotatable table was turned from 0 degrees to 360 degrees to find the maximum reading.
- e. The test-receiver system was set to quasi-peak detect function and specified bandwidth with maximum hold mode when the test frequency is below 1 GHz.
- f. The test-receiver system was set to peak and average detect function and specified bandwidth with maximum hold mode when the test frequency is above 1 GHz. If the peak reading value also meets average limit, measurement with the average detector is unnecessary.

Note:

1. The resolution bandwidth and video bandwidth of test receiver/spectrum analyzer is 120kHz for Quasi-peak detection (QP) at frequency below 1GHz.
2. The resolution bandwidth of test receiver/spectrum analyzer is 1 MHz and the video bandwidth is 3 MHz for Peak detection (PK) at frequency above 1GHz.
3. The resolution bandwidth of test receiver/spectrum analyzer is 1MHz and the video bandwidth is 3MHz for RMS Average (Duty cycle < 98%) for Average detection (AV) at frequency above 1GHz, then the measurement results was added to a correction factor ($10 \log(1/\text{duty cycle})$).
4. The resolution bandwidth of test receiver/spectrum analyzer is 1MHz and the video bandwidth is 10Hz (Duty cycle $\geq 98\%$) for Average detection (AV) at frequency above 1GHz.
5. All modes of operation were investigated and the worst-case emissions are reported.

4.1.4 Deviation from Test Standard

No deviation.

4.1.5 Test Setup

<Frequency Range below 1GHz>

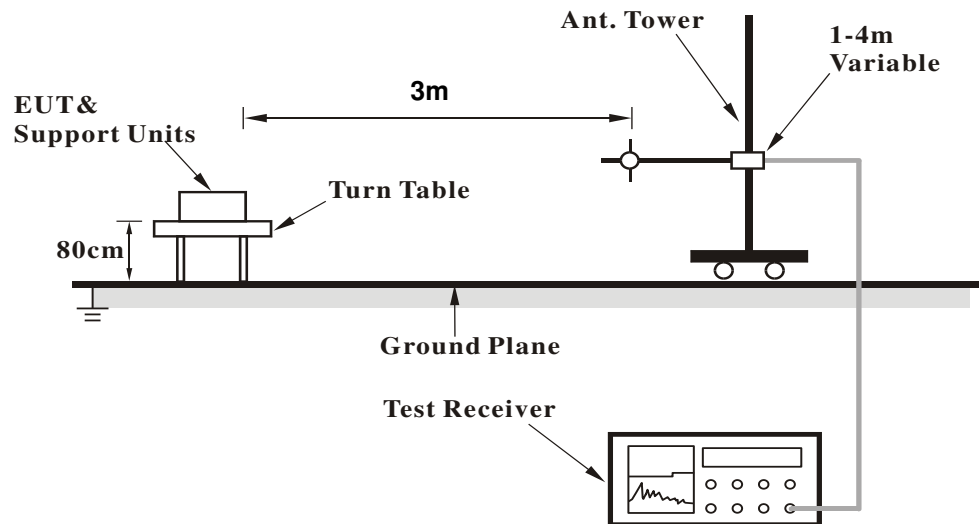

<Frequency Range above 1GHz>

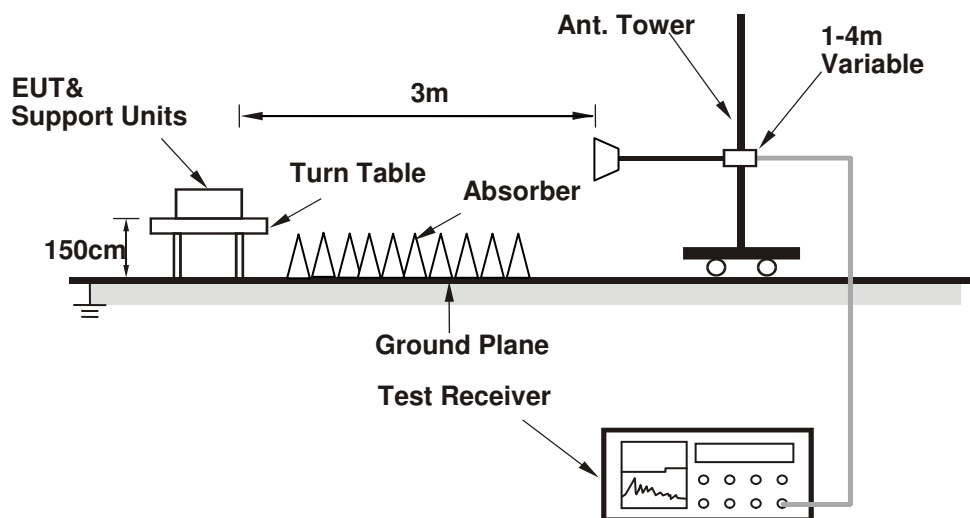

For the actual test configuration, please refer to the attached file (Test Setup Photo).

4.1.6 EUT Operating Condition

1. Connect the EUT with the support unit A (Notebook Computer) which is placed on remote site.
2. Controlling software (Mtool.exe (2.0.2.7)) has been activated to set the EUT on specific status.

4.1.7 Test Results

Above 1GHz Data:

802.11a

CHANNEL	TX Channel 36	DETECTOR FUNCTION	Peak (PK)
FREQUENCY RANGE	1GHz ~ 40GHz		Average (AV)

ANTENNA POLARITY & TEST DISTANCE: HORIZONTAL AT 3 M

NO.	FREQ. (MHz)	EMISSION LEVEL (dBuV/m)	LIMIT (dBuV/m)	MARGIN (dB)	ANTENNA HEIGHT (m)	TABLE ANGLE (Degree)	RAW VALUE (dBuV)	CORRECTION FACTOR (dB/m)
1	5101.00	51.2 PK	74.0	-22.8	1.44 H	176	48.33	2.87
2	5101.00	40.7 AV	54.0	-13.3	1.44 H	176	37.83	2.87
3	*5180.00	95.7 PK			1.44 H	176	92.64	3.06
4	*5180.00	85.9 AV			1.44 H	176	82.84	3.06
5	#10360.00	51.9 PK	74.0	-22.1	1.34 H	207	38.25	13.65
6	#10360.00	37.9 AV	54.0	-16.1	1.34 H	207	24.25	13.65
7	15540.00	51.9 PK	74.0	-22.1	1.49 H	228	36.22	15.68
8	15540.00	38.6 AV	54.0	-15.4	1.49 H	228	22.92	15.68

ANTENNA POLARITY & TEST DISTANCE: VERTICAL AT 3 M

NO.	FREQ. (MHz)	EMISSION LEVEL (dBuV/m)	LIMIT (dBuV/m)	MARGIN (dB)	ANTENNA HEIGHT (m)	TABLE ANGLE (Degree)	RAW VALUE (dBuV)	CORRECTION FACTOR (dB/m)
1	5101.00	62.2 PK	74.0	-11.8	1.43 V	31	59.33	2.87
2	5101.00	51.6 AV	54.0	-2.4	1.43 V	31	48.73	2.87
3	*5180.00	110.7 PK			1.69 V	116	107.64	3.06
4	*5180.00	100.4 AV			1.69 V	116	97.34	3.06
5	#10360.00	51.1 PK	74.0	-22.9	1.57 V	214	37.45	13.65
6	#10360.00	37.0 AV	54.0	-17.0	1.57 V	214	23.35	13.65
7	15540.00	52.3 PK	74.0	-21.7	1.42 V	190	36.62	15.68
8	15540.00	38.9 AV	54.0	-15.1	1.42 V	190	23.22	15.68

REMARKS:

1. Emission Level(dBuV/m) = Raw Value(dBuV) + Correction Factor(dB/m)
2. Correction Factor(dB/m) = Antenna Factor(dB/m) + Cable Factor(dB) – Pre-Amplifier Factor(dB)
3. The other emission levels were very low against the limit.
4. Margin value = Emission Level – Limit value
5. " * ": Fundamental frequency.
6. " # ": The radiated frequency is out of the restricted band.

CHANNEL	TX Channel 40	DETECTOR FUNCTION	Peak (PK)
FREQUENCY RANGE	1GHz ~ 40GHz		Average (AV)

ANTENNA POLARITY & TEST DISTANCE: HORIZONTAL AT 3 M

NO.	FREQ. (MHz)	EMISSION LEVEL (dBuV/m)	LIMIT (dBuV/m)	MARGIN (dB)	ANTENNA HEIGHT (m)	TABLE ANGLE (Degree)	RAW VALUE (dBuV)	CORRECTION FACTOR (dB/m)
1	5119.00	48.7 PK	74.0	-25.3	1.41 H	185	45.79	2.91
2	5119.00	38.2 AV	54.0	-15.8	1.41 H	185	35.29	2.91
3	*5200.00	95.8 PK			1.41 H	185	92.70	3.10
4	*5200.00	85.9 AV			1.41 H	185	82.80	3.10
5	#10400.00	51.5 PK	74.0	-22.5	1.35 H	211	37.84	13.66
6	#10400.00	37.4 AV	54.0	-16.6	1.35 H	211	23.74	13.66
7	15600.00	51.6 PK	74.0	-22.4	1.48 H	231	35.94	15.66
8	15600.00	38.1 AV	54.0	-15.9	1.48 H	231	22.44	15.66

ANTENNA POLARITY & TEST DISTANCE: VERTICAL AT 3 M

NO.	FREQ. (MHz)	EMISSION LEVEL (dBuV/m)	LIMIT (dBuV/m)	MARGIN (dB)	ANTENNA HEIGHT (m)	TABLE ANGLE (Degree)	RAW VALUE (dBuV)	CORRECTION FACTOR (dB/m)
1	5119.00	61.9 PK	74.0	-12.1	1.58 V	31	58.99	2.91
2	5119.00	51.4 AV	54.0	-2.6	1.58 V	31	48.49	2.91
3	*5200.00	110.8 PK			1.58 V	216	107.70	3.10
4	*5200.00	100.4 AV			1.58 V	216	97.30	3.10
5	#10400.00	51.6 PK	74.0	-22.4	1.54 V	222	37.94	13.66
6	#10400.00	37.4 AV	54.0	-16.6	1.54 V	222	23.74	13.66
7	15600.00	52.0 PK	74.0	-22.0	1.47 V	202	36.34	15.66
8	15600.00	38.6 AV	54.0	-15.4	1.47 V	202	22.94	15.66

REMARKS:

1. Emission Level(dBuV/m) = Raw Value(dBuV) + Correction Factor(dB/m)
2. Correction Factor(dB/m) = Antenna Factor(dB/m) + Cable Factor(dB) – Pre-Amplifier Factor(dB)
3. The other emission levels were very low against the limit.
4. Margin value = Emission Level – Limit value
5. " * ": Fundamental frequency.
6. " # ": The radiated frequency is out of the restricted band.

CHANNEL	TX Channel 48	DETECTOR FUNCTION	Peak (PK)
FREQUENCY RANGE	1GHz ~ 40GHz		Average (AV)

ANTENNA POLARITY & TEST DISTANCE: HORIZONTAL AT 3 M

NO.	FREQ. (MHz)	EMISSION LEVEL (dBuV/m)	LIMIT (dBuV/m)	MARGIN (dB)	ANTENNA HEIGHT (m)	TABLE ANGLE (Degree)	RAW VALUE (dBuV)	CORRECTION FACTOR (dB/m)
1	5021.59	41.4 PK	74.0	-32.6	1.42 H	184	38.75	2.65
2	5021.59	34.2 AV	54.0	-19.8	1.42 H	184	31.55	2.65
3	5059.00	50.1 PK	74.0	-23.9	1.40 H	170	47.34	2.76
4	5059.00	35.7 AV	54.0	-18.3	1.40 H	170	32.94	2.76
5	*5240.00	96.2 PK			1.42 H	184	92.99	3.21
6	*5240.00	86.2 AV			1.42 H	184	82.99	3.21
7	5402.00	42.3 PK	74.0	-31.7	1.41 H	200	38.64	3.66
8	5402.00	30.4 AV	54.0	-23.6	1.41 H	200	26.74	3.66
9	#10480.00	51.4 PK	74.0	-22.6	1.38 H	198	37.39	14.01
10	#10480.00	37.0 AV	54.0	-17.0	1.38 H	198	22.99	14.01
11	15720.00	51.9 PK	74.0	-22.1	1.48 H	215	36.47	15.43
12	15720.00	38.3 AV	54.0	-15.7	1.48 H	215	22.87	15.43

ANTENNA POLARITY & TEST DISTANCE: VERTICAL AT 3 M

NO.	FREQ. (MHz)	EMISSION LEVEL (dBuV/m)	LIMIT (dBuV/m)	MARGIN (dB)	ANTENNA HEIGHT (m)	TABLE ANGLE (Degree)	RAW VALUE (dBuV)	CORRECTION FACTOR (dB/m)
1	5021.59	49.7 PK	74.0	-24.3	1.50 V	35	47.05	2.65
2	5021.59	43.4 AV	54.0	-10.6	1.50 V	35	40.75	2.65
3	5059.00	59.4 PK	74.0	-14.6	1.61 V	30	56.64	2.76
4	5059.00	47.9 AV	54.0	-6.1	1.61 V	30	45.14	2.76
5	*5240.00	111.2 PK			1.46 V	215	107.99	3.21
6	*5240.00	100.7 AV			1.46 V	215	97.49	3.21
7	5402.00	55.6 PK	74.0	-18.4	1.61 V	216	51.94	3.66
8	5402.00	44.1 AV	54.0	-9.9	1.61 V	216	40.44	3.66
9	#10480.00	51.2 PK	74.0	-22.8	1.52 V	223	37.19	14.01
10	#10480.00	37.1 AV	54.0	-16.9	1.52 V	223	23.09	14.01
11	15720.00	51.9 PK	74.0	-22.1	1.43 V	210	36.47	15.43
12	15720.00	38.4 AV	54.0	-15.6	1.43 V	210	22.97	15.43

REMARKS:

1. Emission Level(dBuV/m) = Raw Value(dBuV) + Correction Factor(dB/m)
2. Correction Factor(dB/m) = Antenna Factor(dB/m) + Cable Factor(dB) – Pre-Amplifier Factor(dB)
3. The other emission levels were very low against the limit.
4. Margin value = Emission Level – Limit value
5. " * ": Fundamental frequency.
6. " # ": The radiated frequency is out of the restricted band.

CHANNEL	TX Channel 149	DETECTOR FUNCTION	Peak (PK)
FREQUENCY RANGE	1GHz ~ 40GHz		Average (AV)

ANTENNA POLARITY & TEST DISTANCE: HORIZONTAL AT 3 M								
NO.	FREQ. (MHz)	EMISSION LEVEL (dBuV/m)	LIMIT (dBuV/m)	MARGIN (dB)	ANTENNA HEIGHT (m)	TABLE ANGLE (Degree)	RAW VALUE (dBuV)	CORRECTION FACTOR (dB/m)
1	#5586.57	57.5 PK	68.2	-10.7	1.51 H	53	55.00	2.50
2	*5745.00	107.2 PK			1.51 H	53	103.00	4.20
3	*5745.00	97.8 AV			1.51 H	53	93.60	4.20
4	#5984.15	57.3 PK	68.2	-10.9	1.51 H	53	54.00	3.30
5	11490.00	51.9 PK	74.0	-22.1	1.39 H	206	36.70	15.20
6	11490.00	40.3 AV	54.0	-13.7	1.39 H	206	25.10	15.20
7	#17235.00	57.0 PK	74.0	-17.0	1.54 H	228	37.00	20.00
8	#17235.00	44.8 AV	54.0	-9.2	1.54 H	228	24.80	20.00

ANTENNA POLARITY & TEST DISTANCE: VERTICAL AT 3 M								
NO.	FREQ. (MHz)	EMISSION LEVEL (dBuV/m)	LIMIT (dBuV/m)	MARGIN (dB)	ANTENNA HEIGHT (m)	TABLE ANGLE (Degree)	RAW VALUE (dBuV)	CORRECTION FACTOR (dB/m)
1	#5583.73	67.8 PK	68.2	-0.4	1.83 V	134	65.30	2.50
2	*5745.00	123.3 PK			1.83 V	134	119.10	4.20
3	*5745.00	113.5 AV			1.83 V	134	109.30	4.20
4	#5984.15	61.0 PK	68.2	-7.2	1.83 V	134	57.70	3.30
5	11490.00	52.6 PK	74.0	-21.4	1.38 V	318	37.40	15.20
6	11490.00	40.6 AV	54.0	-13.4	1.38 V	318	25.40	15.20
7	#17235.00	57.2 PK	74.0	-16.8	1.27 V	305	37.20	20.00
8	#17235.00	44.7 AV	54.0	-9.3	1.27 V	305	24.70	20.00

REMARKS:

1. Emission Level(dBuV/m) = Raw Value(dBuV) + Correction Factor(dB/m)
2. Correction Factor(dB/m) = Antenna Factor(dB/m) + Cable Factor(dB) – Pre-Amplifier Factor(dB)
3. The other emission levels were very low against the limit.
4. Margin value = Emission Level – Limit value
5. " * ": Fundamental frequency.
6. " # ": The radiated frequency is out of the restricted band.

CHANNEL	TX Channel 157	DETECTOR FUNCTION	Peak (PK)
FREQUENCY RANGE	1GHz ~ 40GHz		Average (AV)

ANTENNA POLARITY & TEST DISTANCE: HORIZONTAL AT 3 M

NO.	FREQ. (MHz)	EMISSION LEVEL (dBuV/m)	LIMIT (dBuV/m)	MARGIN (dB)	ANTENNA HEIGHT (m)	TABLE ANGLE (Degree)	RAW VALUE (dBuV)	CORRECTION FACTOR (dB/m)
1	#5625.52	57.5 PK	68.2	-10.7	1.53 H	64	54.90	2.60
2	*5785.00	106.9 PK			1.53 H	64	102.80	4.10
3	*5785.00	97.3 AV			1.53 H	64	93.20	4.10
4	#5948.05	58.8 PK	68.2	-9.4	1.53 H	64	55.60	3.20
5	11570.00	52.0 PK	74.0	-22.0	1.35 H	194	36.90	15.10
6	11570.00	40.5 AV	54.0	-13.5	1.35 H	194	25.40	15.10
7	#17355.00	57.3 PK	74.0	-16.7	1.44 H	224	36.80	20.50
8	#17355.00	45.2 AV	54.0	-8.8	1.44 H	224	24.70	20.50

ANTENNA POLARITY & TEST DISTANCE: VERTICAL AT 3 M

NO.	FREQ. (MHz)	EMISSION LEVEL (dBuV/m)	LIMIT (dBuV/m)	MARGIN (dB)	ANTENNA HEIGHT (m)	TABLE ANGLE (Degree)	RAW VALUE (dBuV)	CORRECTION FACTOR (dB/m)
1	#5626.00	67.8 PK	68.2	-0.4	1.75 V	136	65.20	2.60
2	*5785.00	122.9 PK			1.75 V	136	118.80	4.10
3	*5785.00	113.5 AV			1.75 V	136	109.40	4.10
4	#5944.25	68.0 PK	68.2	-0.2	1.75 V	136	64.90	3.10
5	11570.00	53.0 PK	74.0	-21.0	1.34 V	323	37.90	15.10
6	11570.00	40.8 AV	54.0	-13.2	1.34 V	323	25.70	15.10
7	#17355.00	56.8 PK	74.0	-17.2	1.28 V	292	36.30	20.50
8	#17355.00	44.3 AV	54.0	-9.7	1.28 V	292	23.80	20.50

REMARKS:

1. Emission Level(dBuV/m) = Raw Value(dBuV) + Correction Factor(dB/m)
2. Correction Factor(dB/m) = Antenna Factor(dB/m) + Cable Factor(dB) – Pre-Amplifier Factor(dB)
3. The other emission levels were very low against the limit.
4. Margin value = Emission Level – Limit value
5. " * ": Fundamental frequency.
6. " # ": The radiated frequency is out of the restricted band.

CHANNEL	TX Channel 165	DETECTOR FUNCTION	Peak (PK)
FREQUENCY RANGE	1GHz ~ 40GHz		Average (AV)

ANTENNA POLARITY & TEST DISTANCE: HORIZONTAL AT 3 M

NO.	FREQ. (MHz)	EMISSION LEVEL (dBuV/m)	LIMIT (dBuV/m)	MARGIN (dB)	ANTENNA HEIGHT (m)	TABLE ANGLE (Degree)	RAW VALUE (dBuV)	CORRECTION FACTOR (dB/m)
1	#5584.68	56.7 PK	68.2	-11.5	1.52 H	41	54.20	2.50
2	*5825.00	108.4 PK			1.52 H	41	104.20	4.20
3	*5825.00	98.6 AV			1.52 H	41	94.40	4.20
4	#5983.68	57.9 PK	68.2	-10.3	1.52 H	41	54.60	3.30
5	11650.00	51.8 PK	74.0	-22.2	1.34 H	188	36.80	15.00
6	11650.00	40.1 AV	54.0	-13.9	1.34 H	188	25.10	15.00
7	#17475.00	57.3 PK	74.0	-16.7	1.41 H	231	36.20	21.10
8	#17475.00	44.9 AV	54.0	-9.1	1.41 H	231	23.80	21.10

ANTENNA POLARITY & TEST DISTANCE: VERTICAL AT 3 M

NO.	FREQ. (MHz)	EMISSION LEVEL (dBuV/m)	LIMIT (dBuV/m)	MARGIN (dB)	ANTENNA HEIGHT (m)	TABLE ANGLE (Degree)	RAW VALUE (dBuV)	CORRECTION FACTOR (dB/m)
1	#5583.73	63.3 PK	68.2	-4.9	1.73 V	136	60.80	2.50
2	*5825.00	124.5 PK			1.73 V	136	120.30	4.20
3	*5825.00	114.7 AV			1.73 V	136	110.50	4.20
4	#5983.68	68.0 PK	68.2	-0.2	1.73 V	136	64.70	3.30
5	11650.00	52.3 PK	74.0	-21.7	1.35 V	334	37.30	15.00
6	11650.00	40.2 AV	54.0	-13.8	1.35 V	334	25.20	15.00
7	#17475.00	57.6 PK	74.0	-16.4	1.32 V	288	36.50	21.10
8	#17475.00	45.2 AV	54.0	-8.8	1.32 V	288	24.10	21.10

REMARKS:

1. Emission Level(dBuV/m) = Raw Value(dBuV) + Correction Factor(dB/m)
2. Correction Factor(dB/m) = Antenna Factor(dB/m) + Cable Factor(dB) – Pre-Amplifier Factor(dB)
3. The other emission levels were very low against the limit.
4. Margin value = Emission Level – Limit value
5. " * ": Fundamental frequency.
6. " # ": The radiated frequency is out of the restricted band.

802.11ac (VHT20)

CHANNEL	TX Channel 36	DETECTOR FUNCTION	Peak (PK)
FREQUENCY RANGE	1GHz ~ 40GHz		Average (AV)

ANTENNA POLARITY & TEST DISTANCE: HORIZONTAL AT 3 M

NO.	FREQ. (MHz)	EMISSION LEVEL (dBuV/m)	LIMIT (dBuV/m)	MARGIN (dB)	ANTENNA HEIGHT (m)	TABLE ANGLE (Degree)	RAW VALUE (dBuV)	CORRECTION FACTOR (dB/m)
1	5102.34	47.5 PK	74.0	-26.5	1.52 H	183	44.63	2.87
2	5102.34	36.8 AV	54.0	-17.2	1.52 H	183	33.93	2.87
3	*5180.00	96.3 PK			1.52 H	183	93.24	3.06
4	*5180.00	85.9 AV			1.52 H	183	82.84	3.06
5	5395.00	39.1 PK	74.0	-34.9	1.47 H	169	35.45	3.65
6	5395.00	32.3 AV	54.0	-21.7	1.47 H	169	28.65	3.65
7	#10360.00	50.4 PK	74.0	-23.6	1.29 H	198	36.75	13.65
8	#10360.00	36.6 AV	54.0	-17.4	1.29 H	198	22.95	13.65
9	15540.00	51.5 PK	74.0	-22.5	1.40 H	236	35.82	15.68
10	15540.00	37.6 AV	54.0	-16.4	1.40 H	236	21.92	15.68

ANTENNA POLARITY & TEST DISTANCE: VERTICAL AT 3 M

NO.	FREQ. (MHz)	EMISSION LEVEL (dBuV/m)	LIMIT (dBuV/m)	MARGIN (dB)	ANTENNA HEIGHT (m)	TABLE ANGLE (Degree)	RAW VALUE (dBuV)	CORRECTION FACTOR (dB/m)
1	5102.34	60.7 PK	74.0	-13.3	1.64 V	24	57.83	2.87
2	5102.34	50.0 AV	54.0	-4.0	1.64 V	24	47.13	2.87
3	*5180.00	111.3 PK			1.56 V	235	108.24	3.06
4	*5180.00	100.4 AV			1.56 V	235	97.34	3.06
5	5395.00	52.3 PK	74.0	-21.7	1.92 V	38	48.65	3.65
6	5395.00	45.5 AV	54.0	-8.5	1.92 V	38	41.85	3.65
7	#10360.00	52.1 PK	74.0	-21.9	1.41 V	349	38.45	13.65
8	#10360.00	37.8 AV	54.0	-16.2	1.41 V	349	24.15	13.65
9	15540.00	49.8 PK	74.0	-24.2	1.30 V	276	34.12	15.68
10	15540.00	39.1 AV	54.0	-14.9	1.30 V	276	23.42	15.68

REMARKS:

- Emission Level(dBuV/m) = Raw Value(dBuV) + Correction Factor(dB/m)
- Correction Factor(dB/m) = Antenna Factor(dB/m) + Cable Factor(dB) – Pre-Amplifier Factor(dB)
- The other emission levels were very low against the limit.
- Margin value = Emission Level – Limit value
- " * ": Fundamental frequency.
- " # ": The radiated frequency is out of the restricted band.

CHANNEL	TX Channel 40	DETECTOR FUNCTION	Peak (PK)
FREQUENCY RANGE	1GHz ~ 40GHz		Average (AV)

ANTENNA POLARITY & TEST DISTANCE: HORIZONTAL AT 3 M

NO.	FREQ. (MHz)	EMISSION LEVEL (dBuV/m)	LIMIT (dBuV/m)	MARGIN (dB)	ANTENNA HEIGHT (m)	TABLE ANGLE (Degree)	RAW VALUE (dBuV)	CORRECTION FACTOR (dB/m)
1	5122.00	48.3 PK	74.0	-25.7	1.50 H	186	45.38	2.92
2	5122.00	37.6 AV	54.0	-16.4	1.50 H	186	34.68	2.92
3	*5200.00	97.2 PK			1.50 H	186	94.10	3.10
4	*5200.00	86.6 AV			1.50 H	186	83.50	3.10
5	5357.68	43.6 PK	74.0	-30.4	1.50 H	186	40.06	3.54
6	5357.68	32.3 AV	54.0	-21.7	1.50 H	186	28.76	3.54
7	#10400.00	50.0 PK	74.0	-24.0	1.31 H	210	36.34	13.66
8	#10400.00	36.4 AV	54.0	-17.6	1.31 H	210	22.74	13.66
9	15600.00	51.3 PK	74.0	-22.7	1.35 H	246	35.64	15.66
10	15600.00	37.1 AV	54.0	-16.9	1.35 H	246	21.44	15.66

ANTENNA POLARITY & TEST DISTANCE: VERTICAL AT 3 M

NO.	FREQ. (MHz)	EMISSION LEVEL (dBuV/m)	LIMIT (dBuV/m)	MARGIN (dB)	ANTENNA HEIGHT (m)	TABLE ANGLE (Degree)	RAW VALUE (dBuV)	CORRECTION FACTOR (dB/m)
1	5122.00	61.6 PK	74.0	-12.4	1.70 V	234	58.68	2.92
2	5122.00	50.8 AV	54.0	-3.2	1.70 V	234	47.88	2.92
3	*5200.00	112.2 PK			1.70 V	234	109.10	3.10
4	*5200.00	101.1 AV			1.70 V	234	98.00	3.10
5	5357.68	54.1 PK	74.0	-19.9	1.70 V	234	50.56	3.54
6	5357.68	42.7 AV	54.0	-11.3	1.70 V	234	39.16	3.54
7	#10400.00	52.6 PK	74.0	-21.4	1.40 V	336	38.94	13.66
8	#10400.00	38.1 AV	54.0	-15.9	1.40 V	336	24.44	13.66
9	15600.00	50.1 PK	74.0	-23.9	1.28 V	291	34.44	15.66
10	15600.00	39.2 AV	54.0	-14.8	1.28 V	291	23.54	15.66

REMARKS:

1. Emission Level(dBuV/m) = Raw Value(dBuV) + Correction Factor(dB/m)
2. Correction Factor(dB/m) = Antenna Factor(dB/m) + Cable Factor(dB) – Pre-Amplifier Factor(dB)
3. The other emission levels were very low against the limit.
4. Margin value = Emission Level – Limit value
5. " * ": Fundamental frequency.
6. " # ": The radiated frequency is out of the restricted band.

CHANNEL	TX Channel 48	DETECTOR FUNCTION	Peak (PK)
FREQUENCY RANGE	1GHz ~ 40GHz		Average (AV)

ANTENNA POLARITY & TEST DISTANCE: HORIZONTAL AT 3 M

NO.	FREQ. (MHz)	EMISSION LEVEL (dBuV/m)	LIMIT (dBuV/m)	MARGIN (dB)	ANTENNA HEIGHT (m)	TABLE ANGLE (Degree)	RAW VALUE (dBuV)	CORRECTION FACTOR (dB/m)
1	5085.00	50.4 PK	74.0	-23.6	1.45 H	195	47.57	2.83
2	5085.00	38.7 AV	54.0	-15.3	1.45 H	195	35.87	2.83
3	*5240.00	97.1 PK			1.45 H	195	93.89	3.21
4	*5240.00	86.3 AV			1.45 H	195	83.09	3.21
5	5398.40	44.6 PK	74.0	-29.4	1.45 H	195	40.94	3.66
6	5398.40	33.6 AV	54.0	-20.4	1.45 H	195	29.94	3.66
7	#10480.00	49.6 PK	74.0	-24.4	1.37 H	220	35.59	14.01
8	#10480.00	36.1 AV	54.0	-17.9	1.37 H	220	22.09	14.01
9	15720.00	51.3 PK	74.0	-22.7	1.35 H	246	35.87	15.43
10	15720.00	37.1 AV	54.0	-16.9	1.35 H	246	21.67	15.43

ANTENNA POLARITY & TEST DISTANCE: VERTICAL AT 3 M

NO.	FREQ. (MHz)	EMISSION LEVEL (dBuV/m)	LIMIT (dBuV/m)	MARGIN (dB)	ANTENNA HEIGHT (m)	TABLE ANGLE (Degree)	RAW VALUE (dBuV)	CORRECTION FACTOR (dB/m)
1	5085.00	59.7 PK	74.0	-14.3	1.51 V	30	56.87	2.83
2	5085.00	47.9 AV	54.0	-6.1	1.51 V	30	45.07	2.83
3	*5240.00	112.1 PK			1.50 V	214	108.89	3.21
4	*5240.00	100.8 AV			1.50 V	214	97.59	3.21
5	5398.40	53.9 PK	74.0	-20.1	1.65 V	133	50.24	3.66
6	5398.40	42.8 AV	54.0	-11.2	1.65 V	133	39.14	3.66
7	#10480.00	52.5 PK	74.0	-21.5	1.37 V	339	38.49	14.01
8	#10480.00	37.9 AV	54.0	-16.1	1.37 V	339	23.89	14.01
9	15720.00	50.1 PK	74.0	-23.9	1.27 V	280	34.67	15.43
10	15720.00	39.0 AV	54.0	-15.0	1.27 V	280	23.57	15.43

REMARKS:

1. Emission Level(dBuV/m) = Raw Value(dBuV) + Correction Factor(dB/m)
2. Correction Factor(dB/m) = Antenna Factor(dB/m) + Cable Factor(dB) – Pre-Amplifier Factor(dB)
3. The other emission levels were very low against the limit.
4. Margin value = Emission Level – Limit value
5. " * ": Fundamental frequency.
6. " # ": The radiated frequency is out of the restricted band.

CHANNEL	TX Channel 149	DETECTOR FUNCTION	Peak (PK)
FREQUENCY RANGE	1GHz ~ 40GHz		Average (AV)

ANTENNA POLARITY & TEST DISTANCE: HORIZONTAL AT 3 M								
NO.	FREQ. (MHz)	EMISSION LEVEL (dBuV/m)	LIMIT (dBuV/m)	MARGIN (dB)	ANTENNA HEIGHT (m)	TABLE ANGLE (Degree)	RAW VALUE (dBuV)	CORRECTION FACTOR (dB/m)
1	#5590.85	57.5 PK	68.2	-10.7	1.37 H	65	55.00	2.50
2	*5745.00	108.4 PK			1.37 H	65	104.20	4.20
3	*5745.00	97.8 AV			1.37 H	65	93.60	4.20
4	#5997.45	57.2 PK	68.2	-11.0	1.37 H	65	53.80	3.40
5	11490.00	51.8 PK	74.0	-22.2	1.41 H	228	36.60	15.20
6	11490.00	39.9 AV	54.0	-14.1	1.41 H	228	24.70	15.20
7	#17235.00	57.4 PK	74.0	-16.6	1.33 H	260	37.40	20.00
8	#17235.00	45.2 AV	54.0	-8.8	1.33 H	260	25.20	20.00

ANTENNA POLARITY & TEST DISTANCE: VERTICAL AT 3 M								
NO.	FREQ. (MHz)	EMISSION LEVEL (dBuV/m)	LIMIT (dBuV/m)	MARGIN (dB)	ANTENNA HEIGHT (m)	TABLE ANGLE (Degree)	RAW VALUE (dBuV)	CORRECTION FACTOR (dB/m)
1	#5590.38	67.6 PK	68.2	-0.6	1.73 V	134	27.32	40.26
2	*5745.00	123.1 PK			1.73 V	134	118.90	4.20
3	*5745.00	111.9 AV			1.73 V	134	107.70	4.20
4	#5987.95	62.4 PK	68.2	-5.8	1.73 V	134	21.26	41.11
5	11490.00	52.6 PK	74.0	-21.4	1.41 V	338	37.40	15.20
6	11490.00	40.4 AV	54.0	-13.6	1.41 V	338	25.20	15.20
7	#17235.00	57.2 PK	74.0	-16.8	1.28 V	281	37.20	20.00
8	#17235.00	45.0 AV	54.0	-9.0	1.28 V	281	25.00	20.00

REMARKS:

1. Emission Level(dBuV/m) = Raw Value(dBuV) + Correction Factor(dB/m)
2. Correction Factor(dB/m) = Antenna Factor(dB/m) + Cable Factor(dB) – Pre-Amplifier Factor(dB)
3. The other emission levels were very low against the limit.
4. Margin value = Emission Level – Limit value
5. " * ": Fundamental frequency.
6. " # ": The radiated frequency is out of the restricted band.

CHANNEL	TX Channel 157	DETECTOR FUNCTION	Peak (PK)
FREQUENCY RANGE	1GHz ~ 40GHz		Average (AV)

ANTENNA POLARITY & TEST DISTANCE: HORIZONTAL AT 3 M

NO.	FREQ. (MHz)	EMISSION LEVEL (dBuV/m)	LIMIT (dBuV/m)	MARGIN (dB)	ANTENNA HEIGHT (m)	TABLE ANGLE (Degree)	RAW VALUE (dBuV)	CORRECTION FACTOR (dB/m)
1	#5626.48	58.4 PK	68.2	-9.8	1.34 H	64	55.80	2.60
2	*5785.00	107.8 PK			1.34 H	64	103.70	4.10
3	*5785.00	97.3 AV			1.34 H	64	93.20	4.10
4	#5946.15	58.1 PK	68.2	-10.1	1.34 H	64	55.00	3.10
5	11570.00	51.3 PK	74.0	-22.7	1.37 H	237	36.20	15.10
6	11570.00	39.9 AV	54.0	-14.1	1.37 H	237	24.80	15.10
7	#17355.00	57.3 PK	74.0	-16.7	1.33 H	244	36.80	20.50
8	#17355.00	45.1 AV	54.0	-8.9	1.33 H	244	24.60	20.50

ANTENNA POLARITY & TEST DISTANCE: VERTICAL AT 3 M

NO.	FREQ. (MHz)	EMISSION LEVEL (dBuV/m)	LIMIT (dBuV/m)	MARGIN (dB)	ANTENNA HEIGHT (m)	TABLE ANGLE (Degree)	RAW VALUE (dBuV)	CORRECTION FACTOR (dB/m)
1	#5620.77	67.9 PK	68.2	-0.3	1.75 V	147	65.30	2.60
2	*5785.00	123.2 PK			1.75 V	147	119.10	4.10
3	*5785.00	111.6 AV			1.75 V	147	107.50	4.10
4	#5939.98	66.7 PK	68.2	-1.5	1.75 V	147	63.60	3.10
5	11570.00	52.9 PK	74.0	-21.1	1.47 V	352	37.80	15.10
6	11570.00	40.8 AV	54.0	-13.2	1.47 V	352	25.70	15.10
7	#17355.00	57.2 PK	74.0	-16.8	1.31 V	277	36.70	20.50
8	#17355.00	44.9 AV	54.0	-9.1	1.31 V	277	24.40	20.50

REMARKS:

1. Emission Level(dBuV/m) = Raw Value(dBuV) + Correction Factor(dB/m)
2. Correction Factor(dB/m) = Antenna Factor(dB/m) + Cable Factor(dB) – Pre-Amplifier Factor(dB)
3. The other emission levels were very low against the limit.
4. Margin value = Emission Level – Limit value
5. " * ": Fundamental frequency.
6. " # ": The radiated frequency is out of the restricted band.

CHANNEL	TX Channel 165	DETECTOR FUNCTION	Peak (PK)
FREQUENCY RANGE	1GHz ~ 40GHz		Average (AV)

ANTENNA POLARITY & TEST DISTANCE: HORIZONTAL AT 3 M

NO.	FREQ. (MHz)	EMISSION LEVEL (dBuV/m)	LIMIT (dBuV/m)	MARGIN (dB)	ANTENNA HEIGHT (m)	TABLE ANGLE (Degree)	RAW VALUE (dBuV)	CORRECTION FACTOR (dB/m)
1	#5580.40	56.3 PK	68.2	-11.9	1.25 H	63	53.80	2.50
2	*5825.00	110.4 PK			1.25 H	63	106.20	4.20
3	*5825.00	99.0 AV			1.25 H	63	94.80	4.20
4	#5987.00	57.5 PK	68.2	-10.7	1.25 H	63	54.20	3.30
5	11650.00	51.8 PK	74.0	-22.2	1.32 H	231	36.80	15.00
6	11650.00	40.2 AV	54.0	-13.8	1.32 H	231	25.20	15.00
7	#17475.00	57.6 PK	74.0	-16.4	1.33 H	255	36.50	21.10
8	#17475.00	45.3 AV	54.0	-8.7	1.33 H	255	24.20	21.10

ANTENNA POLARITY & TEST DISTANCE: VERTICAL AT 3 M

NO.	FREQ. (MHz)	EMISSION LEVEL (dBuV/m)	LIMIT (dBuV/m)	MARGIN (dB)	ANTENNA HEIGHT (m)	TABLE ANGLE (Degree)	RAW VALUE (dBuV)	CORRECTION FACTOR (dB/m)
1	#5590.37	62.4 PK	68.2	-5.8	1.66 V	136	59.90	2.50
2	*5825.00	125.2 PK			1.66 V	136	121.00	4.20
3	*5825.00	114.4 AV			1.66 V	136	110.20	4.20
4	#5979.87	67.9 PK	68.2	-0.3	1.66 V	136	64.60	3.30
5	11650.00	52.2 PK	74.0	-21.8	1.39 V	348	37.20	15.00
6	11650.00	40.5 AV	54.0	-13.5	1.39 V	348	25.50	15.00
7	#17475.00	57.0 PK	74.0	-17.0	1.30 V	291	35.90	21.10
8	#17475.00	44.3 AV	54.0	-9.7	1.30 V	291	23.20	21.10

REMARKS:

1. Emission Level(dBuV/m) = Raw Value(dBuV) + Correction Factor(dB/m)
2. Correction Factor(dB/m) = Antenna Factor(dB/m) + Cable Factor(dB) – Pre-Amplifier Factor(dB)
3. The other emission levels were very low against the limit.
4. Margin value = Emission Level – Limit value
5. " * ": Fundamental frequency.
6. " # ": The radiated frequency is out of the restricted band.

802.11ac (VHT40)

CHANNEL	TX Channel 38	DETECTOR FUNCTION	Peak (PK)
FREQUENCY RANGE	1GHz ~ 40GHz		Average (AV)

ANTENNA POLARITY & TEST DISTANCE: HORIZONTAL AT 3 M

NO.	FREQ. (MHz)	EMISSION LEVEL (dBuV/m)	LIMIT (dBuV/m)	MARGIN (dB)	ANTENNA HEIGHT (m)	TABLE ANGLE (Degree)	RAW VALUE (dBuV)	CORRECTION FACTOR (dB/m)
1	5105.30	51.4 PK	74.0	-22.6	1.37 H	171	48.51	2.89
2	5105.30	40.5 AV	54.0	-13.5	1.37 H	171	37.61	2.89
3	5150.00	55.1 PK	74.0	-18.9	1.37 H	171	52.12	2.98
4	5150.00	40.7 AV	54.0	-13.3	1.37 H	171	37.72	2.98
5	*5190.00	92.7 PK			1.37 H	171	89.63	3.07
6	*5190.00	81.6 AV			1.37 H	171	78.53	3.07
7	5352.60	44.5 PK	74.0	-29.5	1.37 H	171	40.97	3.53
8	5352.60	34.2 AV	54.0	-19.8	1.37 H	171	30.67	3.53
9	#10380.00	48.7 PK	74.0	-25.3	1.34 H	242	35.04	13.66
10	#10380.00	36.1 AV	54.0	-17.9	1.34 H	242	22.44	13.66
11	15570.00	52.2 PK	74.0	-21.8	1.32 H	267	36.53	15.67
12	15570.00	38.2 AV	54.0	-15.8	1.32 H	267	22.53	15.67

ANTENNA POLARITY & TEST DISTANCE: VERTICAL AT 3 M

NO.	FREQ. (MHz)	EMISSION LEVEL (dBuV/m)	LIMIT (dBuV/m)	MARGIN (dB)	ANTENNA HEIGHT (m)	TABLE ANGLE (Degree)	RAW VALUE (dBuV)	CORRECTION FACTOR (dB/m)
1	5105.30	57.2 PK	74.0	-16.8	1.02 V	233	54.31	2.89
2	5105.30	46.2 AV	54.0	-7.8	1.02 V	233	43.31	2.89
3	5150.00	60.9 PK	74.0	-13.1	1.02 V	240	57.92	2.98
4	5150.00	46.4 AV	54.0	-7.6	1.02 V	240	43.42	2.98
5	*5190.00	107.7 PK			1.02 V	240	104.63	3.07
6	*5190.00	96.1 AV			1.02 V	240	93.03	3.07
7	5352.60	50.8 PK	74.0	-23.2	1.02 V	240	47.27	3.53
8	5352.60	40.4 AV	54.0	-13.6	1.02 V	240	36.87	3.53
9	#10380.00	52.0 PK	74.0	-22.0	1.42 V	355	38.34	13.66
10	#10380.00	37.8 AV	54.0	-16.2	1.42 V	355	24.14	13.66
11	15570.00	50.6 PK	74.0	-23.4	1.30 V	286	34.93	15.67
12	15570.00	39.7 AV	54.0	-14.3	1.30 V	286	24.03	15.67

REMARKS:

1. Emission Level(dBuV/m) = Raw Value(dBuV) + Correction Factor(dB/m)
2. Correction Factor(dB/m) = Antenna Factor(dB/m) + Cable Factor(dB) – Pre-Amplifier Factor(dB)
3. The other emission levels were very low against the limit.
4. Margin value = Emission Level – Limit value
5. " * ": Fundamental frequency.
6. " # ": The radiated frequency is out of the restricted band.

CHANNEL	TX Channel 46	DETECTOR FUNCTION	Peak (PK)
FREQUENCY RANGE	1GHz ~ 40GHz		Average (AV)

ANTENNA POLARITY & TEST DISTANCE: HORIZONTAL AT 3 M

NO.	FREQ. (MHz)	EMISSION LEVEL (dBuV/m)	LIMIT (dBuV/m)	MARGIN (dB)	ANTENNA HEIGHT (m)	TABLE ANGLE (Degree)	RAW VALUE (dBuV)	CORRECTION FACTOR (dB/m)
1	5147.66	52.5 PK	74.0	-21.5	1.42 H	165	49.52	2.98
2	5147.66	40.7 AV	54.0	-13.3	1.42 H	165	37.72	2.98
3	*5230.00	92.8 PK			1.42 H	170	89.62	3.18
4	*5230.00	82.3 AV			1.42 H	170	79.12	3.18
5	5383.36	46.8 PK	74.0	-27.2	1.42 H	170	43.18	3.62
6	5383.36	34.3 AV	54.0	-19.7	1.42 H	170	30.68	3.62
7	#10460.00	48.9 PK	74.0	-25.1	1.40 H	243	34.98	13.92
8	#10460.00	36.4 AV	54.0	-17.6	1.40 H	243	22.48	13.92
9	15690.00	52.4 PK	74.0	-21.6	1.37 H	255	36.86	15.54
10	15690.00	38.3 AV	54.0	-15.7	1.37 H	255	22.76	15.54

ANTENNA POLARITY & TEST DISTANCE: VERTICAL AT 3 M

NO.	FREQ. (MHz)	EMISSION LEVEL (dBuV/m)	LIMIT (dBuV/m)	MARGIN (dB)	ANTENNA HEIGHT (m)	TABLE ANGLE (Degree)	RAW VALUE (dBuV)	CORRECTION FACTOR (dB/m)
1	5147.66	58.8 PK	74.0	-15.2	1.27 V	238	55.82	2.98
2	5147.66	46.9 AV	54.0	-7.1	1.27 V	238	43.92	2.98
3	*5230.00	107.8 PK			1.27 V	220	104.62	3.18
4	*5230.00	96.8 AV			1.27 V	220	93.62	3.18
5	5383.36	53.1 PK	74.0	-20.9	1.27 V	220	49.48	3.62
6	5383.36	40.6 AV	54.0	-13.4	1.27 V	220	36.98	3.62
7	#10460.00	52.2 PK	74.0	-21.8	1.42 V	360	38.28	13.92
8	#10460.00	38.0 AV	54.0	-16.0	1.42 V	360	24.08	13.92
9	15690.00	50.4 PK	74.0	-23.6	1.30 V	285	34.86	15.54
10	15690.00	39.8 AV	54.0	-14.2	1.30 V	285	24.26	15.54

REMARKS:

1. Emission Level(dBuV/m) = Raw Value(dBuV) + Correction Factor(dB/m)
2. Correction Factor(dB/m) = Antenna Factor(dB/m) + Cable Factor(dB) – Pre-Amplifier Factor(dB)
3. The other emission levels were very low against the limit.
4. Margin value = Emission Level – Limit value
5. " * ": Fundamental frequency.
6. " # ": The radiated frequency is out of the restricted band.

CHANNEL	TX Channel 151	DETECTOR FUNCTION	Peak (PK)
FREQUENCY RANGE	1GHz ~ 40GHz		Average (AV)

ANTENNA POLARITY & TEST DISTANCE: HORIZONTAL AT 3 M								
NO.	FREQ. (MHz)	EMISSION LEVEL (dBuV/m)	LIMIT (dBuV/m)	MARGIN (dB)	ANTENNA HEIGHT (m)	TABLE ANGLE (Degree)	RAW VALUE (dBuV)	CORRECTION FACTOR (dB/m)
1	#5604.15	57.1 PK	68.2	-11.1	1.41 H	65	54.60	2.50
2	*5755.00	107.0 PK			1.41 H	65	102.80	4.20
3	*5755.00	95.2 AV			1.41 H	65	91.00	4.20
4	#5978.45	57.5 PK	68.2	-10.7	1.41 H	65	54.20	3.30
5	11510.00	51.2 PK	74.0	-22.8	1.35 H	245	36.10	15.10
6	11510.00	39.8 AV	54.0	-14.2	1.35 H	245	24.70	15.10
7	#17265.00	57.4 PK	74.0	-16.6	1.37 H	255	37.50	19.90
8	#17265.00	45.2 AV	54.0	-8.8	1.37 H	255	25.30	19.90

ANTENNA POLARITY & TEST DISTANCE: VERTICAL AT 3 M								
NO.	FREQ. (MHz)	EMISSION LEVEL (dBuV/m)	LIMIT (dBuV/m)	MARGIN (dB)	ANTENNA HEIGHT (m)	TABLE ANGLE (Degree)	RAW VALUE (dBuV)	CORRECTION FACTOR (dB/m)
1	#5605.10	67.8 PK	68.2	-0.4	1.56 V	136	65.20	2.60
2	*5755.00	120.9 PK			1.56 V	136	116.70	4.20
3	*5755.00	109.5 AV			1.56 V	136	105.30	4.20
4	#5930.48	66.3 PK	68.2	-1.9	1.56 V	136	63.20	3.10
5	11510.00	52.7 PK	74.0	-21.3	1.38 V	349	37.60	15.10
6	11510.00	40.8 AV	54.0	-13.2	1.38 V	349	25.70	15.10
7	#17265.00	57.7 PK	74.0	-16.3	1.34 V	298	37.80	19.90
8	#17265.00	45.2 AV	54.0	-8.8	1.34 V	298	25.30	19.90

REMARKS:

1. Emission Level(dBuV/m) = Raw Value(dBuV) + Correction Factor(dB/m)
2. Correction Factor(dB/m) = Antenna Factor(dB/m) + Cable Factor(dB) – Pre-Amplifier Factor(dB)
3. The other emission levels were very low against the limit.
4. Margin value = Emission Level – Limit value
5. " * ": Fundamental frequency.
6. " # ": The radiated frequency is out of the restricted band.

CHANNEL	TX Channel 159	DETECTOR FUNCTION	Peak (PK)
FREQUENCY RANGE	1GHz ~ 40GHz		Average (AV)

ANTENNA POLARITY & TEST DISTANCE: HORIZONTAL AT 3 M

NO.	FREQ. (MHz)	EMISSION LEVEL (dBuV/m)	LIMIT (dBuV/m)	MARGIN (dB)	ANTENNA HEIGHT (m)	TABLE ANGLE (Degree)	RAW VALUE (dBuV)	CORRECTION FACTOR (dB/m)
1	#5617.45	57.1 PK	68.2	-11.1	1.37 H	61	54.50	2.60
2	*5795.00	106.9 PK			1.37 H	61	102.80	4.10
3	*5795.00	95.3 AV			1.37 H	61	91.20	4.10
4	#5953.27	57.3 PK	68.2	-10.9	1.37 H	61	54.10	3.20
5	11590.00	51.7 PK	74.0	-22.3	1.40 H	240	36.60	15.10
6	11590.00	40.0 AV	54.0	-14.0	1.40 H	240	24.90	15.10
7	#17385.00	57.2 PK	74.0	-16.8	1.33 H	262	36.60	20.60
8	#17385.00	45.2 AV	54.0	-8.8	1.33 H	262	24.60	20.60

ANTENNA POLARITY & TEST DISTANCE: VERTICAL AT 3 M

NO.	FREQ. (MHz)	EMISSION LEVEL (dBuV/m)	LIMIT (dBuV/m)	MARGIN (dB)	ANTENNA HEIGHT (m)	TABLE ANGLE (Degree)	RAW VALUE (dBuV)	CORRECTION FACTOR (dB/m)
1	#5630.27	67.1 PK	68.2	-1.1	1.72 V	138	64.50	2.60
2	*5795.00	121.0 PK			1.72 V	138	116.90	4.10
3	*5795.00	109.7 AV			1.72 V	138	105.60	4.10
4	#5939.98	67.1 PK	68.2	-1.1	1.72 V	138	64.00	3.10
5	11590.00	52.6 PK	74.0	-21.4	1.39 V	335	37.50	15.10
6	11590.00	40.8 AV	54.0	-13.2	1.39 V	335	25.70	15.10
7	#17385.00	57.9 PK	74.0	-16.1	1.32 V	289	37.30	20.60
8	#17385.00	45.1 AV	54.0	-8.9	1.32 V	289	24.50	20.60

REMARKS:

1. Emission Level(dBuV/m) = Raw Value(dBuV) + Correction Factor(dB/m)
2. Correction Factor(dB/m) = Antenna Factor(dB/m) + Cable Factor(dB) – Pre-Amplifier Factor(dB)
3. The other emission levels were very low against the limit.
4. Margin value = Emission Level – Limit value
5. " * ": Fundamental frequency.
6. " # ": The radiated frequency is out of the restricted band.

802.11ac (VHT80)

CHANNEL	TX Channel 42	DETECTOR FUNCTION	Peak (PK)
FREQUENCY RANGE	1GHz ~ 40GHz		Average (AV)

ANTENNA POLARITY & TEST DISTANCE: HORIZONTAL AT 3 M

NO.	FREQ. (MHz)	EMISSION LEVEL (dBuV/m)	LIMIT (dBuV/m)	MARGIN (dB)	ANTENNA HEIGHT (m)	TABLE ANGLE (Degree)	RAW VALUE (dBuV)	CORRECTION FACTOR (dB/m)
1	5150.00	52.2 PK	74.0	-21.8	1.32 H	173	49.22	2.98
2	5150.00	40.6 AV	54.0	-13.4	1.32 H	173	37.62	2.98
3	*5210.00	95.2 PK			1.32 H	173	92.08	3.12
4	*5210.00	83.5 AV			1.32 H	173	80.38	3.12
5	5350.00	43.1 PK	74.0	-30.9	1.32 H	173	39.59	3.51
6	5350.00	30.0 AV	54.0	-24.0	1.32 H	173	26.49	3.51
7	#10420.00	49.1 PK	74.0	-24.9	1.41 H	229	35.34	13.76
8	#10420.00	36.4 AV	54.0	-17.6	1.41 H	229	22.64	13.76
9	15630.00	51.9 PK	74.0	-22.1	1.36 H	264	36.28	15.62
10	15630.00	38.0 AV	54.0	-16.0	1.36 H	264	22.38	15.62

ANTENNA POLARITY & TEST DISTANCE: VERTICAL AT 3 M

NO.	FREQ. (MHz)	EMISSION LEVEL (dBuV/m)	LIMIT (dBuV/m)	MARGIN (dB)	ANTENNA HEIGHT (m)	TABLE ANGLE (Degree)	RAW VALUE (dBuV)	CORRECTION FACTOR (dB/m)
1	5150.00	60.0 PK	74.0	-14.0	1.02 V	238	57.02	2.98
2	5150.00	48.3 AV	54.0	-5.7	1.02 V	238	45.32	2.98
3	*5210.00	104.7 PK			1.02 V	238	101.58	3.12
4	*5210.00	92.5 AV			1.02 V	238	89.38	3.12
5	5350.00	56.4 PK	74.0	-17.6	1.02 V	238	52.89	3.51
6	5350.00	43.2 AV	54.0	-10.8	1.02 V	238	39.69	3.51
7	#10420.00	52.1 PK	74.0	-21.9	1.34 V	345	38.34	13.76
8	#10420.00	37.3 AV	54.0	-16.7	1.34 V	345	23.54	13.76
9	15630.00	50.7 PK	74.0	-23.3	1.35 V	280	35.08	15.62
10	15630.00	39.6 AV	54.0	-14.4	1.35 V	280	23.98	15.62

REMARKS:

- Emission Level(dBuV/m) = Raw Value(dBuV) + Correction Factor(dB/m)
- Correction Factor(dB/m) = Antenna Factor(dB/m) + Cable Factor(dB) – Pre-Amplifier Factor(dB)
- The other emission levels were very low against the limit.
- Margin value = Emission Level – Limit value
- " * ": Fundamental frequency.
- " # ": The radiated frequency is out of the restricted band.

CHANNEL	TX Channel 155	DETECTOR FUNCTION	Peak (PK)
FREQUENCY RANGE	1GHz ~ 40GHz		Average (AV)

ANTENNA POLARITY & TEST DISTANCE: HORIZONTAL AT 3 M								
NO.	FREQ. (MHz)	EMISSION LEVEL (dBuV/m)	LIMIT (dBuV/m)	MARGIN (dB)	ANTENNA HEIGHT (m)	TABLE ANGLE (Degree)	RAW VALUE (dBuV)	CORRECTION FACTOR (dB/m)
1	#5611.75	58.3 PK	68.2	-9.9	1.42 H	66	55.70	2.60
2	*5775.00	101.4 PK			1.42 H	66	97.20	4.20
3	*5775.00	89.3 AV			1.42 H	66	85.10	4.20
4	#5940.45	59.0 PK	68.2	-9.2	1.42 H	66	55.90	3.10
5	11550.00	51.3 PK	74.0	-22.7	1.39 H	237	36.10	15.20
6	11550.00	39.9 AV	54.0	-14.1	1.39 H	237	24.70	15.20
7	#17325.00	57.5 PK	74.0	-16.5	1.40 H	278	37.20	20.30
8	#17325.00	45.2 AV	54.0	-8.8	1.40 H	278	24.90	20.30

ANTENNA POLARITY & TEST DISTANCE: VERTICAL AT 3 M								
NO.	FREQ. (MHz)	EMISSION LEVEL (dBuV/m)	LIMIT (dBuV/m)	MARGIN (dB)	ANTENNA HEIGHT (m)	TABLE ANGLE (Degree)	RAW VALUE (dBuV)	CORRECTION FACTOR (dB/m)
1	#5586.10	68.1 PK	68.2	-0.1	1.85 V	139	65.60	2.50
2	*5775.00	116.3 PK			1.85 V	139	112.10	4.20
3	*5775.00	104.3 AV			1.85 V	139	100.10	4.20
4	#5960.40	66.8 PK	68.2	-1.4	1.85 V	139	63.60	3.20
5	11550.00	53.1 PK	74.0	-20.9	1.38 V	333	37.90	15.20
6	11550.00	41.0 AV	54.0	-13.0	1.38 V	333	25.80	15.20
7	#17325.00	56.7 PK	74.0	-17.3	1.40 V	274	36.40	20.30
8	#17325.00	44.4 AV	54.0	-9.6	1.40 V	274	24.10	20.30

REMARKS:

1. Emission Level(dBuV/m) = Raw Value(dBuV) + Correction Factor(dB/m)
2. Correction Factor(dB/m) = Antenna Factor(dB/m) + Cable Factor(dB) – Pre-Amplifier Factor(dB)
3. The other emission levels were very low against the limit.
4. Margin value = Emission Level – Limit value
5. " * ": Fundamental frequency.
6. " # ": The radiated frequency is out of the restricted band.

Below 1GHz Data:

802.11ac (VHT40)

CHANNEL	TX Channel 159	DETECTOR FUNCTION	Quasi-Peak (QP)
FREQUENCY RANGE	below 1GHz		

ANTENNA POLARITY & TEST DISTANCE: HORIZONTAL AT 3 M

NO.	FREQ. (MHz)	EMISSION LEVEL (dBuV/m)	LIMIT (dBuV/m)	MARGIN (dB)	ANTENNA HEIGHT (m)	TABLE ANGLE (Degree)	RAW VALUE (dBuV)	CORRECTION FACTOR (dB/m)
1	72.22	33.2 QP	40.0	-6.8	1.50 H	30	34.75	-1.53
2	170.77	34.4 QP	43.5	-9.1	1.50 H	96	33.91	0.51
3	264.01	36.7 QP	46.0	-9.3	1.00 H	297	36.23	0.43
4	461.97	34.1 QP	46.0	-11.9	2.00 H	17	28.27	5.81
5	818.66	36.9 QP	46.0	-9.1	1.00 H	203	24.85	12.05
6	923.64	37.7 QP	46.0	-8.3	1.00 H	36	23.78	13.95

ANTENNA POLARITY & TEST DISTANCE: VERTICAL AT 3 M

NO.	FREQ. (MHz)	EMISSION LEVEL (dBuV/m)	LIMIT (dBuV/m)	MARGIN (dB)	ANTENNA HEIGHT (m)	TABLE ANGLE (Degree)	RAW VALUE (dBuV)	CORRECTION FACTOR (dB/m)
1	37.78	35.9 QP	40.0	-4.1	1.03 V	360	35.75	0.14
2	93.07	34.5 QP	43.5	-9.0	2.00 V	0	38.94	-4.46
3	250.00	30.3 QP	46.0	-15.7	2.00 V	112	30.46	-0.17
4	395.98	35.6 QP	46.0	-10.4	1.50 V	360	31.57	4.01
5	461.99	38.7 QP	46.0	-7.3	1.00 V	72	32.93	5.81
6	999.98	40.5 QP	54.0	-13.5	1.00 V	254	25.80	14.68

REMARKS:

1. Emission Level(dBuV/m) = Raw Value(dBuV) + Correction Factor(dB/m)
2. Correction Factor(dB/m) = Antenna Factor(dB/m) + Cable Factor(dB) – Pre-Amplifier Factor(dB)
3. The other emission levels were very low against the limit.
4. Margin value = Emission Level – Limit value

4.2 Conducted Emission Measurement

4.2.1 Limits of Conducted Emission Measurement

Frequency (MHz)	Conducted Limit (dBuV)	
	Quasi-peak	Average
0.15 - 0.5	66 - 56	56 - 46
0.50 - 5.0	56	46
5.0 - 30.0	60	50

Note: 1. The lower limit shall apply at the transition frequencies.

2. The limit decreases in line with the logarithm of the frequency in the range of 0.15 to 0.50MHz.

4.2.2 Test Instruments

DESCRIPTION & MANUFACTURER	MODEL NO.	SERIAL NO.	CALIBRATED DATE	CALIBRATED UNTIL
Test Receiver R&S	ESCS 30	100287	Apr. 17, 2015	Apr. 16, 2016
Line-Impedance Stabilization Network (for EUT) SCHWARZBECK	NSLK-8127	8127-523	Oct. 02, 2015	Oct. 01, 2016
Line-Impedance Stabilization Network (for Peripheral) R&S	ENV216	100071	Nov. 11, 2015	Nov. 10, 2016
RF Cable	5D-FB	COACAB-001	May 25, 2015	May 24, 2016
50 ohms Terminator	50	3	Oct. 21, 2015	Oct. 20, 2016
50 ohms Terminator	N/A	EMC-04	Oct. 28, 2015	Oct. 27, 2016
Software BVADT	BVADT_Cond_ V7.3.7.3	NA	NA	NA

Note:

1. The calibration interval of the above test instruments are 12 months and the calibrations are traceable to NML/ROC and NIST/USA.
2. The test was performed in Shielded Room No. A.
3. The VCCI Con A Registration No. is C-817.
4. Tested Date: Mar. 30, 2016

4.2.3 Test Procedure

- The EUT was placed 0.4 meters from the conducting wall of the shielded room with EUT being connected to the power mains through a line impedance stabilization network (LISN). Other support units were connected to the power mains through another LISN. The two LISNs provide 50 ohm/ 50uH of coupling impedance for the measuring instrument.
- Both lines of the power mains connected to the EUT were checked for maximum conducted interference.
- The frequency range from 150kHz to 30MHz was searched. Emission levels under (Limit - 20dB) was not recorded.

NOTE: All modes of operation were investigated and the worst-case emissions are reported.

4.2.4 Deviation from Test Standard

No deviation.

4.2.5 Test Setup

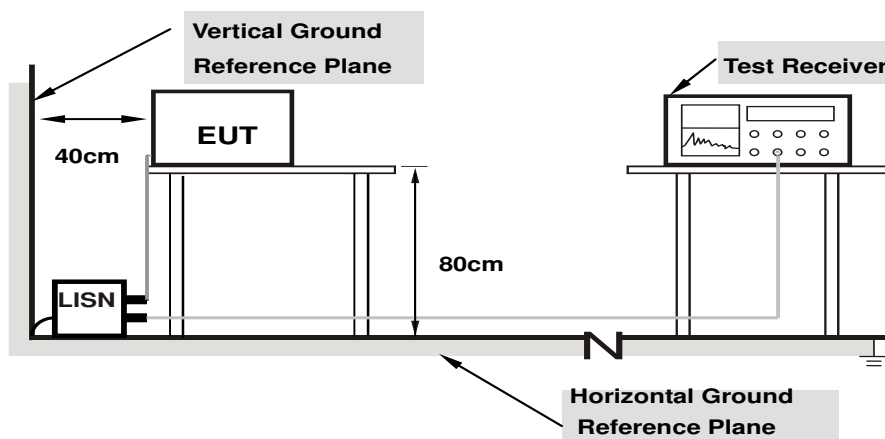

Note: 1.Support units were connected to second LISN.

For the actual test configuration, please refer to the attached file (Test Setup Photo).

4.2.6 EUT Operating Condition

Same as 4.1.6.

4.2.7 Test Results

Phase	Line (L)	Detector Function	Quasi-Peak (QP) / Average (AV)
-------	----------	-------------------	--------------------------------

No	Freq. [MHz]	Corr.	Reading Value		Emission Level		Limit		Margin	
		Factor (dB)	[dB (uV)]		[dB (uV)]		[dB (uV)]		(dB)	
	Q.P.	AV.	Q.P.	AV.	Q.P.	AV.	Q.P.	AV.	Q.P.	AV.
1	0.20859	10.23	34.09	23.07	44.32	33.30	63.26	53.26	-18.94	-19.96
2	2.05969	10.32	28.14	9.83	38.46	20.15	56.00	46.00	-17.54	-25.85
3	2.37109	10.34	29.31	13.30	39.65	23.64	56.00	46.00	-16.35	-22.36
4	3.29688	10.43	26.78	18.75	37.21	29.18	56.00	46.00	-18.79	-16.82
5	4.10547	10.49	25.22	16.38	35.71	26.87	56.00	46.00	-20.29	-19.13
6	12.07813	10.72	33.03	32.37	43.75	43.09	60.00	50.00	-16.25	-6.91
7	14.25391	10.83	37.34	37.22	48.17	48.05	60.00	50.00	-11.83	-1.95

REMARKS:

1. Q.P. and AV. are abbreviations of quasi-peak and average individually.
2. The emission levels of other frequencies were very low against the limit.
3. Margin value = Emission level - Limit value
4. Correction factor = Insertion loss + Cable loss
5. Emission Level = Correction Factor + Reading Value.

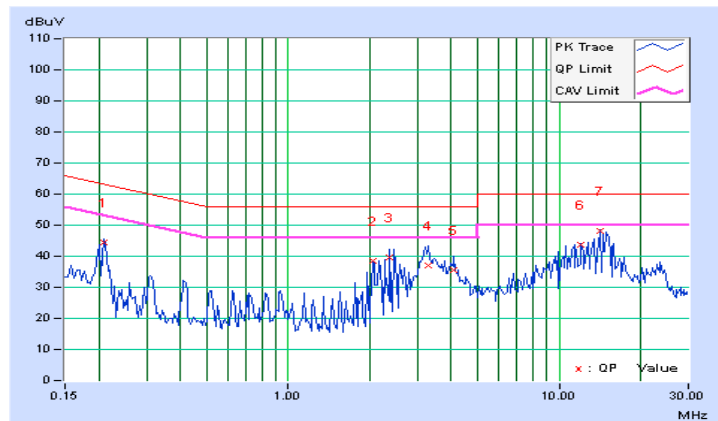

Phase	Neutral (N)	Detector Function	Quasi-Peak (QP) / Average (AV)
-------	-------------	-------------------	--------------------------------

No	Freq. [MHz]	Corr. Factor	Reading Value [dB (uV)]		Emission Level [dB (uV)]		Limit [dB (uV)]		Margin (dB)	
		(dB)	Q.P.	AV.	Q.P.	AV.	Q.P.	AV.	Q.P.	AV.
	1	0.20859	10.31	36.49	25.02	46.80	35.33	63.26	53.26	-16.46
2	2.48047	10.43	32.41	18.11	42.84	28.54	56.00	46.00	-13.16	-17.46
3	3.18750	10.49	30.00	21.26	40.49	31.75	56.00	46.00	-15.51	-14.25
4	4.04297	10.55	26.86	18.34	37.41	28.89	56.00	46.00	-18.59	-17.11
5	10.62891	10.67	34.39	34.14	45.06	44.81	60.00	50.00	-14.94	-5.19
6	12.56250	10.76	31.56	29.89	42.32	40.65	60.00	50.00	-17.68	-9.35
7	14.25391	10.84	37.96	37.88	48.80	48.72	60.00	50.00	-11.20	-1.28

REMARKS:

1. Q.P. and AV. are abbreviations of quasi-peak and average individually.
2. The emission levels of other frequencies were very low against the limit.
3. Margin value = Emission level - Limit value
4. Correction factor = Insertion loss + Cable loss
5. Emission Level = Correction Factor + Reading Value.

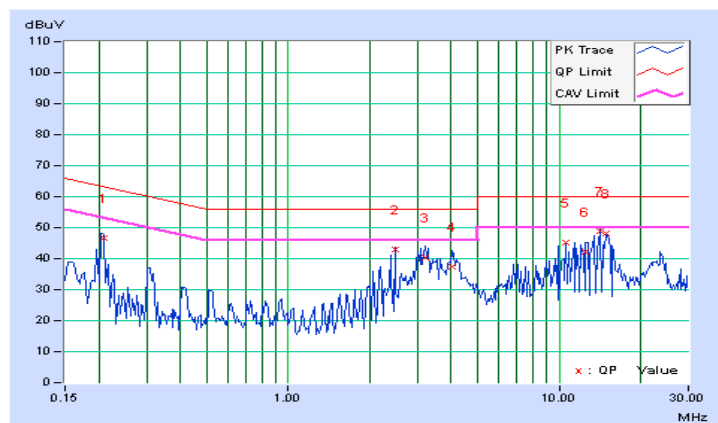

4.3 Transmit Power Measurement

4.3.1 Limits of Transmit Power Measurement

Operation Band	EUT Category		Limit
U-NII-1	√	Outdoor Access Point	1 Watt (30 dBm) (Max. e.i.r.p \leq 125mW(21 dBm) at any elevation angle above 30 degrees as measured from the horizon)
		Fixed point-to-point Access Point	1 Watt (30 dBm)
		Indoor Access Point	1 Watt (30 dBm)
		Mobile and Portable client device	250mW (24 dBm)
U-NII-2A			250mW (24 dBm) or 11 dBm+10 log B*
U-NII-2C			250mW (24 dBm) or 11 dBm+10 log B*
U-NII-3	√		1 Watt (30 dBm)

*B is the 26 dB emission bandwidth in megahertz

Per KDB 662911 Method of conducted output power measurement on IEEE 802.11 devices,

Array Gain = 0 dB (i.e., no array gain) for $N_{ANT} \leq 4$;

Array Gain = 0 dB (i.e., no array gain) for channel widths ≥ 40 MHz for any N_{ANT} ;

Array Gain = $5 \log(N_{ANT}/N_{SS})$ dB or 3 dB, whichever is less for 20-MHz channel widths with $N_{ANT} \geq 5$.

For power measurements on all other devices: Array Gain = $10 \log(N_{ANT}/N_{SS})$ dB.

4.3.2 Test Setup

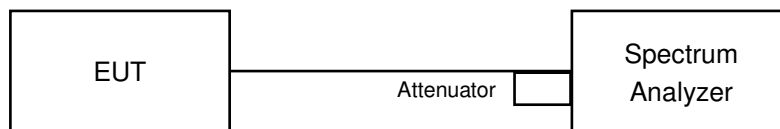

4.3.3 Test Instruments

Refer to section 4.1.2 to get information of above instrument.

4.3.4 Test Procedure

Method PM is used to perform output power measurement, trigger and gating function of wide band power meter is enabled to measure max output power of TX on burst. Duty factor is not added to measured value.

4.3.5 Deviation from Test Standard

No deviation.

4.3.6 EUT Operating Condition

The software provided by client to enable the EUT under transmission condition continuously at lowest, middle and highest channel frequencies individually.

4.3.7 Test Result

802.11a

Chan.	Chan. Freq. (MHz)	Maximum Conducted Power (dBm)			Total Power (mW)	Total Power (dBm)	Limit (dBm)	Pass / Fail
		Chain 0	Chain 1	Chain 2				
36	5180	10.25	10.18	10.19	31.463	14.98	30	Pass
40	5200	10.04	10.29	10.06	30.923	14.90	30	Pass
48	5240	9.95	10.16	10.32	31.026	14.92	30	Pass
149	5745	20.16	19.49	20.08	294.532	24.69	30	Pass
157	5785	20.88	19.93	20.55	334.364	25.24	30	Pass
165	5825	21.77	20.74	21.26	402.551	26.05	30	Pass

EIRP POWER OUTPUT

Chan.	Chan. Freq. (MHz)	EIRP Power (mW)	EIRP Power (dBm)	Power Limit (dBm)	Pass / Fail
36	5180	125.256	20.98	21	Pass
40	5200	123.107	20.90	21	Pass
48	5240	123.517	20.92	21	Pass

*This device is outdoor access point and antenna at any elevation angle above 30 degrees as measured from the horizon, therefore Max. e.i.r.p \leq 125mW(21 dBm) to compliance.

802.11ac (VHT20)

Chan.	Chan. Freq. (MHz)	Maximum Conducted Power (dBm)			Total Power (mW)	Total Power (dBm)	Limit (dBm)	Pass / Fail
		Chain 0	Chain 1	Chain 2				
36	5180	10.16	10.28	10.16	31.416	14.97	30	Pass
40	5200	10.04	10.30	10.11	31.065	14.92	30	Pass
48	5240	9.79	10.95	9.70	31.306	14.96	30	Pass
149	5745	21.45	20.56	21.05	380.75	25.81	30	Pass
157	5785	21.80	20.60	21.21	398.301	26.00	30	Pass
165	5825	23.58	22.76	22.97	614.986	27.89	30	Pass

EIRP POWER OUTPUT

Chan.	Chan. Freq. (MHz)	EIRP Power (mW)	EIRP Power (dBm)	Power Limit (dBm)	Pass / Fail
36	5180	125.069	20.97	21	Pass
40	5200	123.672	20.92	21	Pass
48	5240	124.631	20.96	21	Pass

*This device is outdoor access point and antenna at any elevation angle above 30 degrees as measured from the horizon, therefore Max. e.i.r.p \leq 125mW(21 dBm) to compliance.

802.11ac (VHT40)

Chan.	Chan. Freq. (MHz)	Maximum Conducted Power (dBm)			Total Power (mW)	Total Power (dBm)	Limit (dBm)	Pass / Fail
		Chain 0	Chain 1	Chain 2				
38	5190	9.99	10.32	9.78	30.248	14.81	30	Pass
46	5230	9.59	10.63	9.61	29.801	14.74	30	Pass
151	5755	24.46	23.44	23.52	724.959	28.60	30	Pass
159	5795	25.29	24.47	23.81	858.399	29.34	30	Pass

EIRP POWER OUTPUT

Chan.	Chan. Freq. (MHz)	EIRP Power (mW)	EIRP Power (dBm)	Power Limit (dBm)	Pass / Fail
38	5190	120.419	20.81	21	Pass
46	5230	118.640	20.74	21	Pass

*This device is outdoor access point and antenna at any elevation angle above 30 degrees as measured from the horizon, therefore Max. e.i.r.p \leq 125mW(21 dBm) to compliance.

802.11ac (VHT80)

Chan.	Chan. Freq. (MHz)	Maximum Conducted Power (dBm)			Total Power (mW)	Total Power (dBm)	Limit (dBm)	Pass / Fail
		Chain 0	Chain 1	Chain 2				
42	5210	9.91	10.52	10.18	31.49	14.98	30	Pass
155	5775	20.54	19.93	20.09	313.735	24.97	30	Pass

EIRP POWER OUTPUT

Chan.	Chan. Freq. (MHz)	EIRP Power (mW)	EIRP Power (dBm)	Power Limit (dBm)	Pass / Fail
42	5210	125.364	20.98	21	Pass

*This device is outdoor access point and antenna at any elevation angle above 30 degrees as measured from the horizon, therefore Max. e.i.r.p \leq 125mW(21 dBm) to compliance.

4.4 Peak Power Spectral Density Measurement

4.4.1 Limits of Peak Power Spectral Density Measurement

Operation Band	EUT Category		Limit
U-NII-1	√	Outdoor Access Point	17dBm/ MHz
		Fixed point-to-point Access Point	
		Indoor Access Point	
		Mobile and Portable client device	11dBm/ MHz
U-NII-2A			11dBm/ MHz
U-NII-2C			11dBm/ MHz
U-NII-3		√	30dBm/ 500kHz

4.4.2 Test Setup

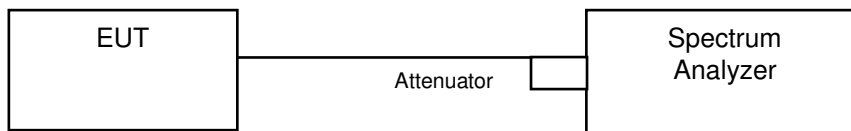

4.4.3 Test Instruments

Refer to section 4.1.2 to get information of above instrument.

4.4.4 Test Procedure

802.11a, 802.11ac (VHT20)

For U-NII-1:

Using method SA-1

1. Set span to encompass the entire emission bandwidth (EBW) of the signal.
2. Set RBW = 1 MHz, Set VBW \geq 3 MHz, Detector = RMS
3. Sweep time = auto, trigger set to "free run".
4. Trace average at least 100 traces in power averaging mode.
5. Record the max value

For U-NII-3:

1. Set span to encompass the entire emission bandwidth (EBW) of the signal.
2. Set RBW = 300 kHz, Set VBW \geq 1 MHz, Detector = RMS
3. Use the peak marker function to determine the maximum power level in any 300 kHz band segment within the fundamental EBW.
4. Scale the observed power level to an equivalent value in 500 kHz by adjusting (reducing) the measured power by a bandwidth correction factor (BWCF) where $BWCF = 10\log(500 \text{ kHz}/300\text{kHz})$
5. Sweep time = auto, trigger set to "free run".
6. Trace average at least 100 traces in power averaging mode.
7. Record the max value

802.11ac (VHT40), 802.11ac (VHT80)

For U-NII-1:

Using method SA-2

1. Set span to encompass the entire emission bandwidth (EBW) of the signal.
2. Set RBW = 1 MHz, Set VBW \geq 3 MHz, Detector = RMS
3. Sweep time = auto, trigger set to "free run".
4. Trace average at least 100 traces in power averaging mode.
5. Record the max value and add $10 \log (1/\text{duty cycle})$

For U-NII-3:

1. Set span to encompass the entire emission bandwidth (EBW) of the signal.
2. Set RBW = 300 kHz, Set VBW \geq 1 MHz, Detector = RMS
3. Use the peak marker function to determine the maximum power level in any 300 kHz band segment within the fundamental EBW.
4. Scale the observed power level to an equivalent value in 500 kHz by adjusting (reducing) the measured power by a bandwidth correction factor (BWCF) where $BWCF = 10\log(500 \text{ kHz}/300\text{kHz})$
5. Sweep time = auto, trigger set to "free run".
6. Trace average at least 100 traces in power averaging mode.
7. Record the max value and add $10 \log (1/\text{duty cycle})$

4.4.5 Deviation from Test Standard

No deviation.

4.4.6 EUT Operating Condition

Same as Item 4.3.6.

4.4.7 Test Results

For U-NII-1:

802.11a

Chan.	Chan. Freq. (MHz)	PSD (dBm/MHz)			Total Power Density (dBm/MHz)	MAX. Limit (dBm/MHz)	Pass / Fail
		Chain 0	Chain 1	Chain 2			
36	5180	-3.23	-1.96	-3.64	1.89	12.39	Pass
40	5200	-2.11	-2.73	-5.28	1.60	12.39	Pass
48	5240	-3.03	-3.15	-4.04	1.39	12.39	Pass

- Note:** 1. Method a) of power density measurement of KDB 662911 is using for calculating total power density. Total power density is summing entire spectra across corresponding frequency bins on the various outputs by computer.
2. Directional gain = $10 \log[(10^{G1/20} + 10^{G2/20} + 10^{G3/20})^2 / 3] = 10.61 \text{ dBi} > 6 \text{ dBi}$, so the power density limit shall be reduced to $17 - (10.61 - 6) = 12.39 \text{ dBm}$.

802.11ac (VHT20)

Chan.	Chan. Freq. (MHz)	PSD (dBm/MHz)			Total Power Density (dBm/MHz)	MAX. Limit (dBm/MHz)	Pass / Fail
		Chain 0	Chain 1	Chain 2			
36	5180	-3.82	-3.29	-2.23	1.71	12.39	Pass
40	5200	-3.73	-3.20	-2.42	1.69	12.39	Pass
48	5240	-3.06	-3.76	-2.93	1.54	12.39	Pass

- Note:** 1. Method a) of power density measurement of KDB 662911 is using for calculating total power density. Total power density is summing entire spectra across corresponding frequency bins on the various outputs by computer.
2. Directional gain = $10 \log[(10^{G1/20} + 10^{G2/20} + 10^{G3/20})^2 / 3] = 10.61 \text{ dBi} > 6 \text{ dBi}$, so the power density limit shall be reduced to $17 - (10.61 - 6) = 12.39 \text{ dBm}$.

802.11ac (VHT40)

Chan.	Chan. Freq. (MHz)	PSD W/O Duty Factor (dBm)			Duty Factor (dB)	Total PSD With Duty Factor (dBm)	MAX. Limit (dBm/MHz)	Pass / Fail
		Chain 0	Chain 1	Chain 2				
38	5190	-6.71	-6.05	-6.81	0.11	-1.63	12.39	Pass
46	5230	-7.13	-5.92	-6.05	0.11	-1.45	12.39	Pass

- Note:** 1. Method a) of power density measurement of KDB 662911 is using for calculating total power density. Total power density is summing entire spectra across corresponding frequency bins on the various outputs by computer.
2. Directional gain = $10 \log[(10^{G1/20} + 10^{G2/20} + 10^{G3/20})^2 / 3] = 10.61 \text{ dBi} > 6 \text{ dBi}$, so the power density limit shall be reduced to $17 - (10.61 - 6) = 12.39 \text{ dBm}$.
3. Refer to section 3.3 for duty cycle spectrum plot.

802.11ac (VHT80)

Chan.	Chan. Freq. (MHz)	PSD W/O Duty Factor (dBm)			Duty Factor (dB)	Total PSD With Duty Factor (dBm)	MAX. Limit (dBm/MHz)	Pass / Fail
		Chain 0	Chain 1	Chain 2				
42	5210	-10.53	-9.46	-9.22	0.23	-4.70	12.39	Pass

- Note:**
- Method a) of power density measurement of KDB 662911 is using for calculating total power density. Total power density is summing entire spectra across corresponding frequency bins on the various outputs by computer.
 - Directional gain = $10 \log[(10^{G1/20} + 10^{G2/20} + 10^{G3/20})^2 / 3] = 10.61 \text{dBi} > 6 \text{dBi}$, so the power density limit shall be reduced to $17 - (10.61 - 6) = 12.39 \text{dBm}$.
 - Refer to section 3.3 for duty cycle spectrum plot.

Spectrum Plot of Worst Value

802.11a_Chain 1 / CH36

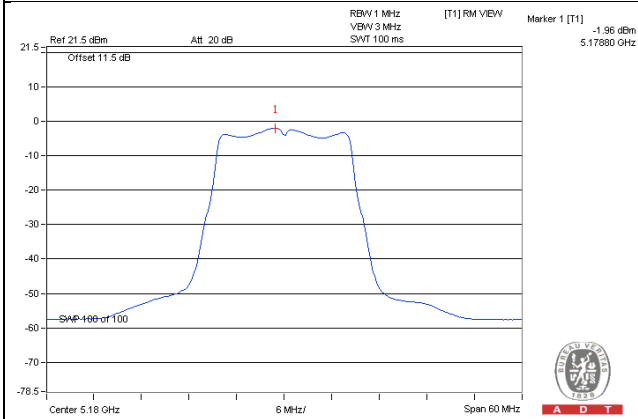

802.11ac (VHT20)_Chain 2 / CH36

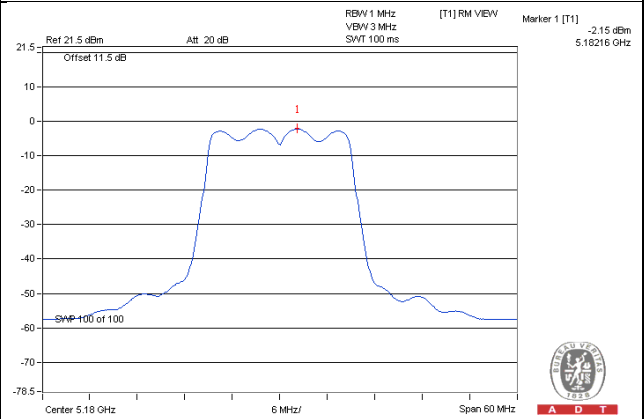

802.11ac (VHT40)_Chain 1 / CH46

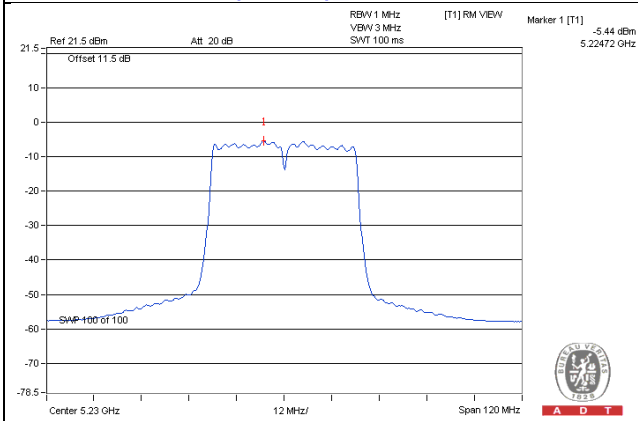

802.11ac (VHT80)_Chain 2 / CH42

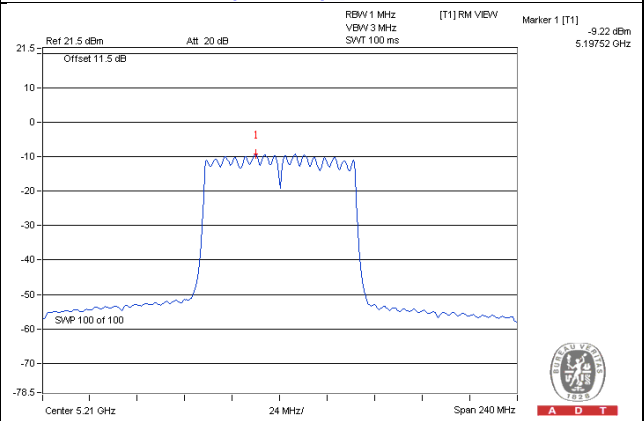

For U-NII-3:

802.11a

TX chain	Channel	Freq. (MHz)	PSD (dBm/300kHz)	PSD (dBm/500kHz)	10 log (N=2) dB	Total PSD (dBm/500kHz)	Limit (dBm/500kHz)	Pass /Fail
0	149	5745	1.75	3.97	4.77	8.74	25.56	Pass
	157	5785	2.49	4.71	4.77	9.48	25.56	Pass
	165	5825	3.44	5.66	4.77	10.43	25.56	Pass
1	149	5745	0.10	2.32	4.77	7.09	25.56	Pass
	157	5785	0.43	2.65	4.77	7.42	25.56	Pass
	165	5825	1.09	3.31	4.77	8.08	25.56	Pass
2	149	5745	1.18	3.40	4.77	8.17	25.56	Pass
	157	5785	1.23	3.45	4.77	8.22	25.56	Pass
	165	5825	1.41	3.63	4.77	8.40	25.56	Pass

Note: 1. Directional gain = $10 \log[(10^{G1/20} + 10^{G2/20} + 10^{G3/20})^2 / 3] = 10.44\text{dBi} > 6\text{dBi}$, so the power density limit shall be reduced to $30 - (10.44 - 6) = 25.56\text{dBm}$.

802.11n (HT20)

TX chain	Channel	Freq. (MHz)	PSD (dBm/300kHz)	PSD (dBm/500kHz)	10 log (N=2) dB	Total PSD (dBm/500kHz)	Limit (dBm/500kHz)	Pass /Fail
0	149	5745	1.78	4.00	4.77	8.77	25.56	Pass
	157	5785	2.35	4.57	4.77	9.34	25.56	Pass
	165	5825	4.34	6.56	4.77	11.33	25.56	Pass
1	149	5745	1.10	3.32	4.77	8.09	25.56	Pass
	157	5785	1.09	3.31	4.77	8.08	25.56	Pass
	165	5825	2.99	5.21	4.77	9.98	25.56	Pass
2	149	5745	0.37	2.59	4.77	7.36	25.56	Pass
	157	5785	0.42	2.64	4.77	7.41	25.56	Pass
	165	5825	1.64	3.86	4.77	8.63	25.56	Pass

Note: 1. Directional gain = $10 \log[(10^{G1/20} + 10^{G2/20} + 10^{G3/20})^2 / 3] = 10.44\text{dBi} > 6\text{dBi}$, so the power density limit shall be reduced to $30 - (10.44 - 6) = 25.56\text{dBm}$.

802.11n (HT40)

TX chain	Chan.	Chan. Freq. (MHz)	PSD W/O Duty Factor		10 log (N=2) dB	Duty Factor (dB)	Total PSD With Duty Factor (dBm/500kHz)	Limit (dBm/500kHz)	Pass /Fail
			(dBm/300kHz)	(dBm/500kHz)					
0	151	5755	1.09	3.31	4.77	0.11	8.19	25.56	Pass
	159	5795	1.98	4.20	4.77	0.11	9.08	25.56	Pass
1	151	5755	-0.85	1.37	4.77	0.11	6.25	25.56	Pass
	159	5795	0.47	2.69	4.77	0.11	7.57	25.56	Pass
2	151	5755	0.05	2.27	4.77	0.11	7.15	25.56	Pass
	159	5795	-0.86	1.36	4.77	0.11	6.24	25.56	Pass

- Note:** 1. Directional gain = $10 \log[(10^{G1/20} + 10^{G2/20} + 10^{G3/20})^2 / 3] = 10.44\text{dBi} > 6\text{dBi}$, so the power density limit shall be reduced to $30-(10.44-6) = 25.56\text{dBm}$
2. Refer to section 3.3 for duty cycle spectrum plot.

802.11ac (VHT80)

TX chain	Chan.	Chan. Freq. (MHz)	PSD W/O Duty Factor		10 log (N=2) dB	Duty Factor (dB)	Total PSD With Duty Factor (dBm/500kHz)	Limit (dBm/500kHz)	Pass /Fail
			(dBm/300kHz)	(dBm/500kHz)					
0	155	5775	-6.45	-4.23	4.77	0.23	0.77	25.56	Pass
1	155	5775	-7.84	-5.62	4.77	0.23	-0.62	25.56	Pass
2	155	5775	-7.08	-4.86	4.77	0.23	0.14	25.56	Pass

- Note:** 1. Directional gain = $10 \log[(10^{G1/20} + 10^{G2/20} + 10^{G3/20})^2 / 3] = 10.44\text{dBi} > 6\text{dBi}$, so the power density limit shall be reduced to $30-(10.44-6) = 25.56\text{dBm}$
2. Refer to section 3.3 for duty cycle spectrum plot.

Spectrum Plot of Worst Value

802.11a_Chain 0 / CH165

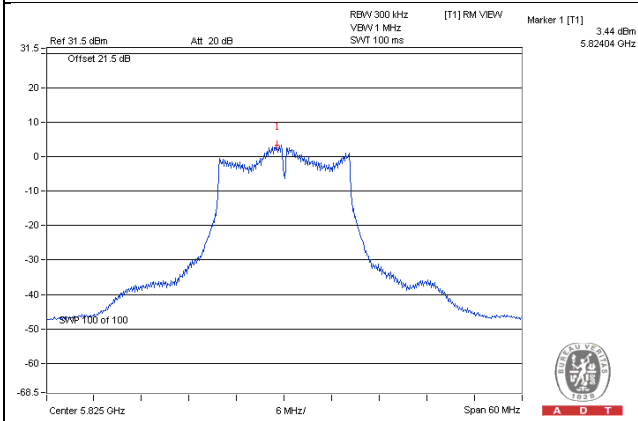

802.11ac (VHT20)_Chain 0 / CH165

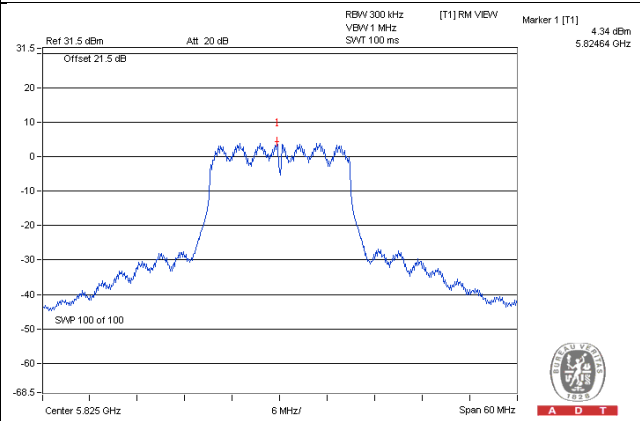

802.11ac (VHT40)_Chain 0 / CH159

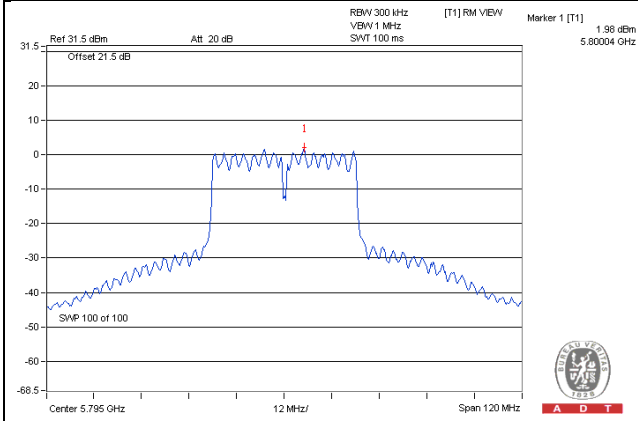

802.11ac (VHT80)_Chain 0 / CH155

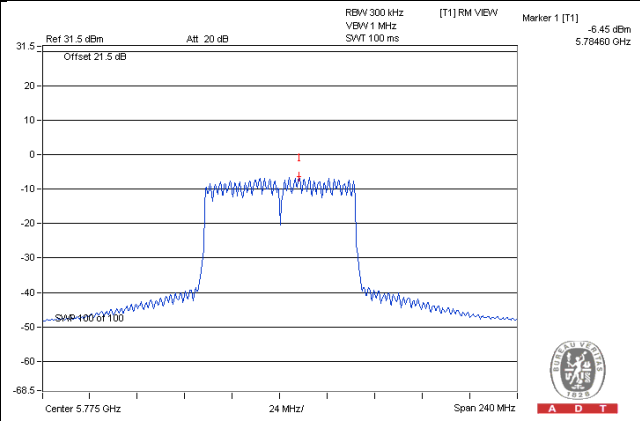

4.5 Frequency Stability Measurement

4.5.1 Limits of Frequency Stability Measurement

The frequency of the carrier signal shall be maintained within band of operation

4.5.2 Test Setup

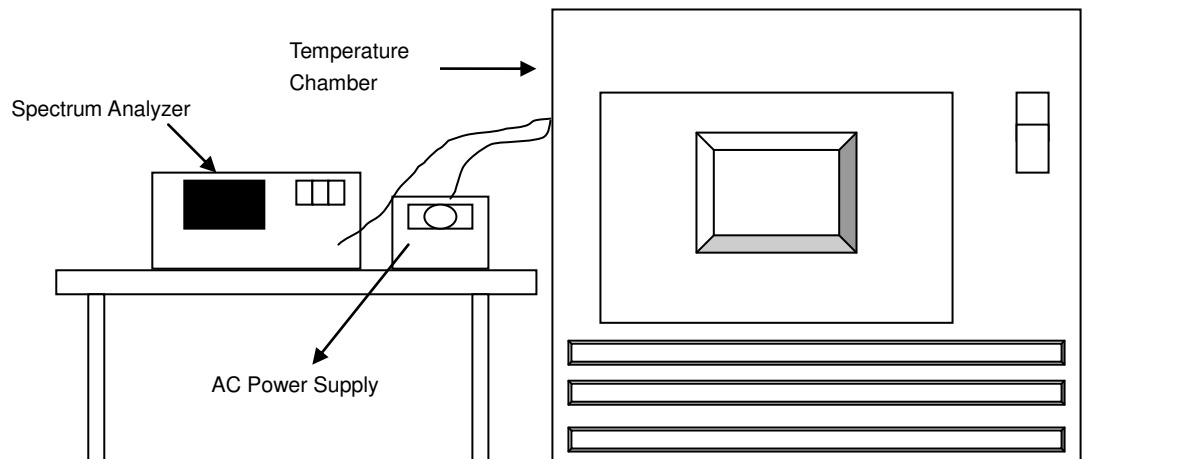

4.5.3 Test Instruments

Refer to section 4.1.2 to get information of above instrument.

4.5.4 Test Procedure

- The EUT was placed inside the environmental test chamber and powered by nominal AC voltage.
- Turn the EUT on and couple its output to a spectrum analyzer.
- Turn the EUT off and set the chamber to the highest temperature specified.
- Allow sufficient time (approximately 30 min) for the temperature of the chamber to stabilize, turn the EUT on and measure the operating frequency after 2, 5, and 10 Minutes.
- Repeat step 2 and 3 with the temperature chamber set to the lowest temperature.
- The test chamber was allowed to stabilize at +20 degree C for a minimum of 30 Minutes. The supply voltage was then adjusted on the EUT from 85% to 115% and the frequency record.

4.5.5 Deviation from Test Standard

No deviation.

4.5.6 EUT Operating Condition

Set the EUT transmit at un-modulation mode to test frequency stability.

4.5.7 Test Results

Frequency Stability Versus Temp.									
Operating Frequency: 5180 MHz									
TEMP. (°C)	Power Supply (Vac)	0 Minute		2 Minute		5 Minute		10 Minute	
		Measured Frequency (MHz)	Pass/Fail	Measured Frequency (MHz)	Pass/Fail	Measured Frequency (MHz)	Pass/Fail	Measured Frequency (MHz)	Pass/Fail
50	120	5179.9934	Pass	5179.9943	Pass	5179.9946	Pass	5179.994	Pass
40	120	5179.9819	Pass	5179.9842	Pass	5179.9837	Pass	5179.9865	Pass
30	120	5180.0161	Pass	5180.0158	Pass	5180.0189	Pass	5180.0189	Pass
20	120	5180.0219	Pass	5180.02	Pass	5180.02	Pass	5180.024	Pass
10	120	5180.0181	Pass	5180.0162	Pass	5180.0171	Pass	5180.0165	Pass
0	120	5179.9994	Pass	5179.9997	Pass	5179.9969	Pass	5180.0004	Pass
-10	120	5180.0184	Pass	5180.0178	Pass	5180.0191	Pass	5180.018	Pass
-20	120	5180.001	Pass	5180.0001	Pass	5180.0003	Pass	5179.9984	Pass
-30	120	5180.0032	Pass	5180.0016	Pass	5180.0016	Pass	5179.999	Pass

Frequency Stability Versus Voltage									
Operating Frequency: 5180 MHz									
TEMP. (°C)	Power Supply (Vac)	0 Minute		2 Minute		5 Minute		10 Minute	
		Measured Frequency (MHz)	Pass/Fail	Measured Frequency (MHz)	Pass/Fail	Measured Frequency (MHz)	Pass/Fail	Measured Frequency (MHz)	Pass/Fail
20	138	5180.0229	Pass	5180.0207	Pass	5180.02	Pass	5180.0246	Pass
	120	5180.0219	Pass	5180.02	Pass	5180.02	Pass	5180.024	Pass
	102	5180.0214	Pass	5180.0204	Pass	5180.0191	Pass	5180.0245	Pass

4.6 6dB Bandwidth Measurement

4.6.1 Limits of 6dB Bandwidth Measurement

The minimum of 6dB Bandwidth Measurement is 0.5MHz.

4.6.2 Test Setup

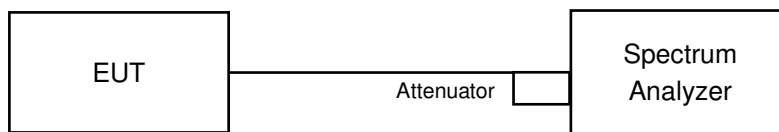

4.6.3 Test Instruments

Refer to section 4.1.2 to get information of above instrument.

4.6.4 Test Procedure

MEASUREMENT PROCEDURE REF

- Set resolution bandwidth (RBW) = 100kHz
- Set the video bandwidth (VBW) $\geq 3 \times$ RBW, Detector = Peak.
- Trace mode = max hold.
- Sweep = auto couple.
- Measure the maximum width of the emission that is constrained by the frequencies associated with the two amplitude points (upper and lower) that are attenuated by 6 dB relative to the maximum level measured in the fundamental emission

4.6.5 Deviation from Test Standard

No deviation.

4.6.6 EUT Operating Condition

The software provided by client to enable the EUT under transmission condition continuously at lowest, middle and highest channel frequencies individually.

4.6.7 Test Results

802.11a

Channel	Frequency (MHz)	6dB Bandwidth (MHz)			Minimum Limit (MHz)	Pass / Fail
		Chain 0	Chain 1	Chain 2		
149	5745	15.76	16.41	15.78	0.5	Pass
157	5785	16.45	16.44	15.79	0.5	Pass
165	5825	16.39	16.45	16.37	0.5	Pass

802.11n (HT20)

Channel	Frequency (MHz)	6dB Bandwidth (MHz)			Minimum Limit (MHz)	Pass / Fail
		Chain 0	Chain 1	Chain 2		
149	5745	16.75	17.67	17.65	0.5	Pass
157	5785	16.34	17.66	17.62	0.5	Pass
165	5825	16.29	17.65	17.61	0.5	Pass

802.11ac (VHT40)

Channel	Frequency (MHz)	6dB Bandwidth (MHz)			Minimum Limit (MHz)	Pass / Fail
		Chain 0	Chain 1	Chain 2		
151	5755	36.41	36.35	36.42	0.5	Pass
159	5795	36.46	36.51	36.45	0.5	Pass

802.11ac (VHT80)

Channel	Frequency (MHz)	6dB Bandwidth (MHz)			Minimum Limit (MHz)	Pass / Fail
		Chain 0	Chain 1	Chain 2		
155	5775	75.54	76.49	75.82	0.5	Pass

Spectrum Plot of Worst Value

802.11a_Chain 0 / CH149

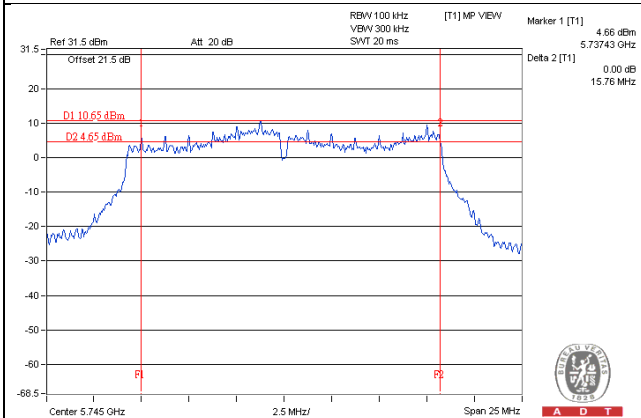

802.11ac (VHT20)_Chain 0 / CH165

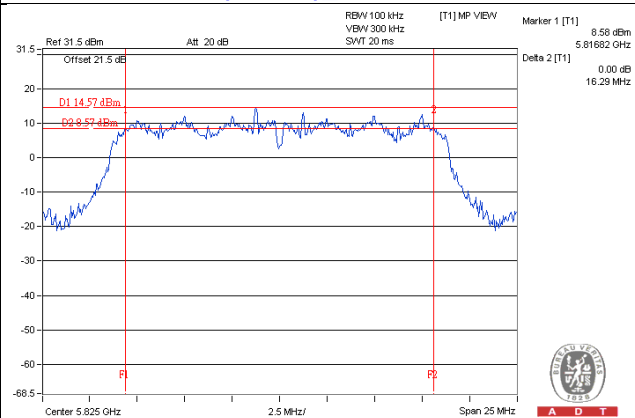

802.11ac (VHT40)_Chain 1 / CH151

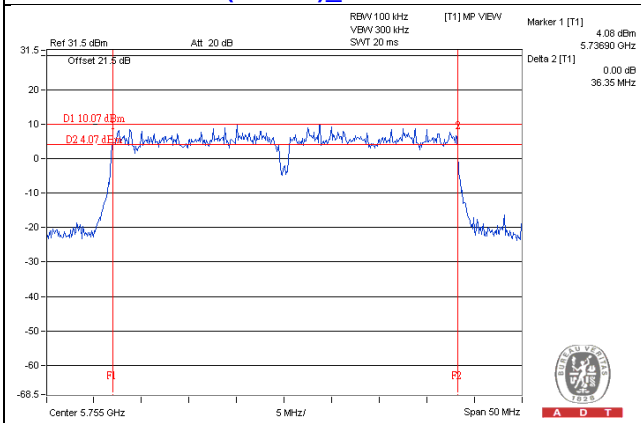

802.11ac (VHT80)_Chain 0 / CH155

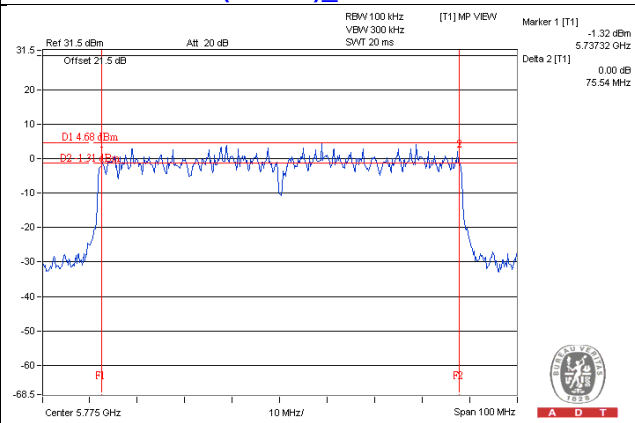

5 Pictures of Test Arrangements

Please refer to the attached file (Test Setup Photo).

Annex A- Radiated Out of Band Emisison (OOBE) Measurement (For U-NII-3 band)

802.11a

CH 149 5745 MHz

Horizontal

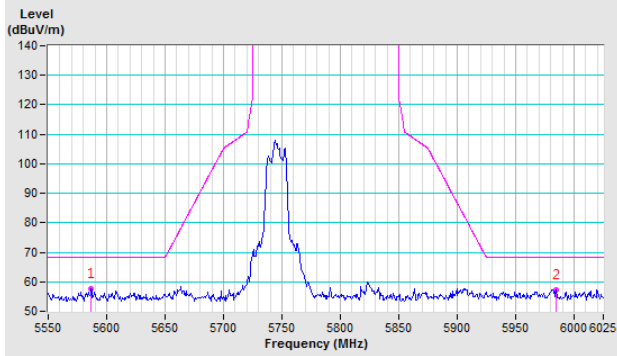

Vertical

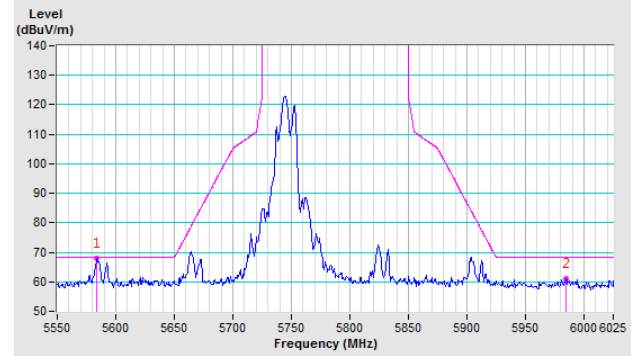

CH 157 5785 MHz

Horizontal

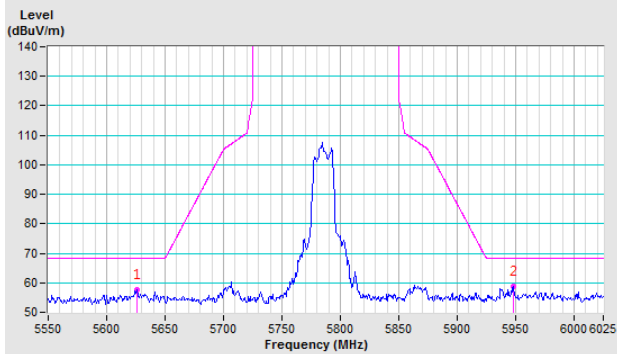

Vertical

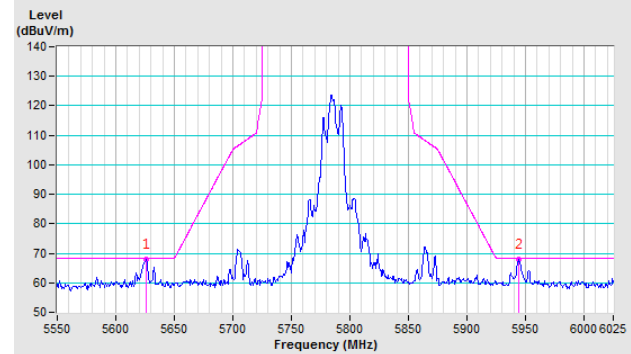

CH 165 5825 MHz

Horizontal

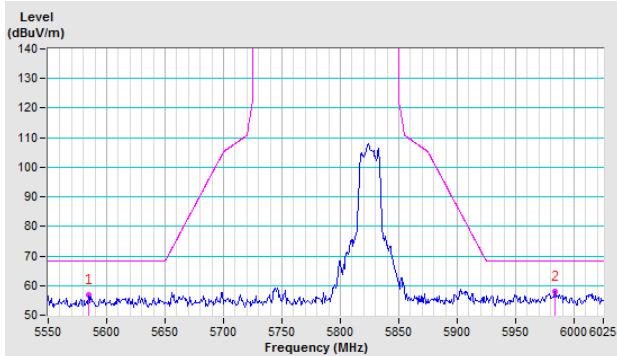

Vertical

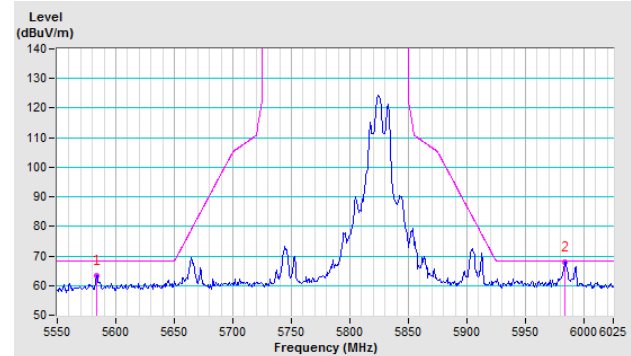

802.11ac (VHT20)

CH 149 5745 MHz

Horizontal

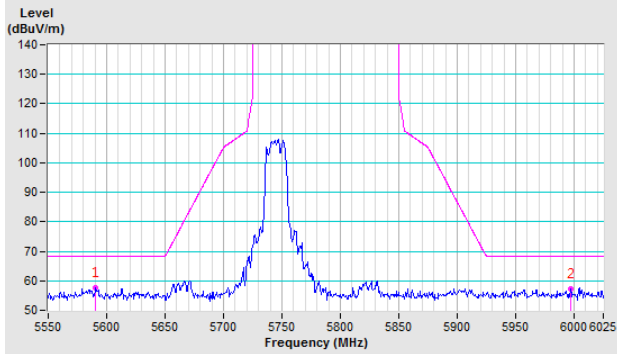

Vertical

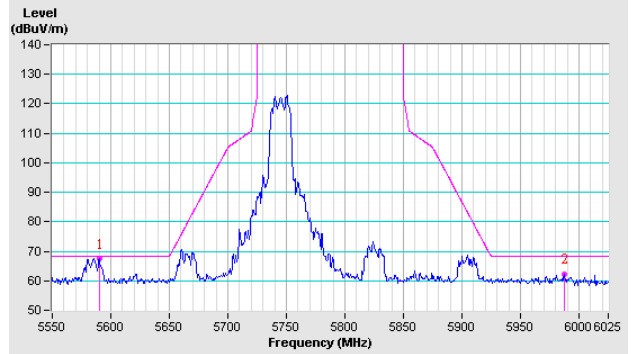

CH 157 5785 MHz

Horizontal

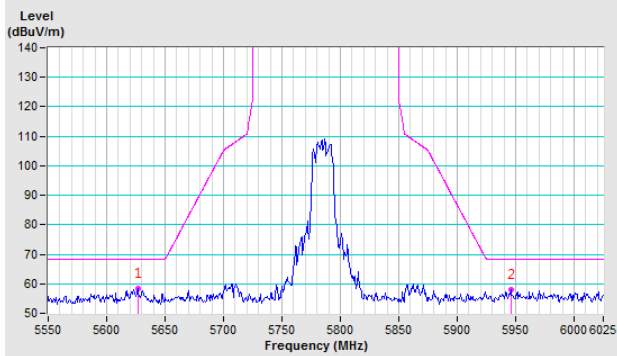

Vertical

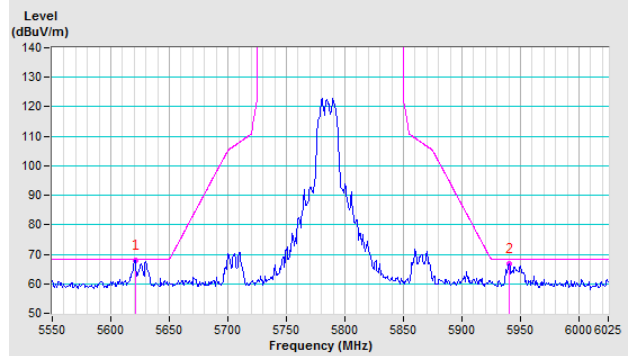

CH 165 5825 MHz

Horizontal

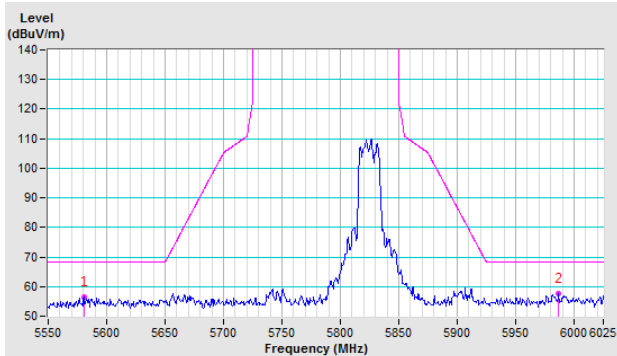

Vertical

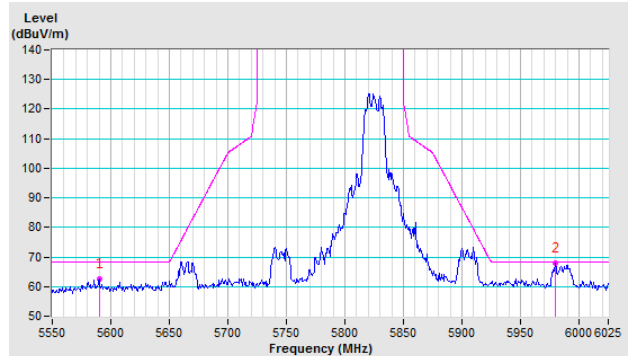

802.11ac (VHT40)

CH 151 5755 MHz

Horizontal

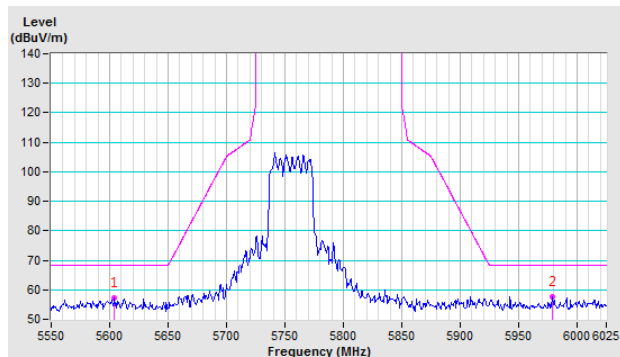

Vertical

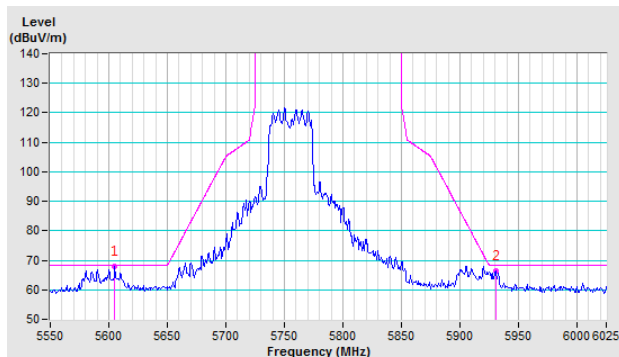

CH 159 5795 MHz

Horizontal

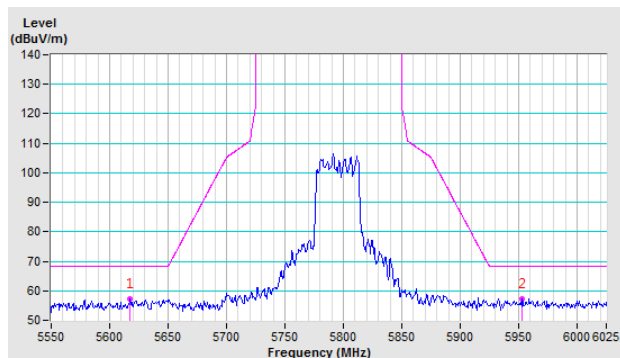

Vertical

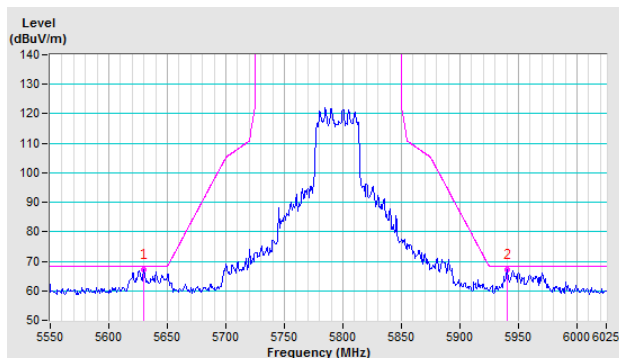

802.11ac (VHT80)

CH 155 5775 MHz

Horizontal

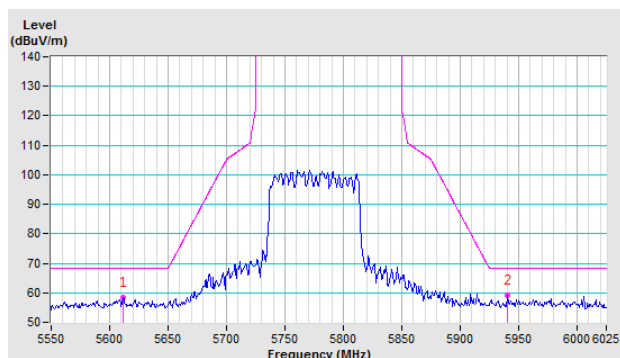

Vertical

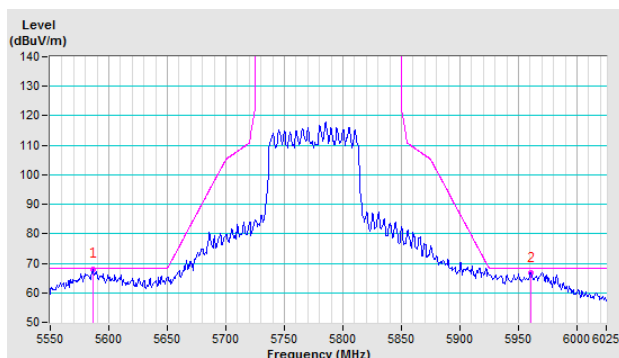

Appendix – Information on the Testing Laboratories

We, Bureau Veritas Consumer Products Services (H.K.) Ltd., Taoyuan Branch, were founded in 1988 to provide our best service in EMC, Radio, Telecom and Safety consultation. Our laboratories are accredited and approved according to ISO/IEC 17025.

If you have any comments, please feel free to contact us at the following:

Linko EMC/RF Lab

Tel: 886-2-26052180

Fax: 886-2-26051924

Hsin Chu EMC/RF/Telecom Lab

Tel: 886-3-6668565

Fax: 886-3-6668323

Hwa Ya EMC/RF/Safety Lab

Tel: 886-3-3183232

Fax: 886-3-3270892

Email: service.adt@tw.bureauveritas.com

Web Site: www.bureauveritas-adt.com

The address and road map of all our labs can be found in our web site also.

--- END ---