



FCC TEST REPORT (15.407)

REPORT NO.: RF140402E02-1 R1

MODEL NO.: ECWO5320, ECWO5320-L, ECWO5320-C,
ECWO5324, ECWO5324-L, ECWO5324-C

FCC ID: YZKECWO5320

RECEIVED: Apr. 02, 2014

TESTED: Apr. 10 to 17, 2014

ISSUED: May 30, 2014

APPLICANT: Edgecore Networks Corporation.

ADDRESS: No.1, Creation Rd. III, Hsinchu Science
Park, Hsinchu 30077, Taiwan, R.O.C

ISSUED BY: Bureau Veritas Consumer Products Services
(H.K.) Ltd., Taoyuan Branch Hsin Chu Laboratory

LAB ADDRESS : No. 81-1, Lu Liao Keng, 9th Ling, Wu Lung Tsuen,
Chiung Lin Hsiang, Hsin Chu Hsien 307, Taiwan,
R.O.C.

TEST LOCATION (1): No. 81-1, Lu Liao Keng, 9th Ling, Wu Lung Tsuen,
Chiung Lin Hsiang, Hsin Chu Hsien 307, Taiwan,
R.O.C.

TEST LOCATION (2): No. 49, Ln. 206, Wende Rd., Shangshan Tsuen,
Chiung Lin Hsiang, Hsin Chu Hsien 307, Taiwan,
R.O.C.

This report should not be used by the client to claim product certification, approval, or endorsement by TAF or any government agencies.



This report is for your exclusive use. Any copying or replication of this report to or for any other person or entity, or use of our name or trademark, is permitted only with our prior written permission. This report sets forth our findings solely with respect to the test samples identified herein. The results set forth in this report are not indicative or representative of the quality or characteristics of the lot from which a test sample was taken or any similar or identical product unless specifically and expressly noted. Our report includes all of the tests requested by you and the results thereof based upon the information that you provided to us. You have 60 days from date of issuance of this report to notify us of any material error or omission caused by our negligence, provided, however, that such notice shall be in writing and shall specifically address the issue you wish to raise. A failure to raise such issue within the prescribed time shall constitute your unqualified acceptance of the completeness of this report, the tests conducted and the correctness of the report contents. Unless specific mention, the uncertainty of measurement has been explicitly taken into account to declare the compliance or non-compliance to the specification



A D T

Table of Contents

RELEASE CONTROL RECORD	4
1. CERTIFICATION	5
2. SUMMARY OF TEST RESULTS	6
2.1 MEASUREMENT UNCERTAINTY	7
3. GENERAL INFORMATION	8
3.1 GENERAL DESCRIPTION OF EUT	8
3.2 DESCRIPTION OF TEST MODES	12
3.2.1 TEST MODE APPLICABILITY AND TESTED CHANNEL DETAIL	13
3.3 GENERAL DESCRIPTION OF APPLIED STANDARDS	16
3.4 DUTY CYCLE OF TEST SIGNAL	17
3.5 DESCRIPTION OF SUPPORT UNITS.....	24
3.6 CONFIGURATION OF SYSTEM UNDER TEST	25
4. TEST TYPES AND RESULTS	26
4.1 CONDUCTED EMISSION MEASUREMENT	26
4.1.1 LIMITS OF CONDUCTED EMISSION MEASUREMENT	26
4.1.2 TEST INSTRUMENTS.....	26
4.1.3 TEST PROCEDURES	27
4.1.4 DEVIATION FROM TEST STANDARD	27
4.1.5 TEST SETUP	27
4.1.6 EUT OPERATING CONDITIONS	28
4.1.7 TEST RESULTS	29
4.2 RADIATED EMISSION AND BANDEDGE MEASUREMENT	31
4.2.1 LIMITS OF RADIATED EMISSION AND BANDEDGE MEASUREMENT	31
4.2.2 LIMITS OF UNWANTED EMISSION OUT OF THE RESTRICTED BANDS.....	31
4.2.3 TEST INSTRUMENTS.....	32
4.2.4 TEST PROCEDURES	34
4.2.5 DEVIATION FROM TEST STANDARD	34
4.2.6 TEST SETUP	35
4.2.7 EUT OPERATING CONDITION.....	35
4.2.8 TEST RESULTS (MODE 1)	36
4.2.9 TEST RESULTS (MODE 2)	52
4.3 TRANSMIT POWER MEASUREMENT	68
4.3.1 LIMITS OF TRANSMIT POWER MEASUREMENT	68
4.3.2 TEST INSTRUMENTS.....	68
4.3.3 TEST PROCEDURE.....	69
4.3.4 DEVIATION FROM TEST STANDARD	69
4.3.5 TEST SETUP	69
4.3.6 EUT OPERATING CONDITIONS	70



A D T

4.3.7	TEST RESULTS (MODE 1)	71
4.3.8	TEST RESULTS (MODE 2)	78
4.4	PEAK POWER SPECTRAL DENSITY MEASUREMENT	85
4.4.1	LIMITS OF PEAK POWER SPECTRAL DENSITY MEASUREMENT	85
4.4.2	TEST INSTRUMENTS	85
4.4.3	TEST PROCEDURES	85
4.4.4	DEVIATION FROM TEST STANDARD	85
4.4.5	TEST SETUP	85
4.4.6	EUT OPERATING CONDITIONS	86
4.4.7	TEST RESULTS (MODE 1)	87
4.4.8	TEST RESULTS (MODE 2)	91
4.5	PEAK POWER EXCURSION MEASUREMENT	95
4.5.1	LIMITS OF PEAK POWER EXCURSION MEASUREMENT	95
4.5.2	TEST INSTRUMENTS	95
4.5.3	TEST PROCEDURE	95
4.5.4	DEVIATION FROM TEST STANDARD	95
4.5.5	TEST SETUP	95
4.5.6	EUT OPERATING CONDITIONS	95
4.5.7	TEST RESULTS (MODE 1)	96
4.5.8	TEST RESULTS (MODE 2)	101
4.6	FREQUENCY STABILITY	106
4.6.1	LIMITS OF FREQUENCY STABILITY MEASUREMENT	106
4.6.2	TEST INSTRUMENTS	106
4.6.3	TEST PROCEDURE	106
4.6.4	DEVIATION FROM TEST STANDARD	107
4.6.5	TEST SETUP	107
4.6.6	EUT OPERATING CONDITION	107
4.6.7	TEST RESULTS (MODE 1)	108
4.6.8	TEST RESULTS (MODE 2)	109
4.6.9	PHOTOGRAPHS OF THE TEST CONFIGURATION	110
5.	INFORMATION ON THE TESTING LABORATORIES	111
6.	APPENDIX A - MODIFICATIONS RECORDERS FOR ENGINEERING CHANGES TO THE EUT BY THE LAB	112



A D T

RELEASE CONTROL RECORD

ISSUE NO.	REASON FOR CHANGE	DATE ISSUED
RF140402E02-1	Original release	May 14, 2014
RF140402E02-1 R1	Modified the product name	May 30, 2014



A D T

1. CERTIFICATION

PRODUCT: 802.11ac Outdoor Dual Band Access Point
BRAND NAME: Edge-corE
MODEL NO.: ECWO5320, ECWO5320-L, ECWO5320-C,
ECWO5324, ECWO5324-L, ECWO5324-C
TEST SAMPLE: ENGINEERING SAMPLE
APPLICANT: Edgecore Networks Corporation.
TESTED: Apr. 10 to 17, 2014
STANDARDS: FCC Part 15, Subpart E (Section 15.407)
ANSI C63.10-2009

The above equipment (Model: ECWO5320, ECWO5324) have been tested by **Bureau Veritas Consumer Products Services (H.K.) Ltd., Taoyuan Branch**, and found compliance with the requirement of the above standards. The test record, data evaluation & Equipment Under Test (EUT) configurations represented herein are true and accurate accounts of the measurements of the sample's EMC characteristics under the conditions specified in this report.

PREPARED BY : Midoli Peng , **DATE:** May 30, 2014
(Midoli Peng, Specialist)

APPROVED BY : May Chen , **DATE:** May 30, 2014
(May Chen, Manager)



A D T

2. SUMMARY OF TEST RESULTS

The EUT has been tested according to the following specifications:

APPLIED STANDARD: FCC PART 15, SUBPART E (SECTION 15.407)			
STANDARD SECTION	TEST TYPE	RESULT	REMARK
15.407(b)(6)	AC Power Conducted Emission	PASS	Meet the requirement of limit. Minimum passing margin is -12.39dB at 0.15391MHz
15.407(b/1/2/3) (b)(6)	Spurious Emissions	PASS	Meet the requirement of limit. Minimum passing margin is -1.7dB at 125.00MHz.
15.407(a/1/2)	Transmit Power	PASS	Meet the requirement of limit.
15.407(a)(6)	Peak Power Excursion	PASS	Meet the requirement of limit.
15.407(a/1/2)	Peak Power Spectral Density	PASS	Meet the requirement of limit.
15.407(g)	Frequency Stability	PASS	Meet the requirement of limit.
15.203	Antenna Requirement	PASS	Antenna connector is RP-SMA or MMCX not a standard connector.

NOTE: 1. For WLAN: The EUT was operating in 2400 ~ 2483.5MHz, 5.15~5.25GHz and 5.725~5.850GHz frequencies band. This report was recorded the RF parameters including 5.15~5.25GHz. For the 2400 ~ 2483.5MHz and 5.725~5.850GHz RF parameters was recorded in another test report.



A D T

2.1 MEASUREMENT UNCERTAINTY

Where relevant, the following measurement uncertainty levels have been estimated for tests performed on the EUT as specified in CISPR 16-4-2:

This uncertainty represents an expanded uncertainty expressed at approximately the 95% confidence level using a coverage factor of $k=2$.

Measurement	Value
Conducted emissions	2.86 dB
Radiated emissions (30MHz-1GHz)	5.37 dB
Radiated emissions (1GHz -6GHz)	3.72 dB
Radiated emissions (6GHz -18GHz)	4.00 dB
Radiated emissions (18GHz -40GHz)	4.11 dB



A D T

3. GENERAL INFORMATION

3.1 GENERAL DESCRIPTION OF EUT

PRODUCT	802.11ac Outdoor Dual Band Access Point
MODEL NO.	ECWO5320, ECWO5320-L, ECWO5320-C, ECWO5324, ECWO5324-L, ECWO5324-C
POWER SUPPLY	DC 24V from POE
MODULATION TYPE	CCK, DQPSK, DBPSK for DSSS 64QAM, 16QAM, QPSK, BPSK for OFDM 256QAM for OFDM in 11ac mode only
MODULATION TECHNOLOGY	DSSS,OFDM
TRANSFER RATE	802.11b: up to 11Mbps 802.11a / g: up to 54Mbps 802.11n: up to 300Mbps 802.11ac: up to 866.7Mbps
OPERATING FREQUENCY	For 15.407 5GHz: 5.18 ~ 5.24GHz For 15.247 2.4GHz: 2.412 ~ 2.462GHz 5GHz: 5.745 ~ 5.825GHz
NUMBER OF CHANNEL	For 15.407 4 for 802.11a, 802.11n (HT20), 802.11ac (VHT20) 2 for 802.11n (HT40), 802.11ac (VHT40) 1 for 802.11ac (VHT80) For 15.247 (2.4GHz) 11 for 802.11b, 802.11g, 802.11n (HT20) 7 for 802.11n (HT40) For 15.247 (5GHz) 5 for 802.11a, 802.11n (HT20), 802.11ac (VHT20) 2 for 802.11n (HT40), 802.11ac (VHT40) 1 for 802.11ac (VHT80)
MAXIMUM OUTPUT POWER	Please see NOTE
ANTENNA TYPE	Please see NOTE
DATA CABLE	NA
I/O PORTS	Refer to user's manual
ASSOCIATED DEVICES	POE x1



A D T

Note:

1. The EUT is a 2.4GHz & 5GHz WLAN device.
2. 2.4GHz & 5GHz technology can transmit at same time.
3. The EUT has six model names, which are identical to each other in all aspects except for the followings:

Product Name	Brand Name	Model Name	Different
802.11ac Outdoor Dual Band Access Point	Edge-corE	ECWO5320	External antenna (2.4GHz) + Internal antenna (5GHz)
	Edge-corE	ECWO5320-L	External antenna (2.4GHz) + Internal antenna (5GHz)
	Edge-corE	ECWO5320-C	External antenna (2.4GHz) + Internal antenna (5GHz)
	Edge-corE	ECWO5324	External antenna (2.4GHz) + External antenna (5GHz)
	Edge-corE	ECWO5324-L	External antenna (2.4GHz) + External antenna (5GHz)
	Edge-corE	ECWO5324-C	External antenna (2.4GHz) + External antenna (5GHz)

From the above models, models: **ECWO5320**, **ECWO5324** were selected as representative model for the test and its data was recorded in this report.

4. The EUT must be supplied with a POE as following table:

Brand	Model No.	Spec.
NA	NU24-F240100-I2	Input: 100-240V, 0.7A, 50/60Hz Output: 24V, 1A

5. The antennas provided to the EUT, please refer to the following table:

External antenna								
Transmitter Circuit	Antenna Type	Connector Type	Antenna Gain(dBi) < excluding cable loss>	Inside EUT		Outside EUT		Frequency range (MHz to MHz)
				Cable Loss (dB)	Cable Length (mm)	Cable Loss (dB)	Cable Length (mm)	
Chain (0)	Dipole	RP-SMA	2.65	1	250	1.5	500	2400~2500
			2.7	1.2	250	2.9	500	5150~5850
Chain (1)	Dipole	RP-SMA	2.65	1	250	1.5	500	2400~2500
			2.7	1.2	250	2.9	500	5150~5850
Internal antenna								
Transmitter Circuit	Antenna Type	Connector Type	Antenna Gain(dBi)	Frequency range (MHz to MHz)				
Chain (0)	Patch Array	MMCX	12.5	5150~5850				
Chain (1)	Patch Array	MMCX	12.5	5150~5850				

※For 802.11a/b/g mode will fix transmission on Chain (0)

6. The maximum output power(mW) table as below table:

15.247 (2.4GHz) – with External antenna			
1Tx		2Tx	
802.11b	137.404	802.11b	-
802.11g	146.893	802.11g	-
802.11n (HT20)	148.594	802.11n (HT20)	222.389
802.11n (HT40)	102.802	802.11n (HT40)	260.942
15.247 (5GHz) – with External antenna			
1Tx		2Tx	
802.11a	253.513	802.11a	-
802.11ac (VHT20)	253.513	802.11ac (VHT20)	244.946
802.11ac (VHT40)	251.768	802.11ac (VHT40)	200.708
802.11ac (VHT80)	153.109	802.11ac (VHT80)	192.573
15.247 (5GHz) – with Internal antenna			
1Tx		2Tx	
802.11a	138.995	802.11a	-
802.11ac (VHT20)	211.349	802.11ac (VHT20)	217.548
802.11ac (VHT40)	208.449	802.11ac (VHT40)	200.708
802.11ac (VHT80)	153.109	802.11ac (VHT80)	192.573
15.407 (5GHz) – with External antenna			
1Tx		2Tx	
802.11a	46.026	802.11a	-
802.11ac (VHT20)	45.082	802.11ac (VHT20)	45.450
802.11ac (VHT40)	49.091	802.11ac (VHT40)	49.095
802.11ac (VHT80)	49.091	802.11ac (VHT80)	46.776
15.407 (5GHz) – with Internal antenna			
1Tx		2Tx	
802.11a	10.423	802.11a	-
802.11ac (VHT20)	10.351	802.11ac (VHT20)	10.175
802.11ac (VHT40)	10.447	802.11ac (VHT40)	11.048
802.11ac (VHT80)	10.889	802.11ac (VHT80)	10.896



A D T

7. The EUT incorporates a MIMO function without beamforming.

MODULATION MODE	Tx/Rx FUNCTION
802.11a	1Tx/2Rx
802.11b	1Tx/2Rx
802.11g	1Tx/2Rx
802.11n (HT20)	1Tx/2Rx or 2Tx/2Rx
802.11n (HT40)	1Tx/2Rx or 2Tx/2Rx
802.11ac (VHT20)	1Tx/2Rx or 2Tx/2Rx
802.11ac (VHT40)	1Tx/2Rx or 2Tx/2Rx
802.11ac (VHT80)	1Tx/2Rx or 2Tx/2Rx

Note: The modulation and bandwidth are similar for 802.11n mode for 20MHz (40MHz) and 802.11ac mode for 20MHz (40MHz), therefore investigated worst case to representative mode in test report. (Final test mode refer section 3.2.1)

8. Spurious emission of the simultaneous operation (2.4GHz & 5GHz) has been evaluated and no non-compliance was found.
9. When the EUT operating in 802.11n, the software operation, which is defined by manufacturer, MCS (Modulation and Coding Schemes) from 0 to 15.
10. When the EUT operating in 802.11ac, the software operation, which is defined by manufacturer, MCS (Modulation and Coding Schemes) from 0 to 9.
11. The above EUT information was declared by the manufacturer and for more detailed features description, please refer to the manufacturer's specifications or User's Manual.



A D T

3.2 DESCRIPTION OF TEST MODES

Operated in 5150 ~ 5250MHz band:

4 channels are provided for 802.11a, 802.11n (HT20), 802.11ac (VHT20):

CHANNEL	FREQUENCY
36	5180 MHz
40	5200 MHz
44	5220 MHz
48	5240 MHz

2 channels are provided for 802.11n (HT40), 802.11ac (VHT40):

CHANNEL	FREQUENCY
38	5190 MHz
46	5230 MHz

1 channel is provided for 802.11ac (VHT80):

CHANNEL	FREQUENCY
42	5210 MHz



A D T

3.2.1 TEST MODE APPLICABILITY AND TESTED CHANNEL DETAIL

EUT CONFIGURE MODE	APPLICABLE TO				DESCRIPTION
	PLC	RE < 1G	RE ≥ 1G	APCM	
1	-	√	√	√	with External antenna
2	√	√	√	√	with Internal antenna

Where **PLC**: Power Line Conducted Emission **RE < 1G**: Radiated Emission below 1GHz
RE ≥ 1G: Radiated Emission above 1GHz **APCM**: Antenna Port Conducted Measurement

POWER LINE CONDUCTED EMISSION TEST:

- Pre-Scan has been conducted to determine the worst-case mode from all possible combinations between available modulations, data rates and antenna ports (if EUT with antenna diversity architecture).
- Following channel(s) was (were) selected for the final test as listed below.

MODE	AVAILABLE CHANNEL	TESTED CHANNEL	MODULATION TECHNOLOGY	MODULATION TYPE	DATA RATE (MBPS)
802.11ac (VHT40)	38 to 134	46	OFDM	BPSK	27

RADIATED EMISSION TEST (BELOW 1 GHz):

- Pre-Scan has been conducted to determine the worst-case mode from all possible combinations between available modulations, data rates and antenna ports (if EUT with antenna diversity architecture).
- Following channel(s) was (were) selected for the final test as listed below.

MODE	AVAILABLE CHANNEL	TESTED CHANNEL	MODULATION TECHNOLOGY	MODULATION TYPE	DATA RATE (Mbps)
802.11ac (VHT40)	38 to 134	46	OFDM	BPSK	27



A D T

RADIATED EMISSION TEST (ABOVE 1 GHz):

- Pre-Scan has been conducted to determine the worst-case mode from all possible combinations between available modulations, data rates and antenna ports (if EUT with antenna diversity architecture).
- Following channel(s) was (were) selected for the final test as listed below.

MODE	AVAILABLE CHANNEL	TESTED CHANNEL	MODULATION TECHNOLOGY	MODULATI ON TYPE	DATA RATE (Mbps)
802.11a	36 to 48	36, 40, 48	OFDM	BPSK	6
802.11ac (VHT20), 1Tx	36 to 48	36, 40, 48	OFDM	BPSK	6.5
802.11ac (VHT40) , 1Tx	38 to 46	38, 46	OFDM	BPSK	13.5
802.11ac (VHT80) , 1Tx	42	42	OFDM	BPSK	29.3
802.11ac (VHT20), 2Tx	36 to 48	36, 40, 48	OFDM	BPSK	13
802.11ac (VHT40) , 2Tx	38 to 46	38, 46	OFDM	BPSK	27
802.11ac (VHT80) , 2Tx	42	42	OFDM	BPSK	58.5

ANTENNA PORT CONDUCTED MEASUREMENT:

- Pre-Scan has been conducted to determine the worst-case mode from all possible combinations between available modulations, data rates and antenna ports (if EUT with antenna diversity architecture).
- Following channel(s) was (were) selected for the final test as listed below.

MODE	AVAILABLE CHANNEL	TESTED CHANNEL	MODULATION TECHNOLOGY	MODULATI ON TYPE	DATA RATE (Mbps)
802.11a	36 to 48	36, 40, 48	OFDM	BPSK	6
802.11ac (VHT20), 1Tx	36 to 48	36, 40, 48	OFDM	BPSK	6.5
802.11ac (VHT40) , 1Tx	38 to 46	38, 46	OFDM	BPSK	13.5
802.11ac (VHT80) , 1Tx	42	42	OFDM	BPSK	29.3
802.11ac (VHT20), 2Tx	36 to 48	36, 40, 48	OFDM	BPSK	13
802.11ac (VHT40) , 2Tx	38 to 46	38, 46	OFDM	BPSK	27
802.11ac (VHT80) , 2Tx	42	42	OFDM	BPSK	58.5



A D T

TEST CONDITION:

APPLICABLE TO	ENVIRONMENTAL CONDITIONS	INPUT POWER	TESTED BY
PLC	16deg. 69C,%RH	120Vac, 60Hz	Jason Huang
RE<1G	21deg. C, 65%RH	120Vac, 60Hz	Robert Cheng
RE ³ 1G	24deg. C, 73%RH	120Vac, 60Hz	Robert Cheng
	24deg. C, 73%RH	120Vac, 60Hz	Andy Ho
APCM	25deg. C, 60%RH	120Vac, 60Hz	Robert Cheng



3.3 GENERAL DESCRIPTION OF APPLIED STANDARDS

The EUT is a RF product. According to the specifications of the manufacturer, it must comply with the requirements of the following standards:

FCC Part 15, Subpart E (15.407)

789033 D01 General UNII Test Procedures v01r03

662911 D01 Multiple Transmitter Output v02r01

ANSI C63.10-2009

All test items have been performed and recorded as per the above standards.

Note: The EUT has been verified to comply with the requirements of FCC Part 15, Subpart B, Class B (DoC). The test report has been issued separately.

3.4 DUTY CYCLE OF TEST SIGNAL

Duty cycle of test signal is 100 %, duty factor is not required.

802.11a, 1Tx

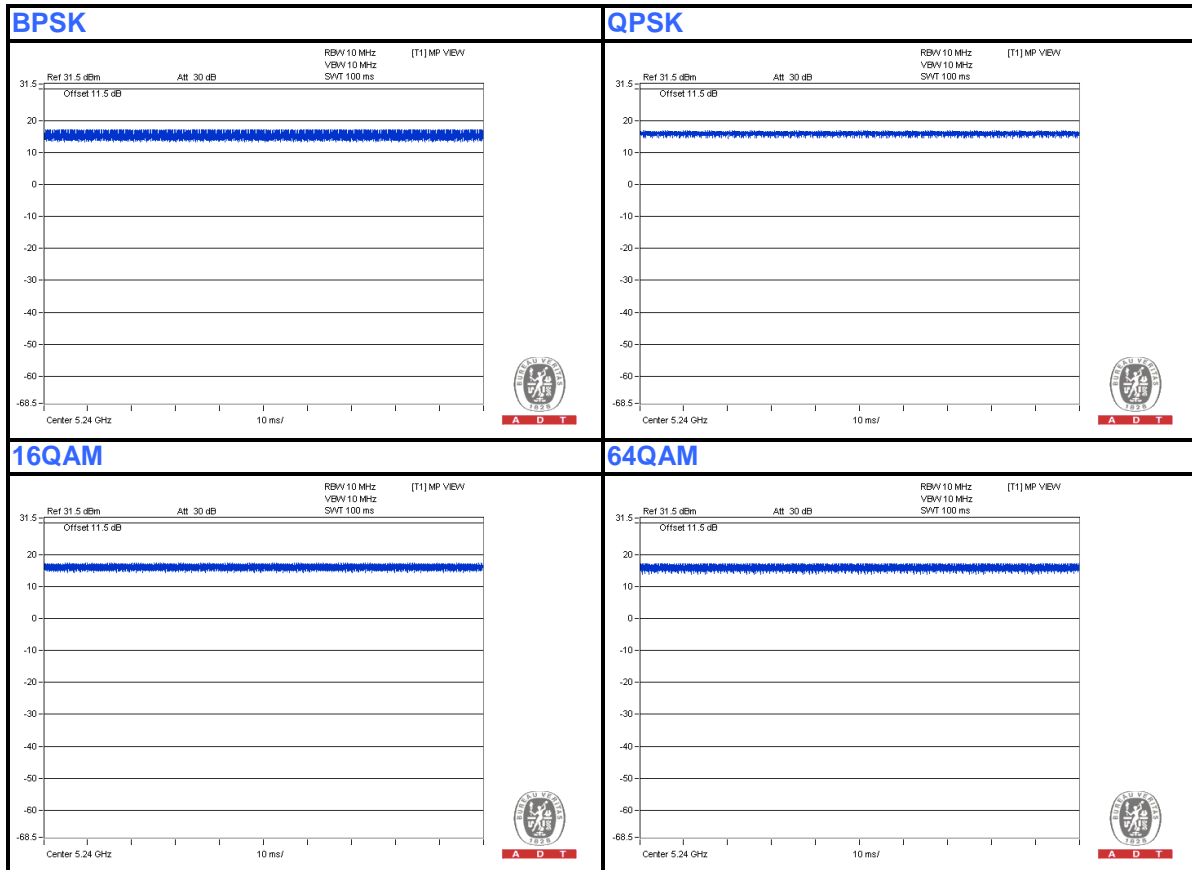



A D T

Duty cycle of test signal is 100 %, duty factor is not required.

802.11ac (VHT20), 1Tx

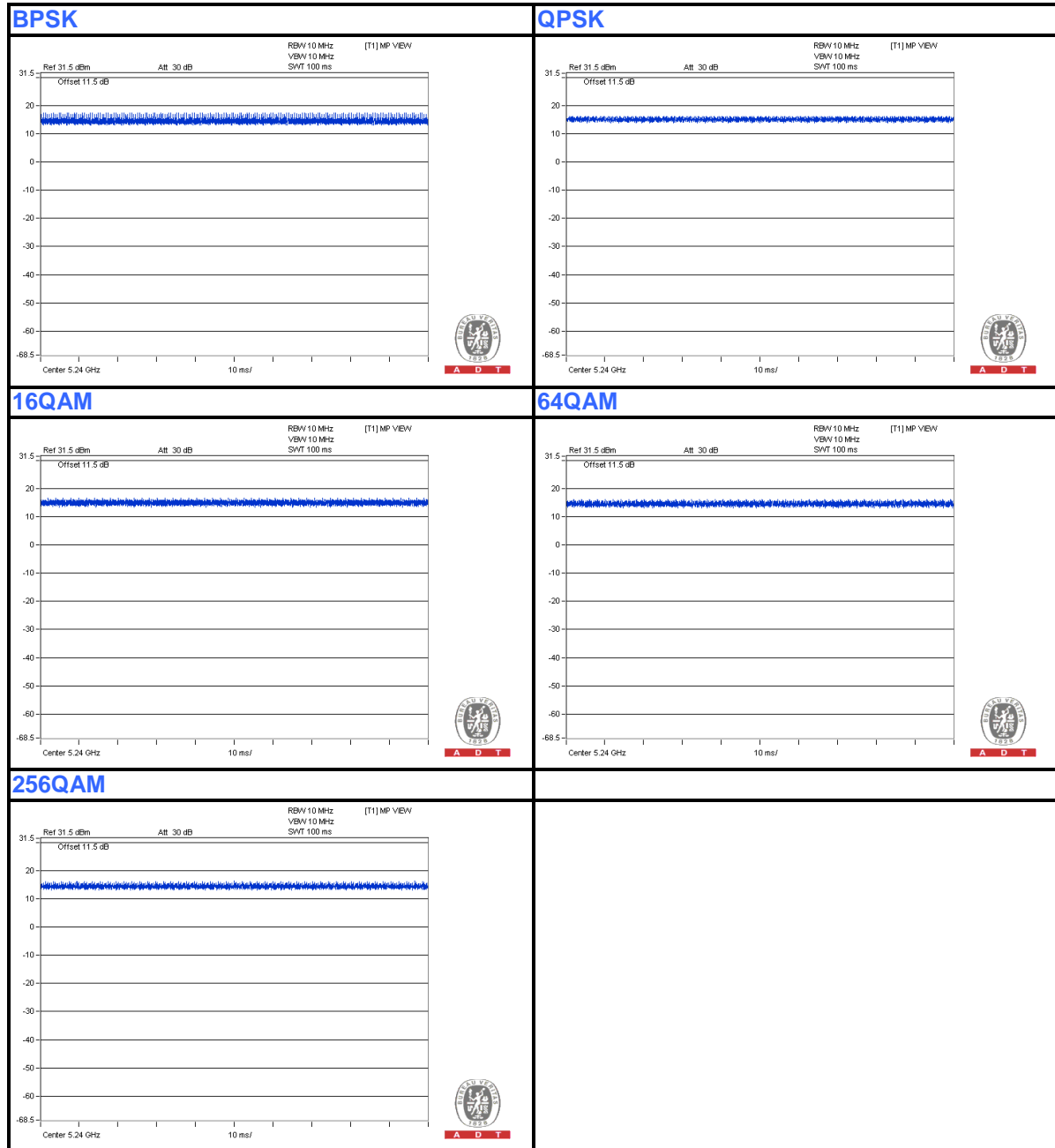



A D T

Duty cycle of test signal is 100 %, duty factor is not required.

802.11ac (VHT40), 1Tx





A D T

Duty cycle of test signal is 100 %, duty factor is not required.

802.11ac (VHT80), 1Tx





A D T

Duty cycle of test signal is 100 %, duty factor is not required.

802.11ac (VHT20), 2Tx

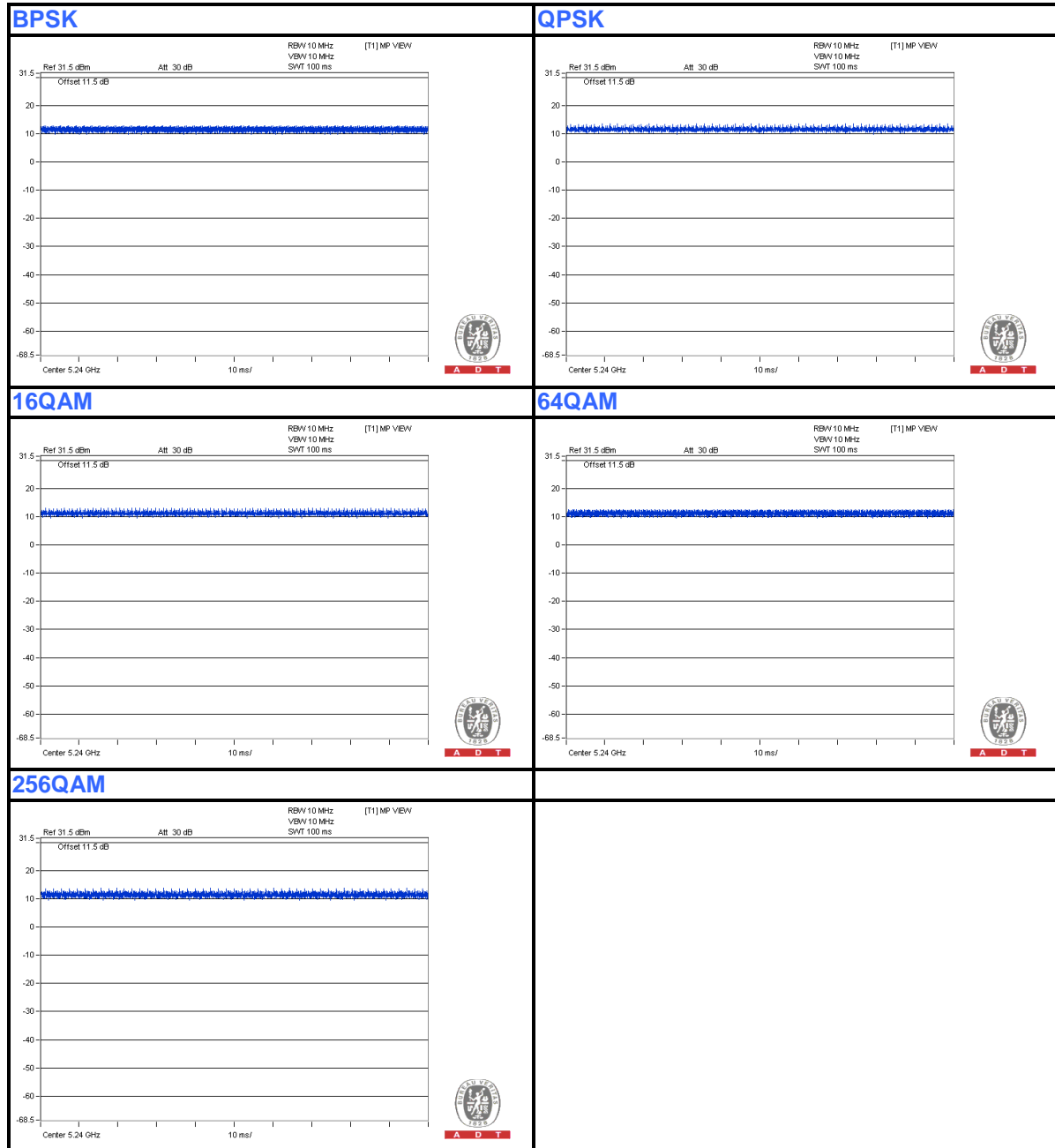



A D T

Duty cycle of test signal is 100 %, duty factor is not required.

802.11ac (VHT40), 2Tx





A D T

Duty cycle of test signal is 100 %, duty factor is not required.

802.11ac (VHT80), 2Tx

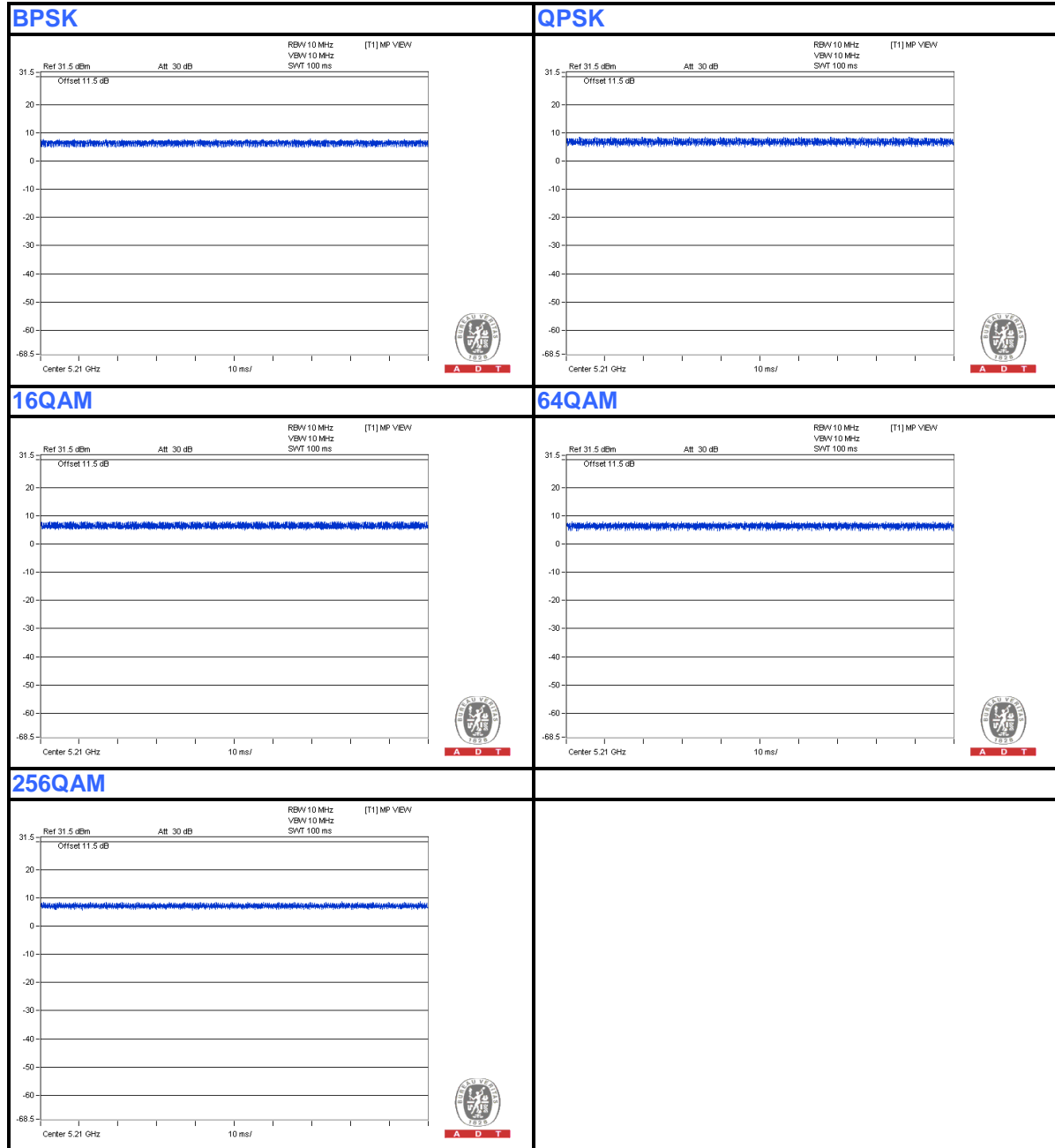



A D T

3.5 DESCRIPTION OF SUPPORT UNITS

The EUT has been tested as an independent unit together with other necessary accessories or support units. The following support units or accessories were used to form a representative test configuration during the tests.

No.	Product	Brand	Model No.	Serial No.	FCC ID
1	NOTEBOOK COMPUTER	DELL	PP32LA	GSLB32S	NA
2	NOTEBOOK COMPUTER	DELL	PP32LA	FSLB32S	NA

No.	Signal cable description
1	UTP cable(10m)
2	UTP cable(10m)

Note: The power cords of the above support units were unshielded (1.8m).

3.6 CONFIGURATION OF SYSTEM UNDER TEST

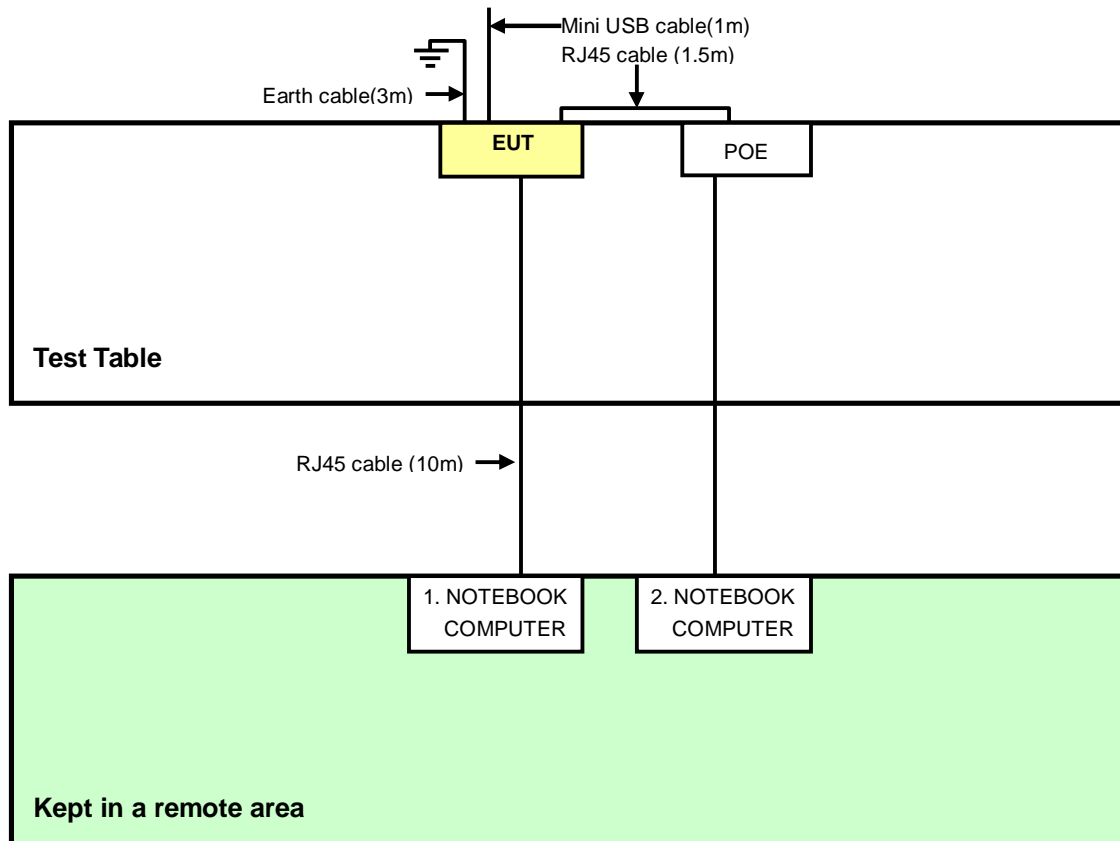

4. TEST TYPES AND RESULTS

4.1 CONDUCTED EMISSION MEASUREMENT

4.1.1 LIMITS OF CONDUCTED EMISSION MEASUREMENT

FREQUENCY OF EMISSION (MHz)	CONDUCTED LIMIT (dB μ V)	
	Quasi-peak	Average
0.15-0.5	66 to 56	56 to 46
0.5-5	56	46
5-30	60	50

- NOTE:**
1. The lower limit shall apply at the transition frequencies.
 2. The limit decreases in line with the logarithm of the frequency in the range of 0.15 to 0.50 MHz.

4.1.2 TEST INSTRUMENTS

DESCRIPTION & MANUFACTURER	MODEL NO.	SERIAL NO.	CALIBRATED DATE	CALIBRATED UNTIL
Test Receiver LIG NEX1	ER-265	L09068005	July 22, 2013	July 21, 2014
Pulse Limiter SCHWARZBECK	VTSD 9561F	9607	Mar. 06, 2014	Mar. 05, 2015
Line-Impedance Stabilization Network (for EUT) SCHWARZBECK	NSLK8127	8127-522	Sep. 05, 2013	Sep. 04, 2014
Line-Impedance Stabilization Network (for Peripheral)	ENV216	100072	June 06, 2013	June 05, 2014
RF Cable (JYEBAO)	5DFB	CONCAB-003	Mar. 07, 2014	Mar. 06, 2015
50 ohms Terminator	50	EMC-03	Sep. 24, 2013	Sep. 23, 2014
Software ADT	BV ADT_Cond_V7.3.7. 3	NA	NA	NA

Note:

1. The calibration interval of the above test instruments is 12 months and the calibrations are traceable to NML/ROC and NIST/USA.
2. The test was performed in Shielded Room No. C.
3. The VCCI Con C Registration No. is C-3611.
4. Tested Date: Apr. 17, 2014

4.1.3 TEST PROCEDURES

- a. The EUT was placed 0.4 meters from the conducting wall of the shielded room with EUT being connected to the power mains through a line impedance stabilization network (LISN). Other support units were connected to the power mains through another LISN.
- b. The two LISNs provide 50 ohm/ 50uH of coupling impedance for the measuring instrument.
- c. Both lines of the power mains connected to the EUT were checked for maximum conducted interference.
- d. The frequency range from 150kHz to 30MHz was searched. Emission level under (Limit – 20dB) was not recorded.

NOTE:

1. The resolution bandwidth of test receiver is 9kHz for Quasi-peak detection (QP) & Average detection (AV).

4.1.4 DEVIATION FROM TEST STANDARD

No deviation

4.1.5 TEST SETUP

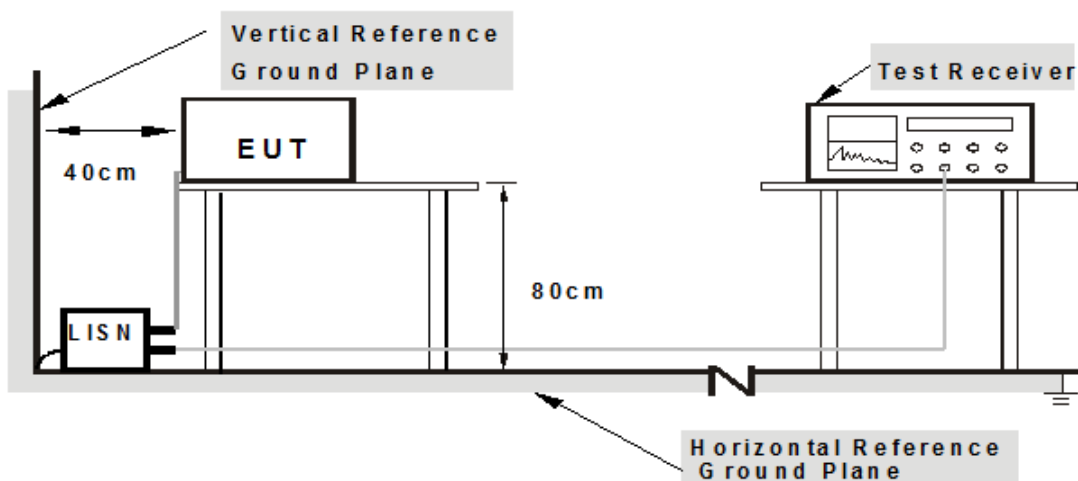

Note: 1. Support units were connected to second LISN.

For the actual test configuration, please refer to the related item – Photographs of the Test Configuration.

4.1.6 EUT OPERATING CONDITIONS

1. Placed the EUT on testing table.
2. Prepared computer system (support units 1 ~ 2) to act as communication partner.
3. The communication partner ran test program “MP_TEST.exe[Ver 1.3.8.0]” to enable EUT under transmission/receiving condition continuously.

4.1.7 TEST RESULTS

PHASE	Line (L)	DETECTOR FUNCTION	Quasi-Peak (QP) / Average (AV)
-------	----------	-------------------	--------------------------------

No	Freq. [MHz]	Corr. Factor [dB]	Reading Value [dB (uV)]		Emission Level [dB (uV)]		Limit [dB (uV)]		Margin (dB)	
			Q.P.	AV.	Q.P.	AV.	Q.P.	AV.	Q.P.	AV.
1	0.15000	0.06	52.20	39.72	52.26	39.78	66.00	56.00	-13.74	-16.22
2	0.16953	0.06	48.22	35.26	48.28	35.32	64.98	54.98	-16.70	-19.66
3	0.18906	0.06	44.73	29.63	44.79	29.69	64.08	54.08	-19.29	-24.39
4	0.29063	0.06	36.49	27.27	36.55	27.33	60.51	50.51	-23.95	-23.17
5	17.26953	0.59	31.13	25.97	31.72	26.56	60.00	50.00	-28.28	-23.44
6	22.09375	0.72	34.21	29.60	34.93	30.32	60.00	50.00	-25.07	-19.68

REMARKS:

1. Q.P. and AV. are abbreviations of quasi-peak and average individually.
2. The emission levels of other frequencies were very low against the limit.
3. Margin value = Emission Level – Limit value
4. Correction Factor = Insertion loss + Cable loss
5. Emission Level = Correction Factor + Reading Value

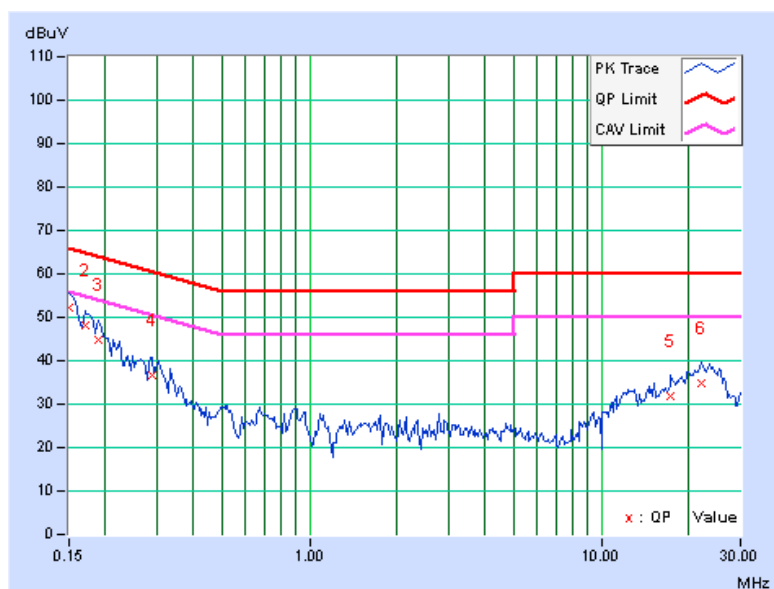



A D T

PHASE	Neutral (N)	DETECTOR FUNCTION	Quasi-Peak (QP) / Average (AV)
--------------	-------------	--------------------------	--------------------------------

No	Freq. [MHz]	Corr. Factor [dB]	Reading Value [dB (uV)]		Emission Level [dB (uV)]		Limit [dB (uV)]		Margin (dB)	
			Q.P.	AV.	Q.P.	AV.	Q.P.	AV.	Q.P.	AV.
1	0.15391	0.07	53.33	39.08	53.40	39.15	65.79	55.79	-12.39	-16.64
2	0.16953	0.07	49.81	36.12	49.88	36.19	64.98	54.98	-15.11	-18.80
3	0.18125	0.06	48.16	32.61	48.22	32.67	64.43	54.43	-16.20	-21.75
4	0.19687	0.06	44.62	30.97	44.68	31.03	63.74	53.74	-19.06	-22.71
5	0.29844	0.06	37.12	27.52	37.18	27.58	60.29	50.29	-23.10	-22.70
6	25.00781	0.80	34.22	29.46	35.02	30.26	60.00	50.00	-24.98	-19.74

REMARKS:

1. Q.P. and AV. are abbreviations of quasi-peak and average individually.
2. The emission levels of other frequencies were very low against the limit.
3. Margin value = Emission Level – Limit value
4. Correction Factor = Insertion loss + Cable loss
5. Emission Level = Correction Factor + Reading Value

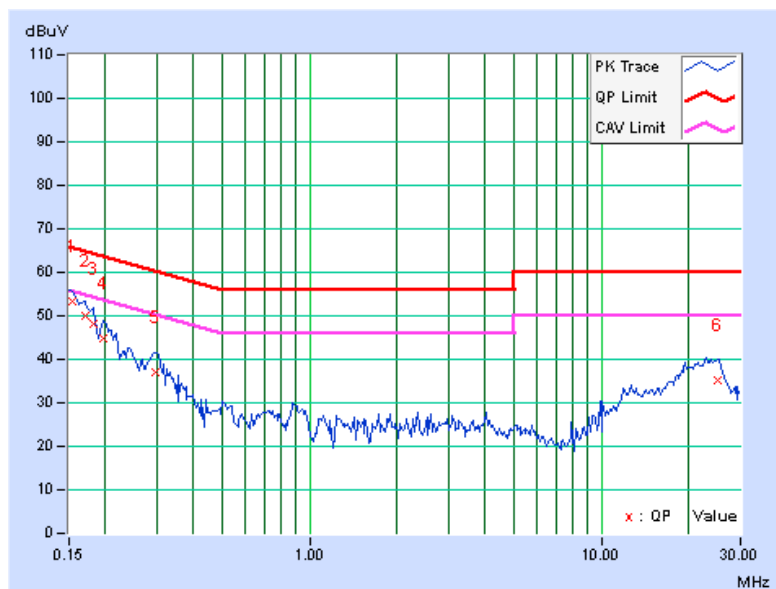



A D T

4.2 RADIATED EMISSION AND BANDEDGE MEASUREMENT

4.2.1 LIMITS OF RADIATED EMISSION AND BANDEDGE MEASUREMENT

Radiated emissions which fall in the restricted bands must comply with the radiated emission limits specified as below table:

Frequencies (MHz)	Field strength (microvolts/meter)	Measurement distance (meters)
0.009-0.490	2400/F(kHz)	300
0.490-1.705	24000/F(kHz)	30
1.705-30.0	30	30
30-88	100	3
88-216	150	3
216-960	200	3
Above 960	500	3

NOTE:

1. The lower limit shall apply at the transition frequencies.
2. Emission level (dBuV/m) = 20 log Emission level (uV/m).
3. For frequencies above 1000MHz, the field strength limits are based on average detector, however, the peak field strength of any emission shall not exceed the maximum permitted average limits, specified above by more than 20dB under any condition of modulation.

4.2.2 LIMITS OF UNWANTED EMISSION OUT OF THE RESTRICTED BANDS

APPLICABLE TO	LIMIT	
√	FIELD STRENGTH AT 3m (dBμV/m)	
	PK	AV
	74	54
	EIRP LIMIT (dBm)	EQUIVALENT FIELD STRENGTH AT 3m (dBμV/m)
	PK	PK
	-27	68.3

NOTE:

1. The following formula is used to convert the equipment isotropic radiated power (eirp) to field strength:

$$E = \frac{1000000\sqrt{30P}}{3} \mu\text{V/m, where P is the eirp (Watts).}$$



A D T

4.2.3 TEST INSTRUMENTS

For Below 1GHz:

DESCRIPTION & MANUFACTURER	MODEL NO.	SERIAL NO.	CALIBRATED DATE	CALIBRATED UNTIL
MXE EMI Receiver Agilent	N9038A	MY51210105	Jan. 21,2014	Jan. 20,2015
Pre-Amplifier Mini-Circuits	ZFL-1000VH2 B	AMP-ZFL-03	Nov. 13, 2013	Nov. 12, 2014
Trilog Broadband Antenna SCHWARZBECK	VULB 9168	9168-360	Feb. 26, 2014	Feb. 25, 2015
RF Cable	NA	CHGCAB_001	Oct. 05, 2013	Oct. 04, 2014
Spectrum Analyzer R&S	FSV40	100964	July 15, 2013	July 14, 2014
Horn_Antenna AISI	AIH.8018	0000320091110	Nov. 18, 2013	Nov. 17, 2014
Pre-Amplifier Agilent	8449B	3008A02578	June 25, 2013	June 24, 2014
RF Cable	NA	RF104-201 RF104-203 RF104-204	Dec. 12, 2013	Dec. 11, 2014
Spectrum Analyzer Agilent	E4446A	MY48250253	Aug. 28, 2013	Aug. 27, 2014
Pre-Amplifier SPACEK LABS	SLKKa-48-6	9K16	Nov. 13, 2013	Nov. 12, 2014
Horn_Antenna SCHWARZBECK	BBHA 9170	9170-424	Oct. 08, 2013	Oct. 07, 2014
Software	ADT_Radiated _V8.7.07	NA	NA	NA
Antenna Tower & Turn Table CT	NA	NA	NA	NA

Note:

1. The calibration interval of the above test instruments is 12 months and the calibrations are traceable to NML/ROC and NIST/USA.
2. The horn antenna, preamplifier (model: 8449B) are used only for the measurement of emission frequency above 1GHz if tested.
- 3 The test was performed in 966 Chamber No. G.
4. The FCC Site Registration No. is 966073.
- 5 The VCCI Site Registration No. is G-137.
- 6 The CANADA Site Registration No. is IC 7450H-2.
- 7 Tested Date: Apr. 11, 2014



A D T

For Above 1GHz:

DESCRIPTION & MANUFACTURER	MODEL NO.	SERIAL NO.	CALIBRATED DATE	CALIBRATED UNTIL
MXE EMI Receiver Agilent	N9038A	MY50010156	Jan. 15, 2014	Jan. 14, 2015
Pre-Amplifier Mini-Circuits	ZFL-1000VH2 B	AMP-ZFL-04	Nov. 13, 2013	Nov. 12, 2014
Trilog Broadband Antenna SCHWARZBECK	VULB 9168	9168-361	Feb. 27, 2014	Feb. 26, 2015
RF Cable	NA	CHHCAB_001	Oct. 06, 2013	Oct. 05, 2014
Spectrum Analyzer R&S	FSV40	100964	July 15, 2013	July 14, 2014
Horn_Antenna AISI	AIH.8018	0000220091110	Dec. 06, 2013	Dec. 05, 2014
Pre-Amplifier Agilent	8449B	3008A01923	Oct. 29, 2013	Oct. 28, 2014
RF Cable	NA	RF104-205 RF104-207 RF104-202	Dec. 12, 2013	Dec. 11, 2014
Spectrum Analyzer Agilent	E4446A	MY48250253	Aug. 28, 2013	Aug. 27, 2014
Pre-Amplifier SPACEK LABS	SLKKa-48-6	9K16	Nov. 13, 2013	Nov. 12, 2014
Horn_Antenna SCHWARZBECK	BBHA 9170	9170-424	Oct. 08, 2013	Oct. 07, 2014
Software	ADT_Radiated _V8.7.07	NA	NA	NA
Antenna Tower & Turn Table CT	NA	NA	NA	NA

Note:

1. The calibration interval of the above test instruments is 12 months and the calibrations are traceable to NML/ROC and NIST/USA.
2. The horn antenna, preamplifier (model: 8449B) are used only for the measurement of emission frequency above 1GHz if tested.
3. The test was performed in 966 Chamber No. H.
4. The FCC Site Registration No. is 797305.
5. The CANADA Site Registration No. is IC 7450H-3.
6. Tested Date: Apr. 16, 2014

4.2.4 TEST PROCEDURES

- a. The EUT was placed on the top of a rotating table 0.8 meters above the ground at 3 meter chamber room for test. The table was rotated 360 degrees to determine the position of the highest radiation.
- b. The EUT was set 3 meters away from the interference-receiving antenna, which was mounted on the top of a variable-height antenna tower.
- c. The height of antenna is varied from one meter to four meters above the ground to determine the maximum value of the field strength. Both horizontal and vertical polarizations of the antenna are set to make the measurement.
- d. For each suspected emission, the EUT was arranged to its worst case and then the antenna was tuned to heights from 1 meter to 4 meters and the rotatable table was turned from 0 degrees to 360 degrees to find the maximum reading.
- e. The test-receiver system was set to quasi-peak detect function and specified bandwidth with maximum hold mode when the test frequency is below 1 GHz.
- f. The test-receiver system was set to peak and average detect function and specified bandwidth with maximum hold mode when the test frequency is above 1 GHz. If the peak reading value also meets average limit, measurement with the average detector is unnecessary.

Note:

1. The resolution bandwidth and video bandwidth of test receiver/spectrum analyzer is 120kHz for Quasi-peak detection (QP) at frequency below 1GHz.
2. The resolution bandwidth of test receiver/spectrum analyzer is 1 MHz and the video bandwidth is 3 MHz for Peak detection (PK) at frequency above 1GHz.
3. The resolution bandwidth of test receiver/spectrum analyzer is 1MHz and the video bandwidth is 3MHz for RMS Average (Duty cycle < 98%) for Average detection (AV) at frequency above 1GHz, then the measurement results was added to a correction factor ($10 \log(1/\text{duty cycle})$).
4. The resolution bandwidth of test receiver/spectrum analyzer is 1MHz and the video bandwidth is 10Hz (Duty cycle $\geq 98\%$) for Average detection (AV) at frequency above 1GHz.
5. All modes of operation were investigated and the worst-case emissions are reported.

4.2.5 DEVIATION FROM TEST STANDARD

No deviation

4.2.6 TEST SETUP

<Frequency Range below 1GHz>

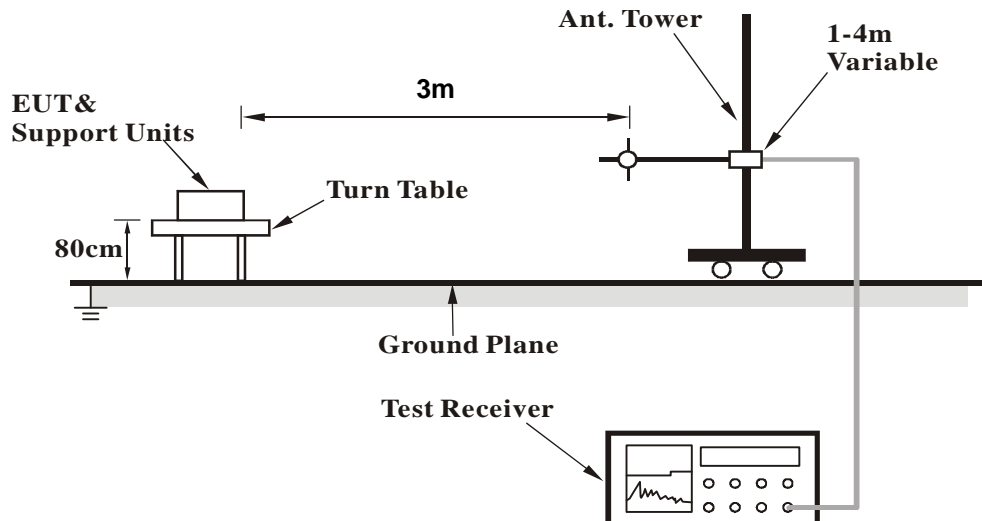

<Frequency Range above 1GHz>

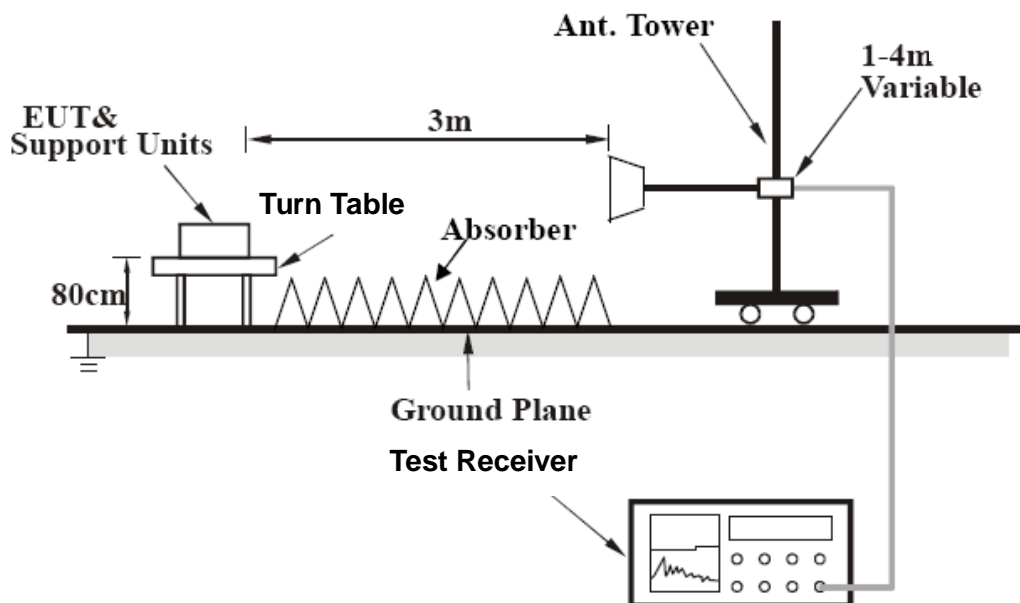

For the actual test configuration, please refer to the related item – Photographs of the Test Configuration.

4.2.7 EUT OPERATING CONDITION

Same as 4.1.6



A D T

4.2.8 TEST RESULTS (MODE 1)

BELOW 1GHz WORST-CASE DATA

802.11ac (VHT40), 2Tx

CHANNEL	TX Channel 46	DETECTOR FUNCTION	Quasi-Peak (QP)
FREQUENCY RANGE	Below 1GHz		

ANTENNA POLARITY & TEST DISTANCE: HORIZONTAL AT 3 M

NO.	FREQ. (MHz)	EMISSION LEVEL (dBuV/m)	LIMIT (dBuV/m)	MARGIN (dB)	ANTENNA HEIGHT (m)	TABLE ANGLE (Degree)	RAW VALUE (dBuV)	CORRECTION FACTOR (dB/m)
1	110.80	33.7 QP	43.5	-9.8	1.50 H	75	49.95	-16.25
2	125.01	40.3 QP	43.5	-3.2	2.00 H	284	55.20	-14.92
3	160.47	35.0 QP	43.5	-8.5	2.00 H	284	48.19	-13.18
4	174.24	36.0 QP	43.5	-7.5	1.50 H	77	50.07	-14.11
5	250.00	40.4 QP	46.0	-5.6	1.21 H	256	54.69	-14.32
6	362.52	41.8 QP	46.0	-4.2	1.00 H	325	52.57	-10.73

ANTENNA POLARITY & TEST DISTANCE: VERTICAL AT 3 M

NO.	FREQ. (MHz)	EMISSION LEVEL (dBuV/m)	LIMIT (dBuV/m)	MARGIN (dB)	ANTENNA HEIGHT (m)	TABLE ANGLE (Degree)	RAW VALUE (dBuV)	CORRECTION FACTOR (dB/m)
1	39.55	36.6 QP	40.0	-3.4	1.00 V	360	50.37	-13.80
2	71.08	34.2 QP	40.0	-5.8	1.00 V	219	50.02	-15.78
3	125.00	41.8 QP	43.5	-1.7	1.00 V	332	56.68	-14.92
4	250.00	41.9 QP	46.0	-4.1	2.00 V	330	56.26	-14.32
5	362.52	42.6 QP	46.0	-3.5	1.50 V	358	53.28	-10.73
6	875.02	42.3 QP	46.0	-3.7	1.00 V	323	42.75	-0.45

REMARKS:

1. Emission Level(dBuV/m) = Raw Value(dBuV) + Correction Factor(dB/m)
2. Correction Factor(dB/m) = Antenna Factor(dB/m) + Cable Factor(dB) – Pre-Amplifier Factor(dB)
3. The other emission levels were very low against the limit.
4. Margin value = Emission Level – Limit value



ABOVE 1GHz DATA

802.11a, 1Tx

CHANNEL	TX Channel 36	DETECTOR FUNCTION	Peak (PK)
FREQUENCY RANGE	1GHz ~ 40GHz		Average (AV)

ANTENNA POLARITY & TEST DISTANCE: HORIZONTAL AT 3 M

NO.	FREQ. (MHz)	EMISSION LEVEL (dBuV/m)	LIMIT (dBuV/m)	MARGIN (dB)	ANTENNA HEIGHT (m)	TABLE ANGLE (Degree)	RAW VALUE (dBuV)	CORRECTION FACTOR (dB/m)
1	5000.00	51.4 PK	74.0	-22.6	1.03 H	180	47.60	3.80
2	5000.00	40.8 AV	54.0	-13.2	1.03 H	180	37.00	3.80
3	5105.00	52.9 PK	74.0	-21.1	1.03 H	180	48.80	4.10
4	5105.00	41.8 AV	54.0	-12.2	1.03 H	180	37.70	4.10
5	*5180.00	101.8 PK			1.03 H	180	97.40	4.40
6	*5180.00	92.8 AV			1.03 H	180	88.40	4.40
7	#10360.00	55.5 PK	74.0	-18.5	1.00 H	65	45.40	10.10
8	#10360.00	41.9 AV	54.0	-12.1	1.00 H	65	31.80	10.10
9	15540.00	61.9 PK	74.0	-12.1	1.00 H	202	47.10	14.80
10	15540.00	48.7 AV	54.0	-5.3	1.00 H	202	33.90	14.80

ANTENNA POLARITY & TEST DISTANCE: VERTICAL AT 3 M

NO.	FREQ. (MHz)	EMISSION LEVEL (dBuV/m)	LIMIT (dBuV/m)	MARGIN (dB)	ANTENNA HEIGHT (m)	TABLE ANGLE (Degree)	RAW VALUE (dBuV)	CORRECTION FACTOR (dB/m)
1	5000.00	56.4 PK	74.0	-17.6	1.05 V	183	52.60	3.80
2	5000.00	45.8 AV	54.0	-8.2	1.05 V	183	42.00	3.80
3	5105.00	56.8 PK	74.0	-17.2	1.05 V	183	52.70	4.10
4	5105.00	46.2 AV	54.0	-7.8	1.05 V	183	42.10	4.10
5	*5180.00	111.9 PK			1.05 V	183	107.50	4.40
6	*5180.00	102.9 AV			1.05 V	183	98.50	4.40
7	#10360.00	54.1 PK	74.0	-19.9	1.04 V	9	44.00	10.10
8	#10360.00	41.0 AV	54.0	-13.0	1.04 V	9	30.90	10.10
9	15540.00	59.4 PK	74.0	-14.6	1.00 V	205	44.60	14.80
10	15540.00	49.1 AV	54.0	-4.9	1.00 V	205	34.30	14.80

REMARKS:

- Emission Level(dBuV/m) = Raw Value(dBuV) + Correction Factor(dB/m)
- Correction Factor(dB/m) = Antenna Factor(dB/m) + Cable Factor(dB) – Pre-Amplifier Factor(dB)
- The other emission levels were very low against the limit.
- Margin value = Emission Level – Limit value
- " * ": Fundamental frequency.
- " # ": The radiated frequency is out of the restricted band.



A D T

CHANNEL	TX Channel 40	DETECTOR FUNCTION	Peak (PK)
FREQUENCY RANGE	1GHz ~ 40GHz		Average (AV)

ANTENNA POLARITY & TEST DISTANCE: HORIZONTAL AT 3 M

NO.	FREQ. (MHz)	EMISSION LEVEL (dBuV/m)	LIMIT (dBuV/m)	MARGIN (dB)	ANTENNA HEIGHT (m)	TABLE ANGLE (Degree)	RAW VALUE (dBuV)	CORRECTION FACTOR (dB/m)
1	*5200.00	100.4 PK			1.03 H	185	96.00	4.40
2	*5200.00	90.3 AV			1.03 H	185	85.90	4.40
3	#10400.00	55.0 PK	74.0	-19.0	1.00 H	65	45.00	10.00
4	#10400.00	41.6 AV	54.0	-12.4	1.00 H	65	31.60	10.00
5	15600.00	62.2 PK	74.0	-11.8	1.00 H	199	47.10	15.10
6	15600.00	48.9 AV	54.0	-5.1	1.00 H	199	33.80	15.10

ANTENNA POLARITY & TEST DISTANCE: VERTICAL AT 3 M

NO.	FREQ. (MHz)	EMISSION LEVEL (dBuV/m)	LIMIT (dBuV/m)	MARGIN (dB)	ANTENNA HEIGHT (m)	TABLE ANGLE (Degree)	RAW VALUE (dBuV)	CORRECTION FACTOR (dB/m)
1	*5200.00	109.3 PK			1.03 V	185	104.90	4.40
2	*5200.00	100.4 AV			1.03 V	185	96.00	4.40
3	#10400.00	54.4 PK	74.0	-19.6	1.10 V	6	44.40	10.00
4	#10400.00	41.1 AV	54.0	-12.9	1.10 V	6	31.10	10.00
5	15600.00	60.4 PK	74.0	-13.6	1.00 V	210	45.30	15.10
6	15600.00	49.5 AV	54.0	-4.5	1.00 V	210	34.40	15.10

REMARKS:

1. Emission Level(dBuV/m) = Raw Value(dBuV) + Correction Factor(dB/m)
2. Correction Factor(dB/m) = Antenna Factor(dB/m) + Cable Factor(dB) – Pre-Amplifier Factor(dB)
3. The other emission levels were very low against the limit.
4. Margin value = Emission Level – Limit value
5. " * ": Fundamental frequency.
6. " # ": The radiated frequency is out of the restricted band.



A D T

CHANNEL	TX Channel 48	DETECTOR FUNCTION	Peak (PK)
FREQUENCY RANGE	1GHz ~ 40GHz		Average (AV)

ANTENNA POLARITY & TEST DISTANCE: HORIZONTAL AT 3 M

NO.	FREQ. (MHz)	EMISSION LEVEL (dBuV/m)	LIMIT (dBuV/m)	MARGIN (dB)	ANTENNA HEIGHT (m)	TABLE ANGLE (Degree)	RAW VALUE (dBuV)	CORRECTION FACTOR (dB/m)
1	*5240.00	100.0 PK			1.05 H	198	95.50	4.50
2	*5240.00	89.9 AV			1.05 H	198	85.40	4.50
3	5350.00	56.1 PK	74.0	-17.9	1.05 H	198	51.70	4.40
4	5350.00	41.9 AV	54.0	-12.1	1.05 H	198	37.50	4.40
5	5400.00	53.2 PK	74.0	-20.8	1.05 H	198	48.50	4.70
6	5400.00	42.0 AV	54.0	-12.0	1.05 H	198	37.30	4.70
7	#10480.00	54.4 PK	74.0	-19.6	1.00 H	76	44.10	10.30
8	#10480.00	40.9 AV	54.0	-13.1	1.00 H	76	30.60	10.30
9	15720.00	62.1 PK	74.0	-11.9	1.02 H	185	47.40	14.70
10	15720.00	48.7 AV	54.0	-5.3	1.02 H	185	34.00	14.70

ANTENNA POLARITY & TEST DISTANCE: VERTICAL AT 3 M

NO.	FREQ. (MHz)	EMISSION LEVEL (dBuV/m)	LIMIT (dBuV/m)	MARGIN (dB)	ANTENNA HEIGHT (m)	TABLE ANGLE (Degree)	RAW VALUE (dBuV)	CORRECTION FACTOR (dB/m)
1	*5240.00	109.6 PK			1.02 V	184	105.10	4.50
2	*5240.00	100.9 AV			1.02 V	184	96.40	4.50
3	5350.00	56.7 PK	74.0	-17.3	1.02 V	184	52.30	4.40
4	5350.00	42.1 AV	54.0	-11.9	1.02 V	184	37.70	4.40
5	5400.00	59.8 PK	74.0	-14.2	1.00 V	183	55.10	4.70
6	5400.00	49.2 AV	54.0	-4.8	1.00 V	183	44.50	4.70
7	#10480.00	56.1 PK	74.0	-17.9	1.04 V	12	45.80	10.30
8	#10480.00	42.3 AV	54.0	-11.7	1.04 V	12	32.00	10.30
9	15720.00	60.9 PK	74.0	-13.1	1.00 V	230	46.20	14.70
10	15720.00	49.8 AV	54.0	-4.2	1.00 V	230	35.10	14.70

REMARKS:

1. Emission Level(dBuV/m) = Raw Value(dBuV) + Correction Factor(dB/m)
2. Correction Factor(dB/m) = Antenna Factor(dB/m) + Cable Factor(dB) – Pre-Amplifier Factor(dB)
3. The other emission levels were very low against the limit.
4. Margin value = Emission Level – Limit value
5. " * ": Fundamental frequency.
6. " # ": The radiated frequency is out of the restricted band.



A D T

802.11ac (VHT20), 1Tx

CHANNEL	TX Channel 36	DETECTOR FUNCTION	Peak (PK)
FREQUENCY RANGE	1GHz ~ 40GHz		Average (AV)

ANTENNA POLARITY & TEST DISTANCE: HORIZONTAL AT 3 M

NO.	FREQ. (MHz)	EMISSION LEVEL (dBuV/m)	LIMIT (dBuV/m)	MARGIN (dB)	ANTENNA HEIGHT (m)	TABLE ANGLE (Degree)	RAW VALUE (dBuV)	CORRECTION FACTOR (dB/m)
1	5000.00	53.3 PK	74.0	-20.7	1.08 H	345	49.50	3.80
2	5000.00	44.1 AV	54.0	-9.9	1.08 H	345	40.30	3.80
3	5093.00	51.2 PK	74.0	-22.8	1.10 H	302	47.10	4.10
4	5093.00	39.1 AV	54.0	-14.9	1.10 H	302	35.00	4.10
5	*5180.00	100.2 PK			1.10 H	302	95.80	4.40
6	*5180.00	90.1 AV			1.10 H	302	85.70	4.40
7	#10360.00	55.9 PK	74.0	-18.1	1.00 H	60	45.80	10.10
8	#10360.00	42.2 AV	54.0	-11.8	1.00 H	60	32.10	10.10
9	15540.00	62.3 PK	74.0	-11.7	1.03 H	171	47.50	14.80
10	15540.00	49.0 AV	54.0	-5.0	1.03 H	171	34.20	14.80

ANTENNA POLARITY & TEST DISTANCE: VERTICAL AT 3 M

NO.	FREQ. (MHz)	EMISSION LEVEL (dBuV/m)	LIMIT (dBuV/m)	MARGIN (dB)	ANTENNA HEIGHT (m)	TABLE ANGLE (Degree)	RAW VALUE (dBuV)	CORRECTION FACTOR (dB/m)
1	5000.00	57.2 PK	74.0	-16.8	1.16 V	19	53.40	3.80
2	5000.00	51.3 AV	54.0	-2.7	1.16 V	19	47.50	3.80
3	5093.00	54.8 PK	74.0	-19.2	1.01 V	17	50.70	4.10
4	5093.00	43.4 AV	54.0	-10.6	1.01 V	17	39.30	4.10
5	*5180.00	107.2 PK			1.01 V	17	102.80	4.40
6	*5180.00	98.0 AV			1.01 V	17	93.60	4.40
7	#10360.00	56.2 PK	74.0	-17.8	1.00 V	24	46.10	10.10
8	#10360.00	42.5 AV	54.0	-11.5	1.00 V	24	32.40	10.10
9	15540.00	60.9 PK	74.0	-13.1	1.00 V	218	46.10	14.80
10	15540.00	49.7 AV	54.0	-4.3	1.00 V	218	34.90	14.80

REMARKS:

1. Emission Level(dBuV/m) = Raw Value(dBuV) + Correction Factor(dB/m)
2. Correction Factor(dB/m) = Antenna Factor(dB/m) + Cable Factor(dB) – Pre-Amplifier Factor(dB)
3. The other emission levels were very low against the limit.
4. Margin value = Emission Level – Limit value
5. " * ": Fundamental frequency.
6. " # ": The radiated frequency is out of the restricted band.



A D T

CHANNEL	TX Channel 40	DETECTOR FUNCTION	Peak (PK)
FREQUENCY RANGE	1GHz ~ 40GHz		Average (AV)

ANTENNA POLARITY & TEST DISTANCE: HORIZONTAL AT 3 M

NO.	FREQ. (MHz)	EMISSION LEVEL (dBuV/m)	LIMIT (dBuV/m)	MARGIN (dB)	ANTENNA HEIGHT (m)	TABLE ANGLE (Degree)	RAW VALUE (dBuV)	CORRECTION FACTOR (dB/m)
1	5000.00	52.4 PK	74.0	-21.6	1.10 H	355	48.60	3.80
2	5000.00	43.7 AV	54.0	-10.3	1.10 H	355	39.90	3.80
3	5112.00	51.0 PK	74.0	-23.0	1.06 H	303	46.90	4.10
4	5112.00	38.9 AV	54.0	-15.1	1.06 H	303	34.80	4.10
5	*5200.00	99.6 PK			1.07 H	296	95.20	4.40
6	*5200.00	89.6 AV			1.07 H	296	85.20	4.40
7	#10400.00	56.0 PK	74.0	-18.0	1.05 H	50	46.00	10.00
8	#10400.00	42.3 AV	54.0	-11.7	1.05 H	50	32.30	10.00
9	15600.00	62.1 PK	74.0	-11.9	1.00 H	168	47.00	15.10
10	15600.00	48.6 AV	54.0	-5.4	1.00 H	168	33.50	15.10

ANTENNA POLARITY & TEST DISTANCE: VERTICAL AT 3 M

NO.	FREQ. (MHz)	EMISSION LEVEL (dBuV/m)	LIMIT (dBuV/m)	MARGIN (dB)	ANTENNA HEIGHT (m)	TABLE ANGLE (Degree)	RAW VALUE (dBuV)	CORRECTION FACTOR (dB/m)
1	5000.00	56.4 PK	74.0	-17.6	1.16 V	23	52.60	3.80
2	5000.00	49.8 AV	54.0	-4.2	1.16 V	23	46.00	3.80
3	5112.00	54.9 PK	74.0	-19.1	1.02 V	17	50.80	4.10
4	5112.00	43.0 AV	54.0	-11.0	1.02 V	17	38.90	4.10
5	*5200.00	107.3 PK			1.02 V	17	102.90	4.40
6	*5200.00	98.2 AV			1.02 V	17	93.80	4.40
7	#10400.00	55.8 PK	74.0	-18.2	1.00 V	12	45.80	10.00
8	#10400.00	42.0 AV	54.0	-12.0	1.00 V	12	32.00	10.00
9	15600.00	60.4 PK	74.0	-13.6	1.02 V	211	45.30	15.10
10	15600.00	49.3 AV	54.0	-4.7	1.02 V	211	34.20	15.10

REMARKS:

1. Emission Level(dBuV/m) = Raw Value(dBuV) + Correction Factor(dB/m)
2. Correction Factor(dB/m) = Antenna Factor(dB/m) + Cable Factor(dB) – Pre-Amplifier Factor(dB)
3. The other emission levels were very low against the limit.
4. Margin value = Emission Level – Limit value
5. " * ": Fundamental frequency.
6. " # ": The radiated frequency is out of the restricted band.



A D T

CHANNEL	TX Channel 48	DETECTOR FUNCTION	Peak (PK)
FREQUENCY RANGE	1GHz ~ 40GHz		Average (AV)

ANTENNA POLARITY & TEST DISTANCE: HORIZONTAL AT 3 M

NO.	FREQ. (MHz)	EMISSION LEVEL (dBuV/m)	LIMIT (dBuV/m)	MARGIN (dB)	ANTENNA HEIGHT (m)	TABLE ANGLE (Degree)	RAW VALUE (dBuV)	CORRECTION FACTOR (dB/m)
1	5080.00	50.4 PK	74.0	-23.6	1.01 H	310	46.30	4.10
2	5080.00	38.2 AV	54.0	-15.8	1.01 H	310	34.10	4.10
3	*5240.00	98.4 PK			1.01 H	310	93.90	4.50
4	*5240.00	88.5 AV			1.01 H	310	84.00	4.50
5	5350.00	56.5 PK	74.0	-17.5	1.01 H	310	52.10	4.40
6	5350.00	41.7 AV	54.0	-12.3	1.01 H	310	37.30	4.40
7	5399.00	53.0 PK	74.0	-21.0	1.01 H	310	48.30	4.70
8	5399.00	41.9 AV	54.0	-12.1	1.01 H	310	37.20	4.70
9	#10480.00	56.2 PK	74.0	-17.8	1.11 H	45	45.90	10.30
10	#10480.00	42.4 AV	54.0	-11.6	1.11 H	45	32.10	10.30
11	15720.00	62.2 PK	74.0	-11.8	1.01 H	156	47.50	14.70
12	15720.00	49.1 AV	54.0	-4.9	1.01 H	156	34.40	14.70

ANTENNA POLARITY & TEST DISTANCE: VERTICAL AT 3 M

NO.	FREQ. (MHz)	EMISSION LEVEL (dBuV/m)	LIMIT (dBuV/m)	MARGIN (dB)	ANTENNA HEIGHT (m)	TABLE ANGLE (Degree)	RAW VALUE (dBuV)	CORRECTION FACTOR (dB/m)
1	5080.00	54.1 PK	74.0	-19.9	1.11 V	15	50.00	4.10
2	5080.00	42.7 AV	54.0	-11.3	1.11 V	15	38.60	4.10
3	*5240.00	106.2 PK			1.11 V	15	101.70	4.50
4	*5240.00	97.8 AV			1.11 V	15	93.30	4.50
5	5350.00	56.7 PK	74.0	-17.3	1.11 V	15	52.30	4.40
6	5350.00	41.8 AV	54.0	-12.2	1.11 V	15	37.40	4.40
7	5399.00	54.5 PK	74.0	-19.5	1.18 V	13	49.80	4.70
8	5399.00	43.4 AV	54.0	-10.6	1.18 V	13	38.70	4.70
9	#10480.00	55.9 PK	74.0	-18.1	1.00 V	15	45.60	10.30
10	#10480.00	41.8 AV	54.0	-12.2	1.00 V	15	31.50	10.30
11	15720.00	61.0 PK	74.0	-13.0	1.00 V	195	46.30	14.70
12	15720.00	49.8 AV	54.0	-4.2	1.00 V	195	35.10	14.70

REMARKS:

1. Emission Level(dBuV/m) = Raw Value(dBuV) + Correction Factor(dB/m)
2. Correction Factor(dB/m) = Antenna Factor(dB/m) + Cable Factor(dB) – Pre-Amplifier Factor(dB)
3. The other emission levels were very low against the limit.
4. Margin value = Emission Level – Limit value
5. " * ": Fundamental frequency.
6. " # ": The radiated frequency is out of the restricted band.



A D T

802.11ac (VHT40), 1Tx

CHANNEL	TX Channel 38	DETECTOR FUNCTION	Peak (PK)
FREQUENCY RANGE	1GHz ~ 40GHz		Average (AV)

ANTENNA POLARITY & TEST DISTANCE: HORIZONTAL AT 3 M

NO.	FREQ. (MHz)	EMISSION LEVEL (dBuV/m)	LIMIT (dBuV/m)	MARGIN (dB)	ANTENNA HEIGHT (m)	TABLE ANGLE (Degree)	RAW VALUE (dBuV)	CORRECTION FACTOR (dB/m)
1	5150.00	50.8 PK	74.0	-23.2	1.00 H	289	46.50	4.30
2	5150.00	38.6 AV	54.0	-15.4	1.00 H	289	34.30	4.30
3	*5190.00	98.1 PK			1.00 H	289	93.70	4.40
4	*5190.00	87.4 AV			1.00 H	289	83.00	4.40
5	#10380.00	55.6 PK	74.0	-18.4	1.08 H	37	45.50	10.10
6	#10380.00	41.8 AV	54.0	-12.2	1.08 H	37	31.70	10.10
7	15570.00	62.2 PK	74.0	-11.8	1.06 H	143	47.30	14.90
8	15570.00	49.0 AV	54.0	-5.0	1.06 H	143	34.10	14.90

ANTENNA POLARITY & TEST DISTANCE: VERTICAL AT 3 M

NO.	FREQ. (MHz)	EMISSION LEVEL (dBuV/m)	LIMIT (dBuV/m)	MARGIN (dB)	ANTENNA HEIGHT (m)	TABLE ANGLE (Degree)	RAW VALUE (dBuV)	CORRECTION FACTOR (dB/m)
1	5150.00	55.7 PK	74.0	-18.3	1.06 V	13	51.40	4.30
2	5150.00	42.8 AV	54.0	-11.2	1.06 V	13	38.50	4.30
3	*5190.00	105.1 PK			1.06 V	13	100.70	4.40
4	*5190.00	95.6 AV			1.06 V	13	91.20	4.40
5	#10380.00	55.8 PK	74.0	-18.2	1.00 V	0	45.70	10.10
6	#10380.00	41.7 AV	54.0	-12.3	1.00 V	0	31.60	10.10
7	15570.00	60.5 PK	74.0	-13.5	1.03 V	205	45.60	14.90
8	15570.00	49.4 AV	54.0	-4.6	1.03 V	205	34.50	14.90

REMARKS:

1. Emission Level(dBuV/m) = Raw Value(dBuV) + Correction Factor(dB/m)
2. Correction Factor(dB/m) = Antenna Factor(dB/m) + Cable Factor(dB) – Pre-Amplifier Factor(dB)
3. The other emission levels were very low against the limit.
4. Margin value = Emission Level – Limit value
5. " * ": Fundamental frequency.
6. " # ": The radiated frequency is out of the restricted band.



A D T

CHANNEL	TX Channel 46	DETECTOR FUNCTION	Peak (PK)
FREQUENCY RANGE	1GHz ~ 40GHz		Average (AV)

ANTENNA POLARITY & TEST DISTANCE: HORIZONTAL AT 3 M

NO.	FREQ. (MHz)	EMISSION LEVEL (dBuV/m)	LIMIT (dBuV/m)	MARGIN (dB)	ANTENNA HEIGHT (m)	TABLE ANGLE (Degree)	RAW VALUE (dBuV)	CORRECTION FACTOR (dB/m)
1	5000.00	51.0 PK	74.0	-23.0	1.00 H	280	47.20	3.80
2	5000.00	39.0 AV	54.0	-15.0	1.00 H	280	35.20	3.80
3	*5230.00	98.4 PK			1.00 H	280	93.90	4.50
4	*5230.00	87.4 AV			1.00 H	280	82.90	4.50
5	5350.00	56.8 PK	74.0	-17.2	1.00 H	280	52.40	4.40
6	5350.00	42.5 AV	54.0	-11.5	1.00 H	280	38.10	4.40
7	#10460.00	55.9 PK	74.0	-18.1	1.04 H	26	45.70	10.20
8	#10460.00	42.3 AV	54.0	-11.7	1.04 H	26	32.10	10.20
9	15690.00	62.5 PK	74.0	-11.5	1.02 H	148	47.80	14.70
10	15690.00	49.2 AV	54.0	-4.8	1.02 H	148	34.50	14.70

ANTENNA POLARITY & TEST DISTANCE: VERTICAL AT 3 M

NO.	FREQ. (MHz)	EMISSION LEVEL (dBuV/m)	LIMIT (dBuV/m)	MARGIN (dB)	ANTENNA HEIGHT (m)	TABLE ANGLE (Degree)	RAW VALUE (dBuV)	CORRECTION FACTOR (dB/m)
1	5000.00	58.0 PK	74.0	-16.0	1.08 V	15	54.20	3.80
2	5000.00	51.7 AV	54.0	-2.3	1.08 V	15	47.90	3.80
3	*5230.00	105.2 PK			1.06 V	8	100.70	4.50
4	*5230.00	95.8 AV			1.06 V	8	91.30	4.50
5	5350.00	56.2 PK	74.0	-17.8	1.08 V	15	51.80	4.40
6	5350.00	42.6 AV	54.0	-11.4	1.08 V	15	38.20	4.40
7	#10460.00	56.5 PK	74.0	-17.5	1.04 V	16	46.30	10.20
8	#10460.00	42.1 AV	54.0	-11.9	1.04 V	16	31.90	10.20
9	15690.00	60.7 PK	74.0	-13.3	1.04 V	211	46.00	14.70
10	15690.00	49.5 AV	54.0	-4.5	1.04 V	211	34.80	14.70

REMARKS:

1. Emission Level(dBuV/m) = Raw Value(dBuV) + Correction Factor(dB/m)
2. Correction Factor(dB/m) = Antenna Factor(dB/m) + Cable Factor(dB) – Pre-Amplifier Factor(dB)
3. The other emission levels were very low against the limit.
4. Margin value = Emission Level – Limit value
5. " * ": Fundamental frequency.
6. " # ": The radiated frequency is out of the restricted band.



802.11ac (VHT80), 1Tx

CHANNEL	TX Channel 42	DETECTOR FUNCTION	Peak (PK)
FREQUENCY RANGE	1GHz ~ 40GHz		Average (AV)

ANTENNA POLARITY & TEST DISTANCE: HORIZONTAL AT 3 M

NO.	FREQ. (MHz)	EMISSION LEVEL (dBuV/m)	LIMIT (dBuV/m)	MARGIN (dB)	ANTENNA HEIGHT (m)	TABLE ANGLE (Degree)	RAW VALUE (dBuV)	CORRECTION FACTOR (dB/m)
1	5150.00	50.9 PK	74.0	-23.1	1.01 H	267	46.60	4.30
2	5150.00	38.8 AV	54.0	-15.2	1.01 H	267	34.50	4.30
3	*5210.00	96.1 PK			1.01 H	267	91.60	4.50
4	*5210.00	85.1 AV			1.01 H	267	80.60	4.50
5	5350.00	56.6 PK	74.0	-17.4	1.01 H	267	52.20	4.40
6	5350.00	42.2 AV	54.0	-11.8	1.01 H	267	37.80	4.40
7	#10420.00	55.5 PK	74.0	-18.5	1.00 H	38	45.40	10.10
8	#10420.00	41.8 AV	54.0	-12.2	1.00 H	38	31.70	10.10
9	15630.00	62.8 PK	74.0	-11.2	1.03 H	157	47.90	14.90
10	15630.00	49.5 AV	54.0	-4.5	1.03 H	157	34.60	14.90

ANTENNA POLARITY & TEST DISTANCE: VERTICAL AT 3 M

NO.	FREQ. (MHz)	EMISSION LEVEL (dBuV/m)	LIMIT (dBuV/m)	MARGIN (dB)	ANTENNA HEIGHT (m)	TABLE ANGLE (Degree)	RAW VALUE (dBuV)	CORRECTION FACTOR (dB/m)
1	5150.00	54.6 PK	74.0	-19.4	1.14 V	8	50.30	4.30
2	5150.00	43.5 AV	54.0	-10.5	1.14 V	8	39.20	4.30
3	*5210.00	103.0 PK			1.14 V	8	98.50	4.50
4	*5210.00	93.0 AV			1.14 V	8	88.50	4.50
5	5350.00	56.8 PK	74.0	-17.2	1.14 V	8	52.40	4.40
6	5350.00	42.8 AV	54.0	-11.2	1.14 V	8	38.40	4.40
7	#10420.00	56.7 PK	74.0	-17.3	1.03 V	20	46.60	10.10
8	#10420.00	42.4 AV	54.0	-11.6	1.03 V	20	32.30	10.10
9	15630.00	60.3 PK	74.0	-13.7	1.00 V	225	45.40	14.90
10	15630.00	48.8 AV	54.0	-5.2	1.00 V	225	33.90	14.90

REMARKS:

1. Emission Level(dBuV/m) = Raw Value(dBuV) + Correction Factor(dB/m)
2. Correction Factor(dB/m) = Antenna Factor(dB/m) + Cable Factor(dB) – Pre-Amplifier Factor(dB)
3. The other emission levels were very low against the limit.
4. Margin value = Emission Level – Limit value
5. " * ": Fundamental frequency.
6. " # ": The radiated frequency is out of the restricted band.



A D T

802.11ac (VHT20), 2Tx

CHANNEL	TX Channel 36	DETECTOR FUNCTION	Peak (PK)
FREQUENCY RANGE	1GHz ~ 40GHz		Average (AV)

ANTENNA POLARITY & TEST DISTANCE: HORIZONTAL AT 3 M

NO.	FREQ. (MHz)	EMISSION LEVEL (dBuV/m)	LIMIT (dBuV/m)	MARGIN (dB)	ANTENNA HEIGHT (m)	TABLE ANGLE (Degree)	RAW VALUE (dBuV)	CORRECTION FACTOR (dB/m)
1	5000.00	52.6 PK	74.0	-21.4	1.10 H	343	48.80	3.80
2	5000.00	40.2 AV	54.0	-13.8	1.10 H	343	36.40	3.80
3	*5180.00	101.4 PK			1.02 H	172	97.00	4.40
4	*5180.00	92.6 AV			1.02 H	172	88.20	4.40
5	#10360.00	55.5 PK	74.0	-18.5	1.02 H	56	45.40	10.10
6	#10360.00	41.7 AV	54.0	-12.3	1.02 H	56	31.60	10.10
7	15540.00	62.2 PK	74.0	-11.8	1.00 H	212	47.40	14.80
8	15540.00	49.0 AV	54.0	-5.0	1.00 H	212	34.20	14.80

ANTENNA POLARITY & TEST DISTANCE: VERTICAL AT 3 M

NO.	FREQ. (MHz)	EMISSION LEVEL (dBuV/m)	LIMIT (dBuV/m)	MARGIN (dB)	ANTENNA HEIGHT (m)	TABLE ANGLE (Degree)	RAW VALUE (dBuV)	CORRECTION FACTOR (dB/m)
1	5000.00	54.9 PK	74.0	-19.1	1.14 V	168	51.10	3.80
2	5000.00	43.8 AV	54.0	-10.2	1.14 V	168	40.00	3.80
3	*5180.00	105.9 PK			1.04 V	187	101.50	4.40
4	*5180.00	96.9 AV			1.04 V	187	92.50	4.40
5	#10360.00	53.8 PK	74.0	-20.2	1.10 V	4	43.70	10.10
6	#10360.00	40.9 AV	54.0	-13.1	1.10 V	4	30.80	10.10
7	15540.00	59.2 PK	74.0	-14.8	1.00 V	206	44.40	14.80
8	15540.00	49.2 AV	54.0	-4.8	1.00 V	206	34.40	14.80

REMARKS:

1. Emission Level(dBuV/m) = Raw Value(dBuV) + Correction Factor(dB/m)
2. Correction Factor(dB/m) = Antenna Factor(dB/m) + Cable Factor(dB) – Pre-Amplifier Factor(dB)
3. The other emission levels were very low against the limit.
4. Margin value = Emission Level – Limit value
5. " * ": Fundamental frequency.
6. " # ": The radiated frequency is out of the restricted band.



A D T

CHANNEL	TX Channel 40	DETECTOR FUNCTION	Peak (PK)
FREQUENCY RANGE	1GHz ~ 40GHz		Average (AV)

ANTENNA POLARITY & TEST DISTANCE: HORIZONTAL AT 3 M

NO.	FREQ. (MHz)	EMISSION LEVEL (dBuV/m)	LIMIT (dBuV/m)	MARGIN (dB)	ANTENNA HEIGHT (m)	TABLE ANGLE (Degree)	RAW VALUE (dBuV)	CORRECTION FACTOR (dB/m)
1	*5200.00	101.7 PK			1.00 H	180	97.30	4.40
2	*5200.00	92.6 AV			1.00 H	180	88.20	4.40
3	#10400.00	55.5 PK	74.0	-18.5	1.06 H	45	45.50	10.00
4	#10400.00	42.0 AV	54.0	-12.0	1.06 H	45	32.00	10.00
5	15600.00	62.3 PK	74.0	-11.7	1.00 H	210	47.20	15.10
6	15600.00	48.9 AV	54.0	-5.1	1.00 H	210	33.80	15.10

ANTENNA POLARITY & TEST DISTANCE: VERTICAL AT 3 M

NO.	FREQ. (MHz)	EMISSION LEVEL (dBuV/m)	LIMIT (dBuV/m)	MARGIN (dB)	ANTENNA HEIGHT (m)	TABLE ANGLE (Degree)	RAW VALUE (dBuV)	CORRECTION FACTOR (dB/m)
1	*5200.00	105.2 PK			1.00 V	185	100.80	4.40
2	*5200.00	96.4 AV			1.00 V	185	92.00	4.40
3	#10400.00	53.8 PK	74.0	-20.2	1.08 V	6	43.80	10.00
4	#10400.00	40.9 AV	54.0	-13.1	1.08 V	6	30.90	10.00
5	15600.00	59.8 PK	74.0	-14.2	1.00 V	202	44.70	15.10
6	15600.00	49.7 AV	54.0	-4.3	1.00 V	202	34.60	15.10

REMARKS:

1. Emission Level(dBuV/m) = Raw Value(dBuV) + Correction Factor(dB/m)
2. Correction Factor(dB/m) = Antenna Factor(dB/m) + Cable Factor(dB) – Pre-Amplifier Factor(dB)
3. The other emission levels were very low against the limit.
4. Margin value = Emission Level – Limit value
5. " * ": Fundamental frequency.
6. " # ": The radiated frequency is out of the restricted band.



A D T

CHANNEL	TX Channel 48	DETECTOR FUNCTION	Peak (PK)
FREQUENCY RANGE	1GHz ~ 40GHz		Average (AV)

ANTENNA POLARITY & TEST DISTANCE: HORIZONTAL AT 3 M

NO.	FREQ. (MHz)	EMISSION LEVEL (dBuV/m)	LIMIT (dBuV/m)	MARGIN (dB)	ANTENNA HEIGHT (m)	TABLE ANGLE (Degree)	RAW VALUE (dBuV)	CORRECTION FACTOR (dB/m)
1	*5240.00	105.6 PK			1.00 H	174	101.10	4.50
2	*5240.00	95.4 AV			1.00 H	174	90.90	4.50
3	5350.00	56.1 PK	74.0	-17.9	1.00 H	174	51.70	4.40
4	5350.00	42.7 AV	54.0	-11.3	1.00 H	174	38.30	4.40
5	#10480.00	55.7 PK	74.0	-18.3	1.05 H	42	45.40	10.30
6	#10480.00	42.0 AV	54.0	-12.0	1.05 H	42	31.70	10.30
7	15720.00	62.3 PK	74.0	-11.7	1.00 H	215	47.60	14.70
8	15720.00	49.0 AV	54.0	-5.0	1.00 H	215	34.30	14.70

ANTENNA POLARITY & TEST DISTANCE: VERTICAL AT 3 M

NO.	FREQ. (MHz)	EMISSION LEVEL (dBuV/m)	LIMIT (dBuV/m)	MARGIN (dB)	ANTENNA HEIGHT (m)	TABLE ANGLE (Degree)	RAW VALUE (dBuV)	CORRECTION FACTOR (dB/m)
1	*5240.00	108.8 PK			1.02 V	187	104.30	4.50
2	*5240.00	99.6 AV			1.02 V	187	95.10	4.50
3	5350.00	56.7 PK	74.0	-17.3	1.02 V	187	52.30	4.40
4	5350.00	42.8 AV	54.0	-11.2	1.02 V	187	38.40	4.40
5	#10480.00	53.9 PK	74.0	-20.1	1.07 V	12	43.60	10.30
6	#10480.00	41.3 AV	54.0	-12.7	1.07 V	12	31.00	10.30
7	15720.00	60.0 PK	74.0	-14.0	1.06 V	194	45.30	14.70
8	15720.00	49.8 AV	54.0	-4.2	1.06 V	194	35.10	14.70

REMARKS:

1. Emission Level(dBuV/m) = Raw Value(dBuV) + Correction Factor(dB/m)
2. Correction Factor(dB/m) = Antenna Factor(dB/m) + Cable Factor(dB) – Pre-Amplifier Factor(dB)
3. The other emission levels were very low against the limit.
4. Margin value = Emission Level – Limit value
5. " * ": Fundamental frequency.
6. " # ": The radiated frequency is out of the restricted band.



A D T

802.11ac (VHT40), 2Tx

CHANNEL	TX Channel 38	DETECTOR FUNCTION	Peak (PK)
FREQUENCY RANGE	1GHz ~ 40GHz		Average (AV)

ANTENNA POLARITY & TEST DISTANCE: HORIZONTAL AT 3 M

NO.	FREQ. (MHz)	EMISSION LEVEL (dBuV/m)	LIMIT (dBuV/m)	MARGIN (dB)	ANTENNA HEIGHT (m)	TABLE ANGLE (Degree)	RAW VALUE (dBuV)	CORRECTION FACTOR (dB/m)
1	5120.00	52.8 PK	74.0	-21.2	1.01 H	175	48.70	4.10
2	5120.00	40.6 AV	54.0	-13.4	1.01 H	175	36.50	4.10
3	*5190.00	102.1 PK			1.01 H	175	97.70	4.40
4	*5190.00	91.1 AV			1.01 H	175	86.70	4.40
5	#10380.00	56.2 PK	74.0	-17.8	1.07 H	57	46.10	10.10
6	#10380.00	42.3 AV	54.0	-11.7	1.07 H	57	32.20	10.10
7	15570.00	62.0 PK	74.0	-12.0	1.05 H	221	47.10	14.90
8	15570.00	48.9 AV	54.0	-5.1	1.05 H	221	34.00	14.90

ANTENNA POLARITY & TEST DISTANCE: VERTICAL AT 3 M

NO.	FREQ. (MHz)	EMISSION LEVEL (dBuV/m)	LIMIT (dBuV/m)	MARGIN (dB)	ANTENNA HEIGHT (m)	TABLE ANGLE (Degree)	RAW VALUE (dBuV)	CORRECTION FACTOR (dB/m)
1	5120.00	54.4 PK	74.0	-19.6	1.04 V	185	50.30	4.10
2	5120.00	43.7 AV	54.0	-10.3	1.04 V	185	39.60	4.10
3	*5190.00	105.4 PK			1.04 V	185	101.00	4.40
4	*5190.00	95.3 AV			1.04 V	185	90.90	4.40
5	#10380.00	54.2 PK	74.0	-19.8	1.07 V	26	44.10	10.10
6	#10380.00	41.5 AV	54.0	-12.5	1.07 V	26	31.40	10.10
7	15570.00	60.1 PK	74.0	-13.9	1.05 V	197	45.20	14.90
8	15570.00	50.2 AV	54.0	-3.8	1.05 V	197	35.30	14.90

REMARKS:

1. Emission Level(dBuV/m) = Raw Value(dBuV) + Correction Factor(dB/m)
2. Correction Factor(dB/m) = Antenna Factor(dB/m) + Cable Factor(dB) – Pre-Amplifier Factor(dB)
3. The other emission levels were very low against the limit.
4. Margin value = Emission Level – Limit value
5. " * ": Fundamental frequency.
6. " # ": The radiated frequency is out of the restricted band.



A D T

CHANNEL	TX Channel 46	DETECTOR FUNCTION	Peak (PK)
FREQUENCY RANGE	1GHz ~ 40GHz		Average (AV)

ANTENNA POLARITY & TEST DISTANCE: HORIZONTAL AT 3 M

NO.	FREQ. (MHz)	EMISSION LEVEL (dBuV/m)	LIMIT (dBuV/m)	MARGIN (dB)	ANTENNA HEIGHT (m)	TABLE ANGLE (Degree)	RAW VALUE (dBuV)	CORRECTION FACTOR (dB/m)
1	*5230.00	101.9 PK			1.00 H	168	97.40	4.50
2	*5230.00	90.7 AV			1.00 H	168	86.20	4.50
3	5350.00	56.7 PK	74.0	-17.3	1.00 H	168	52.30	4.40
4	5350.00	42.8 AV	54.0	-11.2	1.00 H	168	38.40	4.40
5	#10460.00	55.8 PK	74.0	-18.2	1.10 H	57	45.60	10.20
6	#10460.00	42.1 AV	54.0	-11.9	1.10 H	57	31.90	10.20
7	15690.00	62.5 PK	74.0	-11.5	1.08 H	236	47.80	14.70
8	15690.00	49.3 AV	54.0	-4.7	1.08 H	236	34.60	14.70

ANTENNA POLARITY & TEST DISTANCE: VERTICAL AT 3 M

NO.	FREQ. (MHz)	EMISSION LEVEL (dBuV/m)	LIMIT (dBuV/m)	MARGIN (dB)	ANTENNA HEIGHT (m)	TABLE ANGLE (Degree)	RAW VALUE (dBuV)	CORRECTION FACTOR (dB/m)
1	*5230.00	105.9 PK			1.03 V	188	101.40	4.50
2	*5230.00	95.6 AV			1.03 V	188	91.10	4.50
3	5350.00	56.8 PK	74.0	-17.2	1.03 V	188	52.40	4.40
4	5350.00	42.8 AV	54.0	-11.2	1.03 V	188	38.40	4.40
5	#10460.00	54.4 PK	74.0	-19.6	1.04 V	34	44.20	10.20
6	#10460.00	41.7 AV	54.0	-12.3	1.04 V	34	31.50	10.20
7	15690.00	60.8 PK	74.0	-13.2	1.05 V	198	46.10	14.70
8	15690.00	50.7 AV	54.0	-3.3	1.05 V	198	36.00	14.70

REMARKS:

1. Emission Level(dBuV/m) = Raw Value(dBuV) + Correction Factor(dB/m)
2. Correction Factor(dB/m) = Antenna Factor(dB/m) + Cable Factor(dB) – Pre-Amplifier Factor(dB)
3. The other emission levels were very low against the limit.
4. Margin value = Emission Level – Limit value
5. " * ": Fundamental frequency.
6. " # ": The radiated frequency is out of the restricted band.



802.11ac (VHT80), 2Tx

CHANNEL	TX Channel 42	DETECTOR FUNCTION	Peak (PK)
FREQUENCY RANGE	1GHz ~ 40GHz		Average (AV)

ANTENNA POLARITY & TEST DISTANCE: HORIZONTAL AT 3 M

NO.	FREQ. (MHz)	EMISSION LEVEL (dBuV/m)	LIMIT (dBuV/m)	MARGIN (dB)	ANTENNA HEIGHT (m)	TABLE ANGLE (Degree)	RAW VALUE (dBuV)	CORRECTION FACTOR (dB/m)
1	5150.00	52.7 PK	74.0	-21.3	1.02 H	169	48.40	4.30
2	5150.00	40.5 AV	54.0	-13.5	1.02 H	169	36.20	4.30
3	*5210.00	99.2 PK			1.02 H	169	94.70	4.50
4	*5210.00	88.0 AV			1.02 H	169	83.50	4.50
5	5350.00	56.4 PK	74.0	-17.6	1.02 H	169	52.00	4.40
6	5350.00	41.7 AV	54.0	-12.3	1.02 H	169	37.30	4.40
7	#10420.00	56.0 PK	74.0	-18.0	1.13 H	43	45.90	10.10
8	#10420.00	42.6 AV	54.0	-11.4	1.13 H	43	32.50	10.10
9	15630.00	62.3 PK	74.0	-11.7	1.08 H	238	47.40	14.90
10	15630.00	49.3 AV	54.0	-4.7	1.08 H	238	34.40	14.90

ANTENNA POLARITY & TEST DISTANCE: VERTICAL AT 3 M

NO.	FREQ. (MHz)	EMISSION LEVEL (dBuV/m)	LIMIT (dBuV/m)	MARGIN (dB)	ANTENNA HEIGHT (m)	TABLE ANGLE (Degree)	RAW VALUE (dBuV)	CORRECTION FACTOR (dB/m)
1	5150.00	54.3 PK	74.0	-19.7	1.03 V	176	50.00	4.30
2	5150.00	44.2 AV	54.0	-9.8	1.03 V	176	39.90	4.30
3	*5210.00	102.8 PK			1.03 V	176	98.30	4.50
4	*5210.00	92.8 AV			1.03 V	176	88.30	4.50
5	5350.00	56.7 PK	74.0	-17.3	1.03 V	176	52.30	4.40
6	5350.00	41.8 AV	54.0	-12.2	1.03 V	176	37.40	4.40
7	#10420.00	54.3 PK	74.0	-19.7	1.00 V	22	44.20	10.10
8	#10420.00	41.4 AV	54.0	-12.6	1.00 V	22	31.30	10.10
9	15630.00	61.1 PK	74.0	-12.9	1.06 V	195	46.20	14.90
10	15630.00	50.9 AV	54.0	-3.1	1.06 V	195	36.00	14.90

REMARKS:

1. Emission Level(dBuV/m) = Raw Value(dBuV) + Correction Factor(dB/m)
2. Correction Factor(dB/m) = Antenna Factor(dB/m) + Cable Factor(dB) – Pre-Amplifier Factor(dB)
3. The other emission levels were very low against the limit.
4. Margin value = Emission Level – Limit value
5. " * ": Fundamental frequency.
6. " # ": The radiated frequency is out of the restricted band.



A D T

4.2.9 TEST RESULTS (MODE 2)

BELOW 1GHz WORST-CASE DATA

802.11ac (VHT40), 2Tx

CHANNEL	TX Channel 46	DETECTOR FUNCTION	Quasi-Peak (QP)
FREQUENCY RANGE	Below 1GHz		

ANTENNA POLARITY & TEST DISTANCE: HORIZONTAL AT 3 M

NO.	FREQ. (MHz)	EMISSION LEVEL (dBuV/m)	LIMIT (dBuV/m)	MARGIN (dB)	ANTENNA HEIGHT (m)	TABLE ANGLE (Degree)	RAW VALUE (dBuV)	CORRECTION FACTOR (dB/m)
1	86.86	32.1 QP	40.0	-7.9	2.00 H	82	51.16	-19.04
2	97.15	36.7 QP	43.5	-6.8	2.00 H	22	55.13	-18.41
3	125.02	40.0 QP	43.5	-3.5	2.00 H	327	54.88	-14.92
4	148.36	35.6 QP	43.5	-7.9	2.00 H	82	48.77	-13.15
5	250.00	40.5 QP	46.0	-5.5	1.00 H	70	54.84	-14.32
6	362.52	39.1 QP	46.0	-6.9	1.00 H	85	49.85	-10.73

ANTENNA POLARITY & TEST DISTANCE: VERTICAL AT 3 M

NO.	FREQ. (MHz)	EMISSION LEVEL (dBuV/m)	LIMIT (dBuV/m)	MARGIN (dB)	ANTENNA HEIGHT (m)	TABLE ANGLE (Degree)	RAW VALUE (dBuV)	CORRECTION FACTOR (dB/m)
1	38.82	36.6 QP	40.0	-3.4	1.00 V	52	50.47	-13.85
2	43.59	35.3 QP	40.0	-4.7	1.00 V	72	48.81	-13.49
3	66.50	34.3 QP	40.0	-5.7	1.00 V	101	49.33	-14.99
4	80.32	36.1 QP	40.0	-3.9	1.00 V	101	54.39	-18.25
5	125.00	40.5 QP	43.5	-3.0	1.00 V	238	55.38	-14.92
6	440.02	38.3 QP	46.0	-7.7	1.00 V	18	46.72	-8.44

REMARKS:

1. Emission Level(dBuV/m) = Raw Value(dBuV) + Correction Factor(dB/m)
2. Correction Factor(dB/m) = Antenna Factor(dB/m) + Cable Factor(dB) – Pre-Amplifier Factor(dB)
3. The other emission levels were very low against the limit.
4. Margin value = Emission Level – Limit value



ABOVE 1GHz DATA

802.11a, 1Tx

CHANNEL	TX Channel 36	DETECTOR FUNCTION	Peak (PK)
FREQUENCY RANGE	1GHz ~ 40GHz		Average (AV)

ANTENNA POLARITY & TEST DISTANCE: HORIZONTAL AT 3 M

NO.	FREQ. (MHz)	EMISSION LEVEL (dBuV/m)	LIMIT (dBuV/m)	MARGIN (dB)	ANTENNA HEIGHT (m)	TABLE ANGLE (Degree)	RAW VALUE (dBuV)	CORRECTION FACTOR (dB/m)
1	5150.00	51.2 PK	74.0	-22.8	1.20 H	77	46.90	4.30
2	5150.00	39.3 AV	54.0	-14.7	1.20 H	77	35.00	4.30
3	*5180.00	95.9 PK			1.20 H	77	91.50	4.40
4	*5180.00	86.9 AV			1.20 H	77	82.50	4.40
5	#10360.00	52.7 PK	74.0	-21.3	1.00 H	76	42.60	10.10
6	#10360.00	39.6 AV	54.0	-14.4	1.00 H	76	29.50	10.10
7	15540.00	59.0 PK	74.0	-15.0	1.01 H	279	44.20	14.80
8	15540.00	46.6 AV	54.0	-7.4	1.01 H	279	31.80	14.80

ANTENNA POLARITY & TEST DISTANCE: VERTICAL AT 3 M

NO.	FREQ. (MHz)	EMISSION LEVEL (dBuV/m)	LIMIT (dBuV/m)	MARGIN (dB)	ANTENNA HEIGHT (m)	TABLE ANGLE (Degree)	RAW VALUE (dBuV)	CORRECTION FACTOR (dB/m)
1	5150.00	50.4 PK	74.0	-23.6	1.00 V	308	46.10	4.30
2	5150.00	40.7 AV	54.0	-13.3	1.00 V	308	36.40	4.30
3	*5180.00	100.7 PK			1.00 V	308	96.30	4.40
4	*5180.00	93.0 AV			1.00 V	308	88.60	4.40
5	#10360.00	55.3 PK	74.0	-18.7	1.00 V	196	45.20	10.10
6	#10360.00	40.8 AV	54.0	-13.2	1.00 V	196	30.70	10.10
7	15540.00	58.1 PK	74.0	-15.9	1.06 V	120	43.30	14.80
8	15540.00	46.1 AV	54.0	-7.9	1.06 V	120	31.30	14.80

REMARKS:

1. Emission Level(dBuV/m) = Raw Value(dBuV) + Correction Factor(dB/m)
2. Correction Factor(dB/m) = Antenna Factor(dB/m) + Cable Factor(dB) – Pre-Amplifier Factor(dB)
3. The other emission levels were very low against the limit.
4. Margin value = Emission Level – Limit value
5. " * ": Fundamental frequency.
6. " # ": The radiated frequency is out of the restricted band.



A D T

CHANNEL	TX Channel 40	DETECTOR FUNCTION	Peak (PK)
FREQUENCY RANGE	1GHz ~ 40GHz		Average (AV)

ANTENNA POLARITY & TEST DISTANCE: HORIZONTAL AT 3 M

NO.	FREQ. (MHz)	EMISSION LEVEL (dBuV/m)	LIMIT (dBuV/m)	MARGIN (dB)	ANTENNA HEIGHT (m)	TABLE ANGLE (Degree)	RAW VALUE (dBuV)	CORRECTION FACTOR (dB/m)
1	*5200.00	95.3 PK			1.13 H	67	90.90	4.40
2	*5200.00	86.3 AV			1.13 H	67	81.90	4.40
3	#10400.00	53.4 PK	74.0	-20.6	1.03 H	89	43.40	10.00
4	#10400.00	40.5 AV	54.0	-13.5	1.03 H	89	30.50	10.00
5	15600.00	59.3 PK	74.0	-14.7	1.00 H	293	44.20	15.10
6	15600.00	46.8 AV	54.0	-7.2	1.00 H	293	31.70	15.10

ANTENNA POLARITY & TEST DISTANCE: VERTICAL AT 3 M

NO.	FREQ. (MHz)	EMISSION LEVEL (dBuV/m)	LIMIT (dBuV/m)	MARGIN (dB)	ANTENNA HEIGHT (m)	TABLE ANGLE (Degree)	RAW VALUE (dBuV)	CORRECTION FACTOR (dB/m)
1	*5200.00	100.7 PK			1.00 V	310	96.30	4.40
2	*5200.00	93.1 AV			1.00 V	310	88.70	4.40
3	#10400.00	55.3 PK	74.0	-18.7	1.00 V	191	45.30	10.00
4	#10400.00	41.0 AV	54.0	-13.0	1.00 V	191	31.00	10.00
5	15600.00	58.3 PK	74.0	-15.7	1.04 V	112	43.20	15.10
6	15600.00	46.6 AV	54.0	-7.4	1.04 V	112	31.50	15.10

REMARKS:

1. Emission Level(dBuV/m) = Raw Value(dBuV) + Correction Factor(dB/m)
2. Correction Factor(dB/m) = Antenna Factor(dB/m) + Cable Factor(dB) – Pre-Amplifier Factor(dB)
3. The other emission levels were very low against the limit.
4. Margin value = Emission Level – Limit value
5. " * ": Fundamental frequency.
6. " # ": The radiated frequency is out of the restricted band.



A D T

CHANNEL	TX Channel 48	DETECTOR FUNCTION	Peak (PK)
FREQUENCY RANGE	1GHz ~ 40GHz		Average (AV)

ANTENNA POLARITY & TEST DISTANCE: HORIZONTAL AT 3 M

NO.	FREQ. (MHz)	EMISSION LEVEL (dBuV/m)	LIMIT (dBuV/m)	MARGIN (dB)	ANTENNA HEIGHT (m)	TABLE ANGLE (Degree)	RAW VALUE (dBuV)	CORRECTION FACTOR (dB/m)
1	*5240.00	96.3 PK			1.76 H	78	91.80	4.50
2	*5240.00	87.1 AV			1.76 H	78	82.60	4.50
3	5350.00	51.8 PK	74.0	-22.2	1.76 H	78	47.40	4.40
4	5350.00	39.2 AV	54.0	-14.8	1.76 H	78	34.80	4.40
5	#10480.00	54.3 PK	74.0	-19.7	1.00 H	104	44.00	10.30
6	#10480.00	40.7 AV	54.0	-13.3	1.00 H	104	30.40	10.30
7	15720.00	59.7 PK	74.0	-14.3	1.00 H	305	45.00	14.70
8	15720.00	47.0 AV	54.0	-7.0	1.00 H	305	32.30	14.70

ANTENNA POLARITY & TEST DISTANCE: VERTICAL AT 3 M

NO.	FREQ. (MHz)	EMISSION LEVEL (dBuV/m)	LIMIT (dBuV/m)	MARGIN (dB)	ANTENNA HEIGHT (m)	TABLE ANGLE (Degree)	RAW VALUE (dBuV)	CORRECTION FACTOR (dB/m)
1	*5240.00	102.1 PK			1.00 V	355	97.60	4.50
2	*5240.00	94.0 AV			1.00 V	355	89.50	4.50
3	5350.00	51.6 PK	74.0	-22.4	1.00 V	355	47.20	4.40
4	5350.00	40.6 AV	54.0	-13.4	1.00 V	355	36.20	4.40
5	#10480.00	55.3 PK	74.0	-18.7	1.00 V	205	45.00	10.30
6	#10480.00	40.8 AV	54.0	-13.2	1.00 V	205	30.50	10.30
7	15720.00	59.0 PK	74.0	-15.0	1.00 V	118	44.30	14.70
8	15720.00	46.9 AV	54.0	-7.1	1.00 V	118	32.20	14.70

REMARKS:

1. Emission Level(dBuV/m) = Raw Value(dBuV) + Correction Factor(dB/m)
2. Correction Factor(dB/m) = Antenna Factor(dB/m) + Cable Factor(dB) – Pre-Amplifier Factor(dB)
3. The other emission levels were very low against the limit.
4. Margin value = Emission Level – Limit value
5. " * ": Fundamental frequency.
6. " # ": The radiated frequency is out of the restricted band.



A D T

802.11ac (VHT20), 1Tx

CHANNEL	TX Channel 36	DETECTOR FUNCTION	Peak (PK)
FREQUENCY RANGE	1GHz ~ 40GHz		Average (AV)

ANTENNA POLARITY & TEST DISTANCE: HORIZONTAL AT 3 M

NO.	FREQ. (MHz)	EMISSION LEVEL (dBuV/m)	LIMIT (dBuV/m)	MARGIN (dB)	ANTENNA HEIGHT (m)	TABLE ANGLE (Degree)	RAW VALUE (dBuV)	CORRECTION FACTOR (dB/m)
1	5150.00	51.0 PK	74.0	-23.0	1.16 H	73	46.70	4.30
2	5150.00	39.0 AV	54.0	-15.0	1.16 H	73	34.70	4.30
3	*5180.00	97.2 PK			1.16 H	73	92.80	4.40
4	*5180.00	88.0 AV			1.16 H	73	83.60	4.40
5	#10360.00	53.9 PK	74.0	-20.1	1.01 H	107	43.80	10.10
6	#10360.00	40.7 AV	54.0	-13.3	1.01 H	107	30.60	10.10
7	15540.00	59.2 PK	74.0	-14.8	1.00 H	300	44.40	14.80
8	15540.00	46.8 AV	54.0	-7.2	1.00 H	300	32.00	14.80

ANTENNA POLARITY & TEST DISTANCE: VERTICAL AT 3 M

NO.	FREQ. (MHz)	EMISSION LEVEL (dBuV/m)	LIMIT (dBuV/m)	MARGIN (dB)	ANTENNA HEIGHT (m)	TABLE ANGLE (Degree)	RAW VALUE (dBuV)	CORRECTION FACTOR (dB/m)
1	5150.00	50.8 PK	74.0	-23.2	1.01 V	354	46.50	4.30
2	5150.00	40.7 AV	54.0	-13.3	1.01 V	354	36.40	4.30
3	*5180.00	101.9 PK			1.01 V	354	97.50	4.40
4	*5180.00	94.0 AV			1.01 V	354	89.60	4.40
5	#10360.00	55.1 PK	74.0	-18.9	1.00 V	200	45.00	10.10
6	#10360.00	40.8 AV	54.0	-13.2	1.00 V	200	30.70	10.10
7	15540.00	59.5 PK	74.0	-14.5	1.00 V	123	44.70	14.80
8	15540.00	47.4 AV	54.0	-6.6	1.00 V	123	32.60	14.80

REMARKS:

1. Emission Level(dBuV/m) = Raw Value(dBuV) + Correction Factor(dB/m)
2. Correction Factor(dB/m) = Antenna Factor(dB/m) + Cable Factor(dB) – Pre-Amplifier Factor(dB)
3. The other emission levels were very low against the limit.
4. Margin value = Emission Level – Limit value
5. " * ": Fundamental frequency.
6. " # ": The radiated frequency is out of the restricted band.



A D T

CHANNEL	TX Channel 40	DETECTOR FUNCTION	Peak (PK)
FREQUENCY RANGE	1GHz ~ 40GHz		Average (AV)

ANTENNA POLARITY & TEST DISTANCE: HORIZONTAL AT 3 M

NO.	FREQ. (MHz)	EMISSION LEVEL (dBuV/m)	LIMIT (dBuV/m)	MARGIN (dB)	ANTENNA HEIGHT (m)	TABLE ANGLE (Degree)	RAW VALUE (dBuV)	CORRECTION FACTOR (dB/m)
1	*5200.00	96.6 PK			1.12 H	69	92.20	4.40
2	*5200.00	87.2 AV			1.12 H	69	82.80	4.40
3	#10400.00	54.3 PK	74.0	-19.7	1.00 H	93	44.30	10.00
4	#10400.00	41.1 AV	54.0	-12.9	1.00 H	93	31.10	10.00
5	15600.00	58.7 PK	74.0	-15.3	1.00 H	283	43.60	15.10
6	15600.00	46.3 AV	54.0	-7.7	1.00 H	283	31.20	15.10

ANTENNA POLARITY & TEST DISTANCE: VERTICAL AT 3 M

NO.	FREQ. (MHz)	EMISSION LEVEL (dBuV/m)	LIMIT (dBuV/m)	MARGIN (dB)	ANTENNA HEIGHT (m)	TABLE ANGLE (Degree)	RAW VALUE (dBuV)	CORRECTION FACTOR (dB/m)
1	*5200.00	101.6 PK			1.01 V	355	97.20	4.40
2	*5200.00	93.7 AV			1.01 V	355	89.30	4.40
3	#10400.00	54.6 PK	74.0	-19.4	1.00 V	183	44.60	10.00
4	#10400.00	40.4 AV	54.0	-13.6	1.00 V	183	30.40	10.00
5	15600.00	59.7 PK	74.0	-14.3	1.00 V	115	44.60	15.10
6	15600.00	47.5 AV	54.0	-6.5	1.00 V	115	32.40	15.10

REMARKS:

1. Emission Level(dBuV/m) = Raw Value(dBuV) + Correction Factor(dB/m)
2. Correction Factor(dB/m) = Antenna Factor(dB/m) + Cable Factor(dB) – Pre-Amplifier Factor(dB)
3. The other emission levels were very low against the limit.
4. Margin value = Emission Level – Limit value
5. " * ": Fundamental frequency.
6. " # ": The radiated frequency is out of the restricted band.



A D T

CHANNEL	TX Channel 48	DETECTOR FUNCTION	Peak (PK)
FREQUENCY RANGE	1GHz ~ 40GHz		Average (AV)

ANTENNA POLARITY & TEST DISTANCE: HORIZONTAL AT 3 M

NO.	FREQ. (MHz)	EMISSION LEVEL (dBuV/m)	LIMIT (dBuV/m)	MARGIN (dB)	ANTENNA HEIGHT (m)	TABLE ANGLE (Degree)	RAW VALUE (dBuV)	CORRECTION FACTOR (dB/m)
1	*5240.00	96.6 PK			1.22 H	58	92.10	4.50
2	*5240.00	87.5 AV			1.22 H	58	83.00	4.50
3	5350.00	51.6 PK	74.0	-22.4	1.22 H	58	47.20	4.40
4	5350.00	38.9 AV	54.0	-15.1	1.22 H	58	34.50	4.40
5	#10480.00	53.7 PK	74.0	-20.3	1.00 H	69	43.40	10.30
6	#10480.00	40.4 AV	54.0	-13.6	1.00 H	69	30.10	10.30
7	15720.00	58.3 PK	74.0	-15.7	1.01 H	277	43.60	14.70
8	15720.00	46.0 AV	54.0	-8.0	1.01 H	277	31.30	14.70

ANTENNA POLARITY & TEST DISTANCE: VERTICAL AT 3 M

NO.	FREQ. (MHz)	EMISSION LEVEL (dBuV/m)	LIMIT (dBuV/m)	MARGIN (dB)	ANTENNA HEIGHT (m)	TABLE ANGLE (Degree)	RAW VALUE (dBuV)	CORRECTION FACTOR (dB/m)
1	*5240.00	102.0 PK			1.00 V	351	97.50	4.50
2	*5240.00	94.4 AV			1.00 V	351	89.90	4.50
3	5350.00	51.3 PK	74.0	-22.7	1.00 V	351	46.90	4.40
4	5350.00	40.8 AV	54.0	-13.2	1.00 V	351	36.40	4.40
5	#10480.00	54.3 PK	74.0	-19.7	1.00 V	185	44.00	10.30
6	#10480.00	39.9 AV	54.0	-14.1	1.00 V	185	29.60	10.30
7	15720.00	59.5 PK	74.0	-14.5	1.00 V	102	44.80	14.70
8	15720.00	47.2 AV	54.0	-6.8	1.00 V	102	32.50	14.70

REMARKS:

1. Emission Level(dBuV/m) = Raw Value(dBuV) + Correction Factor(dB/m)
2. Correction Factor(dB/m) = Antenna Factor(dB/m) + Cable Factor(dB) – Pre-Amplifier Factor(dB)
3. The other emission levels were very low against the limit.
4. Margin value = Emission Level – Limit value
5. " * ": Fundamental frequency.
6. " # ": The radiated frequency is out of the restricted band.



A D T

802.11ac (VHT40), 1Tx

CHANNEL	TX Channel 38	DETECTOR FUNCTION	Peak (PK)
FREQUENCY RANGE	1GHz ~ 40GHz		Average (AV)

ANTENNA POLARITY & TEST DISTANCE: HORIZONTAL AT 3 M

NO.	FREQ. (MHz)	EMISSION LEVEL (dBuV/m)	LIMIT (dBuV/m)	MARGIN (dB)	ANTENNA HEIGHT (m)	TABLE ANGLE (Degree)	RAW VALUE (dBuV)	CORRECTION FACTOR (dB/m)
1	5150.00	50.9 PK	74.0	-23.1	1.13 H	86	46.60	4.30
2	5150.00	40.4 AV	54.0	-13.6	1.13 H	86	36.10	4.30
3	*5190.00	93.8 PK			1.13 H	86	89.40	4.40
4	*5190.00	84.5 AV			1.13 H	86	80.10	4.40
5	#10380.00	53.6 PK	74.0	-20.4	1.02 H	49	43.50	10.10
6	#10380.00	40.0 AV	54.0	-14.0	1.02 H	49	29.90	10.10
7	15570.00	57.0 PK	74.0	-17.0	1.00 H	271	42.10	14.90
8	15570.00	45.2 AV	54.0	-8.8	1.00 H	271	30.30	14.90

ANTENNA POLARITY & TEST DISTANCE: VERTICAL AT 3 M

NO.	FREQ. (MHz)	EMISSION LEVEL (dBuV/m)	LIMIT (dBuV/m)	MARGIN (dB)	ANTENNA HEIGHT (m)	TABLE ANGLE (Degree)	RAW VALUE (dBuV)	CORRECTION FACTOR (dB/m)
1	5150.00	50.4 PK	74.0	-23.6	1.02 V	355	46.10	4.30
2	5150.00	41.8 AV	54.0	-12.2	1.02 V	355	37.50	4.30
3	*5190.00	98.8 PK			1.02 V	355	94.40	4.40
4	*5190.00	91.1 AV			1.02 V	355	86.70	4.40
5	#10380.00	54.3 PK	74.0	-19.7	1.04 V	199	44.20	10.10
6	#10380.00	39.7 AV	54.0	-14.3	1.04 V	199	29.60	10.10
7	15570.00	58.7 PK	74.0	-15.3	1.06 V	94	43.80	14.90
8	15570.00	46.7 AV	54.0	-7.3	1.06 V	94	31.80	14.90

REMARKS:

1. Emission Level(dBuV/m) = Raw Value(dBuV) + Correction Factor(dB/m)
2. Correction Factor(dB/m) = Antenna Factor(dB/m) + Cable Factor(dB) – Pre-Amplifier Factor(dB)
3. The other emission levels were very low against the limit.
4. Margin value = Emission Level – Limit value
5. " * ": Fundamental frequency.
6. " # ": The radiated frequency is out of the restricted band.



A D T

CHANNEL	TX Channel 46	DETECTOR FUNCTION	Peak (PK)
FREQUENCY RANGE	1GHz ~ 40GHz		Average (AV)

ANTENNA POLARITY & TEST DISTANCE: HORIZONTAL AT 3 M

NO.	FREQ. (MHz)	EMISSION LEVEL (dBuV/m)	LIMIT (dBuV/m)	MARGIN (dB)	ANTENNA HEIGHT (m)	TABLE ANGLE (Degree)	RAW VALUE (dBuV)	CORRECTION FACTOR (dB/m)
1	*5230.00	94.0 PK			1.16 H	80	89.50	4.50
2	*5230.00	84.8 AV			1.16 H	80	80.30	4.50
3	5350.00	51.2 PK	74.0	-22.8	1.16 H	80	46.80	4.40
4	5350.00	39.6 AV	54.0	-14.4	1.16 H	80	35.20	4.40
5	#10460.00	52.9 PK	74.0	-21.1	1.04 H	45	42.70	10.20
6	#10460.00	39.8 AV	54.0	-14.2	1.04 H	45	29.60	10.20
7	15690.00	56.8 PK	74.0	-17.2	1.00 H	274	42.10	14.70
8	15690.00	45.3 AV	54.0	-8.7	1.00 H	274	30.60	14.70

ANTENNA POLARITY & TEST DISTANCE: VERTICAL AT 3 M

NO.	FREQ. (MHz)	EMISSION LEVEL (dBuV/m)	LIMIT (dBuV/m)	MARGIN (dB)	ANTENNA HEIGHT (m)	TABLE ANGLE (Degree)	RAW VALUE (dBuV)	CORRECTION FACTOR (dB/m)
1	*5230.00	99.2 PK			1.02 V	355	94.70	4.50
2	*5230.00	91.0 AV			1.02 V	355	86.50	4.50
3	5350.00	51.7 PK	74.0	-22.3	1.02 V	355	47.30	4.40
4	5350.00	40.5 AV	54.0	-13.5	1.02 V	355	36.10	4.40
5	#10460.00	54.2 PK	74.0	-19.8	1.02 V	178	44.00	10.20
6	#10460.00	39.3 AV	54.0	-14.7	1.02 V	178	29.10	10.20
7	15690.00	58.2 PK	74.0	-15.8	1.11 V	80	43.50	14.70
8	15690.00	46.6 AV	54.0	-7.4	1.11 V	80	31.90	14.70

REMARKS:

1. Emission Level(dBuV/m) = Raw Value(dBuV) + Correction Factor(dB/m)
2. Correction Factor(dB/m) = Antenna Factor(dB/m) + Cable Factor(dB) – Pre-Amplifier Factor(dB)
3. The other emission levels were very low against the limit.
4. Margin value = Emission Level – Limit value
5. " * ": Fundamental frequency.
6. " # ": The radiated frequency is out of the restricted band.



802.11ac (VHT80), 1Tx

CHANNEL	TX Channel 42	DETECTOR FUNCTION	Peak (PK)
FREQUENCY RANGE	1GHz ~ 40GHz		Average (AV)

ANTENNA POLARITY & TEST DISTANCE: HORIZONTAL AT 3 M

NO.	FREQ. (MHz)	EMISSION LEVEL (dBuV/m)	LIMIT (dBuV/m)	MARGIN (dB)	ANTENNA HEIGHT (m)	TABLE ANGLE (Degree)	RAW VALUE (dBuV)	CORRECTION FACTOR (dB/m)
1	5150.00	60.8 PK	74.0	-13.2	1.16 H	68	56.50	4.30
2	5150.00	49.2 AV	54.0	-4.8	1.16 H	68	44.90	4.30
3	*5210.00	90.6 PK			1.16 H	68	86.10	4.50
4	*5210.00	82.0 AV			1.16 H	68	77.50	4.50
5	5350.00	51.2 PK	74.0	-22.8	1.16 H	68	46.80	4.40
6	5350.00	39.4 AV	54.0	-14.6	1.16 H	68	35.00	4.40
7	#10420.00	52.6 PK	74.0	-21.4	1.00 H	30	42.50	10.10
8	#10420.00	39.5 AV	54.0	-14.5	1.00 H	30	29.40	10.10
9	15630.00	55.7 PK	74.0	-18.3	1.05 H	278	40.80	14.90
10	15630.00	44.5 AV	54.0	-9.5	1.05 H	278	29.60	14.90

ANTENNA POLARITY & TEST DISTANCE: VERTICAL AT 3 M

NO.	FREQ. (MHz)	EMISSION LEVEL (dBuV/m)	LIMIT (dBuV/m)	MARGIN (dB)	ANTENNA HEIGHT (m)	TABLE ANGLE (Degree)	RAW VALUE (dBuV)	CORRECTION FACTOR (dB/m)
1	5150.00	62.0 PK	74.0	-12.0	1.01 V	355	57.70	4.30
2	5150.00	50.7 AV	54.0	-3.3	1.01 V	355	46.40	4.30
3	*5210.00	95.7 PK			1.01 V	355	91.20	4.50
4	*5210.00	88.2 AV			1.01 V	355	83.70	4.50
5	5350.00	51.6 PK	74.0	-22.4	1.01 V	355	47.20	4.40
6	5350.00	40.5 AV	54.0	-13.5	1.01 V	355	36.10	4.40
7	#10420.00	53.9 PK	74.0	-20.1	1.00 V	163	43.80	10.10
8	#10420.00	39.4 AV	54.0	-14.6	1.00 V	163	29.30	10.10
9	15630.00	57.4 PK	74.0	-16.6	1.06 V	70	42.50	14.90
10	15630.00	45.8 AV	54.0	-8.2	1.06 V	70	30.90	14.90

REMARKS:

1. Emission Level(dBuV/m) = Raw Value(dBuV) + Correction Factor(dB/m)
2. Correction Factor(dB/m) = Antenna Factor(dB/m) + Cable Factor(dB) – Pre-Amplifier Factor(dB)
3. The other emission levels were very low against the limit.
4. Margin value = Emission Level – Limit value
5. " * ": Fundamental frequency.
6. " # ": The radiated frequency is out of the restricted band.



A D T

802.11ac (VHT20), 2Tx

CHANNEL	TX Channel 36	DETECTOR FUNCTION	Peak (PK)
FREQUENCY RANGE	1GHz ~ 40GHz		Average (AV)

ANTENNA POLARITY & TEST DISTANCE: HORIZONTAL AT 3 M

NO.	FREQ. (MHz)	EMISSION LEVEL (dBuV/m)	LIMIT (dBuV/m)	MARGIN (dB)	ANTENNA HEIGHT (m)	TABLE ANGLE (Degree)	RAW VALUE (dBuV)	CORRECTION FACTOR (dB/m)
1	5150.00	51.5 PK	74.0	-22.5	1.00 H	32	47.20	4.30
2	5150.00	39.5 AV	54.0	-14.5	1.00 H	32	35.20	4.30
3	*5180.00	100.7 PK			1.00 H	32	96.30	4.40
4	*5180.00	91.0 AV			1.00 H	32	86.60	4.40
5	#10360.00	54.7 PK	74.0	-19.3	1.00 H	232	44.60	10.10
6	#10360.00	41.2 AV	54.0	-12.8	1.00 H	232	31.10	10.10
7	15540.00	60.0 PK	74.0	-14.0	1.00 H	314	45.20	14.80
8	15540.00	47.4 AV	54.0	-6.6	1.00 H	314	32.60	14.80

ANTENNA POLARITY & TEST DISTANCE: VERTICAL AT 3 M

NO.	FREQ. (MHz)	EMISSION LEVEL (dBuV/m)	LIMIT (dBuV/m)	MARGIN (dB)	ANTENNA HEIGHT (m)	TABLE ANGLE (Degree)	RAW VALUE (dBuV)	CORRECTION FACTOR (dB/m)
1	5150.00	52.4 PK	74.0	-21.6	1.05 V	5	48.10	4.30
2	5150.00	41.8 AV	54.0	-12.2	1.05 V	5	37.50	4.30
3	*5180.00	105.5 PK			1.05 V	5	101.10	4.40
4	*5180.00	98.3 AV			1.05 V	5	93.90	4.40
5	#10360.00	54.5 PK	74.0	-19.5	1.00 V	105	44.40	10.10
6	#10360.00	41.1 AV	54.0	-12.9	1.00 V	105	31.00	10.10
7	15540.00	58.4 PK	74.0	-15.6	1.00 V	211	43.60	14.80
8	15540.00	47.0 AV	54.0	-7.0	1.00 V	211	32.20	14.80

REMARKS:

1. Emission Level(dBuV/m) = Raw Value(dBuV) + Correction Factor(dB/m)
2. Correction Factor(dB/m) = Antenna Factor(dB/m) + Cable Factor(dB) – Pre-Amplifier Factor(dB)
3. The other emission levels were very low against the limit.
4. Margin value = Emission Level – Limit value
5. " * ": Fundamental frequency.
6. " # ": The radiated frequency is out of the restricted band.



A D T

CHANNEL	TX Channel 40	DETECTOR FUNCTION	Peak (PK)
FREQUENCY RANGE	1GHz ~ 40GHz		Average (AV)

ANTENNA POLARITY & TEST DISTANCE: HORIZONTAL AT 3 M

NO.	FREQ. (MHz)	EMISSION LEVEL (dBuV/m)	LIMIT (dBuV/m)	MARGIN (dB)	ANTENNA HEIGHT (m)	TABLE ANGLE (Degree)	RAW VALUE (dBuV)	CORRECTION FACTOR (dB/m)
1	*5200.00	99.9 PK			1.00 H	29	95.50	4.40
2	*5200.00	90.0 AV			1.00 H	29	85.60	4.40
3	#10400.00	54.7 PK	74.0	-19.3	1.00 H	231	44.70	10.00
4	#10400.00	41.3 AV	54.0	-12.7	1.00 H	231	31.30	10.00
5	15600.00	60.4 PK	74.0	-13.6	1.03 H	321	45.30	15.10
6	15600.00	47.8 AV	54.0	-6.2	1.03 H	321	32.70	15.10

ANTENNA POLARITY & TEST DISTANCE: VERTICAL AT 3 M

NO.	FREQ. (MHz)	EMISSION LEVEL (dBuV/m)	LIMIT (dBuV/m)	MARGIN (dB)	ANTENNA HEIGHT (m)	TABLE ANGLE (Degree)	RAW VALUE (dBuV)	CORRECTION FACTOR (dB/m)
1	*5200.00	104.9 PK			1.01 V	3	100.50	4.40
2	*5200.00	97.8 AV			1.01 V	3	93.40	4.40
3	#10400.00	54.5 PK	74.0	-19.5	1.00 V	105	44.50	10.00
4	#10400.00	41.1 AV	54.0	-12.9	1.00 V	105	31.10	10.00
5	15600.00	58.5 PK	74.0	-15.5	1.00 V	214	43.40	15.10
6	15600.00	47.1 AV	54.0	-6.9	1.00 V	214	32.00	15.10

REMARKS:

1. Emission Level(dBuV/m) = Raw Value(dBuV) + Correction Factor(dB/m)
2. Correction Factor(dB/m) = Antenna Factor(dB/m) + Cable Factor(dB) – Pre-Amplifier Factor(dB)
3. The other emission levels were very low against the limit.
4. Margin value = Emission Level – Limit value
5. " * ": Fundamental frequency.
6. " # ": The radiated frequency is out of the restricted band.



A D T

CHANNEL	TX Channel 48	DETECTOR FUNCTION	Peak (PK)
FREQUENCY RANGE	1GHz ~ 40GHz		Average (AV)

ANTENNA POLARITY & TEST DISTANCE: HORIZONTAL AT 3 M

NO.	FREQ. (MHz)	EMISSION LEVEL (dBuV/m)	LIMIT (dBuV/m)	MARGIN (dB)	ANTENNA HEIGHT (m)	TABLE ANGLE (Degree)	RAW VALUE (dBuV)	CORRECTION FACTOR (dB/m)
1	*5240.00	100.2 PK			1.00 H	32	95.70	4.50
2	*5240.00	90.8 AV			1.00 H	32	86.30	4.50
3	5350.00	51.3 PK	74.0	-22.7	1.00 H	32	46.90	4.40
4	5350.00	38.8 AV	54.0	-15.2	1.00 H	32	34.40	4.40
5	#10480.00	54.8 PK	74.0	-19.2	1.01 H	215	44.50	10.30
6	#10480.00	41.4 AV	54.0	-12.6	1.01 H	215	31.10	10.30
7	15720.00	60.2 PK	74.0	-13.8	1.00 H	324	45.50	14.70
8	15720.00	47.4 AV	54.0	-6.6	1.00 H	324	32.70	14.70

ANTENNA POLARITY & TEST DISTANCE: VERTICAL AT 3 M

NO.	FREQ. (MHz)	EMISSION LEVEL (dBuV/m)	LIMIT (dBuV/m)	MARGIN (dB)	ANTENNA HEIGHT (m)	TABLE ANGLE (Degree)	RAW VALUE (dBuV)	CORRECTION FACTOR (dB/m)
1	*5240.00	105.0 PK			1.01 V	5	100.50	4.50
2	*5240.00	98.0 AV			1.01 V	5	93.50	4.50
3	5350.00	52.2 PK	74.0	-21.8	1.01 V	5	47.80	4.40
4	5350.00	41.4 AV	54.0	-12.6	1.01 V	5	37.00	4.40
5	#10480.00	54.7 PK	74.0	-19.3	1.00 V	93	44.40	10.30
6	#10480.00	41.3 AV	54.0	-12.7	1.00 V	93	31.00	10.30
7	15720.00	58.4 PK	74.0	-15.6	1.03 V	226	43.70	14.70
8	15720.00	47.2 AV	54.0	-6.8	1.03 V	226	32.50	14.70

REMARKS:

1. Emission Level(dBuV/m) = Raw Value(dBuV) + Correction Factor(dB/m)
2. Correction Factor(dB/m) = Antenna Factor(dB/m) + Cable Factor(dB) – Pre-Amplifier Factor(dB)
3. The other emission levels were very low against the limit.
4. Margin value = Emission Level – Limit value
5. " * ": Fundamental frequency.
6. " # ": The radiated frequency is out of the restricted band.



A D T

802.11ac (VHT40), 2Tx

CHANNEL	TX Channel 38	DETECTOR FUNCTION	Peak (PK)
FREQUENCY RANGE	1GHz ~ 40GHz		Average (AV)

ANTENNA POLARITY & TEST DISTANCE: HORIZONTAL AT 3 M

NO.	FREQ. (MHz)	EMISSION LEVEL (dBuV/m)	LIMIT (dBuV/m)	MARGIN (dB)	ANTENNA HEIGHT (m)	TABLE ANGLE (Degree)	RAW VALUE (dBuV)	CORRECTION FACTOR (dB/m)
1	5150.00	52.1 PK	74.0	-21.9	1.00 H	17	47.80	4.30
2	5150.00	39.8 AV	54.0	-14.2	1.00 H	17	35.50	4.30
3	*5190.00	95.6 PK			1.00 H	17	91.20	4.40
4	*5190.00	84.5 AV			1.00 H	17	80.10	4.40
5	#10380.00	55.0 PK	74.0	-19.0	1.05 H	213	44.90	10.10
6	#10380.00	41.9 AV	54.0	-12.1	1.05 H	213	31.80	10.10
7	15570.00	59.5 PK	74.0	-14.5	1.02 H	311	44.60	14.90
8	15570.00	46.9 AV	54.0	-7.1	1.02 H	311	32.00	14.90

ANTENNA POLARITY & TEST DISTANCE: VERTICAL AT 3 M

NO.	FREQ. (MHz)	EMISSION LEVEL (dBuV/m)	LIMIT (dBuV/m)	MARGIN (dB)	ANTENNA HEIGHT (m)	TABLE ANGLE (Degree)	RAW VALUE (dBuV)	CORRECTION FACTOR (dB/m)
1	5150.00	51.8 PK	74.0	-22.2	1.02 V	356	47.50	4.30
2	5150.00	41.6 AV	54.0	-12.4	1.02 V	356	37.30	4.30
3	*5190.00	100.4 PK			1.02 V	356	96.00	4.40
4	*5190.00	91.7 AV			1.02 V	356	87.30	4.40
5	#10380.00	54.7 PK	74.0	-19.3	1.02 V	84	44.60	10.10
6	#10380.00	41.5 AV	54.0	-12.5	1.02 V	84	31.40	10.10
7	15570.00	58.0 PK	74.0	-16.0	1.03 V	236	43.10	14.90
8	15570.00	46.7 AV	54.0	-7.3	1.03 V	236	31.80	14.90

REMARKS:

1. Emission Level(dBuV/m) = Raw Value(dBuV) + Correction Factor(dB/m)
2. Correction Factor(dB/m) = Antenna Factor(dB/m) + Cable Factor(dB) – Pre-Amplifier Factor(dB)
3. The other emission levels were very low against the limit.
4. Margin value = Emission Level – Limit value
5. " * ": Fundamental frequency.
6. " # ": The radiated frequency is out of the restricted band.



A D T

CHANNEL	TX Channel 46	DETECTOR FUNCTION	Peak (PK)
FREQUENCY RANGE	1GHz ~ 40GHz		Average (AV)

ANTENNA POLARITY & TEST DISTANCE: HORIZONTAL AT 3 M

NO.	FREQ. (MHz)	EMISSION LEVEL (dBuV/m)	LIMIT (dBuV/m)	MARGIN (dB)	ANTENNA HEIGHT (m)	TABLE ANGLE (Degree)	RAW VALUE (dBuV)	CORRECTION FACTOR (dB/m)
1	*5230.00	96.3 PK			1.00 H	7	91.80	4.50
2	*5230.00	85.4 AV			1.00 H	7	80.90	4.50
3	5350.00	51.2 PK	74.0	-22.8	1.00 H	7	46.80	4.40
4	5350.00	38.9 AV	54.0	-15.1	1.00 H	7	34.50	4.40
5	#10460.00	55.4 PK	74.0	-18.6	1.02 H	218	45.20	10.20
6	#10460.00	42.1 AV	54.0	-11.9	1.02 H	218	31.90	10.20
7	15690.00	59.1 PK	74.0	-14.9	1.00 H	319	44.40	14.70
8	15690.00	46.6 AV	54.0	-7.4	1.00 H	319	31.90	14.70

ANTENNA POLARITY & TEST DISTANCE: VERTICAL AT 3 M

NO.	FREQ. (MHz)	EMISSION LEVEL (dBuV/m)	LIMIT (dBuV/m)	MARGIN (dB)	ANTENNA HEIGHT (m)	TABLE ANGLE (Degree)	RAW VALUE (dBuV)	CORRECTION FACTOR (dB/m)
1	*5230.00	100.2 PK			1.00 V	347	95.70	4.50
2	*5230.00	92.5 AV			1.00 V	347	88.00	4.50
3	5350.00	52.3 PK	74.0	-21.7	1.00 V	347	47.90	4.40
4	5350.00	40.6 AV	54.0	-13.4	1.00 V	347	36.20	4.40
5	#10460.00	54.3 PK	74.0	-19.7	1.00 V	93	44.10	10.20
6	#10460.00	41.1 AV	54.0	-12.9	1.00 V	93	30.90	10.20
7	15690.00	57.8 PK	74.0	-16.2	1.00 V	226	43.10	14.70
8	15690.00	46.7 AV	54.0	-7.3	1.00 V	226	32.00	14.70

REMARKS:

1. Emission Level(dBuV/m) = Raw Value(dBuV) + Correction Factor(dB/m)
2. Correction Factor(dB/m) = Antenna Factor(dB/m) + Cable Factor(dB) – Pre-Amplifier Factor(dB)
3. The other emission levels were very low against the limit.
4. Margin value = Emission Level – Limit value
5. " * ": Fundamental frequency.
6. " # ": The radiated frequency is out of the restricted band.



802.11ac (VHT80), 2Tx

CHANNEL	TX Channel 42	DETECTOR FUNCTION	Peak (PK)
FREQUENCY RANGE	1GHz ~ 40GHz		Average (AV)

ANTENNA POLARITY & TEST DISTANCE: HORIZONTAL AT 3 M

NO.	FREQ. (MHz)	EMISSION LEVEL (dBuV/m)	LIMIT (dBuV/m)	MARGIN (dB)	ANTENNA HEIGHT (m)	TABLE ANGLE (Degree)	RAW VALUE (dBuV)	CORRECTION FACTOR (dB/m)
1	5150.00	55.4 PK	74.0	-18.6	1.00 H	8	51.10	4.30
2	5150.00	44.9 AV	54.0	-9.1	1.00 H	8	40.60	4.30
3	*5210.00	96.7 PK			1.00 H	8	92.20	4.50
4	*5210.00	85.7 AV			1.00 H	8	81.20	4.50
5	5350.00	51.8 PK	74.0	-22.2	1.00 H	8	47.40	4.40
6	5350.00	38.6 AV	54.0	-15.4	1.00 H	8	34.20	4.40
7	#10420.00	55.1 PK	74.0	-18.9	1.02 H	215	45.00	10.10
8	#10420.00	42.0 AV	54.0	-12.0	1.02 H	215	31.90	10.10
9	15630.00	59.1 PK	74.0	-14.9	1.00 H	331	44.20	14.90
10	15630.00	46.8 AV	54.0	-7.2	1.00 H	331	31.90	14.90

ANTENNA POLARITY & TEST DISTANCE: VERTICAL AT 3 M

NO.	FREQ. (MHz)	EMISSION LEVEL (dBuV/m)	LIMIT (dBuV/m)	MARGIN (dB)	ANTENNA HEIGHT (m)	TABLE ANGLE (Degree)	RAW VALUE (dBuV)	CORRECTION FACTOR (dB/m)
1	5150.00	56.0 PK	74.0	-18.0	1.15 V	0	51.70	4.30
2	5150.00	46.5 AV	54.0	-7.5	1.15 V	0	42.20	4.30
3	*5210.00	101.0 PK			1.15 V	0	96.50	4.50
4	*5210.00	92.5 AV			1.15 V	0	88.00	4.50
5	5350.00	52.8 PK	74.0	-21.2	1.15 V	0	48.40	4.40
6	5350.00	40.4 AV	54.0	-13.6	1.15 V	0	36.00	4.40
7	#10420.00	53.6 PK	74.0	-20.4	1.00 V	94	43.50	10.10
8	#10420.00	40.6 AV	54.0	-13.4	1.00 V	94	30.50	10.10
9	15630.00	57.6 PK	74.0	-16.4	1.01 V	233	42.70	14.90
10	15630.00	46.4 AV	54.0	-7.6	1.01 V	233	31.50	14.90

REMARKS:

1. Emission Level(dBuV/m) = Raw Value(dBuV) + Correction Factor(dB/m)
2. Correction Factor(dB/m) = Antenna Factor(dB/m) + Cable Factor(dB) – Pre-Amplifier Factor(dB)
3. The other emission levels were very low against the limit.
4. Margin value = Emission Level – Limit value
5. " * ": Fundamental frequency.
6. " # ": The radiated frequency is out of the restricted band.



A D T

4.3 TRANSMIT POWER MEASUREMENT

4.3.1 LIMITS OF TRANSMIT POWER MEASUREMENT

FREQUENCY BAND	LIMIT
5.150 ~ 5.250GHz	The lesser of 50mW (17dBm) or 4dBm + 10logB
5.250 ~ 5.350GHz	The lesser of 250mW (24dBm) or 11dBm + 10logB
5.470 ~ 5.725GHz	The lesser of 250mW (24dBm) or 11dBm + 10logB

NOTE: Where B is the 26dB emission bandwidth in MHz.

Per KDB 662911 D01 Multiple Transmitter Output Method of conducted output power measurement on IEEE 802.11 devices,

Array Gain = 0 dB (i.e., no array gain) for NANT ≤ 4;

Array Gain = 0 dB (i.e., no array gain) for channel widths ≥ 40 MHz for any NANT;

Array Gain = 5 log(NANT/NSS) dB or 3 dB, whichever is less for 20-MHz channel widths with NANT ≥ 5.

For power measurements on all other devices: Array Gain = 10 log(NANT/NSS) dB.

4.3.2 TEST INSTRUMENTS

FOR POWER OUTPUT MEASUREMENT

DESCRIPTION & MANUFACTURER	MODEL NO.	SERIAL NO.	CALIBRATED DATE	CALIBRATED UNTIL
Power meter Anritsu	ML2495A	1014008	Apr. 23, 2013	Apr. 22, 2014
Power sensor Anritsu	MA2411B	0917122	Apr. 23, 2013	Apr. 22, 2014

Note:

1. The calibration interval of the above test instruments is 12 months and the calibrations are traceable to NML/ROC and NIST/USA.
2. Tested date : Apr. 10, 2014

FOR 26dB OCCUPIED BANDWIDTH

DESCRIPTION & MANUFACTURER	MODEL NO.	SERIAL NO.	CALIBRATED DATE	CALIBRATED UNTIL
Spectrum Analyzer R&S	FSV 40	100964	July 15, 2013	July 14, 2014

Note:

1. The calibration interval of the above test instruments is 12 months and the calibrations are traceable to NML/ROC and NIST/USA.
2. Tested date : Apr. 10, 2014

4.3.3 TEST PROCEDURE

FOR POWER OUTPUT MEASUREMENT

Method PM is used to perform output power measurement, trigger and gating function of wide band power meter is enabled to measure max output power of TX on burst. Duty factor is not added to measured value.

FOR 26dB OCCUPIED BANDWIDTH

1. Set RBW = approximately 1% of the emission bandwidth.
2. Set the VBW > RBW.
3. Detector = Peak.
4. Trace mode = max hold.
5. Measure the maximum width of the emission that is 26 dB down from the peak of the emission. Compare this with the RBW setting of the analyzer. Readjust RBW and repeat measurement as needed until the RBW/EBW ratio is approximately 1%.

4.3.4 DEVIATION FROM TEST STANDARD

No deviation

4.3.5 TEST SETUP

FOR POWER OUTPUT MEASUREMENT

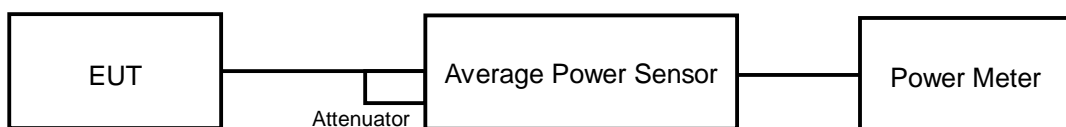

FOR 26dB OCCUPIED BANDWIDTH

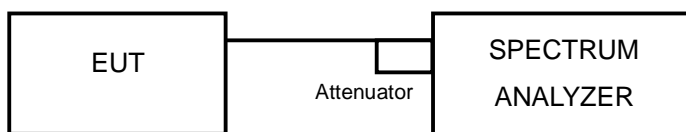

4.3.6 EUT OPERATING CONDITIONS

The software provided by client to enable the EUT under transmission condition continuously at specific channel frequencies individually.

4.3.7 TEST RESULTS (MODE 1)

802.11a, 1Tx

POWER OUTPUT

CHANNEL	CHANNEL FREQUENCY (MHz)	AVERAGE POWER (mW)	AVERAGE POWER (dBm)	POWER LIMIT (dBm)	PASS/FAIL
36	5180	45.082	16.54	17	PASS
40	5200	45.814	16.61	17	PASS
48	5240	46.026	16.63	17	PASS

26dB OCCUPIED BANDWIDTH

CHANNEL	CHANNEL FREQUENCY (MHz)	26dBc BANDWIDTH (MHz)
36	5180	21.44
40	5200	21.37
48	5240	21.41

Note: For output power limitation is determined based on 26dBc bandwidth.

Power Limit = 4dBm + 10logB < UNII Band 1 >			
Channel Number	Freq.(MHz)	Min. B(MHz)	Determined Conducted Limit (dBm)
36	5180	21.44	17.31 > 17
40	5200	21.37	17.29 > 17
48	5240	21.41	17.3 > 17



A D T

**802.11ac (VHT20), 1Tx
POWER OUTPUT**

CHANNEL	CHANNEL FREQUENCY (MHz)	AVERAGE POWER (mW)	AVERAGE POWER (dBm)	POWER LIMIT (dBm)	PASS/FAIL
36	5180	44.259	16.46	17	PASS
40	5200	45.082	16.54	17	PASS
48	5240	44.978	16.53	17	PASS

26dB OCCUPIED BANDWIDTH

CHANNEL	CHANNEL FREQUENCY (MHz)	26dBc BANDWIDTH (MHz)
36	5180	21.99
40	5200	21.96
48	5240	22.00

Note: For output power limitation is determined based on 26dBc bandwidth.

Power Limit = 4dBm + 10logB < UNII Band 1 >			
Channel Number	Freq.(MHz)	Min. B(MHz)	Determined Conducted Limit (dBm)
36	5180	21.99	17.42 > 17
40	5200	21.96	17.41 > 17
48	5240	22.00	17.42 > 17



A D T

**802.11ac (VHT40), 1Tx
POWER OUTPUT**

CHANNEL	CHANNEL FREQUENCY (MHz)	AVERAGE POWER (mW)	AVERAGE POWER (dBm)	POWER LIMIT (dBm)	PASS/FAIL
38	5190	48.978	16.90	17	PASS
46	5230	49.091	16.91	17	PASS

26dB OCCUPIED BANDWIDTH

CHANNEL	CHANNEL FREQUENCY (MHz)	26dBc BANDWIDTH (MHz)
38	5190	45.44
46	5230	45.46

Note: For output power limitation is determined based on 26dBc bandwidth.

Power Limit = 4dBm + 10logB < UNII Band 1 >			
Channel Number	Freq.(MHz)	Min. B(MHz)	Determined Conducted Limit (dBm)
38	5190	45.44	20.57 > 17
46	5230	45.46	20.57 > 17



A D T

**802.11ac (VHT80), 1Tx
POWER OUTPUT**

CHANNEL	CHANNEL FREQUENCY (MHz)	AVERAGE POWER (mW)	AVERAGE POWER (dBm)	POWER LIMIT (dBm)	PASS/FAIL
42	5210	49.091	16.91	17	PASS

26dB OCCUPIED BANDWIDTH

CHANNEL	CHANNEL FREQUENCY (MHz)	26dBc BANDWIDTH (MHz)
42	5210	84.90

Note: For output power limitation is determined based on 26dBc bandwidth.

Power Limit = $4\text{dBm} + 10\log B$ < UNII Band 1 >			
Channel Number	Freq.(MHz)	Min. B(MHz)	Determined Conducted Limit (dBm)
42	5210	84.90	23.28 > 17



A D T

**802.11ac (VHT20), 2Tx
POWER OUTPUT**

CHAN.	CHAN. FREQ. (MHz)	AVERAGE POWER (dBm)		TOTAL POWER (mW)	TOTAL POWER (dBm)	POWER LIMIT (dBm)	PASS / FAIL
		CHAIN 0	CHAIN 1				
36	5180	13.59	13.54	45.450	16.58	17	PASS
40	5200	13.69	13.29	44.718	16.50	17	PASS
48	5240	13.58	13.28	44.084	16.44	17	PASS

26dB OCCUPIED BANDWIDTH

CHANNEL	CHANNEL FREQUENCY (MHz)	26dBc BANDWIDTH (MHz)	
		CHAIN 0	CHAIN 1
36	5180	21.76	21.70
40	5200	21.73	21.76
48	5240	21.77	21.66

Note: For output power limitation is determined based on 26dBc bandwidth.

Power Limit = 4dBm + 10logB < UNII Band 1 >			
Channel Number	Freq.(MHz)	Min. B(MHz)	Determined Conducted Limit (dBm)
36	5180	21.70	17.36 > 17
40	5200	21.73	17.37 > 17
48	5240	21.66	17.35 > 17



A D T

802.11ac(VHT40), 2Tx

POWER OUTPUT

CHAN.	CHAN. FREQ. (MHz)	AVERAGE POWER (dBm)		TOTAL POWER (mW)	TOTAL POWER (dBm)	POWER LIMIT (dBm)	PASS / FAIL
		CHAIN 0	CHAIN 1				
38	5190	13.89	13.86	48.813	16.89	17	PASS
46	5230	13.89	13.91	49.095	16.91	17	PASS

26dB OCCUPIED BANDWIDTH

CHANNEL	CHANNEL FREQUENCY (MHz)	26dBc BANDWIDTH (MHz)	
		CHAIN 0	CHAIN 1
38	5190	45.34	45.33
46	5230	45.15	45.14

Note: For output power limitation is determined based on 26dBc bandwidth.

Power Limit = 4dBm + 10logB < UNII Band 1 >			
Channel Number	Freq.(MHz)	Min. B(MHz)	Determined Conducted Limit (dBm)
38	5190	45.33	20.56 > 17
46	5230	45.14	20.54 > 17



A D T

802.11ac (VHT80), 2Tx
POWER OUTPUT

CHAN.	CHAN. FREQ. (MHz)	AVERAGE POWER (dBm)		TOTAL POWER (mW)	TOTAL POWER (dBm)	POWER LIMIT (dBm)	PASS / FAIL
		CHAIN 0	CHAIN 1				
42	5210	13.69	13.69	46.776	16.70	17	PASS

26dB OCCUPIED BANDWIDTH

CHANNEL	CHANNEL FREQUENCY (MHz)	26dBc BANDWIDTH (MHz)	
		CHAIN 0	CHAIN 1
42	5210	84.57	86.86

Note: For output power limitation is determined based on 26dBc bandwidth.

Power Limit = $4\text{dBm} + 10\log B$ < UNII Band 1 >			
Channel Number	Freq.(MHz)	Min. B(MHz)	Determined Conducted Limit (dBm)
42	5210	84.57	23.27 > 17



A D T

4.3.8 TEST RESULTS (MODE 2)

802.11a, 1Tx

POWER OUTPUT

CHANNEL	CHANNEL FREQUENCY (MHz)	AVERAGE POWER (mW)	AVERAGE POWER (dBm)	POWER LIMIT (dBm)	PASS/FAIL
36	5180	10.399	10.17	10.50	PASS
40	5200	9.886	9.95	10.50	PASS
48	5240	10.423	10.18	10.50	PASS

Note: 5150~5250MHz: The directional gain is 12.50dBi > 6dBi, therefore the limit needs to reduce, so the power limit shall be reduced to "Determined Conducted Limit-(12.50-6)".

26dB OCCUPIED BANDWIDTH

CHANNEL	CHANNEL FREQUENCY (MHz)	26dBc BANDWIDTH (MHz)
36	5180	21.29
40	5200	21.24
48	5240	21.24

Note: For output power limitation is determined based on 26dBc bandwidth.

Power Limit = 4dBm + 10logB < UNII Band 1 >			
Channel Number	Freq.(MHz)	Min. B(MHz)	Determined Conducted Limit (dBm)
36	5180	21.29	17.28 > 17
40	5200	21.24	17.27 > 17
48	5240	21.24	17.27 > 17



A D T

**802.11ac (VHT20), 1Tx
POWER OUTPUT**

CHANNEL	CHANNEL FREQUENCY (MHz)	AVERAGE POWER (mW)	AVERAGE POWER (dBm)	POWER LIMIT (dBm)	PASS/FAIL
36	5180	10.351	10.15	10.50	PASS
40	5200	10.304	10.13	10.50	PASS
48	5240	9.817	9.92	10.50	PASS

Note: 5150~5250MHz: The directional gain is 12.50dBi > 6dBi, therefore the limit needs to reduce, so the power limit shall be reduced to "Determined Conducted Limit-(12.50-6)".

26dB OCCUPIED BANDWIDTH

CHANNEL	CHANNEL FREQUENCY (MHz)	26dBc BANDWIDTH (MHz)
36	5180	21.98
40	5200	21.90
48	5240	21.92

Note: For output power limitation is determined based on 26dBc bandwidth.

Power Limit = 4dBm + 10logB < UNII Band 1 >			
Channel Number	Freq.(MHz)	Min. B(MHz)	Determined Conducted Limit (dBm)
36	5180	21.98	17.42 > 17
40	5200	21.90	17.4 > 17
48	5240	21.92	17.4 > 17



A D T

**802.11ac (VHT40), 1Tx
POWER OUTPUT**

CHANNEL	CHANNEL FREQUENCY (MHz)	AVERAGE POWER (mW)	AVERAGE POWER (dBm)	POWER LIMIT (dBm)	PASS/FAIL
38	5190	10.447	10.19	10.50	PASS
46	5230	10.399	10.17	10.50	PASS

Note: 5150~5250MHz: The directional gain is 12.50dBi > 6dBi, therefore the limit needs to reduce, so the power limit shall be reduced to "Determined Conducted Limit-(12.50-6)".

26dB OCCUPIED BANDWIDTH

CHANNEL	CHANNEL FREQUENCY (MHz)	26dBc BANDWIDTH (MHz)
38	5190	45.37
46	5230	45.59

Note: For output power limitation is determined based on 26dBc bandwidth.

Power Limit = 4dBm + 10logB < UNII Band 1 >			
Channel Number	Freq.(MHz)	Min. B(MHz)	Determined Conducted Limit (dBm)
38	5190	45.37	20.56 > 17
46	5230	45.59	20.58 > 17



A D T

802.11ac (VHT80), 1Tx
POWER OUTPUT

CHANNEL	CHANNEL FREQUENCY (MHz)	AVERAGE POWER (mW)	AVERAGE POWER (dBm)	POWER LIMIT (dBm)	PASS/FAIL
42	5210	10.889	10.37	10.50	PASS

Note: 5150~5250MHz: The directional gain is 12.50dBi > 6dBi, therefore the limit needs to reduce, so the power limit shall be reduced to "Determined Conducted Limit-(12.50-6)".

26dB OCCUPIED BANDWIDTH

CHANNEL	CHANNEL FREQUENCY (MHz)	26dBc BANDWIDTH (MHz)
42	5210	84.81

Note: For output power limitation is determined based on 26dBc bandwidth.

Power Limit = 4dBm + 10logB < UNII Band 1 >			
Channel Number	Freq.(MHz)	Min. B(MHz)	Determined Conducted Limit (dBm)
42	5210	84.81	23.28 > 17



A D T

**802.11ac (VHT20), 2Tx
POWER OUTPUT**

CHAN.	CHAN. FREQ. (MHz)	AVERAGE POWER (dBm)		TOTAL POWER (mW)	TOTAL POWER (dBm)	POWER LIMIT (dBm)	PASS / FAIL
		CHAIN 0	CHAIN 1				
36	5180	7.09	7.04	10.175	10.08	10.50	PASS
40	5200	6.94	7.17	10.155	10.07	10.50	PASS
48	5240	6.88	7.21	10.135	10.06	10.50	PASS

Note: 5150~5250MHz: The directional gain is 12.50dBi > 6dBi, therefore the limit needs to reduce, so the power limit shall be reduced to "Determined Conducted Limit-(12.50-6)".

26dB OCCUPIED BANDWIDTH

CHANNEL	CHANNEL FREQUENCY (MHz)	26dBc BANDWIDTH (MHz)	
		CHAIN 0	CHAIN 1
36	5180	21.74	21.59
40	5200	21.70	21.69
48	5240	21.44	21.60

Note: For output power limitation is determined based on 26dBc bandwidth.

Power Limit = 4dBm + 10logB < UNII Band 1 >			
Channel Number	Freq.(MHz)	Min. B(MHz)	Determined Conducted Limit (dBm)
36	5180	21.59	17.34 > 17
40	5200	21.69	17.36 > 17
48	5240	21.44	17.31 > 17



A D T

**802.11ac(VHT40), 2Tx
POWER OUTPUT**

CHAN.	CHAN. FREQ. (MHz)	AVERAGE POWER (dBm)		TOTAL POWER (mW)	TOTAL POWER (dBm)	POWER LIMIT (dBm)	PASS / FAIL
		CHAIN 0	CHAIN 1				
38	5190	7.29	7.14	10.534	10.23	10.50	PASS
46	5230	7.56	7.28	11.048	10.43	10.50	PASS

Note: 5150~5250MHz: The directional gain is 12.50dBi > 6dBi, therefore the limit needs to reduce, so the power limit shall be reduced to "Determined Conducted Limit-(12.50-6)".

26dB OCCUPIED BANDWIDTH

CHANNEL	CHANNEL FREQUENCY (MHz)	26dBc BANDWIDTH (MHz)	
		CHAIN 0	CHAIN 1
38	5190	45.37	45.07
46	5230	45.17	45.24

Note: For output power limitation is determined based on 26dBc bandwidth.

Power Limit = 4dBm + 10logB < UNII Band 1 >			
Channel Number	Freq.(MHz)	Min. B(MHz)	Determined Conducted Limit (dBm)
38	5190	45.07	20.53 > 17
46	5230	45.17	20.54 > 17



A D T

802.11ac (VHT80), 2Tx
POWER OUTPUT

CHAN.	CHAN. FREQ. (MHz)	AVERAGE POWER (dBm)		TOTAL POWER (mW)	TOTAL POWER (dBm)	POWER LIMIT (dBm)	PASS / FAIL
		CHAIN 0	CHAIN 1				
42	5210	7.21	7.51	10.896	10.37	10.50	PASS

Note: 5150~5250MHz: The directional gain is 12.50dBi > 6dBi, therefore the limit needs to reduce, so the power limit shall be reduced to "Determined Conducted Limit-(12.50-6)".

26dB OCCUPIED BANDWIDTH

CHANNEL	CHANNEL FREQUENCY (MHz)	26dBc BANDWIDTH (MHz)	
		CHAIN 0	CHAIN 1
42	5210	84.71	86.50

Note: For output power limitation is determined based on 26dBc bandwidth.

Power Limit = 4dBm + 10logB < UNII Band 1 >			
Channel Number	Freq.(MHz)	Min. B(MHz)	Determined Conducted Limit (dBm)
42	5210	84.71	23.27 > 17

4.4 PEAK POWER SPECTRAL DENSITY MEASUREMENT

4.4.1 LIMITS OF PEAK POWER SPECTRAL DENSITY MEASUREMENT

Frequency Band	Limit
5.15 ~ 5.25GHz	4dBm
5.25 ~ 5.35GHz	11dBm
5.47 ~ 5.725GHz	11dBm
5.725 ~ 5.825GHz	17dBm

4.4.2 TEST INSTRUMENTS

DESCRIPTION & MANUFACTURER	MODEL NO.	SERIAL NO.	CALIBRATED DATE	CALIBRATED UNTIL
Spectrum Analyzer R&S	FSV 40	100964	July 15, 2013	July 14, 2014

Note:

1. The calibration interval of the above test instruments is 12 months and the calibrations are traceable to NML/ROC and NIST/USA.
2. Tested date : Apr. 10, 2014

4.4.3 TEST PROCEDURES

Using method SA-1

1. Set span to encompass the entire emission bandwidth (EBW) of the signal.
2. Set RBW = 1 MHz, Set VBW \geq 3 MHz, Detector = RMS
3. Sweep time = auto, trigger set to "free run".
4. Trace average at least 100 traces in power averaging mode.
5. Record the max value

4.4.4 DEVIATION FROM TEST STANDARD

No deviation

4.4.5 TEST SETUP

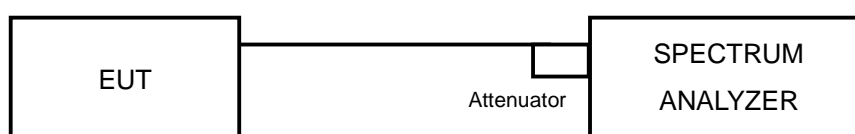



A D T

4.4.6 EUT OPERATING CONDITIONS

Same as 4.3.6



A D T

4.4.7 TEST RESULTS (MODE 1)

802.11a, 1Tx

CHANNEL	FREQUENCY (MHz)	PSD (dBm)	MAXIMUM LIMIT (dBm)	PASS/FAIL
36	5180	3.40	4	PASS
40	5200	3.55	4	PASS
48	5240	3.60	4	PASS

802.11ac (VHT20), 1Tx

CHANNEL	FREQUENCY (MHz)	PSD (dBm)	MAXIMUM LIMIT (dBm)	PASS/FAIL
36	5180	3.07	4	PASS
40	5200	3.15	4	PASS
48	5240	3.22	4	PASS

802.11ac (VHT40), 1Tx

CHANNEL	FREQUENCY (MHz)	PSD (dBm)	MAXIMUM LIMIT (dBm)	PASS/FAIL
38	5190	0.46	4	PASS
46	5230	0.61	4	PASS

802.11ac (VHT80), 1Tx

CHANNEL	FREQUENCY (MHz)	PSD (dBm)	MAXIMUM LIMIT (dBm)	PASS/FAIL
42	5210	-1.73	4	PASS



A D T

SPECTRUM PLOT OF WORST VALUE

802.11a : CH48

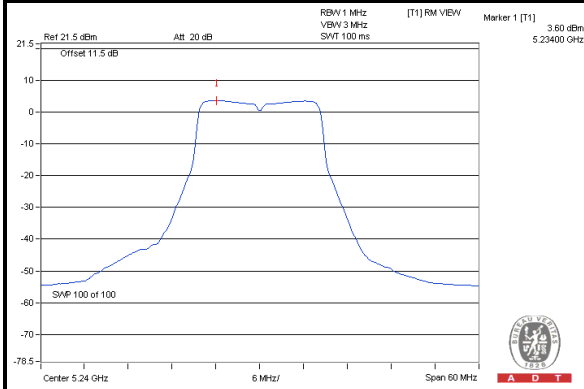

802.11ac (VHT20) : CH48

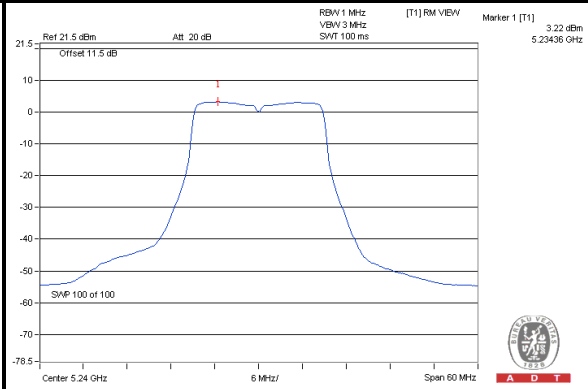

802.11ac (VHT40) : CH46

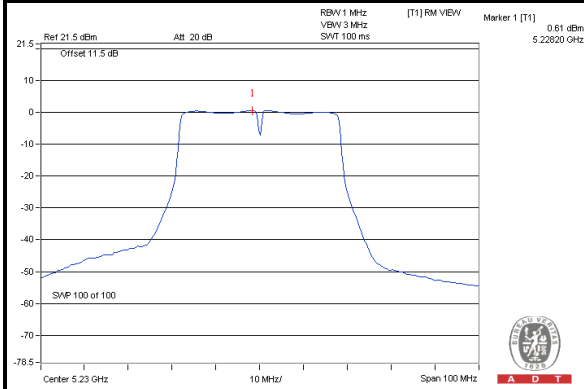

802.11ac (VHT80) : CH42

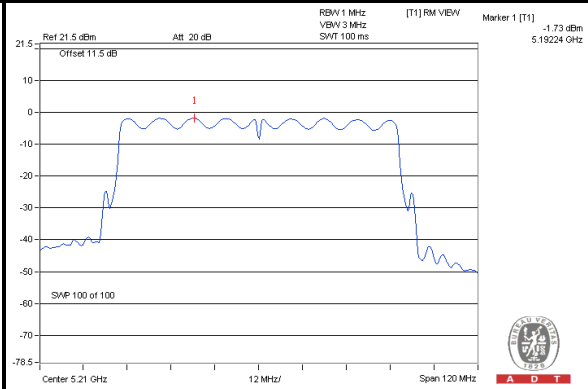



A D T

802.11ac (VHT20), 2Tx

CHANNEL	CHANNEL FREQUENCY (MHz)	PSD (dBm)		TOTAL POWER DENSITY (dBm)	MAX. LIMIT (dBm)	PASS/FAIL
		CHAIN 0	CHAIN 1			
36	5180	-0.09	-0.04	2.95	4	PASS
40	5200	0.07	0.00	3.05	4	PASS
48	5240	-0.22	0.33	3.07	4	PASS

NOTE: 1. Method 1) of power density measurement of KDB 662911 is using for calculating total power density. Total power density is summing entire spectra across corresponding frequency bins on the various outputs by computer.

802.11ac (VHT40), 2Tx

CHANNEL	CHANNEL FREQUENCY (MHz)	PSD (dBm)		TOTAL POWER DENSITY (dBm)	MAX. LIMIT (dBm)	PASS/FAIL
		CHAIN 0	CHAIN 1			
38	5190	-2.53	-2.45	0.52	4	PASS
46	5230	-2.74	-2.39	0.45	4	PASS

NOTE: 1. Method 1) of power density measurement of KDB 662911 is using for calculating total power density. Total power density is summing entire spectra across corresponding frequency bins on the various outputs by computer.

802.11ac (VHT80), 2Tx

CHANNEL	CHANNEL FREQUENCY (MHz)	PSD (dBm)		TOTAL POWER DENSITY (dBm)	MAX. LIMIT (dBm)	PASS/FAIL
		CHAIN 0	CHAIN 1			
42	5210	-4.69	-4.56	-1.61	4	PASS

NOTE: 1. Method 1) of power density measurement of KDB 662911 is using for calculating total power density. Total power density is summing entire spectra across corresponding frequency bins on the various outputs by computer.



A D T

SPECTRUM PLOT OF WORST VALUE

802.11ac (VHT20) / Chain(1) : CH48

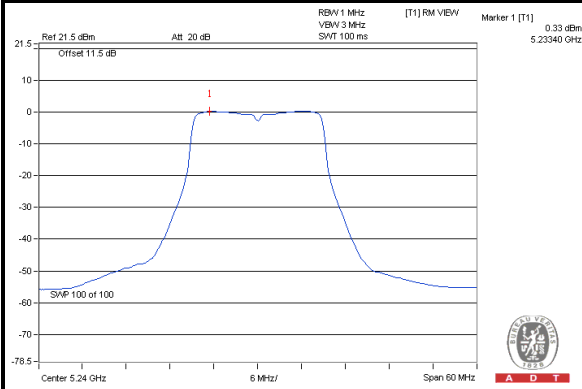

802.11ac (VHT40) / Chain(1) : CH46

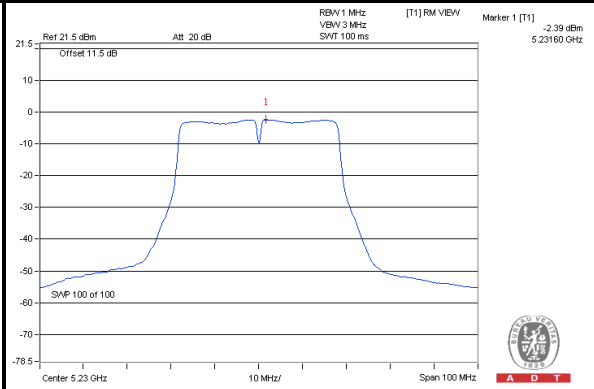

802.11ac (VHT80) / Chain(1) : CH42

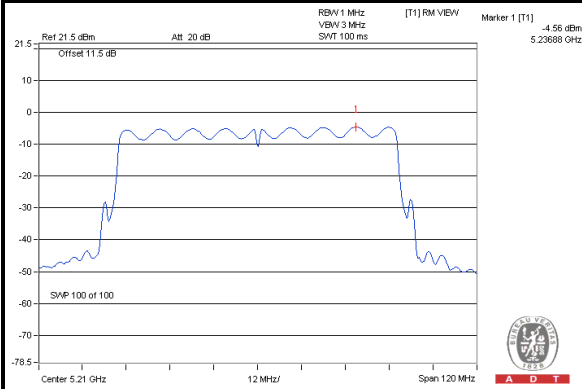



A D T

4.4.8 TEST RESULTS (MODE 2)

802.11a, 1Tx

CHANNEL	FREQUENCY (MHz)	PSD (dBm)	MAXIMUM LIMIT (dBm)	PASS/FAIL
36	5180	-2.52	-2.50	PASS
40	5200	-2.86	-2.50	PASS
48	5240	-2.64	-2.50	PASS

NOTE: 1. The directional gain is 12.50dBi > 6dBi, therefore the limit needs to reduce, so the power density limit shall be reduced to $4-(12.50-6) = -2.50$ dBm.

802.11ac (VHT20), 1Tx

CHANNEL	FREQUENCY (MHz)	PSD (dBm)	MAXIMUM LIMIT (dBm)	PASS/FAIL
36	5180	-2.67	-2.50	PASS
40	5200	-3.09	-2.50	PASS
48	5240	-3.36	-2.50	PASS

NOTE: 1. The directional gain is 12.50dBi > 6dBi, therefore the limit needs to reduce, so the power density limit shall be reduced to $4-(12.50-6) = -2.50$ dBm.

802.11ac (VHT40), 1Tx

CHANNEL	FREQUENCY (MHz)	PSD (dBm)	MAXIMUM LIMIT (dBm)	PASS/FAIL
38	5190	-6.06	-2.50	PASS
46	5230	-6.46	-2.50	PASS

NOTE: 1. The directional gain is 12.50dBi > 6dBi, therefore the limit needs to reduce, so the power density limit shall be reduced to $4-(12.50-6) = -2.50$ dBm.

802.11ac (VHT80), 1Tx

CHANNEL	FREQUENCY (MHz)	PSD (dBm)	MAXIMUM LIMIT (dBm)	PASS/FAIL
42	5210	-8.31	-2.50	PASS

NOTE: 1. The directional gain is 12.50dBi > 6dBi, therefore the limit needs to reduce, so the power density limit shall be reduced to $4-(12.50-6) = -2.50$ dBm.



A D T

SPECTRUM PLOT OF WORST VALUE

802.11a : CH36

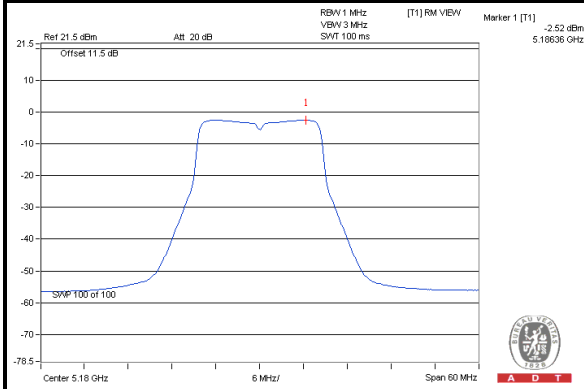

802.11ac (VHT20) : CH36

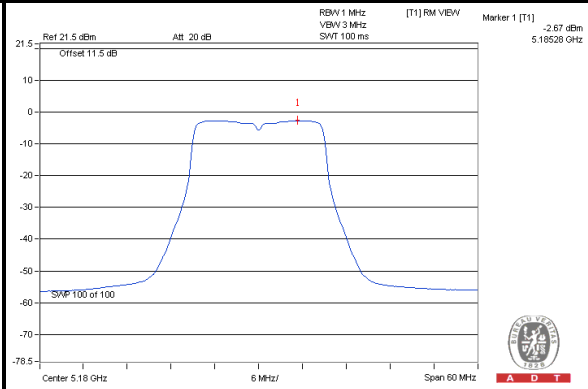

802.11ac (VHT40) : CH38

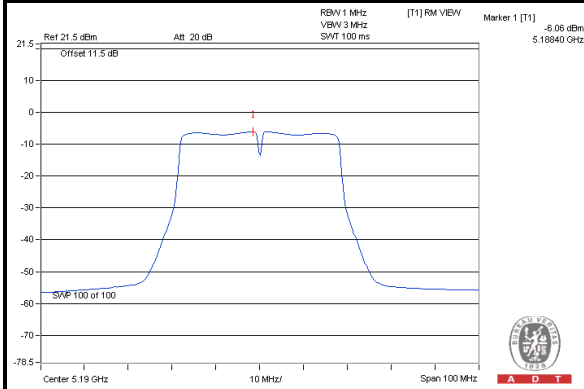

802.11ac (VHT80) : CH42

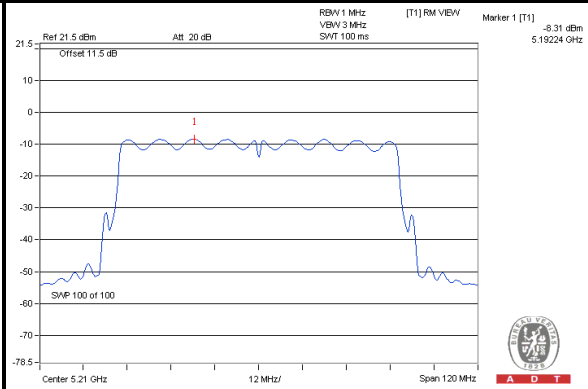



A D T

802.11ac (VHT20), 2Tx

CHANNEL	CHANNEL FREQUENCY (MHz)	PSD (dBm)		TOTAL POWER DENSITY (dBm)	MAX. LIMIT (dBm)	PASS/FAIL
		CHAIN 0	CHAIN 1			
36	5180	-5.97	-5.99	-2.97	-2.50	PASS
40	5200	-6.05	-6.47	-3.24	-2.50	PASS
48	5240	-5.64	-6.01	-2.81	-2.50	PASS

NOTE: 1. Method 1) of power density measurement of KDB 662911 is using for calculating total power density. Total power density is summing entire spectra across corresponding frequency bins on the various outputs by computer.

2. The directional gain is 12.50dBi > 6dBi, therefore the limit needs to reduce, so the power density limit shall be reduced to $4-(12.50-6) = -2.50$ dBm.

802.11ac (VHT40), 2Tx

CHANNEL	CHANNEL FREQUENCY (MHz)	PSD (dBm)		TOTAL POWER DENSITY (dBm)	MAX. LIMIT (dBm)	PASS/FAIL
		CHAIN 0	CHAIN 1			
38	5190	-9.63	-8.96	-6.27	-2.50	PASS
46	5230	-9.25	-8.84	-6.03	-2.50	PASS

NOTE: 1. Method 1) of power density measurement of KDB 662911 is using for calculating total power density. Total power density is summing entire spectra across corresponding frequency bins on the various outputs by computer.

2. The directional gain is 12.50dBi > 6dBi, therefore the limit needs to reduce, so the power density limit shall be reduced to $4-(12.50-6) = -2.50$ dBm.

802.11ac (VHT80), 2Tx

CHANNEL	CHANNEL FREQUENCY (MHz)	PSD (dBm)		TOTAL POWER DENSITY (dBm)	MAX. LIMIT (dBm)	PASS/FAIL
		CHAIN 0	CHAIN 1			
42	5210	-10.88	-10.53	-7.69	-2.50	PASS

NOTE: 1. Method 1) of power density measurement of KDB 662911 is using for calculating total power density. Total power density is summing entire spectra across corresponding frequency bins on the various outputs by computer.

2. The directional gain is 12.50dBi > 6dBi, therefore the limit needs to reduce, so the power density limit shall be reduced to $4-(12.50-6) = -2.50$ dBm.



A D T

SPECTRUM PLOT OF WORST VALUE

802.11ac (VHT20) / Chain(0) : CH48

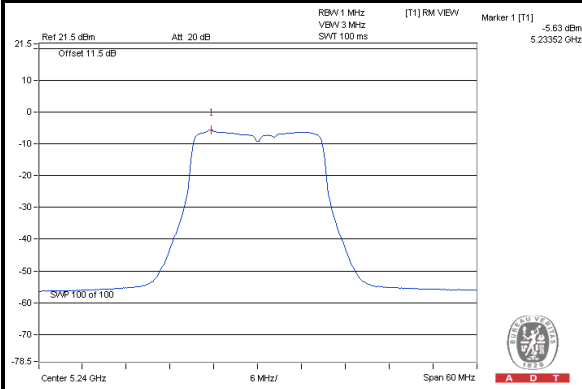

802.11ac (VHT40) / Chain(1) : CH46

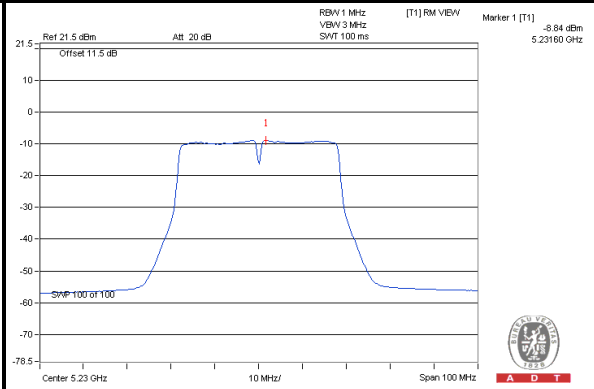

802.11ac (VHT80) / Chain(1) : CH42

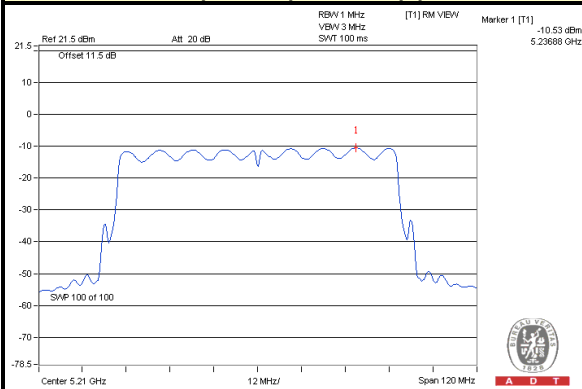

4.5 PEAK POWER EXCURSION MEASUREMENT

4.5.1 LIMITS OF PEAK POWER EXCURSION MEASUREMENT

Shall not exceed 13 dB

4.5.2 TEST INSTRUMENTS

DESCRIPTION & MANUFACTURER	MODEL NO.	SERIAL NO.	CALIBRATED DATE	CALIBRATED UNTIL
Spectrum Analyzer R&S	FSV 40	100964	July 15, 2013	July 14, 2014

Note:

1. The calibration interval of the above test instruments is 12 months and the calibrations are traceable to NML/ROC and NIST/USA.
2. Tested date : Apr. 10, 2014

4.5.3 TEST PROCEDURE

1. Set RBW = 1 MHz, VBW \geq 3 MHz, Detector = peak.
2. Trace mode = max-hold. Allow the sweeps to continue until the trace stabilizes.
3. Use the peak search function to find the peak of the spectrum.
4. Measure the PPSD.
5. Compute the ratio of the maximum of the peak-max-hold spectrum to the PPSD.

4.5.4 DEVIATION FROM TEST STANDARD

No deviation

4.5.5 TEST SETUP

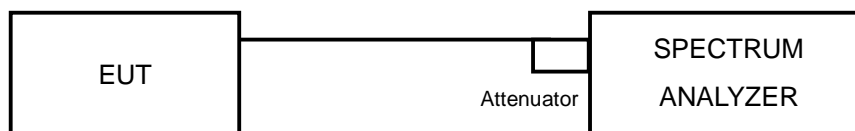

4.5.6 EUT OPERATING CONDITIONS

The software provided by client to enable the EUT under transmission condition continuously at specific channel frequencies individually.



A D T

4.5.7 TEST RESULTS (MODE 1)

For 1Tx

MODULATION MODE	MODULATION TYPE	CHANNEL FREQUENCY (MHz)	PEAK VALUE (dBm)	PPSD (dBm)	PEAK EXCURSION (dB)	LIMIT (dB)	PASS/ FAIL
802.11a	BPSK	5240	11.32	3.60	7.72	13	PASS
	QPSK		12.77	3.50	9.27	13	PASS
	16QAM		12.55	3.53	9.02	13	PASS
	64QAM		13.80	3.61	10.19	13	PASS
802.11ac (VHT20)	BPSK	5240	11.32	3.22	8.10	13	PASS
	QPSK		12.10	3.27	8.83	13	PASS
	16QAM		12.18	3.12	9.06	13	PASS
	64QAM		13.17	3.26	9.91	13	PASS
	256QAM		11.95	3.34	8.61	13	PASS
802.11ac (VHT40)	BPSK	5230	8.86	0.61	8.25	13	PASS
	QPSK		9.89	0.74	9.15	13	PASS
	16QAM		9.74	0.58	9.16	13	PASS
	64QAM		10.40	0.78	9.62	13	PASS
	256QAM		10.51	0.73	9.78	13	PASS
802.11ac (VHT80)	BPSK	5210	6.34	-1.73	8.07	13	PASS
	QPSK		6.75	-1.58	8.33	13	PASS
	16QAM		7.34	-1.44	8.78	13	PASS
	64QAM		6.29	-2.08	8.37	13	PASS
	256QAM		7.19	-1.66	8.85	13	PASS



A D T

SPECTRUM PLOT OF WORST VALUE

802.11a / 64QAM

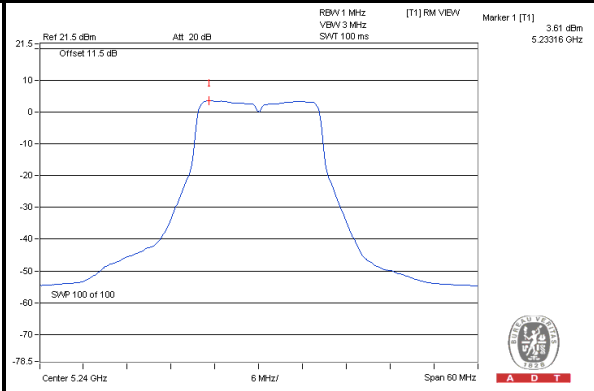
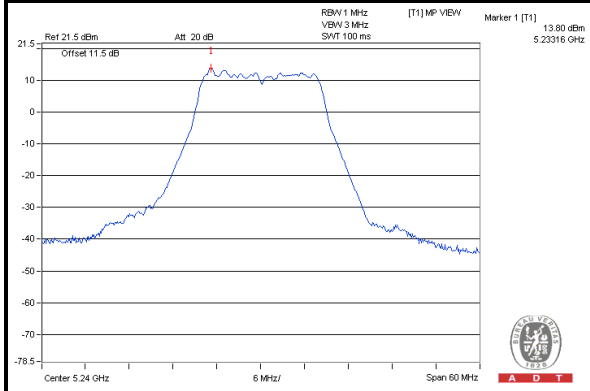

802.11ac (VHT20) / 64QAM

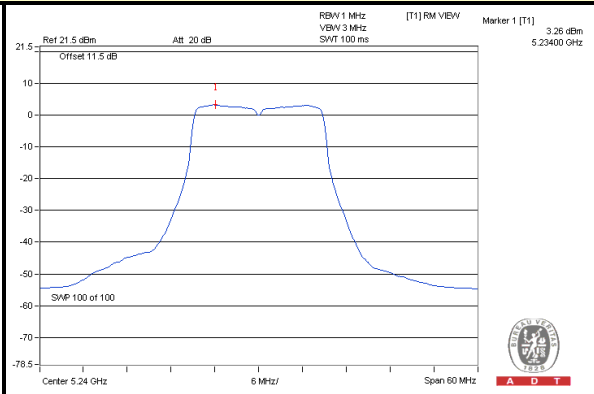
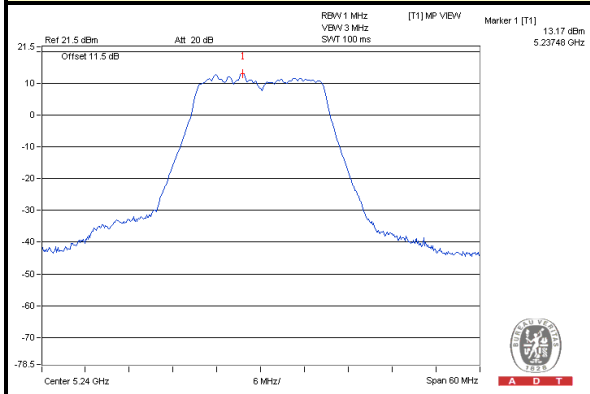



A D T

802.11ac (VHT40) / 256QAM

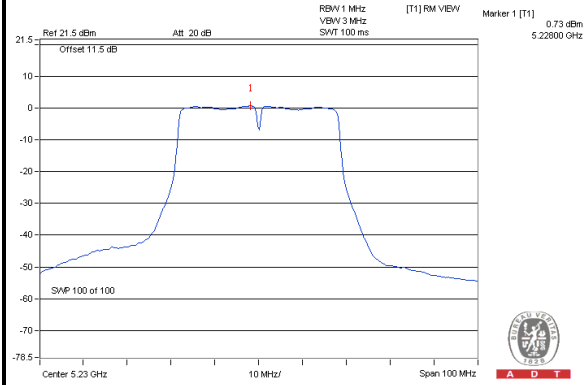
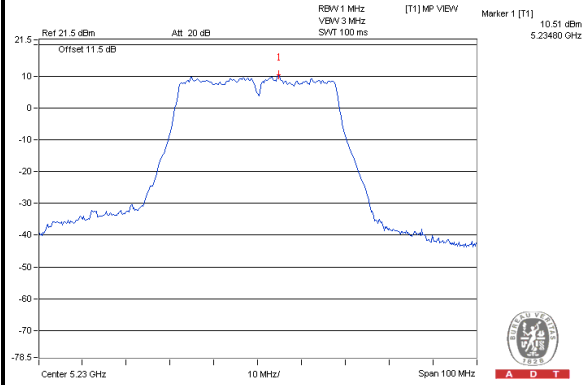

802.11ac (VHT80) / 256QAM

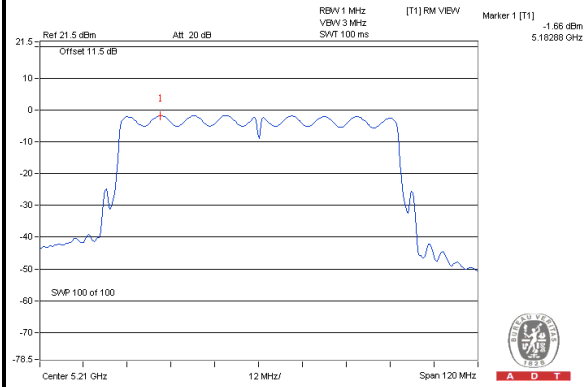
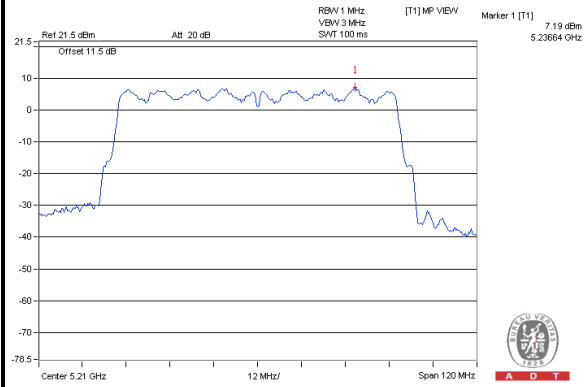



A D T

For 2Tx

MODULATION MODE	MODULATION TYPE	CHANNEL FREQUENCY (MHz)	PEAK VALUE (dBm)	PPSD (dBm)	PEAK EXCURSION (dB)	LIMIT (dB)	PASS/ FAIL
802.11ac (VHT20)	BPSK	5240	7.93	-0.22	8.15	13	PASS
	QPSK		8.58	-0.10	8.68	13	PASS
	16QAM		9.20	0.17	9.03	13	PASS
	64QAM		8.30	-0.37	8.67	13	PASS
	256QAM		8.48	0.16	8.32	13	PASS
802.11ac (VHT40)	BPSK	5230	6.36	-2.72	9.08	13	PASS
	QPSK		6.41	-2.49	8.90	13	PASS
	16QAM		7.83	-2.48	10.31	13	PASS
	64QAM		6.85	-2.65	9.50	13	PASS
	256QAM		6.35	-2.55	8.90	13	PASS
802.11ac (VHT80)	BPSK	5210	3.89	-4.41	8.30	13	PASS
	QPSK		4.16	-4.26	8.42	13	PASS
	16QAM		3.97	-4.43	8.40	13	PASS
	64QAM		4.85	-4.69	9.54	13	PASS
	256QAM		4.88	-3.97	8.85	13	PASS



A D T

SPECTRUM PLOT OF WORST VALUE

802.11ac (VHT20) / 16QAM

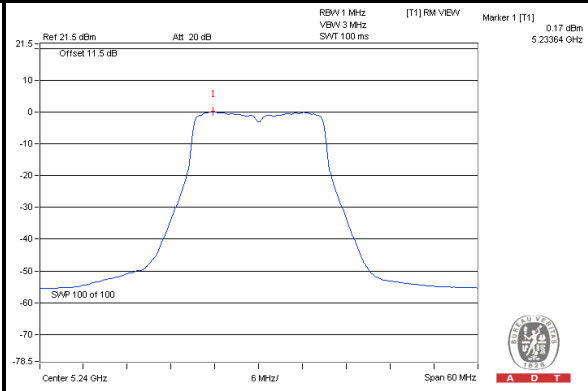
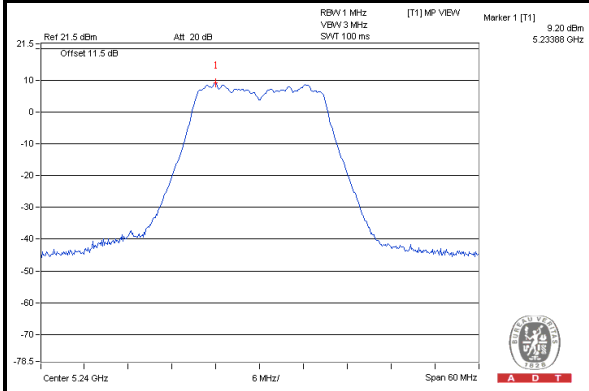

802.11ac (VHT40) / 16QAM

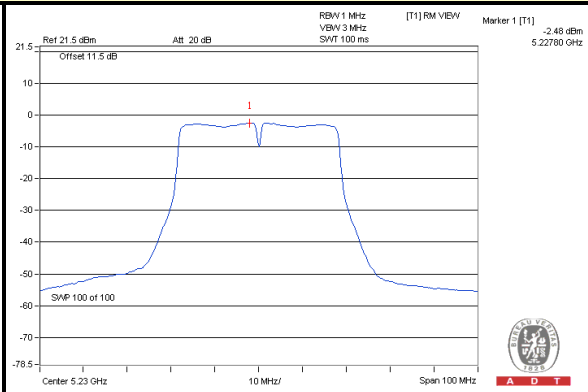
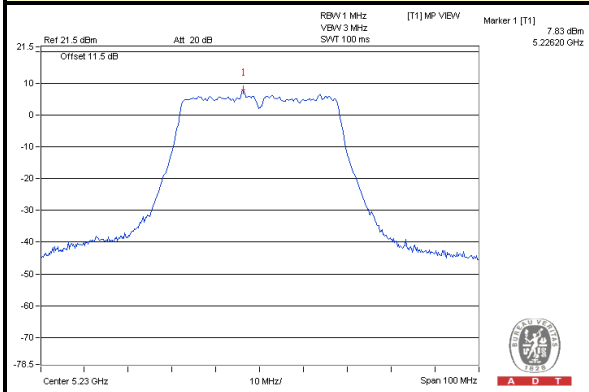

802.11ac (VHT80) / 64QAM

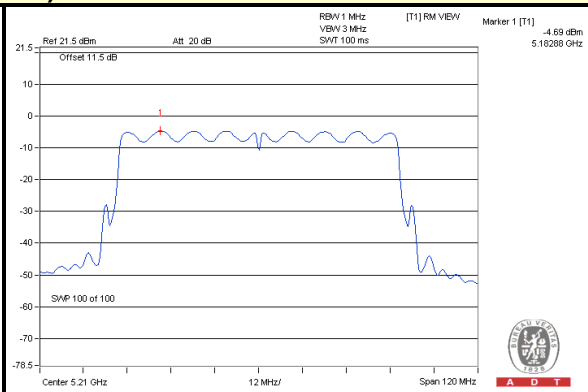
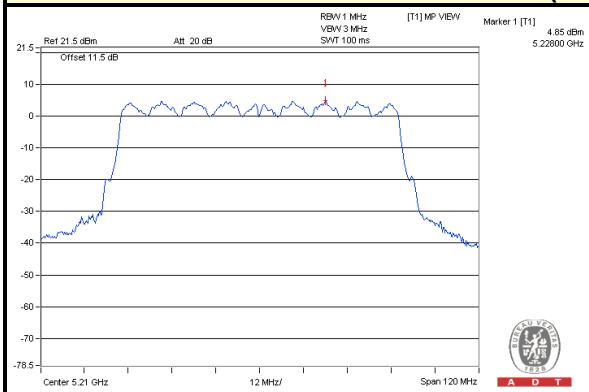



A D T

4.5.8 TEST RESULTS (MODE 2)

For 1Tx

MODULATION MODE	MODULATION TYPE	CHANNEL FREQUENCY (MHz)	PEAK VALUE (dBm)	PPSD (dBm)	PEAK EXCURSION (dB)	LIMIT (dB)	PASS/ FAIL
802.11a	BPSK	5240	4.69	-2.64	7.33	13	PASS
	QPSK		6.85	-2.60	9.45	13	PASS
	16QAM		5.69	-2.80	8.49	13	PASS
	64QAM		6.98	-2.70	9.68	13	PASS
802.11ac (VHT20)	BPSK	5240	4.33	-3.36	7.69	13	PASS
	QPSK		5.18	-3.43	8.61	13	PASS
	16QAM		5.29	-3.47	8.76	13	PASS
	64QAM		6.37	-3.38	9.75	13	PASS
	256QAM		5.01	-3.87	8.88	13	PASS
802.11ac (VHT40)	BPSK	5230	1.33	-6.46	7.79	13	PASS
	QPSK		2.44	-6.69	9.13	13	PASS
	16QAM		2.27	-6.58	8.85	13	PASS
	64QAM		2.99	-6.83	9.82	13	PASS
	256QAM		3.43	-6.24	9.67	13	PASS
802.11ac (VHT80)	BPSK	5210	-0.41	-8.31	7.90	13	PASS
	QPSK		-0.28	-8.61	8.33	13	PASS
	16QAM		0.40	-8.41	8.81	13	PASS
	64QAM		-0.57	-8.61	8.04	13	PASS
	256QAM		0.39	-8.52	8.91	13	PASS



A D T

SPECTRUM PLOT OF WORST VALUE

802.11a / 64QAM

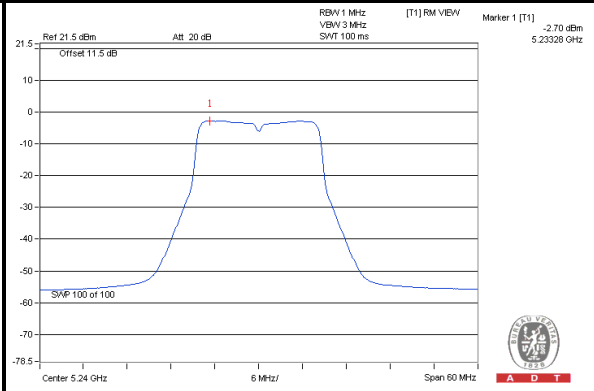
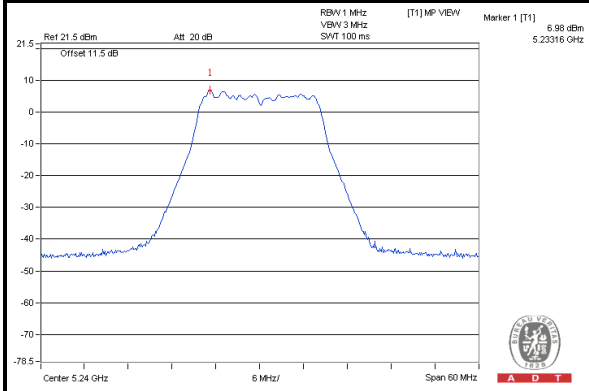

802.11ac (VHT20) / 64QAM

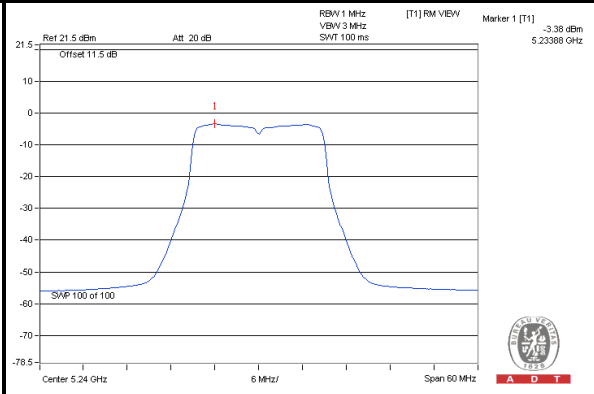
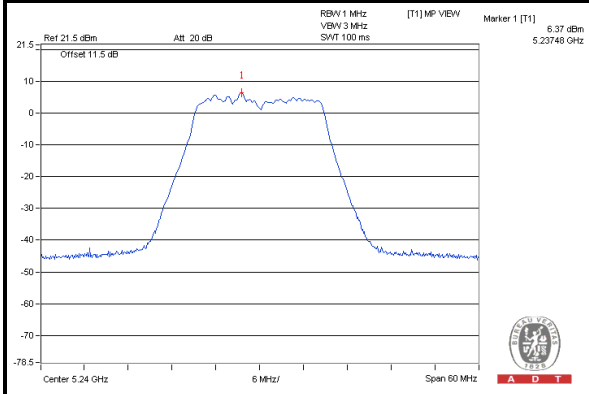



A D T

802.11ac (VHT40) / 64QAM

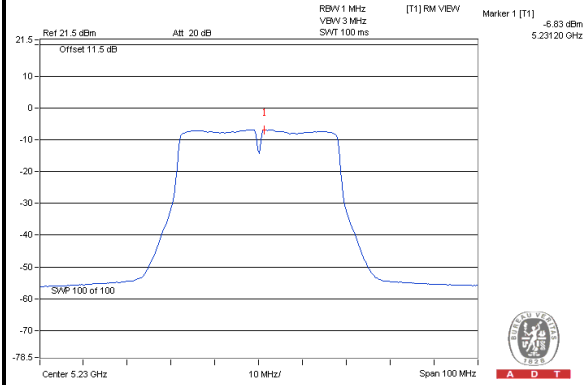
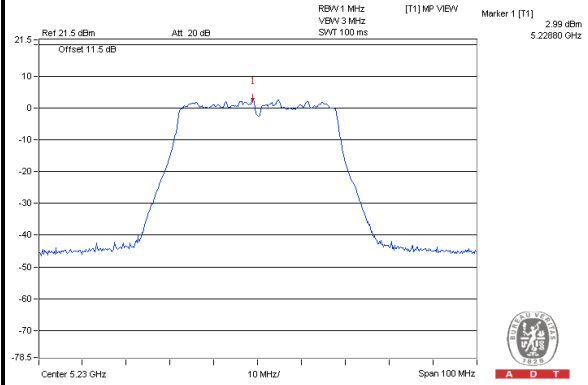

802.11ac (VHT80) / 256QAM

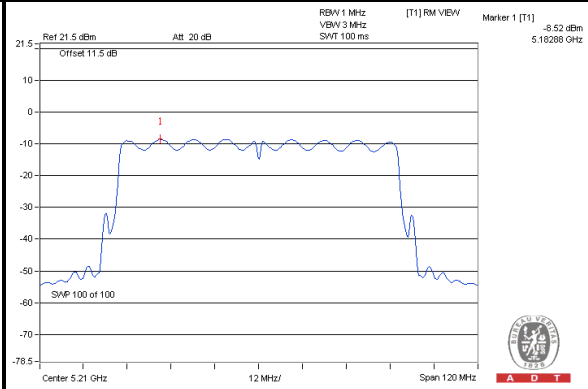
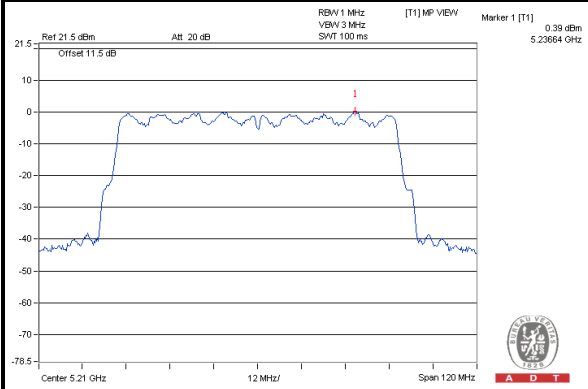



A D T

For 2Tx

MODULATION MODE	MODULATION TYPE	CHANNEL FREQUENCY (MHz)	PEAK VALUE (dBm)	PPSD (dBm)	PEAK EXCURSION (dB)	LIMIT (dB)	PASS/ FAIL
802.11ac (VHT20)	BPSK	5240	2.04	-5.63	7.67	13	PASS
	QPSK		2.61	-5.67	8.28	13	PASS
	16QAM		3.27	-5.81	9.08	13	PASS
	64QAM		2.84	-6.13	8.97	13	PASS
	256QAM		2.31	-5.83	8.14	13	PASS
802.11ac (VHT40)	BPSK	5230	-0.19	-8.92	8.73	13	PASS
	QPSK		0.06	-8.97	9.03	13	PASS
	16QAM		1.28	-8.66	9.94	13	PASS
	64QAM		-0.08	-8.88	8.80	13	PASS
	256QAM		0.11	-8.95	9.06	13	PASS
802.11ac (VHT80)	BPSK	5210	-2.09	-10.67	8.58	13	PASS
	QPSK		-2.14	-10.43	8.29	13	PASS
	16QAM		-1.67	-10.73	9.06	13	PASS
	64QAM		-1.04	-10.57	9.53	13	PASS
	256QAM		-1.36	-10.11	8.75	13	PASS



A D T

SPECTRUM PLOT OF WORST VALUE

802.11ac (VHT20) / 16QAM

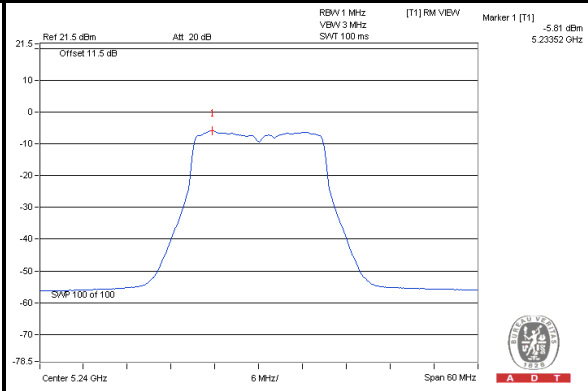
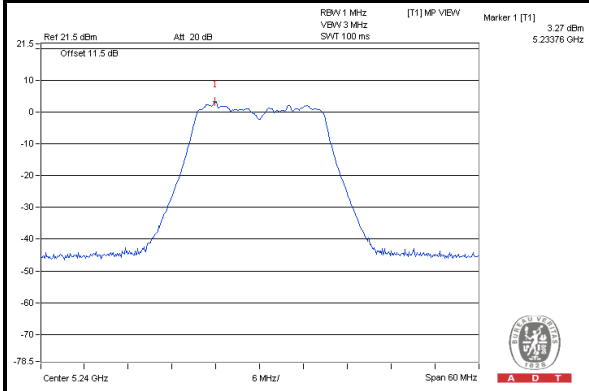

802.11ac (VHT40) / 16QAM

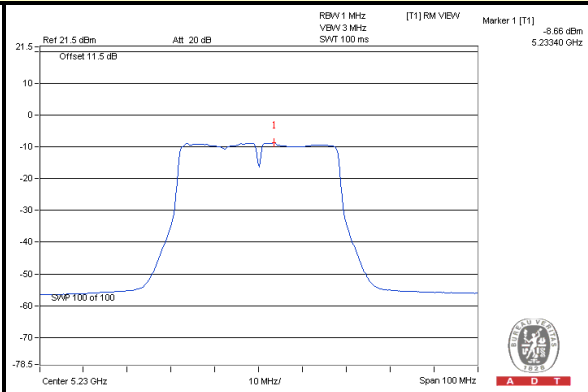
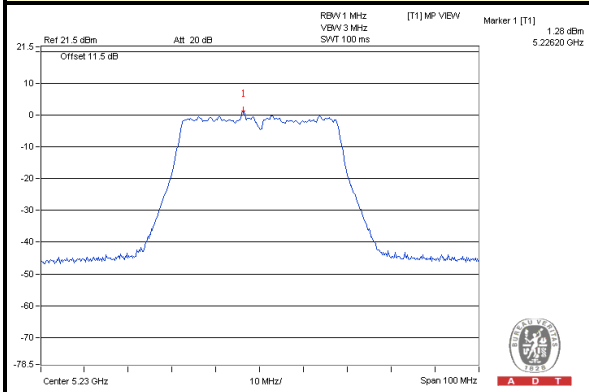

802.11ac (VHT80) / 64QAM

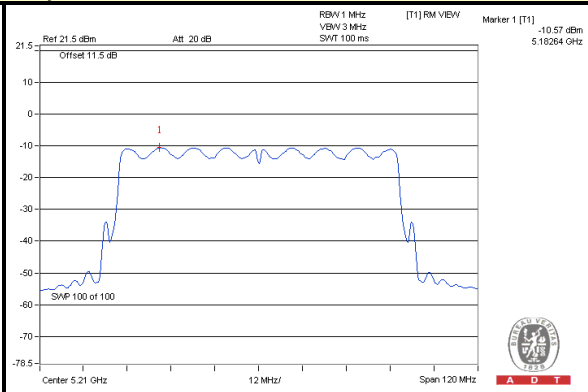
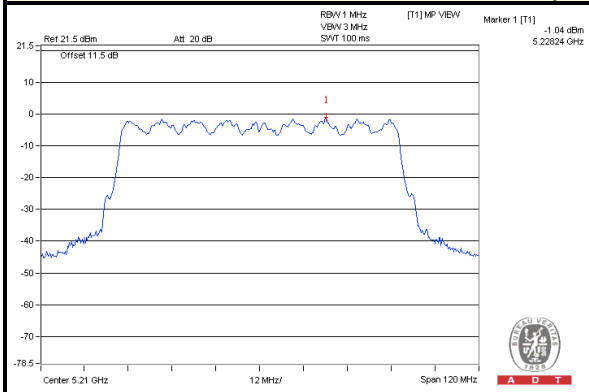



A D T

4.6 FREQUENCY STABILITY

4.6.1 LIMITS OF FREQUENCY STABILITY MEASUREMENT

The frequency of the carrier signal shall be maintained within band of operation

4.6.2 TEST INSTRUMENTS

DESCRIPTION & MANUFACTURER	MODEL NO.	SERIAL NO.	CALIBRATED DATE	CALIBRATED UNTIL
R&S Spectrum Analyzer	FSP40	100036	Jan. 21, 2014	Jan. 20, 2015
Temperature & Humidity Chamber GIANTFORCE	GTH-150-40-S P-AR	MAA0812-008	Jan. 13, 2014	Jan. 12, 2015

Note:

1. The calibration interval of the above test instruments is 12 months and the calibrations are traceable to NML/ROC and NIST/USA.
2. Tested date : Apr. 10, 2014

4.6.3 TEST PROCEDURE

1. The EUT was placed inside the environmental test chamber and powered by nominal AC voltage.
2. Turn the EUT on and couple its output to a spectrum analyzer.
3. Turn the EUT off and set the chamber to the highest temperature specified.
4. Allow sufficient time (approximately 30 min) for the temperature of the chamber to stabilize, turn the EUT on and measure the operating frequency after 2, 5, and 10 minutes.
5. Repeat step 2 and 3 with the temperature chamber set to the lowest temperature.
6. The test chamber was allowed to stabilize at +20 degree C for a minimum of 30 minutes. The supply voltage was then adjusted on the EUT from 85% to 115% and the frequency record.

4.6.4 DEVIATION FROM TEST STANDARD

No deviation

4.6.5 TEST SETUP

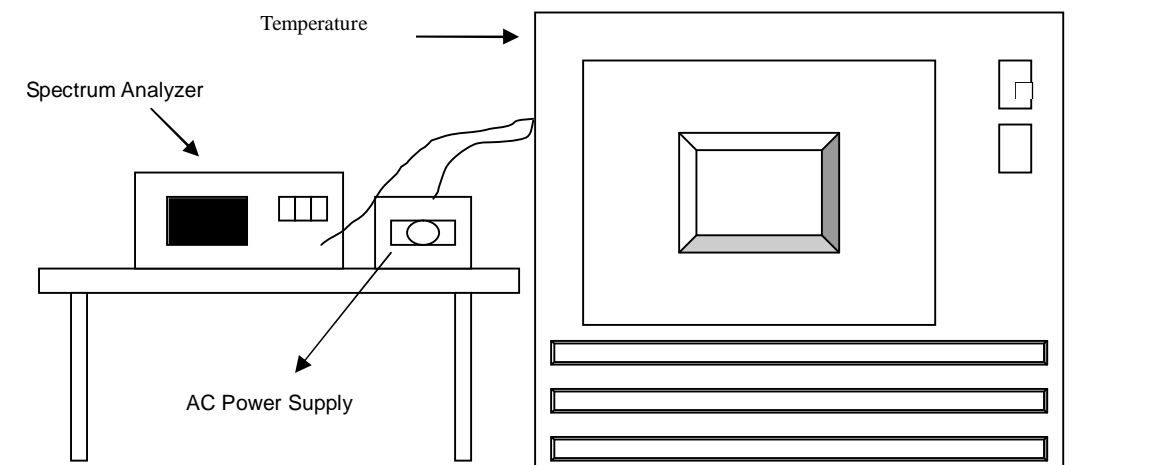

4.6.6 EUT OPERATING CONDITION

Set the EUT transmit at un-modulation mode to test frequency stability.



A D T

4.6.7 TEST RESULTS (MODE 1)

FREQUENCY STABILITY VERSUS TEMP.									
OPERATING FREQUENCY: 5240MHz									
TEMP. (°C)	POWER SUPPLY (Vac)	0 MINUTE		2 MINUTE		5 MINUTE		10 MINUTE	
		Measured Frequency	Frequency Drift	Measured Frequency	Frequency Drift	Measured Frequency	Frequency Drift	Measured Frequency	Frequency Drift
		(MHz)	%	(MHz)	%	(MHz)	%	(MHz)	%
50	120	5239.9967	-0.00006	5239.9962	-0.00007	5239.9962	-0.00007	5239.9989	-0.00002
40	120	5239.9979	-0.00004	5239.9983	-0.00003	5239.9953	-0.00009	5239.9937	-0.00012
30	120	5239.9926	-0.00014	5239.992	-0.00015	5239.9893	-0.00020	5239.9909	-0.00017
20	120	5240.0099	0.00019	5240.0064	0.00012	5240.0108	0.00021	5240.0079	0.00015
10	120	5240.017	0.00032	5240.0192	0.00037	5240.0192	0.00037	5240.0186	0.00035
0	120	5239.9815	-0.00035	5239.9841	-0.00030	5239.9819	-0.00035	5239.9819	-0.00035
-10	120	5239.9943	-0.00011	5239.9912	-0.00017	5239.993	-0.00013	5239.9902	-0.00019
-20	120	5240.013	0.00025	5240.0106	0.00020	5240.0099	0.00019	5240.0118	0.00023
-30	120	5239.986	-0.00027	5239.985	-0.00029	5239.984	-0.00031	5239.9868	-0.00025

FREQUENCY STABILITY VERSUS VOLTAGE									
OPERATING FREQUENCY: 5240MHz									
TEMP. (°C)	POWER SUPPLY (Vac)	0 MINUTE		2 MINUTE		5 MINUTE		10 MINUTE	
		Measured Frequency	Frequency Drift	Measured Frequency	Frequency Drift	Measured Frequency	Frequency Drift	Measured Frequency	Frequency Drift
		(MHz)	%	(MHz)	%	(MHz)	%	(MHz)	%
20	138	5240.0091	0.00017	5240.0062	0.00012	5240.0107	0.00020	5240.0078	0.00015
	120	5240.0099	0.00019	5240.0064	0.00012	5240.0108	0.00021	5240.0079	0.00015
	102	5240.0105	0.00020	5240.0063	0.00012	5240.0104	0.00020	5240.0083	0.00016



4.6.8 TEST RESULTS (MODE 2)

FREQUENCY STABILITY VERSUS TEMP.									
OPERATING FREQUENCY: 5240MHz									
TEMP. (°C)	POWER SUPPLY (Vac)	0 MINUTE		2 MINUTE		5 MINUTE		10 MINUTE	
		Measured Frequency	Frequency Drift	Measured Frequency	Frequency Drift	Measured Frequency	Frequency Drift	Measured Frequency	Frequency Drift
		(MHz)	%	(MHz)	%	(MHz)	%	(MHz)	%
50	120	5239.9849	-0.00029	5239.984	-0.00031	5239.983	-0.00032	5239.9851	-0.00028
40	120	5239.9775	-0.00043	5239.9811	-0.00036	5239.9805	-0.00037	5239.9771	-0.00044
30	120	5239.989	-0.00021	5239.9869	-0.00025	5239.9892	-0.00021	5239.9903	-0.00019
20	120	5240.0223	0.00043	5240.022	0.00042	5240.0208	0.00040	5240.0219	0.00042
10	120	5239.9882	-0.00023	5239.9864	-0.00026	5239.9909	-0.00017	5239.9888	-0.00021
0	120	5239.9827	-0.00033	5239.9824	-0.00034	5239.9854	-0.00028	5239.9857	-0.00027
-10	120	5240.003	0.00006	5240.0008	0.00002	5240.0002	0.00000	5240.0037	0.00007
-20	120	5240.0011	0.00002	5239.9965	-0.00007	5239.9961	-0.00007	5240	0.00000
-30	120	5240.0097	0.00019	5240.011	0.00021	5240.0113	0.00022	5240.0118	0.00023

FREQUENCY STABILITY VERSUS VOLTAGE									
OPERATING FREQUENCY: 5240MHz									
TEMP. (°C)	POWER SUPPLY (Vac)	0 MINUTE		2 MINUTE		5 MINUTE		10 MINUTE	
		Measured Frequency	Frequency Drift	Measured Frequency	Frequency Drift	Measured Frequency	Frequency Drift	Measured Frequency	Frequency Drift
		(MHz)	%	(MHz)	%	(MHz)	%	(MHz)	%
20	138	5240.0227	0.00043	5240.0218	0.00042	5240.0217	0.00041	5240.0209	0.00040
	120	5240.0223	0.00043	5240.022	0.00042	5240.0208	0.00040	5240.0219	0.00042
	102	5240.0232	0.00044	5240.0214	0.00041	5240.0209	0.00040	5240.0217	0.00041



A D T

4.6.9 PHOTOGRAPHS OF THE TEST CONFIGURATION

Please refer to the attached file (Test Setup Photo).





5. INFORMATION ON THE TESTING LABORATORIES

We, Bureau Veritas Consumer Products Services (H.K.) Ltd., Taoyuan Branch, were founded in 1988 to provide our best service in EMC, Radio, Telecom and Safety consultation. Our laboratories are accredited and approved according to ISO/IEC 17025.

If you have any comments, please feel free to contact us at the following:

Linko EMC/RF Lab:

Tel: 886-2-26052180

Fax: 886-2-26052943

Hsin Chu EMC/RF Lab:

Tel: 886-3-5935343

Fax: 886-3-5935342

Hwa Ya EMC/RF/Safety/Telecom Lab:

Tel: 886-3-3183232

Fax: 886-3-3270892

Email: service.adt@tw.bureauveritas.com

Web Site: www.bureauveritas-adt.com

The address and road map of all our labs can be found in our web site also.



A D T

6.APPENDIX A - MODIFICATIONS RECORDERS FOR ENGINEERING CHANGES TO THE EUT BY THE LAB

No modifications were made to the EUT by the lab during the test.

--- END ---