



# FCC TEST REPORT (15.247)

**REPORT NO.:** RF140402E02 R1

**MODEL NO.:** ECWO5320, ECWO5320-L, ECWO5320-C,  
ECWO5324, ECWO5324-L, ECWO5324-C

**FCC ID:** YZKECWO5320

**RECEIVED:** Apr. 02, 2014

**TESTED:** Apr. 08 to 17, 2014

**ISSUED:** May 30, 2014

**APPLICANT:** Edgecore Networks Corporation.

**ADDRESS:** No.1, Creation Rd. III, Hsinchu Science  
Park, Hsinchu 30077, Taiwan, R.O.C

**ISSUED BY:** Bureau Veritas Consumer Products Services  
(H.K.) Ltd., Taoyuan Branch Hsin Chu Laboratory

**LAB ADDRESS :** No. 81-1, Lu Liao Keng, 9th Ling, Wu Lung Tsuen,  
Chiung Lin Hsiang, Hsin Chu Hsien 307, Taiwan,  
R.O.C.

**TEST LOCATION (1):** No. 81-1, Lu Liao Keng, 9th Ling, Wu Lung Tsuen,  
Chiung Lin Hsiang, Hsin Chu Hsien 307, Taiwan,  
R.O.C.

**TEST LOCATION (2):** No. 49, Ln. 206, Wende Rd., Shangshan Tsuen,  
Chiung Lin Hsiang, Hsin Chu Hsien 307, Taiwan,  
R.O.C.

This report should not be used by the client to claim  
product certification, approval, or endorsement by TAF  
or any government agencies.



This report is for your exclusive use. Any copying or replication of this report to or for any other person or entity, or use of our name or trademark, is permitted only with our prior written permission. This report sets forth our findings solely with respect to the test samples identified herein. The results set forth in this report are not indicative or representative of the quality or characteristics of the lot from which a test sample was taken or any similar or identical product unless specifically and expressly noted. Our report includes all of the tests requested by you and the results thereof based upon the information that you provided to us. You have 60 days from date of issuance of this report to notify us of any material error or omission caused by our negligence, provided, however, that such notice shall be in writing and shall specifically address the issue you wish to raise. A failure to raise such issue within the prescribed time shall constitute your unqualified acceptance of the completeness of this report, the tests conducted and the correctness of the report contents. Unless specific mention, the uncertainty of measurement has been explicitly taken into account to declare the compliance or non-compliance to the specification



A D T

## Table of Contents

RELEASE CONTROL RECORD .....	5
1. CERTIFICATION .....	6
2. SUMMARY OF TEST RESULTS .....	7
2.1 MEASUREMENT UNCERTAINTY .....	9
3. GENERAL INFORMATION .....	10
3.1 GENERAL DESCRIPTION OF EUT .....	10
3.2 DESCRIPTION OF TEST MODES .....	14
3.2.1 TEST MODE APPLICABILITY AND TESTED CHANNEL DETAIL .....	15
3.3 GENERAL DESCRIPTION OF APPLIED STANDARDS .....	19
3.4 DUTY CYCLE OF TEST SIGNAL .....	20
3.5 DESCRIPTION OF SUPPORT UNITS .....	23
3.6 CONFIGURATION OF SYSTEM UNDER TEST .....	24
4. TEST TYPES AND RESULTS (FOR 2.4GHz, 2.400 ~ 2.4835GHz Band) .....	25
4.1 CONDUCTED EMISSION MEASUREMENT .....	25
4.1.1 LIMITS OF CONDUCTED EMISSION MEASUREMENT .....	25
4.1.2 TEST INSTRUMENTS .....	25
4.1.3 TEST PROCEDURES .....	26
4.1.4 DEVIATION FROM TEST STANDARD .....	26
4.1.5 TEST SETUP .....	26
4.1.6 EUT OPERATING CONDITIONS .....	27
4.1.7 TEST RESULTS .....	28
4.2 RADIATED EMISSION AND BANDEDGE MEASUREMENT .....	30
4.2.1 LIMITS OF RADIATED EMISSION AND BANDEDGE MEASUREMENT .....	30
4.2.2 TEST INSTRUMENTS .....	31
4.2.3 TEST PROCEDURES .....	33
4.2.4 DEVIATION FROM TEST STANDARD .....	33
4.2.5 TEST SETUP .....	34
4.2.6 EUT OPERATING CONDITIONS .....	34
4.2.7 TEST RESULTS .....	35
4.3 6dB BANDWIDTH MEASUREMENT .....	54
4.3.1 LIMITS OF 6dB BANDWIDTH MEASUREMENT .....	54
4.3.2 TEST INSTRUMENTS .....	54
4.3.3 TEST PROCEDURE .....	54
4.3.4 DEVIATION FROM TEST STANDARD .....	54
4.3.5 TEST SETUP .....	54
4.3.6 EUT OPERATING CONDITIONS .....	54
4.3.7 TEST RESULTS .....	55
4.4 CONDUCTED OUTPUT POWER MEASUREMENT .....	58
4.4.1 LIMITS OF CONDUCTED OUTPUT POWER MEASUREMENT .....	58
4.4.2 INSTRUMENTS .....	58
4.4.3 TEST PROCEDURES .....	58
4.4.4 DEVIATION FROM TEST STANDARD .....	59
4.4.5 TEST SETUP .....	59
4.4.6 EUT OPERATING CONDITIONS .....	59
4.4.7 TEST RESULTS .....	60
4.5 POWER SPECTRAL DENSITY MEASUREMENT .....	62
4.5.1 LIMITS OF POWER SPECTRAL DENSITY MEASUREMENT .....	62
4.5.2 TEST INSTRUMENTS .....	62
4.5.3 TEST PROCEDURE .....	62
4.5.4 DEVIATION FROM TEST STANDARD .....	62



A D T

4.5.5	TEST SETUP .....	62
4.5.6	EUT OPERATING CONDITION .....	62
4.5.7	TEST RESULTS .....	63
4.6	CONDUCTED OUT-BAND EMISSION MEASUREMENT .....	66
4.6.1	LIMITS OF CONDUCTED OUT-BAND EMISSION MEASUREMENT .....	66
4.6.2	TEST INSTRUMENTS .....	66
4.6.3	TEST PROCEDURE .....	66
4.6.4	DEVIATION FROM TEST STANDARD .....	67
4.6.5	TEST SETUP .....	67
4.6.6	EUT OPERATING CONDITION .....	67
4.6.7	TEST RESULTS .....	67
5.	TEST TYPES AND RESULTS (FOR 5gHz, 5.725~5.850GHz Band) .....	76
5.1	CONDUCTED EMISSION MEASUREMENT .....	76
5.1.1	LIMITS OF CONDUCTED EMISSION MEASUREMENT .....	76
5.1.2	TEST INSTRUMENTS .....	76
5.1.3	TEST PROCEDURES .....	77
5.1.4	DEVIATION FROM TEST STANDARD .....	77
5.1.5	TEST SETUP .....	77
5.1.6	EUT OPERATING CONDITIONS .....	78
5.1.7	TEST RESULTS .....	79
5.2	RADIATED AND BANDEDGE EMISSION MEASUREMENT .....	81
5.2.1	LIMITS OF RADIATED AND BANDEDGE EMISSION MEASUREMENT .....	81
5.2.2	TEST INSTRUMENTS .....	82
5.2.3	TEST PROCEDURES .....	84
5.2.4	DEVIATION FROM TEST STANDARD .....	84
5.2.5	TEST SETUP .....	85
5.2.6	EUT OPERATING CONDITIONS .....	85
5.2.7	TEST RESULTS (MODE 1) .....	86
5.2.8	TEST RESULTS (MODE 2) .....	102
5.3	6dB BANDWIDTH MEASUREMENT .....	118
5.3.1	LIMITS OF 6dB BANDWIDTH MEASUREMENT .....	118
5.3.2	TEST INSTRUMENTS .....	118
5.3.3	TEST PROCEDURE .....	118
5.3.4	DEVIATION FROM TEST STANDARD .....	118
5.3.5	TEST SETUP .....	118
5.3.6	EUT OPERATING CONDITIONS .....	118
5.3.7	TEST RESULTS (MODE 1) .....	119
5.3.8	TEST RESULTS (MODE 2) .....	123
5.4	CONDUCTED OUTPUT POWER MEASUREMENT .....	127
5.4.1	LIMITS OF CONDUCTED OUTPUT POWER MEASUREMENT .....	127
5.4.2	INSTRUMENTS .....	127
5.4.3	TEST PROCEDURES .....	128
5.4.4	DEVIATION FROM TEST STANDARD .....	128
5.4.5	TEST SETUP .....	128
5.4.6	EUT OPERATING CONDITIONS .....	128
5.4.7	TEST RESULTS (MODE 1) .....	129
5.4.8	TEST RESULTS (MODE 2) .....	131
5.5	POWER SPECTRAL DENSITY MEASUREMENT .....	133
5.5.1	LIMITS OF POWER SPECTRAL DENSITY MEASUREMENT .....	133
5.5.2	TEST INSTRUMENTS .....	133
5.5.3	TEST PROCEDURE .....	133
5.5.4	DEVIATION FROM TEST STANDARD .....	133



A D T

5.5.5	TEST SETUP .....	133
5.5.6	EUT OPERATING CONDITION.....	134
5.5.7	TEST RESULTS (MODE 1) .....	135
5.5.8	TEST RESULTS (MODE 2) .....	139
5.6	CONDUCTED OUT-BAND EMISSION MEASUREMENT.....	143
5.6.1	LIMITS OF CONDUCTED OUT-BAND EMISSION MEASUREMENT.....	143
5.6.2	TEST INSTRUMENTS.....	143
5.6.3	TEST PROCEDURE.....	143
5.6.4	DEVIATION FROM TEST STANDARD .....	144
5.6.5	TEST SETUP .....	144
5.6.6	EUT OPERATING CONDITION.....	144
5.6.7	TEST RESULTS (MODE 1) .....	144
5.6.8	TEST RESULTS (MODE 2) .....	155
6.	PHOTOGRAPHS OF THE TEST CONFIGURATION.....	166
7.	INFORMATION ON THE TESTING LABORATORIES .....	167
8.	APPENDIX A - MODIFICATIONS RECORDERS FOR ENGINEERING CHANGES TO THE EUT BY THE LAB.....	168



A D T

## RELEASE CONTROL RECORD

ISSUE NO.	REASON FOR CHANGE	DATE ISSUED
RF140402E02	Original release	May 14, 2014
RF140402E02 R1	Modified the product name	May 30, 2014



A D T

## 1. CERTIFICATION

**PRODUCT:** 802.11ac Outdoor Dual Band Access Point  
**BRAND NAME:** Edge-corE  
**MODEL NO.:** ECWO5320, ECWO5320-L, ECWO5320-C,  
ECWO5324, ECWO5324-L, ECWO5324-C  
**TEST SAMPLE:** ENGINEERING SAMPLE  
**APPLICANT:** Edgecore Networks Corporation.  
**TESTED:** Apr. 08 to 17, 2014  
**STANDARDS:** **FCC Part 15, Subpart C (Section 15.247)**  
ANSI C63.10-2009

The above equipment (Model: ECWO5320, ECWO5324) has been tested by **Bureau Veritas Consumer Products Services (H.K.) Ltd., Taoyuan Branch**, and found compliance with the requirement of the above standards. The test record, data evaluation & Equipment Under Test (EUT) configurations represented herein are true and accurate accounts of the measurements of the sample's EMC characteristics under the conditions specified in this report.

**PREPARED BY :** Midoli Peng , **DATE:** May 30, 2014  
( Midoli Peng, Specialist )

**APPROVED BY :** May Chen , **DATE:** May 30, 2014  
( May Chen, Manager )



A D T

## 2. SUMMARY OF TEST RESULTS

The EUT has been tested according to the following specifications:

For 2.4GHz, 2400~2483.5MHz Band

APPLIED STANDARD: FCC PART 15, SUBPART C (SECTION 15.247)			
STANDARD SECTION	TEST TYPE	RESULT	REMARK
15.207	AC Power Conducted Emission	PASS	Meet the requirement of limit. Minimum passing margin is -14.24dB at 0.15781MHz
15.247(d) 15.209	Radiated Emissions	PASS	Meet the requirement of limit. Minimum passing margin is -0.1dB at 2483.5MHz & 4874.00MHz & 4924.00MHz
15.247(d)	Band Edge Measurement	PASS	Meet the requirement of limit.
15.247(a)(2)	6dB bandwidth	PASS	Meet the requirement of limit.
15.247(b)	Conducted Output power	PASS	Meet the requirement of limit.
15.247(e)	Power Spectral Density	PASS	Meet the requirement of limit.
15.203	Antenna Requirement	PASS	Antenna connector is RP-SMA not a standard connector.



A D T

For 5GHz, 5725~5850MHz Band

APPLIED STANDARD: FCC PART 15, SUBPART C (SECTION 15.247)			
STANDARD SECTION	TEST TYPE	RESULT	REMARK
15.207	AC Power Conducted Emission	PASS	Meet the requirement of limit. Minimum passing margin is -12.59dB at 0.15391MHz
15.247(d) 15.209	Radiated Emissions	PASS	Meet the requirement of limit. Minimum passing margin is -0.5dB at 11650.00MHz & 11490.00MHz
15.247(d)	Band Edge Measurement	PASS	Meet the requirement of limit.
15.247(a)(2)	6dB bandwidth	PASS	Meet the requirement of limit.
15.247(b)	Conducted Output power	PASS	Meet the requirement of limit.
15.247(e)	Power Spectral Density	PASS	Meet the requirement of limit.
15.203	Antenna Requirement	PASS	Antenna connector is RP-SMA or MMCX not a standard connector.

**NOTE:** The EUT was operating in 2.400 ~ 2.4835GHz, 5.15~5.25GHz and 5.725~5.850GHz frequencies band. This report was recorded the RF parameters including 2.400 ~ 2.4835GHz and 5.725~5.850GHz. For the 5.15~5.25GHz RF parameters was recorded in another test report.





A D T

## 2.1 MEASUREMENT UNCERTAINTY

Where relevant, the following measurement uncertainty levels have been estimated for tests performed on the EUT as specified in CISPR 16-4-2:

This uncertainty represents an expanded uncertainty expressed at approximately the 95% confidence level using a coverage factor of  $k=2$ .

Measurement	Value
Conducted emissions	2.86 dB
Radiated emissions (30MHz-1GHz)	5.37 dB
Radiated emissions (1GHz -6GHz)	3.72 dB
Radiated emissions (6GHz -18GHz)	4.00 dB
Radiated emissions (18GHz -40GHz)	4.11 dB



A D T

### 3. GENERAL INFORMATION

#### 3.1 GENERAL DESCRIPTION OF EUT

<b>PRODUCT</b>	802.11ac Outdoor Dual Band Access Point
<b>MODEL NO.</b>	ECWO5320, ECWO5320-L, ECWO5320-C, ECWO5324, ECWO5324-L, ECWO5324-C
<b>POWER SUPPLY</b>	DC 24V from POE
<b>MODULATION TYPE</b>	CCK, DQPSK, DBPSK for DSSS 64QAM, 16QAM, QPSK, BPSK for OFDM 256QAM for OFDM in 11ac mode only
<b>MODULATION TECHNOLOGY</b>	DSSS,OFDM
<b>TRANSFER RATE</b>	802.11b: up to 11Mbps 802.11a / g: up to 54Mbps 802.11n: up to 300Mbps 802.11ac: up to 866.7Mbps
<b>OPERATING FREQUENCY</b>	<b>For 15.407</b> <b>5GHz:</b> 5.18 ~ 5.24GHz
	<b>For 15.247</b> <b>2.4GHz:</b> 2.412 ~ 2.462GHz <b>5GHz:</b> 5.745 ~ 5.825GHz
<b>NUMBER OF CHANNEL</b>	<b>For 15.407</b> 4 for 802.11a, 802.11n (HT20), 802.11ac (VHT20) 2 for 802.11n (HT40), 802.11ac (VHT40) 1 for 802.11ac (VHT80)
	<b>For 15.247 (2.4GHz)</b> 11 for 802.11b, 802.11g, 802.11n (HT20) 7 for 802.11n (HT40) <b>For 15.247 (5GHz)</b> 5 for 802.11a, 802.11n (HT20), 802.11ac (VHT20) 2 for 802.11n (HT40), 802.11ac (VHT40) 1 for 802.11ac (VHT80)
<b>MAXIMUM OUTPUT POWER</b>	Please see NOTE
<b>ANTENNA TYPE</b>	Please see NOTE
<b>DATA CABLE</b>	NA
<b>I/O PORTS</b>	Refer to user's manual
<b>ASSOCIATED DEVICES</b>	POE x1



A D T

**Note:**

1. The EUT is a 2.4GHz & 5GHz WLAN device.
2. 2.4GHz & 5GHz technology can transmit at same time.
3. The EUT has six model names, which are identical to each other in all aspects except for the followings:

Product Name	Brand Name	Model Name	Different
802.11ac Outdoor Dual Band Access Point	Edge-corE	ECWO5320	External antenna (2.4GHz) + Internal antenna (5GHz)
	Edge-corE	ECWO5320-L	External antenna (2.4GHz) + Internal antenna (5GHz)
	Edge-corE	ECWO5320-C	External antenna (2.4GHz) + Internal antenna (5GHz)
	Edge-corE	ECWO5324	External antenna (2.4GHz) + External antenna (5GHz)
	Edge-corE	ECWO5324-L	External antenna (2.4GHz) + External antenna (5GHz)
	Edge-corE	ECWO5324-C	External antenna (2.4GHz) + External antenna (5GHz)

From the above models, models: **ECWO5320**, **ECWO5324** were selected as representative model for the test and its data was recorded in this report.

4. The EUT must be supplied with a POE as following table:

Brand	Model No.	Spec.
NA	NU24-F240100-I2	Input: 100-240V, 0.7A, 50/60Hz Output: 24V, 1A

5. The antennas provided to the EUT, please refer to the following table:

External antenna								
Transmitter Circuit	Antenna Type	Connector Type	Antenna Gain(dBi) < excluding cable loss>	Inside EUT		Outside EUT		Frequency range (MHz to MHz)
				Cable Loss (dB)	Cable Length (mm)	Cable Loss (dB)	Cable Length (mm)	
Chain (0)	Dipole	RP-SMA	2.65	1	250	1.5	500	2400~2500
			2.7	1.2	250	2.9	500	5150~5850
Chain (1)	Dipole	RP-SMA	2.65	1	250	1.5	500	2400~2500
			2.7	1.2	250	2.9	500	5150~5850
Internal antenna								
Transmitter Circuit	Antenna Type	Connector Type	Antenna Gain(dBi)	Frequency range (MHz to MHz)				
Chain (0)	Patch Array	MMCX	12.5	5150~5850				
Chain (1)	Patch Array	MMCX	12.5	5150~5850				

※For 802.11a/b/g mode will fix transmission on Chain (0)



A D T

6. The maximum output power(mW) table as below table:

<b>15.247 (2.4GHz) – with External antenna</b>			
<b>1Tx</b>		<b>2Tx</b>	
<b>802.11b</b>	137.404	<b>802.11b</b>	-
<b>802.11g</b>	146.893	<b>802.11g</b>	-
<b>802.11n (HT20)</b>	148.594	<b>802.11n (HT20)</b>	222.389
<b>802.11n (HT40)</b>	102.802	<b>802.11n (HT40)</b>	260.942
<b>15.247 (5GHz) – with External antenna</b>			
<b>1Tx</b>		<b>2Tx</b>	
<b>802.11a</b>	253.513	<b>802.11a</b>	-
<b>802.11ac (VHT20)</b>	253.513	<b>802.11ac (VHT20)</b>	244.946
<b>802.11ac (VHT40)</b>	251.768	<b>802.11ac (VHT40)</b>	200.708
<b>802.11ac (VHT80)</b>	153.109	<b>802.11ac (VHT80)</b>	192.573
<b>15.247 (5GHz) – with Internal antenna</b>			
<b>1Tx</b>		<b>2Tx</b>	
<b>802.11a</b>	138.995	<b>802.11a</b>	-
<b>802.11ac (VHT20)</b>	211.349	<b>802.11ac (VHT20)</b>	217.548
<b>802.11ac (VHT40)</b>	208.449	<b>802.11ac (VHT40)</b>	200.708
<b>802.11ac (VHT80)</b>	153.109	<b>802.11ac (VHT80)</b>	192.573
<b>15.407 (5GHz) – with External antenna</b>			
<b>1Tx</b>		<b>2Tx</b>	
<b>802.11a</b>	46.026	<b>802.11a</b>	-
<b>802.11ac (VHT20)</b>	45.082	<b>802.11ac (VHT20)</b>	45.450
<b>802.11ac (VHT40)</b>	49.091	<b>802.11ac (VHT40)</b>	49.095
<b>802.11ac (VHT80)</b>	49.091	<b>802.11ac (VHT80)</b>	46.776
<b>15.407 (5GHz) – with Internal antenna</b>			
<b>1Tx</b>		<b>2Tx</b>	
<b>802.11a</b>	10.423	<b>802.11a</b>	-
<b>802.11ac (VHT20)</b>	10.351	<b>802.11ac (VHT20)</b>	10.175
<b>802.11ac (VHT40)</b>	10.447	<b>802.11ac (VHT40)</b>	11.048
<b>802.11ac (VHT80)</b>	10.889	<b>802.11ac (VHT80)</b>	10.896

7. The EUT incorporates a MIMO function without beamforming.

<b>MODULATION MODE</b>	<b>Tx/Rx FUNCTION</b>
<b>802.11a</b>	1Tx/2Rx
<b>802.11b</b>	1Tx/2Rx
<b>802.11g</b>	1Tx/2Rx
<b>802.11n (HT20)</b>	1Tx/2Rx or 2Tx/2Rx
<b>802.11n (HT40)</b>	1Tx/2Rx or 2Tx/2Rx
<b>802.11ac (VHT20)</b>	1Tx/2Rx or 2Tx/2Rx
<b>802.11ac (VHT40)</b>	1Tx/2Rx or 2Tx/2Rx
<b>802.11ac (VHT80)</b>	1Tx/2Rx or 2Tx/2Rx

Note: The modulation and bandwidth are similar for 802.11n mode for 20MHz (40MHz) and 802.11ac mode for 20MHz (40MHz), therefore investigated worst case to representative mode in test report. (Final test mode refer section 3.2.1)

8. Spurious emission of the simultaneous operation (2.4GHz & 5GHz) has been evaluated and no non-compliance was found.
9. When the EUT operating in 802.11n, the software operation, which is defined by manufacturer, MCS (Modulation and Coding Schemes) from 0 to 15.
10. When the EUT operating in 802.11ac, the software operation, which is defined by manufacturer, MCS (Modulation and Coding Schemes) from 0 to 9.
11. The above EUT information was declared by the manufacturer and for more detailed features description, please refer to the manufacturer's specifications or User's Manual.



A D T

### 3.2 DESCRIPTION OF TEST MODES

#### Operated in 2400 ~ 2483.5MHz band:

11 channels are provided for 802.11b, 802.11g, 802.11n (HT20):

CHANNEL	FREQUENCY	CHANNEL	FREQUENCY
1	2412MHz	7	2442MHz
2	2417MHz	8	2447MHz
3	2422MHz	9	2452MHz
4	2427MHz	10	2457MHz
5	2432MHz	11	2462MHz
6	2437MHz		

7 channels are provided for 802.11n (HT40):

CHANNEL	FREQUENCY	CHANNEL	FREQUENCY
3	2422MHz	7	2442MHz
4	2427MHz	8	2447MHz
5	2432MHz	9	2452MHz
6	2437MHz		

#### Operated in 5725 ~ 5850MHz band:

5 channels are provided for 802.11a, 802.11n (HT20), 802.11ac (VHT20):

CHANNEL	FREQUENCY	CHANNEL	FREQUENCY
149	5745 MHz	161	5805 MHz
153	5765 MHz	165	5825 MHz
157	5785 MHz		

2 channels are provided for 802.11n (HT40), 802.11ac (VHT40):

CHANNEL	FREQUENCY
151	5755 MHz
159	5795 MHz

1 channel is provided for 802.11ac (VHT80):

CHANNEL	FREQUENCY
155	5775 MHz



A D T

### 3.2.1 TEST MODE APPLICABILITY AND TESTED CHANNEL DETAIL

EUT CONFIGURE MODE	APPLICABLE TO					DESCRIPTION
	PLC	RE < 1G	RE <sup>3</sup> 1G	APCM	OB	
1	√	√	√	√	√	2.4G with External antenna
1	-	√	√	√	√	5GHz with External antenna
2	√	√	√	√	√	5GHz with Internal antenna

Where **PLC**: Power Line Conducted Emission      **RE < 1G**: Radiated Emission below 1GHz  
**RE <sup>3</sup> 1G**: Radiated Emission above 1GHz      **APCM**: Antenna Port Conducted Measurement  
**OB**: Conducted Out-Band Emission Measurement

**NOTE:** 1. "-" means no effect.

#### **POWER LINE CONDUCTED EMISSION TEST:**

- Pre-Scan has been conducted to determine the worst-case mode from all possible combinations between available modulations, data rates and antenna ports (if EUT with antenna diversity architecture).
- Following channel(s) was (were) selected for the final test as listed below.

MODE	AVAILABLE CHANNEL	TESTED CHANNEL	MODULATION TECHNOLOGY	MODULATION TYPE	DATA RATE (Mbps)
For 2.4 GHz 802.11n (HT40), 2Tx	3 to 9	6	OFDM	BPSK	27
For 5 GHz 802.11ac (VHT20), 2Tx	149 to 165	157	OFDM	BPSK	13

#### **RADIATED EMISSION TEST (BELOW 1 GHz):**

- Pre-Scan has been conducted to determine the worst-case mode from all possible combinations between available modulations, data rates and antenna ports (if EUT with antenna diversity architecture).
- Following channel(s) was (were) selected for the final test as listed below.

MODE	AVAILABLE CHANNEL	TESTED CHANNEL	MODULATION TECHNOLOGY	MODULATION TYPE	DATA RATE (Mbps)
For 2.4 GHz 802.11n (HT40), 2Tx	3 to 9	6	OFDM	BPSK	27
For 5 GHz 802.11ac (VHT20), 2Tx	149 to 165	157	OFDM	BPSK	13



A D T

**RADIATED EMISSION TEST (ABOVE 1 GHz):**

- Pre-Scan has been conducted to determine the worst-case mode from all possible combinations between available modulations, data rates and antenna ports (if EUT with antenna diversity architecture).
- Following channel(s) was (were) selected for the final test as listed below.

MODE	AVAILABLE CHANNEL	TESTED CHANNEL	MODULATION TECHNOLOGY	MODULATION TYPE	DATA RATE (Mbps)
802.11b	1 to 11	1, 6, 11	DSSS	DBPSK	1
802.11g	1 to 11	1, 6, 11	OFDM	BPSK	6
For 2.4 GHz 802.11n (HT20), 1Tx	1 to 11	1, 6, 11	OFDM	BPSK	6.5
For 2.4 GHz 802.11n (HT40), 1Tx	3 to 9	3, 6, 9	OFDM	BPSK	13.5
For 2.4 GHz 802.11n (HT20), 2Tx	1 to 11	1, 6, 11	OFDM	BPSK	13
For 2.4 GHz 802.11n (HT40), 2Tx	3 to 9	3, 6, 9	OFDM	BPSK	27
802.11a	149 to 165	149, 157, 165	OFDM	BPSK	6
For 5 GHz 802.11ac (VHT20), 1Tx	149 to 165	149, 157, 165	OFDM	BPSK	6.5
For 5 GHz 802.11ac (VHT40), 1Tx	151 to 159	151, 159	OFDM	BPSK	13.5
For 5 GHz 802.11ac (VHT80), 1Tx	155	155	OFDM	BPSK	29.3
For 5 GHz 802.11ac (VHT20), 2Tx	149 to 165	149, 157, 165	OFDM	BPSK	13
For 5 GHz 802.11ac (VHT40), 2Tx	151 to 159	151, 159	OFDM	BPSK	27
For 5 GHz 802.11ac (VHT80), 2Tx	155	155	OFDM	BPSK	58.5





A D T

**ANTENNA PORT CONDUCTED MEASUREMENT:**

- Pre-Scan has been conducted to determine the worst-case mode from all possible combinations between available modulations, data rates and antenna ports (if EUT with antenna diversity architecture).
- Following channel(s) was (were) selected for the final test as listed below.

MODE	AVAILABLE CHANNEL	TESTED CHANNEL	MODULATION TECHNOLOGY	MODULATION TYPE	DATA RATE (Mbps)
802.11b	1 to 11	1, 6, 11	DSSS	DBPSK	1
802.11g	1 to 11	1, 6, 11	OFDM	BPSK	6
For 2.4 GHz 802.11n (HT20), 1Tx	1 to 11	1, 6, 11	OFDM	BPSK	6.5
For 2.4 GHz 802.11n (HT40), 1Tx	3 to 9	3, 6, 9	OFDM	BPSK	13.5
For 2.4 GHz 802.11n (HT20), 2Tx	1 to 11	1, 6, 11	OFDM	BPSK	13
For 2.4 GHz 802.11n (HT40), 2Tx	3 to 9	3, 6, 9	OFDM	BPSK	27
802.11a	149 to 165	149, 157, 165	OFDM	BPSK	6
For 5 GHz 802.11ac (VHT20), 1Tx	149 to 165	149, 157, 165	OFDM	BPSK	6.5
For 5 GHz 802.11ac (VHT40), 1Tx	151 to 159	151, 159	OFDM	BPSK	13.5
For 5 GHz 802.11ac (VHT80), 1Tx	155	155	OFDM	BPSK	29.3
For 5 GHz 802.11ac (VHT20), 2Tx	149 to 165	149, 157, 165	OFDM	BPSK	13
For 5 GHz 802.11ac (VHT40), 2Tx	151 to 159	151, 159	OFDM	BPSK	27
For 5 GHz 802.11ac (VHT80), 2Tx	155	155	OFDM	BPSK	58.5



A D T

**CONDUCTED OUT-BAND EMISSION MEASUREMENT:**

- Pre-Scan has been conducted to determine the worst-case mode from all possible combinations between available modulations, data rates and antenna ports (if EUT with antenna diversity architecture).
- Following channel(s) was (were) selected for the final test as listed below.

MODE	AVAILABLE CHANNEL	TESTED CHANNEL	MODULATION TECHNOLOGY	MODULATION TYPE	DATA RATE (Mbps)
802.11b	1 to 11	1, 6, 11	DSSS	DBPSK	1
802.11g	1 to 11	1, 6, 11	OFDM	BPSK	6
For 2.4 GHz 802.11n (HT20), 1Tx	1 to 11	1, 6, 11	OFDM	BPSK	6.5
For 2.4 GHz 802.11n (HT40), 1Tx	3 to 9	3, 6, 9	OFDM	BPSK	13.5
For 2.4 GHz 802.11n (HT20), 2Tx	1 to 11	1, 6, 11	OFDM	BPSK	13
For 2.4 GHz 802.11n (HT40), 2Tx	3 to 9	3, 6, 9	OFDM	BPSK	27
802.11a	149 to 165	149, 157, 165	OFDM	BPSK	6
For 5 GHz 802.11ac (VHT20), 1Tx	149 to 165	149, 157, 165	OFDM	BPSK	6.5
For 5 GHz 802.11ac (VHT40), 1Tx	151 to 159	151, 159	OFDM	BPSK	13.5
For 5 GHz 802.11ac (VHT80), 1Tx	155	155	OFDM	BPSK	29.3
For 5 GHz 802.11ac (VHT20), 2Tx	149 to 165	149, 157, 165	OFDM	BPSK	13
For 5 GHz 802.11ac (VHT40), 2Tx	151 to 159	151, 159	OFDM	BPSK	27
For 5 GHz 802.11ac (VHT80), 2Tx	155	155	OFDM	BPSK	58.5

**TEST CONDITION:**

APPLICABLE TO	ENVIRONMENTAL CONDITIONS	INPUT POWER	TESTED BY
PLC	24deg. 73C,%RH	120Vac, 60Hz	Ping Liu
RE<1G	21deg. C, 66%RH	120Vac, 60Hz	Robert Cheng
RE <sup>3</sup> 1G	24deg. C, 73%RH	120Vac, 60Hz	Andy Ho
	23deg. C, 66%RH	120Vac, 60Hz	Andy Ho
	24deg. C, 73%RH	120Vac, 60Hz	Tim Ho
	23deg. C, 66%RH	120Vac, 60Hz	Tim Ho
	23deg. C, 66%RH	120Vac, 60Hz	Nelson Teng
APCM	25deg. C, 60%RH	120Vac, 60Hz	Robert Cheng
OB	25deg. C, 60%RH	120Vac, 60Hz	Robert Cheng

### 3.3 GENERAL DESCRIPTION OF APPLIED STANDARDS

The EUT is a RF product. According to the specifications of the manufacturer, it must comply with the requirements of the following standards:

**FCC Part 15, Subpart C(15.247)**

**558074 D01 DTS Meas Guidance v03r01**

**662911 D01 Multiple Transmitter Output v02r01**

ANSI C63.10-2009

All test items have been performed and recorded as per the above standards.

**Note:** The EUT has been verified to comply with the requirements of FCC Part 15, Subpart B, Class B (DoC). The test report has been issued separately.



A D T

### 3.4 DUTY CYCLE OF TEST SIGNAL

Duty cycle of test signal is 100 %, duty factor is not required.

For 2.4GHz, 1Tx

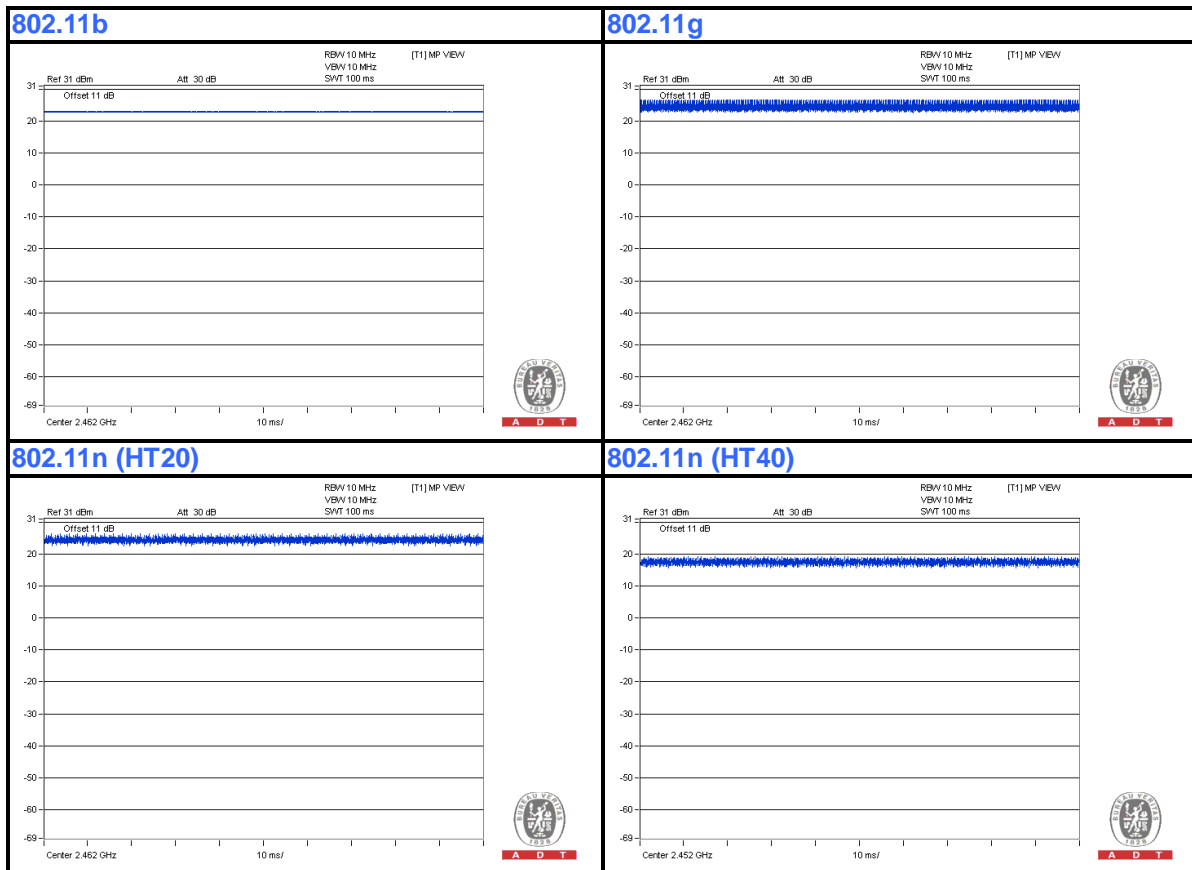

For 2.4GHz, 2Tx

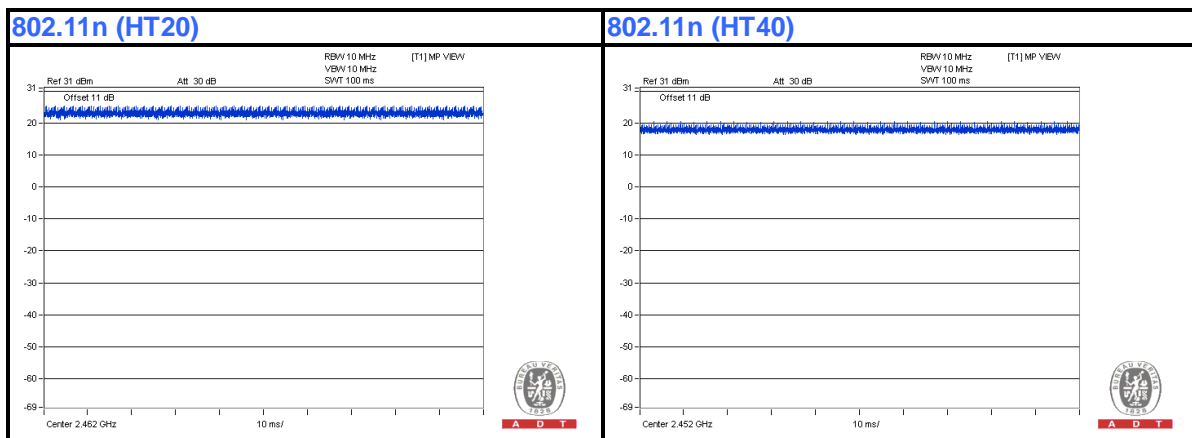



A D T

Duty cycle of test signal is 100 %, duty factor is not required.

For 5GHz, 1Tx

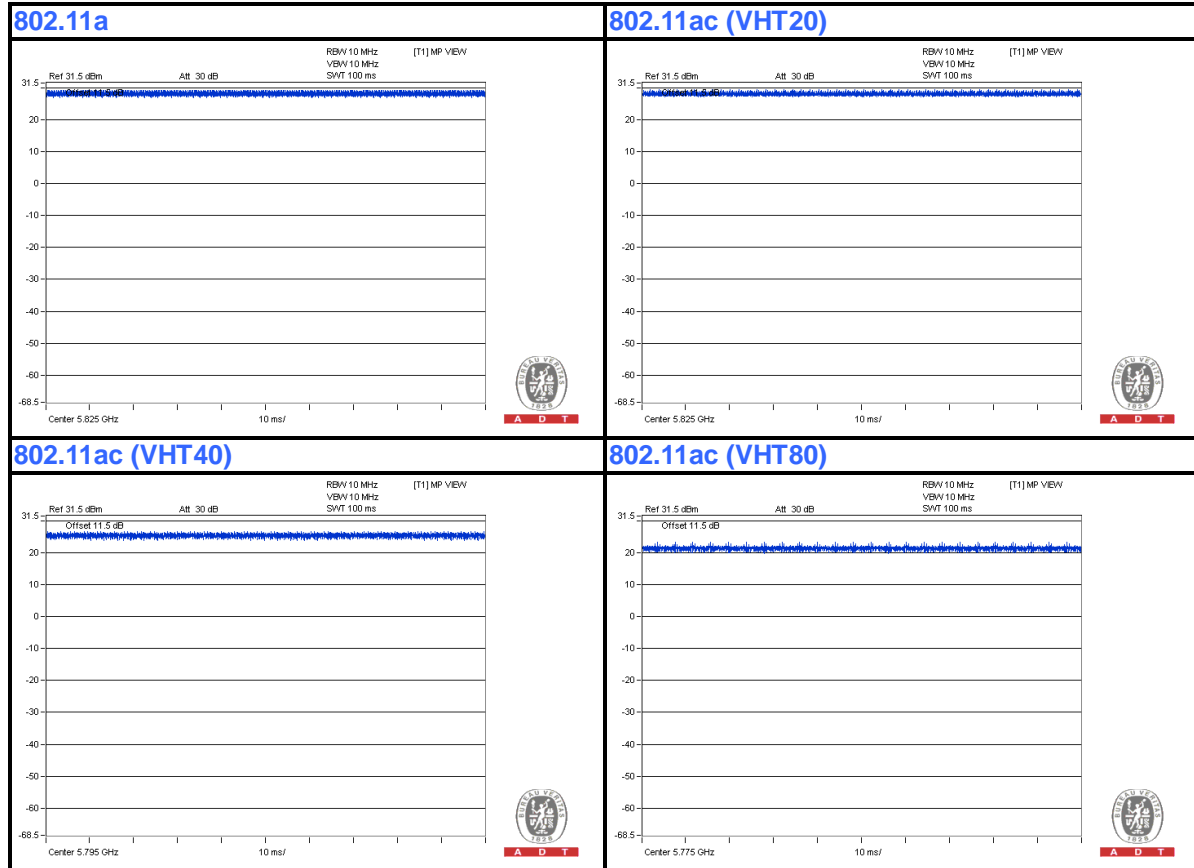



A D T

For 5GHz, 2Tx

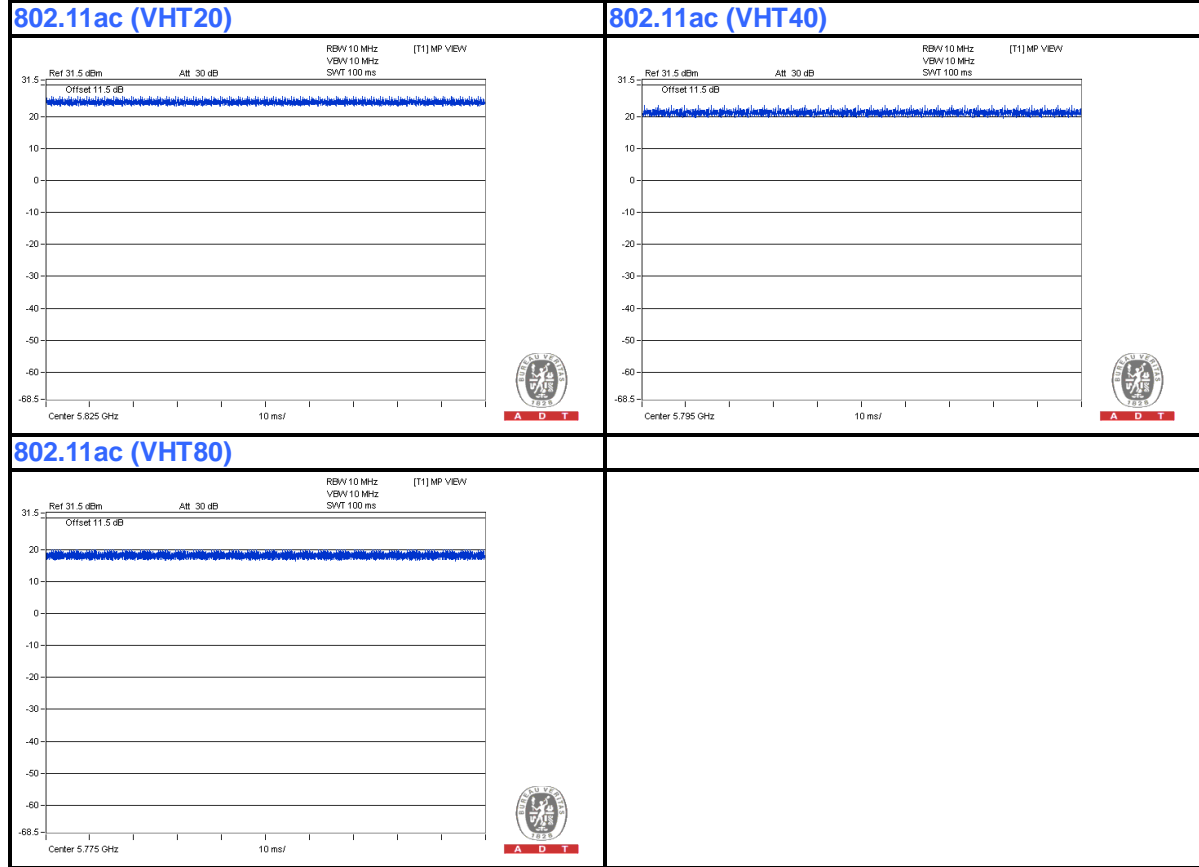



A D T

### 3.5 DESCRIPTION OF SUPPORT UNITS

The EUT has been tested as an independent unit together with other necessary accessories or support units. The following support units or accessories were used to form a representative test configuration during the tests.

No.	Product	Brand	Model No.	Serial No.	FCC ID
1	NOTEBOOK COMPUTER	DELL	PP32LA	GSLB32S	NA
2	NOTEBOOK COMPUTER	DELL	PP32LA	FSLB32S	NA

No.	Signal cable description
1	UTP cable(10m)
2	UTP cable(10m)

Note: The power cords of the above support units were unshielded (1.8m).

### 3.6 CONFIGURATION OF SYSTEM UNDER TEST

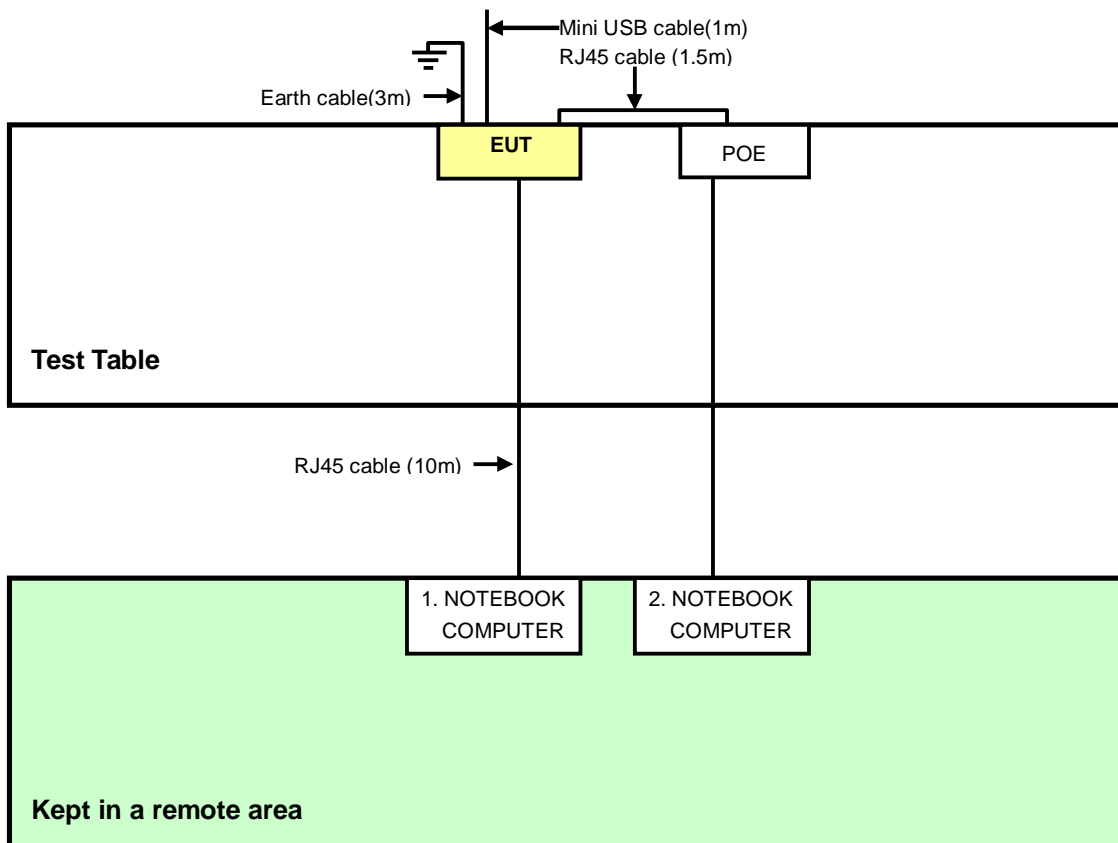





A D T

## 4. TEST TYPES AND RESULTS (FOR 2.4GHz, 2.400 ~ 2.4835GHz Band)

### 4.1 CONDUCTED EMISSION MEASUREMENT

#### 4.1.1 LIMITS OF CONDUCTED EMISSION MEASUREMENT

FREQUENCY OF EMISSION (MHz)	CONDUCTED LIMIT (dB $\mu$ V)	
	Quasi-peak	Average
0.15-0.5	66 to 56	56 to 46
0.5-5	56	46
5-30	60	50

- NOTE:**
1. The lower limit shall apply at the transition frequencies.
  2. The limit decreases in line with the logarithm of the frequency in the range of 0.15 to 0.50 MHz.

#### 4.1.2 TEST INSTRUMENTS

DESCRIPTION & MANUFACTURER	MODEL NO.	SERIAL NO.	CALIBRATED DATE	CALIBRATED UNTIL
Line-Impedance Stabilization Network (for EUT) SCHWARZBECK	NSLK8127	8127-522	Sep. 05, 2013	Sep. 04, 2014
Line-Impedance Stabilization Network (for Peripheral)	ENV216	100072	June 06, 2013	June 05, 2014
RF Cable (JYEBAO)	5DFB	CONCAB-003	Mar. 07, 2014	Mar. 06, 2015
50 ohms Terminator	50	EMC-03	Sep. 24, 2013	Sep. 23, 2014
Software ADT	BV ADT_Cond_V7.3.7. 3	NA	NA	NA

**Note:**

1. The calibration interval of the above test instruments is 12 months and the calibrations are traceable to NML/ROC and NIST/USA.
2. The test was performed in Shielded Room No. C.
3. The VCCI Con C Registration No. is C-3611.
4. Tested Date: Apr. 17, 2014

#### 4.1.3 TEST PROCEDURES

- a. The EUT was placed 0.4 meters from the conducting wall of the shielded room with EUT being connected to the power mains through a line impedance stabilization network (LISN). Other support units were connected to the power mains through another LISN.
- b. The two LISNs provide 50 ohm/ 50uH of coupling impedance for the measuring instrument.
- c. Both lines of the power mains connected to the EUT were checked for maximum conducted interference.
- d. The frequency range from 150kHz to 30MHz was searched. Emission levels under (Limit - 20dB) were not recorded.

#### NOTE:

1. The resolution bandwidth of test receiver is 9kHz for Quasi-peak detection (QP) & Average detection (AV).

#### 4.1.4 DEVIATION FROM TEST STANDARD

No deviation

#### 4.1.5 TEST SETUP

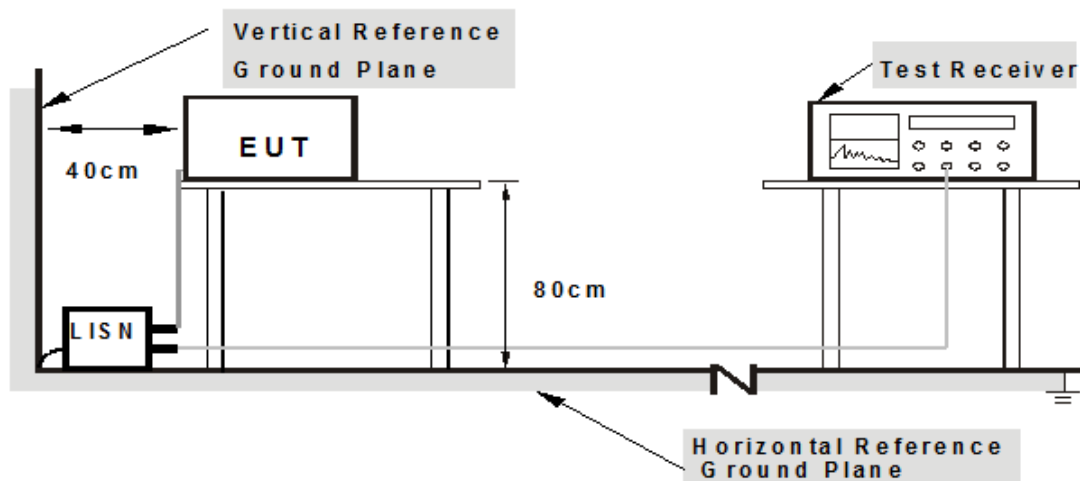

**Note: 1. Support units were connected to second LISN.**

For the actual test configuration, please refer to the related item – Photographs of the Test Configuration.

#### 4.1.6 EUT OPERATING CONDITIONS

1. Placed the EUT on testing table.
2. Prepared computer system (support units 1 ~ 2) to act as communication partner.
3. The communication partner ran test program “MP\_TEST.exe[Ver 1.3.8.0]” to enable EUT under transmission/receiving condition continuously.

### 4.1.7 TEST RESULTS

<b>PHASE</b>	Line (L)	<b>DETECTOR FUNCTION</b>	Quasi-Peak (QP) / Average (AV)
--------------	----------	--------------------------	--------------------------------

No	Freq. [MHz]	Corr. Factor (dB)	Reading Value [dB (uV)]		Emission Level [dB (uV)]		Limit [dB (uV)]		Margin (dB)	
			Q.P.	AV.	Q.P.	AV.	Q.P.	AV.	Q.P.	AV.
1	0.15781	0.06	51.28	35.73	51.34	35.79	65.58	55.58	-14.24	-19.79
2	0.17344	0.06	48.15	34.78	48.21	34.84	64.79	54.79	-16.58	-19.95
3	0.19297	0.06	44.74	31.01	44.80	31.07	63.91	53.91	-19.11	-22.84
4	0.23594	0.06	37.89	25.42	37.95	25.48	62.24	52.24	-24.29	-26.76
5	0.29453	0.06	36.62	27.25	36.68	27.31	60.40	50.40	-23.71	-23.08
6	23.16016	0.75	34.43	29.94	35.18	30.69	60.00	50.00	-24.82	-19.31

#### REMARKS:

1. Q.P. and AV. are abbreviations of quasi-peak and average individually.
2. The emission levels of other frequencies were very low against the limit.
3. Margin value = Emission Level – Limit value
4. Correction Factor = Insertion loss + Cable loss
5. Emission Level = Correction Factor + Reading Value

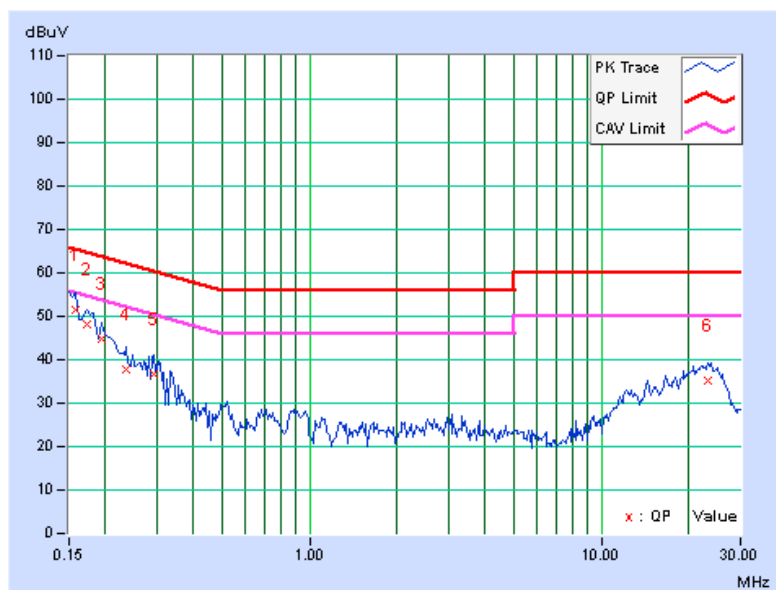

<b>PHASE</b>	Neutral (N)	<b>DETECTOR FUNCTION</b>	Quasi-Peak (QP) / Average (AV)
--------------	-------------	--------------------------	--------------------------------

No	Freq.	Corr.	Reading Value		Emission Level		Limit		Margin	
	[MHz]	(dB)	Q.P.	AV.	Q.P.	AV.	Q.P.	AV.	Q.P.	AV.
1	0.16172	0.07	49.61	33.16	49.68	33.23	65.38	55.38	-15.70	-22.15
2	0.20859	0.06	42.82	28.32	42.88	28.38	63.26	53.26	-20.38	-24.88
3	0.22422	0.06	39.95	25.29	40.01	25.35	62.66	52.66	-22.65	-27.31
4	0.33359	0.07	34.62	25.03	34.69	25.10	59.36	49.36	-24.67	-24.26
5	13.14844	0.48	29.48	23.61	29.96	24.09	60.00	50.00	-30.04	-25.91
6	23.55859	0.76	35.08	30.55	35.84	31.31	60.00	50.00	-24.16	-18.69

**REMARKS:**

1. Q.P. and AV. are abbreviations of quasi-peak and average individually.
2. The emission levels of other frequencies were very low against the limit.
3. Margin value = Emission Level – Limit value
4. Correction Factor = Insertion loss + Cable loss
5. Emission Level = Correction Factor + Reading Value

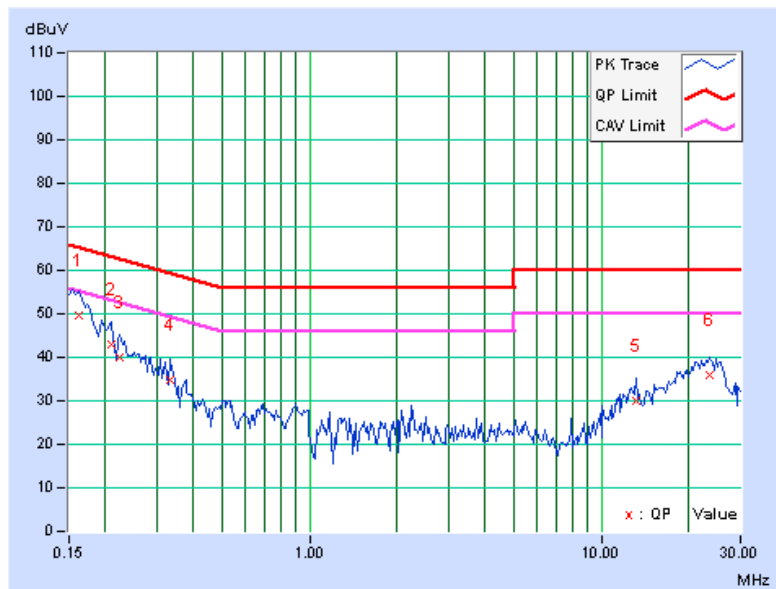



A D T

## 4.2 RADIATED EMISSION AND BANDEGE MEASUREMENT

### 4.2.1 LIMITS OF RADIATED EMISSION AND BANDEGE MEASUREMENT

Radiated emissions which fall in the restricted bands must comply with the radiated emission limits specified as below table. Other emissions shall be at least 30dB below the highest level of the desired power:

Frequencies (MHz)	Field strength (microvolts/meter)	Measurement distance (meters)
0.009-0.490	2400/F(kHz)	300
0.490-1.705	24000/F(kHz)	30
1.705-30.0	30	30
30-88	100	3
88-216	150	3
216-960	200	3
Above 960	500	3

**NOTE:**

1. The lower limit shall apply at the transition frequencies.
2. Emission level (dBuV/m) = 20 log Emission level (uV/m).
3. For frequencies above 1000MHz, the field strength limits are based on average detector, however, the peak field strength of any emission shall not exceed the maximum permitted average limits, specified above by more than 20dB under any condition of modulation.



A D T

## 4.2.2 TEST INSTRUMENTS

### For Below 1GHz test

DESCRIPTION & MANUFACTURER	MODEL NO.	SERIAL NO.	CALIBRATED DATE	CALIBRATED UNTIL
MXE EMI Receiver Agilent	N9038A	MY51210105	Jan. 21,2014	Jan. 20,2015
Pre-Amplifier Mini-Circuits	ZFL-1000VH2 B	AMP-ZFL-03	Nov. 13, 2013	Nov. 12, 2014
Trilog Broadband Antenna SCHWARZBECK	VULB 9168	9168-360	Feb. 26, 2014	Feb. 25, 2015
RF Cable	NA	CHGCAB_001	Oct. 05, 2013	Oct. 04, 2014
Spectrum Analyzer R&S	FSV40	100964	July 15, 2013	July 14, 2014
Horn_Antenna AISI	AIH.8018	0000320091110	Nov. 18, 2013	Nov. 17, 2014
Pre-Amplifier Agilent	8449B	3008A02578	June 25, 2013	June 24, 2014
RF Cable	NA	RF104-201 RF104-203 RF104-204	Dec. 12, 2013	Dec. 11, 2014
Spectrum Analyzer Agilent	E4446A	MY48250253	Aug. 28, 2013	Aug. 27, 2014
Pre-Amplifier SPACEK LABS	SLKKa-48-6	9K16	Nov. 13, 2013	Nov. 12, 2014
Horn_Antenna SCHWARZBECK	BBHA 9170	9170-424	Oct. 08, 2013	Oct. 07, 2014
Software	ADT_Radiated _V8.7.07	NA	NA	NA
Antenna Tower & Turn Table CT	NA	NA	NA	NA

#### Note:

1. The calibration interval of the above test instruments is 12 months and the calibrations are traceable to NML/ROC and NIST/USA.
2. The horn antenna, preamplifier (model: 8449B) are used only for the measurement of emission frequency above 1GHz if tested.
- 3 The test was performed in 966 Chamber No. G.
4. The FCC Site Registration No. is 966073.
- 5 The VCCI Site Registration No. is G-137.
- 6 The CANADA Site Registration No. is IC 7450H-2.
- 7 Tested Date: Apr. 11, 2014



A D T

**For Above 1GHz test**

DESCRIPTION & MANUFACTURER	MODEL NO.	SERIAL NO.	CALIBRATED DATE	CALIBRATED UNTIL
MXE EMI Receiver Agilent	N9038A	MY50010156	Jan. 15, 2014	Jan. 14, 2015
Pre-Amplifier Mini-Circuits	ZFL-1000VH2 B	AMP-ZFL-04	Nov. 13, 2013	Nov. 12, 2014
Trilog Broadband Antenna SCHWARZBECK	VULB 9168	9168-361	Feb. 27, 2014	Feb. 26, 2015
RF Cable	NA	CHHCAB_001	Oct. 06, 2013	Oct. 05, 2014
Spectrum Analyzer R&S	FSV40	100964	July 15, 2013	July 14, 2014
Horn_Antenna AISI	AIH.8018	0000220091110	Dec. 06, 2013	Dec. 05, 2014
Pre-Amplifier Agilent	8449B	3008A01923	Oct. 29, 2013	Oct. 28, 2014
RF Cable	NA	RF104-205 RF104-207 RF104-202	Dec. 12, 2013	Dec. 11, 2014
Spectrum Analyzer Agilent	E4446A	MY48250253	Aug. 28, 2013	Aug. 27, 2014
Pre-Amplifier SPACEK LABS	SLKKa-48-6	9K16	Nov. 13, 2013	Nov. 12, 2014
Horn_Antenna SCHWARZBECK	BBHA 9170	9170-424	Oct. 08, 2013	Oct. 07, 2014
Software	ADT_Radiated _V8.7.07	NA	NA	NA
Antenna Tower & Turn Table CT	NA	NA	NA	NA

**Note:**

1. The calibration interval of the above test instruments is 12 months and the calibrations are traceable to NML/ROC and NIST/USA.
2. The horn antenna, preamplifier (model: 8449B) are used only for the measurement of emission frequency above 1GHz if tested.
3. The test was performed in 966 Chamber No. H.
4. The FCC Site Registration No. is 797305.
5. The CANADA Site Registration No. is IC 7450H-3.
6. Tested Date: Apr. 16, 2014



#### 4.2.3 TEST PROCEDURES

- a. The EUT was placed on the top of a rotating table 0.8 meters above the ground at 3 meter chamber room for test. The table was rotated 360 degrees to determine the position of the highest radiation.
- b. The EUT was set 3 meters away from the interference-receiving antenna, which was mounted on the top of a variable-height antenna tower.
- c. The height of antenna is varied from one meter to four meters above the ground to determine the maximum value of the field strength. Both horizontal and vertical polarizations of the antenna are set to make the measurement.
- d. For each suspected emission, the EUT was arranged to its worst case and then the antenna was tuned to heights from 1 meter to 4 meters and the rotatable table was turned from 0 degrees to 360 degrees to find the maximum reading.
- e. The test-receiver system was set to quasi-peak detect function and specified bandwidth with maximum hold mode when the test frequency is below 1 GHz.
- f. The test-receiver system was set to peak and average detect function and specified bandwidth with maximum hold mode when the test frequency is above 1 GHz. If the peak reading value also meets average limit, measurement with the average detector is unnecessary.

**Note:**

1. The resolution bandwidth and video bandwidth of test receiver/spectrum analyzer is 120kHz for Quasi-peak detection (QP) at frequency below 1GHz.
2. The resolution bandwidth of test receiver/spectrum analyzer is 1 MHz and the video bandwidth is 3 MHz for Peak detection (PK) at frequency above 1GHz.
3. The resolution bandwidth of test receiver/spectrum analyzer is 1MHz and the video bandwidth is 3MHz for RMS Average (Duty cycle < 98%) for Average detection (AV) at frequency above 1GHz, then the measurement results was added to a correction factor ( $10 \log(1/\text{duty cycle})$ ).
4. The resolution bandwidth of test receiver/spectrum analyzer is 1MHz and the video bandwidth is 10Hz (Duty cycle  $\geq 98\%$ ) for Average detection (AV) at frequency above 1GHz.
5. All modes of operation were investigated and the worst-case emissions are reported.

#### 4.2.4 DEVIATION FROM TEST STANDARD

No deviation

## 4.2.5 TEST SETUP

### <Frequency Range below 1GHz>

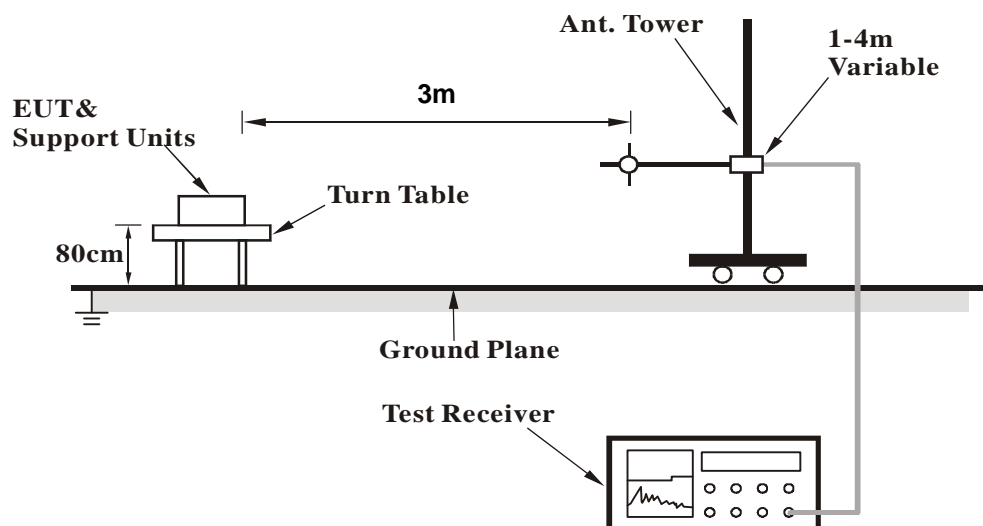

### <Frequency Range above 1GHz>

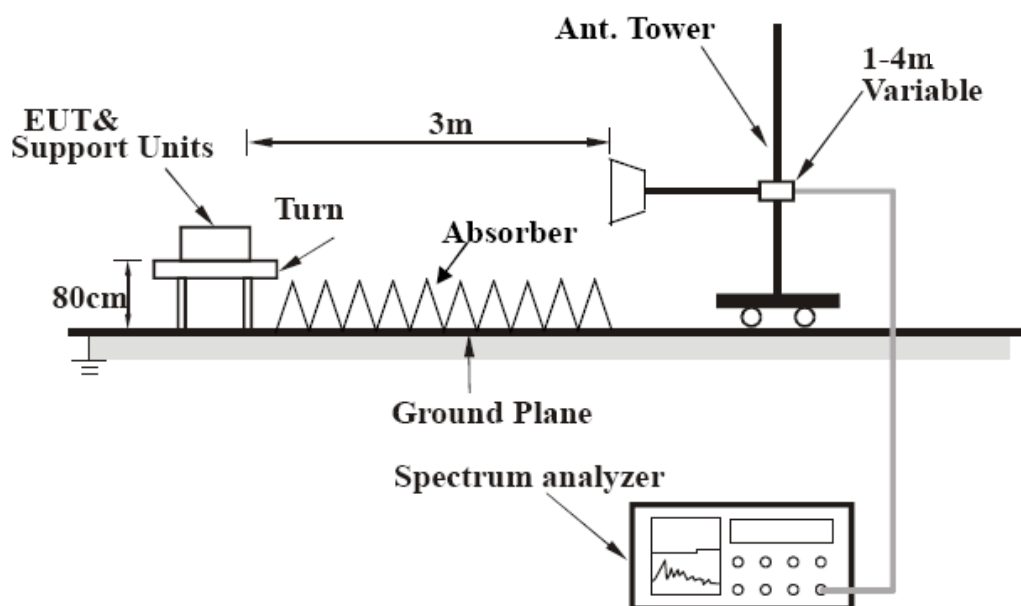

For the actual test configuration, please refer to the related item – Photographs of the Test Configuration.

## 4.2.6 EUT OPERATING CONDITIONS

Same as 4.1.6

## 4.2.7 TEST RESULTS

### BELOW 1GHz WORST-CASE DATA

#### 802.11n (HT40), 2Tx

<b>CHANNEL</b>	TX Channel 6	<b>DETECTOR FUNCTION</b>	Quasi-Peak (QP)
<b>FREQUENCY RANGE</b>	Below 1GHz		

ANTENNA POLARITY & TEST DISTANCE: HORIZONTAL AT 3 M								
NO.	FREQ. (MHz)	EMISSION LEVEL (dBuV/m)	LIMIT (dBuV/m)	MARGIN (dB)	ANTENNA HEIGHT (m)	TABLE ANGLE (Degree)	RAW VALUE (dBuV)	CORRECTION FACTOR (dB/m)
1	86.84	32.1 QP	40.0	-7.9	2.00 H	82	51.11	-19.04
2	97.12	36.8 QP	43.5	-6.8	2.00 H	22	55.16	-18.41
3	125.01	40.0 QP	43.5	-3.5	2.00 H	327	54.91	-14.92
4	148.34	35.6 QP	43.5	-7.9	2.00 H	82	48.79	-13.15
5	250.00	40.5 QP	46.0	-5.5	1.00 H	70	54.80	-14.32
6	362.52	39.0 QP	46.0	-7.0	1.00 H	85	49.77	-10.73
ANTENNA POLARITY & TEST DISTANCE: VERTICAL AT 3 M								
NO.	FREQ. (MHz)	EMISSION LEVEL (dBuV/m)	LIMIT (dBuV/m)	MARGIN (dB)	ANTENNA HEIGHT (m)	TABLE ANGLE (Degree)	RAW VALUE (dBuV)	CORRECTION FACTOR (dB/m)
1	38.83	36.6 QP	40.0	-3.4	1.00 V	52	50.49	-13.85
2	43.58	35.3 QP	40.0	-4.7	1.00 V	72	48.81	-13.49
3	66.52	34.3 QP	40.0	-5.7	1.00 V	101	49.27	-14.99
4	80.34	36.1 QP	40.0	-3.9	1.00 V	101	54.36	-18.25
5	125.00	40.6 QP	43.5	-2.9	1.00 V	238	55.51	-14.92
6	440.02	38.3 QP	46.0	-7.7	1.00 V	18	46.74	-8.44

#### REMARKS:

1. Emission Level(dBuV/m) = Raw Value(dBuV) + Correction Factor(dB/m)
2. Correction Factor(dB/m) = Antenna Factor(dB/m) + Cable Factor(dB) – Pre-Amplifier Factor(dB)
3. The other emission levels were very low against the limit.
4. Margin value = Emission Level – Limit value



A D T

ABOVE 1GHz DATA

802.11b, 1Tx

<b>CHANNEL</b>	TX Channel 1	<b>DETECTOR FUNCTION</b>	Peak (PK)
<b>FREQUENCY RANGE</b>	1GHz ~ 25GHz		Average (AV)

ANTENNA POLARITY & TEST DISTANCE: HORIZONTAL AT 3 M

NO.	FREQ. (MHz)	EMISSION LEVEL (dBuV/m)	LIMIT (dBuV/m)	MARGIN (dB)	ANTENNA HEIGHT (m)	TABLE ANGLE (Degree)	RAW VALUE (dBuV)	CORRECTION FACTOR (dB/m)
1	2390.00	50.0 PK	74.0	-24.0	1.13 H	146	55.60	-5.60
2	2390.00	37.8 AV	54.0	-16.2	1.13 H	146	43.40	-5.60
3	*2412.00	104.1 PK			1.13 H	146	109.60	-5.50
4	*2412.00	100.9 AV			1.13 H	146	106.40	-5.50
5	4824.00	50.2 PK	74.0	-23.8	1.00 H	95	46.40	3.80
6	4824.00	46.9 AV	54.0	-7.1	1.00 H	95	43.10	3.80

ANTENNA POLARITY & TEST DISTANCE: VERTICAL AT 3 M

NO.	FREQ. (MHz)	EMISSION LEVEL (dBuV/m)	LIMIT (dBuV/m)	MARGIN (dB)	ANTENNA HEIGHT (m)	TABLE ANGLE (Degree)	RAW VALUE (dBuV)	CORRECTION FACTOR (dB/m)
1	2390.00	54.5 PK	74.0	-19.5	1.54 V	42	60.10	-5.60
2	2390.00	43.0 AV	54.0	-11.0	1.54 V	42	48.60	-5.60
3	*2412.00	108.5 PK			1.54 V	42	114.00	-5.50
4	*2412.00	106.0 AV			1.54 V	42	111.50	-5.50
5	4824.00	55.8 PK	74.0	-18.2	1.38 V	141	52.00	3.80
6	4824.00	53.8 AV	54.0	-0.2	1.38 V	141	50.00	3.80

REMARKS:

1. Emission Level(dBuV/m) = Raw Value(dBuV) + Correction Factor(dB/m)
2. Correction Factor(dB/m) = Antenna Factor(dB/m) + Cable Factor(dB) – Pre-Amplifier Factor(dB)
3. The other emission levels were very low against the limit.
4. Margin value = Emission Level – Limit value
5. " \* ": Fundamental frequency.



A D T

<b>CHANNEL</b>	TX Channel 6	<b>DETECTOR FUNCTION</b>	Peak (PK)
<b>FREQUENCY RANGE</b>	1GHz ~ 25GHz		Average (AV)

**ANTENNA POLARITY & TEST DISTANCE: HORIZONTAL AT 3 M**

NO.	FREQ. (MHz)	EMISSION LEVEL (dBuV/m)	LIMIT (dBuV/m)	MARGIN (dB)	ANTENNA HEIGHT (m)	TABLE ANGLE (Degree)	RAW VALUE (dBuV)	CORRECTION FACTOR (dB/m)
1	2384.00	50.3 PK	74.0	-23.7	1.36 H	152	55.90	-5.60
2	2384.00	38.0 AV	54.0	-16.0	1.36 H	152	43.60	-5.60
3	*2437.00	105.7 PK			1.36 H	152	111.10	-5.40
4	*2437.00	102.4 AV			1.36 H	152	107.80	-5.40
5	2483.50	51.2 PK	74.0	-22.8	1.36 H	152	56.30	-5.10
6	2483.50	38.9 AV	54.0	-15.1	1.36 H	152	44.00	-5.10
7	4874.00	51.3 PK	74.0	-22.7	1.29 H	235	47.50	3.80
8	4874.00	47.9 AV	54.0	-6.1	1.29 H	235	44.10	3.80
9	7311.00	53.6 PK	74.0	-20.4	1.00 H	274	45.30	8.30
10	7311.00	41.8 AV	54.0	-12.2	1.00 H	274	33.50	8.30

**ANTENNA POLARITY & TEST DISTANCE: VERTICAL AT 3 M**

NO.	FREQ. (MHz)	EMISSION LEVEL (dBuV/m)	LIMIT (dBuV/m)	MARGIN (dB)	ANTENNA HEIGHT (m)	TABLE ANGLE (Degree)	RAW VALUE (dBuV)	CORRECTION FACTOR (dB/m)
1	2384.00	53.3 PK	74.0	-20.7	1.21 V	42	58.90	-5.60
2	2384.00	40.1 AV	54.0	-13.9	1.21 V	42	45.70	-5.60
3	*2437.00	111.5 PK			1.21 V	42	116.90	-5.40
4	*2437.00	107.7 AV			1.21 V	42	113.10	-5.40
5	2483.50	53.2 PK	74.0	-20.8	1.21 V	42	58.30	-5.10
6	2483.50	41.1 AV	54.0	-12.9	1.21 V	42	46.20	-5.10
7	4874.00	55.5 PK	74.0	-18.5	1.82 V	174	51.70	3.80
<b>8</b>	<b>4874.00</b>	<b>53.9 AV</b>	<b>54.0</b>	<b>-0.1</b>	<b>1.82 V</b>	<b>174</b>	<b>50.10</b>	<b>3.80</b>
9	7311.00	53.9 PK	74.0	-20.1	1.00 V	152	45.60	8.30
10	7311.00	41.7 AV	54.0	-12.3	1.00 V	152	33.40	8.30

**REMARKS:**

1. Emission Level(dBuV/m) = Raw Value(dBuV) + Correction Factor(dB/m)
2. Correction Factor(dB/m) = Antenna Factor(dB/m) + Cable Factor(dB) – Pre-Amplifier Factor(dB)
3. The other emission levels were very low against the limit.
4. Margin value = Emission Level – Limit value
5. " \* ": Fundamental frequency.



A D T

<b>CHANNEL</b>	TX Channel 11	<b>DETECTOR FUNCTION</b>	Peak (PK)
<b>FREQUENCY RANGE</b>	1GHz ~ 25GHz		Average (AV)

**ANTENNA POLARITY & TEST DISTANCE: HORIZONTAL AT 3 M**

NO.	FREQ. (MHz)	EMISSION LEVEL (dBuV/m)	LIMIT (dBuV/m)	MARGIN (dB)	ANTENNA HEIGHT (m)	TABLE ANGLE (Degree)	RAW VALUE (dBuV)	CORRECTION FACTOR (dB/m)
1	*2462.00	105.4 PK			1.41 H	147	110.80	-5.40
2	*2462.00	102.6 AV			1.41 H	147	108.00	-5.40
3	2483.50	51.6 PK	74.0	-22.4	1.41 H	147	56.70	-5.10
4	2483.50	39.4 AV	54.0	-14.6	1.41 H	147	44.50	-5.10
5	4924.00	51.7 PK	74.0	-22.3	1.30 H	231	47.90	3.80
6	4924.00	48.1 AV	54.0	-5.9	1.30 H	231	44.30	3.80
7	7386.00	53.5 PK	74.0	-20.5	1.00 H	283	44.90	8.60
8	7386.00	41.4 AV	54.0	-12.6	1.00 H	283	32.80	8.60

**ANTENNA POLARITY & TEST DISTANCE: VERTICAL AT 3 M**

NO.	FREQ. (MHz)	EMISSION LEVEL (dBuV/m)	LIMIT (dBuV/m)	MARGIN (dB)	ANTENNA HEIGHT (m)	TABLE ANGLE (Degree)	RAW VALUE (dBuV)	CORRECTION FACTOR (dB/m)
1	*2462.00	110.3 PK			1.22 V	42	115.70	-5.40
2	*2462.00	107.8 AV			1.22 V	42	113.20	-5.40
3	2483.50	56.8 PK	74.0	-17.2	1.22 V	42	61.90	-5.10
4	2483.50	44.7 AV	54.0	-9.3	1.22 V	42	49.80	-5.10
5	4924.00	55.9 PK	74.0	-18.1	1.11 V	144	52.10	3.80
<b>6</b>	<b>4924.00</b>	<b>53.9 AV</b>	<b>54.0</b>	<b>-0.1</b>	<b>1.11 V</b>	<b>144</b>	<b>50.10</b>	<b>3.80</b>
7	7386.00	53.7 PK	74.0	-20.3	1.00 V	205	45.10	8.60
8	7386.00	41.5 AV	54.0	-12.5	1.00 V	205	32.90	8.60

**REMARKS:**

1. Emission Level(dBuV/m) = Raw Value(dBuV) + Correction Factor(dB/m)
2. Correction Factor(dB/m) = Antenna Factor(dB/m) + Cable Factor(dB) – Pre-Amplifier Factor(dB)
3. The other emission levels were very low against the limit.
4. Margin value = Emission Level – Limit value
5. " \* ": Fundamental frequency.



A D T

## 802.11g, 1Tx

CHANNEL	TX Channel 1	DETECTOR FUNCTION	Peak (PK)
FREQUENCY RANGE	1GHz ~ 25GHz		Average (AV)

ANTENNA POLARITY & TEST DISTANCE: HORIZONTAL AT 3 M								
NO.	FREQ. (MHz)	EMISSION LEVEL (dBuV/m)	LIMIT (dBuV/m)	MARGIN (dB)	ANTENNA HEIGHT (m)	TABLE ANGLE (Degree)	RAW VALUE (dBuV)	CORRECTION FACTOR (dB/m)
1	2390.00	62.0 PK	74.0	-12.0	1.02 H	336	67.60	-5.60
2	2390.00	46.9 AV	54.0	-7.1	1.02 H	336	52.50	-5.60
3	*2412.00	104.6 PK			1.02 H	336	110.10	-5.50
4	*2412.00	95.2 AV			1.02 H	336	100.70	-5.50
5	4824.00	49.3 PK	74.0	-24.7	1.30 H	27	45.50	3.80
6	4824.00	37.9 AV	54.0	-16.1	1.30 H	27	34.10	3.80
ANTENNA POLARITY & TEST DISTANCE: VERTICAL AT 3 M								
NO.	FREQ. (MHz)	EMISSION LEVEL (dBuV/m)	LIMIT (dBuV/m)	MARGIN (dB)	ANTENNA HEIGHT (m)	TABLE ANGLE (Degree)	RAW VALUE (dBuV)	CORRECTION FACTOR (dB/m)
1	2390.00	70.6 PK	74.0	-3.4	1.24 V	40	76.20	-5.60
2	2390.00	53.5 AV	54.0	-0.5	1.24 V	40	59.10	-5.60
3	*2412.00	110.0 PK			1.24 V	40	115.50	-5.50
4	*2412.00	100.6 AV			1.24 V	40	106.10	-5.50
5	4824.00	61.4 PK	74.0	-12.6	1.33 V	132	57.60	3.80
6	4824.00	47.5 AV	54.0	-6.5	1.33 V	132	43.70	3.80

**REMARKS:**

1. Emission Level(dBuV/m) = Raw Value(dBuV) + Correction Factor(dB/m)
2. Correction Factor(dB/m) = Antenna Factor(dB/m) + Cable Factor(dB) – Pre-Amplifier Factor(dB)
3. The other emission levels were very low against the limit.
4. Margin value = Emission Level – Limit value
5. " \* ": Fundamental frequency.



A D T

<b>CHANNEL</b>	TX Channel 6	<b>DETECTOR FUNCTION</b>	Peak (PK)
<b>FREQUENCY RANGE</b>	1GHz ~ 25GHz		Average (AV)

**ANTENNA POLARITY & TEST DISTANCE: HORIZONTAL AT 3 M**

NO.	FREQ. (MHz)	EMISSION LEVEL (dBuV/m)	LIMIT (dBuV/m)	MARGIN (dB)	ANTENNA HEIGHT (m)	TABLE ANGLE (Degree)	RAW VALUE (dBuV)	CORRECTION FACTOR (dB/m)
1	2390.00	46.2 PK	74.0	-27.8	1.02 H	333	51.80	-5.60
2	2390.00	34.5 AV	54.0	-19.5	1.02 H	333	40.10	-5.60
3	*2437.00	106.7 PK			1.02 H	333	112.10	-5.40
4	*2437.00	97.2 AV			1.02 H	333	102.60	-5.40
5	2483.50	50.0 PK	74.0	-24.0	1.02 H	333	55.10	-5.10
6	2483.50	37.5 AV	54.0	-16.5	1.02 H	333	42.60	-5.10
7	4874.00	49.3 PK	74.0	-24.7	1.33 H	16	45.50	3.80
8	4874.00	37.7 AV	54.0	-16.3	1.33 H	16	33.90	3.80
9	7311.00	52.1 PK	74.0	-21.9	1.00 H	162	43.80	8.30
10	7311.00	39.0 AV	54.0	-15.0	1.00 H	162	30.70	8.30

**ANTENNA POLARITY & TEST DISTANCE: VERTICAL AT 3 M**

NO.	FREQ. (MHz)	EMISSION LEVEL (dBuV/m)	LIMIT (dBuV/m)	MARGIN (dB)	ANTENNA HEIGHT (m)	TABLE ANGLE (Degree)	RAW VALUE (dBuV)	CORRECTION FACTOR (dB/m)
1	2390.00	53.5 PK	74.0	-20.5	1.24 V	42	59.10	-5.60
2	2390.00	40.1 AV	54.0	-13.9	1.24 V	42	45.70	-5.60
3	*2437.00	111.8 PK			1.24 V	42	117.20	-5.40
4	*2437.00	102.5 AV			1.24 V	42	107.90	-5.40
5	2483.50	55.6 PK	74.0	-18.4	1.24 V	42	60.70	-5.10
6	2483.50	42.5 AV	54.0	-11.5	1.24 V	42	47.60	-5.10
7	4874.00	61.2 PK	74.0	-12.8	1.37 V	143	57.40	3.80
8	4874.00	47.4 AV	54.0	-6.6	1.37 V	143	43.60	3.80
9	7311.00	54.0 PK	74.0	-20.0	1.00 V	218	45.70	8.30
10	7311.00	41.9 AV	54.0	-12.1	1.00 V	218	33.60	8.30

**REMARKS:**

1. Emission Level(dBuV/m) = Raw Value(dBuV) + Correction Factor(dB/m)
2. Correction Factor(dB/m) = Antenna Factor(dB/m) + Cable Factor(dB) – Pre-Amplifier Factor(dB)
3. The other emission levels were very low against the limit.
4. Margin value = Emission Level – Limit value
5. " \* ": Fundamental frequency.





A D T

<b>CHANNEL</b>	TX Channel 11	<b>DETECTOR FUNCTION</b>	Peak (PK)
<b>FREQUENCY RANGE</b>	1GHz ~ 25GHz		Average (AV)

**ANTENNA POLARITY & TEST DISTANCE: HORIZONTAL AT 3 M**

NO.	FREQ. (MHz)	EMISSION LEVEL (dBuV/m)	LIMIT (dBuV/m)	MARGIN (dB)	ANTENNA HEIGHT (m)	TABLE ANGLE (Degree)	RAW VALUE (dBuV)	CORRECTION FACTOR (dB/m)
1	*2462.00	105.4 PK			1.25 H	336	110.80	-5.40
2	*2462.00	96.4 AV			1.25 H	336	101.80	-5.40
3	2483.50	63.4 PK	74.0	-10.6	1.25 H	336	68.50	-5.10
4	2483.50	48.4 AV	54.0	-5.6	1.25 H	336	53.50	-5.10
5	4924.00	48.7 PK	74.0	-25.3	1.30 H	23	44.90	3.80
6	4924.00	37.4 AV	54.0	-16.6	1.30 H	23	33.60	3.80
7	7386.00	51.7 PK	74.0	-22.3	1.00 H	163	43.10	8.60
8	7386.00	38.9 AV	54.0	-15.1	1.00 H	163	30.30	8.60

**ANTENNA POLARITY & TEST DISTANCE: VERTICAL AT 3 M**

NO.	FREQ. (MHz)	EMISSION LEVEL (dBuV/m)	LIMIT (dBuV/m)	MARGIN (dB)	ANTENNA HEIGHT (m)	TABLE ANGLE (Degree)	RAW VALUE (dBuV)	CORRECTION FACTOR (dB/m)
1	*2462.00	109.8 PK			1.22 V	42	115.20	-5.40
2	*2462.00	100.6 AV			1.22 V	42	106.00	-5.40
3	2483.50	69.0 PK	74.0	-5.0	1.22 V	42	74.10	-5.10
4	<b>2483.50</b>	<b>53.9 AV</b>	<b>54.0</b>	<b>-0.1</b>	<b>1.22 V</b>	<b>42</b>	<b>59.00</b>	<b>-5.10</b>
5	4924.00	45.9 PK	74.0	-28.1	1.12 V	154	42.10	3.80
6	4924.00	34.3 AV	54.0	-19.7	1.12 V	154	30.50	3.80
7	7386.00	53.8 PK	74.0	-20.2	1.00 V	221	45.20	8.60
8	7386.00	41.7 AV	54.0	-12.3	1.00 V	221	33.10	8.60

**REMARKS:**

1. Emission Level(dBuV/m) = Raw Value(dBuV) + Correction Factor(dB/m)
2. Correction Factor(dB/m) = Antenna Factor(dB/m) + Cable Factor(dB) – Pre-Amplifier Factor(dB)
3. The other emission levels were very low against the limit.
4. Margin value = Emission Level – Limit value
5. " \* ": Fundamental frequency.



A D T

### 802.11n (HT20), 1Tx

<b>CHANNEL</b>	TX Channel 1	<b>DETECTOR FUNCTION</b>	Peak (PK)
<b>FREQUENCY RANGE</b>	1GHz ~ 25GHz		Average (AV)

ANTENNA POLARITY & TEST DISTANCE: HORIZONTAL AT 3 M								
NO.	FREQ. (MHz)	EMISSION LEVEL (dBuV/m)	LIMIT (dBuV/m)	MARGIN (dB)	ANTENNA HEIGHT (m)	TABLE ANGLE (Degree)	RAW VALUE (dBuV)	CORRECTION FACTOR (dB/m)
1	2390.00	67.5 PK	74.0	-6.5	1.38 H	73	73.10	-5.60
2	2390.00	49.4 AV	54.0	-4.6	1.38 H	73	55.00	-5.60
3	*2412.00	105.7 PK			1.38 H	73	111.20	-5.50
4	*2412.00	95.0 AV			1.38 H	73	100.50	-5.50
5	4824.00	55.9 PK	74.0	-18.1	1.06 H	29	52.10	3.80
6	4824.00	41.7 AV	54.0	-12.3	1.06 H	29	37.90	3.80
ANTENNA POLARITY & TEST DISTANCE: VERTICAL AT 3 M								
NO.	FREQ. (MHz)	EMISSION LEVEL (dBuV/m)	LIMIT (dBuV/m)	MARGIN (dB)	ANTENNA HEIGHT (m)	TABLE ANGLE (Degree)	RAW VALUE (dBuV)	CORRECTION FACTOR (dB/m)
1	2390.00	71.7 PK	74.0	-2.3	1.00 V	192	77.30	-5.60
2	2390.00	53.4 AV	54.0	-0.6	1.00 V	192	59.00	-5.60
3	*2412.00	107.8 PK			1.00 V	192	113.30	-5.50
4	*2412.00	98.0 AV			1.00 V	192	103.50	-5.50
5	4824.00	60.0 PK	74.0	-14.0	1.00 V	2	56.20	3.80
6	4824.00	45.2 AV	54.0	-8.8	1.00 V	2	41.40	3.80

#### REMARKS:

1. Emission Level(dBuV/m) = Raw Value(dBuV) + Correction Factor(dB/m)
2. Correction Factor(dB/m) = Antenna Factor(dB/m) + Cable Factor(dB) – Pre-Amplifier Factor(dB)
3. The other emission levels were very low against the limit.
4. Margin value = Emission Level – Limit value
5. " \* " : Fundamental frequency.



A D T

<b>CHANNEL</b>	TX Channel 6	<b>DETECTOR FUNCTION</b>	Peak (PK)
<b>FREQUENCY RANGE</b>	1GHz ~ 25GHz		Average (AV)

**ANTENNA POLARITY & TEST DISTANCE: HORIZONTAL AT 3 M**

NO.	FREQ. (MHz)	EMISSION LEVEL (dBuV/m)	LIMIT (dBuV/m)	MARGIN (dB)	ANTENNA HEIGHT (m)	TABLE ANGLE (Degree)	RAW VALUE (dBuV)	CORRECTION FACTOR (dB/m)
1	*2437.00	109.7 PK			1.32 H	67	115.10	-5.40
2	*2437.00	99.1 AV			1.32 H	67	104.50	-5.40
3	4874.00	56.2 PK	74.0	-17.8	1.00 H	16	52.40	3.80
4	4874.00	41.8 AV	54.0	-12.2	1.00 H	16	38.00	3.80
5	7311.00	51.8 PK	74.0	-22.2	1.00 H	169	43.50	8.30
6	7311.00	38.6 AV	54.0	-15.4	1.00 H	169	30.30	8.30

**ANTENNA POLARITY & TEST DISTANCE: VERTICAL AT 3 M**

NO.	FREQ. (MHz)	EMISSION LEVEL (dBuV/m)	LIMIT (dBuV/m)	MARGIN (dB)	ANTENNA HEIGHT (m)	TABLE ANGLE (Degree)	RAW VALUE (dBuV)	CORRECTION FACTOR (dB/m)
1	*2437.00	111.6 PK			1.44 V	197	117.00	-5.40
2	*2437.00	102.0 AV			1.44 V	197	107.40	-5.40
3	4874.00	60.4 PK	74.0	-13.6	1.00 V	12	56.60	3.80
4	4874.00	45.5 AV	54.0	-8.5	1.00 V	12	41.70	3.80
5	7311.00	54.2 PK	74.0	-19.8	1.00 V	220	45.90	8.30
6	7311.00	42.3 AV	54.0	-11.7	1.00 V	220	34.00	8.30

**REMARKS:**

1. Emission Level(dBuV/m) = Raw Value(dBuV) + Correction Factor(dB/m)
2. Correction Factor(dB/m) = Antenna Factor(dB/m) + Cable Factor(dB) – Pre-Amplifier Factor(dB)
3. The other emission levels were very low against the limit.
4. Margin value = Emission Level – Limit value
5. " \* ": Fundamental frequency.



A D T

<b>CHANNEL</b>	TX Channel 11	<b>DETECTOR FUNCTION</b>	Peak (PK)
<b>FREQUENCY RANGE</b>	1GHz ~ 25GHz		Average (AV)

**ANTENNA POLARITY & TEST DISTANCE: HORIZONTAL AT 3 M**

NO.	FREQ. (MHz)	EMISSION LEVEL (dBuV/m)	LIMIT (dBuV/m)	MARGIN (dB)	ANTENNA HEIGHT (m)	TABLE ANGLE (Degree)	RAW VALUE (dBuV)	CORRECTION FACTOR (dB/m)
1	*2462.00	106.8 PK			1.35 H	53	112.20	-5.40
2	*2462.00	95.8 AV			1.35 H	53	101.20	-5.40
3	2483.50	67.6 PK	74.0	-6.4	1.36 H	88	72.70	-5.10
4	2483.50	49.7 AV	54.0	-4.3	1.36 H	88	54.80	-5.10
5	4924.00	56.2 PK	74.0	-17.8	1.00 H	15	52.40	3.80
6	4924.00	42.0 AV	54.0	-12.0	1.00 H	15	38.20	3.80
7	7386.00	52.2 PK	74.0	-21.8	1.04 H	169	43.60	8.60
8	7386.00	38.7 AV	54.0	-15.3	1.04 H	169	30.10	8.60

**ANTENNA POLARITY & TEST DISTANCE: VERTICAL AT 3 M**

NO.	FREQ. (MHz)	EMISSION LEVEL (dBuV/m)	LIMIT (dBuV/m)	MARGIN (dB)	ANTENNA HEIGHT (m)	TABLE ANGLE (Degree)	RAW VALUE (dBuV)	CORRECTION FACTOR (dB/m)
1	*2462.00	108.6 PK			1.00 V	196	114.00	-5.40
2	*2462.00	98.6 AV			1.00 V	196	104.00	-5.40
3	2483.50	70.4 PK	74.0	-3.6	1.00 V	196	75.50	-5.10
4	2483.50	53.7 AV	54.0	-0.3	1.00 V	196	58.80	-5.10
5	4924.00	60.1 PK	74.0	-13.9	1.01 V	25	56.30	3.80
6	4924.00	45.1 AV	54.0	-8.9	1.01 V	25	41.30	3.80
7	7386.00	54.1 PK	74.0	-19.9	1.04 V	208	45.50	8.60
8	7386.00	42.2 AV	54.0	-11.8	1.04 V	208	33.60	8.60

**REMARKS:**

1. Emission Level(dBuV/m) = Raw Value(dBuV) + Correction Factor(dB/m)
2. Correction Factor(dB/m) = Antenna Factor(dB/m) + Cable Factor(dB) – Pre-Amplifier Factor(dB)
3. The other emission levels were very low against the limit.
4. Margin value = Emission Level – Limit value
5. " \* ": Fundamental frequency.



A D T

802.11n (HT40), 1Tx

<b>CHANNEL</b>	TX Channel 3	<b>DETECTOR FUNCTION</b>	Peak (PK)
<b>FREQUENCY RANGE</b>	1GHz ~ 25GHz		Average (AV)

**ANTENNA POLARITY & TEST DISTANCE: HORIZONTAL AT 3 M**

NO.	FREQ. (MHz)	EMISSION LEVEL (dBuV/m)	LIMIT (dBuV/m)	MARGIN (dB)	ANTENNA HEIGHT (m)	TABLE ANGLE (Degree)	RAW VALUE (dBuV)	CORRECTION FACTOR (dB/m)
1	2390.00	58.8 PK	74.0	-15.2	1.00 H	327	64.40	-5.60
2	2390.00	43.4 AV	54.0	-10.6	1.00 H	327	49.00	-5.60
3	*2422.00	96.9 PK			1.00 H	327	102.40	-5.50
4	*2422.00	88.0 AV			1.00 H	327	93.50	-5.50
5	4844.00	56.8 PK	74.0	-17.2	1.04 H	24	53.00	3.80
6	4844.00	42.4 AV	54.0	-11.6	1.04 H	24	38.60	3.80
7	7266.00	52.8 PK	74.0	-21.2	1.00 H	185	44.70	8.10
8	7266.00	39.1 AV	54.0	-14.9	1.00 H	185	31.00	8.10

**ANTENNA POLARITY & TEST DISTANCE: VERTICAL AT 3 M**

NO.	FREQ. (MHz)	EMISSION LEVEL (dBuV/m)	LIMIT (dBuV/m)	MARGIN (dB)	ANTENNA HEIGHT (m)	TABLE ANGLE (Degree)	RAW VALUE (dBuV)	CORRECTION FACTOR (dB/m)
1	2390.00	67.1 PK	74.0	-6.9	1.00 V	193	72.70	-5.60
2	2390.00	53.3 AV	54.0	-0.7	1.00 V	193	58.90	-5.60
3	*2422.00	102.0 PK			1.00 V	193	107.50	-5.50
4	*2422.00	93.7 AV			1.00 V	193	99.20	-5.50
5	4844.00	59.8 PK	74.0	-14.2	1.00 V	11	56.00	3.80
6	4844.00	45.0 AV	54.0	-9.0	1.00 V	11	41.20	3.80
7	7266.00	53.8 PK	74.0	-20.2	1.09 V	223	45.70	8.10
8	7266.00	41.8 AV	54.0	-12.2	1.09 V	223	33.70	8.10

**REMARKS:**

1. Emission Level(dBuV/m) = Raw Value(dBuV) + Correction Factor(dB/m)
2. Correction Factor(dB/m) = Antenna Factor(dB/m) + Cable Factor(dB) – Pre-Amplifier Factor(dB)
3. The other emission levels were very low against the limit.
4. Margin value = Emission Level – Limit value
5. " \* ": Fundamental frequency.



A D T

<b>CHANNEL</b>	TX Channel 6	<b>DETECTOR FUNCTION</b>	Peak (PK)
<b>FREQUENCY RANGE</b>	1GHz ~ 25GHz		Average (AV)

**ANTENNA POLARITY & TEST DISTANCE: HORIZONTAL AT 3 M**

NO.	FREQ. (MHz)	EMISSION LEVEL (dBuV/m)	LIMIT (dBuV/m)	MARGIN (dB)	ANTENNA HEIGHT (m)	TABLE ANGLE (Degree)	RAW VALUE (dBuV)	CORRECTION FACTOR (dB/m)
1	2390.00	59.0 PK	74.0	-15.0	1.00 H	337	64.60	-5.60
2	2390.00	43.5 AV	54.0	-10.5	1.00 H	337	49.10	-5.60
3	*2437.00	101.7 PK			1.00 H	337	107.10	-5.40
4	*2437.00	92.5 AV			1.00 H	337	97.90	-5.40
5	2483.50	59.0 PK	74.0	-15.0	1.00 H	337	64.10	-5.10
6	2483.50	45.2 AV	54.0	-8.8	1.00 H	337	50.30	-5.10
7	4874.00	56.3 PK	74.0	-17.7	1.03 H	16	52.50	3.80
8	4874.00	42.1 AV	54.0	-11.9	1.03 H	16	38.30	3.80
9	7311.00	52.3 PK	74.0	-21.7	1.03 H	180	44.00	8.30
10	7311.00	38.8 AV	54.0	-15.2	1.03 H	180	30.50	8.30

**ANTENNA POLARITY & TEST DISTANCE: VERTICAL AT 3 M**

NO.	FREQ. (MHz)	EMISSION LEVEL (dBuV/m)	LIMIT (dBuV/m)	MARGIN (dB)	ANTENNA HEIGHT (m)	TABLE ANGLE (Degree)	RAW VALUE (dBuV)	CORRECTION FACTOR (dB/m)
1	2390.00	68.5 PK	74.0	-5.5	1.00 V	190	74.10	-5.60
2	2390.00	53.8 AV	54.0	-0.2	1.00 V	190	59.40	-5.60
3	*2437.00	107.3 PK			1.00 V	190	112.70	-5.40
4	*2437.00	98.9 AV			1.00 V	190	104.30	-5.40
5	2483.50	65.1 PK	74.0	-8.9	1.00 V	190	70.20	-5.10
6	2483.50	52.4 AV	54.0	-1.6	1.00 V	190	57.50	-5.10
7	4874.00	59.6 PK	74.0	-14.4	1.05 V	27	55.80	3.80
8	4874.00	44.7 AV	54.0	-9.3	1.05 V	27	40.90	3.80
9	7311.00	53.5 PK	74.0	-20.5	1.11 V	230	45.20	8.30
10	7311.00	41.7 AV	54.0	-12.3	1.11 V	230	33.40	8.30

**REMARKS:**

1. Emission Level(dBuV/m) = Raw Value(dBuV) + Correction Factor(dB/m)
2. Correction Factor(dB/m) = Antenna Factor(dB/m) + Cable Factor(dB) – Pre-Amplifier Factor(dB)
3. The other emission levels were very low against the limit.
4. Margin value = Emission Level – Limit value
5. " \* ": Fundamental frequency.



<b>CHANNEL</b>	TX Channel 9	<b>DETECTOR FUNCTION</b>	Peak (PK)
<b>FREQUENCY RANGE</b>	1GHz ~ 25GHz		Average (AV)

**ANTENNA POLARITY & TEST DISTANCE: HORIZONTAL AT 3 M**

NO.	FREQ. (MHz)	EMISSION LEVEL (dBuV/m)	LIMIT (dBuV/m)	MARGIN (dB)	ANTENNA HEIGHT (m)	TABLE ANGLE (Degree)	RAW VALUE (dBuV)	CORRECTION FACTOR (dB/m)
1	*2452.00	97.3 PK			1.00 H	319	102.70	-5.40
2	*2452.00	88.2 AV			1.00 H	319	93.60	-5.40
3	2483.50	59.0 PK	74.0	-15.0	1.00 H	319	64.10	-5.10
4	2483.50	45.1 AV	54.0	-8.9	1.00 H	319	50.20	-5.10
5	4904.00	56.3 PK	74.0	-17.7	1.08 H	12	52.60	3.70
6	4904.00	42.0 AV	54.0	-12.0	1.08 H	12	38.30	3.70
7	7356.00	52.0 PK	74.0	-22.0	1.00 H	174	43.60	8.40
8	7356.00	38.7 AV	54.0	-15.3	1.00 H	174	30.30	8.40

**ANTENNA POLARITY & TEST DISTANCE: VERTICAL AT 3 M**

NO.	FREQ. (MHz)	EMISSION LEVEL (dBuV/m)	LIMIT (dBuV/m)	MARGIN (dB)	ANTENNA HEIGHT (m)	TABLE ANGLE (Degree)	RAW VALUE (dBuV)	CORRECTION FACTOR (dB/m)
1	*2452.00	102.7 PK			1.00 V	191	108.10	-5.40
2	*2452.00	94.3 AV			1.00 V	191	99.70	-5.40
3	2483.50	64.3 PK	74.0	-9.7	1.00 V	191	69.40	-5.10
4	2483.50	53.1 AV	54.0	-0.9	1.00 V	191	58.20	-5.10
5	4904.00	60.0 PK	74.0	-14.0	1.00 V	27	56.30	3.70
6	4904.00	45.2 AV	54.0	-8.8	1.00 V	27	41.50	3.70
7	7356.00	53.1 PK	74.0	-20.9	1.16 V	214	44.70	8.40
8	7356.00	41.4 AV	54.0	-12.6	1.16 V	214	33.00	8.40

**REMARKS:**

1. Emission Level(dBuV/m) = Raw Value(dBuV) + Correction Factor(dB/m)
2. Correction Factor(dB/m) = Antenna Factor(dB/m) + Cable Factor(dB) – Pre-Amplifier Factor(dB)
3. The other emission levels were very low against the limit.
4. Margin value = Emission Level – Limit value
5. " \* ": Fundamental frequency.



A D T

802.11n (HT20), 2Tx

<b>CHANNEL</b>	TX Channel 1	<b>DETECTOR FUNCTION</b>	Peak (PK)
<b>FREQUENCY RANGE</b>	1GHz ~ 25GHz		Average (AV)

**ANTENNA POLARITY & TEST DISTANCE: HORIZONTAL AT 3 M**

NO.	FREQ. (MHz)	EMISSION LEVEL (dBuV/m)	LIMIT (dBuV/m)	MARGIN (dB)	ANTENNA HEIGHT (m)	TABLE ANGLE (Degree)	RAW VALUE (dBuV)	CORRECTION FACTOR (dB/m)
1	2390.00	49.2 PK	74.0	-24.8	1.03 H	154	54.80	-5.60
2	2390.00	37.6 AV	54.0	-16.4	1.03 H	154	43.20	-5.60
3	*2412.00	109.8 PK			1.07 H	149	115.30	-5.50
4	*2412.00	98.3 AV			1.07 H	149	103.80	-5.50
5	4824.00	55.5 PK	74.0	-18.5	1.57 H	250	51.70	3.80
6	4824.00	41.9 AV	54.0	-12.1	1.57 H	250	38.10	3.80

**ANTENNA POLARITY & TEST DISTANCE: VERTICAL AT 3 M**

NO.	FREQ. (MHz)	EMISSION LEVEL (dBuV/m)	LIMIT (dBuV/m)	MARGIN (dB)	ANTENNA HEIGHT (m)	TABLE ANGLE (Degree)	RAW VALUE (dBuV)	CORRECTION FACTOR (dB/m)
1	2390.00	68.9 PK	74.0	-5.1	1.22 V	38	74.50	-5.60
2	2390.00	53.8 AV	54.0	-0.2	1.22 V	38	59.40	-5.60
3	*2412.00	111.8 PK			1.22 V	38	117.30	-5.50
4	*2412.00	100.6 AV			1.22 V	38	106.10	-5.50
5	4824.00	57.4 PK	74.0	-16.6	1.32 V	140	53.60	3.80
6	4824.00	45.2 AV	54.0	-8.8	1.32 V	140	41.40	3.80

**REMARKS:**

1. Emission Level(dBuV/m) = Raw Value(dBuV) + Correction Factor(dB/m)
2. Correction Factor(dB/m) = Antenna Factor(dB/m) + Cable Factor(dB) – Pre-Amplifier Factor(dB)
3. The other emission levels were very low against the limit.
4. Margin value = Emission Level – Limit value
5. " \* ": Fundamental frequency.





A D T

<b>CHANNEL</b>	TX Channel 6	<b>DETECTOR FUNCTION</b>	Peak (PK)
<b>FREQUENCY RANGE</b>	1GHz ~ 25GHz		Average (AV)

**ANTENNA POLARITY & TEST DISTANCE: HORIZONTAL AT 3 M**

NO.	FREQ. (MHz)	EMISSION LEVEL (dBuV/m)	LIMIT (dBuV/m)	MARGIN (dB)	ANTENNA HEIGHT (m)	TABLE ANGLE (Degree)	RAW VALUE (dBuV)	CORRECTION FACTOR (dB/m)
1	2390.00	49.1 PK	74.0	-24.9	1.05 H	148	54.70	-5.60
2	2390.00	37.3 AV	54.0	-16.7	1.05 H	148	42.90	-5.60
3	*2437.00	112.0 PK			1.05 H	148	117.40	-5.40
4	*2437.00	100.2 AV			1.05 H	148	105.60	-5.40
5	2483.50	51.0 PK	74.0	-23.0	1.05 H	148	56.10	-5.10
6	2483.50	39.0 AV	54.0	-15.0	1.05 H	148	44.10	-5.10
7	4874.00	55.0 PK	74.0	-19.0	1.59 H	245	51.20	3.80
8	4874.00	41.7 AV	54.0	-12.3	1.59 H	245	37.90	3.80
9	7311.00	53.0 PK	74.0	-21.0	1.00 H	291	44.70	8.30
10	7311.00	41.1 AV	54.0	-12.9	1.00 H	291	32.80	8.30

**ANTENNA POLARITY & TEST DISTANCE: VERTICAL AT 3 M**

NO.	FREQ. (MHz)	EMISSION LEVEL (dBuV/m)	LIMIT (dBuV/m)	MARGIN (dB)	ANTENNA HEIGHT (m)	TABLE ANGLE (Degree)	RAW VALUE (dBuV)	CORRECTION FACTOR (dB/m)
1	2390.00	54.3 PK	74.0	-19.7	1.17 V	38	59.90	-5.60
2	2390.00	42.7 AV	54.0	-11.3	1.17 V	38	48.30	-5.60
3	*2437.00	113.9 PK			1.17 V	38	119.30	-5.40
4	*2437.00	102.7 AV			1.17 V	38	108.10	-5.40
5	2483.50	55.7 PK	74.0	-18.3	1.17 V	38	60.80	-5.10
6	2483.50	42.5 AV	54.0	-11.5	1.17 V	38	47.60	-5.10
7	4874.00	66.2 PK	74.0	-7.8	1.37 V	143	62.40	3.80
8	4874.00	53.6 AV	54.0	-0.4	1.37 V	143	49.80	3.80
9	7311.00	54.6 PK	74.0	-19.4	1.00 V	213	46.30	8.30
10	7311.00	41.0 AV	54.0	-13.0	1.00 V	213	32.70	8.30

**REMARKS:**

1. Emission Level(dBuV/m) = Raw Value(dBuV) + Correction Factor(dB/m)
2. Correction Factor(dB/m) = Antenna Factor(dB/m) + Cable Factor(dB) – Pre-Amplifier Factor(dB)
3. The other emission levels were very low against the limit.
4. Margin value = Emission Level – Limit value
5. " \* ": Fundamental frequency.



A D T

<b>CHANNEL</b>	TX Channel 11	<b>DETECTOR FUNCTION</b>	Peak (PK)
<b>FREQUENCY RANGE</b>	1GHz ~ 25GHz		Average (AV)

ANTENNA POLARITY & TEST DISTANCE: HORIZONTAL AT 3 M								
NO.	FREQ. (MHz)	EMISSION LEVEL (dBuV/m)	LIMIT (dBuV/m)	MARGIN (dB)	ANTENNA HEIGHT (m)	TABLE ANGLE (Degree)	RAW VALUE (dBuV)	CORRECTION FACTOR (dB/m)
1	*2462.00	109.8 PK			1.09 H	146	115.20	-5.40
2	*2462.00	98.4 AV			1.09 H	146	103.80	-5.40
3	2483.50	64.6 PK	74.0	-9.4	1.09 H	146	69.70	-5.10
4	2483.50	50.6 AV	54.0	-3.4	1.09 H	146	55.70	-5.10
5	4924.00	54.8 PK	74.0	-19.2	1.61 H	234	51.00	3.80
6	4924.00	41.7 AV	54.0	-12.3	1.61 H	234	37.90	3.80
7	7386.00	53.6 PK	74.0	-20.4	1.00 H	302	45.00	8.60
8	7386.00	41.5 AV	54.0	-12.5	1.00 H	302	32.90	8.60

ANTENNA POLARITY & TEST DISTANCE: VERTICAL AT 3 M								
NO.	FREQ. (MHz)	EMISSION LEVEL (dBuV/m)	LIMIT (dBuV/m)	MARGIN (dB)	ANTENNA HEIGHT (m)	TABLE ANGLE (Degree)	RAW VALUE (dBuV)	CORRECTION FACTOR (dB/m)
1	*2462.00	111.6 PK			1.22 V	41	117.00	-5.40
2	*2462.00	100.1 AV			1.22 V	41	105.50	-5.40
3	2483.50	67.2 PK	74.0	-6.8	1.22 V	41	72.30	-5.10
4	2483.50	53.4 AV	54.0	-0.6	1.22 V	41	58.50	-5.10
5	4924.00	57.7 PK	74.0	-16.3	1.35 V	144	53.90	3.80
6	4924.00	45.3 AV	54.0	-8.7	1.35 V	144	41.50	3.80
7	7386.00	54.2 PK	74.0	-19.8	1.00 V	211	45.60	8.60
8	7386.00	42.0 AV	54.0	-12.0	1.00 V	211	33.40	8.60

**REMARKS:**

1. Emission Level(dBuV/m) = Raw Value(dBuV) + Correction Factor(dB/m)
2. Correction Factor(dB/m) = Antenna Factor(dB/m) + Cable Factor(dB) – Pre-Amplifier Factor(dB)
3. The other emission levels were very low against the limit.
4. Margin value = Emission Level – Limit value
5. " \* ": Fundamental frequency.



A D T

802.11n (HT40), 2Tx

<b>CHANNEL</b>	TX Channel 3	<b>DETECTOR FUNCTION</b>	Peak (PK)
<b>FREQUENCY RANGE</b>	1GHz ~ 25GHz		Average (AV)

**ANTENNA POLARITY & TEST DISTANCE: HORIZONTAL AT 3 M**

NO.	FREQ. (MHz)	EMISSION LEVEL (dBuV/m)	LIMIT (dBuV/m)	MARGIN (dB)	ANTENNA HEIGHT (m)	TABLE ANGLE (Degree)	RAW VALUE (dBuV)	CORRECTION FACTOR (dB/m)
1	2390.00	61.0 PK	74.0	-13.0	1.02 H	311	66.60	-5.60
2	2390.00	47.7 AV	54.0	-6.3	1.02 H	311	53.30	-5.60
3	*2422.00	105.9 PK			1.00 H	340	111.40	-5.50
4	*2422.00	94.3 AV			1.00 H	340	99.80	-5.50
5	4844.00	52.8 PK	74.0	-21.2	1.00 H	287	49.00	3.80
6	4844.00	40.7 AV	54.0	-13.3	1.00 H	287	36.90	3.80
7	7266.00	54.0 PK	74.0	-20.0	1.00 H	303	45.90	8.10
8	7266.00	41.9 AV	54.0	-12.1	1.00 H	303	33.80	8.10

**ANTENNA POLARITY & TEST DISTANCE: VERTICAL AT 3 M**

NO.	FREQ. (MHz)	EMISSION LEVEL (dBuV/m)	LIMIT (dBuV/m)	MARGIN (dB)	ANTENNA HEIGHT (m)	TABLE ANGLE (Degree)	RAW VALUE (dBuV)	CORRECTION FACTOR (dB/m)
1	2390.00	66.6 PK	74.0	-7.4	1.20 V	40	72.20	-5.60
2	2390.00	53.8 AV	54.0	-0.2	1.20 V	40	59.40	-5.60
3	*2422.00	107.6 PK			1.20 V	40	113.10	-5.50
4	*2422.00	96.2 AV			1.20 V	40	101.70	-5.50
5	4844.00	63.0 PK	74.0	-11.0	1.33 V	158	59.20	3.80
6	4844.00	50.7 AV	54.0	-3.3	1.33 V	158	46.90	3.80
7	7266.00	53.6 PK	74.0	-20.4	1.00 V	208	45.50	8.10
8	7266.00	41.5 AV	54.0	-12.5	1.00 V	208	33.40	8.10

**REMARKS:**

1. Emission Level(dBuV/m) = Raw Value(dBuV) + Correction Factor(dB/m)
2. Correction Factor(dB/m) = Antenna Factor(dB/m) + Cable Factor(dB) – Pre-Amplifier Factor(dB)
3. The other emission levels were very low against the limit.
4. Margin value = Emission Level – Limit value
5. " \* ": Fundamental frequency.



A D T

<b>CHANNEL</b>	TX Channel 6	<b>DETECTOR FUNCTION</b>	Peak (PK)
<b>FREQUENCY RANGE</b>	1GHz ~ 25GHz		Average (AV)

**ANTENNA POLARITY & TEST DISTANCE: HORIZONTAL AT 3 M**

NO.	FREQ. (MHz)	EMISSION LEVEL (dBuV/m)	LIMIT (dBuV/m)	MARGIN (dB)	ANTENNA HEIGHT (m)	TABLE ANGLE (Degree)	RAW VALUE (dBuV)	CORRECTION FACTOR (dB/m)
1	2390.00	61.2 PK	74.0	-12.8	1.01 H	324	66.80	-5.60
2	2390.00	47.9 AV	54.0	-6.1	1.01 H	324	53.50	-5.60
3	*2437.00	109.6 PK			1.01 H	324	115.00	-5.40
4	*2437.00	97.9 AV			1.01 H	324	103.30	-5.40
5	2483.50	61.5 PK	74.0	-12.5	1.01 H	324	66.60	-5.10
6	2483.50	47.5 AV	54.0	-6.5	1.01 H	324	52.60	-5.10
7	4874.00	53.1 PK	74.0	-20.9	1.00 H	296	49.30	3.80
8	4874.00	41.2 AV	54.0	-12.8	1.00 H	296	37.40	3.80
9	7311.00	54.2 PK	74.0	-19.8	1.00 H	295	45.90	8.30
10	7311.00	41.9 AV	54.0	-12.1	1.00 H	295	33.60	8.30

**ANTENNA POLARITY & TEST DISTANCE: VERTICAL AT 3 M**

NO.	FREQ. (MHz)	EMISSION LEVEL (dBuV/m)	LIMIT (dBuV/m)	MARGIN (dB)	ANTENNA HEIGHT (m)	TABLE ANGLE (Degree)	RAW VALUE (dBuV)	CORRECTION FACTOR (dB/m)
1	2390.00	66.5 PK	74.0	-7.5	1.19 V	39	72.10	-5.60
2	2390.00	53.2 AV	54.0	-0.8	1.19 V	39	58.80	-5.60
3	*2437.00	111.4 PK			1.19 V	39	116.80	-5.40
4	*2437.00	100.5 AV			1.19 V	39	105.90	-5.40
5	2483.50	64.8 PK	74.0	-9.2	1.19 V	39	69.90	-5.10
6	2483.50	50.3 AV	54.0	-3.7	1.19 V	39	55.40	-5.10
7	4874.00	63.6 PK	74.0	-10.4	1.37 V	144	59.80	3.80
8	4874.00	51.0 AV	54.0	-3.0	1.37 V	144	47.20	3.80
9	7311.00	53.2 PK	74.0	-20.8	1.00 V	206	44.90	8.30
10	7311.00	41.3 AV	54.0	-12.7	1.00 V	206	33.00	8.30

**REMARKS:**

1. Emission Level(dBuV/m) = Raw Value(dBuV) + Correction Factor(dB/m)
2. Correction Factor(dB/m) = Antenna Factor(dB/m) + Cable Factor(dB) – Pre-Amplifier Factor(dB)
3. The other emission levels were very low against the limit.
4. Margin value = Emission Level – Limit value
5. " \* ": Fundamental frequency.



<b>CHANNEL</b>	TX Channel 9	<b>DETECTOR FUNCTION</b>	Peak (PK)
<b>FREQUENCY RANGE</b>	1GHz ~ 25GHz		Average (AV)

**ANTENNA POLARITY & TEST DISTANCE: HORIZONTAL AT 3 M**

NO.	FREQ. (MHz)	EMISSION LEVEL (dBuV/m)	LIMIT (dBuV/m)	MARGIN (dB)	ANTENNA HEIGHT (m)	TABLE ANGLE (Degree)	RAW VALUE (dBuV)	CORRECTION FACTOR (dB/m)
1	*2452.00	106.3 PK			1.00 H	325	111.70	-5.40
2	*2452.00	94.4 AV			1.00 H	325	99.80	-5.40
3	2483.50	61.1 PK	74.0	-12.9	1.04 H	334	66.20	-5.10
4	2483.50	47.1 AV	54.0	-6.9	1.04 H	334	52.20	-5.10
5	4904.00	53.1 PK	74.0	-20.9	1.01 H	290	49.40	3.70
6	4904.00	40.8 AV	54.0	-13.2	1.01 H	290	37.10	3.70
7	7356.00	54.5 PK	74.0	-19.5	1.00 H	309	46.10	8.40
8	7356.00	42.2 AV	54.0	-11.8	1.00 H	309	33.80	8.40

**ANTENNA POLARITY & TEST DISTANCE: VERTICAL AT 3 M**

NO.	FREQ. (MHz)	EMISSION LEVEL (dBuV/m)	LIMIT (dBuV/m)	MARGIN (dB)	ANTENNA HEIGHT (m)	TABLE ANGLE (Degree)	RAW VALUE (dBuV)	CORRECTION FACTOR (dB/m)
1	*2452.00	108.2 PK			1.19 V	40	113.60	-5.40
2	*2452.00	96.8 AV			1.19 V	40	102.20	-5.40
3	2483.50	66.2 PK	74.0	-7.8	1.19 V	40	71.30	-5.10
4	2483.50	53.7 AV	54.0	-0.3	1.19 V	40	58.80	-5.10
5	4904.00	63.1 PK	74.0	-10.9	1.25 V	171	59.40	3.70
6	4904.00	50.9 AV	54.0	-3.1	1.25 V	171	47.20	3.70
7	7356.00	52.7 PK	74.0	-21.3	1.05 V	214	44.30	8.40
8	7356.00	41.1 AV	54.0	-12.9	1.05 V	214	32.70	8.40

**REMARKS:**

1. Emission Level(dBuV/m) = Raw Value(dBuV) + Correction Factor(dB/m)
2. Correction Factor(dB/m) = Antenna Factor(dB/m) + Cable Factor(dB) – Pre-Amplifier Factor(dB)
3. The other emission levels were very low against the limit.
4. Margin value = Emission Level – Limit value
5. " \* ": Fundamental frequency.

### 4.3 6dB BANDWIDTH MEASUREMENT

#### 4.3.1 LIMITS OF 6dB BANDWIDTH MEASUREMENT

The minimum of 6dB Bandwidth Measurement is 0.5 MHz.

#### 4.3.2 TEST INSTRUMENTS

DESCRIPTION & MANUFACTURER	MODEL NO.	SERIAL NO.	CALIBRATED DATE	CALIBRATED UNTIL
Spectrum Analyzer R&S	FSV 40	100964	July 15, 2013	July 14, 2014

**Note:**

1. The calibration interval of the above test instruments is 12 months and the calibrations are traceable to NML/ROC and NIST/USA.
2. Tested date : Apr. 08, 2014

#### 4.3.3 TEST PROCEDURE

1. Set resolution bandwidth (RBW) = 100kHz
2. Set the video bandwidth (VBW)  $\geq 3 \times$  RBW, Detector = Peak.
3. Trace mode = max hold.
4. Sweep = auto couple.
5. Measure the maximum width of the emission that is constrained by the frequencies associated with the two amplitude points (upper and lower) that are attenuated by 6 dB relative to the maximum level measured in the fundamental emission

#### 4.3.4 DEVIATION FROM TEST STANDARD

No deviation

#### 4.3.5 TEST SETUP

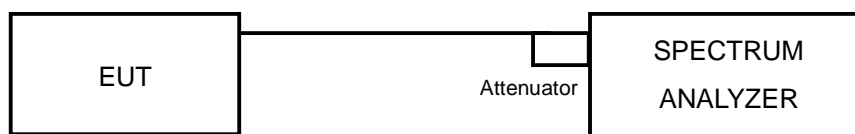

#### 4.3.6 EUT OPERATING CONDITIONS

The software provided by client to enable the EUT under transmission condition continuously at lowest, middle and highest channel frequencies individually.



A D T

### 4.3.7 TEST RESULTS

#### 802.11b, 1Tx

CHANNEL	CHANNEL FREQUENCY (MHz)	6dB BANDWIDTH (MHz)	MINIMUM LIMIT (MHz)	PASS / FAIL
1	2412	10.10	0.5	PASS
6	2437	10.12	0.5	PASS
11	2462	10.10	0.5	PASS

#### 802.11g, 1Tx

CHANNEL	CHANNEL FREQUENCY (MHz)	6dB BANDWIDTH (MHz)	MINIMUM LIMIT (MHz)	PASS / FAIL
1	2412	16.64	0.5	PASS
6	2437	16.64	0.5	PASS
11	2462	16.65	0.5	PASS

#### 802.11n (HT20), 1Tx

CHANNEL	CHANNEL FREQUENCY (MHz)	6dB BANDWIDTH (MHz)	MINIMUM LIMIT (MHz)	PASS / FAIL
1	2412	17.86	0.5	PASS
6	2437	17.85	0.5	PASS
11	2462	17.87	0.5	PASS

#### 802.11n (HT40), 1Tx

CHANNEL	CHANNEL FREQUENCY (MHz)	6dB BANDWIDTH (MHz)	MINIMUM LIMIT (MHz)	PASS / FAIL
3	2422	36.54	0.5	PASS
6	2437	36.52	0.5	PASS
9	2452	36.53	0.5	PASS



A D T

### SPECTRUM PLOT OF WORST VALUE

#### 802.11b / CH1

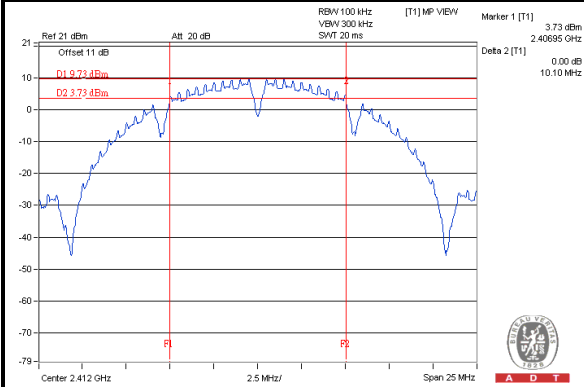

#### 802.11g / CH1

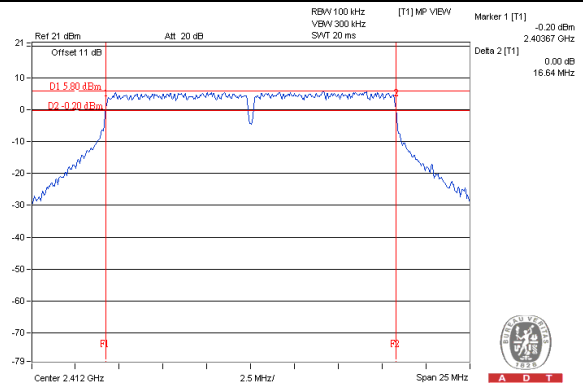

#### 802.11n (HT20) : CH6

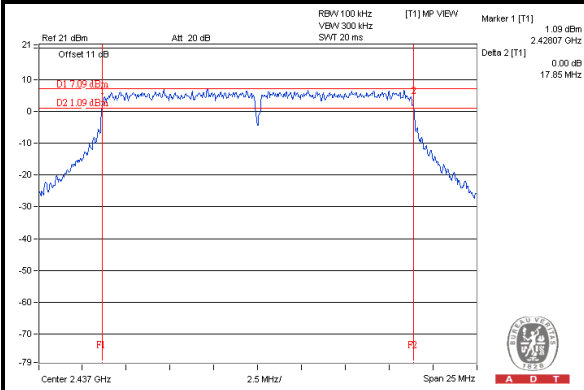

#### 802.11n (HT40) : CH6

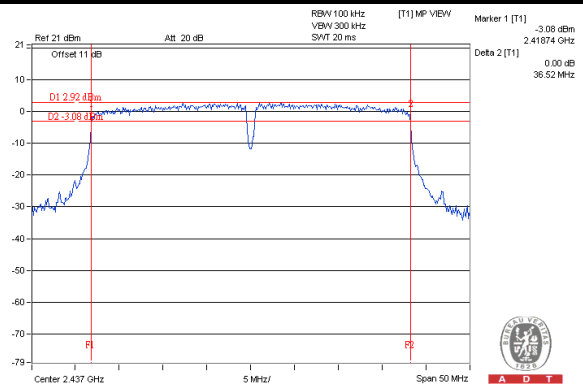





A D T

802.11n (HT20), 2Tx

CHANNEL	CHANNEL FREQUENCY (MHz)	6dB BANDWIDTH (MHz)		MINIMUM LIMIT (MHz)	PASS / FAIL
		CHAIN 0	CHAIN 1		
1	2412	17.88	17.74	0.5	PASS
6	2437	17.87	17.75	0.5	PASS
11	2462	17.88	17.79	0.5	PASS

802.11n (HT40), 2Tx

CHANNEL	CHANNEL FREQUENCY (MHz)	6dB BANDWIDTH (MHz)		MINIMUM LIMIT (MHz)	PASS / FAIL
		CHAIN 0	CHAIN 1		
3	2422	36.53	36.47	0.5	PASS
6	2437	36.50	36.43	0.5	PASS
9	2452	36.53	36.45	0.5	PASS

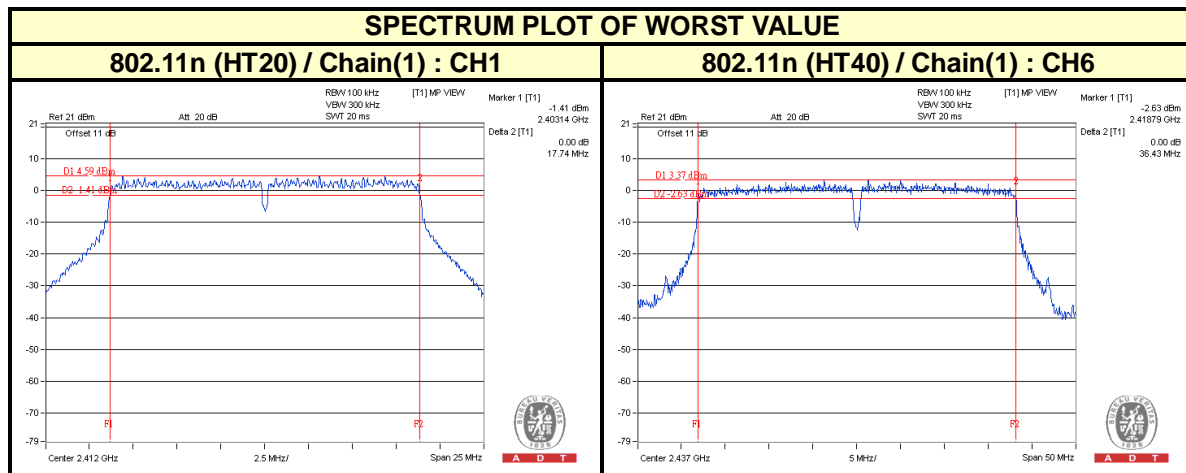

## 4.4 CONDUCTED OUTPUT POWER MEASUREMENT

### 4.4.1 LIMITS OF CONDUCTED OUTPUT POWER MEASUREMENT

For systems using digital modulation in the 2400–2483.5 MHz bands: 1 Watt (30dBm)

Per KDB 662911 D01 Multiple Transmitter Output Method of conducted output power measurement on IEEE 802.11 devices,

Array Gain = 0 dB (i.e., no array gain) for  $NANT \leq 4$ ;

Array Gain = 0 dB (i.e., no array gain) for channel widths  $\geq 40$  MHz for any NANT;

Array Gain =  $5 \log(NANT/NSS)$  dB or 3 dB, whichever is less for 20-MHz channel widths with  $NANT \geq 5$ .

For power measurements on all other devices: Array Gain =  $10 \log(NANT/NSS)$  dB.

### 4.4.2 INSTRUMENTS

DESCRIPTION & MANUFACTURER	MODEL NO.	SERIAL NO.	CALIBRATED DATE	CALIBRATED UNTIL
Power meter Anritsu	ML2495A	1014008	Apr. 23, 2013	Apr. 22, 2014
Power sensor Anritsu	MA2411B	0917122	Apr. 23, 2013	Apr. 22, 2014

**Note:**

1. The calibration interval of the above test instruments is 12 months and the calibrations are traceable to NML/ROC and NIST/USA.
2. Tested date : Apr. 08, 2014

### 4.4.3 TEST PROCEDURES

The average power sensor was used on the output port of the EUT. A power meter was used to read the response of the average power sensor. Record the average power level.

#### 4.4.4 DEVIATION FROM TEST STANDARD

No deviation.

#### 4.4.5 TEST SETUP

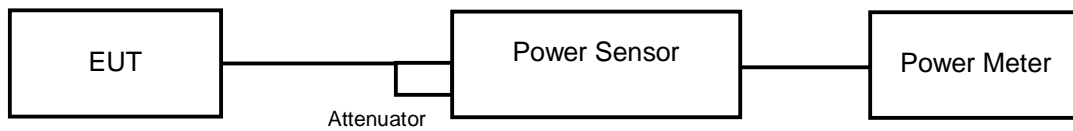

#### 4.4.6 EUT OPERATING CONDITIONS

Same as Item 4.3.6



A D T

#### 4.4.7 TEST RESULTS

##### 802.11b, 1Tx

CHANNEL	FREQUENCY (MHz)	AVERAGE POWER (mW)	AVERAGE POWER (dBm)	LIMIT (dBm)	PASS/FAIL
1	2412	105.439	20.23	30	PASS
6	2437	122.744	20.89	30	PASS
11	2462	137.404	21.38	30	PASS

##### 802.11g, 1Tx

CHANNEL	FREQUENCY (MHz)	AVERAGE POWER (mW)	AVERAGE POWER (dBm)	LIMIT (dBm)	PASS/FAIL
1	2412	119.124	20.76	30	PASS
6	2437	146.893	21.67	30	PASS
11	2462	89.536	19.52	30	PASS

##### 802.11n (HT20), 1Tx

CHANNEL	FREQUENCY (MHz)	AVERAGE POWER (mW)	AVERAGE POWER (dBm)	LIMIT (dBm)	PASS/FAIL
1	2412	74.302	18.71	30	PASS
6	2437	148.594	21.72	30	PASS
11	2462	88.716	19.48	30	PASS

##### 802.11n (HT40), 1Tx

CHANNEL	FREQUENCY (MHz)	AVERAGE POWER (mW)	AVERAGE POWER (dBm)	LIMIT (dBm)	PASS/FAIL
3	2422	38.637	15.87	30	PASS
6	2437	102.802	20.12	30	PASS
9	2452	35.645	15.52	30	PASS



A D T

**802.11n (HT20), 2Tx**

CHANNEL	FREQUENCY (MHz)	AVERAGE POWER (dBm)		TOTAL POWER (mW)	TOTAL POWER (dBm)	LIMIT (dBm)	PASS / FAIL
		CHAIN 0	CHAIN 1				
1	2412	18.71	18.34	142.536	21.54	30	PASS
6	2437	20.68	20.23	222.389	23.47	30	PASS
11	2462	18.97	18.54	150.336	21.77	30	PASS

**802.11n (HT40), 2Tx**

CHANNEL	FREQUENCY (MHz)	AVERAGE POWER (dBm)		TOTAL POWER (mW)	TOTAL POWER (dBm)	LIMIT (dBm)	PASS / FAIL
		CHAIN 0	CHAIN 1				
3	2422	16.79	16.74	94.959	19.78	30	PASS
6	2437	21.12	21.19	260.942	24.17	30	PASS
9	2452	17.01	17.03	100.700	20.03	30	PASS

## 4.5 POWER SPECTRAL DENSITY MEASUREMENT

### 4.5.1 LIMITS OF POWER SPECTRAL DENSITY MEASUREMENT

The Maximum of Power Spectral Density Measurement is 8dBm.

### 4.5.2 TEST INSTRUMENTS

DESCRIPTION & MANUFACTURER	MODEL NO.	SERIAL NO.	CALIBRATED DATE	CALIBRATED UNTIL
Spectrum Analyzer R&S	FSV 40	100964	July 15, 2013	July 14, 2014

**Note:**

1. The calibration interval of the above test instruments is 12 months and the calibrations are traceable to NML/ROC and NIST/USA.
2. Tested date : Apr. 08, 2014

### 4.5.3 TEST PROCEDURE

1. Set the RBW = 10 kHz, VBW =30 kHz, Detector = power averaging (RMS).
2. Ensure that the number of measurement points in the sweep  $\geq 2 \times$  span/RBW
3. Sweep time = auto couple,
4. Employ trace averaging (RMS) mode over a minimum of 100 traces.
5. Use the peak marker function to determine the maximum amplitude level.

### 4.5.4 DEVIATION FROM TEST STANDARD

No deviation

### 4.5.5 TEST SETUP



### 4.5.6 EUT OPERATING CONDITION

Same as Item 4.3.6

## 4.5.7 TEST RESULTS

### 802.11b, 1Tx

CHANNEL	FREQUENCY (MHz)	PSD (dBm)	LIMIT (dBm)	PASS /FAIL
1	2412	-7.84	8	PASS
6	2437	-7.37	8	PASS
11	2462	-6.91	8	PASS

### 802.11g, 1Tx

CHANNEL	FREQUENCY (MHz)	PSD (dBm)	LIMIT (dBm)	PASS /FAIL
1	2412	-9.14	8	PASS
6	2437	-8.97	8	PASS
11	2462	-10.80	8	PASS

### 802.11n (HT20), 1Tx

CHANNEL	FREQUENCY (MHz)	PSD (dBm)	LIMIT (dBm)	PASS /FAIL
1	2412	-11.70	8	PASS
6	2437	-8.88	8	PASS
11	2462	-10.89	8	PASS

### 802.11n (HT40), 1Tx

CHANNEL	FREQUENCY (MHz)	PSD (dBm)	LIMIT (dBm)	PASS /FAIL
3	2422	-16.87	8	PASS
6	2437	-12.22	8	PASS
9	2452	-16.90	8	PASS



A D T

### SPECTRUM PLOT OF WORST VALUE

#### 802.11b / CH11

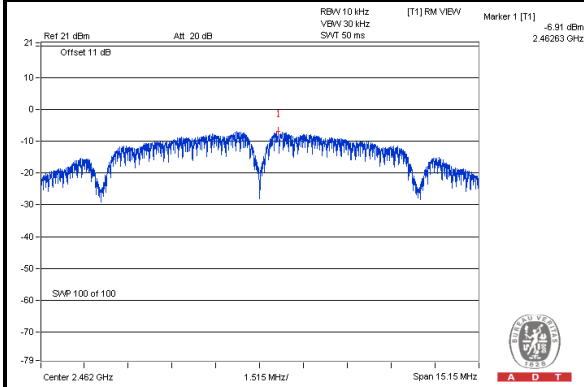

#### 802.11g / CH6

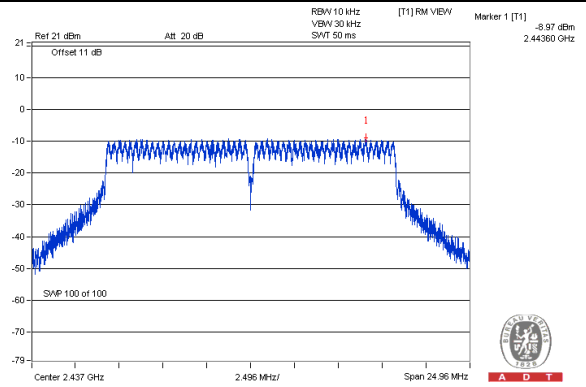

#### 802.11n (HT20) : CH6

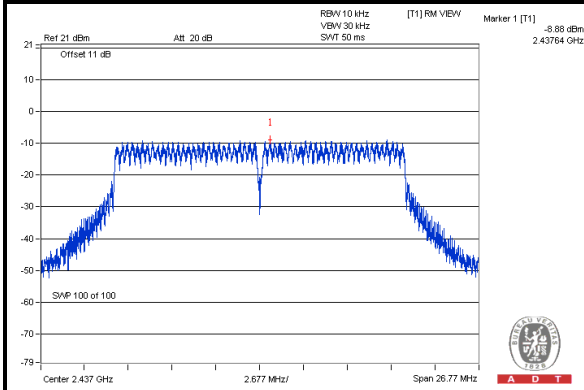

#### 802.11n (HT40) : CH6

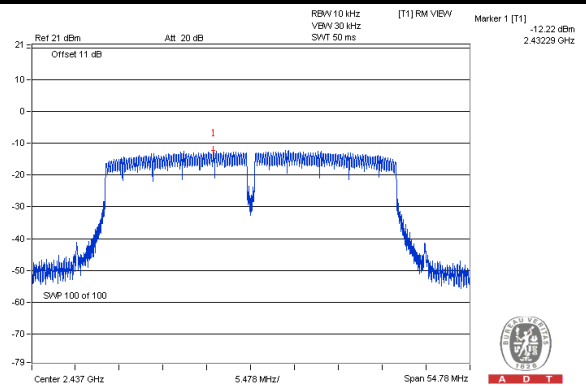





A D T

802.11n (HT20), 2Tx

TX CHAIN	CHANNEL	FREQUENCY (MHz)	PSD (dBm)	10 log (N=2) dB	Total PSD (dBm)	Limit (dBm)	PASS /FAIL
0	1	2412	-12.79	3.01	-9.78	8	PASS
	6	2437	-10.33	3.01	-7.32	8	PASS
	11	2462	-12.46	3.01	-9.45	8	PASS
1	1	2412	-12.49	3.01	-9.48	8	PASS
	6	2437	-11.87	3.01	-8.86	8	PASS
	11	2462	-12.62	3.01	-9.61	8	PASS

802.11n (HT40), 2Tx

TX CHAIN	CHANNEL	FREQUENCY (MHz)	PSD (dBm)	10 log (N=2) dB	Total PSD (dBm)	Limit (dBm)	PASS /FAIL
0	3	2422	-16.31	3.01	-13.30	8	PASS
	6	2437	-11.35	3.01	-8.34	8	PASS
	9	2452	-16.13	3.01	-13.12	8	PASS
1	3	2422	-15.64	3.01	-12.63	8	PASS
	6	2437	-12.73	3.01	-9.72	8	PASS
	9	2452	-15.17	3.01	-12.16	8	PASS

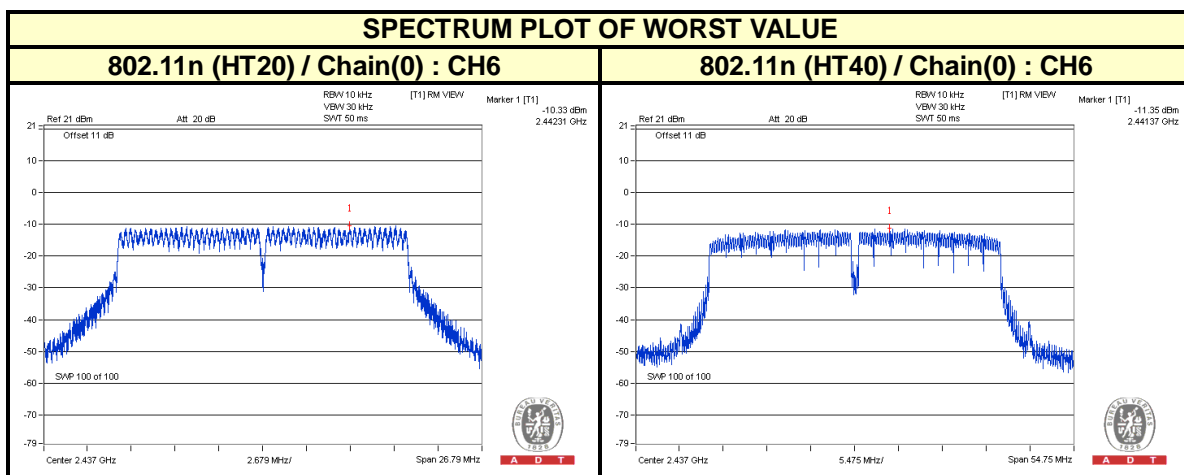

## 4.6 CONDUCTED OUT-BAND EMISSION MEASUREMENT

### 4.6.1 LIMITS OF CONDUCTED OUT-BAND EMISSION MEASUREMENT

Below 30dB of the highest emission level of operating band (in 100kHz Resolution Bandwidth).

### 4.6.2 TEST INSTRUMENTS

DESCRIPTION & MANUFACTURER	MODEL NO.	SERIAL NO.	CALIBRATED DATE	CALIBRATED UNTIL
Spectrum Analyzer R&S	FSV 40	100964	July 15, 2013	July 14, 2014

**Note:**

1. The calibration interval of the above test instruments is 12 months and the calibrations are traceable to NML/ROC and NIST/USA.
2. Tested date : Apr. 08, 2014

### 4.6.3 TEST PROCEDURE

#### Measurement Procedure - Reference Level

1. Set the RBW = 100 kHz.
2. Set the VBW  $\geq$  300 kHz.
3. Detector = peak.
4. Sweep time = auto couple.
5. Trace mode = max hold.
6. Allow trace to fully stabilize.
7. Use the peak marker function to determine the maximum power level in any 100 kHz band segment within the fundamental EBW.

#### Measurement Procedure –Unwanted Emission Level

1. Set RBW = 100 kHz.
2. Set VBW  $\geq$  300 kHz.
3. Set span to encompass the spectrum to be examined
4. Detector = peak.
5. Trace Mode = max hold.
6. Sweep = auto couple.

#### 4.6.4 DEVIATION FROM TEST STANDARD

No deviation

#### 4.6.5 TEST SETUP

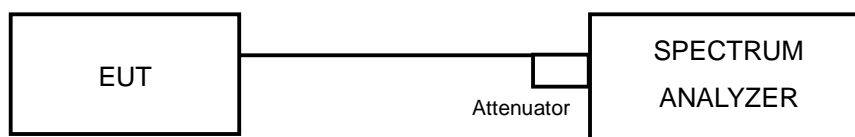

#### 4.6.6 EUT OPERATING CONDITION

Same as Item 4.3.6

#### 4.6.7 TEST RESULTS

The spectrum plots are attached on the following pages. D1 line indicates the highest level, and D2 line indicates the 30dB offset below D1. It shows compliance with the requirement.



A D T

### 802.11b, 1Tx:

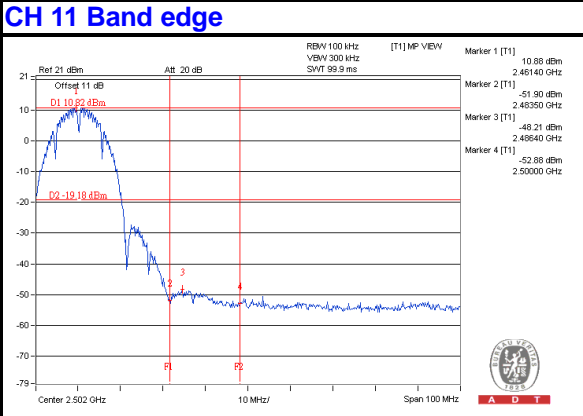
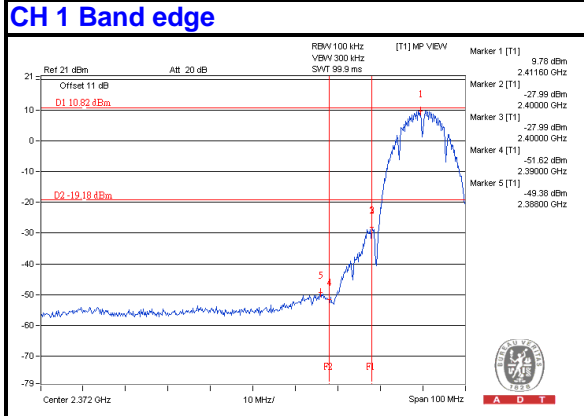
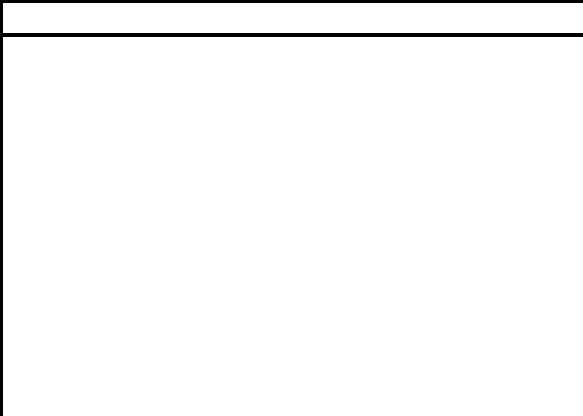
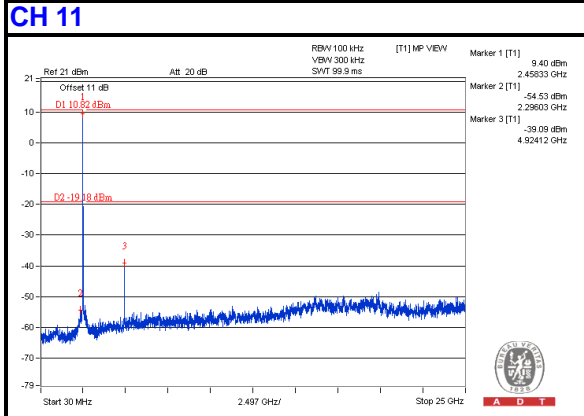
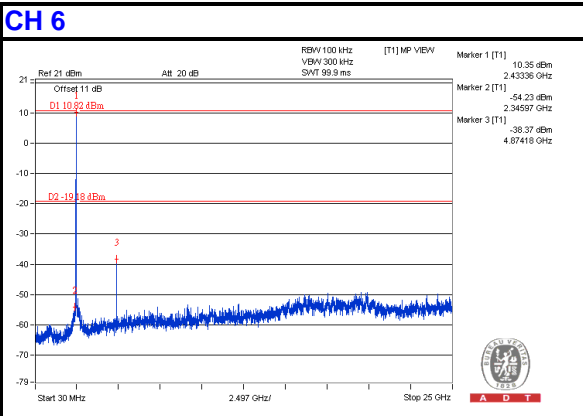
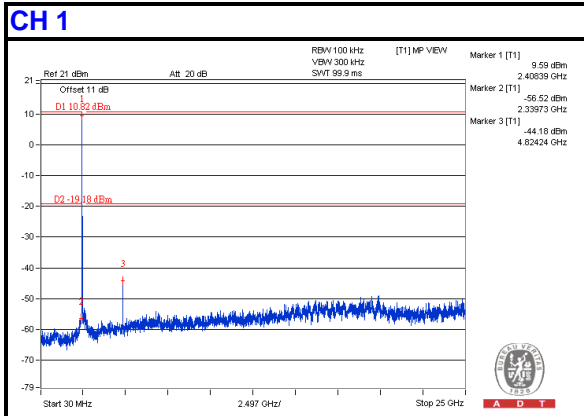
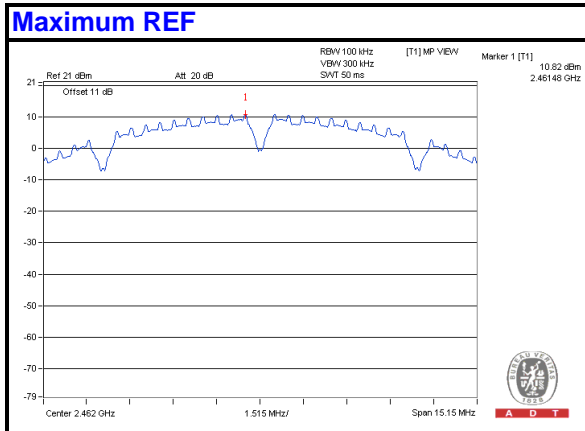



A D T

802.11g, 1Tx:

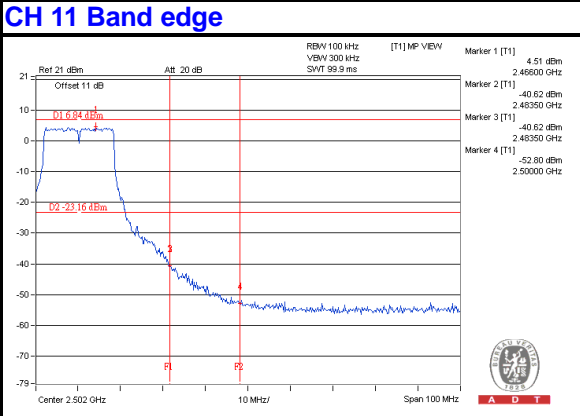
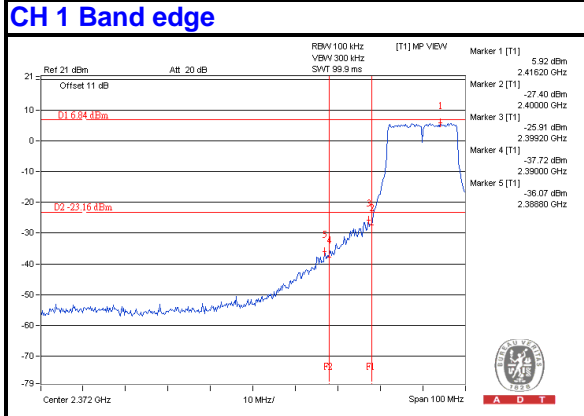
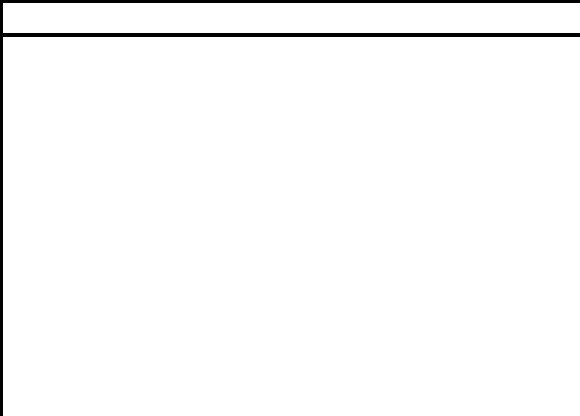
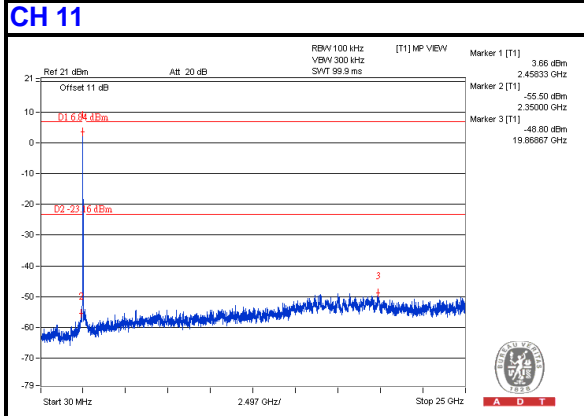
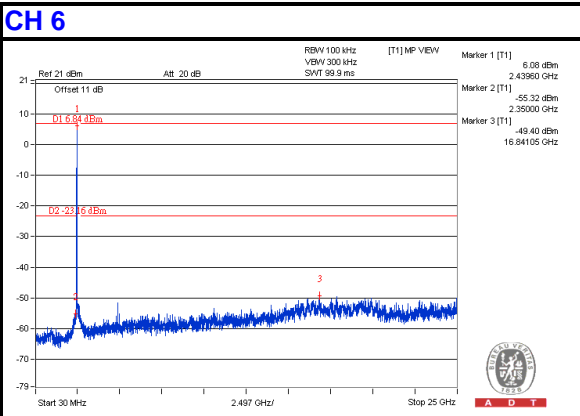
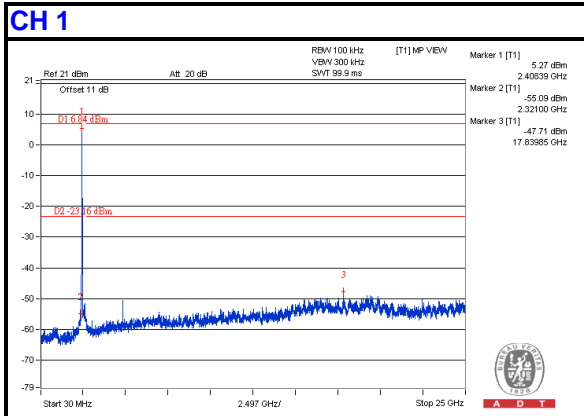
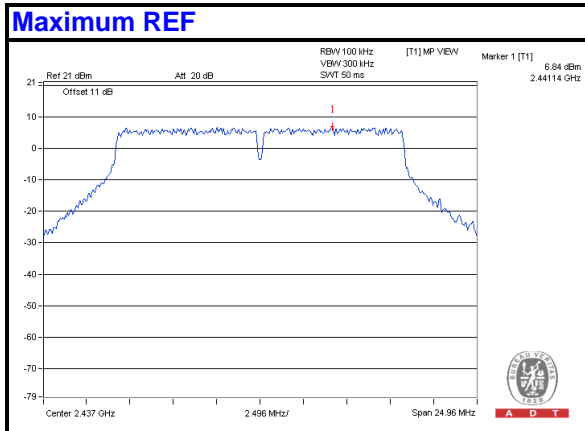



A D T

### 802.11n(HT20), 1Tx:

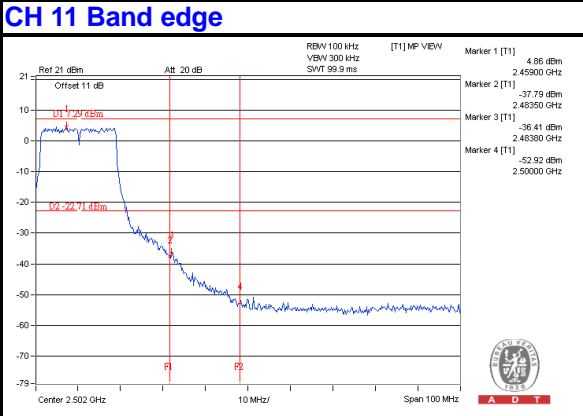
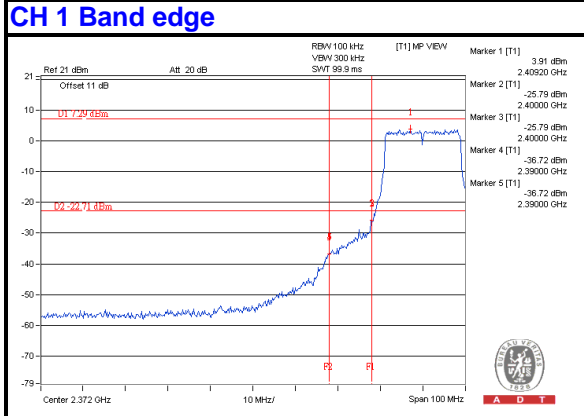
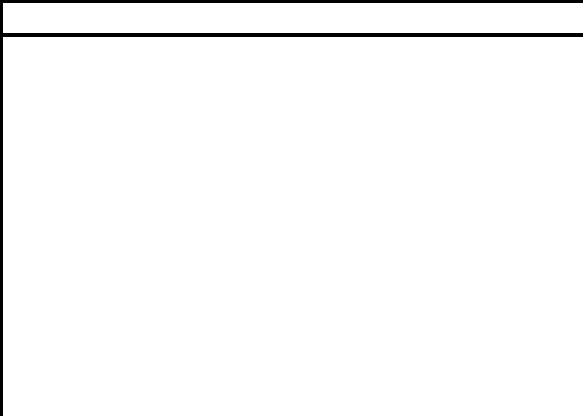
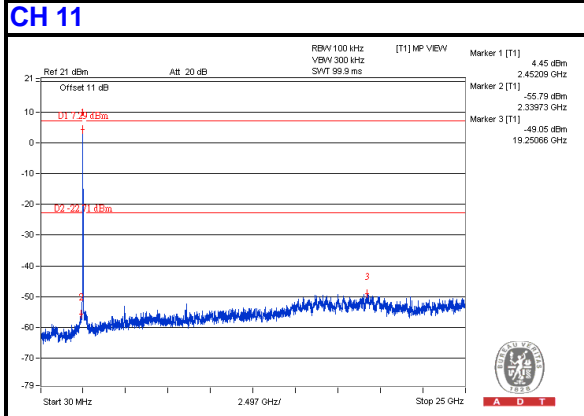
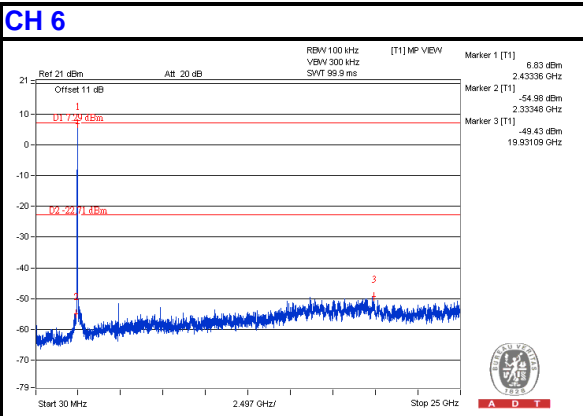
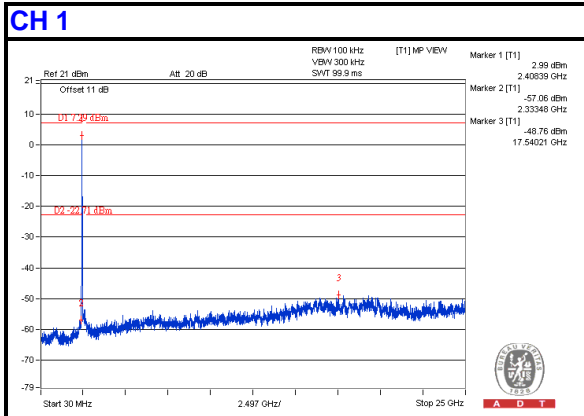
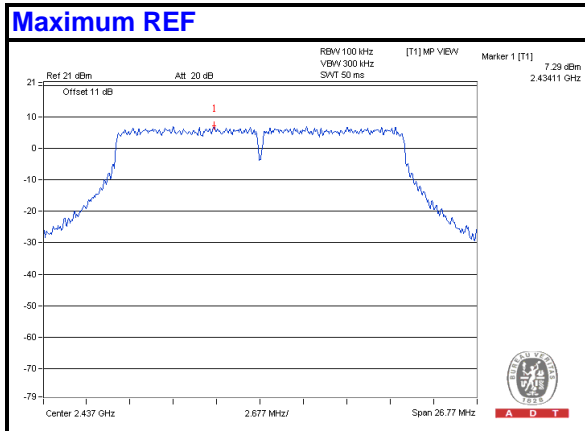



A D T

### 802.11n(HT40), 1Tx:

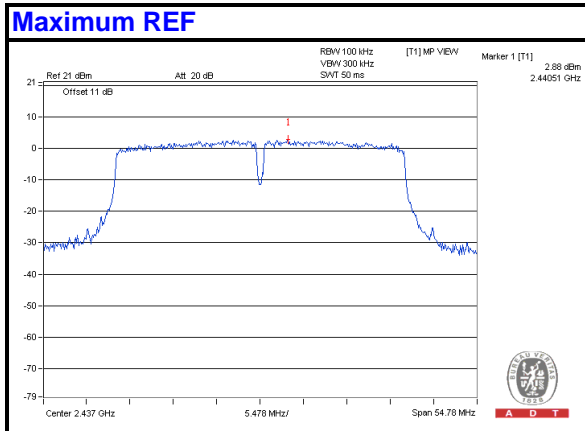

### CH 3

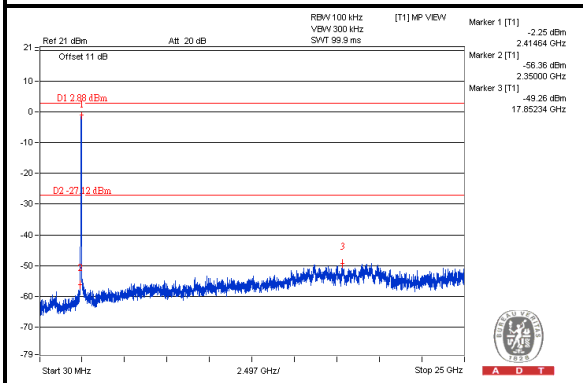

### CH 6

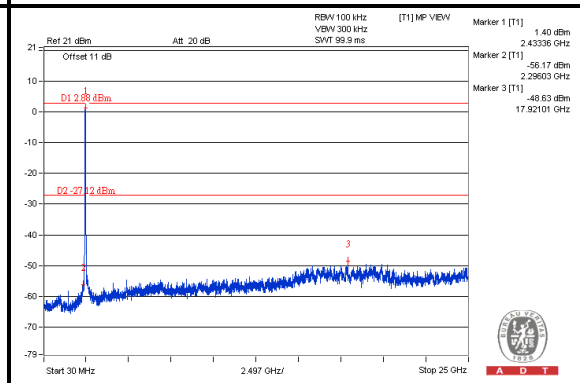

### CH 9

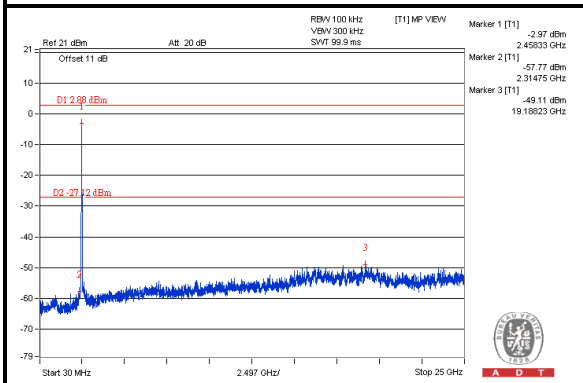

### CH 3 Band edge

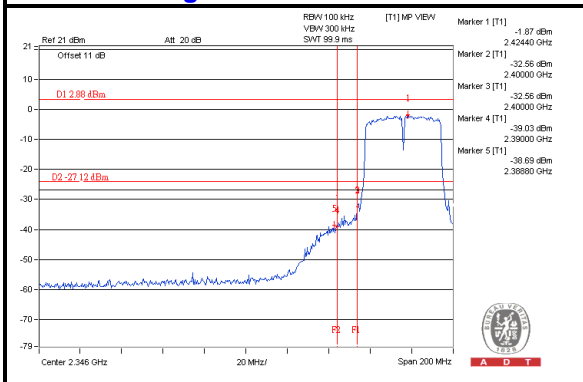

### CH 9 Band edge

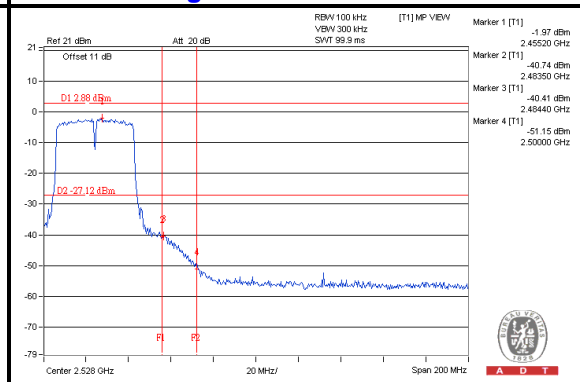



A D T

### 802.11n(HT20), 2Tx:

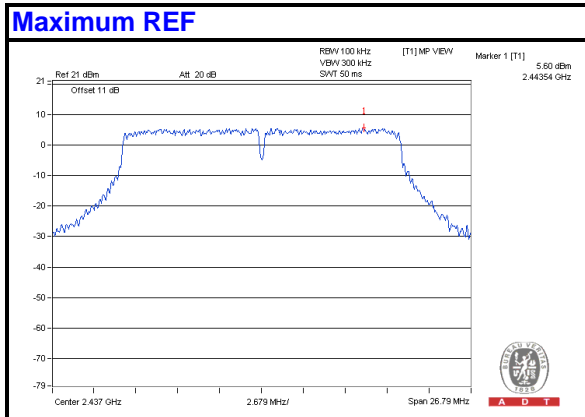

### Chain 0

#### CH 1

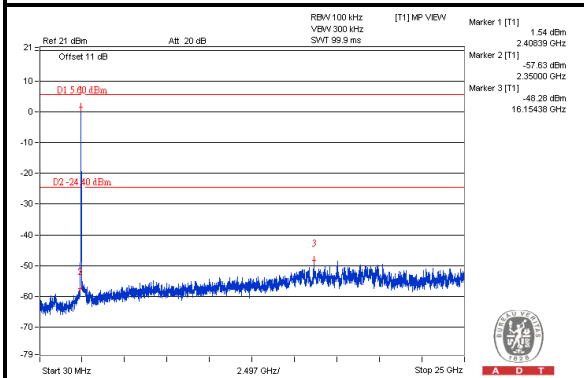

#### CH 6

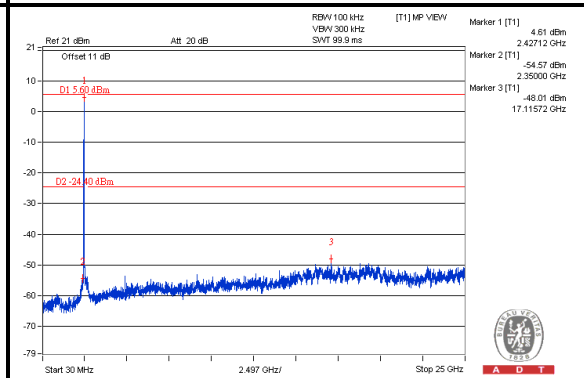

#### CH 11

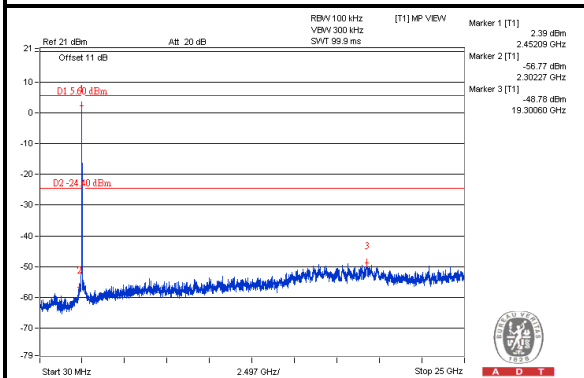

#### CH 11 Band edge

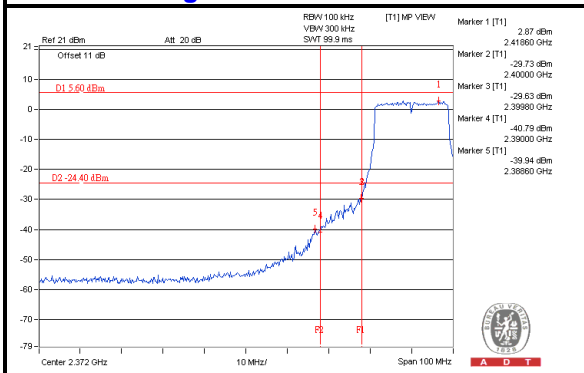

#### CH 11 Band edge

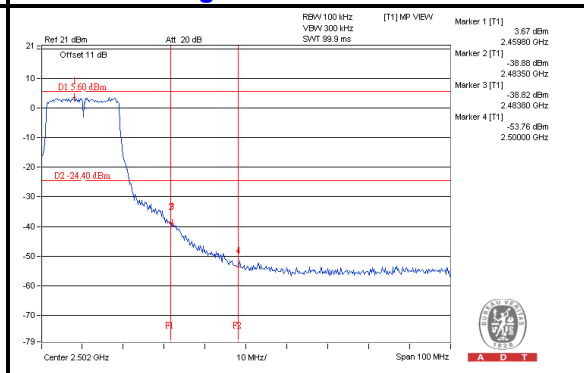





A D T

### Chain 1

#### CH 1

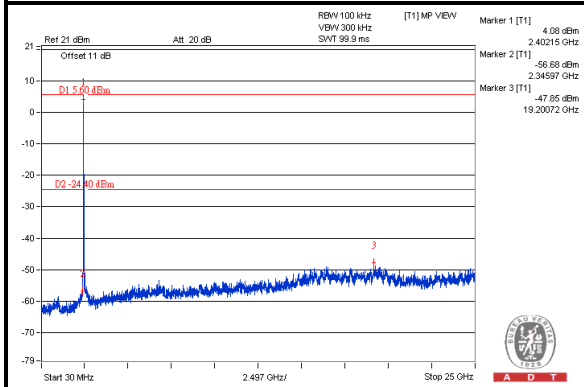

#### CH 6

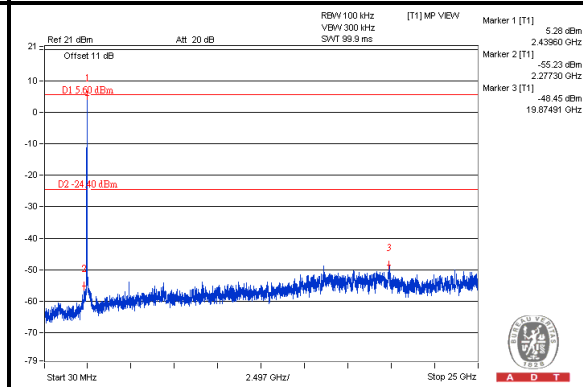

#### CH 11

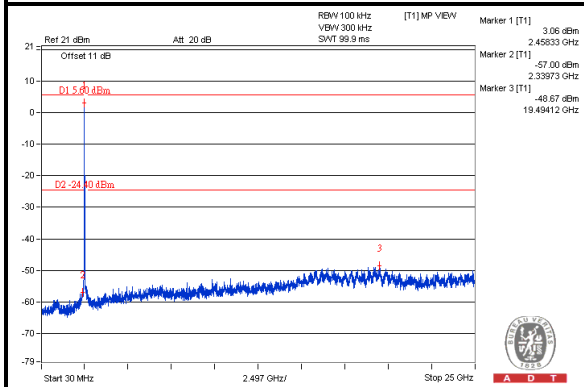

#### CH 1 Band edge

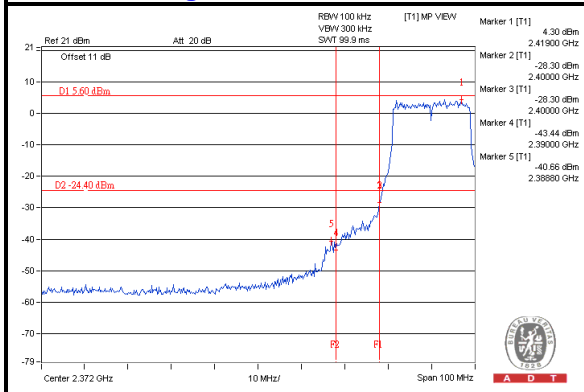

#### CH 11 Band edge

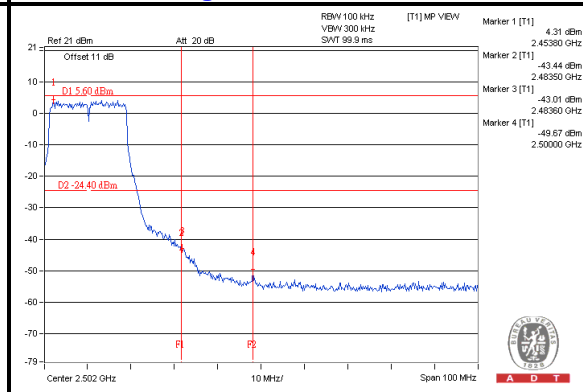



A D T

### 802.11n(HT40), 2Tx:

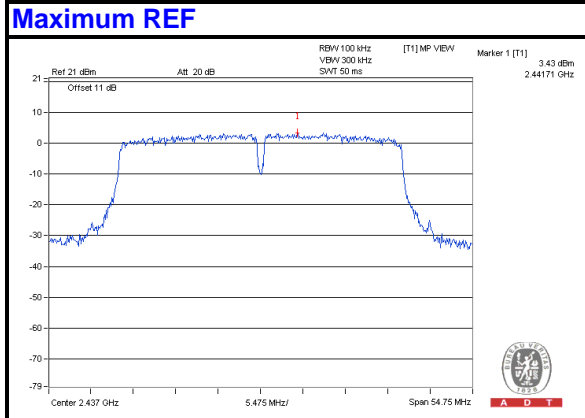

### Chain 0

#### CH 3

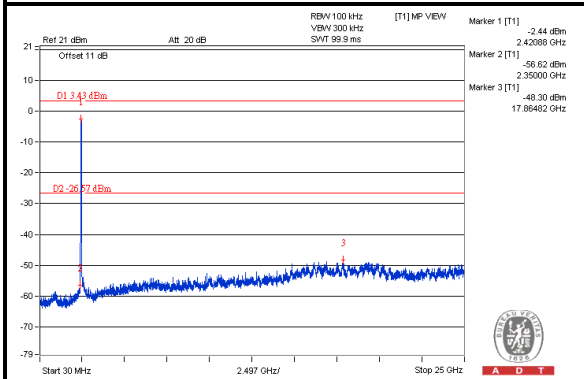

#### CH 6

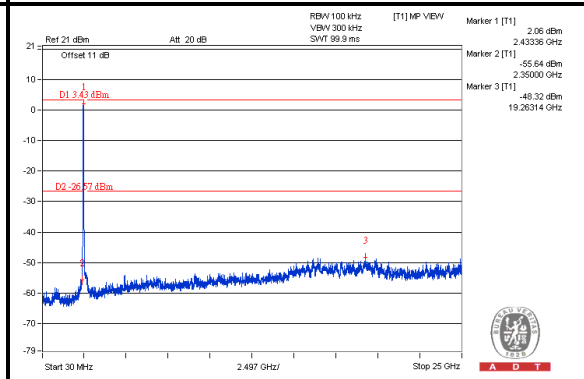

#### CH 9

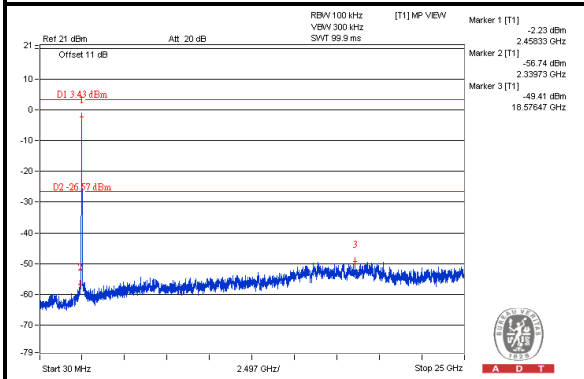

#### CH 3 Band edge

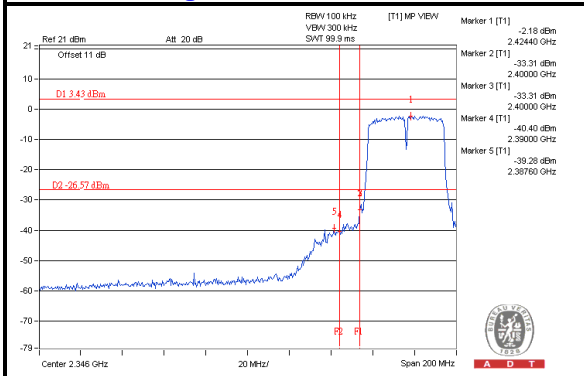

#### CH 9 Band edge

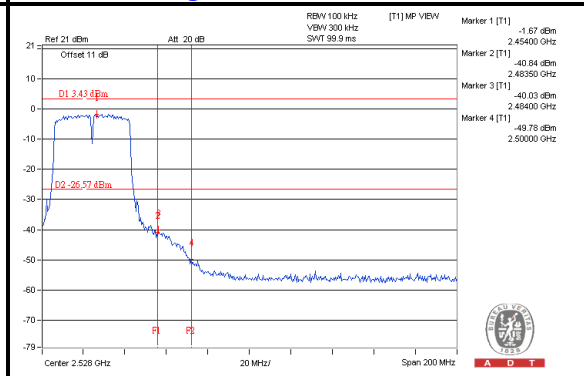



A D T

### Chain 1

#### CH 3

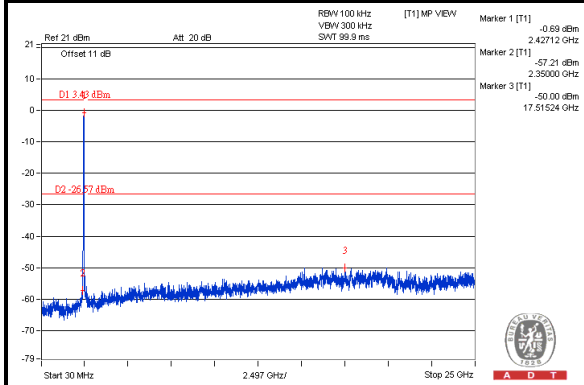

#### CH 6

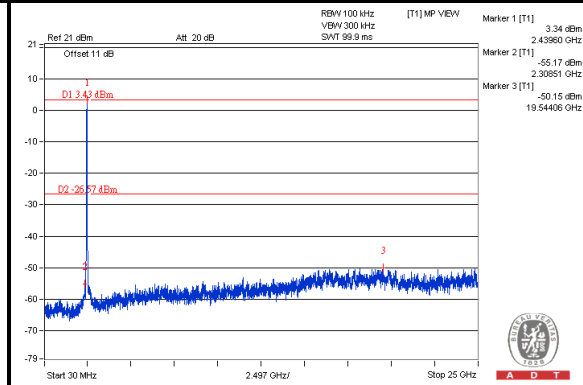

#### CH 9

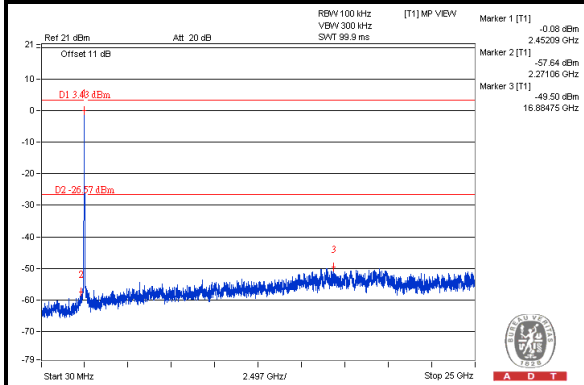

#### CH 3 Band edge

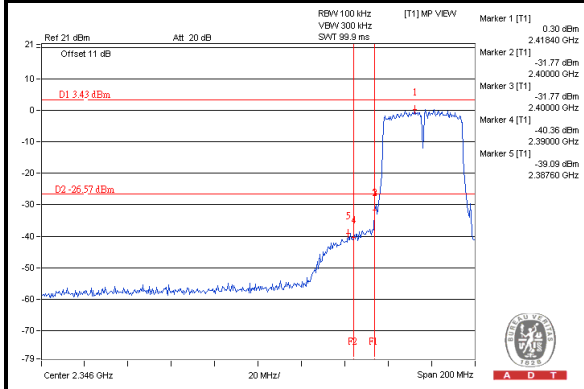

#### CH 9 Band edge

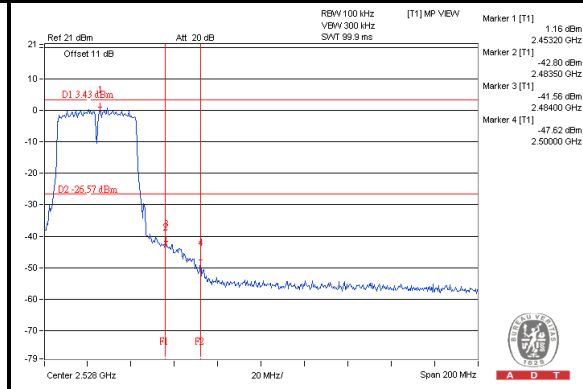



A D T

## 5. TEST TYPES AND RESULTS (FOR 5GHz, 5.725~5.850GHz Band)

### 5.1 CONDUCTED EMISSION MEASUREMENT

#### 5.1.1 LIMITS OF CONDUCTED EMISSION MEASUREMENT

FREQUENCY OF EMISSION (MHz)	CONDUCTED LIMIT (dB $\mu$ V)	
	Quasi-peak	Average
0.15-0.5	66 to 56	56 to 46
0.5-5	56	46
5-30	60	50

- NOTE:**
1. The lower limit shall apply at the transition frequencies.
  2. The limit decreases in line with the logarithm of the frequency in the range of 0.15 to 0.50 MHz.

#### 5.1.2 TEST INSTRUMENTS

DESCRIPTION & MANUFACTURER	MODEL NO.	SERIAL NO.	CALIBRATED DATE	CALIBRATED UNTIL
Line-Impedance Stabilization Network (for EUT) SCHWARZBECK	NSLK8127	8127-522	Sep. 05, 2013	Sep. 04, 2014
Line-Impedance Stabilization Network (for Peripheral)	ENV216	100072	June 06, 2013	June 05, 2014
RF Cable (JYEBAO)	5DFB	CONCAB-003	Mar. 07, 2014	Mar. 06, 2015
50 ohms Terminator	50	EMC-03	Sep. 24, 2013	Sep. 23, 2014
Software ADT	BV ADT_Cond_V7.3.7. 3	NA	NA	NA

**Note:**

1. The calibration interval of the above test instruments is 12 months and the calibrations are traceable to NML/ROC and NIST/USA.
2. The test was performed in Shielded Room No. C.
3. The VCCI Con C Registration No. is C-3611.
4. Tested Date: Apr. 17, 2014

### 5.1.3 TEST PROCEDURES

- a. The EUT was placed 0.4 meters from the conducting wall of the shielded room with EUT being connected to the power mains through a line impedance stabilization network (LISN). Other support units were connected to the power mains through another LISN.
- b. The two LISNs provide 50 ohm/ 50uH of coupling impedance for the measuring instrument.
- c. Both lines of the power mains connected to the EUT were checked for maximum conducted interference.
- d. The frequency range from 150kHz to 30MHz was searched. Emission levels under (Limit – 20dB) were not recorded.

**NOTE:**

- 1. The resolution bandwidth of test receiver is 9kHz for Quasi-peak detection (QP) & Average detection (AV).

### 5.1.4 DEVIATION FROM TEST STANDARD

No deviation

### 5.1.5 TEST SETUP

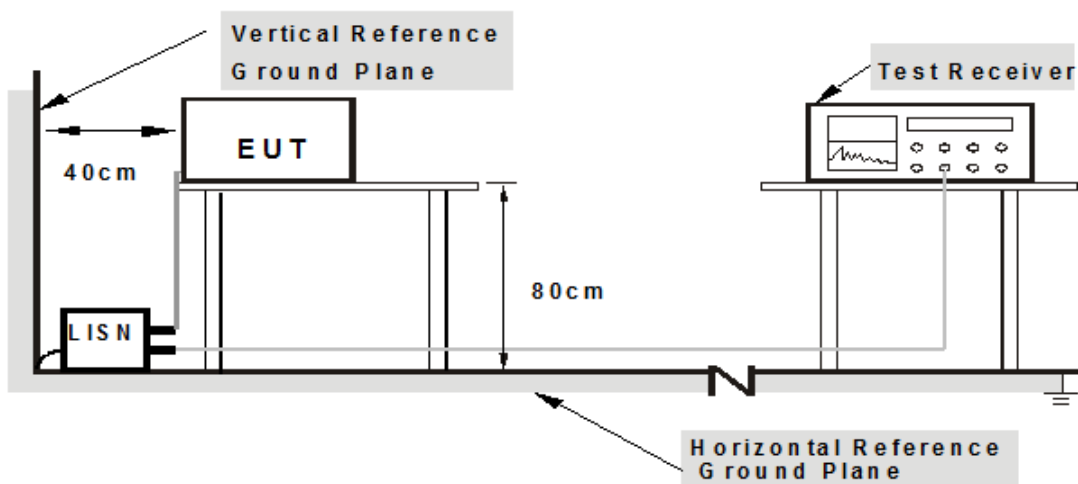

**Note: 1. Support units were connected to second LISN.**

For the actual test configuration, please refer to the related item – Photographs of the Test Configuration.

## 5.1.6 EUT OPERATING CONDITIONS

Same as the 4.1.6

### 5.1.7 TEST RESULTS

<b>PHASE</b>	Line (L)	<b>DETECTOR FUNCTION</b>	Quasi-Peak (QP) / Average (AV)
--------------	----------	--------------------------	--------------------------------

No	Freq.	Corr.	Reading Value		Emission Level		Limit		Margin	
	[MHz]	Factor (dB)	Q.P.	AV.	Q.P.	AV.	Q.P.	AV.	Q.P.	AV.
			[dB (uV)]	[dB (uV)]	[dB (uV)]	[dB (uV)]	[dB (uV)]	[dB (uV)]	(dB)	(dB)
1	0.15781	0.06	51.63	35.98	51.69	36.04	65.58	55.58	-13.89	-19.54
2	0.18516	0.06	45.78	30.79	45.84	30.85	64.25	54.25	-18.41	-23.40
3	0.28672	0.06	37.46	28.14	37.52	28.20	60.62	50.62	-23.09	-22.41
4	14.48438	0.52	31.37	25.58	31.89	26.10	60.00	50.00	-28.11	-23.90
5	20.32031	0.67	34.74	30.27	35.41	30.94	60.00	50.00	-24.59	-19.06
6	24.86328	0.81	33.92	29.38	34.73	30.19	60.00	50.00	-25.27	-19.81

#### REMARKS:

1. Q.P. and AV. are abbreviations of quasi-peak and average individually.
2. The emission levels of other frequencies were very low against the limit.
3. Margin value = Emission Level – Limit value
4. Correction Factor = Insertion loss + Cable loss
5. Emission Level = Correction Factor + Reading Value

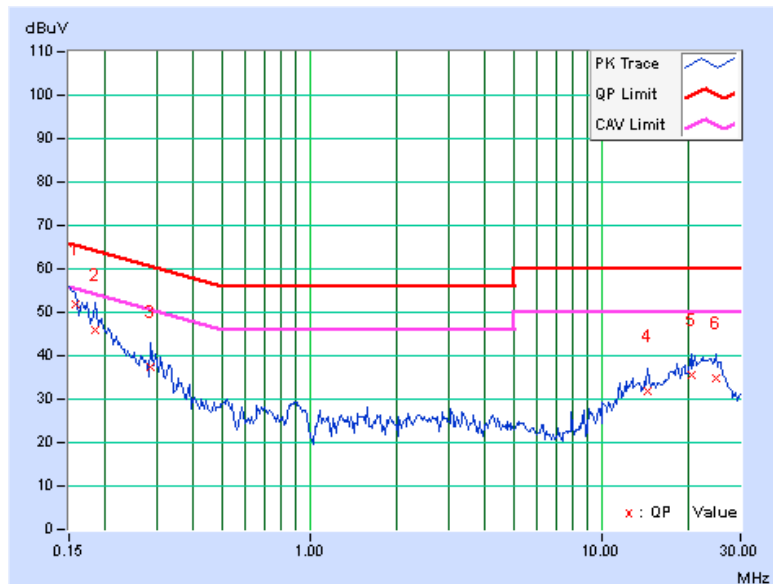

<b>PHASE</b>	Neutral (N)	<b>DETECTOR FUNCTION</b>	Quasi-Peak (QP) / Average (AV)
--------------	-------------	--------------------------	--------------------------------

No	Freq. [MHz]	Corr. Factor (dB)	Reading Value		Emission Level		Limit		Margin	
			[dB (uV)]		[dB (uV)]		[dB (uV)]		(dB)	
			Q.P.	AV.	Q.P.	AV.	Q.P.	AV.	Q.P.	AV.
1	0.15391	0.07	53.13	38.54	53.20	38.61	65.79	55.79	-12.59	-17.18
2	0.16562	0.07	50.41	35.34	50.48	35.41	65.18	55.18	-14.70	-19.77
3	0.20859	0.06	43.02	28.69	43.08	28.75	63.26	53.26	-20.18	-24.51
4	0.34922	0.07	30.48	19.12	30.55	19.19	58.98	48.98	-28.43	-29.79
5	12.76953	0.46	29.91	24.29	30.37	24.75	60.00	50.00	-29.63	-25.25
6	25.16406	0.80	34.14	29.35	34.94	30.15	60.00	50.00	-25.06	-19.85

**REMARKS:**

1. Q.P. and AV. are abbreviations of quasi-peak and average individually.
2. The emission levels of other frequencies were very low against the limit.
3. Margin value = Emission Level – Limit value
4. Correction Factor = Insertion loss + Cable loss
5. Emission Level = Correction Factor + Reading Value

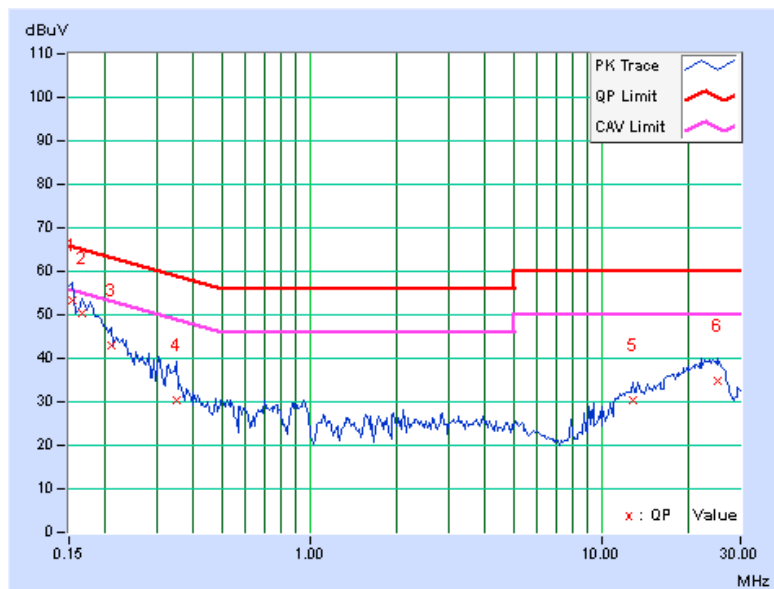





A D T

## 5.2 RADIATED AND BANDEDGE EMISSION MEASUREMENT

### 5.2.1 LIMITS OF RADIATED AND BANDEDGE EMISSION MEASUREMENT

Radiated emissions which fall in the restricted bands must comply with the radiated emission limits specified as below table. Other emissions shall be at least 30dB below the highest level of the desired power:

Frequencies (MHz)	Field strength (microvolts/meter)	Measurement distance (meters)
0.009-0.490	2400/F(kHz)	300
0.490-1.705	24000/F(kHz)	30
1.705-30.0	30	30
30-88	100	3
88-216	150	3
216-960	200	3
Above 960	500	3

**NOTE:**

1. The lower limit shall apply at the transition frequencies.
2. Emission level (dBuV/m) = 20 log Emission level (uV/m).
3. For frequencies above 1000MHz, the field strength limits are based on average detector, however, the peak field strength of any emission shall not exceed the maximum permitted average limits, specified above by more than 20dB under any condition of modulation.



A D T

## 5.2.2 TEST INSTRUMENTS

### For Below 1GHz test

DESCRIPTION & MANUFACTURER	MODEL NO.	SERIAL NO.	CALIBRATED DATE	CALIBRATED UNTIL
MXE EMI Receiver Agilent	N9038A	MY51210105	Jan. 21,2014	Jan. 20,2015
Pre-Amplifier Mini-Circuits	ZFL-1000VH2 B	AMP-ZFL-03	Nov. 13, 2013	Nov. 12, 2014
Trilog Broadband Antenna SCHWARZBECK	VULB 9168	9168-360	Feb. 26, 2014	Feb. 25, 2015
RF Cable	NA	CHGCAB_001	Oct. 05, 2013	Oct. 04, 2014
Spectrum Analyzer R&S	FSV40	100964	July 15, 2013	July 14, 2014
Horn_Antenna AISI	AIH.8018	0000320091110	Nov. 18, 2013	Nov. 17, 2014
Pre-Amplifier Agilent	8449B	3008A02578	June 25, 2013	June 24, 2014
RF Cable	NA	RF104-201 RF104-203 RF104-204	Dec. 12, 2013	Dec. 11, 2014
Spectrum Analyzer Agilent	E4446A	MY48250253	Aug. 28, 2013	Aug. 27, 2014
Pre-Amplifier SPACEK LABS	SLKKa-48-6	9K16	Nov. 13, 2013	Nov. 12, 2014
Horn_Antenna SCHWARZBECK	BBHA 9170	9170-424	Oct. 08, 2013	Oct. 07, 2014
Software	ADT_Radiated _V8.7.07	NA	NA	NA
Antenna Tower & Turn Table CT	NA	NA	NA	NA

#### Note:

1. The calibration interval of the above test instruments is 12 months and the calibrations are traceable to NML/ROC and NIST/USA.
2. The horn antenna, preamplifier (model: 8449B) are used only for the measurement of emission frequency above 1GHz if tested.
- 3 The test was performed in 966 Chamber No. G.
4. The FCC Site Registration No. is 966073.
- 5 The VCCI Site Registration No. is G-137.
- 6 The CANADA Site Registration No. is IC 7450H-2.
- 7 Tested Date: Apr. 11, 2014



A D T

**For Above 1GHz test**

DESCRIPTION & MANUFACTURER	MODEL NO.	SERIAL NO.	CALIBRATED DATE	CALIBRATED UNTIL
MXE EMI Receiver Agilent	N9038A	MY50010156	Jan. 15, 2014	Jan. 14, 2015
Pre-Amplifier Mini-Circuits	ZFL-1000VH2 B	AMP-ZFL-04	Nov. 13, 2013	Nov. 12, 2014
Trilog Broadband Antenna SCHWARZBECK	VULB 9168	9168-361	Feb. 27, 2014	Feb. 26, 2015
RF Cable	NA	CHHCAB_001	Oct. 06, 2013	Oct. 05, 2014
Spectrum Analyzer R&S	FSV40	100964	July 15, 2013	July 14, 2014
Horn_Antenna AISI	AIH.8018	0000220091110	Dec. 06, 2013	Dec. 05, 2014
Pre-Amplifier Agilent	8449B	3008A01923	Oct. 29, 2013	Oct. 28, 2014
RF Cable	NA	RF104-205 RF104-207 RF104-202	Dec. 12, 2013	Dec. 11, 2014
Spectrum Analyzer Agilent	E4446A	MY48250253	Aug. 28, 2013	Aug. 27, 2014
Pre-Amplifier SPACEK LABS	SLKKa-48-6	9K16	Nov. 13, 2013	Nov. 12, 2014
Horn_Antenna SCHWARZBECK	BBHA 9170	9170-424	Oct. 08, 2013	Oct. 07, 2014
Software	ADT_Radiated _V8.7.07	NA	NA	NA
Antenna Tower & Turn Table CT	NA	NA	NA	NA

**Note:**

1. The calibration interval of the above test instruments is 12 months and the calibrations are traceable to NML/ROC and NIST/USA.
2. The horn antenna, preamplifier (model: 8449B) are used only for the measurement of emission frequency above 1GHz if tested.
- 3 The test was performed in 966 Chamber No. H.
4. The FCC Site Registration No. is 797305.
- 5 The CANADA Site Registration No. is IC 7450H-3.
- 6 Tested Date: Apr. 16, 2014

### 5.2.3 TEST PROCEDURES

- a. The EUT was placed on the top of a rotating table 0.8 meters above the ground at 3 meter chamber room for test. The table was rotated 360 degrees to determine the position of the highest radiation.
- b. The EUT was set 3 meters away from the interference-receiving antenna, which was mounted on the top of a variable-height antenna tower.
- c. The height of antenna is varied from one meter to four meters above the ground to determine the maximum value of the field strength. Both horizontal and vertical polarizations of the antenna are set to make the measurement.
- d. For each suspected emission, the EUT was arranged to its worst case and then the antenna was tuned to heights from 1 meter to 4 meters and the rotatable table was turned from 0 degrees to 360 degrees to find the maximum reading.
- e. The test-receiver system was set to quasi-peak detect function and specified bandwidth with maximum hold mode when the test frequency is below 1 GHz.
- f. The test-receiver system was set to peak and average detect function and specified bandwidth with maximum hold mode when the test frequency is above 1 GHz. If the peak reading value also meets average limit, measurement with the average detector is unnecessary.

**Note:**

1. The resolution bandwidth and video bandwidth of test receiver/spectrum analyzer is 120kHz for Quasi-peak detection (QP) at frequency below 1GHz.
2. The resolution bandwidth of test receiver/spectrum analyzer is 1 MHz and the video bandwidth is 3 MHz for Peak detection (PK) at frequency above 1GHz.
3. The resolution bandwidth of test receiver/spectrum analyzer is 1MHz and the video bandwidth is 3MHz for RMS Average (Duty cycle < 98%) for Average detection (AV) at frequency above 1GHz, then the measurement results was added to a correction factor ( $10 \log(1/\text{duty cycle})$ ).
4. The resolution bandwidth of test receiver/spectrum analyzer is 1MHz and the video bandwidth is 10Hz (Duty cycle  $\geq 98\%$ ) for Average detection (AV) at frequency above 1GHz.
5. All modes of operation were investigated and the worst-case emissions are reported.

### 5.2.4 DEVIATION FROM TEST STANDARD

No deviation

## 5.2.5 TEST SETUP

### <Frequency Range below 1GHz>

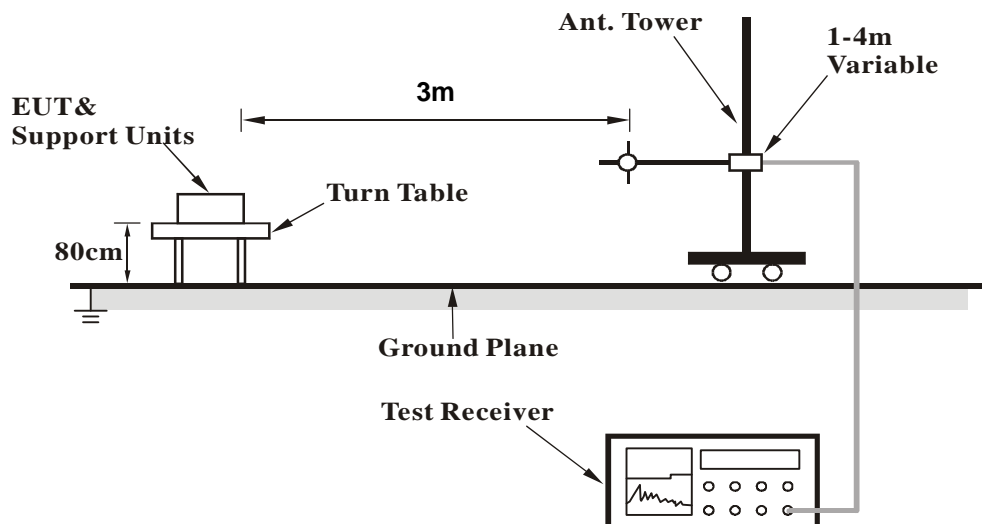

### <Frequency Range above 1GHz>

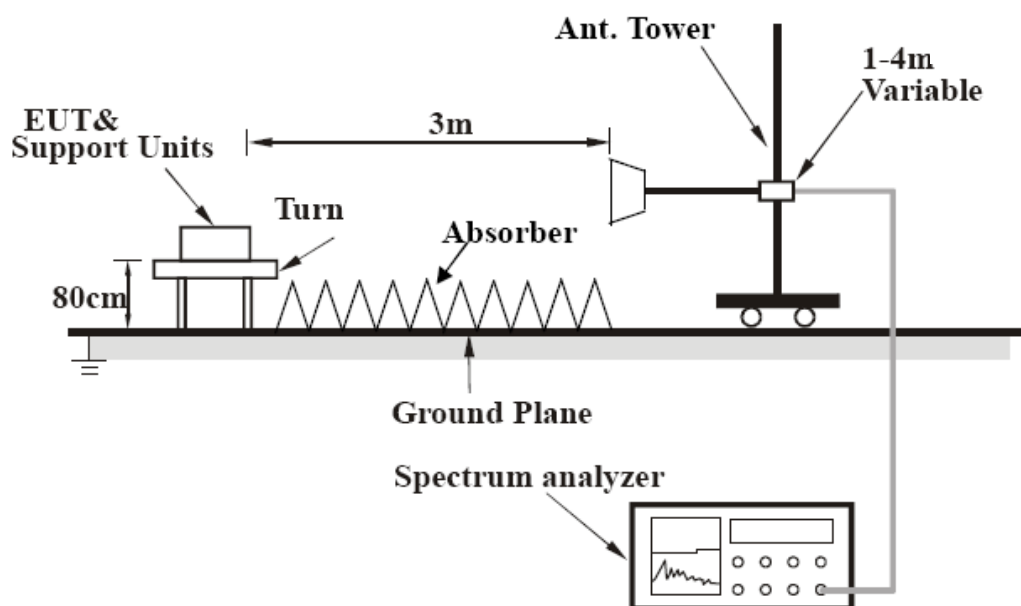

For the actual test configuration, please refer to the related item – Photographs of the Test Configuration.

## 5.2.6 EUT OPERATING CONDITIONS

Same as the 4.1.6



A D T

### 5.2.7 TEST RESULTS (MODE 1)

#### BELOW 1GHz WORST-CASE DATA

#### 802.11ac (VHT20), 2Tx

<b>CHANNEL</b>	TX Channel 157	<b>DETECTOR FUNCTION</b>	Quasi-Peak (QP)
<b>FREQUENCY RANGE</b>	Below 1GHz		

ANTENNA POLARITY & TEST DISTANCE: HORIZONTAL AT 3 M								
NO.	FREQ. (MHz)	EMISSION LEVEL (dBuV/m)	LIMIT (dBuV/m)	MARGIN (dB)	ANTENNA HEIGHT (m)	TABLE ANGLE (Degree)	RAW VALUE (dBuV)	CORRECTION FACTOR (dB/m)
1	86.85	32.1 QP	40.0	-7.9	2.00 H	82	51.14	-19.04
2	97.15	36.7 QP	43.5	-6.8	2.00 H	22	55.11	-18.41
3	125.01	40.0 QP	43.5	-3.5	2.00 H	327	54.90	-14.92
4	148.34	35.6 QP	43.5	-7.9	2.00 H	82	48.78	-13.15
5	250.00	40.5 QP	46.0	-5.5	1.00 H	70	54.82	-14.32
6	362.52	39.1 QP	46.0	-6.9	1.00 H	85	49.83	-10.73

ANTENNA POLARITY & TEST DISTANCE: VERTICAL AT 3 M								
NO.	FREQ. (MHz)	EMISSION LEVEL (dBuV/m)	LIMIT (dBuV/m)	MARGIN (dB)	ANTENNA HEIGHT (m)	TABLE ANGLE (Degree)	RAW VALUE (dBuV)	CORRECTION FACTOR (dB/m)
1	38.82	36.6 QP	40.0	-3.4	1.00 V	52	50.45	-13.85
2	43.59	35.3 QP	40.0	-4.7	1.00 V	72	48.79	-13.49
3	66.50	34.4 QP	40.0	-5.6	1.00 V	101	49.35	-14.99
4	80.32	36.2 QP	40.0	-3.9	1.00 V	101	54.40	-18.25
5	124.98	40.5 QP	43.5	-3.0	1.00 V	238	55.44	-14.92
6	440.02	38.3 QP	46.0	-7.7	1.00 V	18	46.74	-8.44

#### REMARKS:

1. Emission Level(dBuV/m) = Raw Value(dBuV) + Correction Factor(dB/m)
2. Correction Factor(dB/m) = Antenna Factor(dB/m) + Cable Factor(dB) – Pre-Amplifier Factor(dB)
3. The other emission levels were very low against the limit.
4. Margin value = Emission Level – Limit value



A D T

ABOVE 1GHz DATA

802.11a, 1Tx

<b>CHANNEL</b>	TX Channel 149	<b>DETECTOR FUNCTION</b>	Peak (PK)
<b>FREQUENCY RANGE</b>	1GHz ~ 40GHz		Average (AV)

ANTENNA POLARITY & TEST DISTANCE: HORIZONTAL AT 3 M								
NO.	FREQ. (MHz)	EMISSION LEVEL (dBuV/m)	LIMIT (dBuV/m)	MARGIN (dB)	ANTENNA HEIGHT (m)	TABLE ANGLE (Degree)	RAW VALUE (dBuV)	CORRECTION FACTOR (dB/m)
1	*5745.00	103.1 PK			1.68 H	22	98.20	4.90
2	*5745.00	94.4 AV			1.68 H	22	89.50	4.90
3	11490.00	57.0 PK	74.0	-17.0	1.10 H	17	46.40	10.60
4	11490.00	45.9 AV	54.0	-8.1	1.10 H	17	35.30	10.60

ANTENNA POLARITY & TEST DISTANCE: VERTICAL AT 3 M								
NO.	FREQ. (MHz)	EMISSION LEVEL (dBuV/m)	LIMIT (dBuV/m)	MARGIN (dB)	ANTENNA HEIGHT (m)	TABLE ANGLE (Degree)	RAW VALUE (dBuV)	CORRECTION FACTOR (dB/m)
1	*5745.00	108.9 PK			1.25 V	254	104.00	4.90
2	*5745.00	100.5 AV			1.25 V	254	95.60	4.90
3	11490.00	59.6 PK	74.0	-14.4	1.00 V	5	49.00	10.60
4	11490.00	48.2 AV	54.0	-5.8	1.00 V	5	37.60	10.60

REMARKS:

1. Emission Level(dBuV/m) = Raw Value(dBuV) + Correction Factor(dB/m)
2. Correction Factor(dB/m) = Antenna Factor(dB/m) + Cable Factor(dB) – Pre-Amplifier Factor(dB)
3. The other emission levels were very low against the limit.
4. Margin value = Emission Level – Limit value
5. " \* ": Fundamental frequency.
6. The limit value is defined as per 15.247.



A D T

<b>CHANNEL</b>	TX Channel 157	<b>DETECTOR FUNCTION</b>	Peak (PK)
<b>FREQUENCY RANGE</b>	1GHz ~ 40GHz		Average (AV)

**ANTENNA POLARITY & TEST DISTANCE: HORIZONTAL AT 3 M**

NO.	FREQ. (MHz)	EMISSION LEVEL (dBuV/m)	LIMIT (dBuV/m)	MARGIN (dB)	ANTENNA HEIGHT (m)	TABLE ANGLE (Degree)	RAW VALUE (dBuV)	CORRECTION FACTOR (dB/m)
1	*5785.00	102.8 PK			1.71 H	17	97.90	4.90
2	*5785.00	93.9 AV			1.71 H	17	89.00	4.90
3	11570.00	57.4 PK	74.0	-16.6	1.04 H	26	46.70	10.70
4	11570.00	46.3 AV	54.0	-7.7	1.04 H	26	35.60	10.70

**ANTENNA POLARITY & TEST DISTANCE: VERTICAL AT 3 M**

NO.	FREQ. (MHz)	EMISSION LEVEL (dBuV/m)	LIMIT (dBuV/m)	MARGIN (dB)	ANTENNA HEIGHT (m)	TABLE ANGLE (Degree)	RAW VALUE (dBuV)	CORRECTION FACTOR (dB/m)
1	*5785.00	107.8 PK			1.12 V	248	102.90	4.90
2	*5785.00	99.7 AV			1.12 V	248	94.80	4.90
3	11570.00	59.7 PK	74.0	-14.3	1.03 V	14	49.00	10.70
4	11570.00	48.4 AV	54.0	-5.6	1.03 V	14	37.70	10.70

**REMARKS:**

1. Emission Level(dBuV/m) = Raw Value(dBuV) + Correction Factor(dB/m)
2. Correction Factor(dB/m) = Antenna Factor(dB/m) + Cable Factor(dB) – Pre-Amplifier Factor(dB)
3. The other emission levels were very low against the limit.
4. Margin value = Emission Level – Limit value
5. " \* ": Fundamental frequency.
6. The limit value is defined as per 15.247.





A D T

<b>CHANNEL</b>	TX Channel 165	<b>DETECTOR FUNCTION</b>	Peak (PK)
<b>FREQUENCY RANGE</b>	1GHz ~ 40GHz		Average (AV)

**ANTENNA POLARITY & TEST DISTANCE: HORIZONTAL AT 3 M**

NO.	FREQ. (MHz)	EMISSION LEVEL (dBuV/m)	LIMIT (dBuV/m)	MARGIN (dB)	ANTENNA HEIGHT (m)	TABLE ANGLE (Degree)	RAW VALUE (dBuV)	CORRECTION FACTOR (dB/m)
1	*5825.00	103.1 PK			1.71 H	28	98.00	5.10
2	*5825.00	95.4 AV			1.71 H	28	90.30	5.10
3	11650.00	56.9 PK	74.0	-17.1	1.00 H	26	46.30	10.60
4	11650.00	45.6 AV	54.0	-8.4	1.00 H	26	35.00	10.60

**ANTENNA POLARITY & TEST DISTANCE: VERTICAL AT 3 M**

NO.	FREQ. (MHz)	EMISSION LEVEL (dBuV/m)	LIMIT (dBuV/m)	MARGIN (dB)	ANTENNA HEIGHT (m)	TABLE ANGLE (Degree)	RAW VALUE (dBuV)	CORRECTION FACTOR (dB/m)
1	*5825.00	108.6 PK			1.10 V	250	103.50	5.10
2	*5825.00	101.6 AV			1.10 V	250	96.50	5.10
3	11650.00	60.1 PK	74.0	-13.9	1.00 V	6	49.50	10.60
4	11650.00	48.4 AV	54.0	-5.6	1.00 V	6	37.80	10.60

**REMARKS:**

1. Emission Level(dBuV/m) = Raw Value(dBuV) + Correction Factor(dB/m)
2. Correction Factor(dB/m) = Antenna Factor(dB/m) + Cable Factor(dB) – Pre-Amplifier Factor(dB)
3. The other emission levels were very low against the limit.
4. Margin value = Emission Level – Limit value
5. " \* ": Fundamental frequency.
6. The limit value is defined as per 15.247.



A D T

802.11ac (VHT20), 1Tx

<b>CHANNEL</b>	TX Channel 149	<b>DETECTOR FUNCTION</b>	Peak (PK)
<b>FREQUENCY RANGE</b>	1GHz ~ 40GHz		Average (AV)

**ANTENNA POLARITY & TEST DISTANCE: HORIZONTAL AT 3 M**

NO.	FREQ. (MHz)	EMISSION LEVEL (dBuV/m)	LIMIT (dBuV/m)	MARGIN (dB)	ANTENNA HEIGHT (m)	TABLE ANGLE (Degree)	RAW VALUE (dBuV)	CORRECTION FACTOR (dB/m)
1	*5745.00	103.5 PK			1.64 H	32	98.60	4.90
2	*5745.00	94.7 AV			1.64 H	32	89.80	4.90
3	11490.00	56.0 PK	74.0	-18.0	1.00 H	24	45.40	10.60
4	11490.00	44.6 AV	54.0	-9.4	1.00 H	24	34.00	10.60

**ANTENNA POLARITY & TEST DISTANCE: VERTICAL AT 3 M**

NO.	FREQ. (MHz)	EMISSION LEVEL (dBuV/m)	LIMIT (dBuV/m)	MARGIN (dB)	ANTENNA HEIGHT (m)	TABLE ANGLE (Degree)	RAW VALUE (dBuV)	CORRECTION FACTOR (dB/m)
1	*5745.00	108.8 PK			1.31 V	233	103.90	4.90
2	*5745.00	100.4 AV			1.31 V	233	95.50	4.90
3	11490.00	60.6 PK	74.0	-13.4	1.00 V	20	50.00	10.60
4	11490.00	48.8 AV	54.0	-5.2	1.00 V	20	38.20	10.60

**REMARKS:**

1. Emission Level(dBuV/m) = Raw Value(dBuV) + Correction Factor(dB/m)
2. Correction Factor(dB/m) = Antenna Factor(dB/m) + Cable Factor(dB) – Pre-Amplifier Factor(dB)
3. The other emission levels were very low against the limit.
4. Margin value = Emission Level – Limit value
5. " \* ": Fundamental frequency.
6. The limit value is defined as per 15.247.



A D T

<b>CHANNEL</b>	TX Channel 157	<b>DETECTOR FUNCTION</b>	Peak (PK)
<b>FREQUENCY RANGE</b>	1GHz ~ 40GHz		Average (AV)

**ANTENNA POLARITY & TEST DISTANCE: HORIZONTAL AT 3 M**

NO.	FREQ. (MHz)	EMISSION LEVEL (dBuV/m)	LIMIT (dBuV/m)	MARGIN (dB)	ANTENNA HEIGHT (m)	TABLE ANGLE (Degree)	RAW VALUE (dBuV)	CORRECTION FACTOR (dB/m)
1	*5785.00	103.2 PK			1.62 H	33	98.30	4.90
2	*5785.00	94.3 AV			1.62 H	33	89.40	4.90
3	11570.00	56.2 PK	74.0	-17.8	1.02 H	16	45.50	10.70
4	11570.00	44.8 AV	54.0	-9.2	1.02 H	16	34.10	10.70

**ANTENNA POLARITY & TEST DISTANCE: VERTICAL AT 3 M**

NO.	FREQ. (MHz)	EMISSION LEVEL (dBuV/m)	LIMIT (dBuV/m)	MARGIN (dB)	ANTENNA HEIGHT (m)	TABLE ANGLE (Degree)	RAW VALUE (dBuV)	CORRECTION FACTOR (dB/m)
1	*5785.00	107.3 PK			1.03 V	258	102.40	4.90
2	*5785.00	99.5 AV			1.03 V	258	94.60	4.90
3	11570.00	59.5 PK	74.0	-14.5	1.07 V	25	48.80	10.70
4	11570.00	48.0 AV	54.0	-6.0	1.07 V	25	37.30	10.70

**REMARKS:**

1. Emission Level(dBuV/m) = Raw Value(dBuV) + Correction Factor(dB/m)
2. Correction Factor(dB/m) = Antenna Factor(dB/m) + Cable Factor(dB) – Pre-Amplifier Factor(dB)
3. The other emission levels were very low against the limit.
4. Margin value = Emission Level – Limit value
5. " \* ": Fundamental frequency.
6. The limit value is defined as per 15.247.



A D T

<b>CHANNEL</b>	TX Channel 165	<b>DETECTOR FUNCTION</b>	Peak (PK)
<b>FREQUENCY RANGE</b>	1GHz ~ 40GHz		Average (AV)

**ANTENNA POLARITY & TEST DISTANCE: HORIZONTAL AT 3 M**

NO.	FREQ. (MHz)	EMISSION LEVEL (dBuV/m)	LIMIT (dBuV/m)	MARGIN (dB)	ANTENNA HEIGHT (m)	TABLE ANGLE (Degree)	RAW VALUE (dBuV)	CORRECTION FACTOR (dB/m)
1	*5825.00	103.2 PK			1.70 H	28	98.10	5.10
2	*5825.00	95.3 AV			1.70 H	28	90.20	5.10
3	11650.00	56.2 PK	74.0	-17.8	1.02 H	21	45.60	10.60
4	11650.00	44.8 AV	54.0	-9.2	1.02 H	21	34.20	10.60

**ANTENNA POLARITY & TEST DISTANCE: VERTICAL AT 3 M**

NO.	FREQ. (MHz)	EMISSION LEVEL (dBuV/m)	LIMIT (dBuV/m)	MARGIN (dB)	ANTENNA HEIGHT (m)	TABLE ANGLE (Degree)	RAW VALUE (dBuV)	CORRECTION FACTOR (dB/m)
1	*5825.00	108.5 PK			1.00 V	225	103.40	5.10
2	*5825.00	101.2 AV			1.00 V	225	96.10	5.10
3	11650.00	60.3 PK	74.0	-13.7	1.02 V	24	49.70	10.60
4	11650.00	48.3 AV	54.0	-5.7	1.02 V	24	37.70	10.60

**REMARKS:**

1. Emission Level(dBuV/m) = Raw Value(dBuV) + Correction Factor(dB/m)
2. Correction Factor(dB/m) = Antenna Factor(dB/m) + Cable Factor(dB) – Pre-Amplifier Factor(dB)
3. The other emission levels were very low against the limit.
4. Margin value = Emission Level – Limit value
5. " \* ": Fundamental frequency.
6. The limit value is defined as per 15.247.



A D T

802.11ac (VHT40), 1Tx

<b>CHANNEL</b>	TX Channel 151	<b>DETECTOR FUNCTION</b>	Peak (PK)
<b>FREQUENCY RANGE</b>	1GHz ~ 40GHz		Average (AV)

**ANTENNA POLARITY & TEST DISTANCE: HORIZONTAL AT 3 M**

NO.	FREQ. (MHz)	EMISSION LEVEL (dBuV/m)	LIMIT (dBuV/m)	MARGIN (dB)	ANTENNA HEIGHT (m)	TABLE ANGLE (Degree)	RAW VALUE (dBuV)	CORRECTION FACTOR (dB/m)
1	*5755.00	100.4 PK			1.65 H	16	95.50	4.90
2	*5755.00	91.5 AV			1.65 H	16	86.60	4.90
3	11510.00	55.9 PK	74.0	-18.1	1.00 H	19	45.20	10.70
4	11510.00	44.7 AV	54.0	-9.3	1.00 H	19	34.00	10.70

**ANTENNA POLARITY & TEST DISTANCE: VERTICAL AT 3 M**

NO.	FREQ. (MHz)	EMISSION LEVEL (dBuV/m)	LIMIT (dBuV/m)	MARGIN (dB)	ANTENNA HEIGHT (m)	TABLE ANGLE (Degree)	RAW VALUE (dBuV)	CORRECTION FACTOR (dB/m)
1	*5755.00	105.7 PK			1.00 V	223	100.80	4.90
2	*5755.00	97.3 AV			1.00 V	223	92.40	4.90
3	11510.00	59.0 PK	74.0	-15.0	1.13 V	21	48.30	10.70
4	11510.00	47.7 AV	54.0	-6.3	1.13 V	21	37.00	10.70

**REMARKS:**

1. Emission Level(dBuV/m) = Raw Value(dBuV) + Correction Factor(dB/m)
2. Correction Factor(dB/m) = Antenna Factor(dB/m) + Cable Factor(dB) – Pre-Amplifier Factor(dB)
3. The other emission levels were very low against the limit.
4. Margin value = Emission Level – Limit value
5. " \* ": Fundamental frequency.
6. The limit value is defined as per 15.247.



A D T

<b>CHANNEL</b>	TX Channel 159	<b>DETECTOR FUNCTION</b>	Peak (PK)
<b>FREQUENCY RANGE</b>	1GHz ~ 40GHz		Average (AV)

**ANTENNA POLARITY & TEST DISTANCE: HORIZONTAL AT 3 M**

NO.	FREQ. (MHz)	EMISSION LEVEL (dBuV/m)	LIMIT (dBuV/m)	MARGIN (dB)	ANTENNA HEIGHT (m)	TABLE ANGLE (Degree)	RAW VALUE (dBuV)	CORRECTION FACTOR (dB/m)
1	*5795.00	99.5 PK			1.60 H	27	94.70	4.80
2	*5795.00	90.7 AV			1.60 H	27	85.90	4.80
3	11590.00	55.7 PK	74.0	-18.3	1.04 H	18	45.00	10.70
4	11590.00	44.3 AV	54.0	-9.7	1.04 H	18	33.60	10.70

**ANTENNA POLARITY & TEST DISTANCE: VERTICAL AT 3 M**

NO.	FREQ. (MHz)	EMISSION LEVEL (dBuV/m)	LIMIT (dBuV/m)	MARGIN (dB)	ANTENNA HEIGHT (m)	TABLE ANGLE (Degree)	RAW VALUE (dBuV)	CORRECTION FACTOR (dB/m)
1	*5795.00	105.3 PK			1.02 V	227	100.50	4.80
2	*5795.00	97.0 AV			1.02 V	227	92.20	4.80
3	11590.00	59.2 PK	74.0	-14.8	1.10 V	17	48.50	10.70
4	11590.00	47.7 AV	54.0	-6.3	1.10 V	17	37.00	10.70

**REMARKS:**

1. Emission Level(dBuV/m) = Raw Value(dBuV) + Correction Factor(dB/m)
2. Correction Factor(dB/m) = Antenna Factor(dB/m) + Cable Factor(dB) – Pre-Amplifier Factor(dB)
3. The other emission levels were very low against the limit.
4. Margin value = Emission Level – Limit value
5. " \* ": Fundamental frequency.
6. The limit value is defined as per 15.247.



A D T

802.11ac (VHT80), 1Tx

<b>CHANNEL</b>	TX Channel 155	<b>DETECTOR FUNCTION</b>	Peak (PK)
<b>FREQUENCY RANGE</b>	1GHz ~ 40GHz		Average (AV)

**ANTENNA POLARITY & TEST DISTANCE: HORIZONTAL AT 3 M**

NO.	FREQ. (MHz)	EMISSION LEVEL (dBuV/m)	LIMIT (dBuV/m)	MARGIN (dB)	ANTENNA HEIGHT (m)	TABLE ANGLE (Degree)	RAW VALUE (dBuV)	CORRECTION FACTOR (dB/m)
1	*5775.00	98.6 PK			1.54 H	2	93.70	4.90
2	*5775.00	89.6 AV			1.54 H	2	84.70	4.90
3	11550.00	55.2 PK	74.0	-18.8	1.04 H	13	44.50	10.70
4	11550.00	43.9 AV	54.0	-10.1	1.04 H	13	33.20	10.70

**ANTENNA POLARITY & TEST DISTANCE: VERTICAL AT 3 M**

NO.	FREQ. (MHz)	EMISSION LEVEL (dBuV/m)	LIMIT (dBuV/m)	MARGIN (dB)	ANTENNA HEIGHT (m)	TABLE ANGLE (Degree)	RAW VALUE (dBuV)	CORRECTION FACTOR (dB/m)
1	*5775.00	103.2 PK			1.24 V	249	98.30	4.90
2	*5775.00	95.7 AV			1.24 V	249	90.80	4.90
3	11550.00	59.6 PK	74.0	-14.4	1.15 V	22	48.90	10.70
4	11550.00	48.1 AV	54.0	-5.9	1.15 V	22	37.40	10.70

**REMARKS:**

1. Emission Level(dBuV/m) = Raw Value(dBuV) + Correction Factor(dB/m)
2. Correction Factor(dB/m) = Antenna Factor(dB/m) + Cable Factor(dB) – Pre-Amplifier Factor(dB)
3. The other emission levels were very low against the limit.
4. Margin value = Emission Level – Limit value
5. " \* ": Fundamental frequency.
6. The limit value is defined as per 15.247.



A D T

### 802.11ac (VHT20), 2Tx

<b>CHANNEL</b>	TX Channel 149	<b>DETECTOR FUNCTION</b>	Peak (PK)
<b>FREQUENCY RANGE</b>	1GHz ~ 40GHz		Average (AV)

ANTENNA POLARITY & TEST DISTANCE: HORIZONTAL AT 3 M								
NO.	FREQ. (MHz)	EMISSION LEVEL (dBuV/m)	LIMIT (dBuV/m)	MARGIN (dB)	ANTENNA HEIGHT (m)	TABLE ANGLE (Degree)	RAW VALUE (dBuV)	CORRECTION FACTOR (dB/m)
1	*5745.00	99.9 PK			1.60 H	30	95.00	4.90
2	*5745.00	90.6 AV			1.60 H	30	85.70	4.90
3	11490.00	55.6 PK	74.0	-18.4	1.00 H	254	45.00	10.60
4	11490.00	42.1 AV	54.0	-11.9	1.00 H	254	31.50	10.60
ANTENNA POLARITY & TEST DISTANCE: VERTICAL AT 3 M								
NO.	FREQ. (MHz)	EMISSION LEVEL (dBuV/m)	LIMIT (dBuV/m)	MARGIN (dB)	ANTENNA HEIGHT (m)	TABLE ANGLE (Degree)	RAW VALUE (dBuV)	CORRECTION FACTOR (dB/m)
1	*5745.00	107.2 PK			1.00 V	348	102.30	4.90
2	*5745.00	98.2 AV			1.00 V	348	93.30	4.90
3	11490.00	56.4 PK	74.0	-17.6	1.58 V	87	45.80	10.60
4	11490.00	45.5 AV	54.0	-8.5	1.58 V	87	34.90	10.60

#### REMARKS:

1. Emission Level(dBuV/m) = Raw Value(dBuV) + Correction Factor(dB/m)
2. Correction Factor(dB/m) = Antenna Factor(dB/m) + Cable Factor(dB) – Pre-Amplifier Factor(dB)
3. The other emission levels were very low against the limit.
4. Margin value = Emission Level – Limit value
5. " \* " : Fundamental frequency.
6. The limit value is defined as per 15.247.





A D T

<b>CHANNEL</b>	TX Channel 157	<b>DETECTOR FUNCTION</b>	Peak (PK)
<b>FREQUENCY RANGE</b>	1GHz ~ 40GHz		Average (AV)

**ANTENNA POLARITY & TEST DISTANCE: HORIZONTAL AT 3 M**

NO.	FREQ. (MHz)	EMISSION LEVEL (dBuV/m)	LIMIT (dBuV/m)	MARGIN (dB)	ANTENNA HEIGHT (m)	TABLE ANGLE (Degree)	RAW VALUE (dBuV)	CORRECTION FACTOR (dB/m)
1	*5785.00	100.1 PK			1.56 H	26	95.20	4.90
2	*5785.00	90.4 AV			1.56 H	26	85.50	4.90
3	11570.00	55.6 PK	74.0	-18.4	1.00 H	250	44.90	10.70
4	11570.00	42.0 AV	54.0	-12.0	1.00 H	250	31.30	10.70

**ANTENNA POLARITY & TEST DISTANCE: VERTICAL AT 3 M**

NO.	FREQ. (MHz)	EMISSION LEVEL (dBuV/m)	LIMIT (dBuV/m)	MARGIN (dB)	ANTENNA HEIGHT (m)	TABLE ANGLE (Degree)	RAW VALUE (dBuV)	CORRECTION FACTOR (dB/m)
1	*5785.00	107.2 PK			1.06 V	342	102.30	4.90
2	*5785.00	98.1 AV			1.06 V	342	93.20	4.90
3	11570.00	56.7 PK	74.0	-17.3	1.61 V	84	46.00	10.70
4	11570.00	45.6 AV	54.0	-8.4	1.61 V	84	34.90	10.70

**REMARKS:**

1. Emission Level(dBuV/m) = Raw Value(dBuV) + Correction Factor(dB/m)
2. Correction Factor(dB/m) = Antenna Factor(dB/m) + Cable Factor(dB) – Pre-Amplifier Factor(dB)
3. The other emission levels were very low against the limit.
4. Margin value = Emission Level – Limit value
5. " \* ": Fundamental frequency.
6. The limit value is defined as per 15.247.



A D T

<b>CHANNEL</b>	TX Channel 165	<b>DETECTOR FUNCTION</b>	Peak (PK)
<b>FREQUENCY RANGE</b>	1GHz ~ 40GHz		Average (AV)

**ANTENNA POLARITY & TEST DISTANCE: HORIZONTAL AT 3 M**

NO.	FREQ. (MHz)	EMISSION LEVEL (dBuV/m)	LIMIT (dBuV/m)	MARGIN (dB)	ANTENNA HEIGHT (m)	TABLE ANGLE (Degree)	RAW VALUE (dBuV)	CORRECTION FACTOR (dB/m)
1	*5825.00	100.2 PK			1.58 H	40	95.10	5.10
2	*5825.00	91.0 AV			1.58 H	40	85.90	5.10
3	11650.00	55.2 PK	74.0	-18.8	1.05 H	261	44.60	10.60
4	11650.00	41.6 AV	54.0	-12.4	1.05 H	261	31.00	10.60

**ANTENNA POLARITY & TEST DISTANCE: VERTICAL AT 3 M**

NO.	FREQ. (MHz)	EMISSION LEVEL (dBuV/m)	LIMIT (dBuV/m)	MARGIN (dB)	ANTENNA HEIGHT (m)	TABLE ANGLE (Degree)	RAW VALUE (dBuV)	CORRECTION FACTOR (dB/m)
1	*5825.00	107.5 PK			1.06 V	356	102.40	5.10
2	*5825.00	98.5 AV			1.06 V	356	93.40	5.10
3	11650.00	56.7 PK	74.0	-17.3	1.61 V	95	46.10	10.60
4	11650.00	45.7 AV	54.0	-8.3	1.61 V	95	35.10	10.60

**REMARKS:**

1. Emission Level(dBuV/m) = Raw Value(dBuV) + Correction Factor(dB/m)
2. Correction Factor(dB/m) = Antenna Factor(dB/m) + Cable Factor(dB) – Pre-Amplifier Factor(dB)
3. The other emission levels were very low against the limit.
4. Margin value = Emission Level – Limit value
5. " \* ": Fundamental frequency.
6. The limit value is defined as per 15.247.



A D T

802.11ac (VHT40), 2Tx

<b>CHANNEL</b>	TX Channel 151	<b>DETECTOR FUNCTION</b>	Peak (PK)
<b>FREQUENCY RANGE</b>	1GHz ~ 40GHz		Average (AV)

**ANTENNA POLARITY & TEST DISTANCE: HORIZONTAL AT 3 M**

NO.	FREQ. (MHz)	EMISSION LEVEL (dBuV/m)	LIMIT (dBuV/m)	MARGIN (dB)	ANTENNA HEIGHT (m)	TABLE ANGLE (Degree)	RAW VALUE (dBuV)	CORRECTION FACTOR (dB/m)
1	*5755.00	96.8 PK			1.58 H	50	91.90	4.90
2	*5755.00	87.7 AV			1.58 H	50	82.80	4.90
3	11510.00	54.8 PK	74.0	-19.2	1.09 H	247	44.10	10.70
4	11510.00	41.4 AV	54.0	-12.6	1.09 H	247	30.70	10.70

**ANTENNA POLARITY & TEST DISTANCE: VERTICAL AT 3 M**

NO.	FREQ. (MHz)	EMISSION LEVEL (dBuV/m)	LIMIT (dBuV/m)	MARGIN (dB)	ANTENNA HEIGHT (m)	TABLE ANGLE (Degree)	RAW VALUE (dBuV)	CORRECTION FACTOR (dB/m)
1	*5755.00	104.3 PK			1.00 V	348	99.40	4.90
2	*5755.00	95.3 AV			1.00 V	348	90.40	4.90
3	11510.00	57.0 PK	74.0	-17.0	1.56 V	103	46.30	10.70
4	11510.00	45.9 AV	54.0	-8.1	1.56 V	103	35.20	10.70

**REMARKS:**

1. Emission Level(dBuV/m) = Raw Value(dBuV) + Correction Factor(dB/m)
2. Correction Factor(dB/m) = Antenna Factor(dB/m) + Cable Factor(dB) – Pre-Amplifier Factor(dB)
3. The other emission levels were very low against the limit.
4. Margin value = Emission Level – Limit value
5. " \* " : Fundamental frequency.
6. The limit value is defined as per 15.247.



A D T

<b>CHANNEL</b>	TX Channel 159	<b>DETECTOR FUNCTION</b>	Peak (PK)
<b>FREQUENCY RANGE</b>	1GHz ~ 40GHz		Average (AV)

**ANTENNA POLARITY & TEST DISTANCE: HORIZONTAL AT 3 M**

NO.	FREQ. (MHz)	EMISSION LEVEL (dBuV/m)	LIMIT (dBuV/m)	MARGIN (dB)	ANTENNA HEIGHT (m)	TABLE ANGLE (Degree)	RAW VALUE (dBuV)	CORRECTION FACTOR (dB/m)
1	*5795.00	97.3 PK			1.64 H	40	92.50	4.80
2	*5795.00	88.2 AV			1.64 H	40	83.40	4.80
3	11590.00	54.2 PK	74.0	-19.8	1.11 H	248	43.50	10.70
4	11590.00	41.1 AV	54.0	-12.9	1.11 H	248	30.40	10.70

**ANTENNA POLARITY & TEST DISTANCE: VERTICAL AT 3 M**

NO.	FREQ. (MHz)	EMISSION LEVEL (dBuV/m)	LIMIT (dBuV/m)	MARGIN (dB)	ANTENNA HEIGHT (m)	TABLE ANGLE (Degree)	RAW VALUE (dBuV)	CORRECTION FACTOR (dB/m)
1	*5795.00	104.7 PK			1.03 V	345	99.90	4.80
2	*5795.00	95.7 AV			1.03 V	345	90.90	4.80
3	11590.00	56.6 PK	74.0	-17.4	1.61 V	100	45.90	10.70
4	11590.00	45.8 AV	54.0	-8.2	1.61 V	100	35.10	10.70

**REMARKS:**

1. Emission Level(dBuV/m) = Raw Value(dBuV) + Correction Factor(dB/m)
2. Correction Factor(dB/m) = Antenna Factor(dB/m) + Cable Factor(dB) – Pre-Amplifier Factor(dB)
3. The other emission levels were very low against the limit.
4. Margin value = Emission Level – Limit value
5. " \* ": Fundamental frequency.
6. The limit value is defined as per 15.247.



A D T

802.11ac (VHT80), 2Tx

<b>CHANNEL</b>	TX Channel 155	<b>DETECTOR FUNCTION</b>	Peak (PK)
<b>FREQUENCY RANGE</b>	1GHz ~ 40GHz		Average (AV)

**ANTENNA POLARITY & TEST DISTANCE: HORIZONTAL AT 3 M**

NO.	FREQ. (MHz)	EMISSION LEVEL (dBuV/m)	LIMIT (dBuV/m)	MARGIN (dB)	ANTENNA HEIGHT (m)	TABLE ANGLE (Degree)	RAW VALUE (dBuV)	CORRECTION FACTOR (dB/m)
1	*5775.00	98.7 PK			1.61 H	43	93.80	4.90
2	*5775.00	88.6 AV			1.61 H	43	83.70	4.90
3	11550.00	53.8 PK	74.0	-20.2	1.11 H	233	43.10	10.70
4	11550.00	40.6 AV	54.0	-13.4	1.11 H	233	29.90	10.70

**ANTENNA POLARITY & TEST DISTANCE: VERTICAL AT 3 M**

NO.	FREQ. (MHz)	EMISSION LEVEL (dBuV/m)	LIMIT (dBuV/m)	MARGIN (dB)	ANTENNA HEIGHT (m)	TABLE ANGLE (Degree)	RAW VALUE (dBuV)	CORRECTION FACTOR (dB/m)
1	*5775.00	103.3 PK			1.00 V	345	98.40	4.90
2	*5775.00	96.1 AV			1.00 V	345	91.20	4.90
3	11550.00	56.3 PK	74.0	-17.7	1.64 V	99	45.60	10.70
4	11550.00	45.5 AV	54.0	-8.5	1.64 V	99	34.80	10.70

**REMARKS:**

1. Emission Level(dBuV/m) = Raw Value(dBuV) + Correction Factor(dB/m)
2. Correction Factor(dB/m) = Antenna Factor(dB/m) + Cable Factor(dB) – Pre-Amplifier Factor(dB)
3. The other emission levels were very low against the limit.
4. Margin value = Emission Level – Limit value
5. " \* " : Fundamental frequency.
6. The limit value is defined as per 15.247.



A D T

### 5.2.8 TEST RESULTS (MODE 2)

#### BELOW 1GHz WORST-CASE DATA

#### 802.11ac (VHT20), 2Tx

<b>CHANNEL</b>	TX Channel 157	<b>DETECTOR FUNCTION</b>	Quasi-Peak (QP)
<b>FREQUENCY RANGE</b>	Below 1GHz		

#### ANTENNA POLARITY & TEST DISTANCE: HORIZONTAL AT 3 M

NO.	FREQ. (MHz)	EMISSION LEVEL (dBuV/m)	LIMIT (dBuV/m)	MARGIN (dB)	ANTENNA HEIGHT (m)	TABLE ANGLE (Degree)	RAW VALUE (dBuV)	CORRECTION FACTOR (dB/m)
1	110.82	33.7 QP	43.5	-9.8	1.50 H	75	49.97	-16.25
2	125.02	40.3 QP	43.5	-3.2	2.00 H	284	55.22	-14.92
3	160.47	35.1 QP	43.5	-8.4	2.00 H	284	48.28	-13.18
4	174.25	36.0 QP	43.5	-7.6	1.50 H	77	50.06	-14.11
5	250.00	40.4 QP	46.0	-5.6	1.21 H	256	54.72	-14.32
6	362.52	41.9 QP	46.0	-4.2	1.00 H	325	52.58	-10.73

#### ANTENNA POLARITY & TEST DISTANCE: VERTICAL AT 3 M

NO.	FREQ. (MHz)	EMISSION LEVEL (dBuV/m)	LIMIT (dBuV/m)	MARGIN (dB)	ANTENNA HEIGHT (m)	TABLE ANGLE (Degree)	RAW VALUE (dBuV)	CORRECTION FACTOR (dB/m)
1	39.52	36.5 QP	40.0	-3.5	1.00 V	360	50.30	-13.80
2	71.08	34.3 QP	40.0	-5.8	1.00 V	219	50.03	-15.78
3	124.98	41.7 QP	43.5	-1.8	1.00 V	332	56.64	-14.92
4	250.00	42.0 QP	46.0	-4.0	2.00 V	330	56.31	-14.32
5	362.53	42.5 QP	46.0	-3.5	1.50 V	358	53.27	-10.73
6	875.02	42.3 QP	46.0	-3.7	1.00 V	323	42.77	-0.45

#### REMARKS:

1. Emission Level(dBuV/m) = Raw Value(dBuV) + Correction Factor(dB/m)
2. Correction Factor(dB/m) = Antenna Factor(dB/m) + Cable Factor(dB) – Pre-Amplifier Factor(dB)
3. The other emission levels were very low against the limit.
4. Margin value = Emission Level – Limit value



A D T

TX\_High

ABOVE 1GHz DATA

802.11a, 1Tx

<b>CHANNEL</b>	TX Channel 149	<b>DETECTOR FUNCTION</b>	Peak (PK)
<b>FREQUENCY RANGE</b>	1GHz ~ 40GHz		Average (AV)

ANTENNA POLARITY & TEST DISTANCE: HORIZONTAL AT 3 M								
NO.	FREQ. (MHz)	EMISSION LEVEL (dBuV/m)	LIMIT (dBuV/m)	MARGIN (dB)	ANTENNA HEIGHT (m)	TABLE ANGLE (Degree)	RAW VALUE (dBuV)	CORRECTION FACTOR (dB/m)
1	*5745.00	109.8 PK			1.16 H	182	104.90	4.90
2	*5745.00	101.0 AV			1.16 H	182	96.10	4.90
3	11490.00	67.4 PK	74.0	-6.6	1.05 H	192	56.80	10.60
4	11490.00	53.5 AV	54.0	-0.5	1.05 H	192	42.90	10.60

ANTENNA POLARITY & TEST DISTANCE: VERTICAL AT 3 M								
NO.	FREQ. (MHz)	EMISSION LEVEL (dBuV/m)	LIMIT (dBuV/m)	MARGIN (dB)	ANTENNA HEIGHT (m)	TABLE ANGLE (Degree)	RAW VALUE (dBuV)	CORRECTION FACTOR (dB/m)
1	*5745.00	119.3 PK			1.31 V	184	114.40	4.90
2	*5745.00	110.5 AV			1.31 V	184	105.60	4.90
3	11490.00	65.2 PK	74.0	-8.8	1.13 V	191	54.60	10.60
4	11490.00	51.7 AV	54.0	-2.3	1.13 V	191	41.10	10.60

**REMARKS:**

1. Emission Level(dBuV/m) = Raw Value(dBuV) + Correction Factor(dB/m)
2. Correction Factor(dB/m) = Antenna Factor(dB/m) + Cable Factor(dB) – Pre-Amplifier Factor(dB)
3. The other emission levels were very low against the limit.
4. Margin value = Emission Level – Limit value
5. " \* ": Fundamental frequency.
6. The limit value is defined as per 15.247.



A D T

<b>CHANNEL</b>	TX Channel 157	<b>DETECTOR FUNCTION</b>	Peak (PK)
<b>FREQUENCY RANGE</b>	1GHz ~ 40GHz		Average (AV)

**ANTENNA POLARITY & TEST DISTANCE: HORIZONTAL AT 3 M**

NO.	FREQ. (MHz)	EMISSION LEVEL (dBuV/m)	LIMIT (dBuV/m)	MARGIN (dB)	ANTENNA HEIGHT (m)	TABLE ANGLE (Degree)	RAW VALUE (dBuV)	CORRECTION FACTOR (dB/m)
1	*5785.00	110.1 PK			1.34 H	186	105.20	4.90
2	*5785.00	101.4 AV			1.34 H	186	96.50	4.90
3	11570.00	65.1 PK	74.0	-8.9	1.14 H	212	54.40	10.70
4	11570.00	53.3 AV	54.0	-0.7	1.14 H	212	42.60	10.70

**ANTENNA POLARITY & TEST DISTANCE: VERTICAL AT 3 M**

NO.	FREQ. (MHz)	EMISSION LEVEL (dBuV/m)	LIMIT (dBuV/m)	MARGIN (dB)	ANTENNA HEIGHT (m)	TABLE ANGLE (Degree)	RAW VALUE (dBuV)	CORRECTION FACTOR (dB/m)
1	*5785.00	119.8 PK			1.29 V	183	114.90	4.90
2	*5785.00	111.5 AV			1.29 V	183	106.60	4.90
3	11570.00	49.7 PK	74.0	-24.3	1.22 V	161	39.00	10.70
4	11570.00	49.5 AV	54.0	-4.5	1.22 V	161	38.80	10.70

**REMARKS:**

1. Emission Level(dBuV/m) = Raw Value(dBuV) + Correction Factor(dB/m)
2. Correction Factor(dB/m) = Antenna Factor(dB/m) + Cable Factor(dB) – Pre-Amplifier Factor(dB)
3. The other emission levels were very low against the limit.
4. Margin value = Emission Level – Limit value
5. " \* ": Fundamental frequency.
6. The limit value is defined as per 15.247.





A D T

<b>CHANNEL</b>	TX Channel 165	<b>DETECTOR FUNCTION</b>	Peak (PK)
<b>FREQUENCY RANGE</b>	1GHz ~ 40GHz		Average (AV)

**ANTENNA POLARITY & TEST DISTANCE: HORIZONTAL AT 3 M**

NO.	FREQ. (MHz)	EMISSION LEVEL (dBuV/m)	LIMIT (dBuV/m)	MARGIN (dB)	ANTENNA HEIGHT (m)	TABLE ANGLE (Degree)	RAW VALUE (dBuV)	CORRECTION FACTOR (dB/m)
1	5460.00	51.8 PK	74.0	-22.2	1.12 H	199	47.20	4.60
2	5460.00	39.2 AV	54.0	-14.8	1.12 H	199	34.60	4.60
3	*5825.00	110.7 PK			1.12 H	199	105.60	5.10
4	*5825.00	102.1 AV			1.12 H	199	97.00	5.10
5	11650.00	66.6 PK	74.0	-7.4	1.00 H	207	56.00	10.60
6	<b>11650.00</b>	<b>53.5 AV</b>	<b>54.0</b>	<b>-0.5</b>	<b>1.00 H</b>	<b>207</b>	<b>42.90</b>	<b>10.60</b>

**ANTENNA POLARITY & TEST DISTANCE: VERTICAL AT 3 M**

NO.	FREQ. (MHz)	EMISSION LEVEL (dBuV/m)	LIMIT (dBuV/m)	MARGIN (dB)	ANTENNA HEIGHT (m)	TABLE ANGLE (Degree)	RAW VALUE (dBuV)	CORRECTION FACTOR (dB/m)
1	5460.00	54.4 PK	74.0	-19.6	1.28 V	180	49.80	4.60
2	5460.00	42.1 AV	54.0	-11.9	1.28 V	180	37.50	4.60
3	*5825.00	119.1 PK			1.28 V	180	114.00	5.10
4	*5825.00	110.9 AV			1.28 V	180	105.80	5.10
5	11650.00	49.6 PK	74.0	-24.4	1.22 V	161	39.00	10.60
6	11650.00	49.6 AV	54.0	-4.4	1.22 V	161	39.00	10.60

**REMARKS:**

1. Emission Level(dBuV/m) = Raw Value(dBuV) + Correction Factor(dB/m)
2. Correction Factor(dB/m) = Antenna Factor(dB/m) + Cable Factor(dB) – Pre-Amplifier Factor(dB)
3. The other emission levels were very low against the limit.
4. Margin value = Emission Level – Limit value
5. " \* ": Fundamental frequency.
6. The limit value is defined as per 15.247.



A D T

802.11ac (VHT20), 1Tx

<b>CHANNEL</b>	TX Channel 149	<b>DETECTOR FUNCTION</b>	Peak (PK)
<b>FREQUENCY RANGE</b>	1GHz ~ 40GHz		Average (AV)

**ANTENNA POLARITY & TEST DISTANCE: HORIZONTAL AT 3 M**

NO.	FREQ. (MHz)	EMISSION LEVEL (dBuV/m)	LIMIT (dBuV/m)	MARGIN (dB)	ANTENNA HEIGHT (m)	TABLE ANGLE (Degree)	RAW VALUE (dBuV)	CORRECTION FACTOR (dB/m)
1	*5745.00	111.0 PK			1.29 H	350	106.10	4.90
2	*5745.00	101.6 AV			1.29 H	350	96.70	4.90
3	11490.00	59.8 PK	74.0	-14.2	1.17 H	1	49.20	10.60
4	11490.00	46.6 AV	54.0	-7.4	1.17 H	1	36.00	10.60

**ANTENNA POLARITY & TEST DISTANCE: VERTICAL AT 3 M**

NO.	FREQ. (MHz)	EMISSION LEVEL (dBuV/m)	LIMIT (dBuV/m)	MARGIN (dB)	ANTENNA HEIGHT (m)	TABLE ANGLE (Degree)	RAW VALUE (dBuV)	CORRECTION FACTOR (dB/m)
1	*5745.00	119.8 PK			1.24 V	16	114.90	4.90
2	*5745.00	110.5 AV			1.24 V	16	105.60	4.90
3	11490.00	59.5 PK	74.0	-14.5	1.00 V	4	48.90	10.60
4	11490.00	45.7 AV	54.0	-8.3	1.00 V	4	35.10	10.60

**REMARKS:**

1. Emission Level(dBuV/m) = Raw Value(dBuV) + Correction Factor(dB/m)
2. Correction Factor(dB/m) = Antenna Factor(dB/m) + Cable Factor(dB) – Pre-Amplifier Factor(dB)
3. The other emission levels were very low against the limit.
4. Margin value = Emission Level – Limit value
5. " \* ": Fundamental frequency.
6. The limit value is defined as per 15.247.



A D T

<b>CHANNEL</b>	TX Channel 157	<b>DETECTOR FUNCTION</b>	Peak (PK)
<b>FREQUENCY RANGE</b>	1GHz ~ 40GHz		Average (AV)

**ANTENNA POLARITY & TEST DISTANCE: HORIZONTAL AT 3 M**

NO.	FREQ. (MHz)	EMISSION LEVEL (dBuV/m)	LIMIT (dBuV/m)	MARGIN (dB)	ANTENNA HEIGHT (m)	TABLE ANGLE (Degree)	RAW VALUE (dBuV)	CORRECTION FACTOR (dB/m)
1	*5785.00	110.6 PK			1.23 H	353	105.70	4.90
2	*5785.00	101.2 AV			1.23 H	353	96.30	4.90
3	11570.00	59.9 PK	74.0	-14.1	1.21 H	3	49.20	10.70
4	11570.00	47.0 AV	54.0	-7.0	1.21 H	3	36.30	10.70

**ANTENNA POLARITY & TEST DISTANCE: VERTICAL AT 3 M**

NO.	FREQ. (MHz)	EMISSION LEVEL (dBuV/m)	LIMIT (dBuV/m)	MARGIN (dB)	ANTENNA HEIGHT (m)	TABLE ANGLE (Degree)	RAW VALUE (dBuV)	CORRECTION FACTOR (dB/m)
1	*5785.00	120.0 PK			1.22 V	16	115.10	4.90
2	*5785.00	110.5 AV			1.22 V	16	105.60	4.90
3	11570.00	59.3 PK	74.0	-14.7	1.03 V	8	48.60	10.70
4	11570.00	45.6 AV	54.0	-8.4	1.03 V	8	34.90	10.70

**REMARKS:**

1. Emission Level(dBuV/m) = Raw Value(dBuV) + Correction Factor(dB/m)
2. Correction Factor(dB/m) = Antenna Factor(dB/m) + Cable Factor(dB) – Pre-Amplifier Factor(dB)
3. The other emission levels were very low against the limit.
4. Margin value = Emission Level – Limit value
5. " \* ": Fundamental frequency.
6. The limit value is defined as per 15.247.



A D T

<b>CHANNEL</b>	TX Channel 165	<b>DETECTOR FUNCTION</b>	Peak (PK)
<b>FREQUENCY RANGE</b>	1GHz ~ 40GHz		Average (AV)

**ANTENNA POLARITY & TEST DISTANCE: HORIZONTAL AT 3 M**

NO.	FREQ. (MHz)	EMISSION LEVEL (dBuV/m)	LIMIT (dBuV/m)	MARGIN (dB)	ANTENNA HEIGHT (m)	TABLE ANGLE (Degree)	RAW VALUE (dBuV)	CORRECTION FACTOR (dB/m)
1	*5825.00	109.6 PK			1.26 H	347	104.50	5.10
2	*5825.00	100.6 AV			1.26 H	347	95.50	5.10
3	11650.00	62.5 PK	74.0	-11.5	1.14 H	0	51.90	10.60
4	11650.00	49.4 AV	54.0	-4.6	1.14 H	0	38.80	10.60

**ANTENNA POLARITY & TEST DISTANCE: VERTICAL AT 3 M**

NO.	FREQ. (MHz)	EMISSION LEVEL (dBuV/m)	LIMIT (dBuV/m)	MARGIN (dB)	ANTENNA HEIGHT (m)	TABLE ANGLE (Degree)	RAW VALUE (dBuV)	CORRECTION FACTOR (dB/m)
1	*5825.00	120.2 PK			1.22 V	17	115.10	5.10
2	*5825.00	111.2 AV			1.22 V	17	106.10	5.10
3	11650.00	58.8 PK	74.0	-15.2	1.03 V	17	48.20	10.60
4	11650.00	44.8 AV	54.0	-9.2	1.03 V	17	34.20	10.60

**REMARKS:**

1. Emission Level(dBuV/m) = Raw Value(dBuV) + Correction Factor(dB/m)
2. Correction Factor(dB/m) = Antenna Factor(dB/m) + Cable Factor(dB) – Pre-Amplifier Factor(dB)
3. The other emission levels were very low against the limit.
4. Margin value = Emission Level – Limit value
5. " \* ": Fundamental frequency.
6. The limit value is defined as per 15.247.



A D T

802.11ac (VHT40), 1Tx

<b>CHANNEL</b>	TX Channel 151	<b>DETECTOR FUNCTION</b>	Peak (PK)
<b>FREQUENCY RANGE</b>	1GHz ~ 40GHz		Average (AV)

**ANTENNA POLARITY & TEST DISTANCE: HORIZONTAL AT 3 M**

NO.	FREQ. (MHz)	EMISSION LEVEL (dBuV/m)	LIMIT (dBuV/m)	MARGIN (dB)	ANTENNA HEIGHT (m)	TABLE ANGLE (Degree)	RAW VALUE (dBuV)	CORRECTION FACTOR (dB/m)
1	*5755.00	107.2 PK			1.17 H	341	102.30	4.90
2	*5755.00	97.2 AV			1.17 H	341	92.30	4.90
3	11510.00	62.8 PK	74.0	-11.2	1.12 H	12	52.10	10.70
4	11510.00	49.9 AV	54.0	-4.1	1.12 H	12	39.20	10.70

**ANTENNA POLARITY & TEST DISTANCE: VERTICAL AT 3 M**

NO.	FREQ. (MHz)	EMISSION LEVEL (dBuV/m)	LIMIT (dBuV/m)	MARGIN (dB)	ANTENNA HEIGHT (m)	TABLE ANGLE (Degree)	RAW VALUE (dBuV)	CORRECTION FACTOR (dB/m)
1	*5755.00	117.5 PK			1.24 V	11	112.60	4.90
2	*5755.00	107.5 AV			1.24 V	11	102.60	4.90
3	11510.00	58.7 PK	74.0	-15.3	1.00 V	3	48.00	10.70
4	11510.00	45.2 AV	54.0	-8.8	1.00 V	3	34.50	10.70

**REMARKS:**

1. Emission Level(dBuV/m) = Raw Value(dBuV) + Correction Factor(dB/m)
2. Correction Factor(dB/m) = Antenna Factor(dB/m) + Cable Factor(dB) – Pre-Amplifier Factor(dB)
3. The other emission levels were very low against the limit.
4. Margin value = Emission Level – Limit value
5. " \* ": Fundamental frequency.
6. The limit value is defined as per 15.247.



A D T

<b>CHANNEL</b>	TX Channel 159	<b>DETECTOR FUNCTION</b>	Peak (PK)
<b>FREQUENCY RANGE</b>	1GHz ~ 40GHz		Average (AV)

**ANTENNA POLARITY & TEST DISTANCE: HORIZONTAL AT 3 M**

NO.	FREQ. (MHz)	EMISSION LEVEL (dBuV/m)	LIMIT (dBuV/m)	MARGIN (dB)	ANTENNA HEIGHT (m)	TABLE ANGLE (Degree)	RAW VALUE (dBuV)	CORRECTION FACTOR (dB/m)
1	*5795.00	107.6 PK			1.15 H	355	102.80	4.80
2	*5795.00	98.1 AV			1.15 H	355	93.30	4.80
3	11590.00	63.4 PK	74.0	-10.6	1.08 H	4	52.70	10.70
4	11590.00	50.4 AV	54.0	-3.6	1.08 H	4	39.70	10.70

**ANTENNA POLARITY & TEST DISTANCE: VERTICAL AT 3 M**

NO.	FREQ. (MHz)	EMISSION LEVEL (dBuV/m)	LIMIT (dBuV/m)	MARGIN (dB)	ANTENNA HEIGHT (m)	TABLE ANGLE (Degree)	RAW VALUE (dBuV)	CORRECTION FACTOR (dB/m)
1	*5795.00	117.3 PK			1.22 V	14	112.50	4.80
2	*5795.00	108.0 AV			1.22 V	14	103.20	4.80
3	11590.00	58.7 PK	74.0	-15.3	1.00 V	16	48.00	10.70
4	11590.00	45.3 AV	54.0	-8.7	1.00 V	16	34.60	10.70

**REMARKS:**

1. Emission Level(dBuV/m) = Raw Value(dBuV) + Correction Factor(dB/m)
2. Correction Factor(dB/m) = Antenna Factor(dB/m) + Cable Factor(dB) – Pre-Amplifier Factor(dB)
3. The other emission levels were very low against the limit.
4. Margin value = Emission Level – Limit value
5. " \* ": Fundamental frequency.
6. The limit value is defined as per 15.247.



A D T

802.11ac (VHT80), 1Tx

<b>CHANNEL</b>	TX Channel 155	<b>DETECTOR FUNCTION</b>	Peak (PK)
<b>FREQUENCY RANGE</b>	1GHz ~ 40GHz		Average (AV)

**ANTENNA POLARITY & TEST DISTANCE: HORIZONTAL AT 3 M**

NO.	FREQ. (MHz)	EMISSION LEVEL (dBuV/m)	LIMIT (dBuV/m)	MARGIN (dB)	ANTENNA HEIGHT (m)	TABLE ANGLE (Degree)	RAW VALUE (dBuV)	CORRECTION FACTOR (dB/m)
1	*5775.00	105.3 PK			1.15 H	347	100.40	4.90
2	*5775.00	96.2 AV			1.15 H	347	91.30	4.90
3	11550.00	63.4 PK	74.0	-10.6	1.02 H	12	52.70	10.70
4	11550.00	50.6 AV	54.0	-3.4	1.02 H	12	39.90	10.70

**ANTENNA POLARITY & TEST DISTANCE: VERTICAL AT 3 M**

NO.	FREQ. (MHz)	EMISSION LEVEL (dBuV/m)	LIMIT (dBuV/m)	MARGIN (dB)	ANTENNA HEIGHT (m)	TABLE ANGLE (Degree)	RAW VALUE (dBuV)	CORRECTION FACTOR (dB/m)
1	*5775.00	115.5 PK			1.23 V	8	110.60	4.90
2	*5775.00	106.1 AV			1.23 V	8	101.20	4.90
3	11550.00	58.6 PK	74.0	-15.4	1.00 V	14	47.90	10.70
4	11550.00	45.5 AV	54.0	-8.5	1.00 V	14	34.80	10.70

**REMARKS:**

1. Emission Level(dBuV/m) = Raw Value(dBuV) + Correction Factor(dB/m)
2. Correction Factor(dB/m) = Antenna Factor(dB/m) + Cable Factor(dB) – Pre-Amplifier Factor(dB)
3. The other emission levels were very low against the limit.
4. Margin value = Emission Level – Limit value
5. " \* ": Fundamental frequency.
6. The limit value is defined as per 15.247.



A D T

802.11ac (VHT20), 2Tx

<b>CHANNEL</b>	TX Channel 149	<b>DETECTOR FUNCTION</b>	Peak (PK)
<b>FREQUENCY RANGE</b>	1GHz ~ 40GHz		Average (AV)

**ANTENNA POLARITY & TEST DISTANCE: HORIZONTAL AT 3 M**

NO.	FREQ. (MHz)	EMISSION LEVEL (dBuV/m)	LIMIT (dBuV/m)	MARGIN (dB)	ANTENNA HEIGHT (m)	TABLE ANGLE (Degree)	RAW VALUE (dBuV)	CORRECTION FACTOR (dB/m)
1	*5745.00	117.0 PK			1.10 H	190	112.10	4.90
2	*5745.00	106.2 AV			1.10 H	190	101.30	4.90
3	11490.00	57.2 PK	74.0	-16.8	1.38 H	191	46.60	10.60
4	11490.00	44.5 AV	54.0	-9.5	1.38 H	191	33.90	10.60

**ANTENNA POLARITY & TEST DISTANCE: VERTICAL AT 3 M**

NO.	FREQ. (MHz)	EMISSION LEVEL (dBuV/m)	LIMIT (dBuV/m)	MARGIN (dB)	ANTENNA HEIGHT (m)	TABLE ANGLE (Degree)	RAW VALUE (dBuV)	CORRECTION FACTOR (dB/m)
1	*5745.00	118.8 PK			1.12 V	185	113.90	4.90
2	*5745.00	109.6 AV			1.12 V	185	104.70	4.90
3	11490.00	57.7 PK	74.0	-16.3	1.52 V	162	47.10	10.60
4	11490.00	44.2 AV	54.0	-9.8	1.52 V	162	33.60	10.60

**REMARKS:**

1. Emission Level(dBuV/m) = Raw Value(dBuV) + Correction Factor(dB/m)
2. Correction Factor(dB/m) = Antenna Factor(dB/m) + Cable Factor(dB) – Pre-Amplifier Factor(dB)
3. The other emission levels were very low against the limit.
4. Margin value = Emission Level – Limit value
5. " \* ": Fundamental frequency.
6. The limit value is defined as per 15.247.





A D T

<b>CHANNEL</b>	TX Channel 157	<b>DETECTOR FUNCTION</b>	Peak (PK)
<b>FREQUENCY RANGE</b>	1GHz ~ 40GHz		Average (AV)

**ANTENNA POLARITY & TEST DISTANCE: HORIZONTAL AT 3 M**

NO.	FREQ. (MHz)	EMISSION LEVEL (dBuV/m)	LIMIT (dBuV/m)	MARGIN (dB)	ANTENNA HEIGHT (m)	TABLE ANGLE (Degree)	RAW VALUE (dBuV)	CORRECTION FACTOR (dB/m)
1	*5785.00	117.2 PK			1.08 H	189	112.30	4.90
2	*5785.00	106.8 AV			1.08 H	189	101.90	4.90
3	11570.00	60.6 PK	74.0	-13.4	1.25 H	174	49.90	10.70
4	11570.00	47.6 AV	54.0	-6.4	1.25 H	174	36.90	10.70

**ANTENNA POLARITY & TEST DISTANCE: VERTICAL AT 3 M**

NO.	FREQ. (MHz)	EMISSION LEVEL (dBuV/m)	LIMIT (dBuV/m)	MARGIN (dB)	ANTENNA HEIGHT (m)	TABLE ANGLE (Degree)	RAW VALUE (dBuV)	CORRECTION FACTOR (dB/m)
1	*5785.00	117.9 PK			1.30 V	198	113.00	4.90
2	*5785.00	109.5 AV			1.30 V	198	104.60	4.90
3	11570.00	61.4 PK	74.0	-12.6	1.64 V	174	50.70	10.70
4	11570.00	48.8 AV	54.0	-5.2	1.64 V	174	38.10	10.70

**REMARKS:**

1. Emission Level(dBuV/m) = Raw Value(dBuV) + Correction Factor(dB/m)
2. Correction Factor(dB/m) = Antenna Factor(dB/m) + Cable Factor(dB) – Pre-Amplifier Factor(dB)
3. The other emission levels were very low against the limit.
4. Margin value = Emission Level – Limit value
5. " \* ": Fundamental frequency.
6. The limit value is defined as per 15.247.



A D T

<b>CHANNEL</b>	TX Channel 165	<b>DETECTOR FUNCTION</b>	Peak (PK)
<b>FREQUENCY RANGE</b>	1GHz ~ 40GHz		Average (AV)

**ANTENNA POLARITY & TEST DISTANCE: HORIZONTAL AT 3 M**

NO.	FREQ. (MHz)	EMISSION LEVEL (dBuV/m)	LIMIT (dBuV/m)	MARGIN (dB)	ANTENNA HEIGHT (m)	TABLE ANGLE (Degree)	RAW VALUE (dBuV)	CORRECTION FACTOR (dB/m)
1	*5825.00	117.2 PK			1.08 H	189	112.10	5.10
2	*5825.00	106.5 AV			1.08 H	189	101.40	5.10
3	11650.00	62.6 PK	74.0	-11.4	1.19 H	173	52.00	10.60
4	11650.00	48.5 AV	54.0	-5.5	1.19 H	173	37.90	10.60

**ANTENNA POLARITY & TEST DISTANCE: VERTICAL AT 3 M**

NO.	FREQ. (MHz)	EMISSION LEVEL (dBuV/m)	LIMIT (dBuV/m)	MARGIN (dB)	ANTENNA HEIGHT (m)	TABLE ANGLE (Degree)	RAW VALUE (dBuV)	CORRECTION FACTOR (dB/m)
1	*5825.00	118.4 PK			1.28 V	197	113.30	5.10
2	*5825.00	109.1 AV			1.28 V	197	104.00	5.10
3	11650.00	62.9 PK	74.0	-11.1	1.53 V	172	52.30	10.60
4	11650.00	50.0 AV	54.0	-4.0	1.53 V	172	39.40	10.60

**REMARKS:**

1. Emission Level(dBuV/m) = Raw Value(dBuV) + Correction Factor(dB/m)
2. Correction Factor(dB/m) = Antenna Factor(dB/m) + Cable Factor(dB) – Pre-Amplifier Factor(dB)
3. The other emission levels were very low against the limit.
4. Margin value = Emission Level – Limit value
5. " \* ": Fundamental frequency.
6. The limit value is defined as per 15.247.



A D T

802.11ac (VHT40), 2Tx

<b>CHANNEL</b>	TX Channel 151	<b>DETECTOR FUNCTION</b>	Peak (PK)
<b>FREQUENCY RANGE</b>	1GHz ~ 40GHz		Average (AV)

**ANTENNA POLARITY & TEST DISTANCE: HORIZONTAL AT 3 M**

NO.	FREQ. (MHz)	EMISSION LEVEL (dBuV/m)	LIMIT (dBuV/m)	MARGIN (dB)	ANTENNA HEIGHT (m)	TABLE ANGLE (Degree)	RAW VALUE (dBuV)	CORRECTION FACTOR (dB/m)
1	*5755.00	116.4 PK			1.03 H	196	111.50	4.90
2	*5755.00	105.3 AV			1.03 H	196	100.40	4.90
3	11510.00	62.4 PK	74.0	-11.6	1.20 H	173	51.70	10.70
4	11510.00	48.1 AV	54.0	-5.9	1.20 H	173	37.40	10.70

**ANTENNA POLARITY & TEST DISTANCE: VERTICAL AT 3 M**

NO.	FREQ. (MHz)	EMISSION LEVEL (dBuV/m)	LIMIT (dBuV/m)	MARGIN (dB)	ANTENNA HEIGHT (m)	TABLE ANGLE (Degree)	RAW VALUE (dBuV)	CORRECTION FACTOR (dB/m)
1	*5755.00	117.0 PK			1.03 V	188	112.10	4.90
2	*5755.00	108.6 AV			1.03 V	188	103.70	4.90
3	11510.00	62.2 PK	74.0	-11.8	1.48 V	176	51.50	10.70
4	11510.00	49.6 AV	54.0	-4.4	1.48 V	176	38.90	10.70

**REMARKS:**

1. Emission Level(dBuV/m) = Raw Value(dBuV) + Correction Factor(dB/m)
2. Correction Factor(dB/m) = Antenna Factor(dB/m) + Cable Factor(dB) – Pre-Amplifier Factor(dB)
3. The other emission levels were very low against the limit.
4. Margin value = Emission Level – Limit value
5. " \* " : Fundamental frequency.
6. The limit value is defined as per 15.247.



A D T

<b>CHANNEL</b>	TX Channel 159	<b>DETECTOR FUNCTION</b>	Peak (PK)
<b>FREQUENCY RANGE</b>	1GHz ~ 40GHz		Average (AV)

**ANTENNA POLARITY & TEST DISTANCE: HORIZONTAL AT 3 M**

NO.	FREQ. (MHz)	EMISSION LEVEL (dBuV/m)	LIMIT (dBuV/m)	MARGIN (dB)	ANTENNA HEIGHT (m)	TABLE ANGLE (Degree)	RAW VALUE (dBuV)	CORRECTION FACTOR (dB/m)
1	*5795.00	117.0 PK			1.02 H	177	112.20	4.80
2	*5795.00	106.2 AV			1.02 H	177	101.40	4.80
3	11590.00	61.8 PK	74.0	-12.2	1.20 H	157	51.10	10.70
4	11590.00	47.6 AV	54.0	-6.4	1.20 H	157	36.90	10.70

**ANTENNA POLARITY & TEST DISTANCE: VERTICAL AT 3 M**

NO.	FREQ. (MHz)	EMISSION LEVEL (dBuV/m)	LIMIT (dBuV/m)	MARGIN (dB)	ANTENNA HEIGHT (m)	TABLE ANGLE (Degree)	RAW VALUE (dBuV)	CORRECTION FACTOR (dB/m)
1	*5795.00	117.2 PK			1.05 V	189	112.40	4.80
2	*5795.00	109.3 AV			1.05 V	189	104.50	4.80
3	11590.00	62.7 PK	74.0	-11.3	1.54 V	163	52.00	10.70
4	11590.00	49.7 AV	54.0	-4.3	1.54 V	163	39.00	10.70

**REMARKS:**

1. Emission Level(dBuV/m) = Raw Value(dBuV) + Correction Factor(dB/m)
2. Correction Factor(dB/m) = Antenna Factor(dB/m) + Cable Factor(dB) – Pre-Amplifier Factor(dB)
3. The other emission levels were very low against the limit.
4. Margin value = Emission Level – Limit value
5. " \* ": Fundamental frequency.
6. The limit value is defined as per 15.247.



802.11ac (VHT80), 2Tx

<b>CHANNEL</b>	TX Channel 155	<b>DETECTOR FUNCTION</b>	Peak (PK)
<b>FREQUENCY RANGE</b>	1GHz ~ 40GHz		Average (AV)

**ANTENNA POLARITY & TEST DISTANCE: HORIZONTAL AT 3 M**

NO.	FREQ. (MHz)	EMISSION LEVEL (dBuV/m)	LIMIT (dBuV/m)	MARGIN (dB)	ANTENNA HEIGHT (m)	TABLE ANGLE (Degree)	RAW VALUE (dBuV)	CORRECTION FACTOR (dB/m)
1	*5775.00	115.4 PK			1.05 H	182	110.50	4.90
2	*5775.00	103.1 AV			1.05 H	182	98.20	4.90
3	11550.00	60.8 PK	74.0	-13.2	1.19 H	161	50.10	10.70
4	11550.00	46.9 AV	54.0	-7.1	1.19 H	161	36.20	10.70

**ANTENNA POLARITY & TEST DISTANCE: VERTICAL AT 3 M**

NO.	FREQ. (MHz)	EMISSION LEVEL (dBuV/m)	LIMIT (dBuV/m)	MARGIN (dB)	ANTENNA HEIGHT (m)	TABLE ANGLE (Degree)	RAW VALUE (dBuV)	CORRECTION FACTOR (dB/m)
1	*5775.00	115.0 PK			1.04 V	183	110.10	4.90
2	*5775.00	106.2 AV			1.04 V	183	101.30	4.90
3	11550.00	63.3 PK	74.0	-10.7	1.48 V	167	52.60	10.70
4	11550.00	50.4 AV	54.0	-3.6	1.48 V	167	39.70	10.70

**REMARKS:**

1. Emission Level(dBuV/m) = Raw Value(dBuV) + Correction Factor(dB/m)
2. Correction Factor(dB/m) = Antenna Factor(dB/m) + Cable Factor(dB) – Pre-Amplifier Factor(dB)
3. The other emission levels were very low against the limit.
4. Margin value = Emission Level – Limit value
5. " \* " : Fundamental frequency.
6. The limit value is defined as per 15.247.

### 5.3 6dB BANDWIDTH MEASUREMENT

#### 5.3.1 LIMITS OF 6dB BANDWIDTH MEASUREMENT

The minimum of 6dB Bandwidth Measurement is 0.5 MHz.

#### 5.3.2 TEST INSTRUMENTS

DESCRIPTION & MANUFACTURER	MODEL NO.	SERIAL NO.	CALIBRATED DATE	CALIBRATED UNTIL
Spectrum Analyzer R&S	FSV 40	100964	July 15, 2013	July 14, 2014

**Note:**

1. The calibration interval of the above test instruments is 12 months and the calibrations are traceable to NML/ROC and NIST/USA.
2. Tested date : Apr. 08, 2014

#### 5.3.3 TEST PROCEDURE

1. Set resolution bandwidth (RBW) = 100kHz
2. Set the video bandwidth (VBW)  $\geq 3 \times$  RBW, Detector = Peak.
3. Trace mode = max hold.
4. Sweep = auto couple.
5. Measure the maximum width of the emission that is constrained by the frequencies associated with the two amplitude points (upper and lower) that are attenuated by 6 dB relative to the maximum level measured in the fundamental emission

#### 5.3.4 DEVIATION FROM TEST STANDARD

No deviation

#### 5.3.5 TEST SETUP

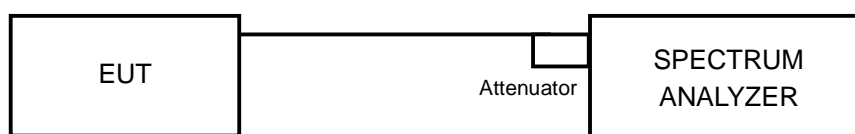

#### 5.3.6 EUT OPERATING CONDITIONS

The software provided by client to enable the EUT under transmission condition continuously at lowest, middle and highest channel frequencies individually.



A D T

### 5.3.7 TEST RESULTS (MODE 1)

#### 802.11a, 1Tx

CHANNEL	CHANNEL FREQUENCY (MHz)	6dB BANDWIDTH (MHz)	MINIMUM LIMIT (MHz)	PASS / FAIL
149	5745	16.59	0.5	PASS
157	5785	16.62	0.5	PASS
165	5825	16.59	0.5	PASS

#### 802.11ac(VHT20), 1Tx

CHANNEL	CHANNEL FREQUENCY (MHz)	6dB BANDWIDTH (MHz)	MINIMUM LIMIT (MHz)	PASS / FAIL
149	5745	17.75	0.5	PASS
157	5785	17.80	0.5	PASS
165	5825	17.77	0.5	PASS

#### 802.11ac(VHT40), 1Tx

CHANNEL	CHANNEL FREQUENCY (MHz)	6dB BANDWIDTH (MHz)	MINIMUM LIMIT (MHz)	PASS / FAIL
151	5755	36.59	0.5	PASS
159	5795	36.60	0.5	PASS

#### 802.11ac (VHT80), 1Tx

CHANNEL	CHANNEL FREQUENCY (MHz)	6dB BANDWIDTH (MHz)	MINIMUM LIMIT (MHz)	PASS / FAIL
155	5775	76.66	0.5	PASS



A D T

### SPECTRUM PLOT OF WORST VALUE

#### 802.11a : CH149

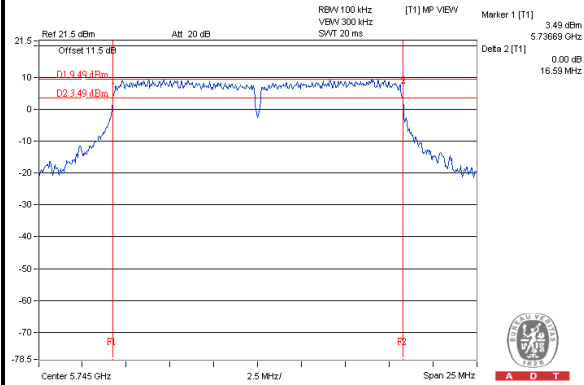

#### 802.11ac (VHT20) : CH149

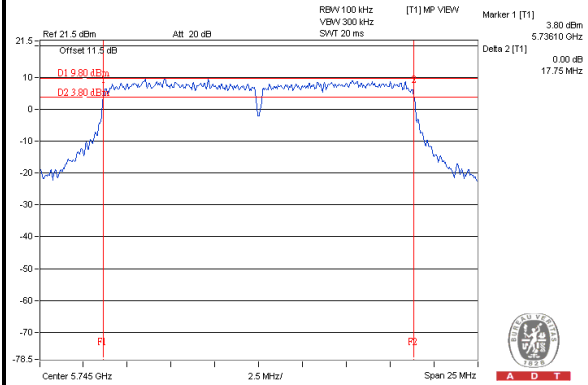

#### 802.11ac (VHT40) : CH151

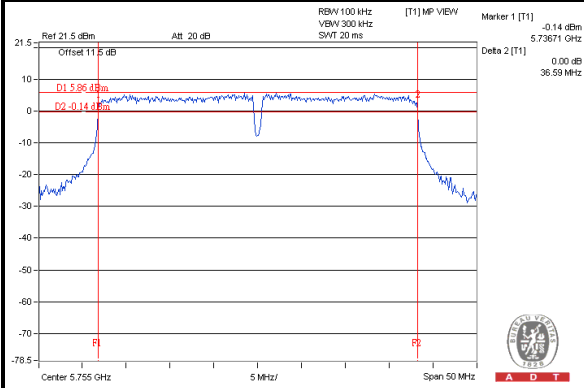

#### 802.11ac (VHT80) : CH155

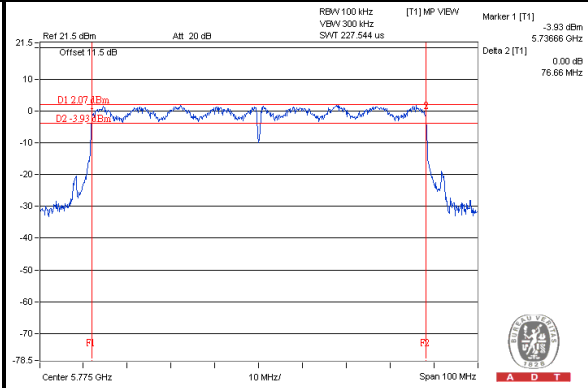





A D T

802.11ac(VHT20), 2Tx

CHANNEL	CHANNEL FREQUENCY (MHz)	6dB BANDWIDTH (MHz)		MINIMUM LIMIT (MHz)	PASS / FAIL
		CHAIN 0	CHAIN 1		
149	5745	17.76	17.70	0.5	PASS
157	5785	17.81	17.73	0.5	PASS
165	5825	17.74	17.75	0.5	PASS

802.11ac(VHT40), 2Tx

CHANNEL	CHANNEL FREQUENCY (MHz)	6dB BANDWIDTH (MHz)		MINIMUM LIMIT (MHz)	PASS / FAIL
		CHAIN 0	CHAIN 1		
151	5755	36.47	36.48	0.5	PASS
159	5795	36.63	36.53	0.5	PASS

802.11ac (VHT80), 2Tx

CHANNEL	CHANNEL FREQUENCY (MHz)	6dB BANDWIDTH (MHz)		MINIMUM LIMIT (MHz)	PASS / FAIL
		CHAIN 0	CHAIN 1		
155	5775	76.68	76.70	0.5	PASS



A D T

### SPECTRUM PLOT OF WORST VALUE

#### 802.11ac (VHT20) / Chain(1) : CH149

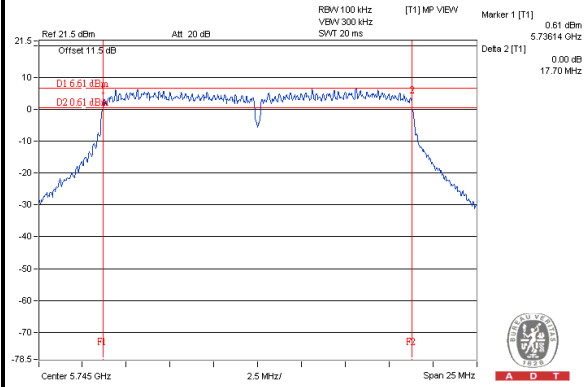

#### 802.11ac (VHT40) / Chain(0) : CH151

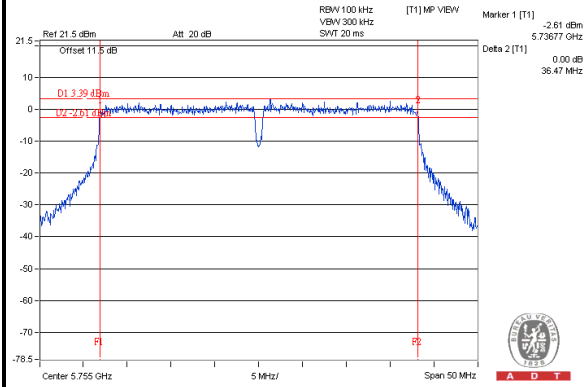

#### 802.11ac (VHT80) / Chain(0) : CH155

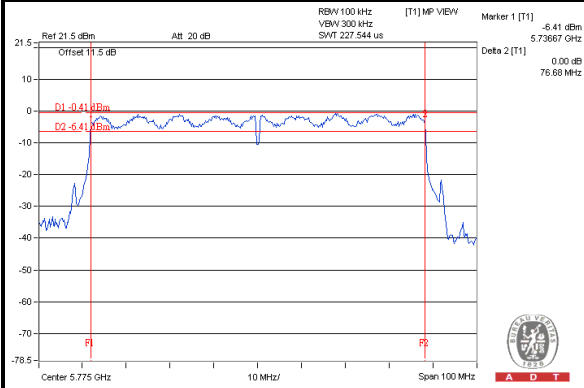



A D T

### 5.3.8 TEST RESULTS (MODE 2)

#### 802.11a, 1Tx

CHANNEL	CHANNEL FREQUENCY (MHz)	6dB BANDWIDTH (MHz)	MINIMUM LIMIT (MHz)	PASS / FAIL
149	5745	16.59	0.5	PASS
157	5785	16.61	0.5	PASS
165	5825	16.60	0.5	PASS

#### 802.11ac(VHT20), 1Tx

CHANNEL	CHANNEL FREQUENCY (MHz)	6dB BANDWIDTH (MHz)	MINIMUM LIMIT (MHz)	PASS / FAIL
149	5745	17.81	0.5	PASS
157	5785	17.82	0.5	PASS
165	5825	17.76	0.5	PASS

#### 802.11ac(VHT40), 1Tx

CHANNEL	CHANNEL FREQUENCY (MHz)	6dB BANDWIDTH (MHz)	MINIMUM LIMIT (MHz)	PASS / FAIL
151	5755	36.55	0.5	PASS
159	5795	36.59	0.5	PASS

#### 802.11ac (VHT80), 1Tx

CHANNEL	CHANNEL FREQUENCY (MHz)	6dB BANDWIDTH (MHz)	MINIMUM LIMIT (MHz)	PASS / FAIL
155	5775	76.66	0.5	PASS



A D T

### SPECTRUM PLOT OF WORST VALUE

#### 802.11a : CH149

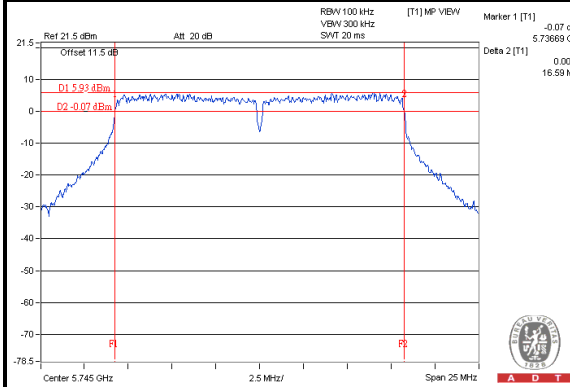

#### 802.11ac (VHT20) : CH165

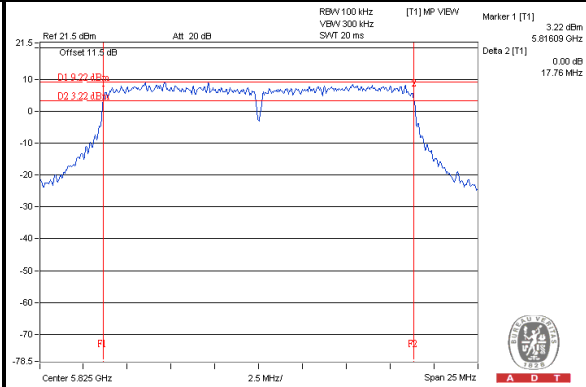

#### 802.11ac (VHT40) : CH151

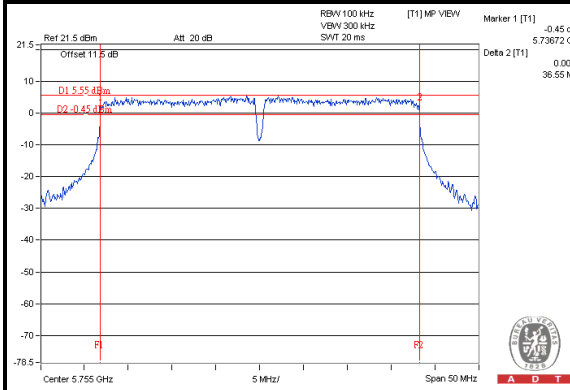

#### 802.11ac (VHT80) : CH155

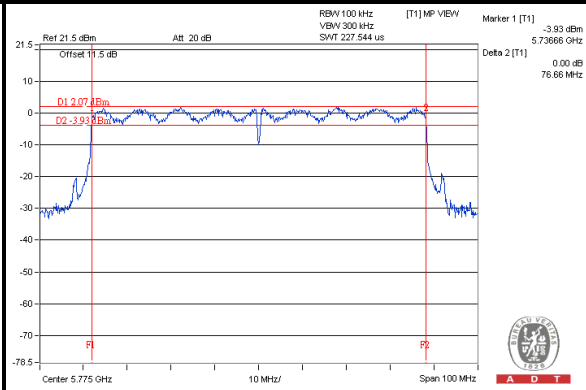



A D T

802.11ac(VHT20), 2Tx

CHANNEL	CHANNEL FREQUENCY (MHz)	6dB BANDWIDTH (MHz)		MINIMUM LIMIT (MHz)	PASS / FAIL
		CHAIN 0	CHAIN 1		
149	5745	17.76	17.70	0.5	PASS
157	5785	17.81	17.73	0.5	PASS
165	5825	17.74	17.75	0.5	PASS

802.11ac(VHT40), 2Tx

CHANNEL	CHANNEL FREQUENCY (MHz)	6dB BANDWIDTH (MHz)		MINIMUM LIMIT (MHz)	PASS / FAIL
		CHAIN 0	CHAIN 1		
151	5755	36.47	36.48	0.5	PASS
159	5795	36.63	36.53	0.5	PASS

802.11ac (VHT80), 2Tx

CHANNEL	CHANNEL FREQUENCY (MHz)	6dB BANDWIDTH (MHz)		MINIMUM LIMIT (MHz)	PASS / FAIL
		CHAIN 0	CHAIN 1		
155	5775	76.68	76.70	0.5	PASS



A D T

### SPECTRUM PLOT OF WORST VALUE

#### 802.11ac (VHT20) / Chain(1) : CH149

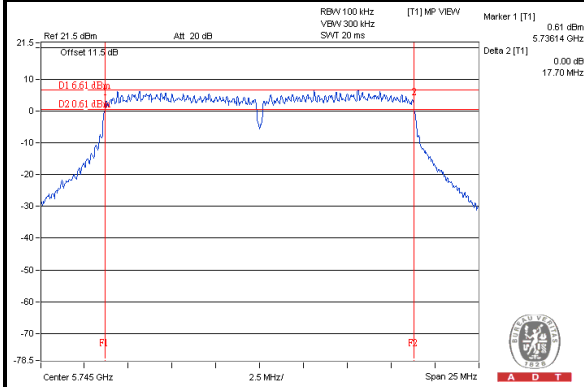

#### 802.11ac (VHT40) / Chain(0) : CH151

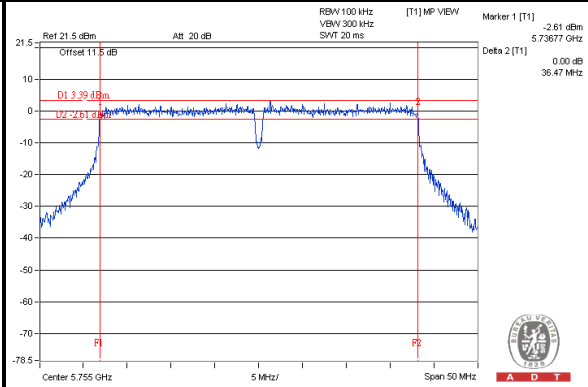

#### 802.11ac (VHT80) / Chain(0) : CH155

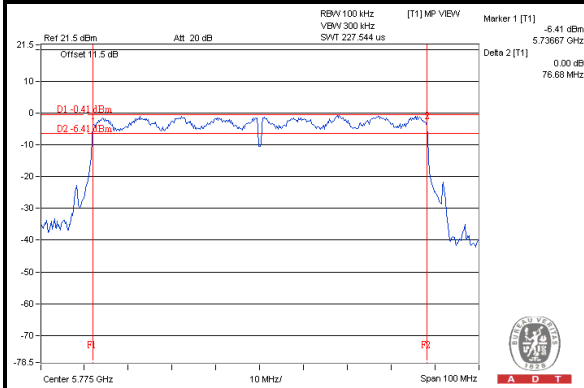

## 5.4 CONDUCTED OUTPUT POWER MEASUREMENT

### 5.4.1 LIMITS OF CONDUCTED OUTPUT POWER MEASUREMENT

For systems using digital modulation in the 5725 –5850 MHz band: 1 Watt (30dBm)

Per KDB 662911 D01 Multiple Transmitter Output Method of conducted output power measurement on IEEE 802.11 devices,

Array Gain = 0 dB (i.e., no array gain) for NANT  $\leq$  4;

Array Gain = 0 dB (i.e., no array gain) for channel widths  $\geq$  40 MHz for any NANT;

Array Gain = 5 log(NANT/NSS) dB or 3 dB, whichever is less for 20-MHz channel widths with NANT  $\geq$  5.

For power measurements on all other devices: Array Gain = 10 log(NANT/NSS) dB.

### 5.4.2 INSTRUMENTS

DESCRIPTION & MANUFACTURER	MODEL NO.	SERIAL NO.	CALIBRATED DATE	CALIBRATED UNTIL
Power meter Anritsu	ML2495A	1014008	Apr. 23, 2013	Apr. 22, 2014
Power sensor Anritsu	MA2411B	0917122	Apr. 23, 2013	Apr. 22, 2014

**Note:**

1. The calibration interval of the above test instruments is 12 months and the calibrations are traceable to NML/ROC and NIST/USA.
2. Tested date : Apr. 08, 2014

### 5.4.3 TEST PROCEDURES

The average power sensor was used on the output port of the EUT. A power meter was used to read the response of the average power sensor. Record the average power level.

### 5.4.4 DEVIATION FROM TEST STANDARD

No deviation.

### 5.4.5 TEST SETUP

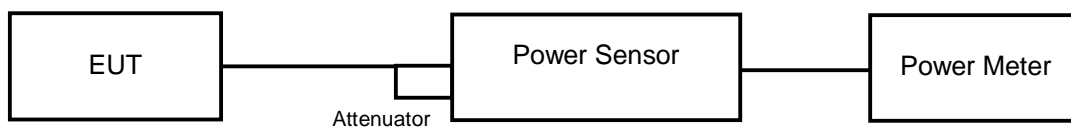

### 5.4.6 EUT OPERATING CONDITIONS

Same as Item 5.3.6





A D T

## 5.4.7 TEST RESULTS (MODE 1)

### 802.11a, 1Tx

CHANNEL	FREQUENCY (MHz)	AVERAGE POWER (mW)	AVERAGE POWER (dBm)	LIMIT (dBm)	PASS/FAIL
149	5745	240.436	23.81	30	PASS
157	5785	249.459	23.97	30	PASS
165	5825	253.513	24.04	30	PASS

### 802.11ac(VHT20), 1Tx

CHANNEL	FREQUENCY (MHz)	AVERAGE POWER (mW)	AVERAGE POWER (dBm)	LIMIT (dBm)	PASS/FAIL
149	5745	243.220	23.86	30	PASS
157	5785	250.611	23.99	30	PASS
165	5825	253.513	24.04	30	PASS

### 802.11ac(VHT40), 1Tx

CHANNEL	FREQUENCY (MHz)	AVERAGE POWER (mW)	AVERAGE POWER (dBm)	LIMIT (dBm)	PASS/FAIL
151	5755	249.459	23.97	30	PASS
159	5795	251.768	24.01	30	PASS

### 802.11ac(VHT80), 1Tx

CHANNEL	FREQUENCY (MHz)	AVERAGE POWER (mW)	AVERAGE POWER (dBm)	LIMIT (dBm)	PASS/FAIL
155	5775	153.109	21.85	30	PASS



A D T

**802.11ac(VHT20), 2Tx**

CHANNEL	FREQUENCY (MHz)	AVERAGE POWER (dBm)		TOTAL POWER (mW)	TOTAL POWER (dBm)	LIMIT (dBm)	PASS / FAIL
		CHAIN 0	CHAIN 1				
149	5745	20.12	20.39	212.198	23.27	30	PASS
157	5785	20.94	20.82	244.946	23.89	30	PASS
165	5825	20.54	20.62	228.585	23.59	30	PASS

**802.11ac(VHT40), 2Tx**

CHANNEL	FREQUENCY (MHz)	AVERAGE POWER (dBm)		TOTAL POWER (mW)	TOTAL POWER (dBm)	LIMIT (dBm)	PASS / FAIL
		CHAIN 0	CHAIN 1				
151	5755	19.26	20.01	184.564	22.66	30	PASS
159	5795	19.96	20.07	200.708	23.03	30	PASS

**802.11ac (VHT80), 2Tx**

CHANNEL	FREQUENCY (MHz)	AVERAGE POWER (dBm)		TOTAL POWER (mW)	TOTAL POWER (dBm)	LIMIT (dBm)	PASS / FAIL
		CHAIN 0	CHAIN 1				
155	5775	19.76	19.91	192.573	22.85	30	PASS



A D T

## 5.4.8 TEST RESULTS (MODE 2)

### 802.11a, 1Tx

CHANNEL	FREQUENCY (MHz)	AVERAGE POWER (mW)	AVERAGE POWER (dBm)	LIMIT (dBm)	PASS/FAIL
149	5745	109.901	20.41	23.5	PASS
157	5785	120.781	20.82	23.5	PASS
165	5825	138.995	21.43	23.5	PASS

Note: The directional gain is 12.5dBi > 6dBi, therefore the limit needs to reduce, so the power limit shall be reduced to  $30-(12.5-6) = 23.5$ dBm.

### 802.11ac(VHT20), 1Tx

CHANNEL	FREQUENCY (MHz)	AVERAGE POWER (mW)	AVERAGE POWER (dBm)	LIMIT (dBm)	PASS/FAIL
149	5745	203.704	23.09	23.5	PASS
157	5785	209.894	23.22	23.5	PASS
165	5825	211.349	23.25	23.5	PASS

Note: The directional gain is 12.5dBi > 6dBi, therefore the limit needs to reduce, so the power limit shall be reduced to  $30-(12.5-6) = 23.5$ dBm.

### 802.11ac(VHT40), 1Tx

CHANNEL	FREQUENCY (MHz)	AVERAGE POWER (mW)	AVERAGE POWER (dBm)	LIMIT (dBm)	PASS/FAIL
151	5755	208.449	23.19	23.5	PASS
159	5795	204.644	23.11	23.5	PASS

Note: The directional gain is 12.5dBi > 6dBi, therefore the limit needs to reduce, so the power limit shall be reduced to  $30-(12.5-6) = 23.5$ dBm.

### 802.11ac(VHT80), 1Tx

CHANNEL	FREQUENCY (MHz)	AVERAGE POWER (mW)	AVERAGE POWER (dBm)	LIMIT (dBm)	PASS/FAIL
155	5775	153.109	21.85	23.5	PASS

Note: The directional gain is 12.5dBi > 6dBi, therefore the limit needs to reduce, so the power limit shall be reduced to  $30-(12.5-6) = 23.5$ dBm.



A D T

**802.11ac(VHT20), 2Tx**

CHANNEL	FREQUENCY (MHz)	AVERAGE POWER (dBm)		TOTAL POWER (mW)	TOTAL POWER (dBm)	LIMIT (dBm)	PASS / FAIL
		CHAIN 0	CHAIN 1				
149	5745	20.12	20.39	212.198	23.27	23.5	PASS
157	5785	20.41	20.32	217.548	23.38	23.5	PASS
165	5825	20.01	20.08	202.090	23.06	23.5	PASS

Note: The directional gain is 12.5dBi > 6dBi, therefore the limit needs to reduce, so the power limit shall be reduced to  $30-(12.5-6) = 23.5$ dBm.

**802.11ac(VHT40), 2Tx**

CHANNEL	FREQUENCY (MHz)	AVERAGE POWER (dBm)		TOTAL POWER (mW)	TOTAL POWER (dBm)	LIMIT (dBm)	PASS / FAIL
		CHAIN 0	CHAIN 1				
151	5755	19.26	20.01	184.564	22.66	23.5	PASS
159	5795	19.96	20.07	200.708	23.03	23.5	PASS

Note: The directional gain is 12.5dBi > 6dBi, therefore the limit needs to reduce, so the power limit shall be reduced to  $30-(12.5-6) = 23.5$ dBm.

**802.11ac (VHT80), 2Tx**

CHANNEL	FREQUENCY (MHz)	AVERAGE POWER (dBm)		TOTAL POWER (mW)	TOTAL POWER (dBm)	LIMIT (dBm)	PASS / FAIL
		CHAIN 0	CHAIN 1				
155	5775	19.76	19.91	192.573	22.85	23.5	PASS

Note: The directional gain is 12.5dBi > 6dBi, therefore the limit needs to reduce, so the power limit shall be reduced to  $30-(12.5-6) = 23.5$ dBm.

## 5.5 POWER SPECTRAL DENSITY MEASUREMENT

### 5.5.1 LIMITS OF POWER SPECTRAL DENSITY MEASUREMENT

The Maximum of Power Spectral Density Measurement is 8dBm.

### 5.5.2 TEST INSTRUMENTS

DESCRIPTION & MANUFACTURER	MODEL NO.	SERIAL NO.	CALIBRATED DATE	CALIBRATED UNTIL
Spectrum Analyzer R&S	FSV 40	100964	July 15, 2013	July 14, 2014

**Note:**

1. The calibration interval of the above test instruments is 12 months and the calibrations are traceable to NML/ROC and NIST/USA.
2. Tested date : Apr. 08, 2014

### 5.5.3 TEST PROCEDURE

6. Set the RBW = 10 kHz, VBW =30 kHz, Detector = power averaging (RMS).
7. Ensure that the number of measurement points in the sweep  $\geq 2 \times$  span/RBW
8. Sweep time = auto couple,
9. Employ trace averaging (RMS) mode over a minimum of 100 traces.
10. Use the peak marker function to determine the maximum amplitude level.

### 5.5.4 DEVIATION FROM TEST STANDARD

No deviation

### 5.5.5 TEST SETUP

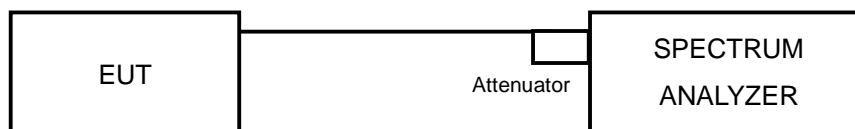

## 5.5.6 EUT OPERATING CONDITION

Same as Item 4.3.6



A D T

### 5.5.7 TEST RESULTS (MODE 1)

#### 802.11a, 1Tx

CHANNEL	FREQUENCY (MHz)	PSD (dBm)	LIMIT (dBm)	PASS /FAIL
149	5745	-6.15	8	PASS
157	5785	-6.18	8	PASS
165	5825	-6.16	8	PASS

#### 802.11ac(VHT20), 1Tx

CHANNEL	FREQUENCY (MHz)	PSD (dBm)	LIMIT (dBm)	PASS /FAIL
149	5745	-6.61	8	PASS
157	5785	-6.39	8	PASS
165	5825	-5.92	8	PASS

#### 802.11ac(VHT40), 1Tx

CHANNEL	FREQUENCY (MHz)	PSD (dBm)	LIMIT (dBm)	PASS /FAIL
151	5755	-9.31	8	PASS
159	5795	-9.17	8	PASS

#### 802.11ac(VHT80), 1Tx

CHANNEL	FREQUENCY (MHz)	PSD (dBm)	LIMIT (dBm)	PASS /FAIL
155	5775	-13.23	8	PASS



A D T

### SPECTRUM PLOT OF WORST VALUE

#### 802.11a : CH149

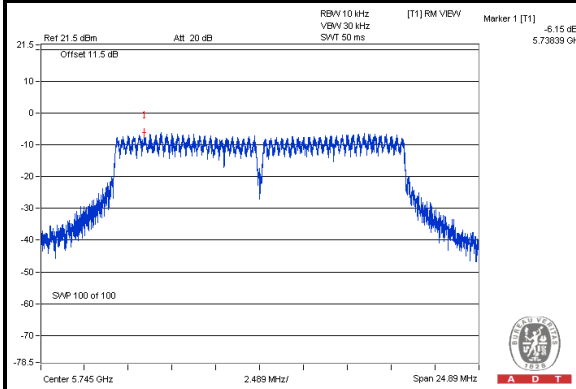

#### 802.11ac (VHT20) : CH165

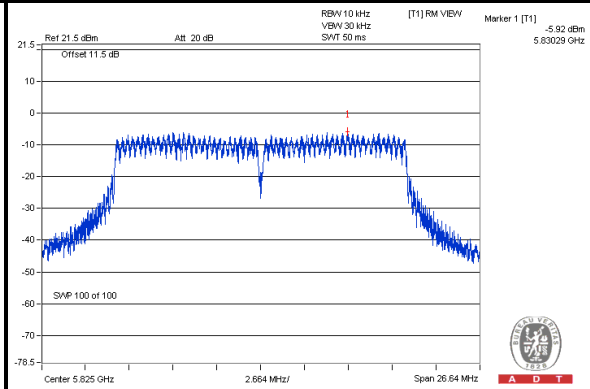

#### 802.11ac (VHT40) : CH159

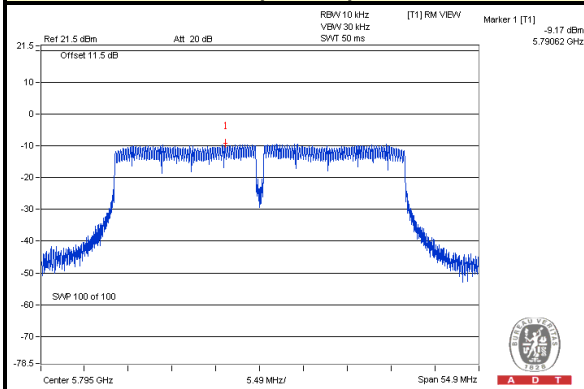

#### 802.11ac (VHT80) : CH155

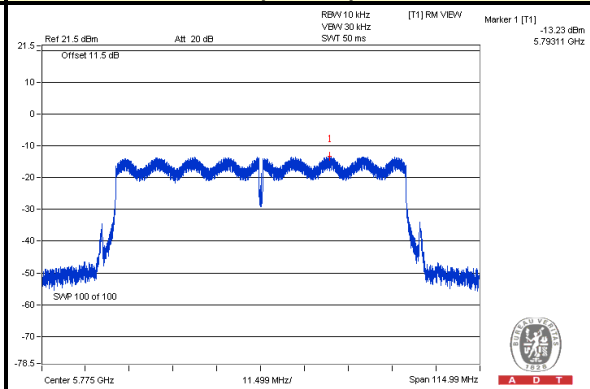





A D T

### 802.11ac(VHT20), 2Tx

TX CHAIN	CHANNEL	FREQUENCY (MHz)	PSD (dBm)	10 log (N=2) dB	Total PSD (dBm)	Limit (dBm)	PASS /FAIL
0	149	5745	-10.13	3.01	-7.12	8	PASS
	157	5785	-8.49	3.01	-5.48	8	PASS
	165	5825	-9.95	3.01	-6.94	8	PASS
1	149	5745	-10.99	3.01	-7.98	8	PASS
	157	5785	-9.88	3.01	-6.87	8	PASS
	165	5825	-9.85	3.01	-6.84	8	PASS

### 802.11ac(VHT40), 2Tx

TX CHAIN	CHANNEL	FREQUENCY (MHz)	PSD (dBm)	10 log (N=2) dB	Total PSD (dBm)	Limit (dBm)	PASS /FAIL
0	151	5755	-12.74	3.01	-9.73	8	PASS
	159	5795	-12.37	3.01	-9.36	8	PASS
1	151	5755	-12.43	3.01	-9.42	8	PASS
	159	5795	-12.12	3.01	-9.11	8	PASS

### 802.11ac(VHT80), 2Tx

TX CHAIN	CHANNEL	FREQUENCY (MHz)	PSD (dBm)	10 log (N=2) dB	Total PSD (dBm)	Limit (dBm)	PASS /FAIL
0	155	5775	-15.66	3.01	-12.65	8	PASS
1	155	5775	-14.79	3.01	-11.78	8	PASS



A D T

### SPECTRUM PLOT OF WORST VALUE

802.11ac (VHT20) / Chain(0) : CH157

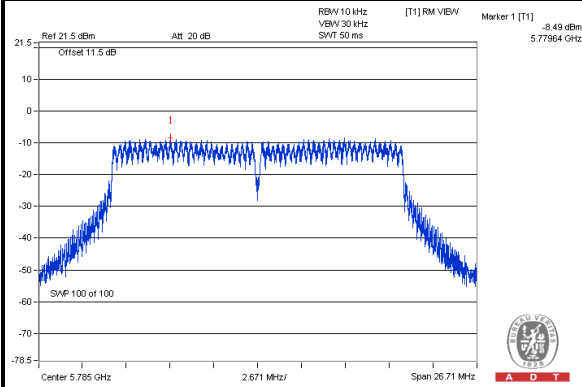

802.11ac (VHT40) / Chain(1) : CH159

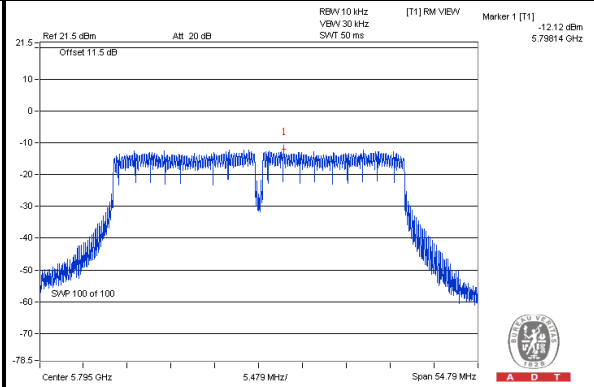

802.11ac (VHT80) / Chain(1) : CH155

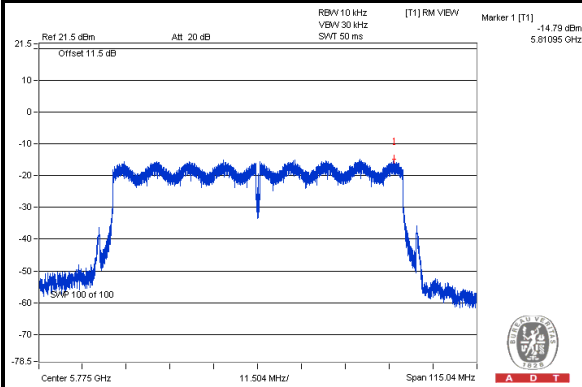



A D T

## 5.5.8 TEST RESULTS (MODE 2)

### 802.11a, 1Tx

CHANNEL	FREQUENCY (MHz)	PSD (dBm)	LIMIT (dBm)	PASS /FAIL
149	5745	-9.94	1.5	PASS
157	5785	-9.25	1.5	PASS
165	5825	-8.45	1.5	PASS

Note: The directional gain is 12.5dBi > 6dBi, therefore the limit needs to reduce, so the power density limit shall be reduced to  $8-(12.5-6) = 1.5$ dBm.

### 802.11ac(VHT20), 1Tx

CHANNEL	FREQUENCY (MHz)	PSD (dBm)	LIMIT (dBm)	PASS /FAIL
149	5745	-7.20	1.5	PASS
157	5785	-6.87	1.5	PASS
165	5825	-6.94	1.5	PASS

Note: The directional gain is 12.5dBi > 6dBi, therefore the limit needs to reduce, so the power density limit shall be reduced to  $8-(12.5-6) = 1.5$ dBm.

### 802.11ac(VHT40), 1Tx

CHANNEL	FREQUENCY (MHz)	PSD (dBm)	LIMIT (dBm)	PASS /FAIL
151	5755	-9.72	1.5	PASS
159	5795	-9.59	1.5	PASS

Note: The directional gain is 12.5dBi > 6dBi, therefore the limit needs to reduce, so the power density limit shall be reduced to  $8-(12.5-6) = 1.5$ dBm.

### 802.11ac(VHT80), 1Tx

CHANNEL	FREQUENCY (MHz)	PSD (dBm)	LIMIT (dBm)	PASS /FAIL
155	5775	-13.23	1.5	PASS

Note: The directional gain is 12.5dBi > 6dBi, therefore the limit needs to reduce, so the power density limit shall be reduced to  $8-(12.5-6) = 1.5$ dBm.



A D T

### SPECTRUM PLOT OF WORST VALUE

#### 802.11a : CH165

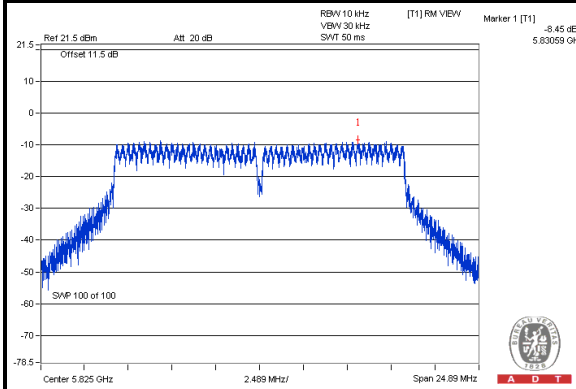

#### 802.11ac (VHT20) : CH157

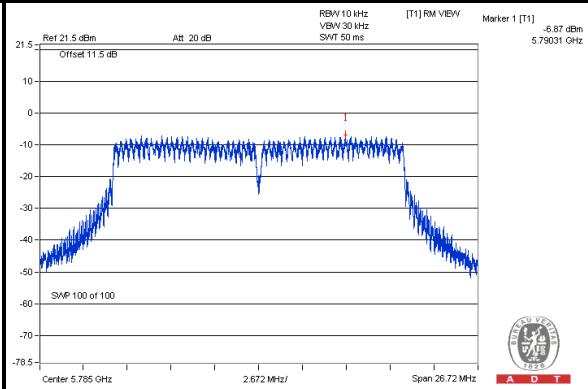

#### 802.11ac (VHT40) : CH159

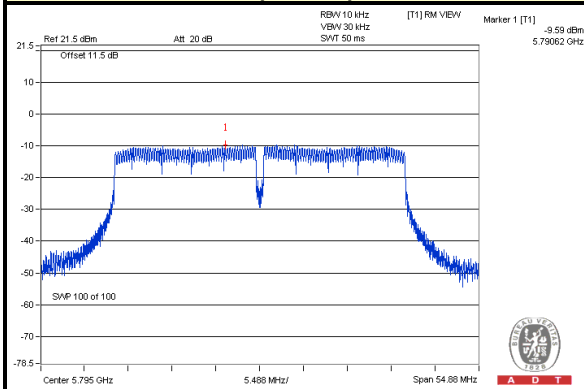

#### 802.11ac (VHT80) : CH155

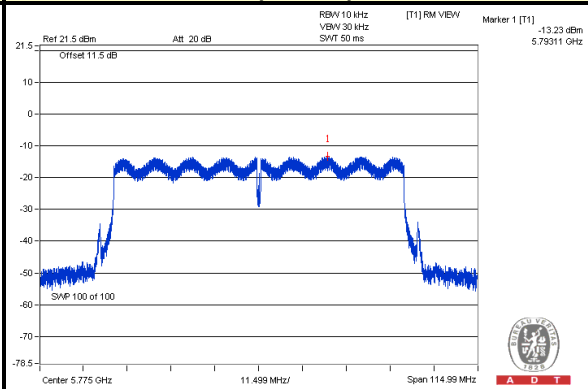

### 802.11ac(VHT20), 2Tx

TX CHAIN	CHANNEL	FREQUENCY (MHz)	PSD (dBm)	10 log (N=2) dB	Total PSD (dBm)	Limit (dBm)	PASS /FAIL
0	149	5745	-10.13	3.01	-7.12	1.5	PASS
	157	5785	-8.49	3.01	-5.48	1.5	PASS
	165	5825	-9.95	3.01	-6.94	1.5	PASS
1	149	5745	-10.99	3.01	-7.98	1.5	PASS
	157	5785	-9.88	3.01	-6.87	1.5	PASS
	165	5825	-9.85	3.01	-6.84	1.5	PASS

Note: The directional gain is 12.5dBi > 6dBi, therefore the limit needs to reduce, so the power density limit shall be reduced to  $8-(12.5-6) = 1.5$ dBm.

### 802.11ac(VHT40), 2Tx

TX CHAIN	CHANNEL	FREQUENCY (MHz)	PSD (dBm)	10 log (N=2) dB	Total PSD (dBm)	Limit (dBm)	PASS /FAIL
0	151	5755	-12.74	3.01	-9.73	1.5	PASS
	159	5795	-12.37	3.01	-9.36	1.5	PASS
1	151	5755	-12.43	3.01	-9.42	1.5	PASS
	159	5795	-12.12	3.01	-9.11	1.5	PASS

Note: The directional gain is 12.5dBi > 6dBi, therefore the limit needs to reduce, so the power density limit shall be reduced to  $8-(12.5-6) = 1.5$ dBm.

### 802.11ac(VHT80), 2Tx

TX CHAIN	CHANNEL	FREQUENCY (MHz)	PSD (dBm)	10 log (N=2) dB	Total PSD (dBm)	Limit (dBm)	PASS /FAIL
0	155	5775	-15.66	3.01	-12.65	1.5	PASS
1	155	5775	-14.79	3.01	-11.78	1.5	PASS

Note: The directional gain is 12.5dBi > 6dBi, therefore the limit needs to reduce, so the power density limit shall be reduced to  $8-(12.5-6) = 1.5$ dBm.



A D T

### SPECTRUM PLOT OF WORST VALUE

802.11ac (VHT20) / Chain(0) : CH157

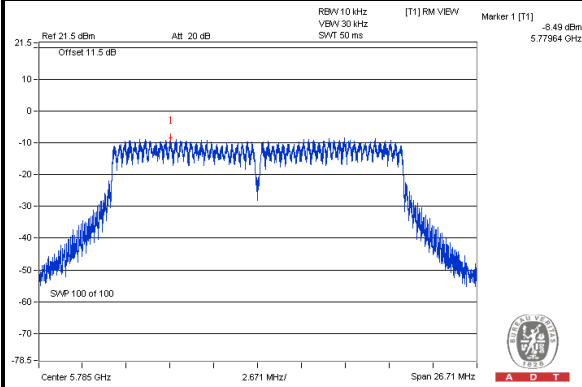

802.11ac (VHT40) / Chain(1) : CH159

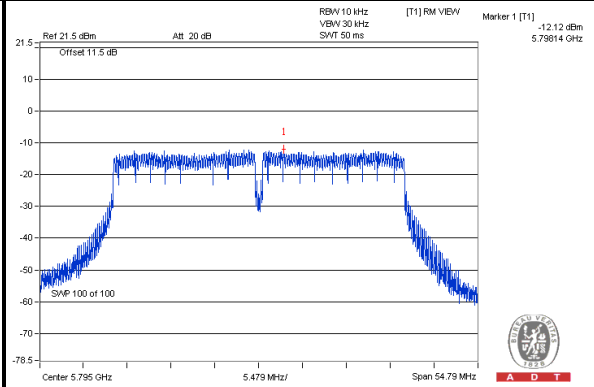

802.11ac (VHT80) / Chain(1) : CH155

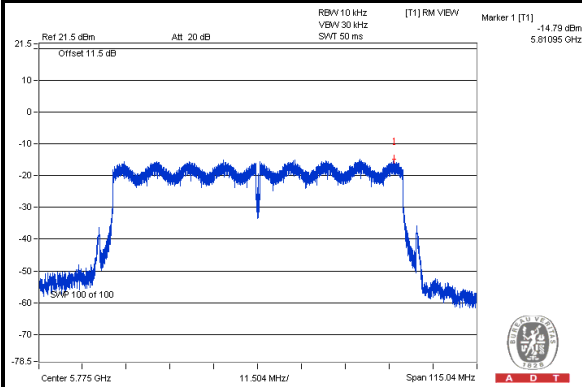

## 5.6 CONDUCTED OUT-BAND EMISSION MEASUREMENT

### 5.6.1 LIMITS OF CONDUCTED OUT-BAND EMISSION MEASUREMENT

Below 30dB of the highest emission level of operating band (in 100kHz Resolution Bandwidth).

### 5.6.2 TEST INSTRUMENTS

DESCRIPTION & MANUFACTURER	MODEL NO.	SERIAL NO.	CALIBRATED DATE	CALIBRATED UNTIL
Spectrum Analyzer R&S	FSV 40	100964	July 15, 2013	July 14, 2014

**Note:**

1. The calibration interval of the above test instruments is 12 months and the calibrations are traceable to NML/ROC and NIST/USA.
2. Tested date : Apr. 08, 2014

### 5.6.3 TEST PROCEDURE

**Measurement Procedure - Reference Level**

1. Set the RBW = 100 kHz.
2. Set the VBW  $\geq$  300 kHz.
3. Detector = peak.
4. Sweep time = auto couple.
5. Trace mode = max hold.
6. Allow trace to fully stabilize.
7. Use the peak marker function to determine the maximum power level in any 100 kHz band segment within the fundamental EBW.

**Measurement Procedure –Unwanted Emission Level**

1. Set RBW = 100 kHz.
2. Set VBW  $\geq$  300 kHz.
3. Set span to encompass the spectrum to be examined
4. Detector = peak.
5. Trace Mode = max hold.
6. Sweep = auto couple.

#### 5.6.4 DEVIATION FROM TEST STANDARD

No deviation

#### 5.6.5 TEST SETUP



#### 5.6.6 EUT OPERATING CONDITION

Same as Item 4.3.6

#### 5.6.7 TEST RESULTS (MODE 1)

The spectrum plots are attached on the following pages. D1 line indicates the highest level, and D2 line indicates the 30dB offset below D1. It shows compliance with the requirement.





A D T

802.11a, 1Tx:

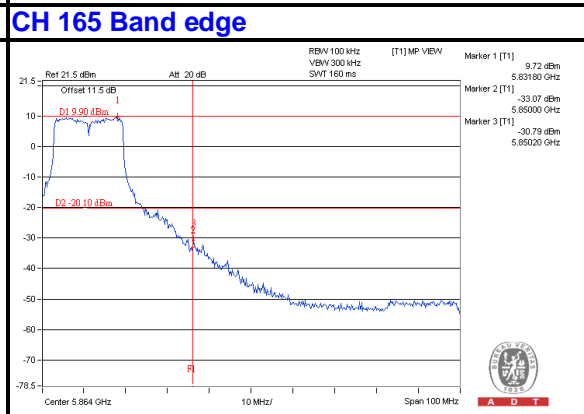
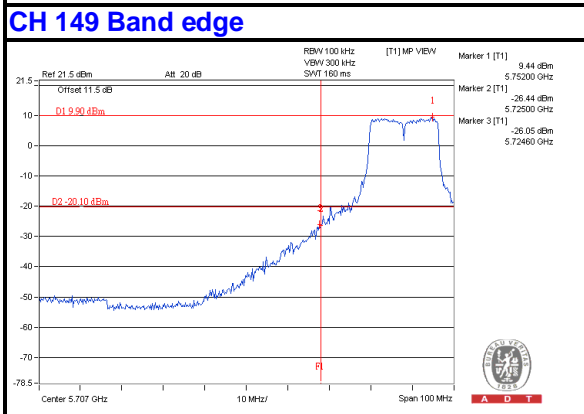
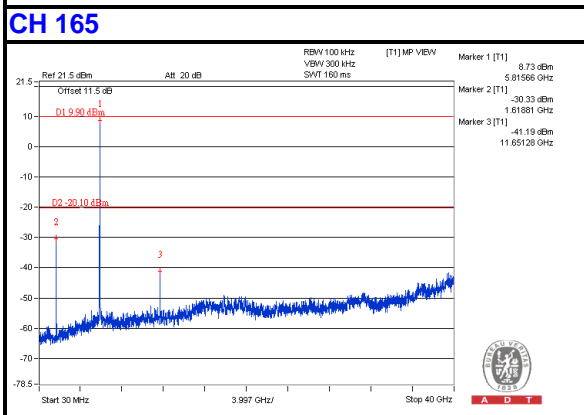
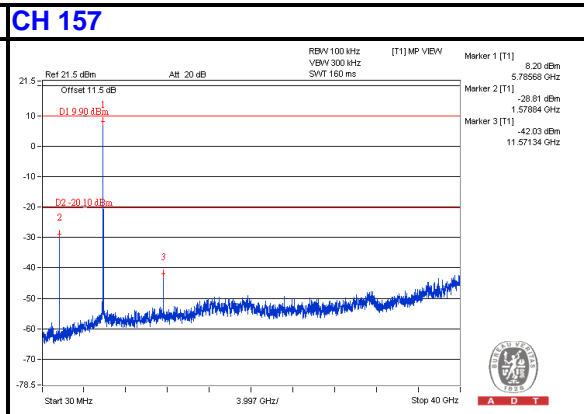
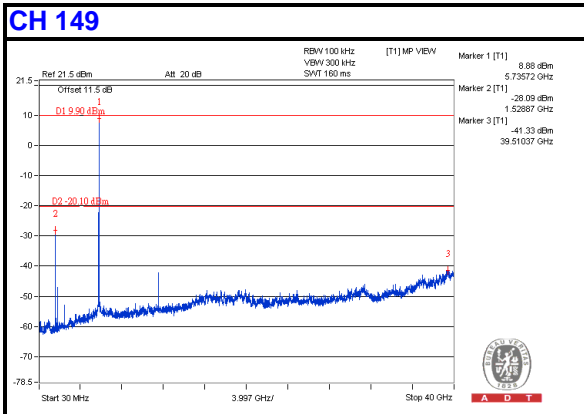
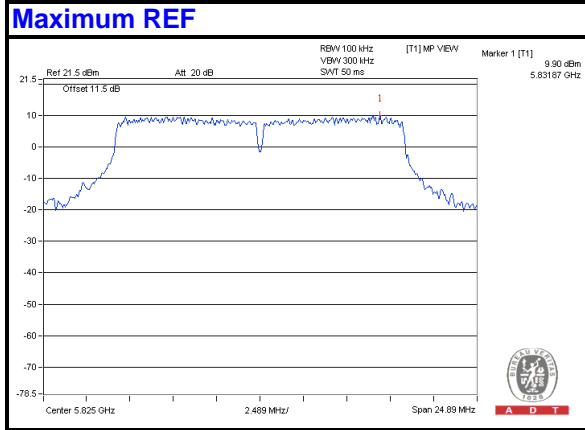



A D T

### 802.11ac(VHT20), 1Tx:

#### Maximum REF

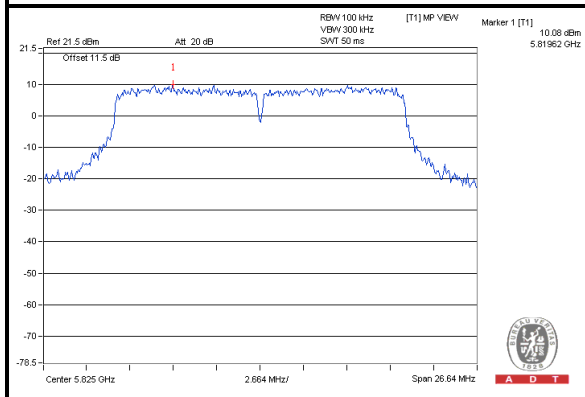

#### CH 149

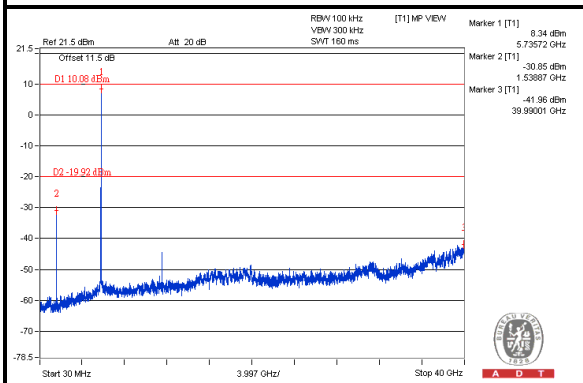

#### CH 157

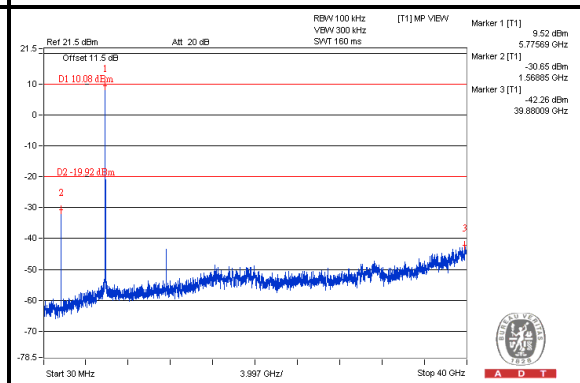

#### CH 165

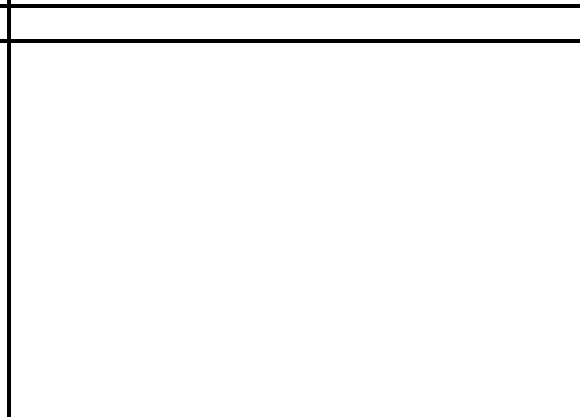
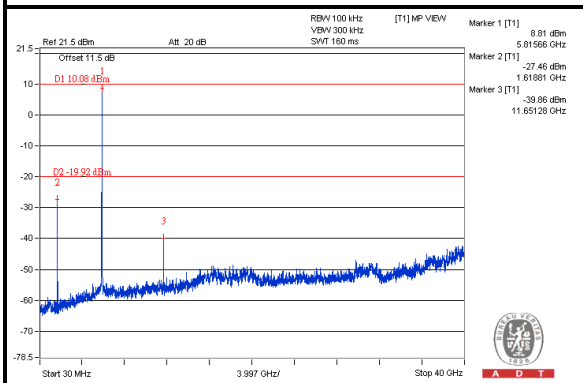

#### CH 149 Band edge

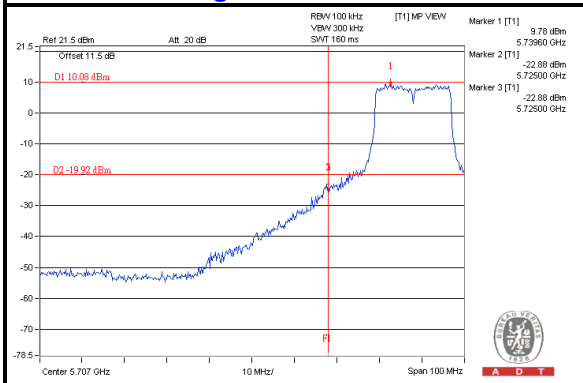

#### CH 165 Band edge

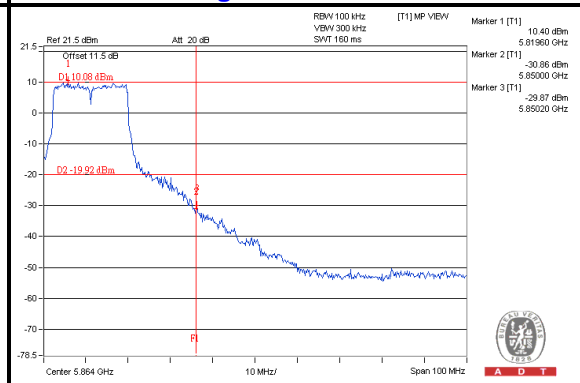



A D T

### 802.11ac(VHT40), 1Tx:

#### Maximum REF

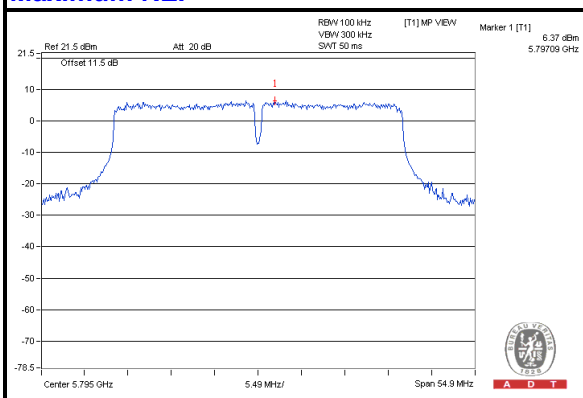

#### CH 151

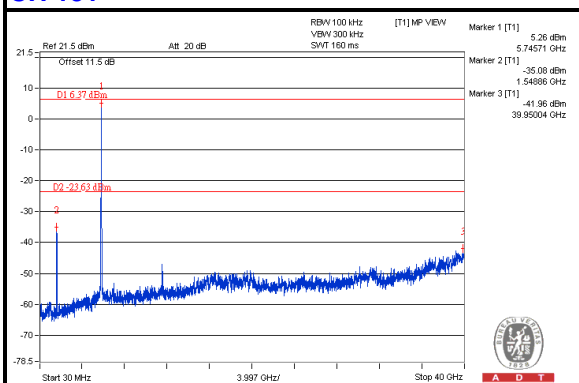

#### CH 159

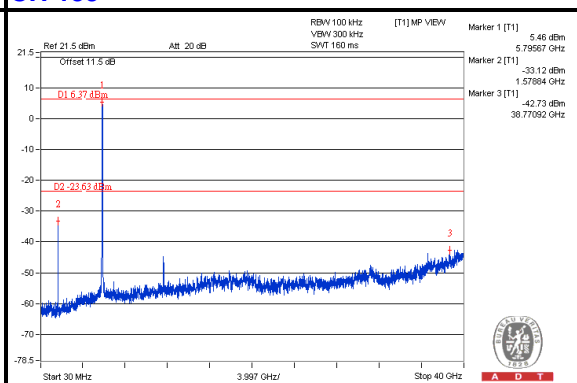

#### CH 151 Band edge

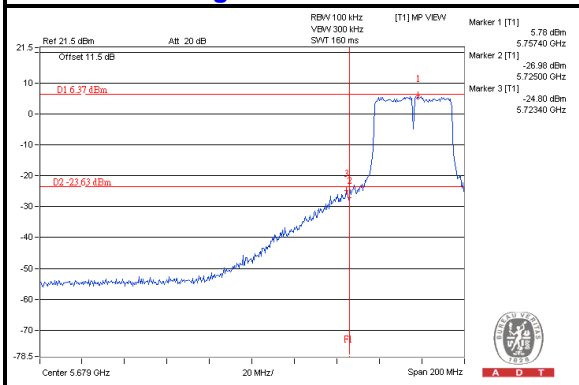

#### CH 159 Band edge

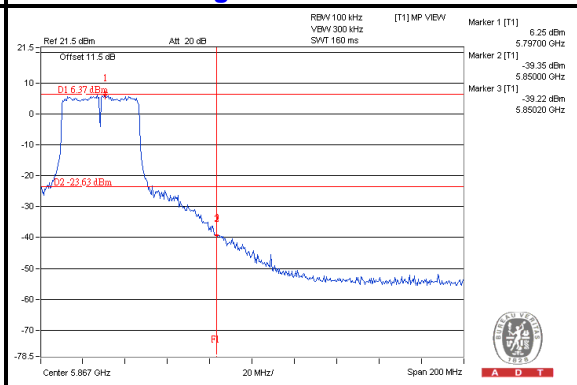



A D T

### 802.11ac(VHT80), 1Tx:

#### Maximum REF

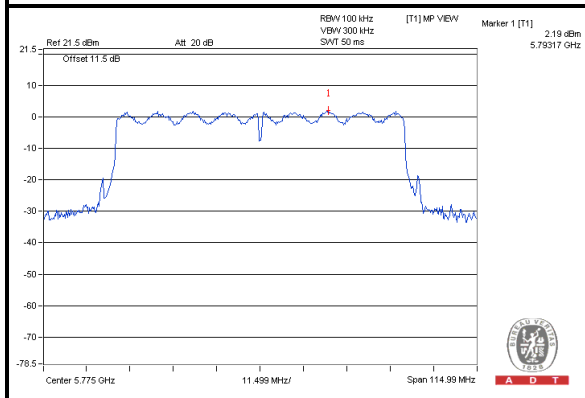

#### CH 155

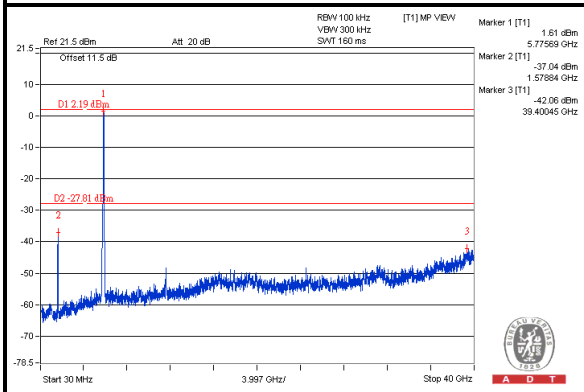

#### CH 155 Band edge

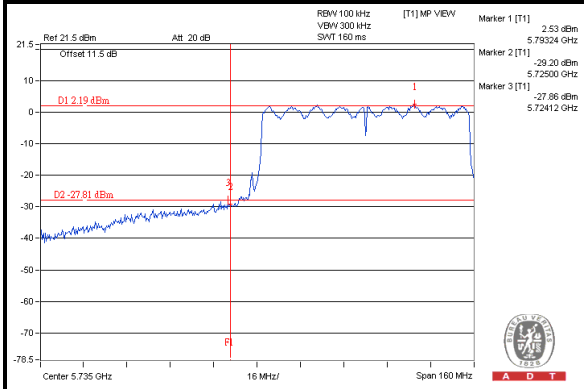

#### CH 155 Band edge

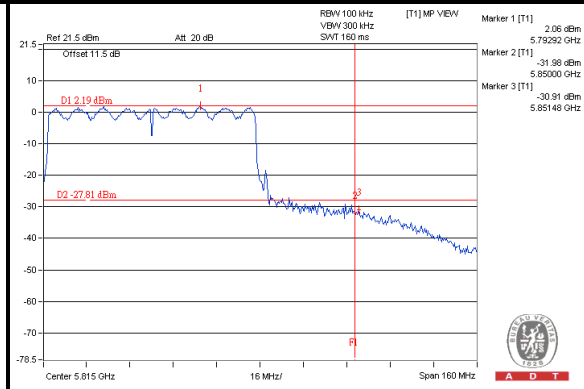



A D T

### 802.11ac(VHT20), 2Tx:

#### Maximum REF

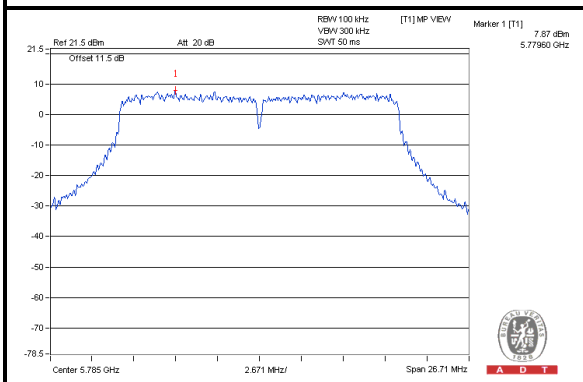

#### Chain 0

##### CH 149

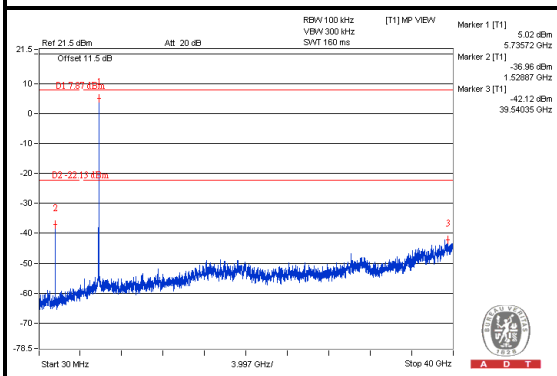

##### CH 157

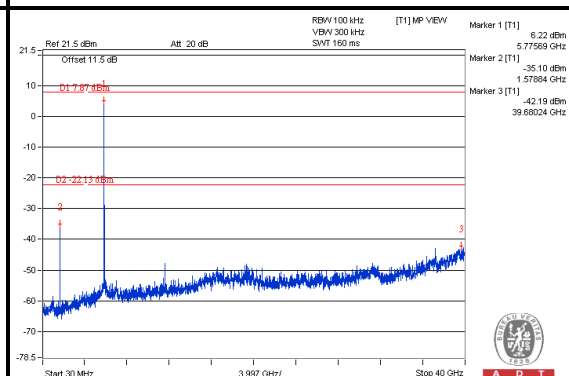

##### CH 165

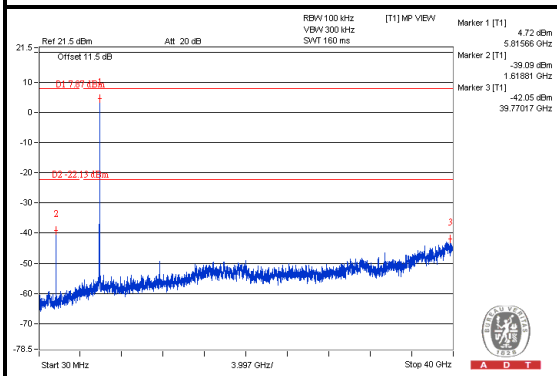

##### CH 149 Band edge

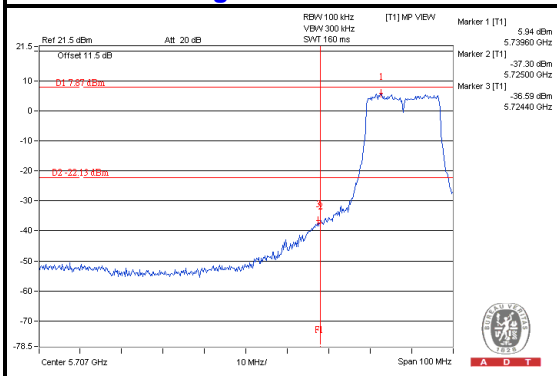

##### CH 165 Band edge

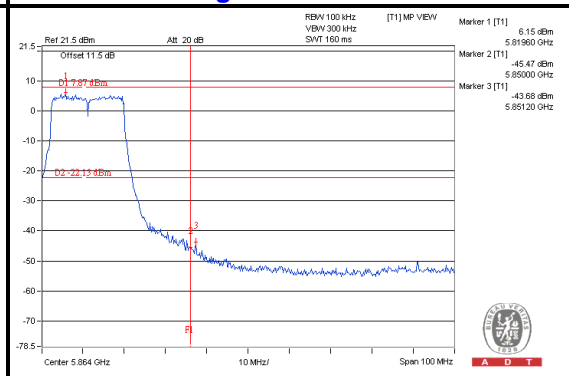



A D T

### Chain 1 CH 149

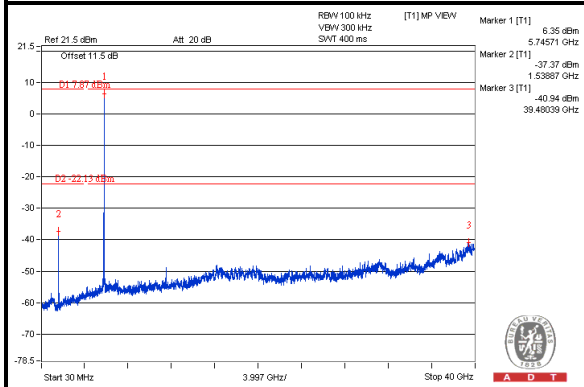

### CH 157

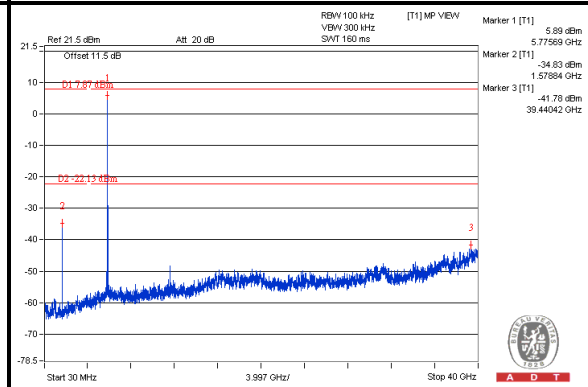

### CH 165

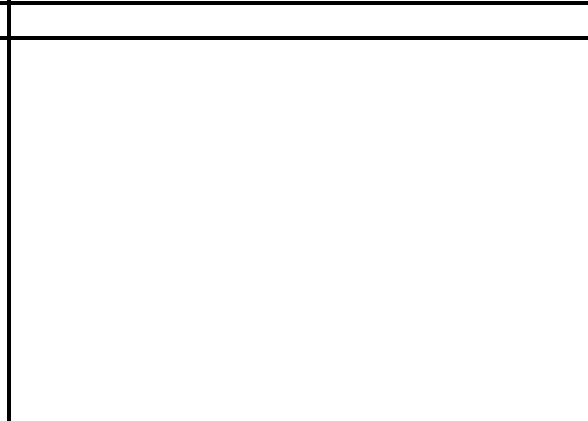
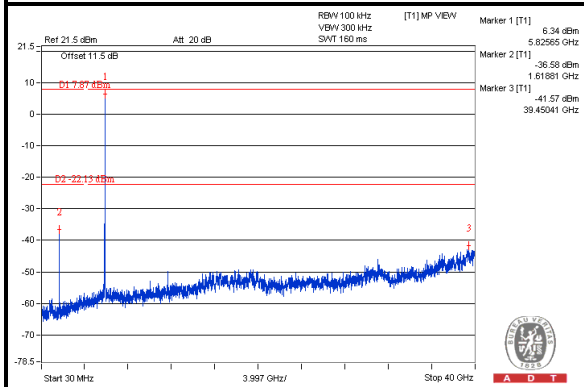

### CH 149 Band edge

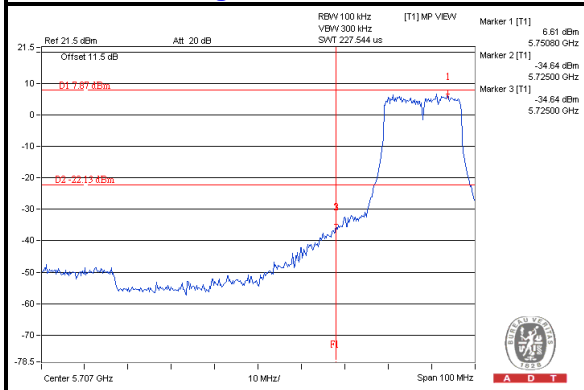

### CH 165 Band edge

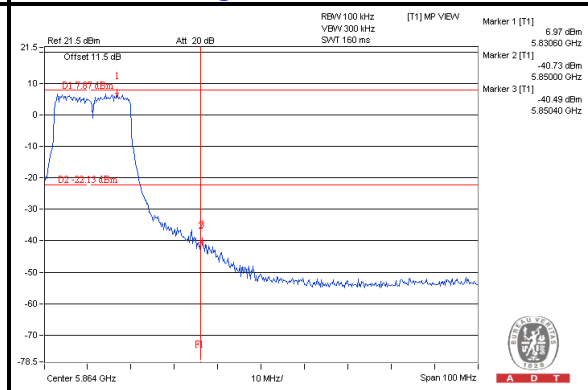

802.11ac(VHT40), 2Tx:

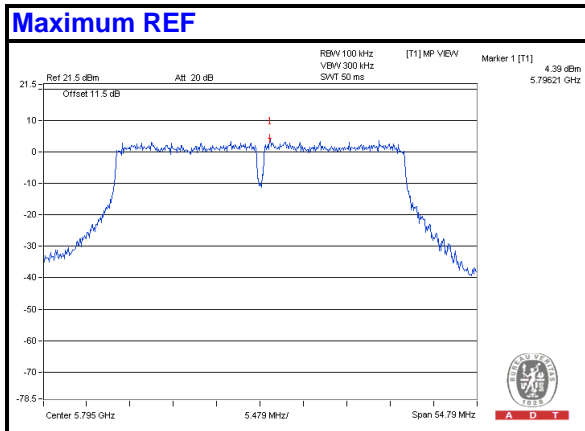

### Chain 0 CH 151

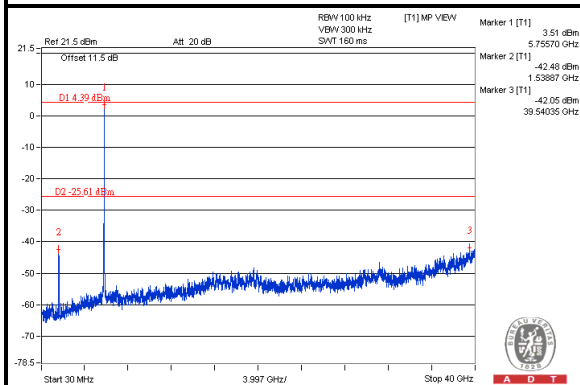

### CH 159

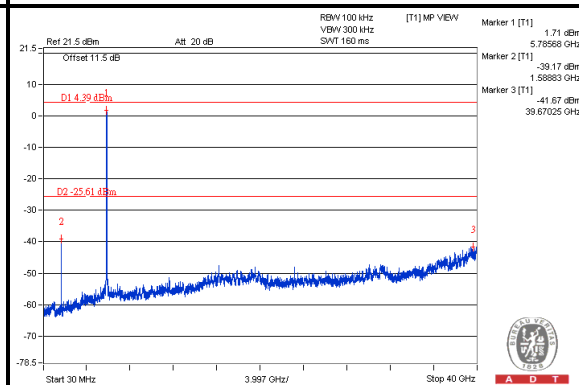

### CH 151 Band edge

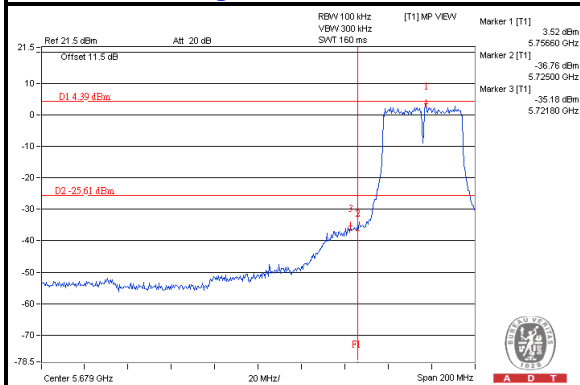

### CH 159 Band edge

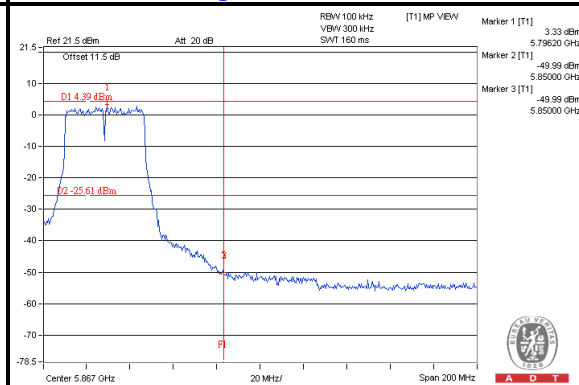



A D T

### Chain 1

#### CH 151

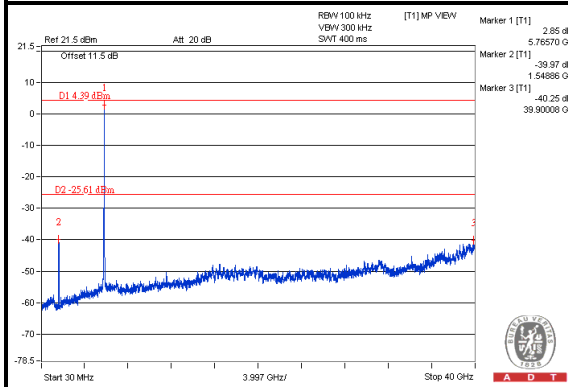

#### CH 159

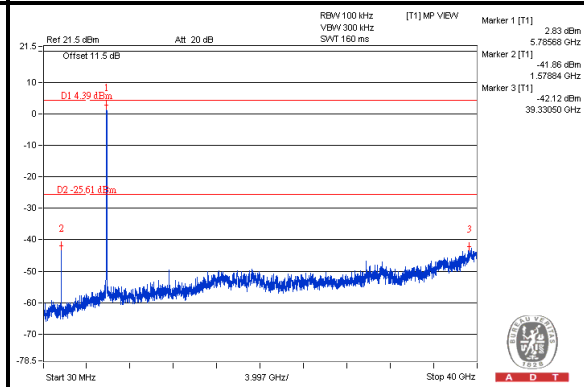

#### CH 151 Band edge

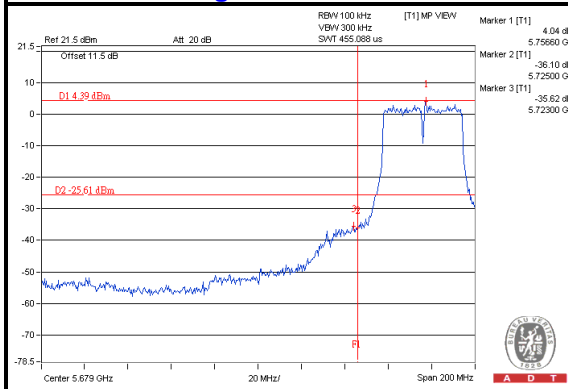

#### CH 159 Band edge

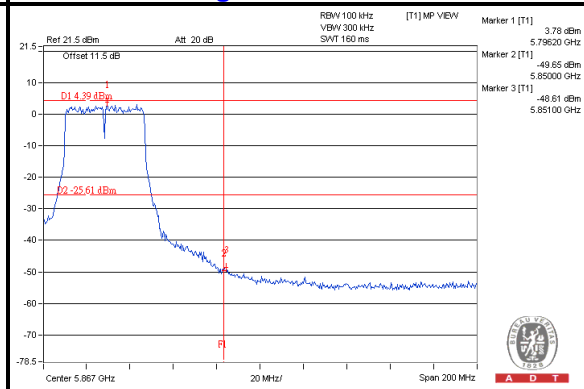





A D T

### 802.11ac(VHT80), 2Tx:

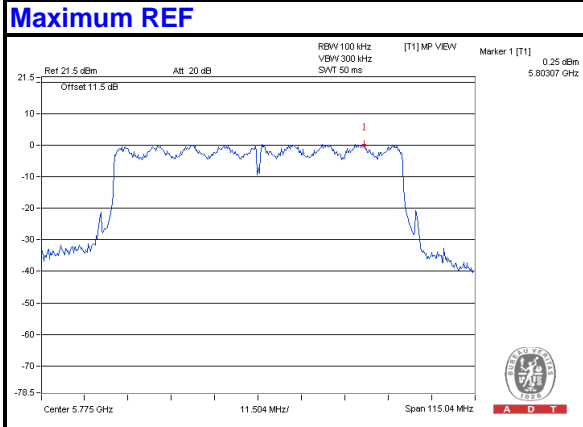

### Chain 0

### CH 155

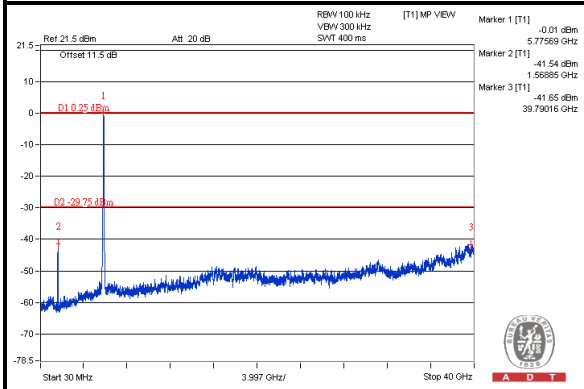

### CH 155 Band edge

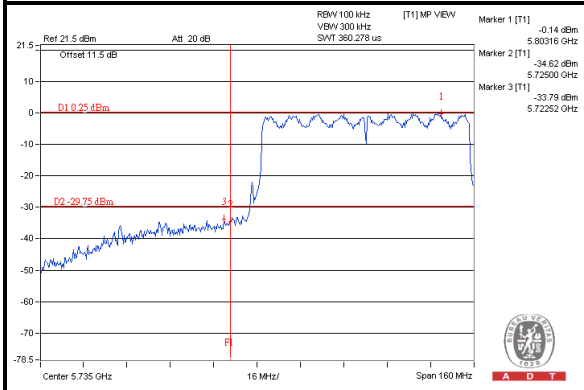

### CH 155 Band edge

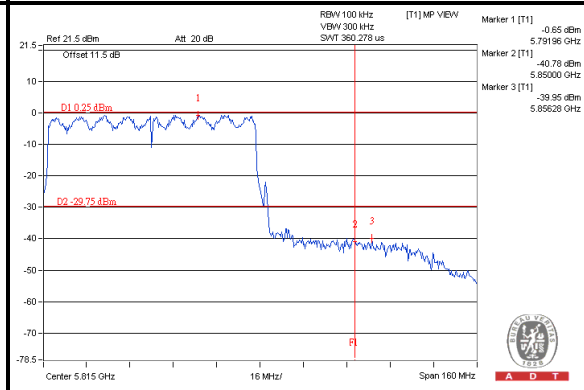



A D T

### Chain 1 CH 155

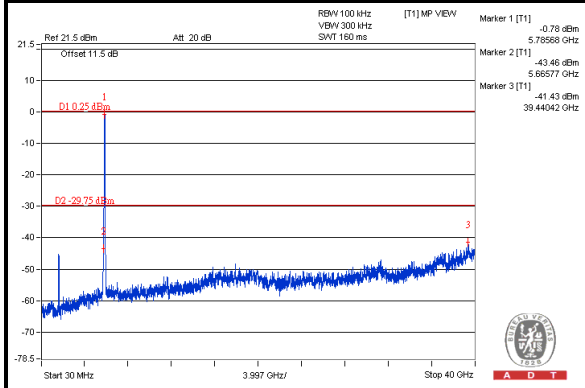

### CH 155 Band edge

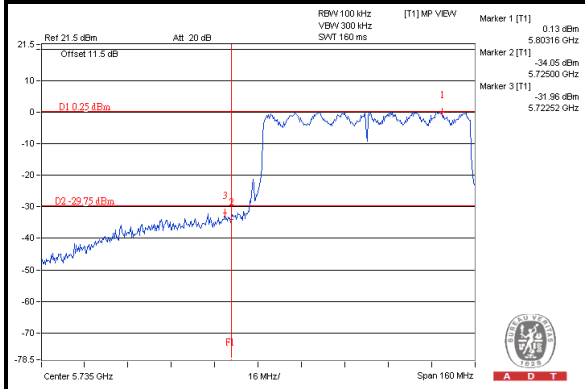

### CH 155 Band edge

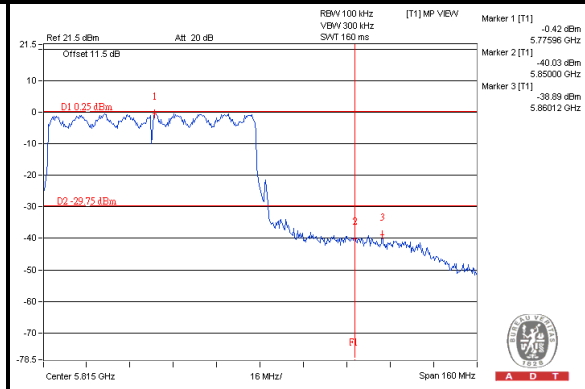



### 5.6.8 TEST RESULTS (MODE 2)

The spectrum plots are attached on the following pages. D1 line indicates the highest level, and D2 line indicates the 30dB offset below D1. It shows compliance with the requirement.



A D T

### 802.11a, 1Tx:

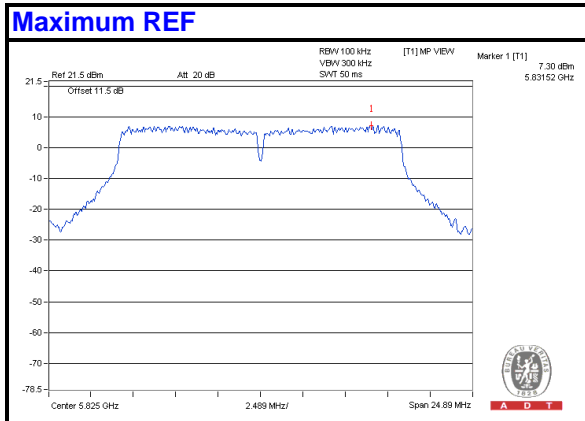

### CH 149

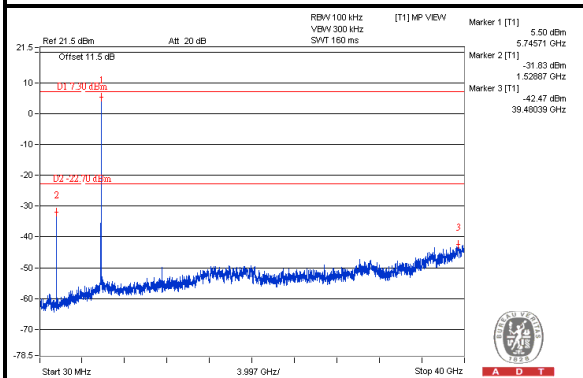

### CH 157

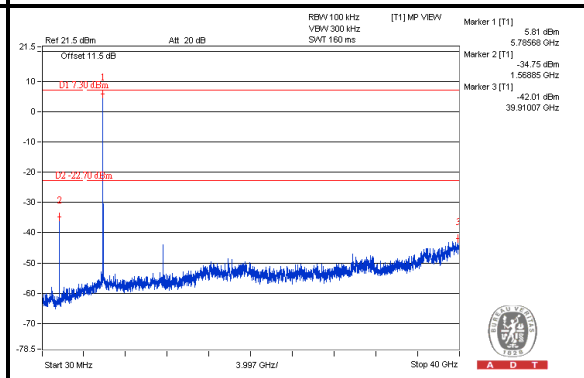

### CH 165

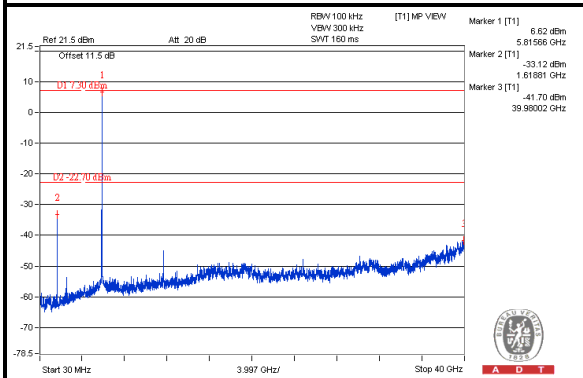

### CH 149 Band edge

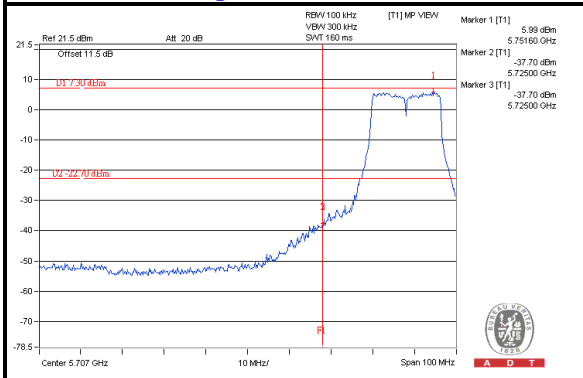

### CH 165 Band edge

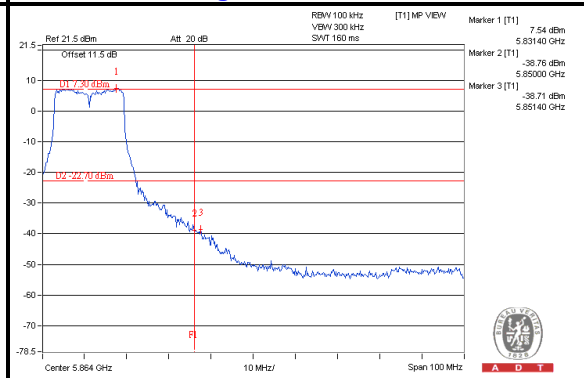



A D T

### 802.11ac(VHT20), 1Tx:

#### Maximum REF

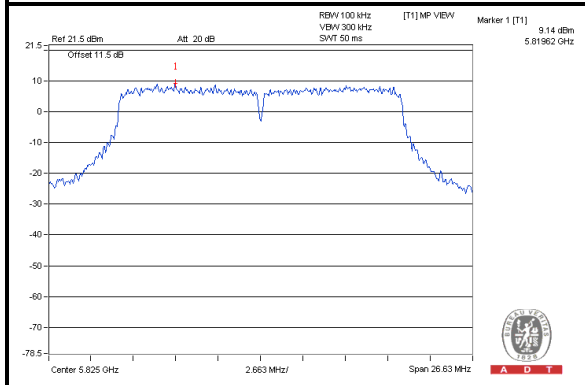

#### CH 149

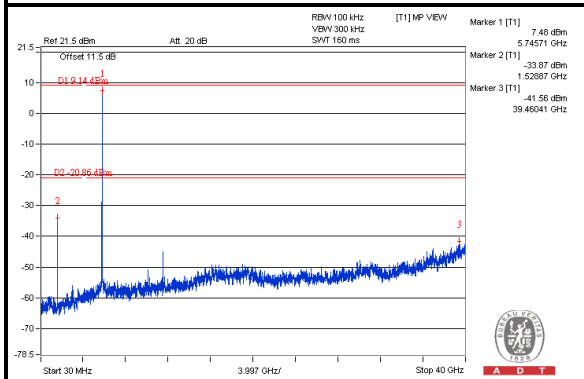

#### CH 157

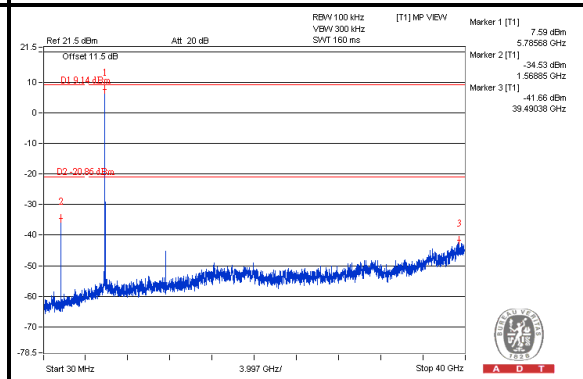

#### CH 165

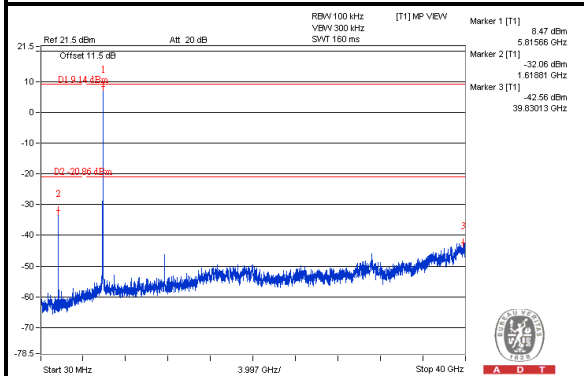

#### CH 149 Band edge

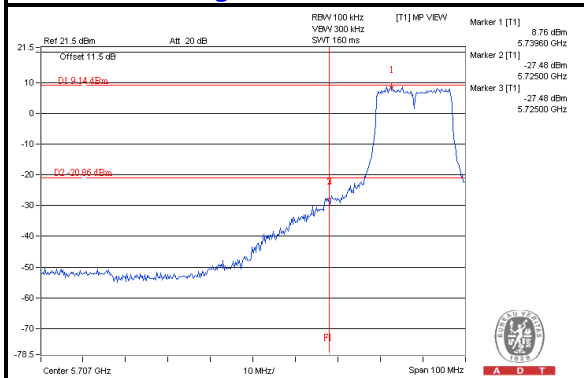

#### CH 165 Band edge

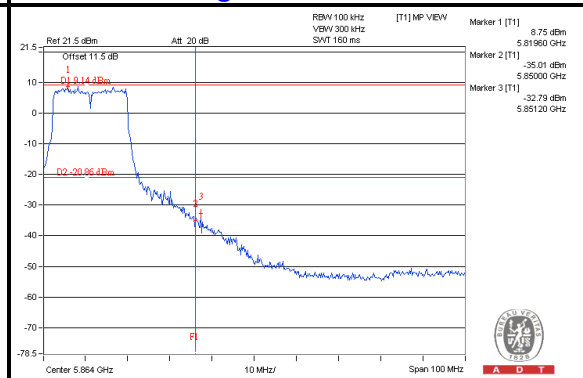



A D T

### 802.11ac(VHT40), 1Tx:

#### Maximum REF

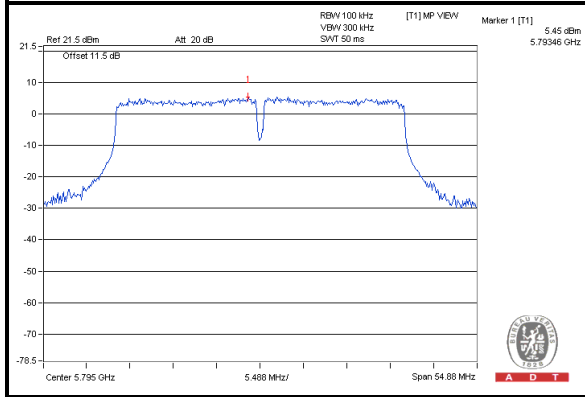

#### CH 151

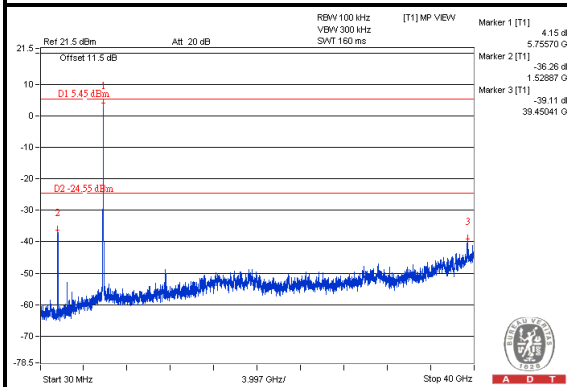

#### CH 159

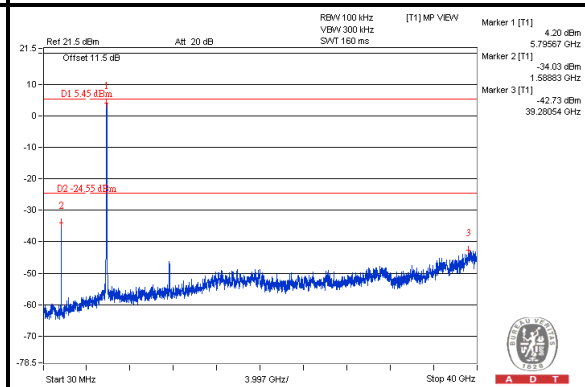

#### CH 151 Band edge

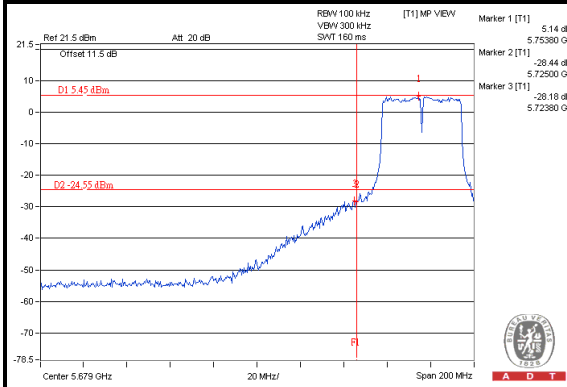

#### CH 159 Band edge

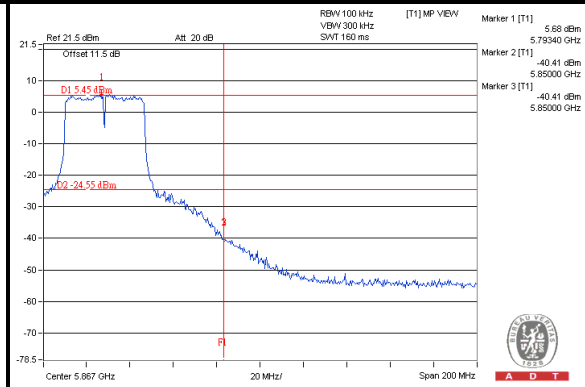



A D T

### 802.11ac(VHT80), 1Tx:

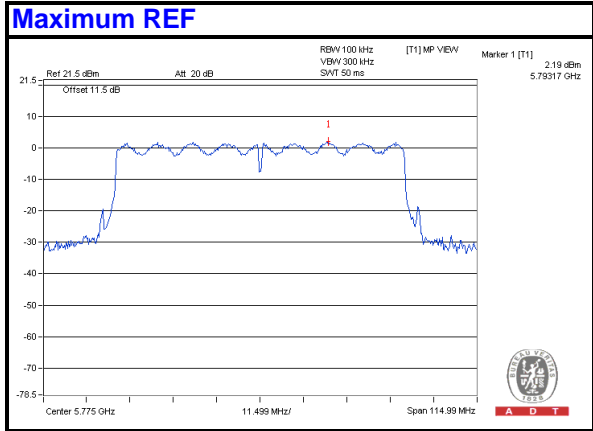

### CH 155

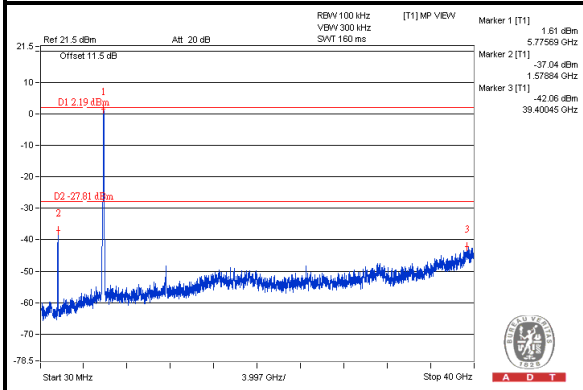

### CH 155 Band edge

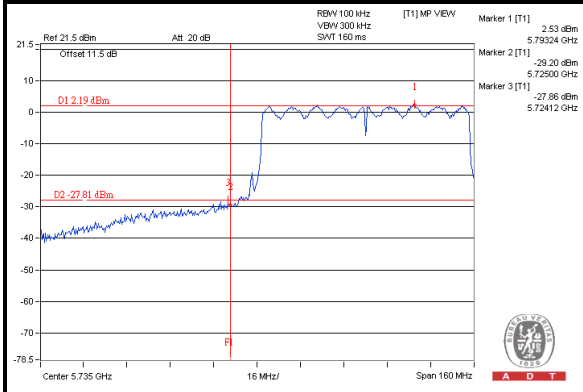

### CH 155 Band edge

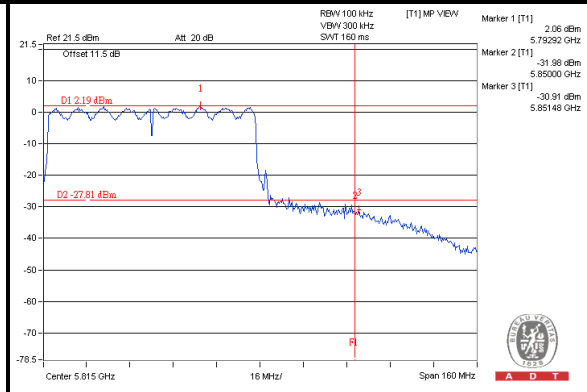



A D T

### 802.11ac(VHT20), 2Tx:

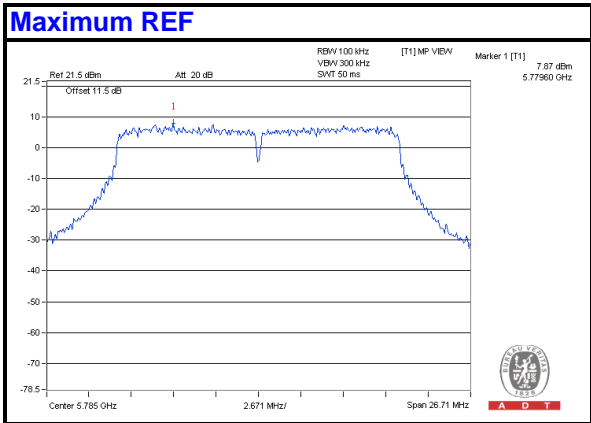

### Chain 0 CH 149

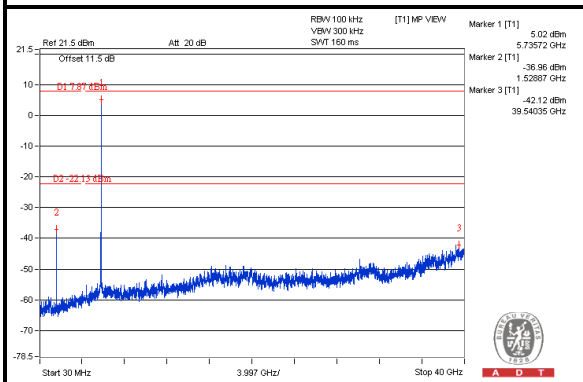

### CH 157

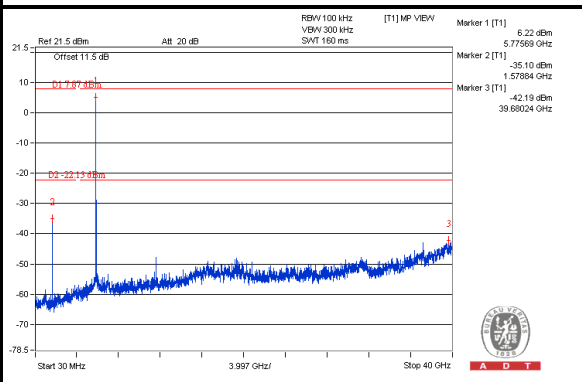

### CH 165

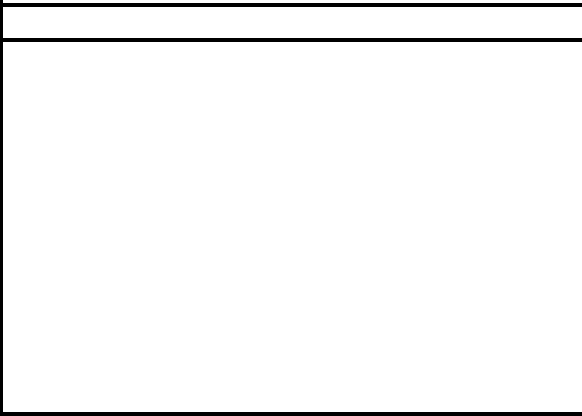
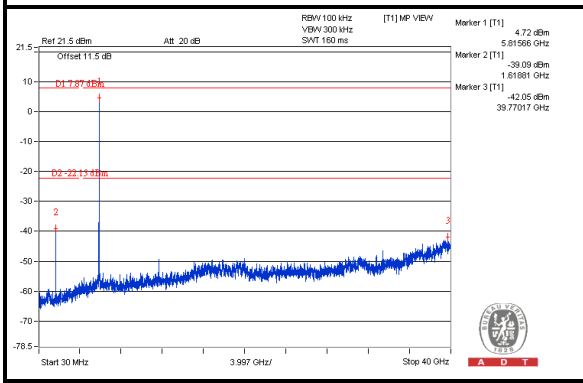

### CH 149 Band edge

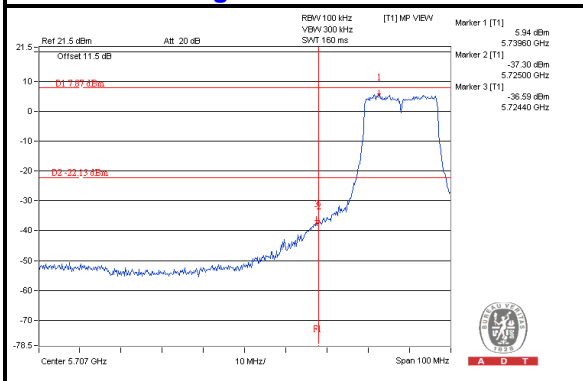

### CH 165 Band edge

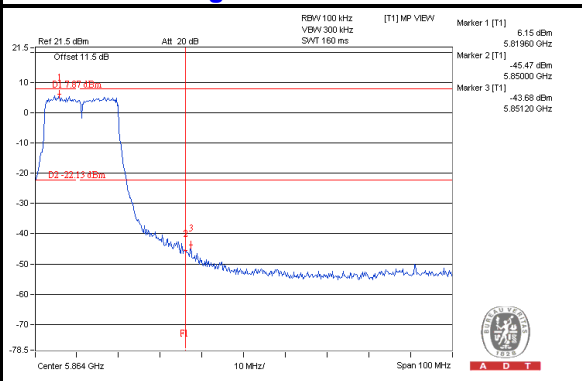





A D T

### Chain 1 CH 149

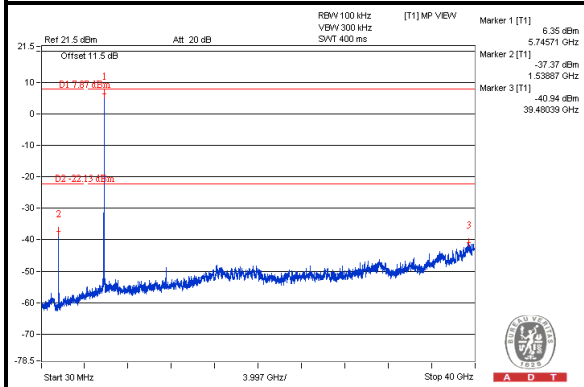

### CH 157

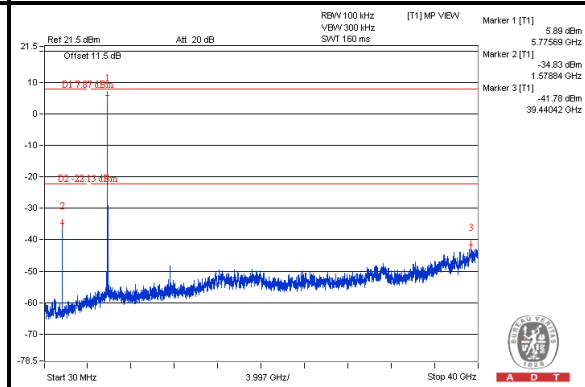

### CH 165

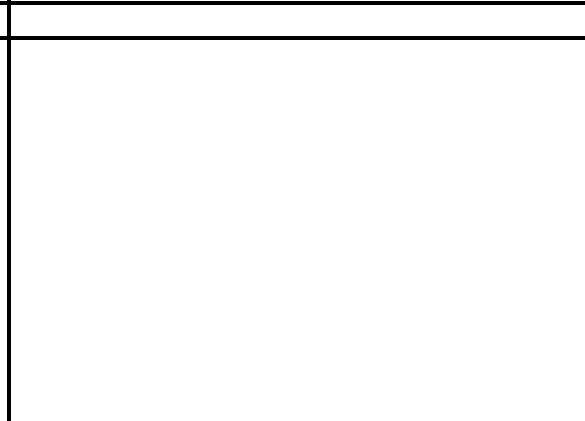
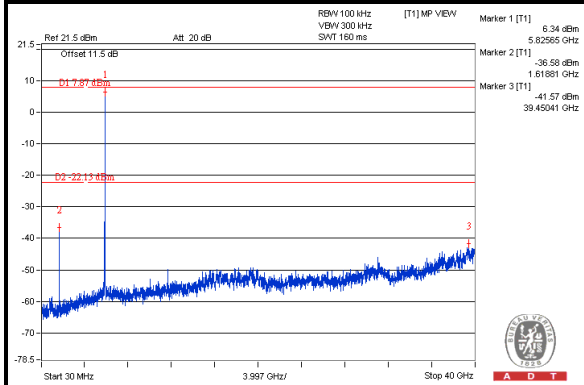

### CH 149 Band edge

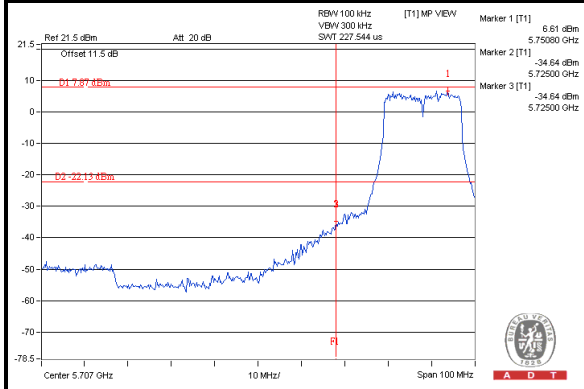

### CH 165 Band edge

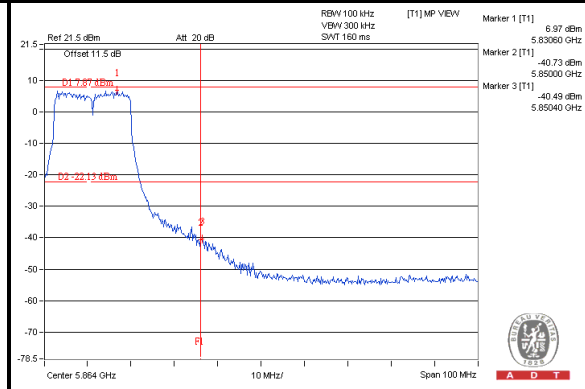



A D T

### 802.11ac(VHT40), 2Tx:

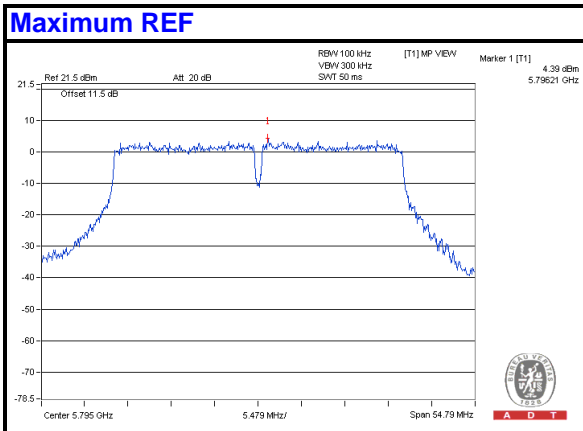

### Chain 0 CH 151

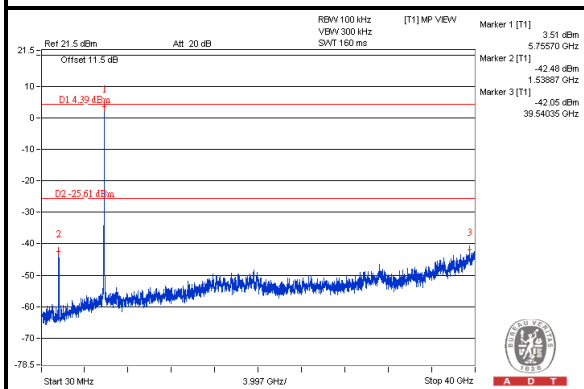

### CH 159

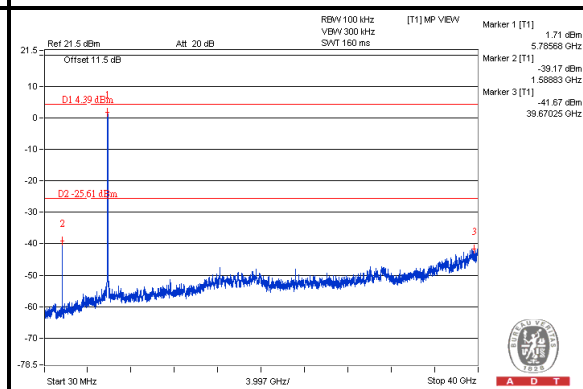

### CH 151 Band edge

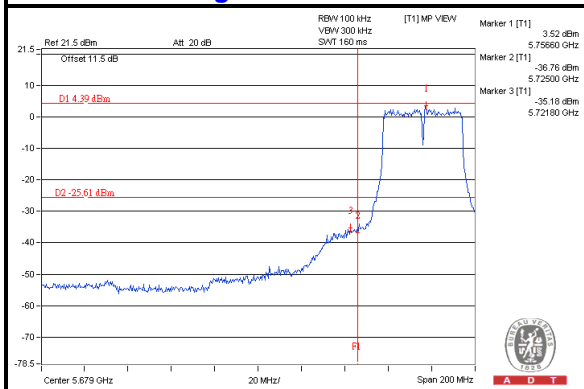

### CH 159 Band edge

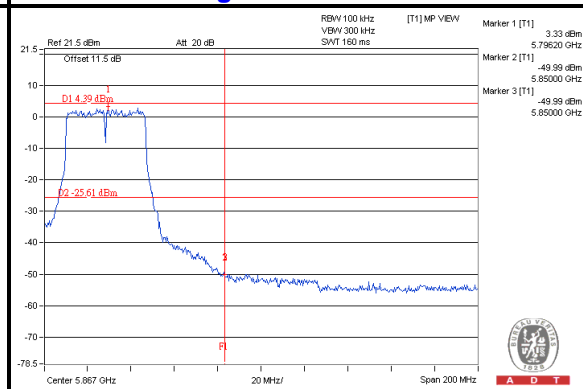



A D T

### Chain 1

#### CH 151

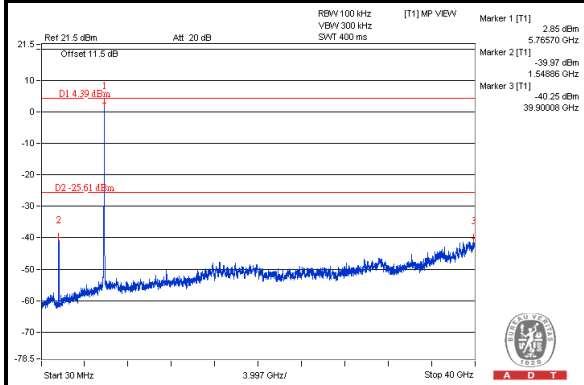

#### CH 159

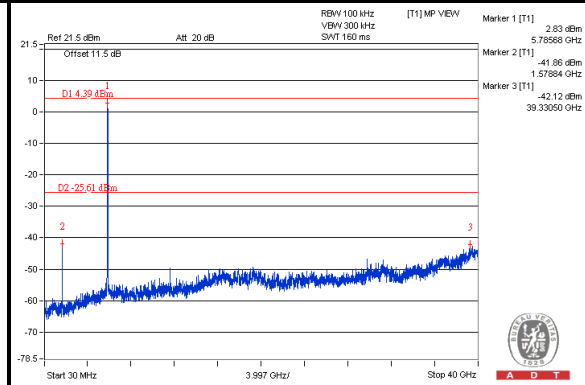

#### CH 151 Band edge

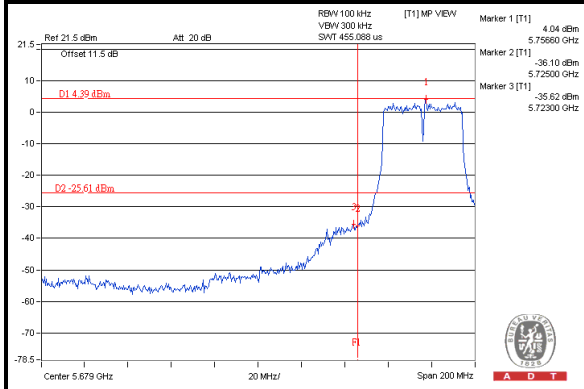

#### CH 159 Band edge

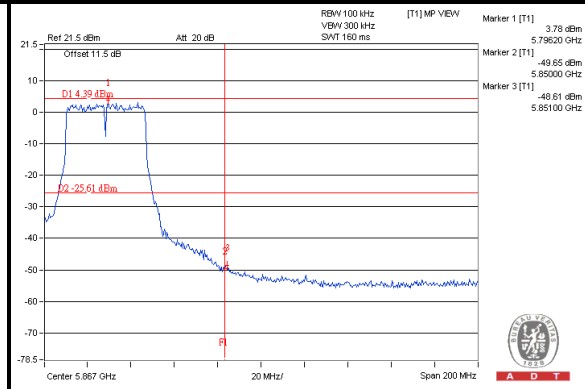



A D T

### 802.11ac(VHT80), 2Tx:

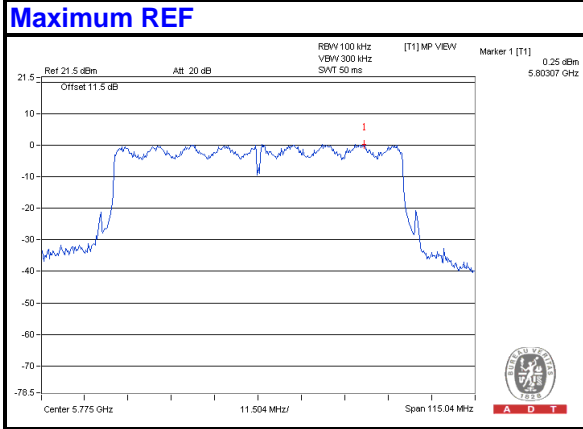

### Chain 0

### CH 155

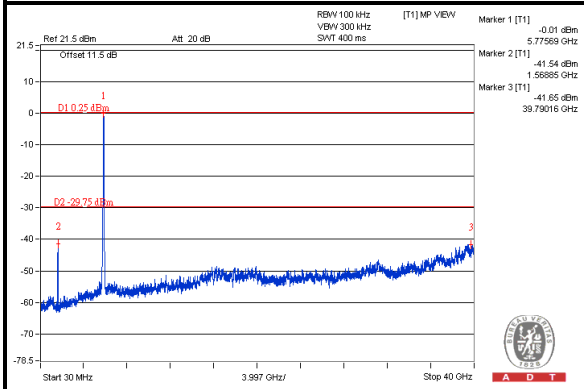

### CH 155 Band edge

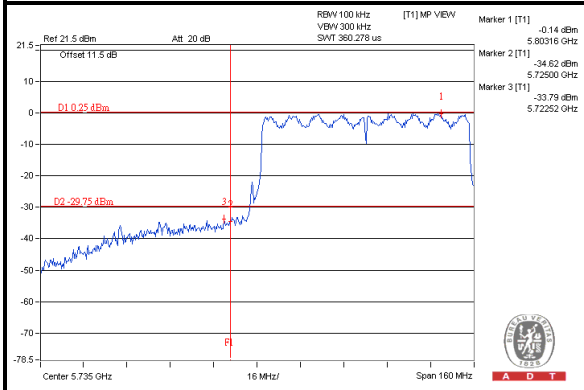

### CH 155 Band edge

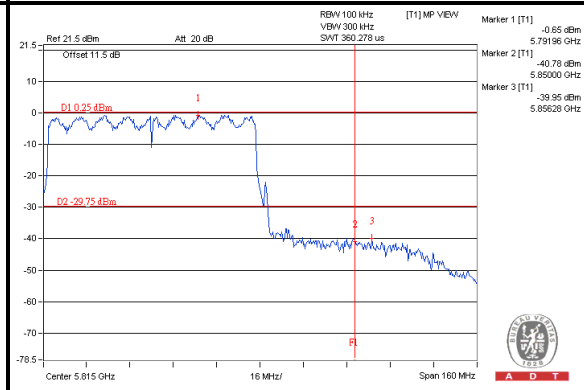



A D T

### Chain 1 CH 155

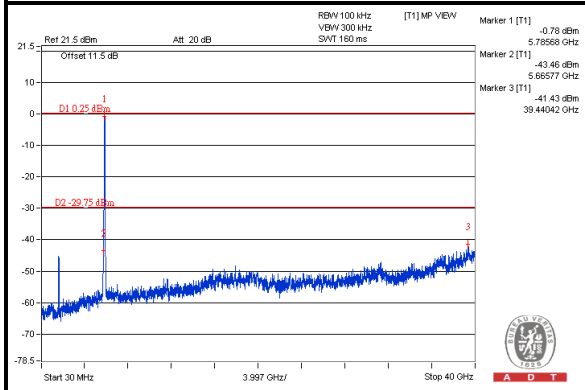

### CH 155 Band edge

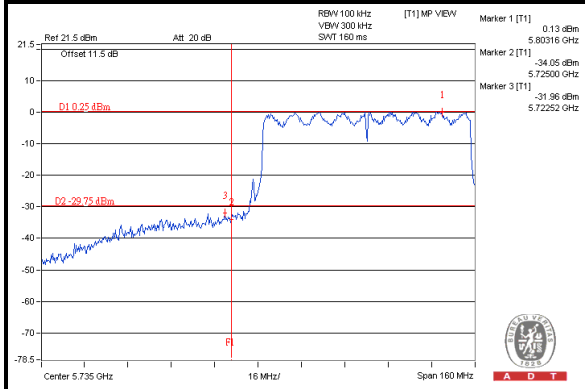

### CH 155 Band edge

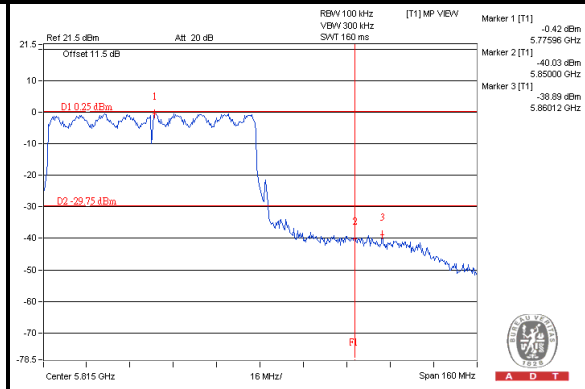



A D T

## 6. PHOTOGRAPHS OF THE TEST CONFIGURATION

Please refer to the attached file (Test Setup Photo).



## 7. INFORMATION ON THE TESTING LABORATORIES

We, Bureau Veritas Consumer Products Services (H.K.) Ltd., Taoyuan Branch, were founded in 1988 to provide our best service in EMC, Radio, Telecom and Safety consultation. Our laboratories are accredited and approved according to ISO/IEC 17025.

If you have any comments, please feel free to contact us at the following:

**Linko EMC/RF Lab:**

Tel: 886-2-26052180

Fax: 886-2-26052943

**Hsin Chu EMC/RF Lab:**

Tel: 886-3-5935343

Fax: 886-3-5935342

**Hwa Ya EMC/RF/Safety/Telecom Lab:**

Tel: 886-3-3183232

Fax: 886-3-3270892

**Email:** [service.adt@tw.bureauveritas.com](mailto:service.adt@tw.bureauveritas.com)

**Web Site:** [www.bureauveritas-adt.com](http://www.bureauveritas-adt.com)

The address and road map of all our labs can be found in our web site also.



A D T

## 8. APPENDIX A - MODIFICATIONS RECORDERS FOR ENGINEERING CHANGES TO THE EUT BY THE LAB

No modifications were made to the EUT by the lab during the test.

--- END ---