

FCC Test Report

Report No.: RF180903E08-1

FCC ID: YZKECWO5212L

Test Model: ECWO5212-L

Received Date: Sep. 03, 2018

Test Date: Oct. 03 to 10, 2018

Issued Date: Nov. 08, 2018

Applicant: Edgecore Networks Corporation

Address: No.1, Creation 3rd Rd., Hsinchu Science Park, East Dist., Hsinchu City
30077, Taiwan, R.O.C

Issued By: Bureau Veritas Consumer Products Services (H.K.) Ltd., Taoyuan Branch
Hsin Chu Laboratory

Lab Address: E-2, No.1, Li Hsin 1st Road, Hsinchu Science Park, Hsinchu City 300,
Taiwan R.O.C.

Test Location : E-2, No.1, Li Hsin 1st Road, Hsinchu Science Park, Hsinchu City 300,
Taiwan R.O.C.

**FCC Registration /
Designation Number:** 723255 / TW2022



This report is for your exclusive use. Any copying or replication of this report to or for any other person or entity, or use of our name or trademark, is permitted only with our prior written permission. This report sets forth our findings solely with respect to the test samples identified herein. The results set forth in this report are not indicative or representative of the quality or characteristics of the lot from which a test sample was taken or any similar or identical product unless specifically and expressly noted. Our report includes all of the tests requested by you and the results thereof based upon the information that you provided to us. You have 60 days from date of issuance of this report to notify us of any material error or omission caused by our negligence, provided, however, that such notice shall be in writing and shall specifically address the issue you wish to raise. A failure to raise such issue within the prescribed time shall constitute your unqualified acceptance of the completeness of this report, the tests conducted and the correctness of the report contents. Unless specific mention, the uncertainty of measurement has been explicitly taken into account to declare the compliance or non-compliance to the specification. The report must not be used by the client to claim product certification, approval, or endorsement by TAF or any government agencies.

Table of Contents

Release Control Record	4
1 Certificate of Conformity	5
2 Summary of Test Results	6
2.1 Measurement Uncertainty	6
2.2 Modification Record	6
3 General Information	7
3.1 General Description of EUT	7
3.2 Description of Test Modes	9
3.2.1 Test Mode Applicability and Tested Channel Detail	10
3.3 Duty Cycle of Test Signal	12
3.4 Description of Support Units	13
3.4.1 Configuration of System under Test	14
3.5 General Description of Applied Standard	16
4 Test Types and Results	17
4.1 Radiated Emission and Bandedge Measurement	17
4.1.1 Limits of Radiated Emission and Bandedge Measurement	17
4.1.2 Test Instruments	18
4.1.3 Test Procedure	19
4.1.4 Deviation from Test Standard	19
4.1.5 Test Setup	20
4.1.6 EUT Operating Condition	21
4.1.7 Test Results	22
4.2 Conducted Emission Measurement	42
4.2.1 Limits of Conducted Emission Measurement	42
4.2.2 Test Instruments	42
4.2.3 Test Procedure	43
4.2.4 Deviation from Test Standard	43
4.2.5 Test Setup	43
4.2.6 EUT Operating Condition	43
4.2.7 Test Results	44
4.3 Transmit Power Measurement	46
4.3.1 Limits of Transmit Power Measurement	46
4.3.2 Test Setup	47
4.3.3 Test Instruments	47
4.3.4 Test Procedure	47
4.3.5 Deviation from Test Standard	47
4.3.6 EUT Operating Condition	47
4.3.7 Test Result	48
4.4 Occupied Bandwidth Measurement	49
4.4.1 Test Setup	49
4.4.2 Test Instruments	49
4.4.3 Test Procedure	49
4.4.4 Test Results	50
4.5 Peak Power Spectral Density Measurement	56
4.5.1 Limits of Peak Power Spectral Density Measurement	56
4.5.2 Test Setup	56
4.5.3 Test Instruments	56
4.5.4 Test Procedure	57
4.5.5 Deviation from Test Standard	57
4.5.6 EUT Operating Condition	57
4.5.7 Test Results	58
4.6 Frequency Stability Measurement	64
4.6.1 Limits of Frequency Stability Measurement	64

4.6.2	Test Setup.....	64
4.6.3	Test Instruments	64
4.6.4	Test Procedure	64
4.6.5	Deviation from Test Standard	64
4.6.6	EUT Operating Condition	64
4.6.7	Test Results	65
4.7	6dB Bandwidth Measurement	66
4.7.1	Limits of 6dB Bandwidth Measurement.....	66
4.7.2	Test Setup.....	66
4.7.3	Test Instruments	66
4.7.4	Test Procedure	66
4.7.5	Deviation from Test Standard	66
4.7.6	EUT Operating Condition	66
4.7.7	Test Results	67
5	Pictures of Test Arrangements.....	69
	Annex A- Radiated Out of Band Emission (OOBE) Measurement (For U-NII-3 band)	70
	Appendix – Information on the Testing Laboratories	73

Release Control Record

Issue No.	Description	Date Issued
RF180903E08-1	Original release.	Nov. 08, 2018

1 Certificate of Conformity

Product: 11ac dual band IP68 Access Point with external antenna

Brand: Edgecore

Test Model: ECWO5212-L

Sample Status: ENGINEERING SAMPLE

Applicant: Edgecore Networks Corporation

Test Date: Oct. 03 to 10, 2018

Standard: 47 CFR FCC Part 15, Subpart E (Section 15.407)
ANSI C63.10: 2013

The above equipment has been tested by **Bureau Veritas Consumer Products Services (H.K.) Ltd., Taoyuan Branch**, and found compliance with the requirement of the above standards. The test record, data evaluation & Equipment Under Test (EUT) configurations represented herein are true and accurate accounts of the measurements of the sample's EMC characteristics under the conditions specified in this report.

Prepared by : Mary Ko , **Date:** Nov. 08, 2018
Mary Ko / Specialist

Approved by : May Chen , **Date:** Nov. 08, 2018
May Chen / Manager

2 Summary of Test Results

47 CFR FCC Part 15, Subpart E (Section 15.407)			
FCC Clause	Test Item	Result	Remarks
15.407(b)(6)	AC Power Conducted Emissions	PASS	Meet the requirement of limit. Minimum passing margin is -10.67dB at 0.22422MHz
15.407(b) (1/2/3/4(i/ii)/6)	Radiated Emissions & Band Edge Measurement*	PASS	Meet the requirement of limit. Minimum passing margin is -0.1dB at 5150.00MHz, 17235.00MHz, 17265.00MHz.
15.407(a)(1/2/3)	Max Average Transmit Power	PASS	Meet the requirement of limit.
---	Occupied Bandwidth Measurement	-	Reference only.
15.407(a)(1/2/3)	Peak Power Spectral Density	PASS	Meet the requirement of limit.
15.407(e)	6dB bandwidth	PASS	Meet the requirement of limit. (U-NII-3 Band only)
15.407(g)	Frequency Stability	PASS	Meet the requirement of limit.
15.203	Antenna Requirement	PASS	Antenna connector is RSMA not a standard connector.

*For U-NII-3 band compliance with rule part 15.407(b)(4)(i), the OOB test plots were recorded in Annex A.

2.1 Measurement Uncertainty

Where relevant, the following measurement uncertainty levels have been estimated for tests performed on the EUT as specified in CISPR 16-4-2:

Measurement	Frequency	Expanded Uncertainty (k=2) (\pm)
Conducted Emissions at mains ports	150kHz ~ 30MHz	1.84 dB
Radiated Emissions up to 1 GHz	30MHz ~ 1GHz	5.33 dB
Radiated Emissions above 1 GHz	1GHz ~ 6GHz	5.10 dB
	6GHz ~ 18GHz	4.85 dB
	18GHz ~ 40GHz	5.24 dB

2.2 Modification Record

There were no modifications required for compliance.

3 General Information

3.1 General Description of EUT

Product	11ac dual band IP68 Access Point with external antenna
Brand	Edgecore
Test Model	ECWO5212-L
Status of EUT	ENGINEERING SAMPLE
Power Supply Rating	48Vdc from POE
Modulation Type	CCK, DQPSK, DBPSK for DSSS 64QAM, 16QAM, QPSK, BPSK for OFDM 256QAM for OFDM in 11ac mode only
Modulation Technology	DSSS, OFDM
Transfer Rate	802.11b: up to 11Mbps 802.11a/g: up to 54Mbps 802.11n: up to 300Mbps 802.11ac: up to 866.7Mbps
Operating Frequency	2.4GHz: 2.412 ~ 2.462GHz 5GHz: 5.18GHz ~ 5.24GHz, 5.745GHz ~ 5.825GHz
Number of Channel	2.4GHz: 802.11b, 802.11g, 802.11n (HT20): 11 802.11n (HT40): 7 5GHz: 802.11a, 802.11n (HT20), 802.11ac (VHT20): 9 802.11n (HT40), 802.11ac (VHT40): 4 802.11ac (VHT80): 2
Output Power	2.4GHz: 491.547mW 5.18 ~ 5.24GHz: 520.72mW 5.745 ~ 5.825GHz: 396.962mW
Antenna Type	Refer to Note
Antenna Connector	Refer to Note
Accessory Device	NA
Data Cable Supplied	NA

Note:

1. The EUT has below radios as following table:

Radio 1	Radio 2
WLAN (2.4GHz) - Internal Antenna	WLAN (5GHz) - External Antenna

2. Simultaneously transmission condition.

Condition	Technology	
1	WLAN (2.4GHz) - Internal Antenna	WLAN (5GHz) - External Antenna

Note: The emission of the simultaneous operation has been evaluated and no non-compliance was found.

3. The EUT must be supplied with a POE as following table:

POE (Only for test not for sale)			
No.	Brand	Model No.	Spec.
1	GOSPELL DIGITAL TECHNOLOGY CO.,LTD	G0720-480-050	Input: 100-240Vac, 0.75 Max, 50/60Hz Output: 48Vdc, 0.5A

4. The antennas provided to the EUT, please refer to the following table:

Antenna No.	Chain No.	Antenna Net Gain (dBi)	Frequency range (GHz)	Antenna Type	Connector Type	Cable Length (mm)
Internal Antenna	2.4G Chain0	4.5	2.4~2.4835	Print PCB	NA	-
	2.4G Chain1	5.4	2.4~2.4835	Print PCB	NA	-
External Antenna	5G Chain0	5.58	5.15~5.85	Dipole	R-SMA	260
	5G Chain1	5.58	5.15~5.85	Dipole	R-SMA	100

5. The EUT incorporates a MIMO function.

2.4GHz Band			
MODULATION MODE	DATA RATE (MCS)	TX & RX CONFIGURATION	
802.11b	1 ~ 11Mbps	2TX	2RX
802.11g	6 ~ 54Mbps	2TX	2RX
802.11n (HT20)	MCS 0~7	2TX	2RX
	MCS 8~15	2TX	2RX
802.11n (HT40)	MCS 0~7	2TX	2RX
	MCS 8~15	2TX	2RX
5GHz Band			
MODULATION MODE	DATA RATE (MCS)	TX & RX CONFIGURATION	
802.11a	6 ~ 54Mbps	2TX	2RX
802.11n (HT20)	MCS 0~7	2TX	2RX
	MCS 8~15	2TX	2RX
802.11n (HT40)	MCS 0~7	2TX	2RX
	MCS 8~15	2TX	2RX
802.11ac (VHT20)	MCS 0~8, Nss=1	2TX	2RX
	MCS 0~8, Nss=2	2TX	2RX
802.11ac (VHT40)	MCS 0~9, Nss=1	2TX	2RX
	MCS 0~9, Nss=2	2TX	2RX
802.11ac (VHT80)	MCS 0~9, Nss=1	2TX	2RX
	MCS 0~9, Nss=2	2TX	2RX

6. The above EUT information is declared by manufacturer and for more detailed features description, please refer to the manufacturer's specifications or user's manual.

3.2 Description of Test Modes

FOR 5180 ~ 5240MHz

4 channels are provided for 802.11a, 802.11n (HT20), 802.11ac (VHT20):

Channel	Frequency	Channel	Frequency
36	5180MHz	44	5220MHz
40	5200MHz	48	5240MHz

2 channels are provided for 802.11n (HT40), 802.11ac (VHT40):

Channel	Frequency	Channel	Frequency
38	5190MHz	46	5230MHz

1 channel is provided for 802.11ac (VHT80):

Channel	Frequency
42	5210MHz

FOR 5745 ~ 5825MHz:

5 channels are provided for 802.11a, 802.11n (HT20), 802.11ac (VHT20):

Channel	Frequency	Channel	Frequency
149	5745MHz	161	5805MHz
153	5765MHz	165	5825MHz
157	5785MHz		

2 channels are provided for 802.11n (HT40), 802.11ac (VHT40):

Channel	Frequency	Channel	Frequency
151	5755MHz	159	5795MHz

1 channel is provided for 802.11ac (VHT80):

Channel	Frequency
155	5775MHz

3.2.1 Test Mode Applicability and Tested Channel Detail

EUT Configure Mode	Applicable To				Description
	RE≥1G	RE<1G	PLC	APCM	
-	√	√	√	√	-

Where **RE≥1G**: Radiated Emission above 1GHz **RE<1G**: Radiated Emission below 1GHz
PLC: Power Line Conducted Emission **APCM**: Antenna Port Conducted Measurement

Radiated Emission Test (Above 1GHz):

- Pre-Scan has been conducted to determine the worst-case mode from all possible combinations between available modulations, data rates and antenna ports (if EUT with antenna diversity architecture).
- Following channel(s) was (were) selected for the final test as listed below.

Mode	FREQ. Band (MHz)	Available Channel	Tested Channel	Modulation Technology	Modulation Type	Data Rate (Mbps)
802.11a	5180-5240	36 to 48	36, 40, 48	OFDM	BPSK	6
802.11ac (VHT20)		36 to 48	36, 40, 48	OFDM	BPSK	6.5
802.11ac (VHT40)		38 to 46	38, 46	OFDM	BPSK	13.5
802.11ac (VHT80)		42	42	OFDM	BPSK	29.3
802.11a	5745-5825	149 to 165	149, 157, 165	OFDM	BPSK	6
802.11ac (VHT20)		149 to 165	149, 157, 165	OFDM	BPSK	6.5
802.11ac (VHT40)		151 to 159	151, 159	OFDM	BPSK	13.5
802.11ac (VHT80)		155	155	OFDM	BPSK	29.3

Radiated Emission Test (Below 1GHz):

- Pre-Scan has been conducted to determine the worst-case mode from all possible combinations between available modulations, data rates and antenna ports (if EUT with antenna diversity architecture).
- Following channel(s) was (were) selected for the final test as listed below.

Mode	FREQ. Band (MHz)	Available Channel	Tested Channel	Modulation Technology	Modulation Type	Data Rate (Mbps)
802.11a	5180-5240 5745-5825	36 to 48 149 to 165	40	OFDM	BPSK	6

Power Line Conducted Emission Test:

- Pre-Scan has been conducted to determine the worst-case mode from all possible combinations between available modulations, data rates and antenna ports (if EUT with antenna diversity architecture).
- Following channel(s) was (were) selected for the final test as listed below.

Mode	FREQ. Band (MHz)	Available Channel	Tested Channel	Modulation Technology	Modulation Type	Data Rate (Mbps)
802.11a	5180-5240 5745-5825	36 to 48 149 to 165	40	OFDM	BPSK	6

Antenna Port Conducted Measurement:

- This item includes all test value of each mode, but only includes spectrum plot of worst value of each mode.
- Pre-Scan has been conducted to determine the worst-case mode from all possible combinations between available modulations, data rates and antenna ports (if EUT with antenna diversity architecture).
- Following channel(s) was (were) selected for the final test as listed below.

Mode	FREQ. Band (MHz)	Available Channel	Tested Channel	Modulation Technology	Modulation Type	Data Rate (Mbps)
802.11a	5180-5240	36 to 48	36, 40, 48	OFDM	BPSK	6
802.11ac (VHT20)		36 to 48	36, 40, 48	OFDM	BPSK	6.5
802.11ac (VHT40)		38 to 46	38, 46	OFDM	BPSK	13.5
802.11ac (VHT80)		42	42	OFDM	BPSK	29.3
802.11a	5745-5825	149 to 165	149, 157, 165	OFDM	BPSK	6
802.11ac (VHT20)		149 to 165	149, 157, 165	OFDM	BPSK	6.5
802.11ac (VHT40)		151 to 159	151, 159	OFDM	BPSK	13.5
802.11ac (VHT80)		155	155	OFDM	BPSK	29.3

Test Condition:

Applicable To	Environmental Conditions	Input Power (system)	Tested By
RE \geq 1G	22deg. C, 65%RH	120Vac, 60Hz	Steven Chiang
RE<1G	21deg. C, 66%RH	120Vac, 60Hz	Steven Chiang
PLC	25deg. C, 75%RH	120Vac, 60Hz	Andy Ho
APCM	25deg. C, 60%RH	120Vac, 60Hz	Anderson Chen

3.3 Duty Cycle of Test Signal

If duty cycle of test signal is $\geq 98\%$, duty factor is not required.

If duty cycle of test signal is $< 98\%$, duty factor shall be considered.

802.11a: Duty cycle = $20.037/20.149 = 0.994$

802.11ac (VHT20): Duty cycle = $18.525/18.7 = 0.991$

802.11ac (VHT40): Duty cycle = $8.95/9.087 = 0.985$

802.11ac (VHT80): Duty cycle = $4.143/4.235 = 0.978$, Duty factor = $10 * \log(1/0.978) = 0.1$

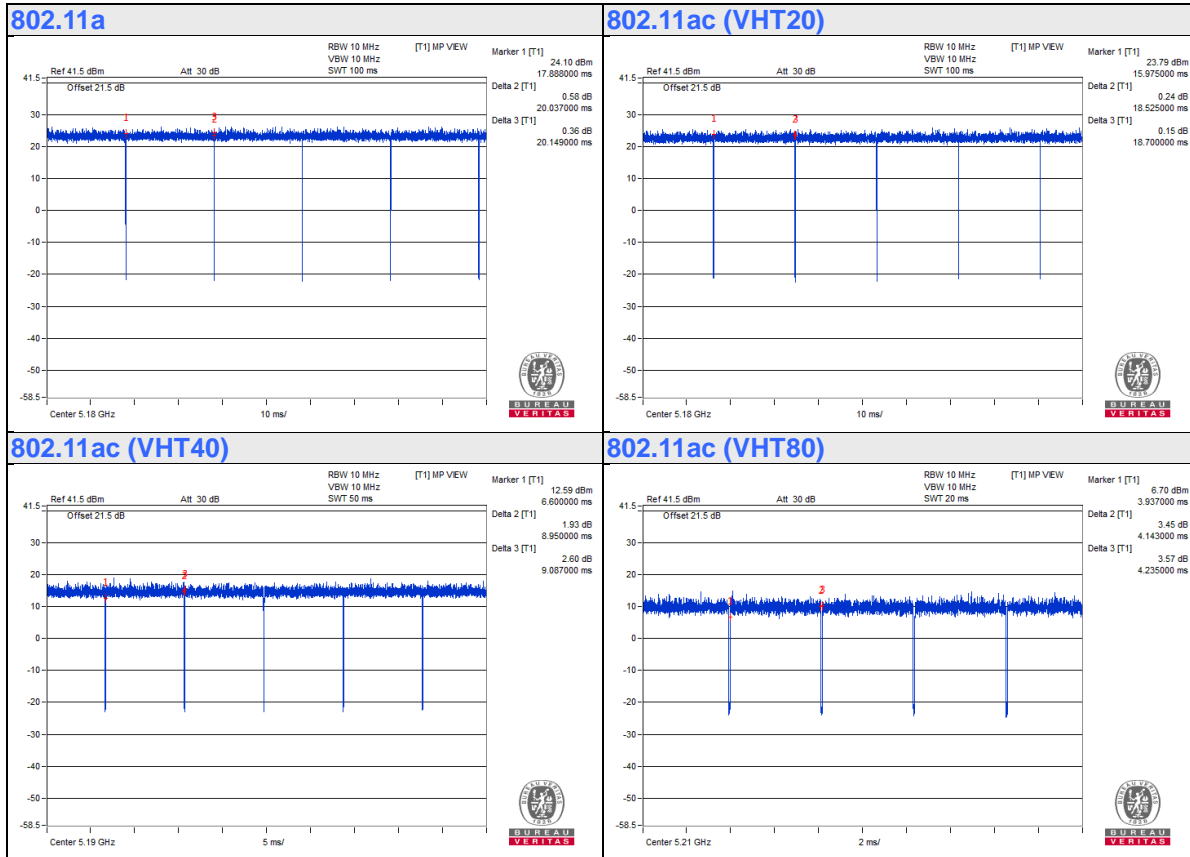

3.4 Description of Support Units

The EUT has been tested as an independent unit together with other necessary accessories or support units. The following support units or accessories were used to form a representative test configuration during the tests.

ID	Product	Brand	Model No.	Serial No.	FCC ID	Remarks
A.	Laptop	DELL	E6420	B92T3R1	FCC DoC	Provided by Lab
B.	Laptop	HP	Pavilion 14-ab023TU	5CD5340WXZ	NA	Provided by Lab
C.	POE Adapter	GOSPELL DIGITAL TECHNOLOGY CO.,LTD	G0720-480-050	NA	NA	Supplied by client

Note:

1. All power cords of the above support units are non-shielded (1.8m).

ID	Descriptions	Qty.	Length (m)	Shielding (Yes/No)	Cores (Qty.)	Remarks
1.	RJ-45 Cable	1	10	No	0	Provided by Lab
2.	RJ-45 Cable	1	10	No	0	Provided by Lab
3.	RJ-45 Cable	1	1	No	0	Provided by Lab
4.	AC Cable	1	1.8	No	0	Supplied by client
5.	Grounding cable	1	1.8	No	0	Provided by Lab

3.4.1 Configuration of System under Test

For conducted emission test:

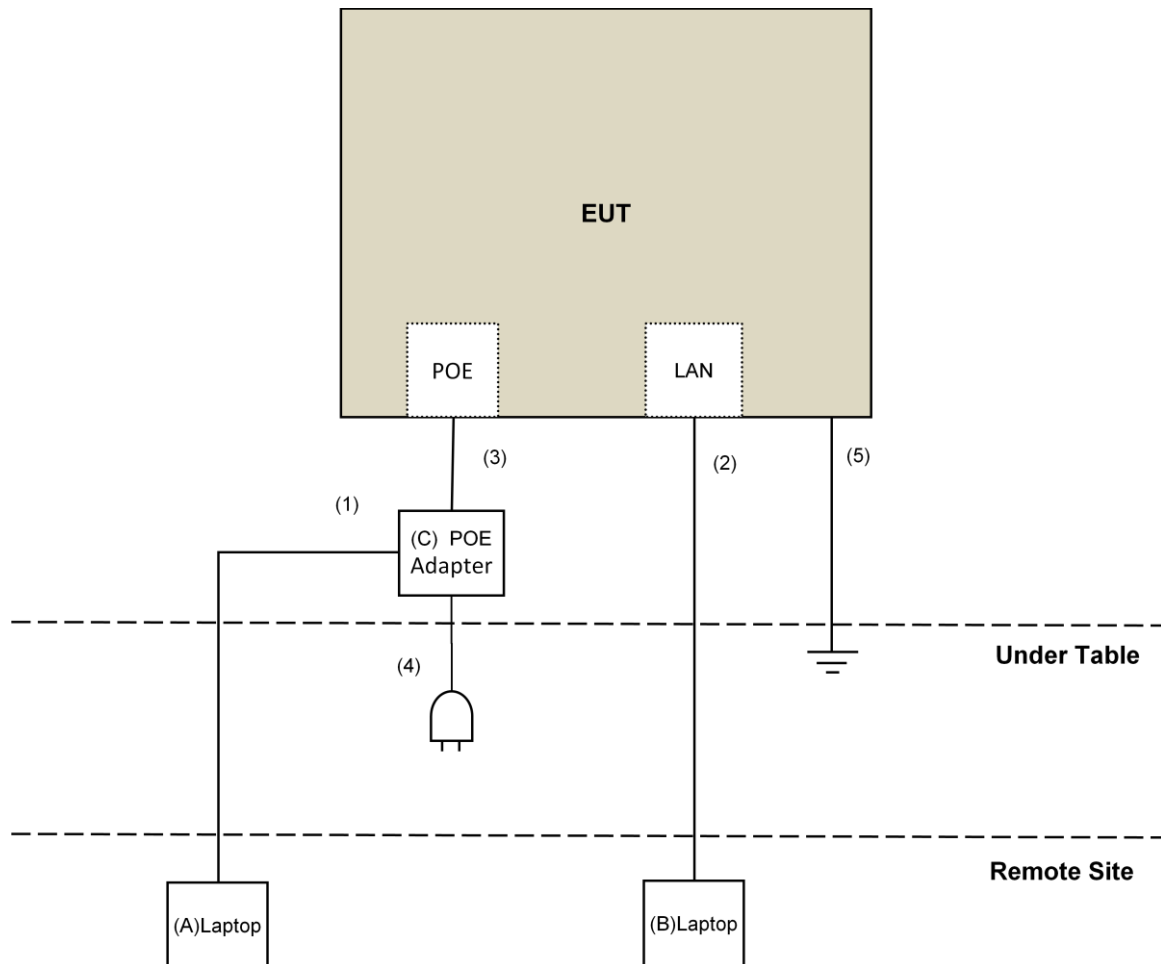

For radiated emission test:

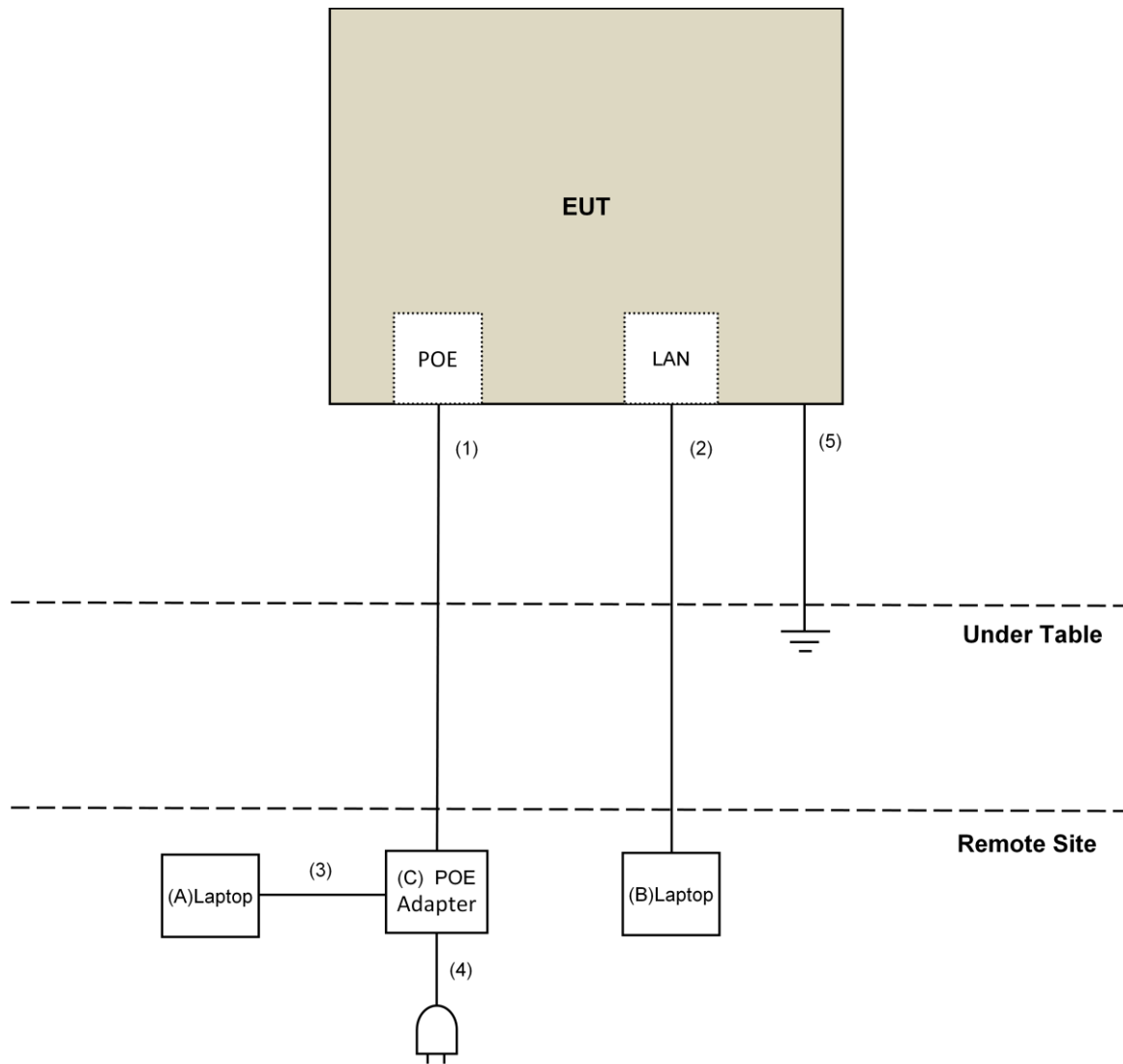

3.5 General Description of Applied Standard

The EUT is a RF Product. According to the specifications of the manufacturer, it must comply with the requirements of the following standards:

FCC Part 15, Subpart E (15.407)
KDB 789033 D02 General UNII Test Procedure New Rules v02r01
KDB 662911 D01 Multiple Transmitter Output v02r01
ANSI C63.10-2013

All test items have been performed and recorded as per the above standards.

4 Test Types and Results

4.1 Radiated Emission and Bandedge Measurement

4.1.1 Limits of Radiated Emission and Bandedge Measurement

Radiated emissions which fall in the restricted bands must comply with the radiated emission limits specified as below table.

Frequencies (MHz)	Field Strength (microvolts/meter)	Measurement Distance (meters)
0.009 ~ 0.490	2400/F(kHz)	300
0.490 ~ 1.705	24000/F(kHz)	30
1.705 ~ 30.0	30	30
30 ~ 88	100	3
88 ~ 216	150	3
216 ~ 960	200	3
Above 960	500	3

NOTE:

1. The lower limit shall apply at the transition frequencies.
2. Emission level (dBuV/m) = 20 log Emission level (uV/m).
3. For frequencies above 1000MHz, the field strength limits are based on average detector, however, the peak field strength of any emission shall not exceed the maximum permitted average limits, specified above by more than 20dB under any condition of modulation.

Limits of unwanted emission out of the restricted bands

Applicable To		Limit	
789033 D02 General UNII Test Procedure New Rules v02r01		Field Strength at 3m	
		PK:74 (dBuV/m)	AV:54 (dBuV/m)
Frequency Band	Applicable To	EIRP Limit	Equivalent Field Strength at 3m
5150~5250 MHz	15.407(b)(1)	PK:-27 (dBm/MHz)	PK:68.2(dBuV/m)
5250~5350 MHz	15.407(b)(2)		
5470~5725 MHz	15.407(b)(3)		
5725~5850 MHz	<input checked="" type="checkbox"/> 15.407(b)(4)(i)	PK:-27 (dBm/MHz) ^{*1} PK:10 (dBm/MHz) ^{*2} PK:15.6 (dBm/MHz) ^{*3} PK:27 (dBm/MHz) ^{*4}	PK: 68.2(dBuV/m) ^{*1} PK:105.2 (dBuV/m) ^{*2} PK: 110.8(dBuV/m) ^{*3} PK:122.2 (dBuV/m) ^{*4}
	<input type="checkbox"/> 15.407(b)(4)(ii)	Emission limits in section 15.247(d)	
^{*1} beyond 75 MHz or more above of the band edge.		^{*2} below the band edge increasing linearly to 10 dBm/MHz at 25 MHz above.	
^{*3} below the band edge increasing linearly to a level of 15.6 dBm/MHz at 5 MHz above.		^{*4} from 5 MHz above or below the band edge increasing linearly to a level of 27 dBm/MHz at the band edge.	

Note:

The following formula is used to convert the equipment isotropic radiated power (eirp) to field strength:

$$E = \frac{1000000\sqrt{30P}}{3} \mu\text{V/m, where P is the eirp (Watts).}$$

4.1.2 Test Instruments

DESCRIPTION & MANUFACTURER	MODEL NO.	SERIAL NO.	CALIBRATED DATE	CALIBRATED UNTIL
Test Receiver Keysight	N9038A	MY54450088	July 05, 2018	July 04, 2019
Pre-Amplifier EMC1	EMC001340	980142	Feb. 09, 2018	Feb. 08, 2019
Loop Antenna ⁽⁷⁾ Electro-Metrics	EM-6879	264	Dec. 16, 2016	Dec. 15, 2018
RF Cable	NA	LOOPCAB-001	Jan. 15, 2018	Jan. 14, 2019
RF Cable	NA	LOOPCAB-002	Jan. 15, 2018	Jan. 14, 2019
Pre-Amplifier Mini-Circuits	ZFL-1000VH2B	AMP-ZFL-01	Nov. 09, 2017	Nov. 08, 2018
Trilog Broadband Antenna SCHWARZBECK	VULB 9168	9168-406	Nov. 29, 2017	Nov. 28, 2018
RF Cable	8D	966-4-1	Mar. 21, 2018	Mar. 20, 2019
RF Cable	8D	966-4-2	Mar. 21, 2018	Mar. 20, 2019
RF Cable	8D	966-4-3	Mar. 21, 2018	Mar. 20, 2019
Fixed attenuator Mini-Circuits	UNAT-5+	PAD-3m-4-01	Sep. 27, 2018	Sep. 26, 2019
Horn_Antenna SCHWARZBECK	BBHA 9120D	9120D-783	Dec. 12, 2017	Dec. 11, 2018
Pre-Amplifier Mini-Circuits	ZVA-183-S+	AMP-ZVA-03	May 10, 2018	May 09, 2019
RF Cable	EMC104-SM-SM-1200	160923	Jan. 29, 2018	Jan. 28, 2019
RF Cable	EMC104-SM-SM-2000	150318	Jan. 29, 2018	Jan. 28, 2019
RF Cable	EMC104-SM-SM-5000	150321	Jan. 29, 2018	Jan. 28, 2019
Pre-Amplifier EMCI	EMC184045SE	980387	Jan. 29, 2018	Jan. 28, 2019
Horn_Antenna SCHWARZBECK	BBHA 9170	BBHA9170608	Dec. 14, 2017	Dec. 13, 2018
RF Cable	EMC102-KM-KM-1200	160925	Jan. 29, 2018	Jan. 28, 2019
Software	ADT_Radiated_V8.7.08	NA	NA	NA
Boresight Antenna Tower & Turn Table Max-Full	MF-7802BS	MF780208530	NA	NA
Spectrum Analyzer R&S	FSV40	100964	June 20, 2018	June 19, 2019
Power meter Anritsu	ML2495A	1014008	May 09, 2018	May 08, 2019
Power sensor Anritsu	MA2411B	0917122	May 09, 2018	May 08, 2019
AC Power Source Extech Electronics	6205	1440452	NA	NA
Temperature & Humidity Chamber Giant Force	GTH-150-40-SP-AR	MAA0812-008	Jan. 10, 2018	Jan. 09, 2019
True RMS Clamp Meter FLUKE	325	31130711WS	May 22, 2018	May 21, 2019

Note:

1. The calibration interval of the above test instruments is 12 months and the calibrations are traceable to NML/ROC and NIST/USA.
2. *The calibration interval of the above test instruments is 24 months and the calibrations are traceable to NML/ROC and NIST/USA.
3. The test was performed in 966 Chamber No. 4.
4. The CANADA Site Registration No. is 20331-2
5. Loop antenna was used for all emissions below 30 MHz.
6. Tested Date: Oct. 03 to 06, 2018

4.1.3 Test Procedure

For Radiated emission below 30MHz

- a. The EUT was placed on the top of a rotating table 0.8 meters above the ground at a 3 meter chamber room. The table was rotated 360 degrees to determine the position of the highest radiation.
- b. The EUT was set 3 meters away from the interference-receiving antenna, which was mounted on the top of a variable-height antenna tower.
- c. Parallel, perpendicular, and ground-parallel orientations of the antenna are set to make the measurement.
- d. For each suspected emission, the EUT was arranged to its worst case and the rotatable table was turned from 0 degrees to 360 degrees to find the maximum reading.
- e. The test-receiver system was set to Quasi-Peak Detect Function and Specified Bandwidth with Maximum Hold Mode.

NOTE:

1. The resolution bandwidth and video bandwidth of test receiver/spectrum analyzer is 9kHz at frequency below 30MHz.

For Radiated emission above 30MHz

- a. The EUT was placed on the top of a rotating table 0.8 meters (for 30MHz ~ 1GHz) / 1.5 meters (for above 1GHz) above the ground at 3 meter chamber room for test. The table was rotated 360 degrees to determine the position of the highest radiation.
- b. The EUT was set 3 meters away from the interference-receiving antenna, which was mounted on the top of a variable-height antenna tower.
- c. The height of antenna is varied from one meter to four meters above the ground to determine the maximum value of the field strength. Both horizontal and vertical polarizations of the antenna are set to make the measurement.
- d. For each suspected emission, the EUT was arranged to its worst case and then the antenna was tuned to heights from 1 meter to 4 meters and the rotatable table was turned from 0 degrees to 360 degrees to find the maximum reading.
- e. The test-receiver system was set to quasi-peak detect function and specified bandwidth with maximum hold mode when the test frequency is below 1 GHz.
- f. The test-receiver system was set to peak and average detects function and specified bandwidth with maximum hold mode when the test frequency is above 1 GHz. If the peak reading value also meets average limit, measurement with the average detector is unnecessary.

Note:

1. The resolution bandwidth and video bandwidth of test receiver/spectrum analyzer is 120kHz for Quasi-peak detection (QP) at frequency below 1GHz.
2. The resolution bandwidth of test receiver/spectrum analyzer is 1 MHz and the video bandwidth is 3 MHz for Peak detection (PK) at frequency above 1GHz.
3. The resolution bandwidth of test receiver/spectrum analyzer is 1MHz and the video bandwidth is $\geq 1/T$ (Duty cycle $< 98\%$) or 10Hz (Duty cycle $\geq 98\%$) for Average detection (AV) at frequency above 1GHz.
4. All modes of operation were investigated and the worst-case emissions are reported.

4.1.4 Deviation from Test Standard

No deviation.

4.1.5 Test Setup

For Radiated emission below 30MHz

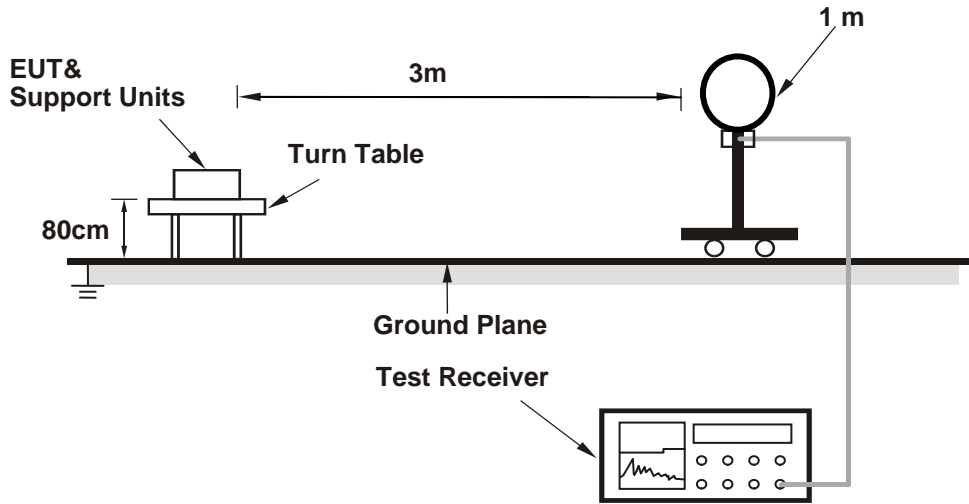

For Radiated emission 30MHz to 1GHz

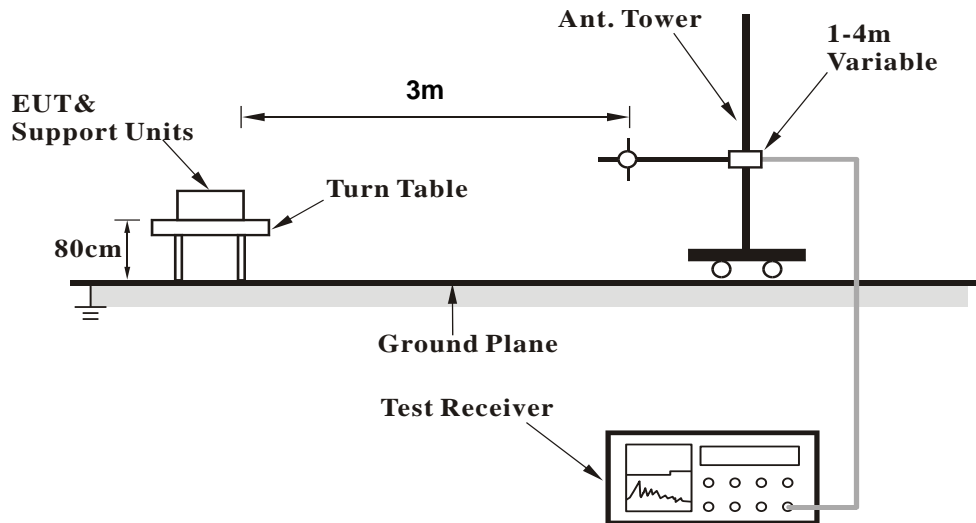

For Radiated emission above 1GHz

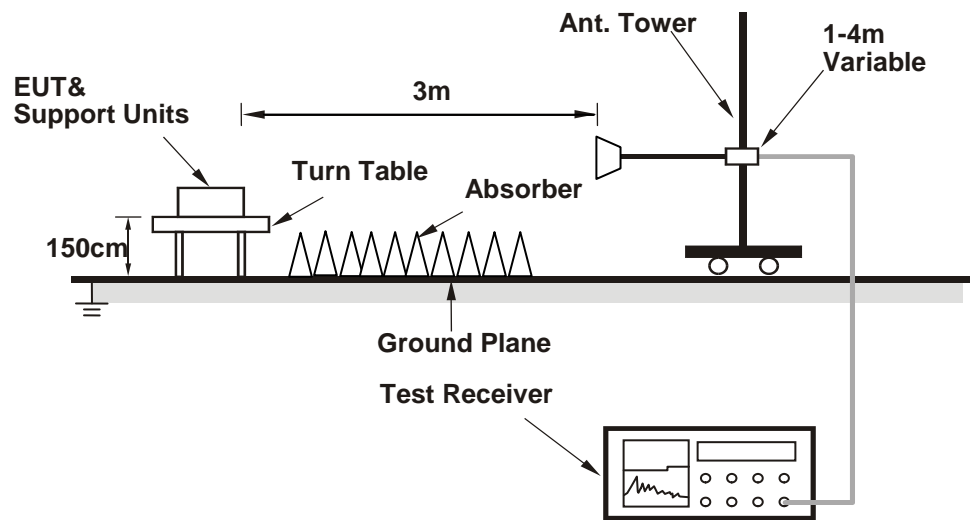

For the actual test configuration, please refer to the attached file (Test Setup Photo).

4.1.6 EUT Operating Condition

- a. Connected the EUT with the Laptop which is placed on remote site.
- b. Controlling software (QDART connectivity (1.0.42)) has been activated to set the EUT on specific status.

4.1.7 Test Results

Above 1GHz Data:

802.11a

CHANNEL	TX Channel 36	DETECTOR FUNCTION	Peak (PK)
FREQUENCY RANGE	1GHz ~ 40GHz		Average (AV)

ANTENNA POLARITY & TEST DISTANCE: HORIZONTAL AT 3 M

NO.	FREQ. (MHz)	EMISSION LEVEL (dBuV/m)	LIMIT (dBuV/m)	MARGIN (dB)	ANTENNA HEIGHT (m)	TABLE ANGLE (Degree)	RAW VALUE (dBuV)	CORRECTION FACTOR (dB/m)
1	5150.00	53.7 PK	74.0	-20.3	1.56 H	355	50.7	3.0
2	5150.00	41.3 AV	54.0	-12.7	1.56 H	355	38.3	3.0
3	*5180.00	102.7 PK			1.56 H	355	99.9	2.8
4	*5180.00	93.7 AV			1.56 H	355	90.9	2.8
5	#10360.00	55.8 PK	68.2	-12.4	1.54 H	27	43.4	12.4
6	15540.00	56.5 PK	74.0	-17.5	1.49 H	287	43.7	12.8
7	15540.00	44.1 AV	54.0	-9.9	1.49 H	287	31.3	12.8

ANTENNA POLARITY & TEST DISTANCE: VERTICAL AT 3 M

NO.	FREQ. (MHz)	EMISSION LEVEL (dBuV/m)	LIMIT (dBuV/m)	MARGIN (dB)	ANTENNA HEIGHT (m)	TABLE ANGLE (Degree)	RAW VALUE (dBuV)	CORRECTION FACTOR (dB/m)
1	5150.00	66.8 PK	74.0	-7.2	1.48 V	300	63.8	3.0
2	5150.00	53.8 AV	54.0	-0.2	1.48 V	300	50.8	3.0
3	*5180.00	115.7 PK			1.48 V	300	112.9	2.8
4	*5180.00	105.8 AV			1.48 V	300	103.0	2.8
5	#10360.00	56.3 PK	68.2	-11.9	1.99 V	330	43.9	12.4
6	15540.00	60.0 PK	74.0	-14.0	1.77 V	28	47.2	12.8
7	15540.00	47.6 AV	54.0	-6.4	1.77 V	28	34.8	12.8

REMARKS:

1. Emission Level(dBuV/m) = Raw Value(dBuV) + Correction Factor(dB/m)
2. Correction Factor(dB/m) = Antenna Factor(dB/m) + Cable Factor(dB) – Pre-Amplifier Factor(dB)
3. The other emission levels were very low against the limit.
4. Margin value = Emission Level – Limit value
5. " * ": Fundamental frequency.
6. " # ": The radiated frequency is out of the restricted band.

CHANNEL	TX Channel 40	DETECTOR FUNCTION	Peak (PK)
FREQUENCY RANGE	1GHz ~ 40GHz		Average (AV)

ANTENNA POLARITY & TEST DISTANCE: HORIZONTAL AT 3 M

NO.	FREQ. (MHz)	EMISSION LEVEL (dBuV/m)	LIMIT (dBuV/m)	MARGIN (dB)	ANTENNA HEIGHT (m)	TABLE ANGLE (Degree)	RAW VALUE (dBuV)	CORRECTION FACTOR (dB/m)
1	5150.00	54.1 PK	74.0	-19.9	1.52 H	7	51.1	3.0
2	5150.00	41.5 AV	54.0	-12.5	1.52 H	7	38.5	3.0
3	*5200.00	107.5 PK			1.52 H	7	104.8	2.7
4	*5200.00	97.7 AV			1.52 H	7	95.0	2.7
5	#10400.00	58.3 PK	68.2	-9.9	1.63 H	38	45.8	12.5
6	15600.00	57.2 PK	74.0	-16.8	1.51 H	270	44.4	12.8
7	15600.00	44.4 AV	54.0	-9.6	1.51 H	270	31.6	12.8

ANTENNA POLARITY & TEST DISTANCE: VERTICAL AT 3 M

NO.	FREQ. (MHz)	EMISSION LEVEL (dBuV/m)	LIMIT (dBuV/m)	MARGIN (dB)	ANTENNA HEIGHT (m)	TABLE ANGLE (Degree)	RAW VALUE (dBuV)	CORRECTION FACTOR (dB/m)
1	5150.00	66.6 PK	74.0	-7.4	1.56 V	298	63.6	3.0
2	5150.00	53.8 AV	54.0	-0.2	1.56 V	298	50.8	3.0
3	*5200.00	119.5 PK			1.56 V	298	116.8	2.7
4	*5200.00	109.9 AV			1.56 V	298	107.2	2.7
5	#10400.00	59.2 PK	68.2	-9.0	1.96 V	315	46.7	12.5
6	15600.00	61.7 PK	74.0	-12.3	1.74 V	22	48.9	12.8
7	15600.00	49.3 AV	54.0	-4.7	1.74 V	22	36.5	12.8

REMARKS:

1. Emission Level(dBuV/m) = Raw Value(dBuV) + Correction Factor(dB/m)
2. Correction Factor(dB/m) = Antenna Factor(dB/m) + Cable Factor(dB) – Pre-Amplifier Factor(dB)
3. The other emission levels were very low against the limit.
4. Margin value = Emission Level – Limit value
5. " * ": Fundamental frequency.
6. " # ": The radiated frequency is out of the restricted band.

CHANNEL	TX Channel 48	DETECTOR FUNCTION	Peak (PK)
FREQUENCY RANGE	1GHz ~ 40GHz		Average (AV)

ANTENNA POLARITY & TEST DISTANCE: HORIZONTAL AT 3 M

NO.	FREQ. (MHz)	EMISSION LEVEL (dBuV/m)	LIMIT (dBuV/m)	MARGIN (dB)	ANTENNA HEIGHT (m)	TABLE ANGLE (Degree)	RAW VALUE (dBuV)	CORRECTION FACTOR (dB/m)
1	*5240.00	107.3 PK			1.50 H	351	104.8	2.5
2	*5240.00	97.5 AV			1.50 H	351	95.0	2.5
3	5350.00	52.3 PK	74.0	-21.7	1.50 H	351	49.7	2.6
4	5350.00	40.4 AV	54.0	-13.6	1.50 H	351	37.8	2.6
5	#10480.00	56.8 PK	68.2	-11.4	1.60 H	29	43.8	13.0
6	15720.00	56.5 PK	74.0	-17.5	1.51 H	284	44.1	12.4
7	15720.00	44.0 AV	54.0	-10.0	1.51 H	284	31.6	12.4

ANTENNA POLARITY & TEST DISTANCE: VERTICAL AT 3 M

NO.	FREQ. (MHz)	EMISSION LEVEL (dBuV/m)	LIMIT (dBuV/m)	MARGIN (dB)	ANTENNA HEIGHT (m)	TABLE ANGLE (Degree)	RAW VALUE (dBuV)	CORRECTION FACTOR (dB/m)
1	*5240.00	119.9 PK			1.56 V	298	117.4	2.5
2	*5240.00	110.0 AV			1.56 V	298	107.5	2.5
3	5350.00	58.2 PK	74.0	-15.8	1.56 V	298	55.6	2.6
4	5350.00	46.6 AV	54.0	-7.4	1.56 V	298	44.0	2.6
5	#10480.00	57.5 PK	68.2	-10.7	2.00 V	318	44.5	13.0
6	15720.00	61.2 PK	74.0	-12.8	1.78 V	36	48.8	12.4
7	15720.00	48.7 AV	54.0	-5.3	1.78 V	36	36.3	12.4

REMARKS:

1. Emission Level(dBuV/m) = Raw Value(dBuV) + Correction Factor(dB/m)
2. Correction Factor(dB/m) = Antenna Factor(dB/m) + Cable Factor(dB) – Pre-Amplifier Factor(dB)
3. The other emission levels were very low against the limit.
4. Margin value = Emission Level – Limit value
5. " * ": Fundamental frequency.
6. " # ": The radiated frequency is out of the restricted band.

CHANNEL	TX Channel 149	DETECTOR FUNCTION	Peak (PK)
FREQUENCY RANGE	1GHz ~ 40GHz		Average (AV)

ANTENNA POLARITY & TEST DISTANCE: HORIZONTAL AT 3 M

NO.	FREQ. (MHz)	EMISSION LEVEL (dBuV/m)	LIMIT (dBuV/m)	MARGIN (dB)	ANTENNA HEIGHT (m)	TABLE ANGLE (Degree)	RAW VALUE (dBuV)	CORRECTION FACTOR (dB/m)
1	*5745.00	105.4 PK			1.42 H	19	102.1	3.3
2	*5745.00	95.6 AV			1.42 H	19	92.3	3.3
3	11490.00	57.1 PK	74.0	-16.9	1.65 H	21	43.7	13.4
4	11490.00	46.0 AV	54.0	-8.0	1.65 H	21	32.6	13.4
5	#17235.00	63.3 PK	68.2	-4.9	1.52 H	291	46.6	16.7

ANTENNA POLARITY & TEST DISTANCE: VERTICAL AT 3 M

NO.	FREQ. (MHz)	EMISSION LEVEL (dBuV/m)	LIMIT (dBuV/m)	MARGIN (dB)	ANTENNA HEIGHT (m)	TABLE ANGLE (Degree)	RAW VALUE (dBuV)	CORRECTION FACTOR (dB/m)
1	*5745.00	119.2 PK			1.54 V	310	115.9	3.3
2	*5745.00	109.6 AV			1.54 V	310	106.3	3.3
3	11490.00	58.1 PK	74.0	-15.9	1.46 V	51	44.7	13.4
4	11490.00	47.0 AV	54.0	-7.0	1.46 V	51	33.6	13.4
5	#17235.00	68.0 PK	68.2	-0.2	1.48 V	326	51.3	16.7

REMARKS:

1. Emission Level(dBuV/m) = Raw Value(dBuV) + Correction Factor(dB/m)
2. Correction Factor(dB/m) = Antenna Factor(dB/m) + Cable Factor(dB) – Pre-Amplifier Factor(dB)
3. The other emission levels were very low against the limit.
4. Margin value = Emission Level – Limit value
5. " * ": Fundamental frequency.
6. " # ": The radiated frequency is out of the restricted band.

CHANNEL	TX Channel 157	DETECTOR FUNCTION	Peak (PK)
FREQUENCY RANGE	1GHz ~ 40GHz		Average (AV)

ANTENNA POLARITY & TEST DISTANCE: HORIZONTAL AT 3 M

NO.	FREQ. (MHz)	EMISSION LEVEL (dBuV/m)	LIMIT (dBuV/m)	MARGIN (dB)	ANTENNA HEIGHT (m)	TABLE ANGLE (Degree)	RAW VALUE (dBuV)	CORRECTION FACTOR (dB/m)
1	*5785.00	106.2 PK			1.40 H	11	102.9	3.3
2	*5785.00	96.3 AV			1.40 H	11	93.0	3.3
3	11570.00	57.3 PK	74.0	-16.7	1.60 H	33	43.9	13.4
4	11570.00	45.9 AV	54.0	-8.1	1.60 H	33	32.5	13.4
5	#17355.00	63.0 PK	68.2	-5.2	1.56 H	286	45.7	17.3

ANTENNA POLARITY & TEST DISTANCE: VERTICAL AT 3 M

NO.	FREQ. (MHz)	EMISSION LEVEL (dBuV/m)	LIMIT (dBuV/m)	MARGIN (dB)	ANTENNA HEIGHT (m)	TABLE ANGLE (Degree)	RAW VALUE (dBuV)	CORRECTION FACTOR (dB/m)
1	*5785.00	120.3 PK			1.59 V	310	117.0	3.3
2	*5785.00	110.4 AV			1.59 V	310	107.1	3.3
3	11570.00	58.0 PK	74.0	-16.0	1.51 V	38	44.6	13.4
4	11570.00	46.8 AV	54.0	-7.2	1.51 V	38	33.4	13.4
5	#17355.00	67.9 PK	68.2	-0.3	1.46 V	339	50.6	17.3

REMARKS:

1. Emission Level(dBuV/m) = Raw Value(dBuV) + Correction Factor(dB/m)
2. Correction Factor(dB/m) = Antenna Factor(dB/m) + Cable Factor(dB) – Pre-Amplifier Factor(dB)
3. The other emission levels were very low against the limit.
4. Margin value = Emission Level – Limit value
5. " * ": Fundamental frequency.
6. " # ": The radiated frequency is out of the restricted band.

CHANNEL	TX Channel 165	DETECTOR FUNCTION	Peak (PK)
FREQUENCY RANGE	1GHz ~ 40GHz		Average (AV)

ANTENNA POLARITY & TEST DISTANCE: HORIZONTAL AT 3 M

NO.	FREQ. (MHz)	EMISSION LEVEL (dBuV/m)	LIMIT (dBuV/m)	MARGIN (dB)	ANTENNA HEIGHT (m)	TABLE ANGLE (Degree)	RAW VALUE (dBuV)	CORRECTION FACTOR (dB/m)
1	*5825.00	106.4 PK			1.44 H	15	102.9	3.5
2	*5825.00	96.5 AV			1.44 H	15	93.0	3.5
3	11650.00	57.0 PK	74.0	-17.0	1.65 H	36	43.7	13.3
4	11650.00	45.6 AV	54.0	-8.4	1.65 H	36	32.3	13.3
5	#17475.00	63.1 PK	68.2	-5.1	1.52 H	285	44.9	18.2

ANTENNA POLARITY & TEST DISTANCE: VERTICAL AT 3 M

NO.	FREQ. (MHz)	EMISSION LEVEL (dBuV/m)	LIMIT (dBuV/m)	MARGIN (dB)	ANTENNA HEIGHT (m)	TABLE ANGLE (Degree)	RAW VALUE (dBuV)	CORRECTION FACTOR (dB/m)
1	*5825.00	120.4 PK			1.57 V	306	116.9	3.5
2	*5825.00	110.7 AV			1.57 V	306	107.2	3.5
3	11650.00	57.4 PK	74.0	-16.6	1.46 V	34	44.1	13.3
4	11650.00	46.3 AV	54.0	-7.7	1.46 V	34	33.0	13.3
5	#17475.00	67.5 PK	68.2	-0.7	1.48 V	338	49.3	18.2

REMARKS:

1. Emission Level(dBuV/m) = Raw Value(dBuV) + Correction Factor(dB/m)
2. Correction Factor(dB/m) = Antenna Factor(dB/m) + Cable Factor(dB) – Pre-Amplifier Factor(dB)
3. The other emission levels were very low against the limit.
4. Margin value = Emission Level – Limit value
5. " * ": Fundamental frequency.
6. " # ": The radiated frequency is out of the restricted band.

802.11ac (VHT20)

CHANNEL	TX Channel 36	DETECTOR FUNCTION	Peak (PK)
FREQUENCY RANGE	1GHz ~ 40GHz		Average (AV)

ANTENNA POLARITY & TEST DISTANCE: HORIZONTAL AT 3 M

NO.	FREQ. (MHz)	EMISSION LEVEL (dBuV/m)	LIMIT (dBuV/m)	MARGIN (dB)	ANTENNA HEIGHT (m)	TABLE ANGLE (Degree)	RAW VALUE (dBuV)	CORRECTION FACTOR (dB/m)
1	5150.00	53.3 PK	74.0	-20.7	1.62 H	353	50.3	3.0
2	5150.00	41.0 AV	54.0	-13.0	1.62 H	353	38.0	3.0
3	*5180.00	102.2 PK			1.62 H	353	99.4	2.8
4	*5180.00	92.8 AV			1.62 H	353	90.0	2.8
5	#10360.00	55.5 PK	68.2	-12.7	1.52 H	33	43.1	12.4
6	15540.00	56.5 PK	74.0	-17.5	1.50 H	280	43.7	12.8
7	15540.00	43.8 AV	54.0	-10.2	1.50 H	280	31.0	12.8

ANTENNA POLARITY & TEST DISTANCE: VERTICAL AT 3 M

NO.	FREQ. (MHz)	EMISSION LEVEL (dBuV/m)	LIMIT (dBuV/m)	MARGIN (dB)	ANTENNA HEIGHT (m)	TABLE ANGLE (Degree)	RAW VALUE (dBuV)	CORRECTION FACTOR (dB/m)
1	5150.00	65.4 PK	74.0	-8.6	1.56 V	298	62.4	3.0
2	5150.00	53.4 AV	54.0	-0.6	1.56 V	298	50.4	3.0
3	*5180.00	114.5 PK			1.56 V	298	111.7	2.8
4	*5180.00	105.0 AV			1.56 V	298	102.2	2.8
5	#10360.00	56.0 PK	68.2	-12.2	1.95 V	333	43.6	12.4
6	15540.00	60.3 PK	74.0	-13.7	1.78 V	28	47.5	12.8
7	15540.00	47.6 AV	54.0	-6.4	1.78 V	28	34.8	12.8

REMARKS:

1. Emission Level(dBuV/m) = Raw Value(dBuV) + Correction Factor(dB/m)
2. Correction Factor(dB/m) = Antenna Factor(dB/m) + Cable Factor(dB) – Pre-Amplifier Factor(dB)
3. The other emission levels were very low against the limit.
4. Margin value = Emission Level – Limit value
5. " * ": Fundamental frequency.
6. " # ": The radiated frequency is out of the restricted band.

CHANNEL	TX Channel 40	DETECTOR FUNCTION	Peak (PK)
FREQUENCY RANGE	1GHz ~ 40GHz		Average (AV)

ANTENNA POLARITY & TEST DISTANCE: HORIZONTAL AT 3 M

NO.	FREQ. (MHz)	EMISSION LEVEL (dBuV/m)	LIMIT (dBuV/m)	MARGIN (dB)	ANTENNA HEIGHT (m)	TABLE ANGLE (Degree)	RAW VALUE (dBuV)	CORRECTION FACTOR (dB/m)
1	5150.00	53.9 PK	74.0	-20.1	1.51 H	355	50.9	3.0
2	5150.00	41.7 AV	54.0	-12.3	1.51 H	355	38.7	3.0
3	*5200.00	117.2 PK			1.51 H	355	114.5	2.7
4	*5200.00	97.5 AV			1.51 H	355	94.8	2.7
5	#10400.00	56.6 PK	68.2	-11.6	1.63 H	15	44.1	12.5
6	15600.00	56.7 PK	74.0	-17.3	1.46 H	293	43.9	12.8
7	15600.00	44.1 AV	54.0	-9.9	1.46 H	293	31.3	12.8

ANTENNA POLARITY & TEST DISTANCE: VERTICAL AT 3 M

NO.	FREQ. (MHz)	EMISSION LEVEL (dBuV/m)	LIMIT (dBuV/m)	MARGIN (dB)	ANTENNA HEIGHT (m)	TABLE ANGLE (Degree)	RAW VALUE (dBuV)	CORRECTION FACTOR (dB/m)
1	5150.00	66.2 PK	74.0	-7.8	1.60 V	291	63.2	3.0
2	5150.00	53.5 AV	54.0	-0.5	1.60 V	291	50.5	3.0
3	*5200.00	118.5 PK			1.60 V	291	115.8	2.7
4	*5200.00	109.8 AV			1.60 V	291	107.1	2.7
5	#10400.00	56.8 PK	68.2	-11.4	1.97 V	306	44.3	12.5
6	15600.00	61.0 PK	74.0	-13.0	1.77 V	43	48.2	12.8
7	15600.00	48.7 AV	54.0	-5.3	1.77 V	43	35.9	12.8

REMARKS:

1. Emission Level(dBuV/m) = Raw Value(dBuV) + Correction Factor(dB/m)
2. Correction Factor(dB/m) = Antenna Factor(dB/m) + Cable Factor(dB) – Pre-Amplifier Factor(dB)
3. The other emission levels were very low against the limit.
4. Margin value = Emission Level – Limit value
5. " * ": Fundamental frequency.
6. " # ": The radiated frequency is out of the restricted band.

CHANNEL	TX Channel 48	DETECTOR FUNCTION	Peak (PK)
FREQUENCY RANGE	1GHz ~ 40GHz		Average (AV)

ANTENNA POLARITY & TEST DISTANCE: HORIZONTAL AT 3 M

NO.	FREQ. (MHz)	EMISSION LEVEL (dBuV/m)	LIMIT (dBuV/m)	MARGIN (dB)	ANTENNA HEIGHT (m)	TABLE ANGLE (Degree)	RAW VALUE (dBuV)	CORRECTION FACTOR (dB/m)
1	*5240.00	116.9 PK			1.52 H	2	114.4	2.5
2	*5240.00	97.2 AV			1.52 H	2	94.7	2.5
3	5350.00	52.5 PK	74.0	-21.5	1.52 H	2	49.9	2.6
4	5350.00	40.3 AV	54.0	-13.7	1.52 H	2	37.7	2.6
5	#10480.00	56.1 PK	68.2	-12.1	1.62 H	26	43.1	13.0
6	15720.00	55.2 PK	74.0	-18.8	1.51 H	291	42.8	12.4
7	15720.00	42.7 AV	54.0	-11.3	1.51 H	291	30.3	12.4

ANTENNA POLARITY & TEST DISTANCE: VERTICAL AT 3 M

NO.	FREQ. (MHz)	EMISSION LEVEL (dBuV/m)	LIMIT (dBuV/m)	MARGIN (dB)	ANTENNA HEIGHT (m)	TABLE ANGLE (Degree)	RAW VALUE (dBuV)	CORRECTION FACTOR (dB/m)
1	*5240.00	119.8 PK			1.56 V	295	117.3	2.5
2	*5240.00	109.8 AV			1.56 V	295	107.3	2.5
3	5350.00	57.7 PK	74.0	-16.3	1.56 V	295	55.1	2.6
4	5350.00	46.1 AV	54.0	-7.9	1.56 V	295	43.5	2.6
5	#10480.00	56.5 PK	68.2	-11.7	2.03 V	325	43.5	13.0
6	15720.00	60.0 PK	74.0	-14.0	1.76 V	42	47.6	12.4
7	15720.00	47.7 AV	54.0	-6.3	1.76 V	42	35.3	12.4

REMARKS:

1. Emission Level(dBuV/m) = Raw Value(dBuV) + Correction Factor(dB/m)
2. Correction Factor(dB/m) = Antenna Factor(dB/m) + Cable Factor(dB) – Pre-Amplifier Factor(dB)
3. The other emission levels were very low against the limit.
4. Margin value = Emission Level – Limit value
5. " * ": Fundamental frequency.
6. " # ": The radiated frequency is out of the restricted band.

CHANNEL	TX Channel 149	DETECTOR FUNCTION	Peak (PK)
FREQUENCY RANGE	1GHz ~ 40GHz		Average (AV)

ANTENNA POLARITY & TEST DISTANCE: HORIZONTAL AT 3 M

NO.	FREQ. (MHz)	EMISSION LEVEL (dBuV/m)	LIMIT (dBuV/m)	MARGIN (dB)	ANTENNA HEIGHT (m)	TABLE ANGLE (Degree)	RAW VALUE (dBuV)	CORRECTION FACTOR (dB/m)
1	*5745.00	103.8 PK			1.50 H	355	100.5	3.3
2	*5745.00	94.5 AV			1.50 H	355	91.2	3.3
3	11490.00	57.6 PK	74.0	-16.4	1.65 H	26	44.2	13.4
4	11490.00	46.1 AV	54.0	-7.9	1.65 H	26	32.7	13.4
5	#17235.00	63.5 PK	68.2	-4.7	1.52 H	301	46.8	16.7

ANTENNA POLARITY & TEST DISTANCE: VERTICAL AT 3 M

NO.	FREQ. (MHz)	EMISSION LEVEL (dBuV/m)	LIMIT (dBuV/m)	MARGIN (dB)	ANTENNA HEIGHT (m)	TABLE ANGLE (Degree)	RAW VALUE (dBuV)	CORRECTION FACTOR (dB/m)
1	*5745.00	118.2 PK			1.65 V	310	114.9	3.3
2	*5745.00	109.1 AV			1.65 V	310	105.8	3.3
3	11490.00	57.9 PK	74.0	-16.1	1.46 V	34	44.5	13.4
4	11490.00	46.5 AV	54.0	-7.5	1.46 V	34	33.1	13.4
5	#17235.00	68.1 PK	68.2	-0.1	1.42 V	328	51.4	16.7

REMARKS:

1. Emission Level(dBuV/m) = Raw Value(dBuV) + Correction Factor(dB/m)
2. Correction Factor(dB/m) = Antenna Factor(dB/m) + Cable Factor(dB) – Pre-Amplifier Factor(dB)
3. The other emission levels were very low against the limit.
4. Margin value = Emission Level – Limit value
5. " * ": Fundamental frequency.
6. " # ": The radiated frequency is out of the restricted band.

CHANNEL	TX Channel 157	DETECTOR FUNCTION	Peak (PK)
FREQUENCY RANGE	1GHz ~ 40GHz		Average (AV)

ANTENNA POLARITY & TEST DISTANCE: HORIZONTAL AT 3 M

NO.	FREQ. (MHz)	EMISSION LEVEL (dBuV/m)	LIMIT (dBuV/m)	MARGIN (dB)	ANTENNA HEIGHT (m)	TABLE ANGLE (Degree)	RAW VALUE (dBuV)	CORRECTION FACTOR (dB/m)
1	*5785.00	104.0 PK			1.47 H	351	100.7	3.3
2	*5785.00	94.7 AV			1.47 H	351	91.4	3.3
3	11570.00	56.9 PK	74.0	-17.1	1.69 H	34	43.5	13.4
4	11570.00	45.3 AV	54.0	-8.7	1.69 H	34	31.9	13.4
5	#17355.00	63.5 PK	68.2	-4.7	1.49 H	282	46.2	17.3

ANTENNA POLARITY & TEST DISTANCE: VERTICAL AT 3 M

NO.	FREQ. (MHz)	EMISSION LEVEL (dBuV/m)	LIMIT (dBuV/m)	MARGIN (dB)	ANTENNA HEIGHT (m)	TABLE ANGLE (Degree)	RAW VALUE (dBuV)	CORRECTION FACTOR (dB/m)
1	*5785.00	118.6 PK			1.69 V	296	115.3	3.3
2	*5785.00	109.4 AV			1.69 V	296	106.1	3.3
3	11570.00	57.8 PK	74.0	-16.2	1.51 V	28	44.4	13.4
4	11570.00	45.8 AV	54.0	-8.2	1.51 V	28	32.4	13.4
5	#17355.00	68.0 PK	68.2	-0.2	1.45 V	353	50.7	17.3

REMARKS:

1. Emission Level(dBuV/m) = Raw Value(dBuV) + Correction Factor(dB/m)
2. Correction Factor(dB/m) = Antenna Factor(dB/m) + Cable Factor(dB) – Pre-Amplifier Factor(dB)
3. The other emission levels were very low against the limit.
4. Margin value = Emission Level – Limit value
5. " * ": Fundamental frequency.
6. " # ": The radiated frequency is out of the restricted band.

CHANNEL	TX Channel 165	DETECTOR FUNCTION	Peak (PK)
FREQUENCY RANGE	1GHz ~ 40GHz		Average (AV)

ANTENNA POLARITY & TEST DISTANCE: HORIZONTAL AT 3 M

NO.	FREQ. (MHz)	EMISSION LEVEL (dBuV/m)	LIMIT (dBuV/m)	MARGIN (dB)	ANTENNA HEIGHT (m)	TABLE ANGLE (Degree)	RAW VALUE (dBuV)	CORRECTION FACTOR (dB/m)
1	*5825.00	104.2 PK			1.55 H	359	100.7	3.5
2	*5825.00	95.0 AV			1.55 H	359	91.5	3.5
3	11650.00	57.5 PK	74.0	-16.5	1.61 H	30	44.2	13.3
4	11650.00	45.9 AV	54.0	-8.1	1.61 H	30	32.6	13.3
5	#17475.00	63.6 PK	68.2	-4.6	1.56 H	272	45.4	18.2

ANTENNA POLARITY & TEST DISTANCE: VERTICAL AT 3 M

NO.	FREQ. (MHz)	EMISSION LEVEL (dBuV/m)	LIMIT (dBuV/m)	MARGIN (dB)	ANTENNA HEIGHT (m)	TABLE ANGLE (Degree)	RAW VALUE (dBuV)	CORRECTION FACTOR (dB/m)
1	*5825.00	118.5 PK			1.62 V	313	115.0	3.5
2	*5825.00	109.3 AV			1.62 V	313	105.8	3.5
3	11650.00	57.9 PK	74.0	-16.1	1.43 V	26	44.6	13.3
4	11650.00	46.7 AV	54.0	-7.3	1.43 V	26	33.4	13.3
5	#17475.00	67.7 PK	68.2	-0.5	1.48 V	353	49.5	18.2

REMARKS:

1. Emission Level(dBuV/m) = Raw Value(dBuV) + Correction Factor(dB/m)
2. Correction Factor(dB/m) = Antenna Factor(dB/m) + Cable Factor(dB) – Pre-Amplifier Factor(dB)
3. The other emission levels were very low against the limit.
4. Margin value = Emission Level – Limit value
5. " * ": Fundamental frequency.
6. " # ": The radiated frequency is out of the restricted band.

802.11ac (VHT40)

CHANNEL	TX Channel 38	DETECTOR FUNCTION	Peak (PK)
FREQUENCY RANGE	1GHz ~ 40GHz		Average (AV)

ANTENNA POLARITY & TEST DISTANCE: HORIZONTAL AT 3 M

NO.	FREQ. (MHz)	EMISSION LEVEL (dBuV/m)	LIMIT (dBuV/m)	MARGIN (dB)	ANTENNA HEIGHT (m)	TABLE ANGLE (Degree)	RAW VALUE (dBuV)	CORRECTION FACTOR (dB/m)
1	5150.00	53.9 PK	74.0	-20.1	1.51 H	359	50.9	3.0
2	5150.00	41.6 AV	54.0	-12.4	1.51 H	359	38.6	3.0
3	*5190.00	96.2 PK			1.51 H	359	93.4	2.8
4	*5190.00	87.5 AV			1.51 H	359	84.7	2.8
5	5350.00	52.1 PK	74.0	-21.9	1.51 H	359	49.5	2.6
6	5350.00	40.4 AV	54.0	-13.6	1.51 H	359	37.8	2.6
7	#10380.00	53.1 PK	68.2	-15.1	1.60 H	9	40.7	12.4
8	15570.00	52.4 PK	74.0	-21.6	1.47 H	270	39.6	12.8
9	15570.00	40.3 AV	54.0	-13.7	1.47 H	270	27.5	12.8

ANTENNA POLARITY & TEST DISTANCE: VERTICAL AT 3 M

NO.	FREQ. (MHz)	EMISSION LEVEL (dBuV/m)	LIMIT (dBuV/m)	MARGIN (dB)	ANTENNA HEIGHT (m)	TABLE ANGLE (Degree)	RAW VALUE (dBuV)	CORRECTION FACTOR (dB/m)
1	5150.00	64.6 PK	74.0	-9.4	1.51 V	295	61.6	3.0
2	5150.00	53.9 AV	54.0	-0.1	1.51 V	295	50.9	3.0
3	*5190.00	106.7 PK			1.51 V	295	103.9	2.8
4	*5190.00	98.2 AV			1.51 V	295	95.4	2.8
5	5350.00	52.9 PK	74.0	-21.1	1.51 V	295	50.3	2.6
6	5350.00	41.2 AV	54.0	-12.8	1.51 V	295	38.6	2.6
7	#10380.00	53.5 PK	68.2	-14.7	2.07 V	337	41.1	12.4
8	15570.00	56.4 PK	74.0	-17.6	1.72 V	52	43.6	12.8
9	15570.00	44.3 AV	54.0	-9.7	1.72 V	52	31.5	12.8

REMARKS:

- Emission Level(dBuV/m) = Raw Value(dBuV) + Correction Factor(dB/m)
- Correction Factor(dB/m) = Antenna Factor(dB/m) + Cable Factor(dB) – Pre-Amplifier Factor(dB)
- The other emission levels were very low against the limit.
- Margin value = Emission Level – Limit value
- " * ": Fundamental frequency.
- " # ": The radiated frequency is out of the restricted band.

CHANNEL	TX Channel 46	DETECTOR FUNCTION	Peak (PK)
FREQUENCY RANGE	1GHz ~ 40GHz		Average (AV)

ANTENNA POLARITY & TEST DISTANCE: HORIZONTAL AT 3 M

NO.	FREQ. (MHz)	EMISSION LEVEL (dBuV/m)	LIMIT (dBuV/m)	MARGIN (dB)	ANTENNA HEIGHT (m)	TABLE ANGLE (Degree)	RAW VALUE (dBuV)	CORRECTION FACTOR (dB/m)
1	5150.00	53.4 PK	74.0	-20.6	1.62 H	357	50.4	3.0
2	5150.00	40.9 AV	54.0	-13.1	1.62 H	357	37.9	3.0
3	*5230.00	103.5 PK			1.62 H	357	101.0	2.5
4	*5230.00	94.6 AV			1.62 H	357	92.1	2.5
5	5350.00	52.3 PK	74.0	-21.7	1.62 H	357	49.7	2.6
6	5350.00	40.2 AV	54.0	-13.8	1.62 H	357	37.6	2.6
7	#10460.00	55.9 PK	68.2	-12.3	1.61 H	15	43.0	12.9
8	15690.00	55.7 PK	74.0	-18.3	1.47 H	277	43.3	12.4
9	15690.00	43.1 AV	54.0	-10.9	1.47 H	277	30.7	12.4

ANTENNA POLARITY & TEST DISTANCE: VERTICAL AT 3 M

NO.	FREQ. (MHz)	EMISSION LEVEL (dBuV/m)	LIMIT (dBuV/m)	MARGIN (dB)	ANTENNA HEIGHT (m)	TABLE ANGLE (Degree)	RAW VALUE (dBuV)	CORRECTION FACTOR (dB/m)
1	5150.00	67.0 PK	74.0	-7.0	1.56 V	298	64.0	3.0
2	5150.00	53.6 AV	54.0	-0.4	1.56 V	298	50.6	3.0
3	*5230.00	114.5 PK			1.56 V	298	112.0	2.5
4	*5230.00	105.9 AV			1.56 V	298	103.4	2.5
5	5350.00	59.7 PK	74.0	-14.3	1.56 V	298	57.1	2.6
6	5350.00	48.2 AV	54.0	-5.8	1.56 V	298	45.6	2.6
7	#10460.00	56.3 PK	68.2	-11.9	2.08 V	330	43.4	12.9
8	15690.00	59.9 PK	74.0	-14.1	1.76 V	55	47.5	12.4
9	15690.00	47.4 AV	54.0	-6.6	1.76 V	55	35.0	12.4

REMARKS:

1. Emission Level(dBuV/m) = Raw Value(dBuV) + Correction Factor(dB/m)
2. Correction Factor(dB/m) = Antenna Factor(dB/m) + Cable Factor(dB) – Pre-Amplifier Factor(dB)
3. The other emission levels were very low against the limit.
4. Margin value = Emission Level – Limit value
5. " * ": Fundamental frequency.
6. " # ": The radiated frequency is out of the restricted band.

CHANNEL	TX Channel 151	DETECTOR FUNCTION	Peak (PK)
FREQUENCY RANGE	1GHz ~ 40GHz		Average (AV)

ANTENNA POLARITY & TEST DISTANCE: HORIZONTAL AT 3 M

NO.	FREQ. (MHz)	EMISSION LEVEL (dBuV/m)	LIMIT (dBuV/m)	MARGIN (dB)	ANTENNA HEIGHT (m)	TABLE ANGLE (Degree)	RAW VALUE (dBuV)	CORRECTION FACTOR (dB/m)
1	*5755.00	102.7 PK			1.48 H	350	99.4	3.3
2	*5755.00	93.8 AV			1.48 H	350	90.5	3.3
3	11510.00	58.0 PK	74.0	-16.0	1.71 H	27	44.6	13.4
4	11510.00	45.4 AV	54.0	-8.6	1.71 H	27	32.0	13.4
5	#17265.00	63.5 PK	68.2	-4.7	1.55 H	275	46.7	16.8

ANTENNA POLARITY & TEST DISTANCE: VERTICAL AT 3 M

NO.	FREQ. (MHz)	EMISSION LEVEL (dBuV/m)	LIMIT (dBuV/m)	MARGIN (dB)	ANTENNA HEIGHT (m)	TABLE ANGLE (Degree)	RAW VALUE (dBuV)	CORRECTION FACTOR (dB/m)
1	*5755.00	116.2 PK			1.58 V	316	112.9	3.3
2	*5755.00	107.5 AV			1.58 V	316	104.2	3.3
3	11510.00	57.6 PK	74.0	-16.4	1.49 V	36	44.2	13.4
4	11510.00	46.7 AV	54.0	-7.3	1.49 V	36	33.3	13.4
5	#17265.00	68.1 PK	68.2	-0.1	1.56 V	346	51.3	16.8

REMARKS:

1. Emission Level(dBuV/m) = Raw Value(dBuV) + Correction Factor(dB/m)
2. Correction Factor(dB/m) = Antenna Factor(dB/m) + Cable Factor(dB) – Pre-Amplifier Factor(dB)
3. The other emission levels were very low against the limit.
4. Margin value = Emission Level – Limit value
5. " * ": Fundamental frequency.
6. " # ": The radiated frequency is out of the restricted band.

CHANNEL	TX Channel 159	DETECTOR FUNCTION	Peak (PK)
FREQUENCY RANGE	1GHz ~ 40GHz		Average (AV)

ANTENNA POLARITY & TEST DISTANCE: HORIZONTAL AT 3 M

NO.	FREQ. (MHz)	EMISSION LEVEL (dBuV/m)	LIMIT (dBuV/m)	MARGIN (dB)	ANTENNA HEIGHT (m)	TABLE ANGLE (Degree)	RAW VALUE (dBuV)	CORRECTION FACTOR (dB/m)
1	*5795.00	102.5 PK			1.49 H	345	99.2	3.3
2	*5795.00	93.5 AV			1.49 H	345	90.2	3.3
3	11590.00	57.9 PK	74.0	-16.1	1.64 H	20	44.5	13.4
4	11590.00	45.7 AV	54.0	-8.3	1.64 H	20	32.3	13.4
5	#17385.00	62.4 PK	68.2	-5.8	1.51 H	287	44.9	17.5

ANTENNA POLARITY & TEST DISTANCE: VERTICAL AT 3 M

NO.	FREQ. (MHz)	EMISSION LEVEL (dBuV/m)	LIMIT (dBuV/m)	MARGIN (dB)	ANTENNA HEIGHT (m)	TABLE ANGLE (Degree)	RAW VALUE (dBuV)	CORRECTION FACTOR (dB/m)
1	*5795.00	116.3 PK			1.55 V	313	113.0	3.3
2	*5795.00	107.6 AV			1.55 V	313	104.3	3.3
3	11590.00	58.3 PK	74.0	-15.7	1.46 V	49	44.9	13.4
4	11590.00	46.5 AV	54.0	-7.5	1.46 V	49	33.1	13.4
5	#17385.00	64.3 PK	68.2	-3.9	1.54 V	338	46.8	17.5

REMARKS:

1. Emission Level(dBuV/m) = Raw Value(dBuV) + Correction Factor(dB/m)
2. Correction Factor(dB/m) = Antenna Factor(dB/m) + Cable Factor(dB) – Pre-Amplifier Factor(dB)
3. The other emission levels were very low against the limit.
4. Margin value = Emission Level – Limit value
5. " * ": Fundamental frequency.
6. " # ": The radiated frequency is out of the restricted band.

802.11ac (VHT80)

CHANNEL	TX Channel 42	DETECTOR FUNCTION	Peak (PK)
FREQUENCY RANGE	1GHz ~ 40GHz		Average (AV)

ANTENNA POLARITY & TEST DISTANCE: HORIZONTAL AT 3 M

NO.	FREQ. (MHz)	EMISSION LEVEL (dBuV/m)	LIMIT (dBuV/m)	MARGIN (dB)	ANTENNA HEIGHT (m)	TABLE ANGLE (Degree)	RAW VALUE (dBuV)	CORRECTION FACTOR (dB/m)
1	5150.00	54.2 PK	74.0	-19.8	1.60 H	346	51.2	3.0
2	5150.00	41.8 AV	54.0	-12.2	1.60 H	346	38.8	3.0
3	*5210.00	94.1 PK			1.60 H	346	91.4	2.7
4	*5210.00	84.8 AV			1.60 H	346	82.1	2.7
5	5350.00	52.4 PK	74.0	-21.6	1.60 H	346	49.8	2.6
6	5350.00	40.4 AV	54.0	-13.6	1.60 H	346	37.8	2.6
7	#10420.00	53.4 PK	68.2	-14.8	1.61 H	24	40.8	12.6
8	15630.00	52.1 PK	74.0	-21.9	1.43 H	280	39.4	12.7
9	15630.00	40.0 AV	54.0	-14.0	1.43 H	280	27.3	12.7

ANTENNA POLARITY & TEST DISTANCE: VERTICAL AT 3 M

NO.	FREQ. (MHz)	EMISSION LEVEL (dBuV/m)	LIMIT (dBuV/m)	MARGIN (dB)	ANTENNA HEIGHT (m)	TABLE ANGLE (Degree)	RAW VALUE (dBuV)	CORRECTION FACTOR (dB/m)
1	5150.00	65.3 PK	74.0	-8.7	1.62 V	294	62.3	3.0
2	5150.00	53.8 AV	54.0	-0.2	1.62 V	294	50.8	3.0
3	*5210.00	104.8 PK			1.62 V	294	102.1	2.7
4	*5210.00	95.5 AV			1.62 V	294	92.8	2.7
5	5350.00	53.5 PK	74.0	-20.5	1.62 V	294	50.9	2.6
6	5350.00	42.5 AV	54.0	-11.5	1.62 V	294	39.9	2.6
7	#10420.00	53.3 PK	68.2	-14.9	2.12 V	339	40.7	12.6
8	15630.00	56.7 PK	74.0	-17.3	1.73 V	49	44.0	12.7
9	15630.00	44.5 AV	54.0	-9.5	1.73 V	49	31.8	12.7

REMARKS:

- Emission Level(dBuV/m) = Raw Value(dBuV) + Correction Factor(dB/m)
- Correction Factor(dB/m) = Antenna Factor(dB/m) + Cable Factor(dB) – Pre-Amplifier Factor(dB)
- The other emission levels were very low against the limit.
- Margin value = Emission Level – Limit value
- " * ": Fundamental frequency.
- " # ": The radiated frequency is out of the restricted band.

CHANNEL	TX Channel 155	DETECTOR FUNCTION	Peak (PK)
FREQUENCY RANGE	1GHz ~ 40GHz		Average (AV)

ANTENNA POLARITY & TEST DISTANCE: HORIZONTAL AT 3 M

NO.	FREQ. (MHz)	EMISSION LEVEL (dBuV/m)	LIMIT (dBuV/m)	MARGIN (dB)	ANTENNA HEIGHT (m)	TABLE ANGLE (Degree)	RAW VALUE (dBuV)	CORRECTION FACTOR (dB/m)
1	*5775.00	96.8 PK			1.52 H	358	93.4	3.4
2	*5775.00	87.1 AV			1.52 H	358	83.7	3.4
3	11550.00	55.9 PK	74.0	-18.1	1.61 H	26	42.6	13.3
4	11550.00	43.5 AV	54.0	-10.5	1.61 H	26	30.2	13.3
5	#17325.00	60.5 PK	68.2	-7.7	1.49 H	272	43.4	17.1

ANTENNA POLARITY & TEST DISTANCE: VERTICAL AT 3 M

NO.	FREQ. (MHz)	EMISSION LEVEL (dBuV/m)	LIMIT (dBuV/m)	MARGIN (dB)	ANTENNA HEIGHT (m)	TABLE ANGLE (Degree)	RAW VALUE (dBuV)	CORRECTION FACTOR (dB/m)
1	*5775.00	111.1 PK			1.61 V	316	107.7	3.4
2	*5775.00	101.5 AV			1.61 V	316	98.1	3.4
3	11550.00	56.4 PK	74.0	-17.6	1.41 V	40	43.1	13.3
4	11550.00	44.3 AV	54.0	-9.7	1.41 V	40	31.0	13.3
5	#17325.00	62.3 PK	68.2	-5.9	1.59 V	325	45.2	17.1

REMARKS:

1. Emission Level(dBuV/m) = Raw Value(dBuV) + Correction Factor(dB/m)
2. Correction Factor(dB/m) = Antenna Factor(dB/m) + Cable Factor(dB) – Pre-Amplifier Factor(dB)
3. The other emission levels were very low against the limit.
4. Margin value = Emission Level – Limit value
5. " * ": Fundamental frequency.
6. " # ": The radiated frequency is out of the restricted band.

Below 1GHz Data:

802.11a

CHANNEL	TX Channel 40	DETECTOR FUNCTION	Quasi-Peak (QP)
FREQUENCY RANGE	9kHz ~ 1GHz		

ANTENNA POLARITY & TEST DISTANCE: HORIZONTAL AT 3 M								
NO.	FREQ. (MHz)	EMISSION LEVEL (dBuV/m)	LIMIT (dBuV/m)	MARGIN (dB)	ANTENNA HEIGHT (m)	TABLE ANGLE (Degree)	RAW VALUE (dBuV)	CORRECTION FACTOR (dB/m)
1	87.50	30.5 QP	40.0	-9.5	2.00 H	277	44.1	-13.6
2	129.98	36.7 QP	43.5	-6.8	2.00 H	81	45.7	-9.0
3	156.78	37.4 QP	43.5	-6.1	2.00 H	264	44.9	-7.5
4	250.00	33.7 QP	46.0	-12.3	1.50 H	78	42.6	-8.9
5	325.00	33.1 QP	46.0	-12.9	1.00 H	285	39.3	-6.2
6	374.50	37.5 QP	46.0	-8.5	1.00 H	103	42.3	-4.8

REMARKS:

1. Emission Level(dBuV/m) = Raw Value(dBuV) + Correction Factor(dB/m)
2. Correction Factor(dB/m) = Antenna Factor(dB/m) + Cable Factor(dB) – Pre-Amplifier Factor(dB)
3. Margin value = Emission Level – Limit value
4. The emission levels were very low against the limit of frequency range 9kHz~30MHz: the amplitude of spurious emissions attenuated more than 20 dB below the permissible value to be report.

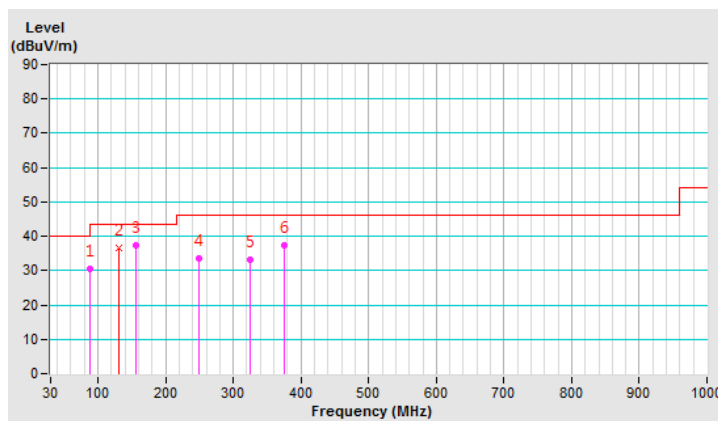

CHANNEL	TX Channel 40	DETECTOR FUNCTION	Quasi-Peak (QP)
FREQUENCY RANGE	9kHz ~ 1GHz		

ANTENNA POLARITY & TEST DISTANCE: VERTICAL AT 3 M

NO.	FREQ. (MHz)	EMISSION LEVEL (dBuV/m)	LIMIT (dBuV/m)	MARGIN (dB)	ANTENNA HEIGHT (m)	TABLE ANGLE (Degree)	RAW VALUE (dBuV)	CORRECTION FACTOR (dB/m)
1	147.35	36.9 QP	43.5	-6.6	1.00 V	360	44.6	-7.7
2	216.36	34.5 QP	46.0	-11.5	1.00 V	173	45.7	-11.2
3	325.00	34.2 QP	46.0	-11.8	1.50 V	121	40.4	-6.2
4	383.13	38.4 QP	46.0	-7.6	1.50 V	131	43.0	-4.6
5	650.02	38.9 QP	46.0	-7.1	1.00 V	360	37.5	1.4
6	958.02	34.2 QP	46.0	-11.8	1.00 V	169	28.0	6.2

REMARKS:

1. Emission Level(dBuV/m) = Raw Value(dBuV) + Correction Factor(dB/m)
2. Correction Factor(dB/m) = Antenna Factor(dB/m) + Cable Factor(dB) – Pre-Amplifier Factor(dB)
3. Margin value = Emission Level – Limit value
4. The emission levels were very low against the limit of frequency range 9kHz~30MHz: the amplitude of spurious emissions attenuated more than 20 dB below the permissible value to be report.

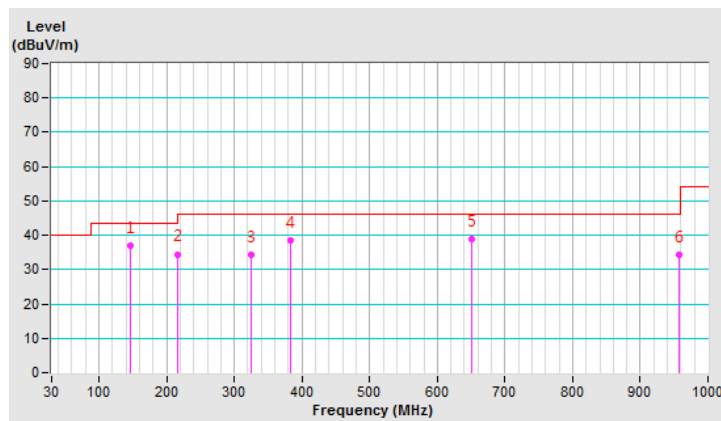

4.2 Conducted Emission Measurement

4.2.1 Limits of Conducted Emission Measurement

Frequency (MHz)	Conducted Limit (dBuV)	
	Quasi-peak	Average
0.15 - 0.5	66 - 56	56 - 46
0.50 - 5.0	56	46
5.0 - 30.0	60	50

Note: 1. The lower limit shall apply at the transition frequencies.

2. The limit decreases in line with the logarithm of the frequency in the range of 0.15 to 0.50MHz.

4.2.2 Test Instruments

DESCRIPTION & MANUFACTURER	MODEL NO.	SERIAL NO.	CALIBRATED DATE	CALIBRATED UNTIL
Test Receiver R&S	ESCS 30	847124/029	Nov. 01, 2017	Oct. 31, 2018
Line-Impedance Stabilization Network (for EUT) R&S	ESH3-Z5	848773/004	Nov. 15, 2017	Nov. 14, 2018
Line-Impedance Stabilization Network (for Peripheral) R&S	ENV216	100072	June 04, 2018	June 03, 2019
50 ohms Terminator	N/A	EMC-04	Nov. 01, 2017	Oct. 31, 2018
RF Cable	5D-FB	COCCAB-001	Sep. 28, 2018	Sep. 27, 2019
Fixed attenuator EMCI	STI02-2200-10	003	Mar. 16, 2018	Mar. 15, 2019
Software BVADT	BVADT_Cond_ V7.3.7.4	NA	NA	NA

Note:

1. The calibration interval of the above test instruments are 12 months and the calibrations are traceable to NML/ROC and NIST/USA.
2. The test was performed in Conduction 1.
3. Tested Date: Oct. 10, 2018

4.2.3 Test Procedure

- The EUT was placed 0.4 meters from the conducting wall of the shielded room with EUT being connected to the power mains through a line impedance stabilization network (LISN). Other support units were connected to the power mains through another LISN. The two LISNs provide 50 ohm/ 50uH of coupling impedance for the measuring instrument.
- Both lines of the power mains connected to the EUT were checked for maximum conducted interference.
- The frequency range from 150kHz to 30MHz was searched. Emission levels under (Limit - 20dB) was not recorded.

NOTE: All modes of operation were investigated and the worst-case emissions are reported.

4.2.4 Deviation from Test Standard

No deviation.

4.2.5 Test Setup

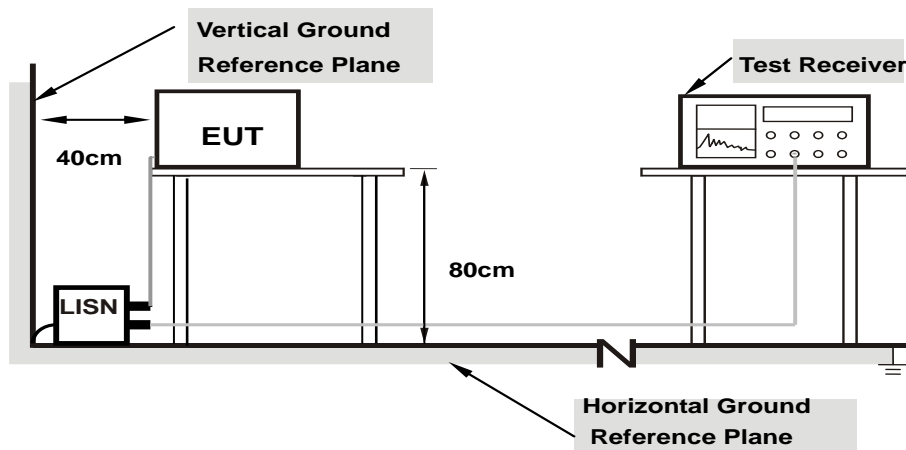

Note: 1.Support units were connected to second LISN.

For the actual test configuration, please refer to the attached file (Test Setup Photo).

4.2.6 EUT Operating Condition

Same as 4.1.6.

4.2.7 Test Results

Phase	Line (L)	Detector Function	Quasi-Peak (QP) / Average (AV)
-------	----------	-------------------	--------------------------------

No	Freq.	Corr.	Reading Value		Emission Level		Limit		Margin	
	[MHz]	Factor	[dB (uV)]		[dB (uV)]		[dB (uV)]		(dB)	
		(dB)	Q.P.	AV.	Q.P.	AV.	Q.P.	AV.	Q.P.	AV.
1	0.16562	10.04	37.16	19.08	47.20	29.12	65.18	55.18	-17.98	-26.06
2	0.18516	10.05	34.10	15.68	44.15	25.73	64.25	54.25	-20.10	-28.52
3	0.22422	10.07	41.20	31.92	51.27	41.99	62.66	52.66	-11.39	-10.67
4	0.31016	10.09	24.76	15.30	34.85	25.39	59.97	49.97	-25.12	-24.58
5	3.67188	10.26	24.91	12.05	35.17	22.31	56.00	46.00	-20.83	-23.69
6	17.33594	10.96	25.84	20.29	36.80	31.25	60.00	50.00	-23.20	-18.75

REMARKS:

1. Q.P. and AV. are abbreviations of quasi-peak and average individually.
2. The emission levels of other frequencies were very low against the limit.
3. Margin value = Emission level - Limit value
4. Correction factor = Insertion loss + Cable loss
5. Emission Level = Correction Factor + Reading Value.



Phase	Neutral (N)	Detector Function	Quasi-Peak (QP) / Average (AV)
-------	-------------	-------------------	--------------------------------

No	Freq. [MHz]	Corr. Factor	Reading Value [dB (uV)]		Emission Level [dB (uV)]		Limit [dB (uV)]		Margin (dB)	
		(dB)	Q.P.	AV.	Q.P.	AV.	Q.P.	AV.	Q.P.	AV.
	1	0.15391	9.95	29.25	7.53	39.20	17.48	65.79	55.79	-26.59
2	0.16953	9.95	37.10	22.48	47.05	32.43	64.98	54.98	-17.93	-22.55
3	0.22031	9.96	38.93	29.84	48.89	39.80	62.81	52.81	-13.92	-13.01
4	0.26719	9.97	28.84	19.64	38.81	29.61	61.20	51.20	-22.39	-21.59
5	3.49609	10.12	25.05	14.02	35.17	24.14	56.00	46.00	-20.83	-21.86
6	15.10547	10.66	22.62	17.10	33.28	27.76	60.00	50.00	-26.72	-22.24

REMARKS:

1. Q.P. and AV. are abbreviations of quasi-peak and average individually.
2. The emission levels of other frequencies were very low against the limit.
3. Margin value = Emission level - Limit value
4. Correction factor = Insertion loss + Cable loss
5. Emission Level = Correction Factor + Reading Value.

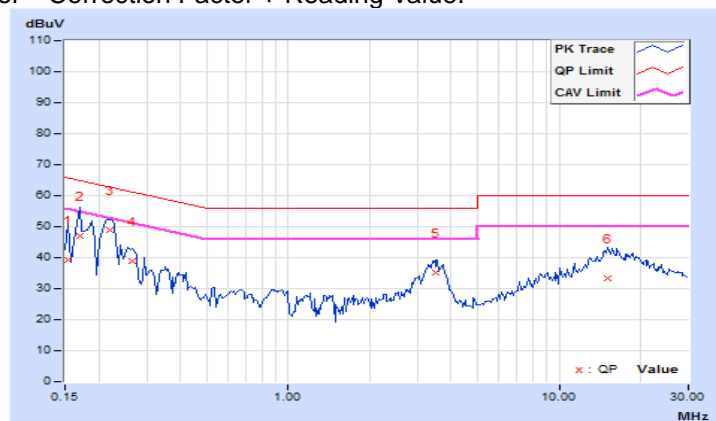

4.3 Transmit Power Measurement

4.3.1 Limits of Transmit Power Measurement

Operation Band	EUT Category		Limit
U-NII-1		Outdoor Access Point	1 Watt (30 dBm) (Max. e.i.r.p \leq 125mW(21 dBm) at any elevation angle above 30 degrees as measured from the horizon)
		Fixed point-to-point Access Point	1 Watt (30 dBm)
	√	Indoor Access Point	1 Watt (30 dBm)
		Client device	250mW (24 dBm)
U-NII-2A	---		250mW (24 dBm) or 11 dBm+10 log B*
U-NII-2C	---		250mW (24 dBm) or 11 dBm+10 log B*
U-NII-3	√		1 Watt (30 dBm)

*B is the 26 dB emission bandwidth in megahertz

Per KDB 662911 Method of conducted output power measurement on IEEE 802.11 devices,

Array Gain = 0 dB (i.e., no array gain) for $N_{ANT} \leq 4$;

Array Gain = 0 dB (i.e., no array gain) for channel widths ≥ 40 MHz for any N_{ANT} ;

Array Gain = $5 \log(N_{ANT}/N_{SS})$ dB or 3 dB, whichever is less for 20-MHz channel widths with $N_{ANT} \geq 5$.

For power measurements on all other devices: Array Gain = $10 \log(N_{ANT}/N_{SS})$ dB.

4.3.2 Test Setup

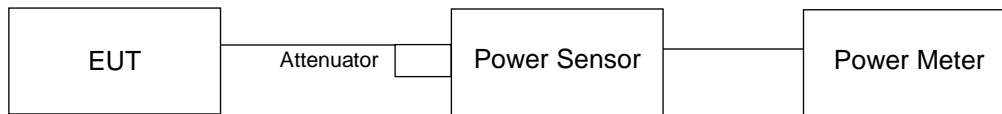

4.3.3 Test Instruments

Refer to section 4.1.2 to get information of above instrument.

4.3.4 Test Procedure

Method PM is used to perform output power measurement, trigger and gating function of wide band power meter is enabled to measure max output power of TX on burst. Duty factor is not added to measured value.

4.3.5 Deviation from Test Standard

No deviation.

4.3.6 EUT Operating Condition

The software provided by client to enable the EUT under transmission condition continuously at lowest, middle and highest channel frequencies individually.

4.3.7 Test Result

802.11a

Chan.	Chan. Freq. (MHz)	Maximum Conducted Power (dBm)		Total Power (mW)	Total Power (dBm)	Limit (dBm)	Pass / Fail
		Chain 0	Chain 1				
36	5180	19.48	20.33	196.611	22.94	30.00	Pass
40	5200	23.77	24.51	520.72	27.17	30.00	Pass
48	5240	23.11	23.34	420.418	26.24	30.00	Pass
149	5745	20.14	20.62	218.621	23.40	30.00	Pass
157	5785	21.00	21.57	269.442	24.30	30.00	Pass
165	5825	22.13	22.61	345.695	25.39	30.00	Pass

802.11ac (VHT20)

Chan.	Chan. Freq. (MHz)	Maximum Conducted Power (dBm)		Total Power (mW)	Total Power (dBm)	Limit (dBm)	Pass / Fail
		Chain 0	Chain 1				
36	5180	18.95	19.67	171.207	22.34	30.00	Pass
40	5200	23.73	24.44	514.019	27.11	30.00	Pass
48	5240	22.89	23.21	403.947	26.06	30.00	Pass
149	5745	20.13	20.57	217.064	23.37	30.00	Pass
157	5785	20.91	21.52	265.216	24.24	30.00	Pass
165	5825	22.08	22.53	340.497	25.32	30.00	Pass

802.11ac (VHT40)

Chan.	Chan. Freq. (MHz)	Maximum Conducted Power (dBm)		Total Power (mW)	Total Power (dBm)	Limit (dBm)	Pass / Fail
		Chain 0	Chain 1				
38	5190	14.54	14.98	59.922	17.78	30.00	Pass
46	5230	22.53	22.57	359.778	25.56	30.00	Pass
151	5755	22.44	23.34	391.162	25.92	30.00	Pass
159	5795	22.72	23.22	396.962	25.99	30.00	Pass

802.11ac (VHT80)

Chan.	Chan. Freq. (MHz)	Maximum Conducted Power (dBm)		Total Power (mW)	Total Power (dBm)	Limit (dBm)	Pass / Fail
		Chain 0	Chain 1				
42	5210	13.31	13.95	46.26	16.65	30.00	Pass
155	5775	16.42	17.69	102.602	20.11	30.00	Pass

4.4 Occupied Bandwidth Measurement

4.4.1 Test Setup



4.4.2 Test Instruments

Refer to section 4.1.2 to get information of above instrument.

4.4.3 Test Procedure

The transmitter output was connected to the spectrum analyzer through an attenuator. The bandwidth of the fundamental frequency was measured by spectrum analyzer with resolution bandwidth in the range of 1% to 5% of the anticipated emission bandwidth, and a video bandwidth at least 3x the resolution bandwidth and set the detector to SAMPLE. The width of a frequency band such that, below the lower and above the upper frequency limits, the mean powers emitted are each equal to a specified percentage 0.5 %of the total mean power of a given emission.

4.4.4 Test Results

802.11a

Channel	Channel Frequency (MHz)	Occupied Bandwidth (MHz)	
		Chain 0	Chain 1
36	5180	16.68	16.68
40	5200	16.68	16.68
48	5240	16.68	16.80
149	5745	16.68	16.68
157	5785	16.68	16.80
165	5825	16.68	16.68

802.11ac (VHT20)

Channel	Channel Frequency (MHz)	Occupied Bandwidth (MHz)	
		Chain 0	Chain 1
36	5180	17.88	17.88
40	5200	17.88	17.88
48	5240	17.88	17.88
149	5745	17.88	17.88
157	5785	17.88	17.88
165	5825	17.88	17.88

802.11ac (VHT40)

Channel	Channel Frequency (MHz)	Occupied Bandwidth (MHz)	
		Chain 0	Chain 1
38	5190	36.72	36.72
46	5230	36.72	36.48
151	5755	36.48	36.48
159	5795	36.72	36.96

802.11ac (VHT80)

Channel	Channel Frequency (MHz)	Occupied Bandwidth (MHz)	
		Chain 0	Chain 1
42	5210	75.84	75.84
155	5775	75.84	75.84

Spectrum Plot of Worst Value

802.11a_Chain1 / CH48

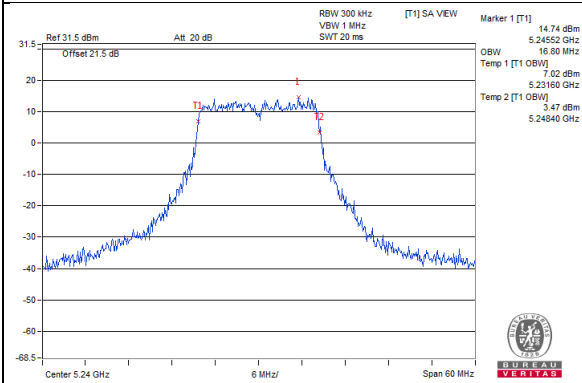

802.11ac (VHT20)_Chain0 / CH36

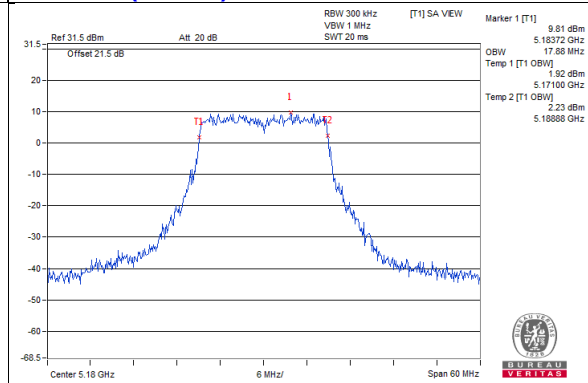

802.11ac (VHT40)_Chain1 / CH159

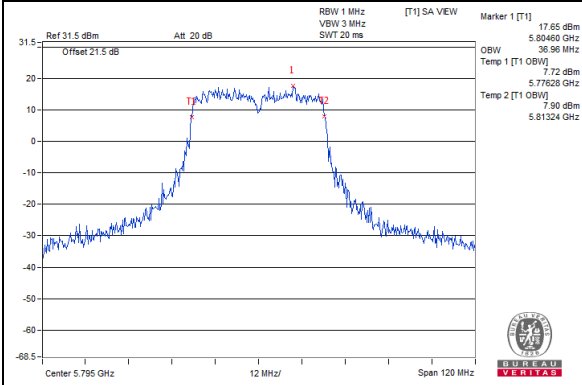

802.11ac (VHT80)_Chain0 / CH42

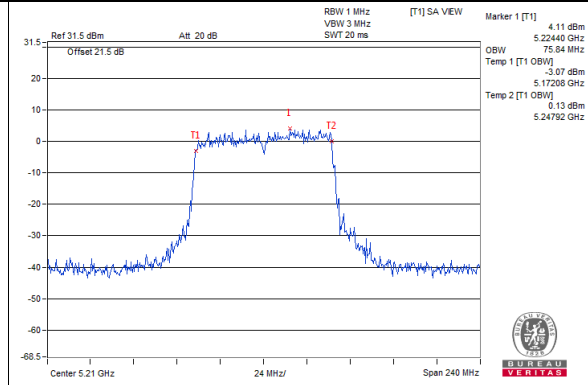

**Spectrum Plot for near by DFS band
(DFS is required, if 99% OCP straddle into U-NII-2A band)**

802.11a_Chain0 / CH48

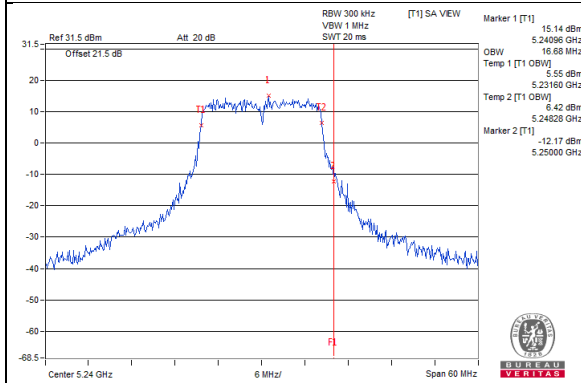

802.11a_Chain1 / CH48

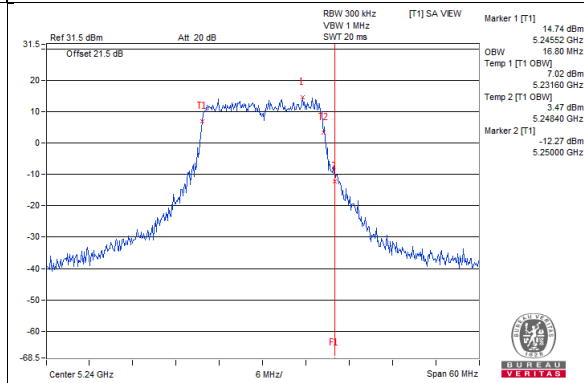

802.11ac(VHT20)_Chain0 / CH48

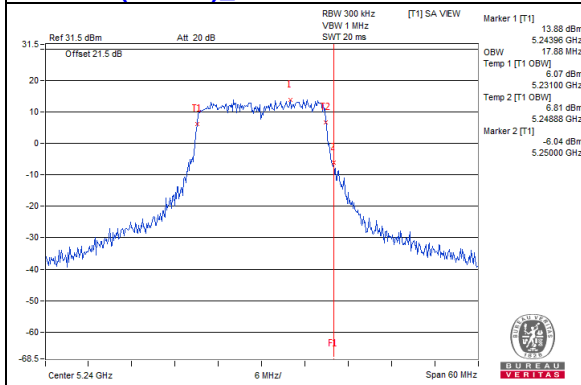

802.11ac(VHT20)_Chain1 / CH48

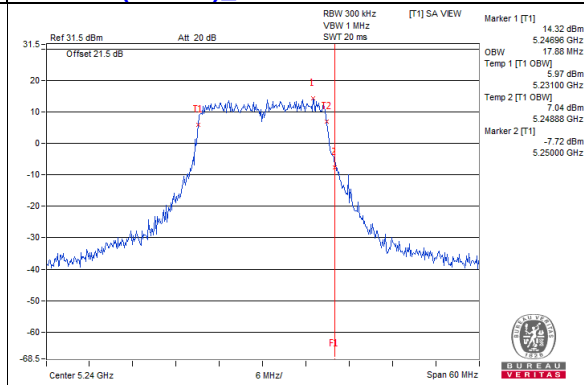

Spectrum Plot for near by DFS band (DFS is required, if 99% OCP straddle into U-NII-2A band)

802.11ac(VHT40)_Chain0 / CH46

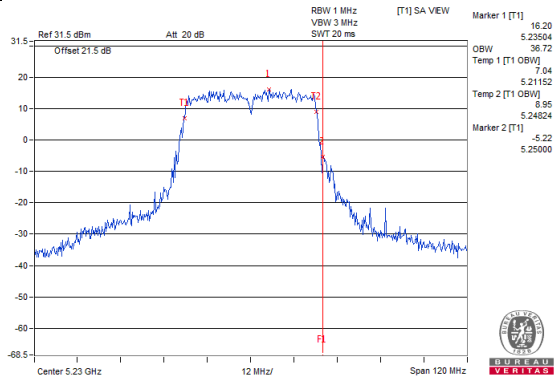

802.11ac(VHT40)_Chain1 / CH46

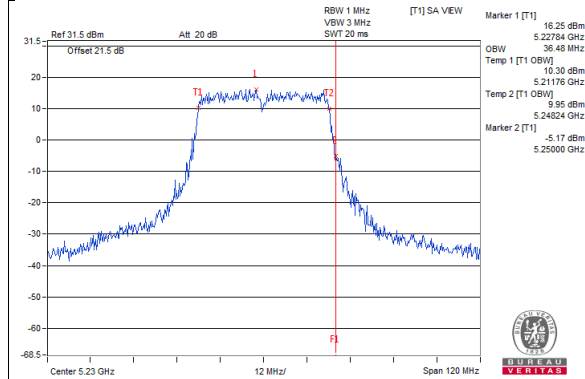

802.11ac(VHT80)_Chain0 / CH42

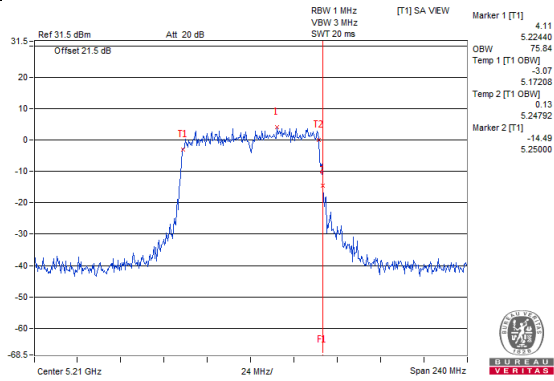

802.11ac(VHT80)_Chain1 / CH42

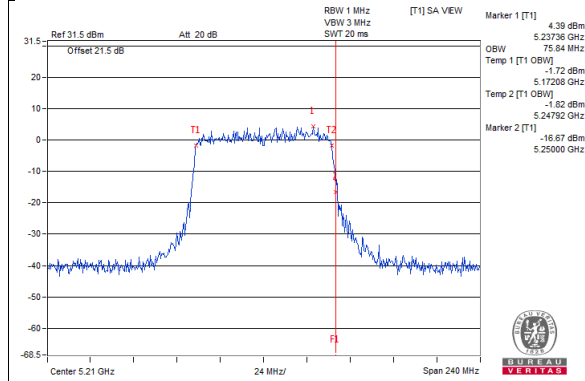

**Spectrum Plot for near by DFS band
(DFS is required, if 99% OCP straddle into U-NII-2C band)**

802.11a_Chain0 / CH149

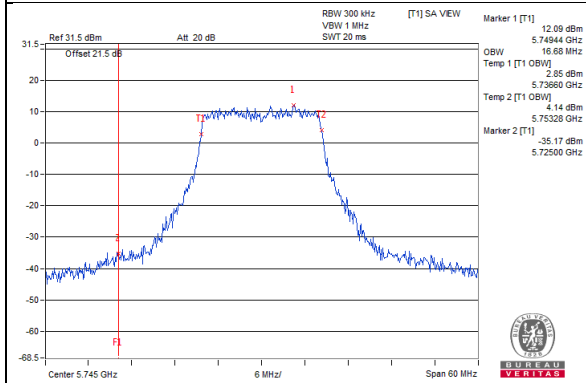

802.11a_Chain1 / CH149

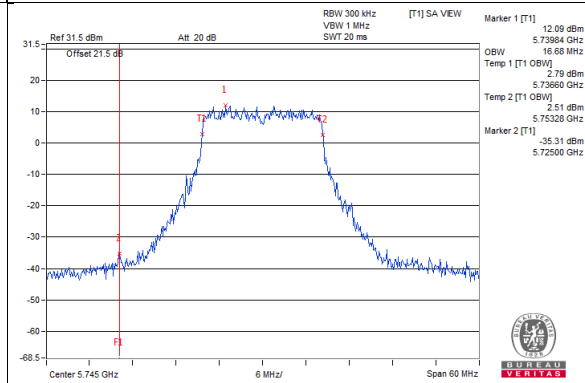

802.11ac(VHT20)_Chain0 / CH149

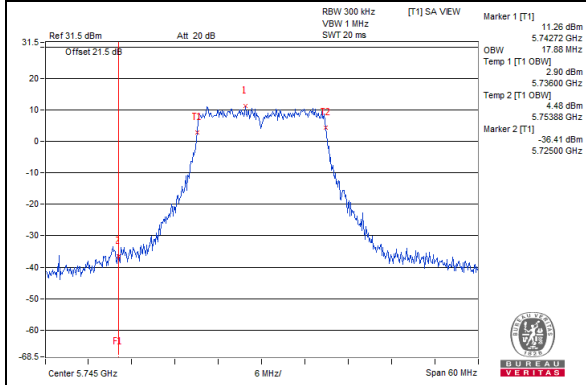

802.11ac(VHT20)_Chain1 / CH149

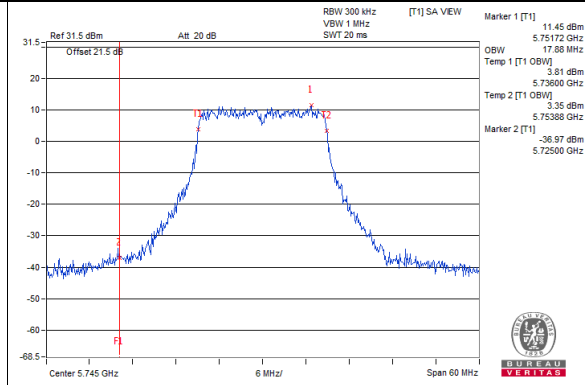

**Spectrum Plot for near by DFS band
(DFS is required, if 99% OCP straddle into U-NII-2C band)**

802.11ac(VHT40)_Chain0 / CH151

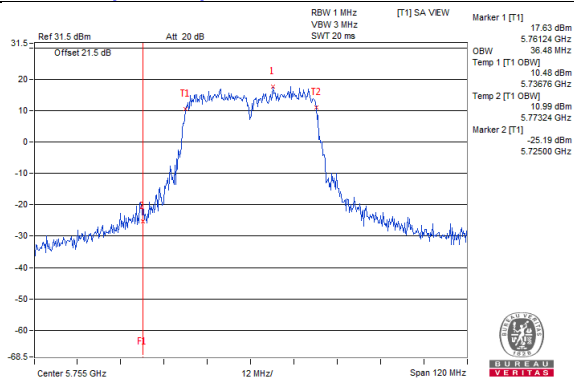

802.11ac(VHT40)_Chain1 / CH151

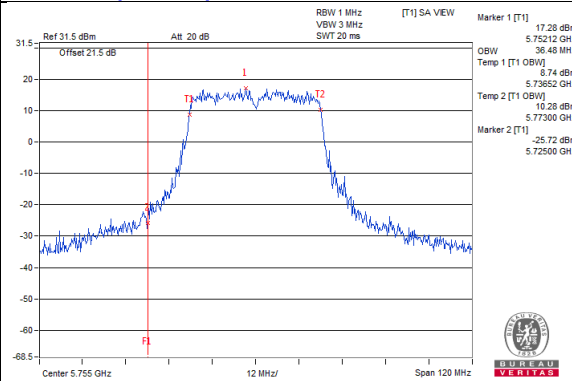

802.11ac(VHT80)_Chain0 / CH155

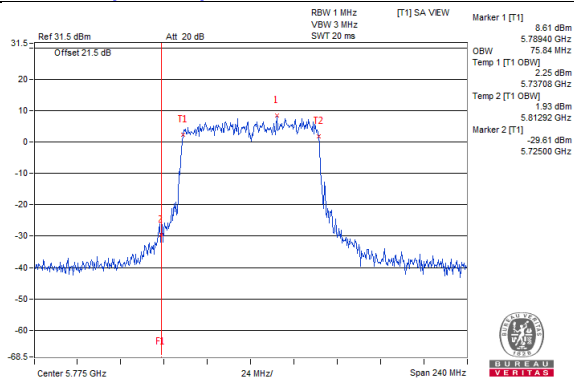

802.11ac(VHT80)_Chain1 / CH155

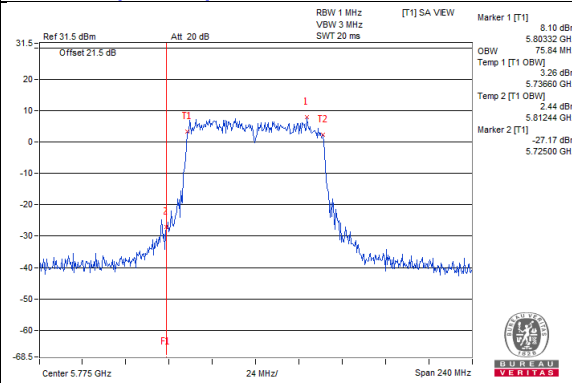

4.5 Peak Power Spectral Density Measurement

4.5.1 Limits of Peak Power Spectral Density Measurement

Operation Band	EUT Category		Limit
U-NII-1		Outdoor Access Point	17dBm/ MHz
		Fixed point-to-point Access Point	
	√	Indoor Access Point	
		Client device	
U-NII-2A	---		11dBm/ MHz
U-NII-2C	---		11dBm/ MHz
U-NII-3	√		30dBm/ 500kHz

4.5.2 Test Setup

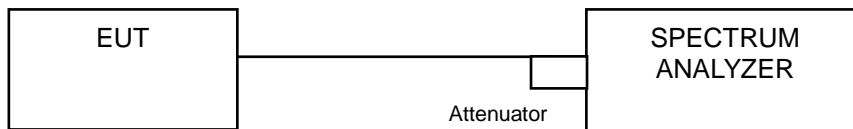

4.5.3 Test Instruments

Refer to section 4.1.2 to get information of above instrument.

4.5.4 Test Procedure

802.11a, 802.11ac (VHT20), 802.11ac (VHT40)

For U-NII-1:

Using method SA-1

1. Set span to encompass the entire emission bandwidth (EBW) of the signal.
2. Set RBW = 1 MHz, Set VBW \geq 3 MHz, Detector = RMS
3. Sweep time = auto, trigger set to "free run".
4. Trace average at least 100 traces in power averaging mode.
5. Record the max value

For U-NII-3:

1. Set span to encompass the entire emission bandwidth (EBW) of the signal.
2. Set RBW = 300 kHz, Set VBW \geq 1 MHz, Detector = RMS
3. Use the peak marker function to determine the maximum power level in any 300 kHz band segment within the fundamental EBW.
4. Scale the observed power level to an equivalent value in 500 kHz by adjusting (reducing) the measured power by a bandwidth correction factor (BWCF) where $BWCF = 10\log(500 \text{ kHz}/300\text{kHz})$
5. Sweep time = auto, trigger set to "free run".
6. Trace average at least 100 traces in power averaging mode.
7. Record the max value

802.11ac (VHT80)

For U-NII-1:

Using method SA-2

1. Set span to encompass the entire emission bandwidth (EBW) of the signal.
2. Set RBW = 1 MHz, Set VBW \geq 3 MHz, Detector = RMS
3. Sweep time = auto, trigger set to "free run".
4. Trace average at least 100 traces in power averaging mode.
5. Record the max value and add $10 \log (1/\text{duty cycle})$

For U-NII-3:

1. Set span to encompass the entire emission bandwidth (EBW) of the signal.
2. Set RBW = 300 kHz, Set VBW \geq 1 MHz, Detector = RMS
3. Use the peak marker function to determine the maximum power level in any 300 kHz band segment within the fundamental EBW.
4. Scale the observed power level to an equivalent value in 500 kHz by adjusting (reducing) the measured power by a bandwidth correction factor (BWCF) where $BWCF = 10\log(500 \text{ kHz}/300\text{kHz})$
5. Sweep time = auto, trigger set to "free run".
6. Trace average at least 100 traces in power averaging mode.
7. Record the max value and add $10 \log (1/\text{duty cycle})$

4.5.5 Deviation from Test Standard

No deviation.

4.5.6 EUT Operating Condition

Same as Item 4.3.6.

4.5.7 Test Results

For U-NII-1:

802.11a

Chan.	Chan. Freq. (MHz)	PSD (dBm/MHz)		Total Power Density (dBm/MHz)	MAX. Limit (dBm/MHz)	Pass / Fail
		Chain 0	Chain 1			
36	5180	6.35	6.94	9.67	14.41	Pass
40	5200	10.84	11.41	14.14	14.41	Pass
48	5240	10.20	10.53	13.38	14.41	Pass

- Note:** 1. Method a) of power density measurement of KDB 662911 is using for calculating total power density. Total power density is summing entire spectra across corresponding frequency bins on the various outputs by computer.
2. Directional gain = $5.58\text{dBi} + 10\log(2) = 8.59\text{dBi} > 6\text{dBi}$, so the power density limit shall be reduced to $17 - (8.59 - 6) = 14.41\text{dBm}$.

802.11ac (VHT20)

Chan.	Chan. Freq. (MHz)	PSD (dBm/MHz)		Total Power Density (dBm/MHz)	MAX. Limit (dBm/MHz)	Pass / Fail
		Chain 0	Chain 1			
36	5180	5.63	5.85	8.75	14.41	Pass
40	5200	10.81	11.18	14.01	14.41	Pass
48	5240	10.30	10.31	13.32	14.41	Pass

- Note:** 1. Method a) of power density measurement of KDB 662911 is using for calculating total power density. Total power density is summing entire spectra across corresponding frequency bins on the various outputs by computer.
2. Directional gain = $5.58\text{dBi} + 10\log(2) = 8.59\text{dBi} > 6\text{dBi}$, so the power density limit shall be reduced to $17 - (8.59 - 6) = 14.41\text{dBm}$.

802.11ac (VHT40)

Chan.	Chan. Freq. (MHz)	PSD (dBm/MHz)		Total Power Density (dBm/MHz)	MAX. Limit (dBm/MHz)	Pass / Fail
		Chain 0	Chain 1			
38	5190	-1.72	-1.59	1.36	14.41	Pass
46	5230	6.69	6.32	9.52	14.41	Pass

- Note:** 1. Method a) of power density measurement of KDB 662911 is using for calculating total power density. Total power density is summing entire spectra across corresponding frequency bins on the various outputs by computer.
2. Directional gain = $5.58\text{dBi} + 10\log(2) = 8.59\text{dBi} > 6\text{dBi}$, so the power density limit shall be reduced to $17 - (8.59 - 6) = 14.41\text{dBm}$.

802.11ac (VHT80)

Chan.	Chan. Freq. (MHz)	PSD W/O Duty Factor (dBm/MHz)		Duty Factor (dB)	Total PSD With Duty Factor (dBm/MHz)	MAX. Limit (dBm/MHz)	Pass / Fail
		Chain 0	Chain 1				
42	5210	-5.71	-5.48	0.10	-2.48	14.41	Pass

- Note:**
- Method a) of power density measurement of KDB 662911 is using for calculating total power density. Total power density is summing entire spectra across corresponding frequency bins on the various outputs by computer.
 - Directional gain = $5.58\text{dBi} + 10\log(2) = 8.59\text{dBi} > 6\text{dBi}$, so the power density limit shall be reduced to $17 - (8.59 - 6) = 14.41\text{dBm}$.
 - Refer to section 3.3 for duty cycle spectrum plot.

Spectrum Plot of Worst Value

802.11a_Chain 1 / CH40

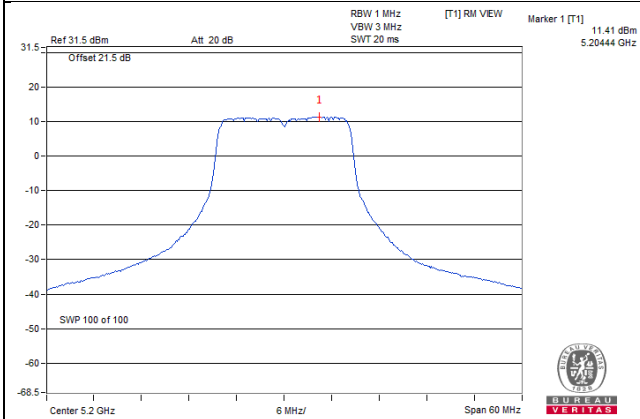

802.11ac (VHT20)_Chain 1 / CH40

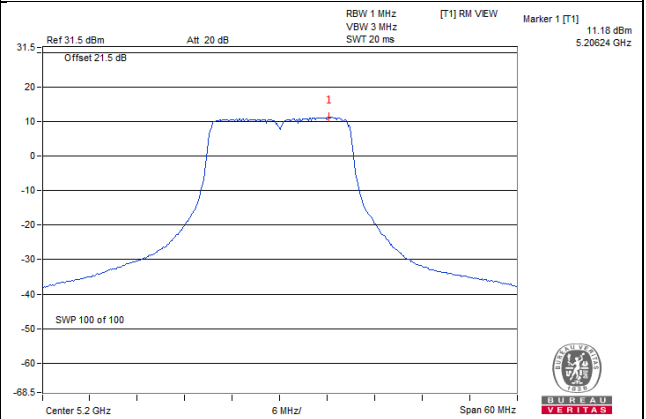

802.11ac (VHT40)_Chain 0 / CH46

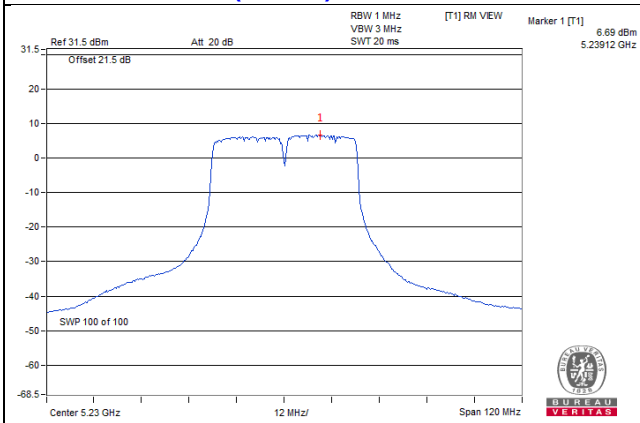

802.11ac (VHT80)_Chain 1 / CH42

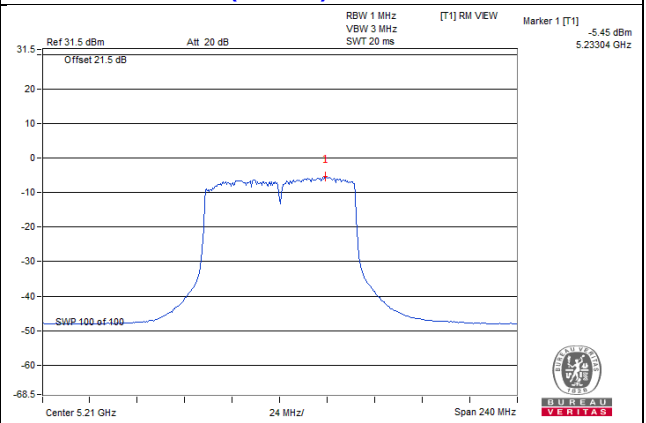

For U-NII-3:
802.11a

TX chain	Channel	Freq. (MHz)	PSD (dBm/300kHz)	PSD (dBm/500kHz)	10 log (N=2) dB	Total PSD (dBm/500kHz)	Limit (dBm/500kHz)	Pass /Fail
0	149	5745	-0.06	2.16	3.01	5.17	27.41	Pass
	157	5785	0.44	2.66	3.01	5.67	27.41	Pass
	165	5825	1.27	3.49	3.01	6.50	27.41	Pass
1	149	5745	-0.66	1.56	3.01	4.57	27.41	Pass
	157	5785	0.70	2.92	3.01	5.93	27.41	Pass
	165	5825	1.43	3.65	3.01	6.66	27.41	Pass

Note: 1. Directional gain = $5.58\text{dBi} + 10\log(2) = 8.59\text{dBi} > 6\text{dBi}$, so the power density limit shall be reduced to $30 - (8.59 - 6) = 27.41\text{dBm}$.

802.11ac (VHT20)

TX chain	Channel	Freq. (MHz)	PSD (dBm/300kHz)	PSD (dBm/500kHz)	10 log (N=2) dB	Total PSD (dBm/500kHz)	Limit (dBm/500kHz)	Pass /Fail
0	149	5745	-0.76	1.46	3.01	4.47	27.41	Pass
	157	5785	0.16	2.38	3.01	5.39	27.41	Pass
	165	5825	1.27	3.49	3.01	6.50	27.41	Pass
1	149	5745	-0.99	1.23	3.01	4.24	27.41	Pass
	157	5785	0.18	2.40	3.01	5.41	27.41	Pass
	165	5825	1.23	3.45	3.01	6.46	27.41	Pass

Note: 1. Directional gain = $5.58\text{dBi} + 10\log(2) = 8.59\text{dBi} > 6\text{dBi}$, so the power density limit shall be reduced to $30 - (8.59 - 6) = 27.41\text{dBm}$.

802.11ac (VHT40)

TX chain	Channel	Freq. (MHz)	PSD (dBm/300kHz)	PSD (dBm/500kHz)	10 log (N=2) dB	Total PSD (dBm/500kHz)	Limit (dBm/500kHz)	Pass /Fail
0	151	5755	-1.40	0.82	3.01	3.83	27.41	Pass
	159	5795	-1.49	0.73	3.01	3.74	27.41	Pass
1	151	5755	-1.45	0.77	3.01	3.78	27.41	Pass
	159	5795	-1.32	0.90	3.01	3.91	27.41	Pass

Note: 1. Directional gain = $5.58\text{dBi} + 10\log(2) = 8.59\text{dBi} > 6\text{dBi}$, so the power density limit shall be reduced to $30 - (8.59 - 6) = 27.41\text{dBm}$.

802.11ac (VHT80)

TX chain	Chan.	Chan. Freq. (MHz)	PSD W/O Duty Factor		10 log (N=2) dB	Duty Factor (dB)	Total PSD With Duty Factor (dBm/500kHz)	Limit (dBm/500kHz)	Pass /Fail
			(dBm/300kHz)	(dBm/500kHz)					
0	155	5775	-10.53	-8.31	3.01	0.10	-5.20	27.41	Pass
1	155	5775	-10.25	-8.03	3.01	0.10	-4.92	27.41	Pass

Note: 1. Directional gain = $5.58\text{dBi} + 10\log(2) = 8.59\text{dBi} > 6\text{dBi}$, so the power density limit shall be reduced to $30 - (8.59 - 6) = 27.41\text{dBm}$.

2. Refer to section 3.3 for duty cycle spectrum plot.

Spectrum Plot of Worst Value

802.11a – Chain 1: CH 165

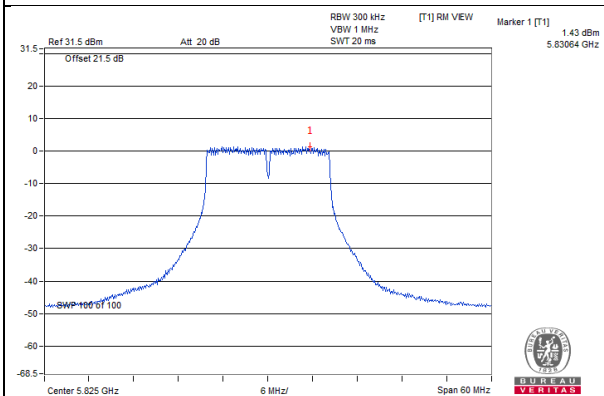

802.11ac (VHT20) – Chain 0: CH 165

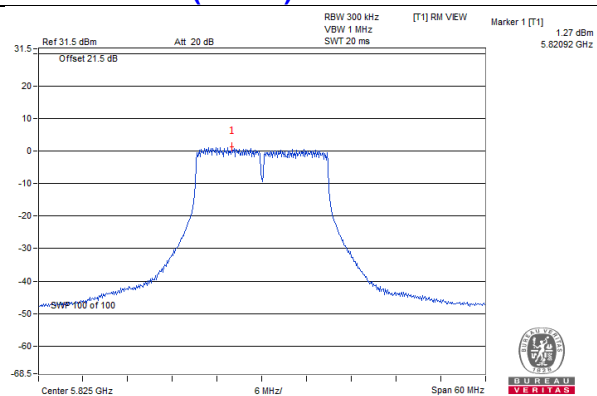

802.11ac (VHT40) – Chain 1: CH 159

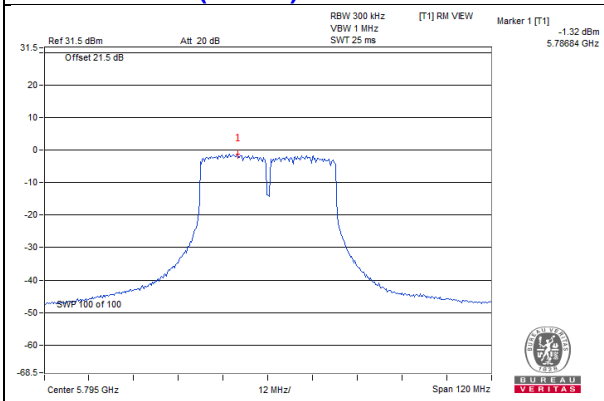

802.11ac (VHT80) – Chain 1: CH 155

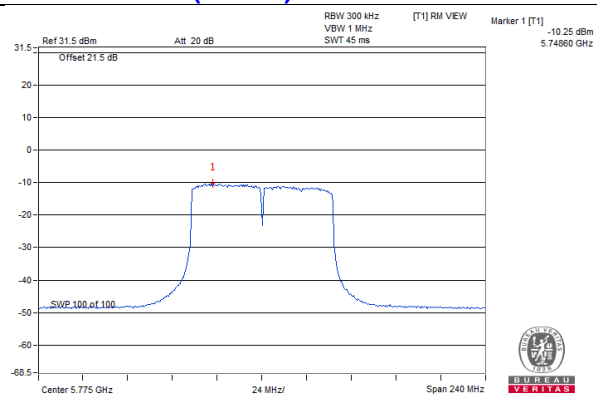

4.6 Frequency Stability Measurement

4.6.1 Limits of Frequency Stability Measurement

The frequency of the carrier signal shall be maintained within band of operation

4.6.2 Test Setup

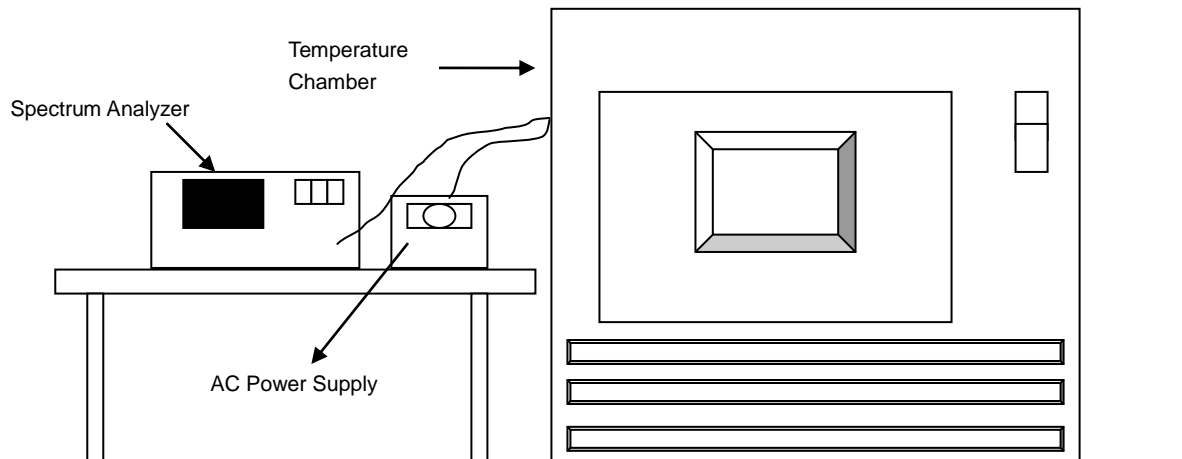

4.6.3 Test Instruments

Refer to section 4.1.2 to get information of above instrument.

4.6.4 Test Procedure

- The EUT was placed inside the environmental test chamber and powered by nominal AC voltage.
- Turn the EUT on and couple its output to a spectrum analyzer.
- Turn the EUT off and set the chamber to the highest temperature specified.
- Allow sufficient time (approximately 30 min) for the temperature of the chamber to stabilize, turn the EUT on and measure the operating frequency after 2, 5, and 10 Minutes.
- Repeat step 2 and 3 with the temperature chamber set to the lowest temperature.
- The test chamber was allowed to stabilize at +20 degree C for a minimum of 30 Minutes. The supply voltage was then adjusted on the EUT from 85% to 115% and the frequency record.

4.6.5 Deviation from Test Standard

No deviation.

4.6.6 EUT Operating Condition

Set the EUT transmit at un-modulation mode to test frequency stability.

4.6.7 Test Results

Frequency Stability Versus Temp.									
Operating Frequency: 5180 MHz									
TEMP. (°C)	Power Supply (Vac)	0 Minute		2 Minutes		5 Minutes		10 Minutes	
		Measured Frequency (MHz)	Pass/Fail	Measured Frequency (MHz)	Pass/Fail	Measured Frequency (MHz)	Pass/Fail	Measured Frequency (MHz)	Pass/Fail
50	120	5179.9947	Pass	5179.9938	Pass	5179.992	Pass	5179.9941	Pass
40	120	5179.9815	Pass	5179.9834	Pass	5179.9805	Pass	5179.9803	Pass
30	120	5179.9992	Pass	5179.9962	Pass	5179.9975	Pass	5179.9968	Pass
20	120	5179.9953	Pass	5179.9957	Pass	5179.993	Pass	5179.9976	Pass
10	120	5180.0217	Pass	5180.0178	Pass	5180.0174	Pass	5180.0172	Pass
0	120	5180.0163	Pass	5180.017	Pass	5180.0146	Pass	5180.0171	Pass
-10	120	5179.98	Pass	5179.9804	Pass	5179.9788	Pass	5179.9805	Pass
-20	120	5179.9834	Pass	5179.9818	Pass	5179.9834	Pass	5179.9805	Pass
-30	120	5180.0095	Pass	5180.0115	Pass	5180.0088	Pass	5180.011	Pass

Frequency Stability Versus Voltage									
Operating Frequency: 5180 MHz									
TEMP. (°C)	Power Supply (Vac)	0 Minute		2 Minutes		5 Minutes		10 Minutes	
		Measured Frequency (MHz)	Pass/Fail	Measured Frequency (MHz)	Pass/Fail	Measured Frequency (MHz)	Pass/Fail	Measured Frequency (MHz)	Pass/Fail
20	138	5179.996	Pass	5179.9965	Pass	5179.9927	Pass	5179.9975	Pass
	120	5179.9953	Pass	5179.9957	Pass	5179.993	Pass	5179.9976	Pass
	102	5179.9949	Pass	5179.9966	Pass	5179.9937	Pass	5179.9967	Pass

4.7 6dB Bandwidth Measurement

4.7.1 Limits of 6dB Bandwidth Measurement

The minimum of 6dB Bandwidth Measurement is 0.5MHz.

4.7.2 Test Setup

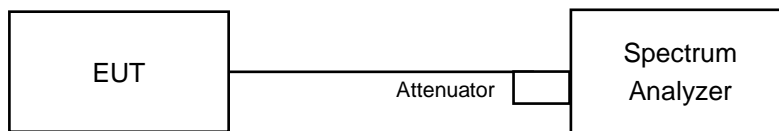

4.7.3 Test Instruments

Refer to section 4.1.2 to get information of above instrument.

4.7.4 Test Procedure

MEASUREMENT PROCEDURE REF

- Set resolution bandwidth (RBW) = 100kHz
- Set the video bandwidth (VBW) $\geq 3 \times$ RBW, Detector = Peak.
- Trace mode = max hold.
- Sweep = auto couple.
- Measure the maximum width of the emission that is constrained by the frequencies associated with the two amplitude points (upper and lower) that are attenuated by 6 dB relative to the maximum level measured in the fundamental emission

4.7.5 Deviation from Test Standard

No deviation.

4.7.6 EUT Operating Condition

The software provided by client to enable the EUT under transmission condition continuously at lowest, middle and highest channel frequencies individually.

4.7.7 Test Results

802.11a

Channel	Frequency (MHz)	6dB Bandwidth (MHz)		Minimum Limit (MHz)	Pass / Fail
		Chain 0	Chain 1		
149	5745	16.43	16.54	0.5	PASS
157	5785	16.56	16.43	0.5	PASS
165	5825	16.47	16.46	0.5	PASS

802.11ac (VHT20)

Channel	Frequency (MHz)	6dB Bandwidth (MHz)		Minimum Limit (MHz)	Pass / Fail
		Chain 0	Chain 1		
149	5745	17.68	17.65	0.5	PASS
157	5785	17.68	17.69	0.5	PASS
165	5825	17.72	17.63	0.5	PASS

802.11ac (VHT40)

Channel	Frequency (MHz)	6dB Bandwidth (MHz)		Minimum Limit (MHz)	Pass / Fail
		Chain 0	Chain 1		
151	5755	36.43	36.52	0.5	PASS
159	5795	36.49	36.45	0.5	PASS

802.11ac (VHT80)

Channel	Frequency (MHz)	6dB Bandwidth (MHz)		Minimum Limit (MHz)	Pass / Fail
		Chain 0	Chain 1		
155	5775	76.46	76.37	0.5	PASS

Spectrum Plot of Worst Value

802.11a_Chain 0 / CH149

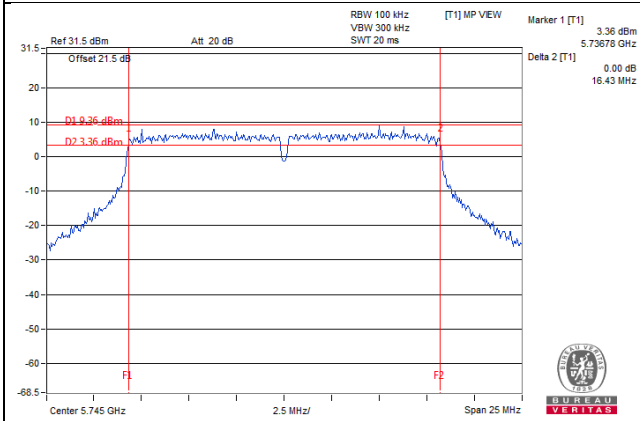

802.11ac (VHT20)_Chain 1 / CH165

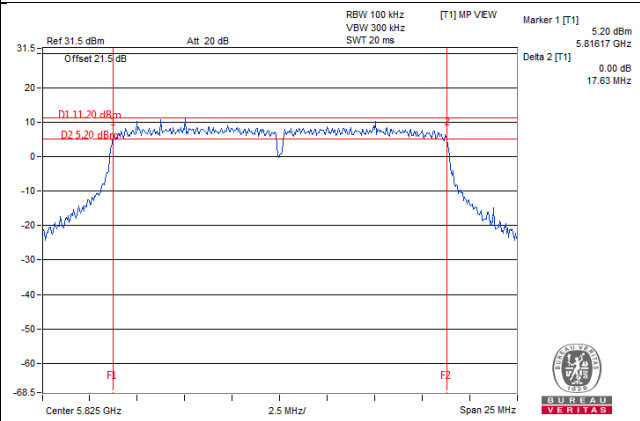

802.11ac (VHT40)_Chain 0 / CH151

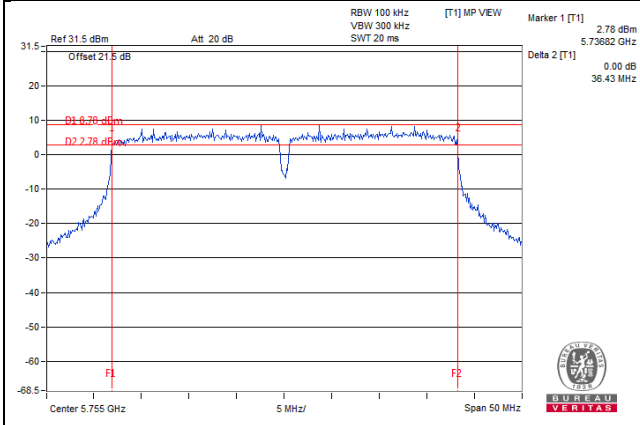

802.11ac (VHT80)_Chain 1 / CH155

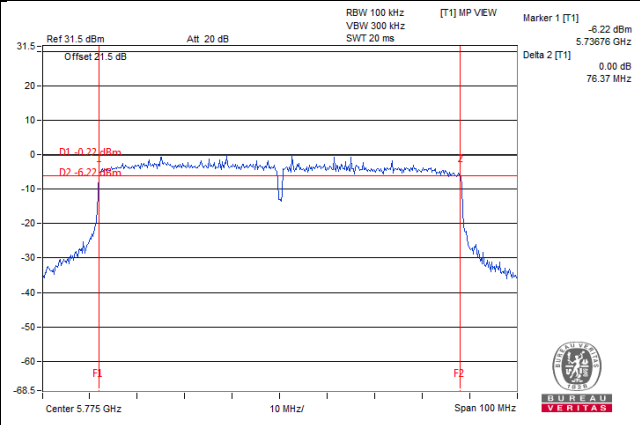

5 Pictures of Test Arrangements

Please refer to the attached file (Test Setup Photo).

Annex A- Radiated Out of Band Emission (OOBE) Measurement (For U-NII-3 band)

802.11a

CH 149 5745 MHz

Horizontal

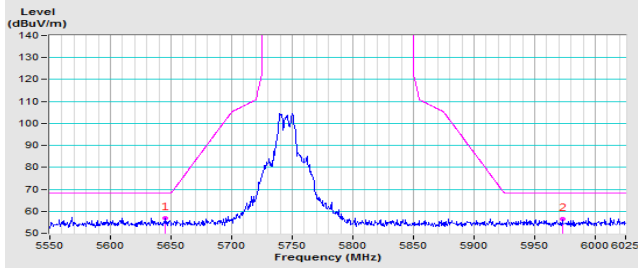

Vertical

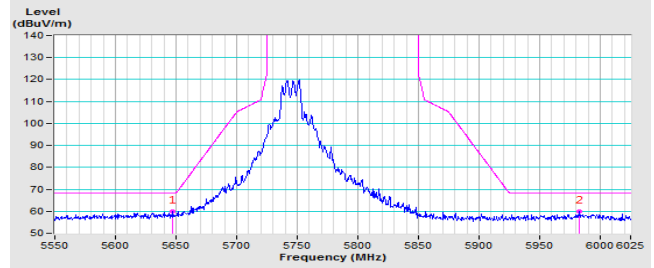

CH 157 5785 MHz

Horizontal

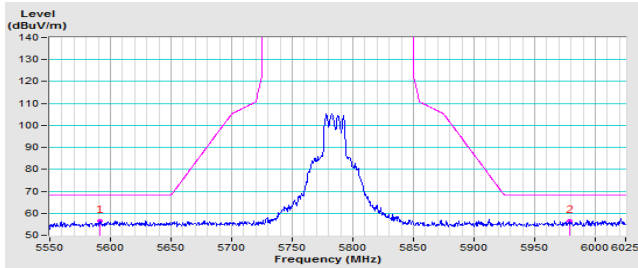

Vertical

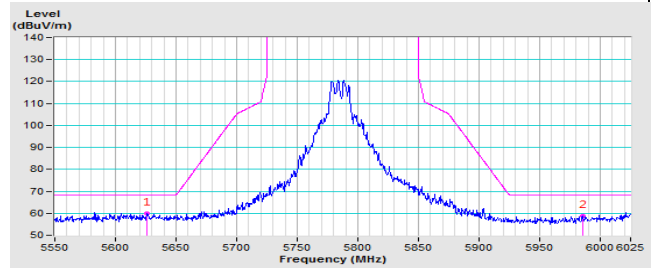

CH 165 5825 MHz

Horizontal

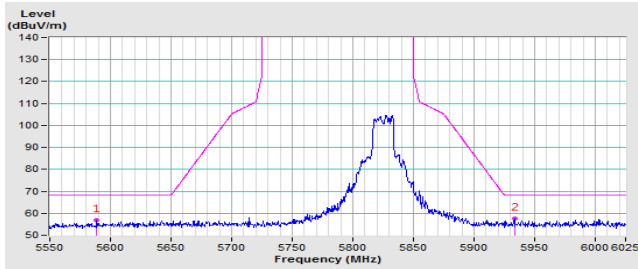

Vertical

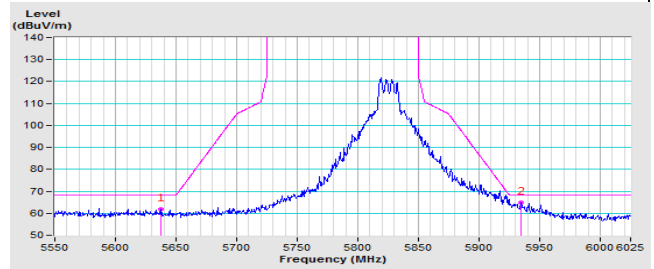

802.11ac (VHT20)

CH 149 5745 MHz

Horizontal

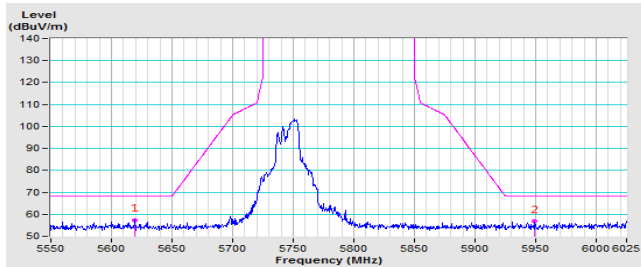

Vertical

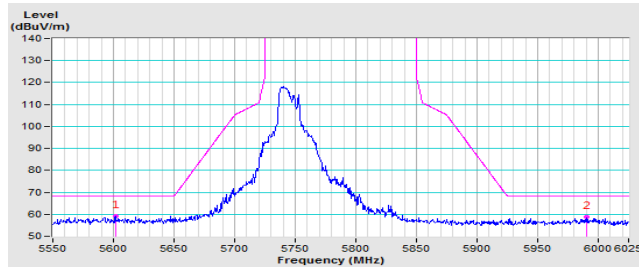

CH 157 5785 MHz

Horizontal

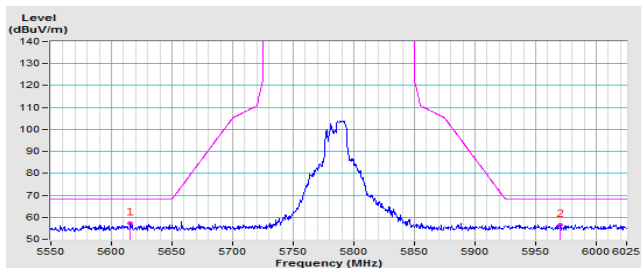

Vertical

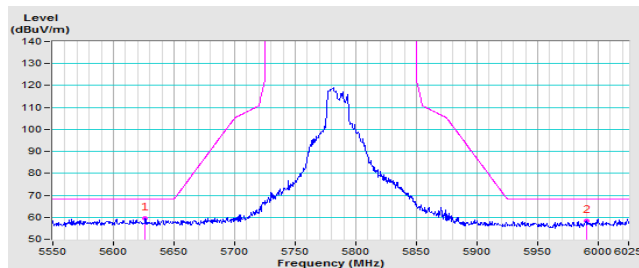

CH 165 5825 MHz

Horizontal

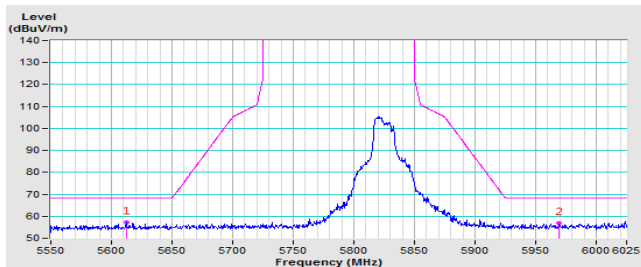

Vertical

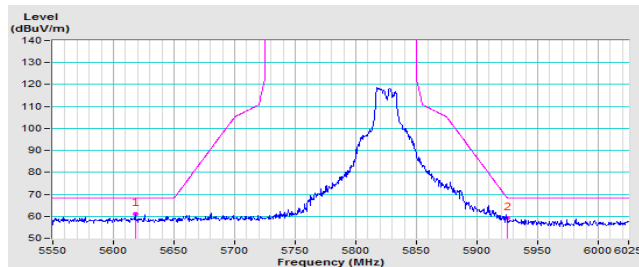

802.11ac (VHT40)

CH 151 5755 MHz

Horizontal

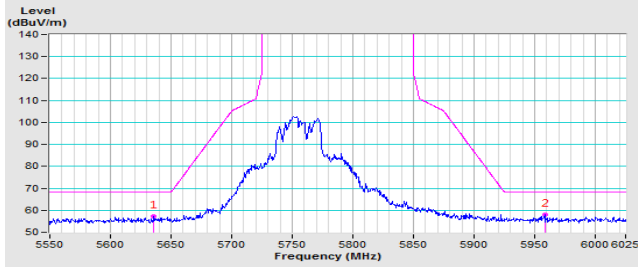

Vertical

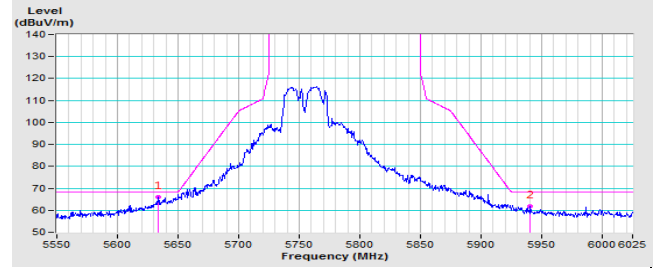

CH 159 5795 MHz

Horizontal

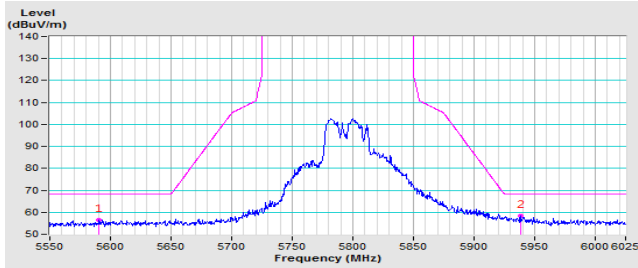

Vertical

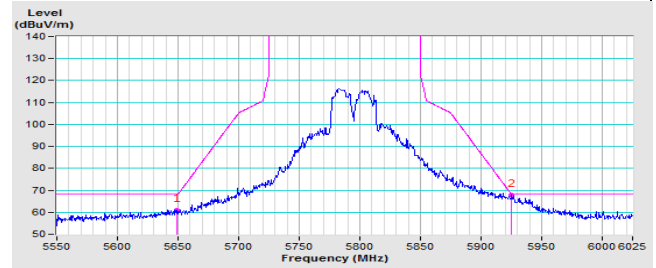

802.11ac (VHT80)

CH 155 5775 MHz

Horizontal

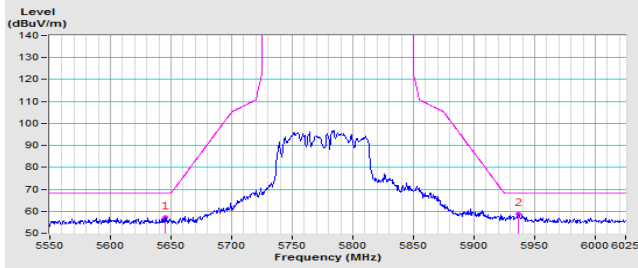

Vertical

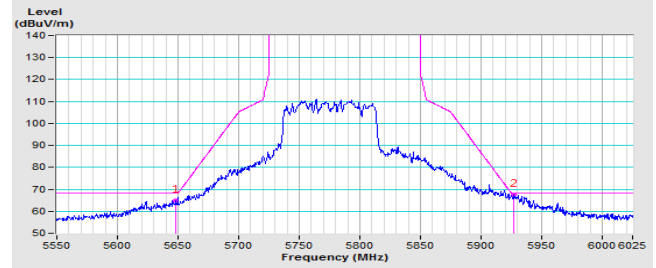

Appendix – Information on the Testing Laboratories

We, Bureau Veritas Consumer Products Services (H.K.) Ltd., Taoyuan Branch, were founded in 1988 to provide our best service in EMC, Radio, Telecom and Safety consultation. Our laboratories are FCC recognized accredited test firms and accredited according to ISO/IEC 17025.

If you have any comments, please feel free to contact us at the following:

Linkou EMC/RF Lab

Tel: 886-2-26052180

Fax: 886-2-26051924

Hsin Chu EMC/RF/Telecom Lab

Tel: 886-3-6668565

Fax: 886-3-6668323

Hwa Ya EMC/RF/Safety Lab

Tel: 886-3-3183232

Fax: 886-3-3270892

Email: service.adt@tw.bureauveritas.com

Web Site: www.bureauveritas-adt.com

The address and road map of all our labs can be found in our web site also.

--- END ---