

FCC Test Report (WLAN)

Report No.: RF171215C04C-1

FCC ID: YZKECWO5211L

Test Model: ECWO5211-L

Received Date: Dec. 15, 2017

Test Date: Jan. 10 to 17, 2018

Issued Date: Apr. 11, 2018

Applicant: Edgecore Networks Corporation

Address: No.1, Creation 3rd Rd., Hsinchu Science Park, East Dist., Hsinchu City
30077, Taiwan, R.O.C

Issued By: Bureau Veritas Consumer Products Services (H.K.) Ltd., Taoyuan Branch
Hsin Chu Laboratory

Lab Address: E-2, No.1, Li Hsin 1st Road, Hsinchu Science Park, Hsinchu City 300,
Taiwan R.O.C.

Test Location: E-2, No.1, Li Hsin 1st Road, Hsinchu Science Park, Hsinchu City 300,
Taiwan R.O.C.

**FCC Registration /
Designation Number:** 723255 / TW2022



This report is for your exclusive use. Any copying or replication of this report to or for any other person or entity, or use of our name or trademark, is permitted only with our prior written permission. This report sets forth our findings solely with respect to the test samples identified herein. The results set forth in this report are not indicative or representative of the quality or characteristics of the lot from which a test sample was taken or any similar or identical product unless specifically and expressly noted. Our report includes all of the tests requested by you and the results thereof based upon the information that you provided to us. You have 60 days from date of issuance of this report to notify us of any material error or omission caused by our negligence, provided, however, that such notice shall be in writing and shall specifically address the issue you wish to raise. A failure to raise such issue within the prescribed time shall constitute your unqualified acceptance of the completeness of this report, the tests conducted and the correctness of the report contents. Unless specific mention, the uncertainty of measurement has been explicitly taken into account to declare the compliance or non-compliance to the specification. The report must not be used by the client to claim product certification, approval, or endorsement by TAF or any government agencies.

Table of Contents

Release Control Record	4
1 Certificate of Conformity	5
2 Summary of Test Results	6
2.1 Measurement Uncertainty	6
2.2 Modification Record	6
3 General Information	7
3.1 General Description of EUT (WLAN)	7
3.2 Description of Test Modes	10
3.2.1 Test Mode Applicability and Tested Channel Detail	11
3.3 Duty Cycle of Test Signal	14
3.4 Description of Support Units	15
3.4.1 Configuration of System under Test	16
3.5 General Description of Applied Standard	17
4 Test Types and Results	18
4.1 Radiated Emission and Bandedge Measurement	18
4.1.1 Limits of Radiated Emission and Bandedge Measurement	18
4.1.2 Test Instruments	19
4.1.3 Test Procedure	20
4.1.4 Deviation from Test Standard	20
4.1.5 Test Setup	21
4.1.6 EUT Operating Condition	22
4.1.7 Test Results	23
4.2 Conducted Emission Measurement	42
4.2.1 Limits of Conducted Emission Measurement	42
4.2.2 Test Instruments	42
4.2.3 Test Procedure	43
4.2.4 Deviation from Test Standard	43
4.2.5 Test Setup	43
4.2.6 EUT Operating Condition	43
4.2.7 Test Results	44
4.3 Transmit Power Measurement	46
4.3.1 Limits of Transmit Power Measurement	46
4.3.2 Test Setup	46
4.3.3 Test Instruments	46
4.3.4 Test Procedure	46
4.3.5 Deviation from Test Standard	46
4.3.6 EUT Operating Condition	46
4.3.7 Test Result	47
4.4 Occupied Bandwidth Measurement	52
4.4.1 Test Setup	52
4.4.2 Test Instruments	52
4.4.3 Test Procedure	52
4.4.4 Test Results	53
4.5 Peak Power Spectral Density Measurement	61
4.5.1 Limits of Peak Power Spectral Density Measurement	61
4.5.2 Test Setup	61
4.5.3 Test Instruments	61
4.5.4 Test Procedure	62
4.5.5 Deviation from Test Standard	62
4.5.6 EUT Operating Condition	62
4.5.7 Test Results	63
4.6 Frequency Stability Measurement	72
4.6.1 Limits of Frequency Stability Measurement	72

4.6.2	Test Setup.....	72
4.6.3	Test Instruments	72
4.6.4	Test Procedure	72
4.6.5	Deviation from Test Standard	72
4.6.6	EUT Operating Condition	72
4.6.7	Test Results	73
4.7	6dB Bandwidth Measurement	74
4.7.1	Limits of 6dB Bandwidth Measurement.....	74
4.7.2	Test Setup.....	74
4.7.3	Test Instruments	74
4.7.4	Test Procedure	74
4.7.5	Deviation from Test Standard	74
4.7.6	EUT Operating Condition	74
4.7.7	Test Results	75
5	Pictures of Test Arrangements.....	77
	Annex A- Radiated Out of Band Emission (OOBE) Measurement (For U-NII-3 band)	78
	Appendix – Information on the Testing Laboratories	82

Release Control Record

Issue No.	Description	Date Issued
RF171215C04C-1	Original release.	Apr. 11, 2018

1 Certificate of Conformity

Product: CONCURRENT DUAL-BAND 11AC WAVE 2 AP

Brand: Edgecore

Test Model: ECWO5211-L

Sample Status: ENGINEERING SAMPLE

Applicant: Edgecore Networks Corporation

Test Date: Jan. 10 to 17, 2018

Standard: 47 CFR FCC Part 15, Subpart E (Section 15.407)
ANSI C63.10: 2013

The above equipment has been tested by **Bureau Veritas Consumer Products Services (H.K.) Ltd., Taoyuan Branch**, and found compliance with the requirement of the above standards. The test record, data evaluation & Equipment Under Test (EUT) configurations represented herein are true and accurate accounts of the measurements of the sample's EMC characteristics under the conditions specified in this report.

Prepared by : Mary Ko , **Date:** Apr. 11, 2018
Mary Ko / Specialist

Approved by : May Chen , **Date:** Apr. 11, 2018
May Chen / Manager

2 Summary of Test Results

47 CFR FCC Part 15, Subpart E (Section 15.407)			
FCC Clause	Test Item	Result	Remarks
15.407(b)(6)	AC Power Conducted Emissions	Pass	Meet the requirement of limit. Minimum passing margin is -8.98dB at 0.38438MHz.
15.407(b) (1/2/3/4(i/ii)/6)	Radiated Emissions & Band Edge Measurement*	Pass	Meet the requirement of limit. Minimum passing margin is -0.1dB at 5150.00MHz.
15.407(a)(1/2/3)	Max Average Transmit Power	Pass	Meet the requirement of limit.
---	Occupied Bandwidth Measurement	-	Reference only.
15.407(a)(1/2/3)	Peak Power Spectral Density	Pass	Meet the requirement of limit.
15.407(e)	6dB bandwidth	Pass	Meet the requirement of limit. (U-NII-3 Band only)
15.407(g)	Frequency Stability	Pass	Meet the requirement of limit.
15.203	Antenna Requirement	Pass	The device is professionally installed.

*For U-NII-3 band compliance with rule part 15.407(b)(4)(i), the OOB test plots were recorded in Annex A.

2.1 Measurement Uncertainty

Where relevant, the following measurement uncertainty levels have been estimated for tests performed on the EUT as specified in CISPR 16-4-2:

Measurement	Frequency	Expanded Uncertainty (k=2) (\pm)
Conducted Emissions at mains ports	150kHz ~ 30MHz	1.84 dB
Radiated Emissions up to 1 GHz	30MHz ~ 1GHz	5.30 dB
Radiated Emissions above 1 GHz	1GHz ~ 6GHz	5.16 dB
	6GHz ~ 18GHz	4.91 dB
	18GHz ~ 40GHz	5.30 dB

2.2 Modification Record

There were no modifications required for compliance.

3 General Information

3.1 General Description of EUT (WLAN)

Product	CONCURRENT DUAL-BAND 11AC WAVE 2 AP
Brand	Edgecore
Test Model	ECWO5211-L
Status of EUT	ENGINEERING SAMPLE
Power Supply Rating	48Vdc from POE
Modulation Type	CCK, DQPSK, DBPSK for DSSS 64QAM, 16QAM, QPSK, BPSK for OFDM 256QAM for OFDM in 11ac mode only
Modulation Technology	DSSS, OFDM
Transfer Rate	802.11a/b: up to 11Mbps 802.11g: up to 54Mbps 802.11n: up to 300Mbps 802.11ac: up to 866.7Mbps
Operating Frequency	2.4GHz: 2.412 ~ 2.462GHz 5GHz: 5.18GHz ~ 5.24GHz, 5.745GHz ~ 5.825GHz
Number of Channel	2.4GHz: 802.11b, 802.11g, 802.11n (HT20): 11 802.11n (HT40): 7 5GHz: 802.11a, 802.11n (HT20), 802.11ac (VHT20): 9 802.11n (HT40), 802.11ac (VHT40): 4 802.11ac (VHT80): 2
Output Power	2.4GHz: 645.727mW 5.18 ~ 5.24GHz: Master mode: 201.731mW Client mode: 201.971mW 5.745 ~ 5.825GHz: 782.596mW
Antenna Type	Refer to Note
Antenna Connector	Refer to Note
Accessory Device	POE x 1
Data Cable Supplied	NA

Note:

1. There are WLAN, Bluetooth and GPS technology used for the EUT.
2. This device can support different category application which switched by access point mode and client mode by software.
3. The EUT contains certified BT-LE module which FCC ID: RC6-M2-TBT.
4. Simultaneously transmission condition.

Condition	Technology		
1	WLAN 2.4GHz	WLAN 5GHz	Bluetooth

Note: The emission of the simultaneous operation has been evaluated and no non-compliance was found.

5. The EUT must be supplied with a POE as following table:

No.	Brand	Model No.	Spec.
1	Powertron Electronics corp.	POE1024-480T3A050	AC Input: 100-240Vac, 1.0A, 50-60Hz DC Output: 48V, 0.5A

6. The antennas provided to the EUT, please refer to the following table:

2.4GHz antenna spec.				
Antenna No.	Frequency (MHz)	Peak Gain (dBi)	Antenna Type	Connector Type
1	2400	4.87	Dipole antenna	N-type
	2450	4.9		
	2500	4.92		
2	2400	4.87		
	2450	4.9		
	2500	4.92		
5GHz antenna spec.				
Antenna No.	Frequency (MHz)	Peak Gain (dBi)	Antenna Type	Connector Type
1	5150	6.87	Dipole antenna	N-type
	5250	6.8		
	5350	6.76		
	5450	6.83		
	5550	6.85		
	5650	6.75		
	5750	6.92		
	5850	6.83		
2	5150	6.87		
	5250	6.8		
	5350	6.76		
	5450	6.83		
	5550	6.85		
	5650	6.75		
	5750	6.92		
	5850	6.83		
Bluetooth antenna spec.				
Frequency (MHz)	Peak Gain (dBi)	Antenna Type	Connector Type	
2400	3.71	PIFA	None	
2450	3.79			
2500	3.88			

GPS antenna spec.

Frequency (MHz)	Peak Gain (dBiC)		Antenna Type	Connector Type
	Horizontal	Vertical		
1575	2.8	3.8	PIFA	Mini PCI
1575.4	2.7	3.7		
1610	3.9	3.4		

Note:

1. Max. gain was selected for the final test.

7. The EUT incorporates a MIMO function:

2.4GHz Band

MODULATION MODE	DATA RATE (MCS)	TX & RX CONFIGURATION	
802.11b	1 ~ 11Mbps	2TX	2RX
802.11g	6 ~ 54Mbps	2TX	2RX
802.11n (HT20)	MCS 0~7	2TX	2RX
	MCS 8~15	2TX	2RX
802.11n (HT40)	MCS 0~7	2TX	2RX
	MCS 8~15	2TX	2RX

5GHz Band

MODULATION MODE	DATA RATE (MCS)	TX & RX CONFIGURATION	
802.11a	6 ~ 54Mbps	2TX	2RX
802.11n (HT20)	MCS 0~7	2TX	2RX
	MCS 8~15	2TX	2RX
802.11n (HT40)	MCS 0~7	2TX	2RX
	MCS 8~15	2TX	2RX
802.11ac (VHT20)	MCS 0~8, Nss=1	2TX	2RX
	MCS 0~8, Nss=2	2TX	2RX
802.11ac (VHT40)	MCS 0~9, Nss=1	2TX	2RX
	MCS 0~9, Nss=2	2TX	2RX
802.11ac (VHT80)	MCS 0~9, Nss=1	2TX	2RX
	MCS 0~9, Nss=2	2TX	2RX

8. The above EUT information is declared by manufacturer and for more detailed features description, please refer to the manufacturer's specifications or user's manual.

3.2 Description of Test Modes

FOR 5180 ~ 5240MHz

4 channels are provided for 802.11a, 802.11n (HT20), 802.11ac (VHT20):

Channel	Frequency	Channel	Frequency
36	5180MHz	44	5220MHz
40	5200MHz	48	5240MHz

2 channels are provided for 802.11n (HT40), 802.11ac (VHT40):

Channel	Frequency	Channel	Frequency
38	5190MHz	46	5230MHz

1 channel is provided for 802.11ac (VHT80):

Channel	Frequency
42	5210MHz

FOR 5745 ~ 5825MHz:

5 channels are provided for 802.11a, 802.11n (HT20), 802.11ac (VHT20):

Channel	Frequency	Channel	Frequency
149	5745MHz	161	5805MHz
153	5765MHz	165	5825MHz
157	5785MHz		

2 channels are provided for 802.11n (HT40), 802.11ac (VHT40):

Channel	Frequency	Channel	Frequency
151	5755MHz	159	5795MHz

1 channel is provided for 802.11ac (VHT80):

Channel	Frequency
155	5775MHz

3.2.1 Test Mode Applicability and Tested Channel Detail

EUT Configure Mode	Applicable To				Description
	RE \geq 1G	RE<1G	PLC	APCM	
-	√	√	√	√	-

Where **RE \geq 1G**: Radiated Emission above 1GHz **RE<1G**: Radiated Emission below 1GHz
PLC: Power Line Conducted Emission **APCM**: Antenna Port Conducted Measurement

Radiated Emission Test (Above 1GHz):

- Pre-Scan has been conducted to determine the worst-case mode from all possible combinations between available modulations, data rates and antenna ports (if EUT with antenna diversity architecture).
- Following channel(s) was (were) selected for the final test as listed below.

Mode	FREQ. Band (MHz)	Available Channel	Tested Channel	Modulation Technology	Modulation Type	Data Rate (Mbps)
802.11a	5180-5240	36 to 48	36, 40, 48	OFDM	BPSK	6
802.11ac (VHT20)		36 to 48	36, 40, 48	OFDM	BPSK	6.5
802.11ac (VHT40)		38 to 46	38, 46	OFDM	BPSK	13.5
802.11ac (VHT80)		42	42	OFDM	BPSK	29.3
802.11a	5745-5825	149 to 165	149, 157, 165	OFDM	BPSK	6
802.11ac (VHT20)		149 to 165	149, 157, 165	OFDM	BPSK	6.5
802.11ac (VHT40)		151 to 159	151, 159	OFDM	BPSK	13.5
802.11ac (VHT80)		155	155	OFDM	BPSK	29.3

Radiated Emission Test (Below 1GHz):

- Pre-Scan has been conducted to determine the worst-case mode from all possible combinations between available modulations, data rates and antenna ports (if EUT with antenna diversity architecture).
- Following channel(s) was (were) selected for the final test as listed below.

Mode	FREQ. Band (MHz)	Available Channel	Tested Channel	Modulation Technology	Modulation Type	Data Rate (Mbps)
802.11ac (VHT40)	5180-5240 5745-5825	38 to 46 151 to 159	159	OFDM	BPSK	13.5

Power Line Conducted Emission Test:

- Pre-Scan has been conducted to determine the worst-case mode from all possible combinations between available modulations, data rates and antenna ports (if EUT with antenna diversity architecture).
- Following channel(s) was (were) selected for the final test as listed below.

Mode	FREQ. Band (MHz)	Available Channel	Tested Channel	Modulation Technology	Modulation Type	Data Rate (Mbps)
802.11ac (VHT40)	5180-5240 5745-5825	38 to 46 151 to 159	159	OFDM	BPSK	13.5

Antenna Port Conducted Measurement:

- This item includes all test value of each mode, but only includes spectrum plot of worst value of each mode.
- Pre-Scan has been conducted to determine the worst-case mode from all possible combinations between available modulations, data rates and antenna ports (if EUT with antenna diversity architecture).
- Following channel(s) was (were) selected for the final test as listed below.

Master mode						
Mode	FREQ. Band (MHz)	Available Channel	Tested Channel	Modulation Technology	Modulation Type	Data Rate (Mbps)
802.11a	5180-5240	36 to 48	36, 40, 48	OFDM	BPSK	6
802.11ac (VHT20)		36 to 48	36, 40, 48	OFDM	BPSK	6.5
802.11ac (VHT40)		38 to 46	38, 46	OFDM	BPSK	13.5
802.11ac (VHT80)		42	42	OFDM	BPSK	29.3
Client mode						
Mode	FREQ. Band (MHz)	Available Channel	Tested Channel	Modulation Technology	Modulation Type	Data Rate (Mbps)
802.11a	5180-5240	36 to 48	36, 40, 48	OFDM	BPSK	6
802.11ac (VHT20)		36 to 48	36, 40, 48	OFDM	BPSK	6.5
802.11ac (VHT40)		38 to 46	38, 46	OFDM	BPSK	13.5
802.11ac (VHT80)		42	42	OFDM	BPSK	29.3
Master mode						
Mode	FREQ. Band (MHz)	Available Channel	Tested Channel	Modulation Technology	Modulation Type	Data Rate (Mbps)
802.11a	5745-5825	149 to 165	149, 157, 165	OFDM	BPSK	6
802.11ac (VHT20)		149 to 165	149, 157, 165	OFDM	BPSK	6.5
802.11ac (VHT40)		151 to 159	151, 159	OFDM	BPSK	13.5
802.11ac (VHT80)		155	155	OFDM	BPSK	29.3

Test Condition:

Applicable To	Environmental Conditions	Input Power	Tested By
RE \geq 1G	24deg. C, 73%RH	120Vac, 60Hz	Rey Chen Andy Ho
RE<1G	23deg. C, 66%RH	120Vac, 60Hz	Andy Ho
PLC	25deg. C, 75%RH	120Vac, 60Hz	Andy Ho
APCM	25deg. C, 60%RH	120Vac, 60Hz	Robert Cheng

3.3 Duty Cycle of Test Signal

If duty cycle of test signal is $\geq 98\%$, duty factor is not required.

If duty cycle of test signal is $< 98\%$, duty factor shall be considered.

802.11a: Duty cycle = $2.024/2.113 = 0.958$, Duty factor = $10 * \log(1/0.958) = 0.19$

802.11ac (VHT20): Duty cycle = $4.959/5.049 = 0.982$

802.11ac (VHT40): Duty cycle = $2.407/2.508 = 0.96$, Duty factor = $10 * \log(1/0.96) = 0.18$

802.11ac (VHT80): Duty cycle = $1.135/1.215 = 0.934$, Duty factor = $10 * \log(1/0.934) = 0.30$

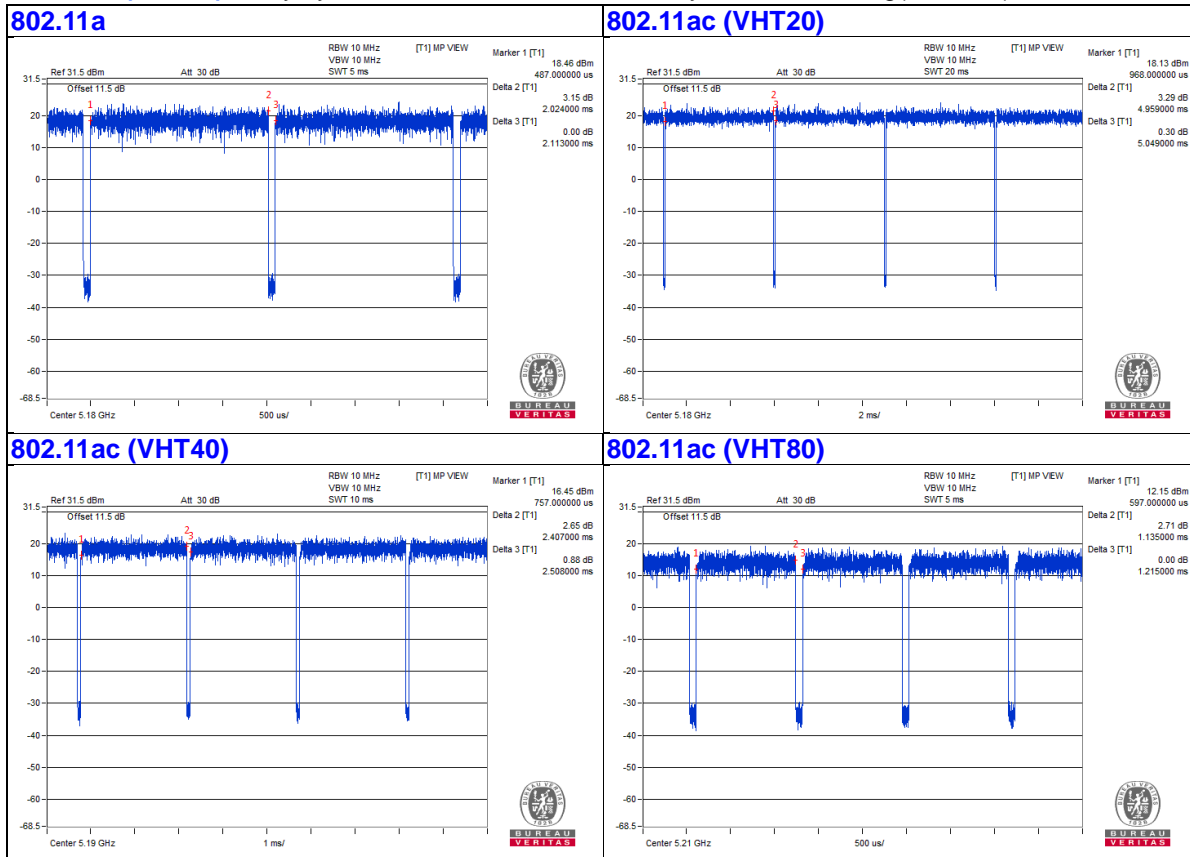

3.4 Description of Support Units

The EUT has been tested as an independent unit together with other necessary accessories or support units. The following support units or accessories were used to form a representative test configuration during the tests.

ID	Product	Brand	Model No.	Serial No.	FCC ID	Remarks
A.	Laptop	DELL	E6420	482T3R1	FCC DoC	Provided by Lab
B.	Laptop	DELL	E6420	B92T3R1	FCC DoC	Provided by Lab

Note: All power cords of the above support units are non-shielded (1.8m).

ID	Descriptions	Qty.	Length (m)	Shielding (Yes/No)	Cores (Qty.)	Remarks
1.	RJ-45 Cable	1	3	No	0	Provided by Lab
2.	RJ-45 Cable	1	10	No	0	Provided by Lab
3.	RJ-45 Cable	1	10	No	0	Provided by Lab
4.	GND Cable	1	3	No	0	Supplied by client

3.4.1 Configuration of System under Test

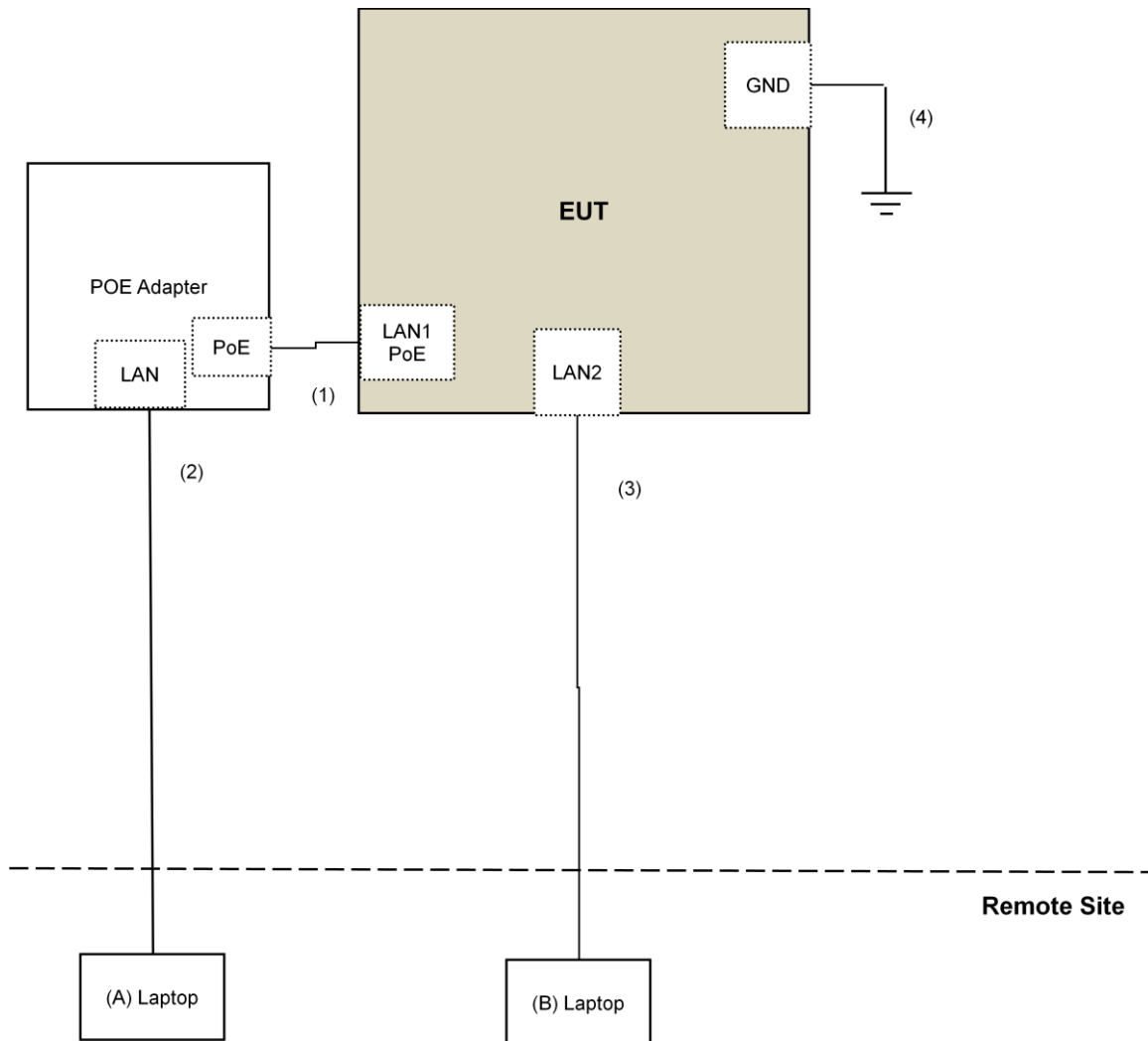

3.5 General Description of Applied Standard

The EUT is a RF Product. According to the specifications of the manufacturer, it must comply with the requirements of the following standards:

FCC Part 15, Subpart E (15.407)

KDB 789033 D02 General UNII Test Procedure New Rules v02r01

KDB 662911 D01 Multiple Transmitter Output v02r01

ANSI C63.10-2013

All test items have been performed and recorded as per the above standards.

4 Test Types and Results

4.1 Radiated Emission and Bandedge Measurement

4.1.1 Limits of Radiated Emission and Bandedge Measurement

Radiated emissions which fall in the restricted bands must comply with the radiated emission limits specified as below table.

Frequencies (MHz)	Field Strength (microvolts/meter)	Measurement Distance (meters)
0.009 ~ 0.490	2400/F(kHz)	300
0.490 ~ 1.705	24000/F(kHz)	30
1.705 ~ 30.0	30	30
30 ~ 88	100	3
88 ~ 216	150	3
216 ~ 960	200	3
Above 960	500	3

NOTE:

1. The lower limit shall apply at the transition frequencies.
2. Emission level (dBuV/m) = 20 log Emission level (uV/m).
3. For frequencies above 1000MHz, the field strength limits are based on average detector, however, the peak field strength of any emission shall not exceed the maximum permitted average limits, specified above by more than 20dB under any condition of modulation.

Limits of unwanted emission out of the restricted bands

Applicable To		Limit	
789033 D02 General UNII Test Procedure New Rules v02r01		Field Strength at 3m	
		PK:74 (dBuV/m)	AV:54 (dBuV/m)
Frequency Band	Applicable To	EIRP Limit	Equivalent Field Strength at 3m
5150~5250 MHz	15.407(b)(1)	PK:-27 (dBm/MHz)	PK:68.2(dBuV/m)
5250~5350 MHz	15.407(b)(2)		
5470~5725 MHz	15.407(b)(3)		
5725~5850 MHz	<input checked="" type="checkbox"/> 15.407(b)(4)(i)	PK:-27 (dBm/MHz) ^{*1} PK:10 (dBm/MHz) ^{*2} PK:15.6 (dBm/MHz) ^{*3} PK:27 (dBm/MHz) ^{*4}	PK: 68.2(dBuV/m) ^{*1} PK:105.2 (dBuV/m) ^{*2} PK: 110.8(dBuV/m) ^{*3} PK:122.2 (dBuV/m) ^{*4}
	<input type="checkbox"/> 15.407(b)(4)(ii)	Emission limits in section 15.247(d)	
^{*1} beyond 75 MHz or more above of the band edge.		^{*2} below the band edge increasing linearly to 10 dBm/MHz at 25 MHz above.	
^{*3} below the band edge increasing linearly to a level of 15.6 dBm/MHz at 5 MHz above.		^{*4} from 5 MHz above or below the band edge increasing linearly to a level of 27 dBm/MHz at the band edge.	

Note:

The following formula is used to convert the equipment isotropic radiated power (eirp) to field strength:

$$E = \frac{1000000\sqrt{30P}}{3} \mu\text{V/m, where P is the eirp (Watts).}$$

4.1.2 Test Instruments

DESCRIPTION & MANUFACTURER	MODEL NO.	SERIAL NO.	CALIBRATED DATE	CALIBRATED UNTIL
Test Receiver Keysight	N9038A	MY54450088	July 08, 2017	July 07, 2018
Pre-Amplifier ^(*) EMCI	EMC001340	980142	Jan. 20, 2016	Jan. 19, 2018
Loop Antenna ^(*) Electro-Metrics	EM-6879	264	Dec. 16, 2016	Dec. 15, 2018
RF Cable	NA	LOOPCAB-001 LOOPCAB-002	Jan. 17, 2017	Jan. 16, 2018
Pre-Amplifier Mini-Circuits	ZFL-1000VH2B	AMP-ZFL-01	Nov. 09, 2017	Nov. 08, 2018
Trilog Broadband Antenna SCHWARZBECK	VULB 9168	9168-406	Nov. 29, 2017	Nov. 28, 2018
RF Cable	8D	966-4-1 966-4-2 966-4-3	Apr. 01, 2017	Mar. 31, 2018
Fixed attenuator Mini-Circuits	UNAT-5+	PAD-3m-4-01	Oct. 03, 2017	Oct. 02, 2018
Horn_Antenna SCHWARZBECK	BBHA 9120D	9120D-783	Dec. 12, 2017	Dec. 11, 2018
Pre-Amplifier EMCI	EMC12630SE	980385	Feb. 02, 2017	Feb. 01, 2018
RF Cable	EMC104-SM-SM-1200 EMC104-SM-SM-2000 EMC104-SM-SM-5000	160923 150318 150321	Feb. 02, 2017 Mar. 29, 2017 Mar. 29, 2017	Feb. 01, 2018 Mar. 28, 2018 Mar. 28, 2018
Pre-Amplifier EMCI	EMC184045SE	980387	Feb. 02, 2017	Feb. 01, 2018
Horn_Antenna SCHWARZBECK	BBHA 9170	BBHA9170608	Dec. 14, 2017	Dec. 13, 2018
RF Cable	SUCOFLEX 102	36432/2 36433/2	Jan. 15, 2017	Jan. 14, 2018
Software	ADT_Radiated_V8.7.08	NA	NA	NA
Antenna Tower & Turn Table Max-Full	MF-7802	MF780208410	NA	NA
Boresight Antenna Fixture	FBA-01	FBA-SIP02	NA	NA
Spectrum Analyzer R&S	FSV40	100964	July 1, 2017	June 30, 2018
Power meter Anritsu	ML2495A	1014008	May 11, 2017	May 10, 2018
Power sensor Anritsu	MA2411B	0917122	May 11, 2017	May 10, 2018
AC Power Source Extech Electronics	6205	1440452	NA	NA
Temperature & Humidity Chamber Giant Force	MHU-225AU	911033	Dec. 01, 2017	Nov. 30, 2018
True RMS Clamp Meter FLUKE	325	31130711WS	May 29, 2017	May 28, 2018

Note:

1. The calibration interval of the above test instruments is 12 months and the calibrations are traceable to NML/ROC and NIST/USA.
2. *The calibration interval of the above test instruments is 24 months and the calibrations are traceable to NML/ROC and NIST/USA.
3. The test was performed in 966 Chamber No. 4.
4. Loop antenna was used for all emissions below 30 MHz.
5. The CANADA Site Registration No. is 20331-2
6. Tested Date: Jan. 10 to 11, 2018

4.1.3 Test Procedure

For Radiated emission below 30MHz

- a. The EUT was placed on the top of a rotating table 0.8 meters above the ground at a 3 meter chamber room. The table was rotated 360 degrees to determine the position of the highest radiation.
- b. The EUT was set 3 meters away from the interference-receiving antenna, which was mounted on the top of a variable-height antenna tower.
- c. Both X and Y axes of the antenna are set to make the measurement.
- d. For each suspected emission, the EUT was arranged to its worst case and the rotatable table was turned from 0 degrees to 360 degrees to find the maximum reading.
- e. The test-receiver system was set to Quasi-Peak Detect Function and Specified Bandwidth with Maximum Hold Mode.

NOTE:

1. The resolution bandwidth and video bandwidth of test receiver/spectrum analyzer is 9kHz at frequency below 30MHz.

For Radiated emission above 30MHz

- a. The EUT was placed on the top of a rotating table 0.8 meters (for 30MHz ~ 1GHz) / 1.5 meters (for above 1GHz) above the ground at 3 meter chamber room for test. The table was rotated 360 degrees to determine the position of the highest radiation.
- b. The EUT was set 3 meters away from the interference-receiving antenna, which was mounted on the top of a variable-height antenna tower.
- c. The height of antenna is varied from one meter to four meters above the ground to determine the maximum value of the field strength. Both horizontal and vertical polarizations of the antenna are set to make the measurement.
- d. For each suspected emission, the EUT was arranged to its worst case and then the antenna was tuned to heights from 1 meter to 4 meters and the rotatable table was turned from 0 degrees to 360 degrees to find the maximum reading.
- e. The test-receiver system was set to quasi-peak detect function and specified bandwidth with maximum hold mode when the test frequency is below 1 GHz.
- f. The test-receiver system was set to peak and average detect function and specified bandwidth with maximum hold mode when the test frequency is above 1 GHz. If the peak reading value also meets average limit, measurement with the average detector is unnecessary.

Note:

1. The resolution bandwidth and video bandwidth of test receiver/spectrum analyzer is 120kHz for Quasi-peak detection (QP) at frequency below 1GHz.
2. The resolution bandwidth of test receiver/spectrum analyzer is 1 MHz and the video bandwidth is 3 MHz for Peak detection (PK) at frequency above 1GHz.
3. The resolution bandwidth of test receiver/spectrum analyzer is 1MHz and the video bandwidth is $\geq 1/T$ (Duty cycle < 98%) or 10Hz (Duty cycle $\geq 98\%$) for Average detection (AV) at frequency above 1GHz.
4. All modes of operation were investigated and the worst-case emissions are reported.

4.1.4 Deviation from Test Standard

No deviation.

4.1.5 Test Setup

For Radiated emission below 30MHz

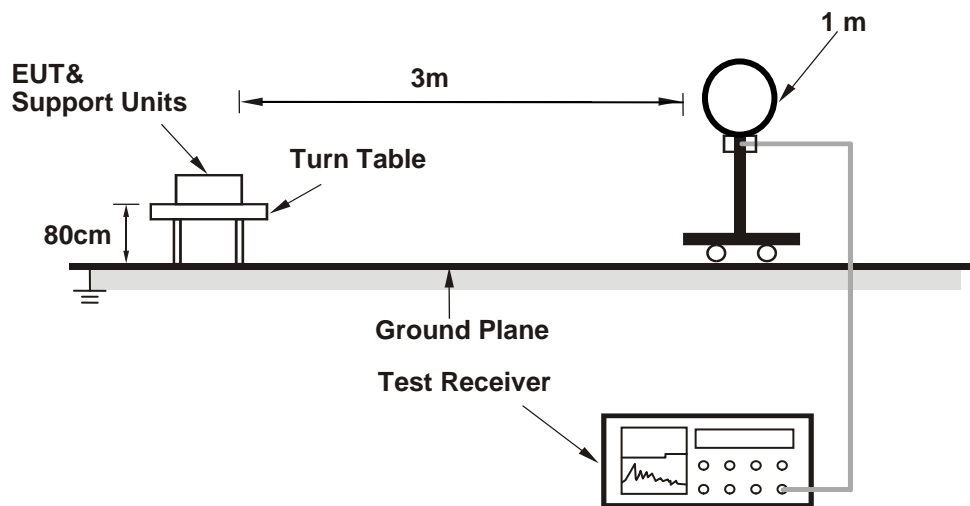

For Radiated emission 30MHz to 1GHz

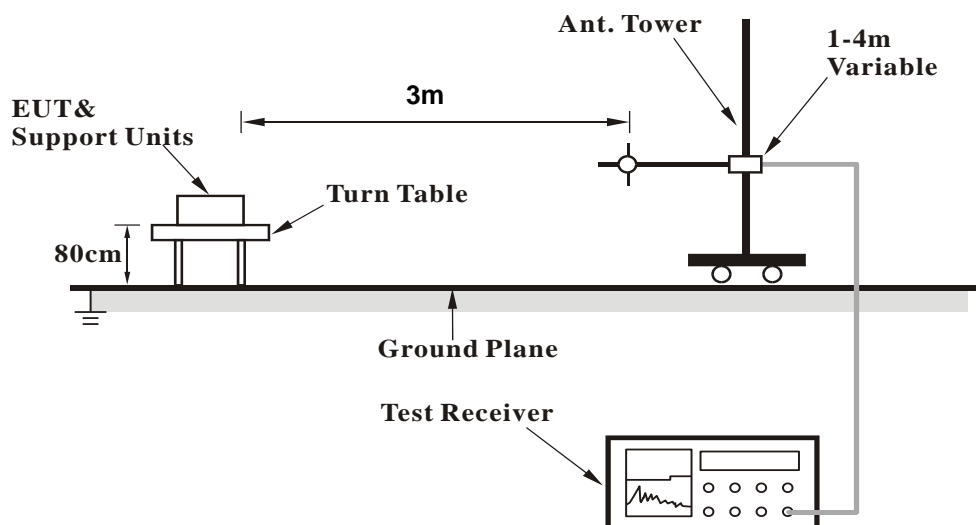

For Radiated emission above 1GHz

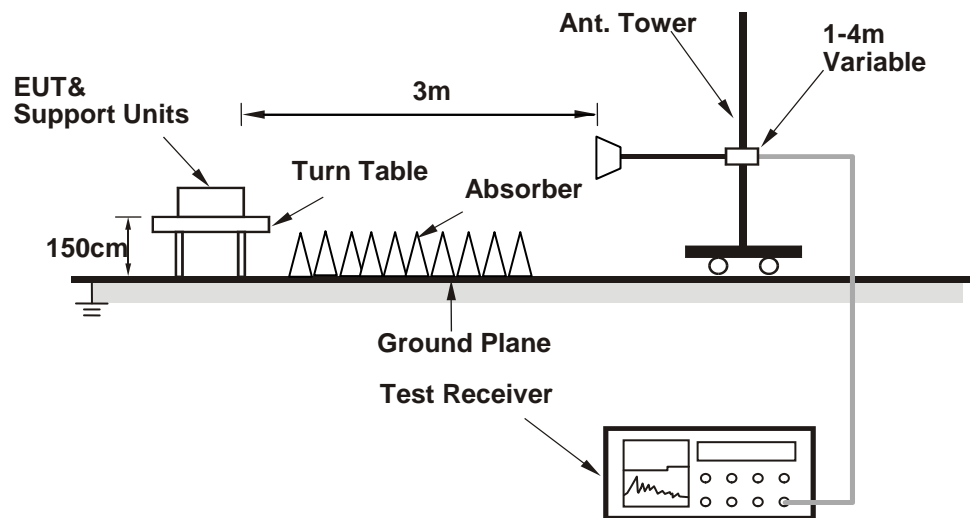

For the actual test configuration, please refer to the attached file (Test Setup Photo).

4.1.6 EUT Operating Condition

- a. Connected the EUT with the Laptop which is placed on remote site.
- b. Controlling software (QRCT Ver3.0.233.0) has been activated to set the EUT on specific status.

4.1.7 Test Results

Above 1GHz Data:

802.11a

CHANNEL	TX Channel 36	DETECTOR FUNCTION	Peak (PK)
FREQUENCY RANGE	1GHz ~ 40GHz		Average (AV)

ANTENNA POLARITY & TEST DISTANCE: HORIZONTAL AT 3 M

NO.	FREQ. (MHz)	EMISSION LEVEL (dBuV/m)	LIMIT (dBuV/m)	MARGIN (dB)	ANTENNA HEIGHT (m)	TABLE ANGLE (Degree)	RAW VALUE (dBuV)	CORRECTION FACTOR (dB/m)
1	#3453.00	47.8 PK	74.0	-26.2	1.96 H	141	47.3	0.5
2	#3453.00	41.2 AV	54.0	-12.8	1.96 H	141	40.7	0.5
3	5150.00	50.7 PK	74.0	-23.3	1.37 H	252	46.4	4.3
4	5150.00	39.0 AV	54.0	-15.0	1.37 H	252	34.7	4.3
5	*5180.00	99.1 PK			1.37 H	252	95.0	4.1
6	*5180.00	88.8 AV			1.37 H	252	84.7	4.1
7	#10360.00	49.5 PK	74.0	-24.5	1.91 H	300	36.2	13.3
8	#10360.00	45.1 AV	54.0	-8.9	1.91 H	300	31.8	13.3
9	15540.00	47.2 PK	74.0	-26.8	1.52 H	147	34.3	12.9
10	15540.00	35.3 AV	54.0	-18.7	1.52 H	147	22.4	12.9

ANTENNA POLARITY & TEST DISTANCE: VERTICAL AT 3 M

NO.	FREQ. (MHz)	EMISSION LEVEL (dBuV/m)	LIMIT (dBuV/m)	MARGIN (dB)	ANTENNA HEIGHT (m)	TABLE ANGLE (Degree)	RAW VALUE (dBuV)	CORRECTION FACTOR (dB/m)
1	#3453.00	48.2 PK	74.0	-25.8	2.66 V	360	47.7	0.5
2	#3453.00	41.6 AV	54.0	-12.4	2.66 V	360	41.1	0.5
3	5150.00	66.8 PK	74.0	-7.2	1.51 V	226	62.5	4.3
4	5150.00	51.4 AV	54.0	-2.6	1.51 V	226	47.1	4.3
5	*5180.00	114.6 PK			1.51 V	226	110.5	4.1
6	*5180.00	103.2 AV			1.51 V	226	99.1	4.1
7	#10360.00	46.9 PK	74.0	-27.1	3.38 V	324	33.6	13.3
8	#10360.00	38.5 AV	54.0	-15.5	3.38 V	324	25.2	13.3
9	15540.00	48.1 PK	74.0	-25.9	1.55 V	65	35.2	12.9
10	15540.00	35.6 AV	54.0	-18.4	1.55 V	65	22.7	12.9

REMARKS:

1. Emission Level(dBuV/m) = Raw Value(dBuV) + Correction Factor(dB/m)
2. Correction Factor(dB/m) = Antenna Factor(dB/m) + Cable Factor(dB) – Pre-Amplifier Factor(dB)
3. The other emission levels were very low against the limit.
4. Margin value = Emission Level – Limit value
5. " * ": Fundamental frequency.
6. " # ": The radiated frequency is out of the restricted band.

CHANNEL	TX Channel 40	DETECTOR FUNCTION	Peak (PK)
FREQUENCY RANGE	1GHz ~ 40GHz		Average (AV)

ANTENNA POLARITY & TEST DISTANCE: HORIZONTAL AT 3 M

NO.	FREQ. (MHz)	EMISSION LEVEL (dBuV/m)	LIMIT (dBuV/m)	MARGIN (dB)	ANTENNA HEIGHT (m)	TABLE ANGLE (Degree)	RAW VALUE (dBuV)	CORRECTION FACTOR (dB/m)
1	5150.00	50.4 PK	74.0	-23.6	1.39 H	265	46.1	4.3
2	5150.00	37.6 AV	54.0	-16.4	1.39 H	265	33.3	4.3
3	*5200.00	99.1 PK			1.39 H	265	95.1	4.0
4	*5200.00	90.7 AV			1.39 H	265	86.7	4.0
5	5350.00	47.6 PK	74.0	-26.4	1.39 H	265	43.6	4.0
6	5350.00	37.4 AV	54.0	-16.6	1.39 H	265	33.4	4.0
7	#10400.00	45.1 PK	74.0	-28.9	1.92 H	288	31.6	13.5
8	#10400.00	40.9 AV	54.0	-13.1	1.92 H	288	27.4	13.5
9	15600.00	47.2 PK	74.0	-26.8	1.53 H	142	34.1	13.1
10	15600.00	35.3 AV	54.0	-18.7	1.53 H	142	22.2	13.1

ANTENNA POLARITY & TEST DISTANCE: VERTICAL AT 3 M

NO.	FREQ. (MHz)	EMISSION LEVEL (dBuV/m)	LIMIT (dBuV/m)	MARGIN (dB)	ANTENNA HEIGHT (m)	TABLE ANGLE (Degree)	RAW VALUE (dBuV)	CORRECTION FACTOR (dB/m)
1	5150.00	64.4 PK	74.0	-9.6	1.48 V	226	60.1	4.3
2	5150.00	47.9 AV	54.0	-6.1	1.48 V	226	43.6	4.3
3	*5200.00	114.6 PK			1.48 V	226	110.6	4.0
4	*5200.00	105.1 AV			1.48 V	226	101.1	4.0
5	5350.00	48.8 PK	74.0	-25.2	1.48 V	226	44.8	4.0
6	5350.00	37.6 AV	54.0	-16.4	1.48 V	226	33.6	4.0
7	#10400.00	49.0 PK	74.0	-25.0	3.32 V	334	35.5	13.5
8	#10400.00	36.7 AV	54.0	-17.3	3.32 V	334	23.2	13.5
9	15600.00	48.2 PK	74.0	-25.8	1.55 V	64	35.1	13.1
10	15600.00	35.4 AV	54.0	-18.6	1.55 V	64	22.3	13.1

REMARKS:

1. Emission Level(dBuV/m) = Raw Value(dBuV) + Correction Factor(dB/m)
2. Correction Factor(dB/m) = Antenna Factor(dB/m) + Cable Factor(dB) – Pre-Amplifier Factor(dB)
3. The other emission levels were very low against the limit.
4. Margin value = Emission Level – Limit value
5. " * ": Fundamental frequency.
6. " # ": The radiated frequency is out of the restricted band.

CHANNEL	TX Channel 48	DETECTOR FUNCTION	Peak (PK)
FREQUENCY RANGE	1GHz ~ 40GHz		Average (AV)

ANTENNA POLARITY & TEST DISTANCE: HORIZONTAL AT 3 M

NO.	FREQ. (MHz)	EMISSION LEVEL (dBuV/m)	LIMIT (dBuV/m)	MARGIN (dB)	ANTENNA HEIGHT (m)	TABLE ANGLE (Degree)	RAW VALUE (dBuV)	CORRECTION FACTOR (dB/m)
1	*5240.00	100.7 PK			1.39 H	250	96.8	3.9
2	*5240.00	91.9 AV			1.39 H	250	88.0	3.9
3	5350.00	49.6 PK	74.0	-24.4	1.39 H	250	45.6	4.0
4	5350.00	37.4 AV	54.0	-16.6	1.39 H	250	33.4	4.0
5	#10480.00	46.3 PK	74.0	-27.7	1.89 H	291	32.3	14.0
6	#10480.00	41.7 AV	54.0	-12.3	1.89 H	291	27.7	14.0
7	15720.00	47.1 PK	74.0	-26.9	1.48 H	162	33.6	13.5
8	15720.00	35.2 AV	54.0	-18.8	1.48 H	162	21.7	13.5

ANTENNA POLARITY & TEST DISTANCE: VERTICAL AT 3 M

NO.	FREQ. (MHz)	EMISSION LEVEL (dBuV/m)	LIMIT (dBuV/m)	MARGIN (dB)	ANTENNA HEIGHT (m)	TABLE ANGLE (Degree)	RAW VALUE (dBuV)	CORRECTION FACTOR (dB/m)
1	*5240.00	116.2 PK			1.54 V	227	112.3	3.9
2	*5240.00	106.3 AV			1.54 V	227	102.4	3.9
3	5350.00	50.3 PK	74.0	-23.7	1.54 V	227	46.3	4.0
4	5350.00	37.6 AV	54.0	-16.4	1.54 V	227	33.6	4.0
5	#10480.00	49.4 PK	74.0	-24.6	3.38 V	327	35.4	14.0
6	#10480.00	36.2 AV	54.0	-17.8	3.38 V	327	22.2	14.0
7	15720.00	48.0 PK	74.0	-26.0	1.55 V	56	34.5	13.5
8	15720.00	35.3 AV	54.0	-18.7	1.55 V	56	21.8	13.5

REMARKS:

1. Emission Level(dBuV/m) = Raw Value(dBuV) + Correction Factor(dB/m)
2. Correction Factor(dB/m) = Antenna Factor(dB/m) + Cable Factor(dB) – Pre-Amplifier Factor(dB)
3. The other emission levels were very low against the limit.
4. Margin value = Emission Level – Limit value
5. " * ": Fundamental frequency.
6. " # ": The radiated frequency is out of the restricted band.

CHANNEL	TX Channel 149	DETECTOR FUNCTION	Peak (PK)
FREQUENCY RANGE	1GHz ~ 40GHz		Average (AV)

ANTENNA POLARITY & TEST DISTANCE: HORIZONTAL AT 3 M

NO.	FREQ. (MHz)	EMISSION LEVEL (dBuV/m)	LIMIT (dBuV/m)	MARGIN (dB)	ANTENNA HEIGHT (m)	TABLE ANGLE (Degree)	RAW VALUE (dBuV)	CORRECTION FACTOR (dB/m)
1	*5745.00	103.4 PK			1.70 H	154	98.8	4.6
2	*5745.00	94.0 AV			1.70 H	154	89.4	4.6
3	11490.00	51.3 PK	74.0	-22.7	1.90 H	292	37.2	14.1
4	11490.00	46.7 AV	54.0	-7.3	1.90 H	292	32.6	14.1
5	#17235.00	60.2 PK	74.0	-13.8	2.44 H	51	43.3	16.9
6	#17235.00	49.0 AV	54.0	-5.0	2.44 H	51	32.1	16.9

ANTENNA POLARITY & TEST DISTANCE: VERTICAL AT 3 M

NO.	FREQ. (MHz)	EMISSION LEVEL (dBuV/m)	LIMIT (dBuV/m)	MARGIN (dB)	ANTENNA HEIGHT (m)	TABLE ANGLE (Degree)	RAW VALUE (dBuV)	CORRECTION FACTOR (dB/m)
1	*5745.00	119.5 PK			1.50 V	236	114.9	4.6
2	*5745.00	109.1 AV			1.50 V	236	104.5	4.6
3	11490.00	49.0 PK	74.0	-25.0	3.34 V	327	34.9	14.1
4	11490.00	40.4 AV	54.0	-13.6	3.34 V	327	26.3	14.1
5	#17235.00	53.0 PK	74.0	-21.0	1.51 V	331	36.1	16.9
6	#17235.00	41.8 AV	54.0	-12.2	1.51 V	331	24.9	16.9

REMARKS:

1. Emission Level(dBuV/m) = Raw Value(dBuV) + Correction Factor(dB/m)
2. Correction Factor(dB/m) = Antenna Factor(dB/m) + Cable Factor(dB) – Pre-Amplifier Factor(dB)
3. The other emission levels were very low against the limit.
4. Margin value = Emission Level – Limit value
5. " * ": Fundamental frequency.
6. " # ": The radiated frequency is out of the restricted band.

CHANNEL	TX Channel 157	DETECTOR FUNCTION	Peak (PK)
FREQUENCY RANGE	1GHz ~ 40GHz		Average (AV)

ANTENNA POLARITY & TEST DISTANCE: HORIZONTAL AT 3 M

NO.	FREQ. (MHz)	EMISSION LEVEL (dBuV/m)	LIMIT (dBuV/m)	MARGIN (dB)	ANTENNA HEIGHT (m)	TABLE ANGLE (Degree)	RAW VALUE (dBuV)	CORRECTION FACTOR (dB/m)
1	*5785.00	104.1 PK			1.55 H	360	99.5	4.6
2	*5785.00	93.4 AV			1.55 H	360	88.8	4.6
3	11570.00	51.7 PK	74.0	-22.3	1.96 H	300	37.6	14.1
4	11570.00	47.0 AV	54.0	-7.0	1.96 H	300	32.9	14.1
5	#17355.00	60.2 PK	74.0	-13.8	2.39 H	54	42.4	17.8
6	#17355.00	49.2 AV	54.0	-4.8	2.39 H	54	31.4	17.8

ANTENNA POLARITY & TEST DISTANCE: VERTICAL AT 3 M

NO.	FREQ. (MHz)	EMISSION LEVEL (dBuV/m)	LIMIT (dBuV/m)	MARGIN (dB)	ANTENNA HEIGHT (m)	TABLE ANGLE (Degree)	RAW VALUE (dBuV)	CORRECTION FACTOR (dB/m)
1	*5785.00	119.1 PK			1.90 V	360	114.5	4.6
2	*5785.00	109.1 AV			1.90 V	360	104.5	4.6
3	11570.00	49.4 PK	74.0	-24.6	3.30 V	318	35.3	14.1
4	11570.00	40.6 AV	54.0	-13.4	3.30 V	318	26.5	14.1
5	#17355.00	52.9 PK	74.0	-21.1	1.46 V	344	35.1	17.8
6	#17355.00	41.7 AV	54.0	-12.3	1.46 V	344	23.9	17.8

REMARKS:

1. Emission Level(dBuV/m) = Raw Value(dBuV) + Correction Factor(dB/m)
2. Correction Factor(dB/m) = Antenna Factor(dB/m) + Cable Factor(dB) – Pre-Amplifier Factor(dB)
3. The other emission levels were very low against the limit.
4. Margin value = Emission Level – Limit value
5. " * ": Fundamental frequency.
6. " # ": The radiated frequency is out of the restricted band.

CHANNEL	TX Channel 165	DETECTOR FUNCTION	Peak (PK)
FREQUENCY RANGE	1GHz ~ 40GHz		Average (AV)

ANTENNA POLARITY & TEST DISTANCE: HORIZONTAL AT 3 M

NO.	FREQ. (MHz)	EMISSION LEVEL (dBuV/m)	LIMIT (dBuV/m)	MARGIN (dB)	ANTENNA HEIGHT (m)	TABLE ANGLE (Degree)	RAW VALUE (dBuV)	CORRECTION FACTOR (dB/m)
1	*5825.00	104.5 PK			1.22 H	325	99.7	4.8
2	*5825.00	94.9 AV			1.22 H	325	90.1	4.8
3	11650.00	51.3 PK	74.0	-22.7	1.85 H	308	37.3	14.0
4	11650.00	46.7 AV	54.0	-7.3	1.85 H	308	32.7	14.0
5	#17475.00	59.8 PK	74.0	-14.2	2.48 H	66	40.8	19.0
6	#17475.00	48.7 AV	54.0	-5.3	2.48 H	66	29.7	19.0

ANTENNA POLARITY & TEST DISTANCE: VERTICAL AT 3 M

NO.	FREQ. (MHz)	EMISSION LEVEL (dBuV/m)	LIMIT (dBuV/m)	MARGIN (dB)	ANTENNA HEIGHT (m)	TABLE ANGLE (Degree)	RAW VALUE (dBuV)	CORRECTION FACTOR (dB/m)
1	*5825.00	119.1 PK			1.85 V	360	114.3	4.8
2	*5825.00	109.3 AV			1.85 V	360	104.5	4.8
3	11650.00	48.7 PK	74.0	-25.3	3.36 V	316	34.7	14.0
4	11650.00	39.9 AV	54.0	-14.1	3.36 V	316	25.9	14.0
5	#17475.00	53.1 PK	74.0	-20.9	1.46 V	342	34.1	19.0
6	#17475.00	41.9 AV	54.0	-12.1	1.46 V	342	22.9	19.0

REMARKS:

1. Emission Level(dBuV/m) = Raw Value(dBuV) + Correction Factor(dB/m)
2. Correction Factor(dB/m) = Antenna Factor(dB/m) + Cable Factor(dB) – Pre-Amplifier Factor(dB)
3. The other emission levels were very low against the limit.
4. Margin value = Emission Level – Limit value
5. " * ": Fundamental frequency.
6. " # ": The radiated frequency is out of the restricted band.

802.11ac (VHT20)

CHANNEL	TX Channel 36	DETECTOR FUNCTION	Peak (PK)
FREQUENCY RANGE	1GHz ~ 40GHz		Average (AV)

ANTENNA POLARITY & TEST DISTANCE: HORIZONTAL AT 3 M								
NO.	FREQ. (MHz)	EMISSION LEVEL (dBuV/m)	LIMIT (dBuV/m)	MARGIN (dB)	ANTENNA HEIGHT (m)	TABLE ANGLE (Degree)	RAW VALUE (dBuV)	CORRECTION FACTOR (dB/m)
1	5150.00	52.0 PK	74.0	-22.0	1.39 H	264	47.7	4.3
2	5150.00	40.5 AV	54.0	-13.5	1.39 H	264	36.2	4.3
3	*5180.00	100.6 PK			1.39 H	264	96.5	4.1
4	*5180.00	89.6 AV			1.39 H	264	85.5	4.1
5	#10360.00	45.3 PK	74.0	-28.7	1.90 H	295	32.0	13.3
6	#10360.00	41.4 AV	54.0	-12.6	1.90 H	295	28.1	13.3
7	15540.00	47.0 PK	74.0	-27.0	1.54 H	130	34.1	12.9
8	15540.00	35.1 AV	54.0	-18.9	1.54 H	130	22.2	12.9

ANTENNA POLARITY & TEST DISTANCE: VERTICAL AT 3 M								
NO.	FREQ. (MHz)	EMISSION LEVEL (dBuV/m)	LIMIT (dBuV/m)	MARGIN (dB)	ANTENNA HEIGHT (m)	TABLE ANGLE (Degree)	RAW VALUE (dBuV)	CORRECTION FACTOR (dB/m)
1	5150.00	66.0 PK	74.0	-8.0	1.54 V	159	61.7	4.3
2	5150.00	51.5 AV	54.0	-2.5	1.54 V	159	47.2	4.3
3	*5180.00	116.1 PK			1.54 V	159	112.0	4.1
4	*5180.00	104.0 AV			1.54 V	159	99.9	4.1
5	#10360.00	49.6 PK	74.0	-24.4	3.37 V	348	36.3	13.3
6	#10360.00	37.1 AV	54.0	-16.9	3.37 V	348	23.8	13.3
7	15540.00	48.6 PK	74.0	-25.4	1.53 V	79	35.7	12.9
8	15540.00	35.7 AV	54.0	-18.3	1.53 V	79	22.8	12.9

REMARKS:

1. Emission Level(dBuV/m) = Raw Value(dBuV) + Correction Factor(dB/m)
2. Correction Factor(dB/m) = Antenna Factor(dB/m) + Cable Factor(dB) – Pre-Amplifier Factor(dB)
3. The other emission levels were very low against the limit.
4. Margin value = Emission Level – Limit value
5. " * ": Fundamental frequency.
6. " # ": The radiated frequency is out of the restricted band.

CHANNEL	TX Channel 40	DETECTOR FUNCTION	Peak (PK)
FREQUENCY RANGE	1GHz ~ 40GHz		Average (AV)

ANTENNA POLARITY & TEST DISTANCE: HORIZONTAL AT 3 M

NO.	FREQ. (MHz)	EMISSION LEVEL (dBuV/m)	LIMIT (dBuV/m)	MARGIN (dB)	ANTENNA HEIGHT (m)	TABLE ANGLE (Degree)	RAW VALUE (dBuV)	CORRECTION FACTOR (dB/m)
1	5150.00	47.2 PK	74.0	-26.8	1.37 H	251	42.9	4.3
2	5150.00	37.5 AV	54.0	-16.5	1.37 H	251	33.2	4.3
3	*5200.00	98.7 PK			1.37 H	251	94.7	4.0
4	*5200.00	89.4 AV			1.37 H	251	85.4	4.0
5	5350.00	49.2 PK	74.0	-24.8	1.37 H	251	45.2	4.0
6	5350.00	37.4 AV	54.0	-16.6	1.37 H	251	33.4	4.0
7	#10400.00	45.4 PK	74.0	-28.6	1.86 H	296	31.9	13.5
8	#10400.00	41.3 AV	54.0	-12.7	1.86 H	296	27.8	13.5
9	15600.00	46.9 PK	74.0	-27.1	1.53 H	137	33.8	13.1
10	15600.00	35.2 AV	54.0	-18.8	1.53 H	137	22.1	13.1

ANTENNA POLARITY & TEST DISTANCE: VERTICAL AT 3 M

NO.	FREQ. (MHz)	EMISSION LEVEL (dBuV/m)	LIMIT (dBuV/m)	MARGIN (dB)	ANTENNA HEIGHT (m)	TABLE ANGLE (Degree)	RAW VALUE (dBuV)	CORRECTION FACTOR (dB/m)
1	5150.00	61.2 PK	74.0	-12.8	1.47 V	158	56.9	4.3
2	5150.00	47.9 AV	54.0	-6.1	1.47 V	158	43.6	4.3
3	*5200.00	114.2 PK			1.47 V	158	110.2	4.0
4	*5200.00	103.8 AV			1.47 V	158	99.8	4.0
5	5350.00	51.1 PK	74.0	-22.9	1.47 V	158	47.1	4.0
6	5350.00	37.6 AV	54.0	-16.4	1.47 V	158	33.6	4.0
7	#10400.00	49.4 PK	74.0	-24.6	3.26 V	323	35.9	13.5
8	#10400.00	37.1 AV	54.0	-16.9	3.26 V	323	23.6	13.5
9	15600.00	48.4 PK	74.0	-25.6	1.56 V	64	35.3	13.1
10	15600.00	35.4 AV	54.0	-18.6	1.56 V	64	22.3	13.1

REMARKS:

1. Emission Level(dBuV/m) = Raw Value(dBuV) + Correction Factor(dB/m)
2. Correction Factor(dB/m) = Antenna Factor(dB/m) + Cable Factor(dB) – Pre-Amplifier Factor(dB)
3. The other emission levels were very low against the limit.
4. Margin value = Emission Level – Limit value
5. " * ": Fundamental frequency.
6. " # ": The radiated frequency is out of the restricted band.

CHANNEL	TX Channel 48	DETECTOR FUNCTION	Peak (PK)
FREQUENCY RANGE	1GHz ~ 40GHz		Average (AV)

ANTENNA POLARITY & TEST DISTANCE: HORIZONTAL AT 3 M

NO.	FREQ. (MHz)	EMISSION LEVEL (dBuV/m)	LIMIT (dBuV/m)	MARGIN (dB)	ANTENNA HEIGHT (m)	TABLE ANGLE (Degree)	RAW VALUE (dBuV)	CORRECTION FACTOR (dB/m)
1	*5240.00	101.2 PK			1.39 H	264	97.3	3.9
2	*5240.00	91.3 AV			1.39 H	264	87.4	3.9
3	5350.00	50.1 PK	74.0	-23.9	1.39 H	264	46.1	4.0
4	5350.00	37.5 AV	54.0	-16.5	1.39 H	264	33.5	4.0
5	#10480.00	44.9 PK	74.0	-29.1	1.94 H	303	30.9	14.0
6	#10480.00	40.5 AV	54.0	-13.5	1.94 H	303	26.5	14.0
7	15720.00	46.7 PK	74.0	-27.3	1.56 H	137	33.2	13.5
8	15720.00	35.0 AV	54.0	-19.0	1.56 H	137	21.5	13.5

ANTENNA POLARITY & TEST DISTANCE: VERTICAL AT 3 M

NO.	FREQ. (MHz)	EMISSION LEVEL (dBuV/m)	LIMIT (dBuV/m)	MARGIN (dB)	ANTENNA HEIGHT (m)	TABLE ANGLE (Degree)	RAW VALUE (dBuV)	CORRECTION FACTOR (dB/m)
1	*5240.00	116.7 PK			1.49 V	157	112.8	3.9
2	*5240.00	105.7 AV			1.49 V	157	101.8	3.9
3	5350.00	50.2 PK	74.0	-23.8	1.49 V	157	46.2	4.0
4	5350.00	37.7 AV	54.0	-16.3	1.49 V	157	33.7	4.0
5	#10480.00	48.8 PK	74.0	-25.2	3.31 V	334	34.8	14.0
6	#10480.00	36.6 AV	54.0	-17.4	3.31 V	334	22.6	14.0
7	15720.00	48.0 PK	74.0	-26.0	1.53 V	71	34.5	13.5
8	15720.00	35.1 AV	54.0	-18.9	1.53 V	71	21.6	13.5

REMARKS:

1. Emission Level(dBuV/m) = Raw Value(dBuV) + Correction Factor(dB/m)
2. Correction Factor(dB/m) = Antenna Factor(dB/m) + Cable Factor(dB) – Pre-Amplifier Factor(dB)
3. The other emission levels were very low against the limit.
4. Margin value = Emission Level – Limit value
5. " * ": Fundamental frequency.
6. " # ": The radiated frequency is out of the restricted band.

CHANNEL	TX Channel 149	DETECTOR FUNCTION	Peak (PK)
FREQUENCY RANGE	1GHz ~ 40GHz		Average (AV)

ANTENNA POLARITY & TEST DISTANCE: HORIZONTAL AT 3 M

NO.	FREQ. (MHz)	EMISSION LEVEL (dBuV/m)	LIMIT (dBuV/m)	MARGIN (dB)	ANTENNA HEIGHT (m)	TABLE ANGLE (Degree)	RAW VALUE (dBuV)	CORRECTION FACTOR (dB/m)
1	*5745.00	105.8 PK			1.21 H	326	101.2	4.6
2	*5745.00	95.3 AV			1.21 H	326	90.7	4.6
3	11490.00	51.0 PK	74.0	-23.0	1.86 H	292	36.9	14.1
4	11490.00	46.5 AV	54.0	-7.5	1.86 H	292	32.4	14.1
5	#17235.00	60.3 PK	74.0	-13.7	2.39 H	43	43.4	16.9
6	#17235.00	49.2 AV	54.0	-4.8	2.39 H	43	32.3	16.9

ANTENNA POLARITY & TEST DISTANCE: VERTICAL AT 3 M

NO.	FREQ. (MHz)	EMISSION LEVEL (dBuV/m)	LIMIT (dBuV/m)	MARGIN (dB)	ANTENNA HEIGHT (m)	TABLE ANGLE (Degree)	RAW VALUE (dBuV)	CORRECTION FACTOR (dB/m)
1	*5745.00	118.0 PK			1.68 V	360	113.4	4.6
2	*5745.00	107.7 AV			1.68 V	360	103.1	4.6
3	11490.00	48.8 PK	74.0	-25.2	3.32 V	339	34.7	14.1
4	11490.00	40.4 AV	54.0	-13.6	3.32 V	339	26.3	14.1
5	#17235.00	52.8 PK	74.0	-21.2	1.46 V	333	35.9	16.9
6	#17235.00	41.5 AV	54.0	-12.5	1.46 V	333	24.6	16.9

REMARKS:

1. Emission Level(dBuV/m) = Raw Value(dBuV) + Correction Factor(dB/m)
2. Correction Factor(dB/m) = Antenna Factor(dB/m) + Cable Factor(dB) – Pre-Amplifier Factor(dB)
3. The other emission levels were very low against the limit.
4. Margin value = Emission Level – Limit value
5. " * ": Fundamental frequency.
6. " # ": The radiated frequency is out of the restricted band.

CHANNEL	TX Channel 157	DETECTOR FUNCTION	Peak (PK)
FREQUENCY RANGE	1GHz ~ 40GHz		Average (AV)

ANTENNA POLARITY & TEST DISTANCE: HORIZONTAL AT 3 M

NO.	FREQ. (MHz)	EMISSION LEVEL (dBuV/m)	LIMIT (dBuV/m)	MARGIN (dB)	ANTENNA HEIGHT (m)	TABLE ANGLE (Degree)	RAW VALUE (dBuV)	CORRECTION FACTOR (dB/m)
1	*5785.00	105.5 PK			1.22 H	326	100.9	4.6
2	*5785.00	95.9 AV			1.22 H	326	91.3	4.6
3	11570.00	50.8 PK	74.0	-23.2	1.91 H	294	36.7	14.1
4	11570.00	46.3 AV	54.0	-7.7	1.91 H	294	32.2	14.1
5	#17355.00	59.9 PK	74.0	-14.1	2.40 H	47	42.1	17.8
6	#17355.00	48.5 AV	54.0	-5.5	2.40 H	47	30.7	17.8

ANTENNA POLARITY & TEST DISTANCE: VERTICAL AT 3 M

NO.	FREQ. (MHz)	EMISSION LEVEL (dBuV/m)	LIMIT (dBuV/m)	MARGIN (dB)	ANTENNA HEIGHT (m)	TABLE ANGLE (Degree)	RAW VALUE (dBuV)	CORRECTION FACTOR (dB/m)
1	*5785.00	118.1 PK			1.69 V	360	113.5	4.6
2	*5785.00	107.8 AV			1.69 V	360	103.2	4.6
3	11570.00	49.1 PK	74.0	-24.9	3.40 V	328	35.0	14.1
4	11570.00	40.2 AV	54.0	-13.8	3.40 V	328	26.1	14.1
5	#17355.00	53.5 PK	74.0	-20.5	1.49 V	332	35.7	17.8
6	#17355.00	42.1 AV	54.0	-11.9	1.49 V	332	24.3	17.8

REMARKS:

1. Emission Level(dBuV/m) = Raw Value(dBuV) + Correction Factor(dB/m)
2. Correction Factor(dB/m) = Antenna Factor(dB/m) + Cable Factor(dB) – Pre-Amplifier Factor(dB)
3. The other emission levels were very low against the limit.
4. Margin value = Emission Level – Limit value
5. " * ": Fundamental frequency.
6. " # ": The radiated frequency is out of the restricted band.

CHANNEL	TX Channel 165	DETECTOR FUNCTION	Peak (PK)
FREQUENCY RANGE	1GHz ~ 40GHz		Average (AV)

ANTENNA POLARITY & TEST DISTANCE: HORIZONTAL AT 3 M

NO.	FREQ. (MHz)	EMISSION LEVEL (dBuV/m)	LIMIT (dBuV/m)	MARGIN (dB)	ANTENNA HEIGHT (m)	TABLE ANGLE (Degree)	RAW VALUE (dBuV)	CORRECTION FACTOR (dB/m)
1	*5825.00	105.2 PK			1.22 H	324	100.4	4.8
2	*5825.00	95.1 AV			1.22 H	324	90.3	4.8
3	11650.00	51.4 PK	74.0	-22.6	1.95 H	289	37.4	14.0
4	11650.00	46.7 AV	54.0	-7.3	1.95 H	289	32.7	14.0
5	#17475.00	60.2 PK	74.0	-13.8	2.44 H	42	41.2	19.0
6	#17475.00	49.2 AV	54.0	-4.8	2.44 H	42	30.2	19.0

ANTENNA POLARITY & TEST DISTANCE: VERTICAL AT 3 M

NO.	FREQ. (MHz)	EMISSION LEVEL (dBuV/m)	LIMIT (dBuV/m)	MARGIN (dB)	ANTENNA HEIGHT (m)	TABLE ANGLE (Degree)	RAW VALUE (dBuV)	CORRECTION FACTOR (dB/m)
1	*5825.00	117.8 PK			1.72 V	360	113.0	4.8
2	*5825.00	107.4 AV			1.72 V	360	102.6	4.8
3	11650.00	49.2 PK	74.0	-24.8	3.35 V	313	35.2	14.0
4	11650.00	40.5 AV	54.0	-13.5	3.35 V	313	26.5	14.0
5	#17475.00	53.5 PK	74.0	-20.5	1.49 V	318	34.5	19.0
6	#17475.00	42.1 AV	54.0	-11.9	1.49 V	318	23.1	19.0

REMARKS:

1. Emission Level(dBuV/m) = Raw Value(dBuV) + Correction Factor(dB/m)
2. Correction Factor(dB/m) = Antenna Factor(dB/m) + Cable Factor(dB) – Pre-Amplifier Factor(dB)
3. The other emission levels were very low against the limit.
4. Margin value = Emission Level – Limit value
5. " * ": Fundamental frequency.
6. " # ": The radiated frequency is out of the restricted band.

802.11ac (VHT40)

CHANNEL	TX Channel 38	DETECTOR FUNCTION	Peak (PK)
FREQUENCY RANGE	1GHz ~ 40GHz		Average (AV)

ANTENNA POLARITY & TEST DISTANCE: HORIZONTAL AT 3 M

NO.	FREQ. (MHz)	EMISSION LEVEL (dBuV/m)	LIMIT (dBuV/m)	MARGIN (dB)	ANTENNA HEIGHT (m)	TABLE ANGLE (Degree)	RAW VALUE (dBuV)	CORRECTION FACTOR (dB/m)
1	5150.00	57.5 PK	74.0	-16.5	1.34 H	271	53.2	4.3
2	5150.00	41.9 AV	54.0	-12.1	1.34 H	271	37.6	4.3
3	*5190.00	96.8 PK			1.34 H	271	92.7	4.1
4	*5190.00	88.0 AV			1.34 H	271	83.9	4.1
5	5350.00	50.2 PK	74.0	-23.8	1.34 H	271	46.2	4.0
6	5350.00	37.6 AV	54.0	-16.4	1.34 H	271	33.6	4.0
7	#10380.00	45.5 PK	74.0	-28.5	1.82 H	307	32.1	13.4
8	#10380.00	41.3 AV	54.0	-12.7	1.82 H	307	27.9	13.4
9	15570.00	47.4 PK	74.0	-26.6	1.50 H	143	34.4	13.0
10	15570.00	35.5 AV	54.0	-18.5	1.50 H	143	22.5	13.0

ANTENNA POLARITY & TEST DISTANCE: VERTICAL AT 3 M

NO.	FREQ. (MHz)	EMISSION LEVEL (dBuV/m)	LIMIT (dBuV/m)	MARGIN (dB)	ANTENNA HEIGHT (m)	TABLE ANGLE (Degree)	RAW VALUE (dBuV)	CORRECTION FACTOR (dB/m)
1	5150.00	68.5 PK	74.0	-5.5	1.49 V	224	64.2	4.3
2	5150.00	52.9 AV	54.0	-1.1	1.49 V	224	48.6	4.3
3	*5190.00	112.3 PK			1.49 V	224	108.2	4.1
4	*5190.00	102.4 AV			1.49 V	224	98.3	4.1
5	5350.00	53.1 PK	74.0	-20.9	1.49 V	224	49.1	4.0
6	5350.00	42.1 AV	54.0	-11.9	1.49 V	224	38.1	4.0
7	#10380.00	49.5 PK	74.0	-24.5	3.28 V	312	36.1	13.4
8	#10380.00	37.0 AV	54.0	-17.0	3.28 V	312	23.6	13.4
9	15570.00	48.6 PK	74.0	-25.4	1.60 V	50	35.6	13.0
10	15570.00	35.7 AV	54.0	-18.3	1.60 V	50	22.7	13.0

REMARKS:

- Emission Level(dBuV/m) = Raw Value(dBuV) + Correction Factor(dB/m)
- Correction Factor(dB/m) = Antenna Factor(dB/m) + Cable Factor(dB) – Pre-Amplifier Factor(dB)
- The other emission levels were very low against the limit.
- Margin value = Emission Level – Limit value
- " * ": Fundamental frequency.
- " # ": The radiated frequency is out of the restricted band.

CHANNEL	TX Channel 46	DETECTOR FUNCTION	Peak (PK)
FREQUENCY RANGE	1GHz ~ 40GHz		Average (AV)

ANTENNA POLARITY & TEST DISTANCE: HORIZONTAL AT 3 M

NO.	FREQ. (MHz)	EMISSION LEVEL (dBuV/m)	LIMIT (dBuV/m)	MARGIN (dB)	ANTENNA HEIGHT (m)	TABLE ANGLE (Degree)	RAW VALUE (dBuV)	CORRECTION FACTOR (dB/m)
1	*5230.00	97.5 PK			1.35 H	281	93.6	3.9
2	*5230.00	88.5 AV			1.35 H	281	84.6	3.9
3	5350.00	51.1 PK	74.0	-22.9	1.35 H	281	47.1	4.0
4	5350.00	37.6 AV	54.0	-16.4	1.35 H	281	33.6	4.0
5	#10460.00	45.7 PK	74.0	-28.3	1.84 H	304	31.8	13.9
6	#10460.00	41.4 AV	54.0	-12.6	1.84 H	304	27.5	13.9
7	15690.00	46.5 PK	74.0	-27.5	1.52 H	129	32.9	13.6
8	15690.00	34.9 AV	54.0	-19.1	1.52 H	129	21.3	13.6

ANTENNA POLARITY & TEST DISTANCE: VERTICAL AT 3 M

NO.	FREQ. (MHz)	EMISSION LEVEL (dBuV/m)	LIMIT (dBuV/m)	MARGIN (dB)	ANTENNA HEIGHT (m)	TABLE ANGLE (Degree)	RAW VALUE (dBuV)	CORRECTION FACTOR (dB/m)
1	*5230.00	113.0 PK			1.48 V	225	109.1	3.9
2	*5230.00	102.9 AV			1.48 V	225	99.0	3.9
3	5350.00	55.1 PK	74.0	-18.9	1.48 V	225	51.1	4.0
4	5350.00	40.6 AV	54.0	-13.4	1.48 V	225	36.6	4.0
5	#10460.00	49.4 PK	74.0	-24.6	3.20 V	321	35.5	13.9
6	#10460.00	37.2 AV	54.0	-16.8	3.20 V	321	23.3	13.9
7	15690.00	48.3 PK	74.0	-25.7	1.52 V	66	34.7	13.6
8	15690.00	35.1 AV	54.0	-18.9	1.52 V	66	21.5	13.6

REMARKS:

1. Emission Level(dBuV/m) = Raw Value(dBuV) + Correction Factor(dB/m)
2. Correction Factor(dB/m) = Antenna Factor(dB/m) + Cable Factor(dB) – Pre-Amplifier Factor(dB)
3. The other emission levels were very low against the limit.
4. Margin value = Emission Level – Limit value
5. " * ": Fundamental frequency.
6. " # ": The radiated frequency is out of the restricted band.

CHANNEL	TX Channel 151	DETECTOR FUNCTION	Peak (PK)
FREQUENCY RANGE	1GHz ~ 40GHz		Average (AV)

ANTENNA POLARITY & TEST DISTANCE: HORIZONTAL AT 3 M

NO.	FREQ. (MHz)	EMISSION LEVEL (dBuV/m)	LIMIT (dBuV/m)	MARGIN (dB)	ANTENNA HEIGHT (m)	TABLE ANGLE (Degree)	RAW VALUE (dBuV)	CORRECTION FACTOR (dB/m)
1	*5755.00	103.0 PK			1.15 H	326	98.4	4.6
2	*5755.00	93.4 AV			1.15 H	326	88.8	4.6
3	11510.00	50.8 PK	74.0	-23.2	1.86 H	288	36.7	14.1
4	11510.00	46.4 AV	54.0	-7.6	1.86 H	288	32.3	14.1
5	#17265.00	59.6 PK	74.0	-14.4	2.36 H	32	42.5	17.1
6	#17265.00	48.3 AV	54.0	-5.7	2.36 H	32	31.2	17.1

ANTENNA POLARITY & TEST DISTANCE: VERTICAL AT 3 M

NO.	FREQ. (MHz)	EMISSION LEVEL (dBuV/m)	LIMIT (dBuV/m)	MARGIN (dB)	ANTENNA HEIGHT (m)	TABLE ANGLE (Degree)	RAW VALUE (dBuV)	CORRECTION FACTOR (dB/m)
1	*5755.00	116.2 PK			1.91 V	12	111.6	4.6
2	*5755.00	106.4 AV			1.91 V	12	101.8	4.6
3	11510.00	48.6 PK	74.0	-25.4	3.43 V	314	34.5	14.1
4	11510.00	39.7 AV	54.0	-14.3	3.43 V	314	25.6	14.1
5	#17265.00	53.2 PK	74.0	-20.8	1.49 V	320	36.1	17.1
6	#17265.00	42.0 AV	54.0	-12.0	1.49 V	320	24.9	17.1

REMARKS:

1. Emission Level(dBuV/m) = Raw Value(dBuV) + Correction Factor(dB/m)
2. Correction Factor(dB/m) = Antenna Factor(dB/m) + Cable Factor(dB) – Pre-Amplifier Factor(dB)
3. The other emission levels were very low against the limit.
4. Margin value = Emission Level – Limit value
5. " * ": Fundamental frequency.
6. " # ": The radiated frequency is out of the restricted band.

CHANNEL	TX Channel 159	DETECTOR FUNCTION	Peak (PK)
FREQUENCY RANGE	1GHz ~ 40GHz		Average (AV)

ANTENNA POLARITY & TEST DISTANCE: HORIZONTAL AT 3 M

NO.	FREQ. (MHz)	EMISSION LEVEL (dBuV/m)	LIMIT (dBuV/m)	MARGIN (dB)	ANTENNA HEIGHT (m)	TABLE ANGLE (Degree)	RAW VALUE (dBuV)	CORRECTION FACTOR (dB/m)
1	*5795.00	102.8 PK			1.34 H	329	98.1	4.7
2	*5795.00	93.0 AV			1.34 H	329	88.3	4.7
3	11590.00	50.7 PK	74.0	-23.3	1.92 H	296	36.6	14.1
4	11590.00	46.4 AV	54.0	-7.6	1.92 H	296	32.3	14.1
5	#17385.00	59.5 PK	74.0	-14.5	2.40 H	57	41.5	18.0
6	#17385.00	48.0 AV	54.0	-6.0	2.40 H	57	30.0	18.0

ANTENNA POLARITY & TEST DISTANCE: VERTICAL AT 3 M

NO.	FREQ. (MHz)	EMISSION LEVEL (dBuV/m)	LIMIT (dBuV/m)	MARGIN (dB)	ANTENNA HEIGHT (m)	TABLE ANGLE (Degree)	RAW VALUE (dBuV)	CORRECTION FACTOR (dB/m)
1	*5795.00	116.7 PK			1.87 V	21	112.0	4.7
2	*5795.00	106.7 AV			1.87 V	21	102.0	4.7
3	11590.00	49.0 PK	74.0	-25.0	3.44 V	327	34.9	14.1
4	11590.00	40.2 AV	54.0	-13.8	3.44 V	327	26.1	14.1
5	#17385.00	53.6 PK	74.0	-20.4	1.53 V	336	35.6	18.0
6	#17385.00	41.9 AV	54.0	-12.1	1.53 V	336	23.9	18.0

REMARKS:

1. Emission Level(dBuV/m) = Raw Value(dBuV) + Correction Factor(dB/m)
2. Correction Factor(dB/m) = Antenna Factor(dB/m) + Cable Factor(dB) – Pre-Amplifier Factor(dB)
3. The other emission levels were very low against the limit.
4. Margin value = Emission Level – Limit value
5. " * ": Fundamental frequency.
6. " # ": The radiated frequency is out of the restricted band.

802.11ac (VHT80)

CHANNEL	TX Channel 42	DETECTOR FUNCTION	Peak (PK)
FREQUENCY RANGE	1GHz ~ 40GHz		Average (AV)

ANTENNA POLARITY & TEST DISTANCE: HORIZONTAL AT 3 M

NO.	FREQ. (MHz)	EMISSION LEVEL (dBuV/m)	LIMIT (dBuV/m)	MARGIN (dB)	ANTENNA HEIGHT (m)	TABLE ANGLE (Degree)	RAW VALUE (dBuV)	CORRECTION FACTOR (dB/m)
1	5150.00	64.1 PK	74.0	-9.9	1.39 H	269	59.8	4.3
2	5150.00	43.8 AV	54.0	-10.2	1.39 H	269	39.5	4.3
3	*5210.00	94.2 PK			1.39 H	269	90.1	4.1
4	*5210.00	85.3 AV			1.39 H	269	81.2	4.1
5	5350.00	55.3 PK	74.0	-18.7	1.39 H	269	51.3	4.0
6	5350.00	41.6 AV	54.0	-12.4	1.39 H	269	37.6	4.0
7	#10420.00	45.5 PK	74.0	-28.5	1.82 H	297	31.9	13.6
8	#10420.00	41.5 AV	54.0	-12.5	1.82 H	297	27.9	13.6
9	15630.00	47.5 PK	74.0	-26.5	1.54 H	134	34.2	13.3
10	15630.00	35.9 AV	54.0	-18.1	1.54 H	134	22.6	13.3

ANTENNA POLARITY & TEST DISTANCE: VERTICAL AT 3 M

NO.	FREQ. (MHz)	EMISSION LEVEL (dBuV/m)	LIMIT (dBuV/m)	MARGIN (dB)	ANTENNA HEIGHT (m)	TABLE ANGLE (Degree)	RAW VALUE (dBuV)	CORRECTION FACTOR (dB/m)
1	5150.00	67.2 PK	74.0	-6.8	1.51 V	226	62.9	4.3
2	5150.00	53.9 AV	54.0	-0.1	1.51 V	226	49.6	4.3
3	*5210.00	109.7 PK			1.51 V	226	105.6	4.1
4	*5210.00	99.7 AV			1.51 V	226	95.6	4.1
5	5350.00	59.2 PK	74.0	-14.8	1.51 V	226	55.2	4.0
6	5350.00	46.9 AV	54.0	-7.1	1.51 V	226	42.9	4.0
7	#10420.00	49.8 PK	74.0	-24.2	3.24 V	318	36.2	13.6
8	#10420.00	37.6 AV	54.0	-16.4	3.24 V	318	24.0	13.6
9	15630.00	48.2 PK	74.0	-25.8	1.47 V	57	34.9	13.3
10	15630.00	34.7 AV	54.0	-19.3	1.47 V	57	21.4	13.3

REMARKS:

- Emission Level(dBuV/m) = Raw Value(dBuV) + Correction Factor(dB/m)
- Correction Factor(dB/m) = Antenna Factor(dB/m) + Cable Factor(dB) – Pre-Amplifier Factor(dB)
- The other emission levels were very low against the limit.
- Margin value = Emission Level – Limit value
- " * ": Fundamental frequency.
- " # ": The radiated frequency is out of the restricted band.

CHANNEL	TX Channel 155	DETECTOR FUNCTION	Peak (PK)
FREQUENCY RANGE	1GHz ~ 40GHz		Average (AV)

ANTENNA POLARITY & TEST DISTANCE: HORIZONTAL AT 3 M

NO.	FREQ. (MHz)	EMISSION LEVEL (dBuV/m)	LIMIT (dBuV/m)	MARGIN (dB)	ANTENNA HEIGHT (m)	TABLE ANGLE (Degree)	RAW VALUE (dBuV)	CORRECTION FACTOR (dB/m)
1	*5775.00	96.2 PK			1.51 H	331	91.6	4.6
2	*5775.00	86.8 AV			1.51 H	331	82.2	4.6
3	11550.00	45.8 PK	74.0	-28.2	1.87 H	314	31.7	14.1
4	11550.00	41.6 AV	54.0	-12.4	1.87 H	314	27.5	14.1
5	#17325.00	48.1 PK	74.0	-25.9	1.47 H	151	30.7	17.4
6	#17325.00	36.0 AV	54.0	-18.0	1.47 H	151	18.6	17.4

ANTENNA POLARITY & TEST DISTANCE: VERTICAL AT 3 M

NO.	FREQ. (MHz)	EMISSION LEVEL (dBuV/m)	LIMIT (dBuV/m)	MARGIN (dB)	ANTENNA HEIGHT (m)	TABLE ANGLE (Degree)	RAW VALUE (dBuV)	CORRECTION FACTOR (dB/m)
1	*5775.00	110.4 PK			1.88 V	360	105.8	4.6
2	*5775.00	101.4 AV			1.88 V	360	96.8	4.6
3	11550.00	48.0 PK	74.0	-26.0	3.41 V	327	33.9	14.1
4	11550.00	39.2 AV	54.0	-14.8	3.41 V	327	25.1	14.1
5	#17325.00	54.0 PK	74.0	-20.0	1.54 V	323	36.6	17.4
6	#17325.00	42.5 AV	54.0	-11.5	1.54 V	323	25.1	17.4

REMARKS:

1. Emission Level(dBuV/m) = Raw Value(dBuV) + Correction Factor(dB/m)
2. Correction Factor(dB/m) = Antenna Factor(dB/m) + Cable Factor(dB) – Pre-Amplifier Factor(dB)
3. The other emission levels were very low against the limit.
4. Margin value = Emission Level – Limit value
5. " * ": Fundamental frequency.
6. " # ": The radiated frequency is out of the restricted band.

Below 1GHz Data:

802.11ac (VHT40)

CHANNEL	TX Channel 159	DETECTOR FUNCTION	Quasi-Peak (QP)
FREQUENCY RANGE	9kHz ~ 1GHz		

ANTENNA POLARITY & TEST DISTANCE: HORIZONTAL AT 3 M

NO.	FREQ. (MHz)	EMISSION LEVEL (dBuV/m)	LIMIT (dBuV/m)	MARGIN (dB)	ANTENNA HEIGHT (m)	TABLE ANGLE (Degree)	RAW VALUE (dBuV)	CORRECTION FACTOR (dB/m)
1	30.00	34.5 QP	40.0	-5.5	2.43 H	172	43.3	-8.8
2	125.06	37.4 QP	43.5	-6.1	2.41 H	183	46.8	-9.4
3	311.30	41.1 QP	46.0	-4.9	1.95 H	273	47.9	-6.8
4	421.88	38.6 QP	46.0	-7.4	1.62 H	281	42.5	-3.9
5	491.72	39.8 QP	46.0	-6.2	1.44 H	189	42.2	-2.4
6	837.04	37.5 QP	46.0	-8.5	1.02 H	225	33.9	3.6

ANTENNA POLARITY & TEST DISTANCE: VERTICAL AT 3 M

NO.	FREQ. (MHz)	EMISSION LEVEL (dBuV/m)	LIMIT (dBuV/m)	MARGIN (dB)	ANTENNA HEIGHT (m)	TABLE ANGLE (Degree)	RAW VALUE (dBuV)	CORRECTION FACTOR (dB/m)
1	38.22	33.1 QP	40.0	-6.9	1.09 V	142	41.5	-8.4
2	124.99	39.6 QP	43.5	-3.9	1.19 V	273	49.0	-9.4
3	313.25	36.6 QP	46.0	-9.4	1.09 V	311	43.3	-6.7
4	348.16	36.5 QP	46.0	-9.5	1.12 V	83	42.5	-6.0
5	544.10	41.2 QP	46.0	-4.8	1.67 V	139	42.7	-1.5
6	852.56	37.5 QP	46.0	-8.5	1.18 V	243	33.8	3.7

REMARKS:

1. Emission Level(dBuV/m) = Raw Value(dBuV) + Correction Factor(dB/m)
2. Correction Factor(dB/m) = Antenna Factor(dB/m) + Cable Factor(dB) – Pre-Amplifier Factor(dB)
3. The other emission levels were very low against the limit.
4. Margin value = Emission Level – Limit value

4.2 Conducted Emission Measurement

4.2.1 Limits of Conducted Emission Measurement

Frequency (MHz)	Conducted Limit (dBuV)	
	Quasi-peak	Average
0.15 - 0.5	66 - 56	56 - 46
0.50 - 5.0	56	46
5.0 - 30.0	60	50

Note: 1. The lower limit shall apply at the transition frequencies.

2. The limit decreases in line with the logarithm of the frequency in the range of 0.15 to 0.50MHz.

4.2.2 Test Instruments

DESCRIPTION & MANUFACTURER	MODEL NO.	SERIAL NO.	CALIBRATED DATE	CALIBRATED UNTIL
Test Receiver R&S	ESCS 30	847124/029	Nov. 01, 2017	Oct. 31, 2018
Line-Impedance Stabilization Network (for EUT) R&S	ESH3-Z5	848773/004	Nov. 15, 20167	Nov. 14, 2018
Line-Impedance Stabilization Network (for Peripheral) R&S	ENV216	100072	June 03, 2017	June 02, 2018
50 ohms Terminator	N/A	EMC-02	Sep. 22, 2017	Sep. 21, 2018
RF Cable	5D-FB	COCCAB-001	Sep. 29, 2017	Sep. 28, 2018
10 dB PAD Mini-Circuits	HAT-10+	CONATT-004	June 18, 2017	June 17, 2018
Software BVADT	BVADT_Cond_ V7.3.7.4	NA	NA	NA

Note:

1. The calibration interval of the above test instruments are 12 months and the calibrations are traceable to NML/ROC and NIST/USA.
2. The test was performed in Shielded Room No. 1.
- 3 Tested Date: Jan. 17, 2018

4.2.3 Test Procedure

- The EUT was placed 0.4 meters from the conducting wall of the shielded room with EUT being connected to the power mains through a line impedance stabilization network (LISN). Other support units were connected to the power mains through another LISN. The two LISNs provide 50 ohm/ 50uH of coupling impedance for the measuring instrument.
- Both lines of the power mains connected to the EUT were checked for maximum conducted interference.
- The frequency range from 150kHz to 30MHz was searched. Emission levels under (Limit - 20dB) was not recorded.

NOTE: All modes of operation were investigated and the worst-case emissions are reported.

4.2.4 Deviation from Test Standard

No deviation.

4.2.5 Test Setup

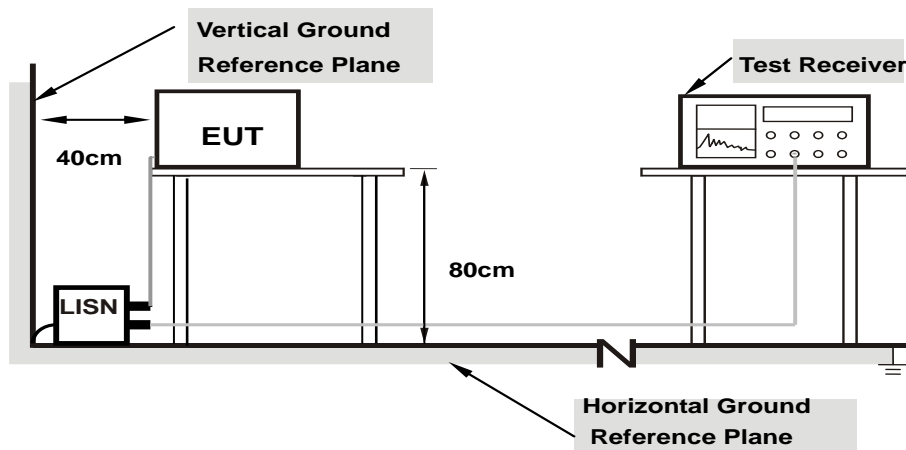

Note: 1.Support units were connected to second LISN.

For the actual test configuration, please refer to the attached file (Test Setup Photo).

4.2.6 EUT Operating Condition

Same as 4.1.6.

4.2.7 Test Results

Phase	Line (L)	Detector Function	Quasi-Peak (QP) / Average (AV)
-------	----------	-------------------	--------------------------------

No	Freq. [MHz]	Corr. Factor	Reading Value [dB (uV)]		Emission Level [dB (uV)]		Limit [dB (uV)]		Margin (dB)	
		(dB)	Q.P.	AV.	Q.P.	AV.	Q.P.	AV.	Q.P.	AV.
	1	0.15000	10.13	38.58	27.27	48.71	37.40	66.00	56.00	-17.29
2	0.18906	10.14	31.52	21.95	41.66	32.09	64.08	54.08	-22.42	-21.99
3	0.38047	10.19	35.64	28.87	45.83	39.06	58.27	48.27	-12.44	-9.21
4	0.69688	10.21	26.65	18.89	36.86	29.10	56.00	46.00	-19.14	-16.90
5	0.97813	10.23	22.96	13.50	33.19	23.73	56.00	46.00	-22.81	-22.27
6	25.87500	11.28	21.15	19.97	32.43	31.25	60.00	50.00	-27.57	-18.75

REMARKS:

1. Q.P. and AV. are abbreviations of quasi-peak and average individually.
2. The emission levels of other frequencies were very low against the limit.
3. Margin value = Emission level - Limit value
4. Correction factor = Insertion loss + Cable loss
5. Emission Level = Correction Factor + Reading Value.

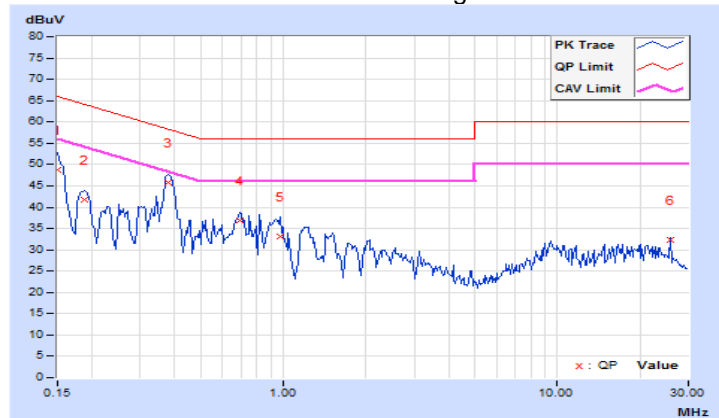

Phase	Neutral (N)	Detector Function	Quasi-Peak (QP) / Average (AV)
-------	-------------	-------------------	--------------------------------

No	Freq. [MHz]	Corr.	Reading Value		Emission Level		Limit		Margin	
		Factor (dB)	[dB (uV)]		[dB (uV)]		[dB (uV)]		(dB)	
			Q.P.	AV.	Q.P.	AV.	Q.P.	AV.	Q.P.	AV.
1	0.15000	10.04	38.74	27.45	48.78	37.49	66.00	56.00	-17.22	-18.51
2	0.18906	10.04	31.65	22.56	41.69	32.60	64.08	54.08	-22.39	-21.48
3	0.38438	10.08	35.52	29.12	45.60	39.20	58.18	48.18	-12.58	-8.98
4	1.23828	10.12	24.34	16.24	34.46	26.36	56.00	46.00	-21.54	-19.64
5	9.57422	10.47	22.08	18.76	32.55	29.23	60.00	50.00	-27.45	-20.77
6	25.87500	11.05	21.23	19.99	32.28	31.04	60.00	50.00	-27.72	-18.96

REMARKS:

1. Q.P. and AV. are abbreviations of quasi-peak and average individually.
2. The emission levels of other frequencies were very low against the limit.
3. Margin value = Emission level - Limit value
4. Correction factor = Insertion loss + Cable loss
5. Emission Level = Correction Factor + Reading Value.

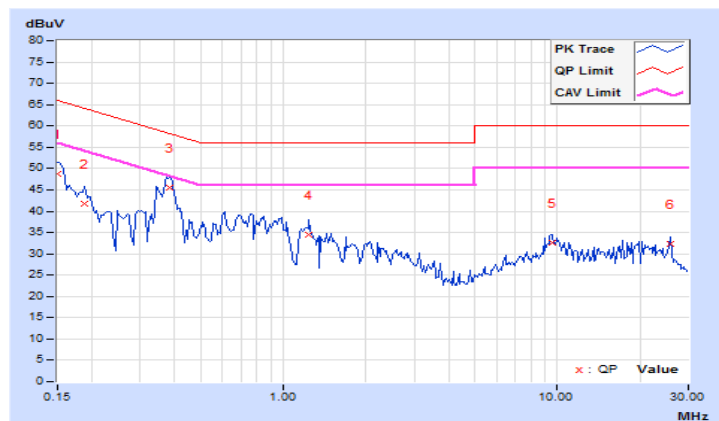

4.3 Transmit Power Measurement

4.3.1 Limits of Transmit Power Measurement

Operation Band	EUT Category		Limit
U-NII-1	√	Outdoor Access Point	1 Watt (30 dBm) (Max. e.i.r.p ≤ 125mW(21 dBm) at any elevation angle above 30 degrees as measured from the horizon)
		Fixed point-to-point Access Point	1 Watt (30 dBm)
		Indoor Access Point	1 Watt (30 dBm)
	√	Client device	250mW (24 dBm)
U-NII-2A			250mW (24 dBm) or 11 dBm+10 log B*
U-NII-2C			250mW (24 dBm) or 11 dBm+10 log B*
U-NII-3		√	1 Watt (30 dBm)

*B is the 26 dB emission bandwidth in megahertz

Note: This device can support different category application which switched by access point mode and client mode by software.

Per KDB 662911 Method of conducted output power measurement on IEEE 802.11 devices,

Array Gain = 0 dB (i.e., no array gain) for $N_{ANT} \leq 4$;

Array Gain = 0 dB (i.e., no array gain) for channel widths ≥ 40 MHz for any N_{ANT} ;

Array Gain = $5 \log(N_{ANT}/N_{SS})$ dB or 3 dB, whichever is less for 20-MHz channel widths with $N_{ANT} \geq 5$.

For power measurements on all other devices: Array Gain = $10 \log(N_{ANT}/N_{SS})$ dB.

4.3.2 Test Setup

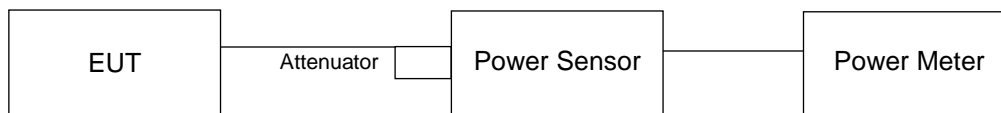

4.3.3 Test Instruments

Refer to section 4.1.2 to get information of above instrument.

4.3.4 Test Procedure

Method PM is used to perform output power measurement, trigger and gating function of wide band power meter is enabled to measure max output power of TX on burst. Duty factor is not added to measured value.

4.3.5 Deviation from Test Standard

No deviation.

4.3.6 EUT Operating Condition

The software provided by client to enable the EUT under transmission condition continuously at lowest, middle and highest channel frequencies individually.

4.3.7 Test Result

For U-NII-1:

Master Mode

802.11a

Chan.	Chan. Freq. (MHz)	Maximum Conducted Power (dBm)		Total Power (mW)	Total Power (dBm)	Limit (dBm)	Pass / Fail
		Chain 0	Chain 1				
36	5180	19.61	19.86	188.239	22.75	29.08	Pass
40	5200	19.56	19.97	189.677	22.78	29.08	Pass
48	5240	19.74	20.13	197.228	22.95	29.08	Pass

Note: Max. gain = 6.92dBi > 6dBi , so the power limit shall be reduced to $30 - (6.92 - 6) = 29.08$ dBm

EIRP POWER OUTPUT

Chan.	Chan. Freq. (MHz)	EIRP Power (mW)	EIRP Power (dBm)	Power Limit (dBm)	Pass / Fail
36	5180	116.335	20.66	21.00	Pass
40	5200	117.223	20.69	21.00	Pass
48	5240	121.890	20.86	21.00	Pass

Note:

1. This device is outdoor access point and antenna at any elevation angle above 30 degrees as measured from the horizon, therefore Max. e.i.r.p ≤ 125 mW(21 dBm) to compliance.
2. Max gain is -2.08956dBi at any elevation angle above 30 degrees.

802.11ac (VHT20)

Chan.	Chan. Freq. (MHz)	Maximum Conducted Power (dBm)		Total Power (mW)	Total Power (dBm)	Limit (dBm)	Pass / Fail
		Chain 0	Chain 1				
36	5180	19.48	19.86	185.544	22.68	29.08	Pass
40	5200	19.52	19.71	183.077	22.63	29.08	Pass
48	5240	19.85	19.98	196.146	22.93	29.08	Pass

Note: Max. gain = 6.92dBi > 6dBi , so the power limit shall be reduced to $30-(6.92-6) = 29.08\text{dBm}$

EIRP POWER OUTPUT

Chan.	Chan. Freq. (MHz)	EIRP Power (mW)	EIRP Power (dBm)	Power Limit (dBm)	Pass / Fail
36	5180	114.669	20.59	21.00	Pass
40	5200	113.145	20.54	21.00	Pass
48	5240	121.221	20.84	21.00	Pass

Note:

1. This device is outdoor access point and antenna at any elevation angle above 30 degrees as measured from the horizon, therefore Max. e.i.r.p $\leq 125\text{mW}(21\text{ dBm})$ to compliance.
2. Max gain is -2.08956dBi at any elevation angle above 30 degrees.

802.11ac (VHT40)

Chan.	Chan. Freq. (MHz)	Maximum Conducted Power (dBm)		Total Power (mW)	Total Power (dBm)	Limit (dBm)	Pass / Fail
		Chain 0	Chain 1				
38	5190	19.84	19.98	195.924	22.92	29.08	Pass
46	5230	19.89	20.18	201.731	23.05	29.08	Pass

Note: Max. gain = 6.92dBi > 6dBi , so the power limit shall be reduced to $30-(6.92-6) = 29.08\text{dBm}$

EIRP POWER OUTPUT

Chan.	Chan. Freq. (MHz)	EIRP Power (mW)	EIRP Power (dBm)	Power Limit (dBm)	Pass / Fail
38	5190	121.084	20.83	21.00	Pass
46	5230	124.673	20.96	21.00	Pass

Note:

1. This device is outdoor access point and antenna at any elevation angle above 30 degrees as measured from the horizon, therefore Max. e.i.r.p $\leq 125\text{mW}(21\text{ dBm})$ to compliance.
2. Max gain is -2.08956dBi at any elevation angle above 30 degrees.

802.11ac (VHT80)

Chan.	Chan. Freq. (MHz)	Maximum Conducted Power (dBm)		Total Power (mW)	Total Power (dBm)	Limit (dBm)	Pass / Fail
		Chain 0	Chain 1				
42	5210	19.48	19.83	184.877	22.67	29.08	Pass

Note: Max. gain = 6.92dBi > 6dBi , so the power limit shall be reduced to $30 - (6.92 - 6) = 29.08$ dBm

EIRP POWER OUTPUT

Chan.	Chan. Freq. (MHz)	EIRP Power (mW)	EIRP Power (dBm)	Power Limit (dBm)	Pass / Fail
42	5210	114.257	20.58	21.00	Pass

Note:

1. This device is outdoor access point and antenna at any elevation angle above 30 degrees as measured from the horizon, therefore Max. e.i.r.p ≤ 125 mW(21 dBm) to compliance.

2. Max gain is -2.08956dBi at any elevation angle above 30 degrees.

Client Mode
802.11a

Chan.	Chan. Freq. (MHz)	Maximum Conducted Power (dBm)		Total Power (mW)	Total Power (dBm)	Limit (dBm)	Pass / Fail
		Chain 0	Chain 1				
36	5180	16.64	16.88	94.885	19.77	23.08	Pass
40	5200	16.59	16.89	94.469	19.75	23.08	Pass
48	5240	16.73	17.09	98.266	19.92	23.08	Pass

Note: Max. gain = 6.92dBi > 6dBi , so the power limit shall be reduced to $24 - (6.92 - 6) = 23.08$ dBm

802.11ac (VHT20)

Chan.	Chan. Freq. (MHz)	Maximum Conducted Power (dBm)		Total Power (mW)	Total Power (dBm)	Limit (dBm)	Pass / Fail
		Chain 0	Chain 1				
36	5180	16.83	17.22	100.918	20.04	23.08	Pass
40	5200	16.51	16.84	93.077	19.69	23.08	Pass
48	5240	16.96	17.10	100.945	20.04	23.08	Pass

Note: Max. gain = 6.92dBi > 6dBi , so the power limit shall be reduced to $24 - (6.92 - 6) = 23.08$ dBm

802.11ac (VHT40)

Chan.	Chan. Freq. (MHz)	Maximum Conducted Power (dBm)		Total Power (mW)	Total Power (dBm)	Limit (dBm)	Pass / Fail
		Chain 0	Chain 1				
38	5190	19.84	20.02	196.845	22.94	23.08	Pass
46	5230	19.89	20.19	201.971	23.05	23.08	Pass

Note: Max. gain = 6.92dBi > 6dBi , so the power limit shall be reduced to $24 - (6.92 - 6) = 23.08$ dBm

802.11ac (VHT80)

Chan.	Chan. Freq. (MHz)	Maximum Conducted Power (dBm)		Total Power (mW)	Total Power (dBm)	Limit (dBm)	Pass / Fail
		Chain 0	Chain 1				
42	5210	19.48	19.83	184.877	22.67	23.08	Pass

Note: Max. gain = 6.92dBi > 6dBi , so the power limit shall be reduced to $24 - (6.92 - 6) = 23.08$ dBm

For U-NII-3:
802.11a

Chan.	Chan. Freq. (MHz)	Maximum Conducted Power (dBm)		Total Power (mW)	Total Power (dBm)	Limit (dBm)	Pass / Fail
		Chain 0	Chain 1				
149	5745	25.92	25.61	754.756	28.78	29.08	Pass
157	5785	25.79	25.88	766.573	28.85	29.08	Pass
165	5825	25.84	25.61	747.622	28.74	29.08	Pass

Note: Max. gain = 6.92dBi > 6dBi , so the power limit shall be reduced to $30-(6.92-6) = 29.08$ dBm

802.11ac (VHT20)

Chan.	Chan. Freq. (MHz)	Maximum Conducted Power (dBm)		Total Power (mW)	Total Power (dBm)	Limit (dBm)	Pass / Fail
		Chain 0	Chain 1				
149	5745	25.89	25.61	752.065	28.76	29.08	Pass
157	5785	25.68	25.88	757.086	28.79	29.08	Pass
165	5825	25.76	25.72	749.954	28.75	29.08	Pass

Note: Max. gain = 6.92dBi > 6dBi , so the power limit shall be reduced to $30-(6.92-6) = 29.08$ dBm

802.11ac (VHT40)

Chan.	Chan. Freq. (MHz)	Maximum Conducted Power (dBm)		Total Power (mW)	Total Power (dBm)	Limit (dBm)	Pass / Fail
		Chain 0	Chain 1				
151	5755	25.20	25.66	699.26	28.45	29.08	Pass
159	5795	25.71	26.13	782.596	28.94	29.08	Pass

Note: Max. gain = 6.92dBi > 6dBi , so the power limit shall be reduced to $30-(6.92-6) = 29.08$ dBm

802.11ac (VHT80)

Chan.	Chan. Freq. (MHz)	Maximum Conducted Power (dBm)		Total Power (mW)	Total Power (dBm)	Limit (dBm)	Pass / Fail
		Chain 0	Chain 1				
155	5775	22.89	23.17	402.027	26.04	29.08	Pass

Note: Max. gain = 6.92dBi > 6dBi , so the power limit shall be reduced to $30-(6.92-6) = 29.08$ dBm

4.4 Occupied Bandwidth Measurement

4.4.1 Test Setup

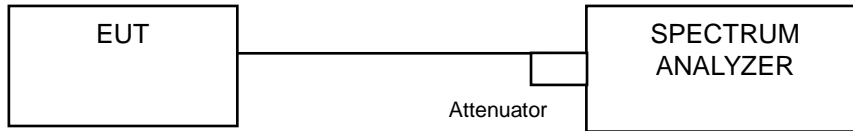

4.4.2 Test Instruments

Refer to section 4.1.2 to get information of above instrument.

4.4.3 Test Procedure

The transmitter output was connected to the spectrum analyzer through an attenuator. The bandwidth of the fundamental frequency was measured by spectrum analyzer with resolution bandwidth in the range of 1% to 5% of the anticipated emission bandwidth, and a video bandwidth at least 3x the resolution bandwidth and set the detector to SAMPLE. The width of a frequency band such that, below the lower and above the upper frequency limits, the mean powers emitted are each equal to a specified percentage 0.5 %of the total mean power of a given emission.

4.4.4 Test Results

For U-NII-1:
Master Mode
802.11a

Channel	Channel Frequency (MHz)	Occupied Bandwidth (MHz)	
		Chain 0	Chain 1
36	5180	16.56	16.44
40	5200	16.44	16.56
48	5240	16.44	16.56

802.11ac (VHT20)

Channel	Channel Frequency (MHz)	Occupied Bandwidth (MHz)	
		Chain 0	Chain 1
36	5180	17.76	17.76
40	5200	17.76	17.76
48	5240	17.64	17.64

802.11ac (VHT40)

Channel	Channel Frequency (MHz)	Occupied Bandwidth (MHz)	
		Chain 0	Chain 1
38	5190	36.24	36.24
46	5230	36.24	36.24

802.11ac (VHT80)

Channel	Channel Frequency (MHz)	Occupied Bandwidth (MHz)	
		Chain 0	Chain 1
42	5210	76.32	75.84

Spectrum Plot of Worst Value

802.11a / Chain 0 : CH36

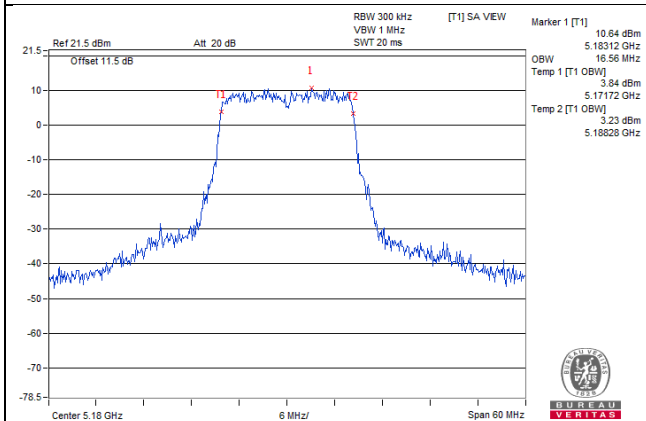

802.11ac (VHT20) / Chain 0 : CH36

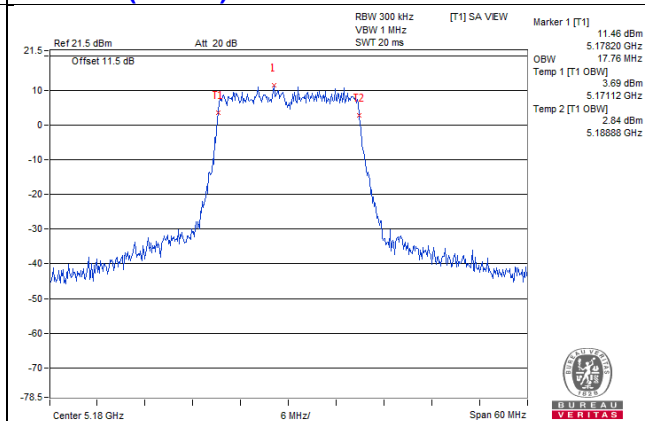

802.11ac (VHT40) / Chain 0 : CH38

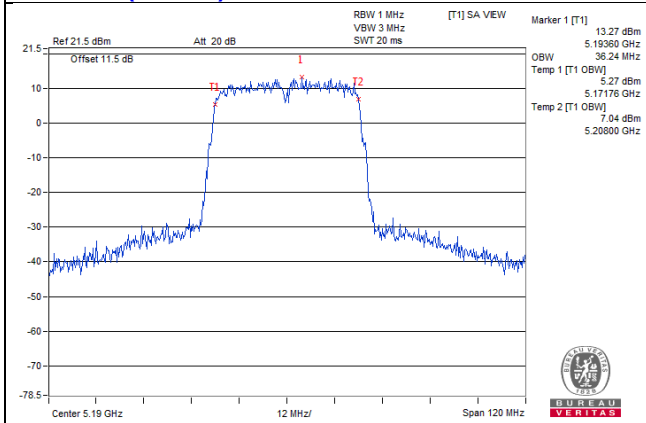

802.11ac (VHT80) / Chain 0 : CH42

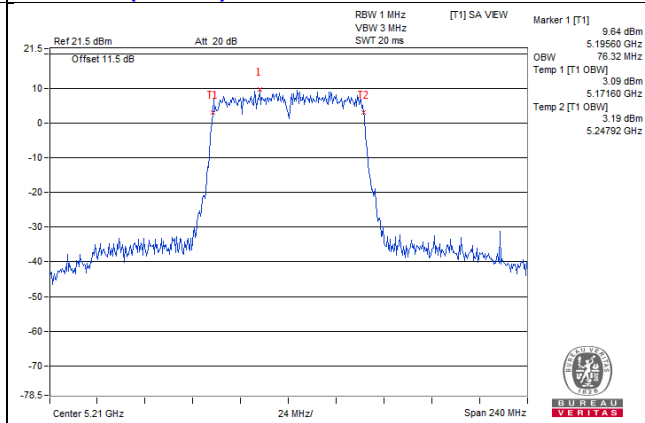

Client Mode
802.11a

Channel	Channel Frequency (MHz)	Occupied Bandwidth (MHz)	
		Chain 0	Chain 1
36	5180	16.56	16.56
40	5200	16.56	16.44
48	5240	16.56	16.56

802.11ac (VHT20)

Channel	Channel Frequency (MHz)	Occupied Bandwidth (MHz)	
		Chain 0	Chain 1
36	5180	17.76	17.76
40	5200	17.64	17.64
48	5240	17.76	17.76

802.11ac (VHT40)

Channel	Channel Frequency (MHz)	Occupied Bandwidth (MHz)	
		Chain 0	Chain 1
38	5190	36.24	36.24
46	5230	36.24	36.24

802.11ac (VHT80)

Channel	Channel Frequency (MHz)	Occupied Bandwidth (MHz)	
		Chain 0	Chain 1
42	5210	76.32	75.84

Spectrum Plot of Worst Value

802.11a / Chain 0 : CH36

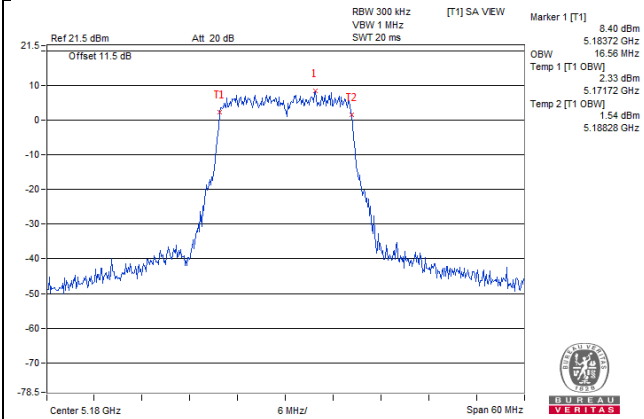

802.11ac (VHT20) / Chain 0 : CH36

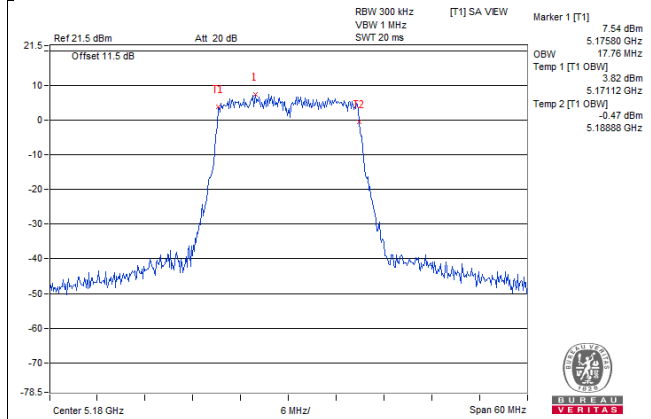

802.11ac (VHT40) / Chain 0 : CH38

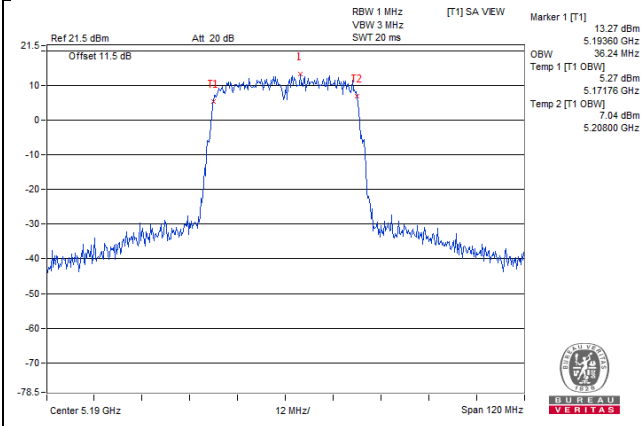

802.11ac (VHT80) / Chain 0 : CH42

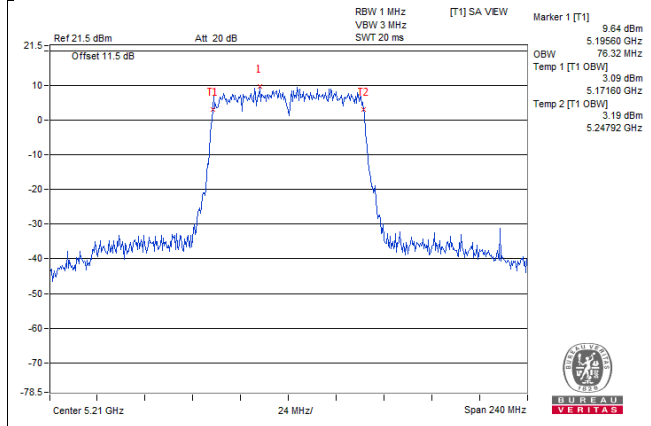

For U-NII-3:
802.11a

Channel	Channel Frequency (MHz)	Occupied Bandwidth (MHz)	
		Chain 0	Chain 1
149	5745	25.80	25.20
157	5785	25.20	23.16
165	5825	23.76	21.00

802.11ac (VHT20)

Channel	Channel Frequency (MHz)	Occupied Bandwidth (MHz)	
		Chain 0	Chain 1
149	5745	26.76	26.52
157	5785	25.56	23.52
165	5825	23.28	21.00

802.11ac (VHT40)

Channel	Channel Frequency (MHz)	Occupied Bandwidth (MHz)	
		Chain 0	Chain 1
151	5755	37.44	40.32
159	5795	37.68	37.44

802.11ac (VHT80)

Channel	Channel Frequency (MHz)	Occupied Bandwidth (MHz)	
		Chain 0	Chain 1
155	5775	75.84	76.32

Spectrum Plot of Worst Value

802.11a / Chain 0 : CH149

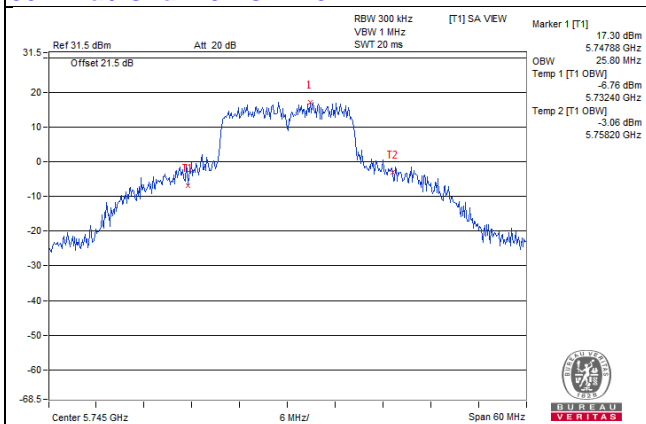

802.11ac (VHT20) / Chain 0 : CH149

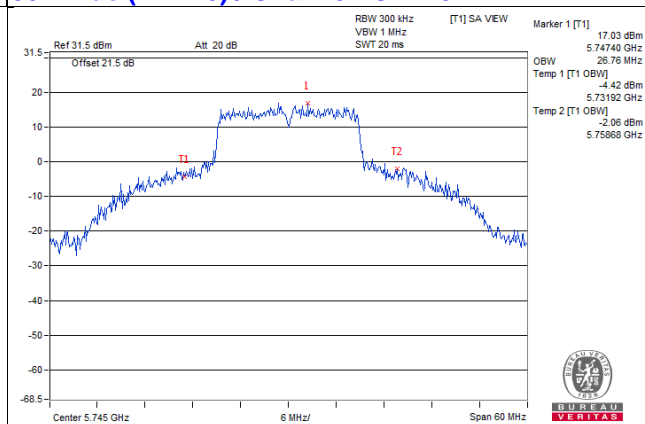

802.11ac (VHT40) / Chain 1 : CH151

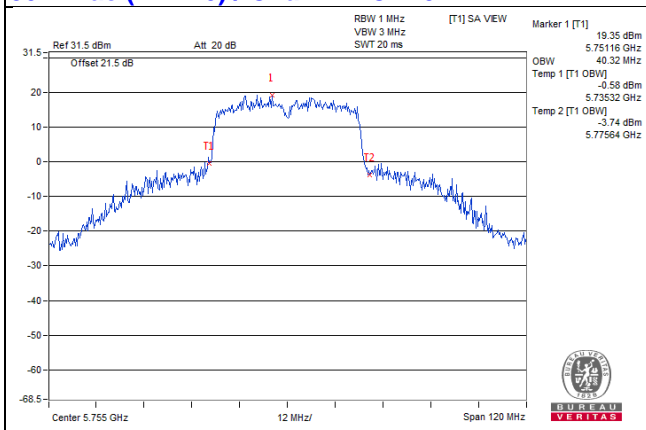

802.11ac (VHT80) / Chain 1 : CH155

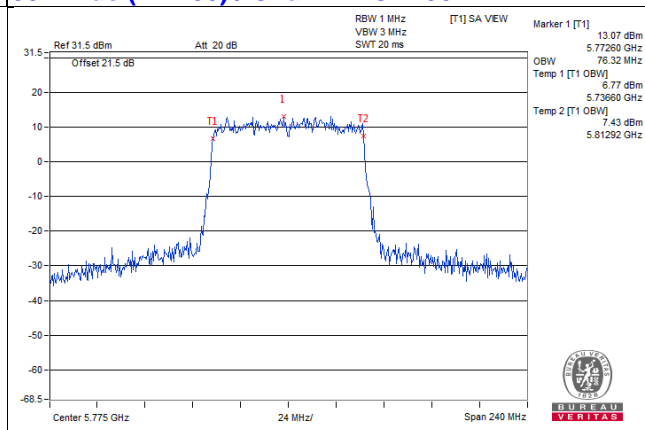

**Spectrum Plot for near by DFS band
(DFS is required, if 99% OCP straddle into U-NII-2A band)**

802.11a_Chain0 / CH48

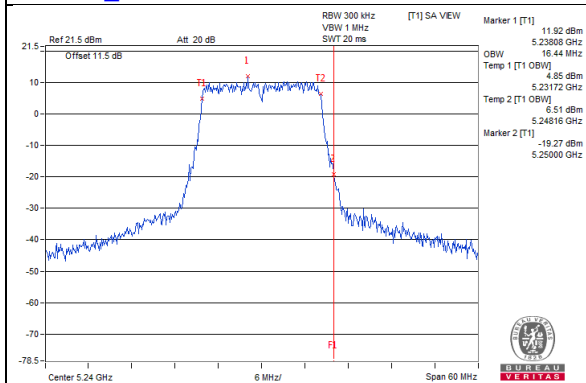

802.11a_Chain1 / CH48

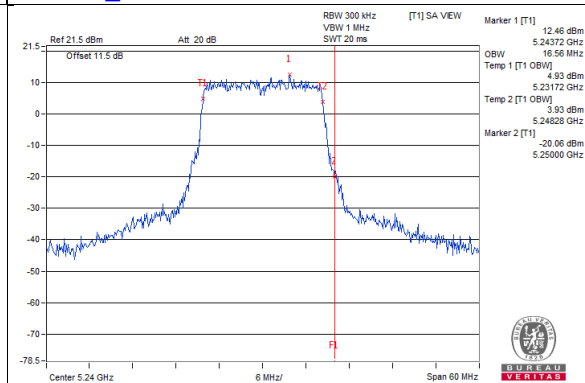

802.11ac(VHT20)_Chain0 / CH48

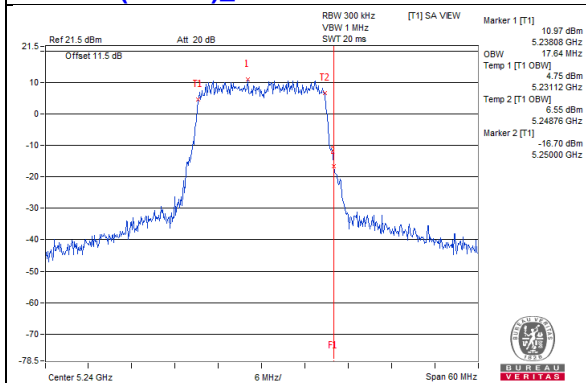

802.11ac(VHT20)_Chain1 / CH48

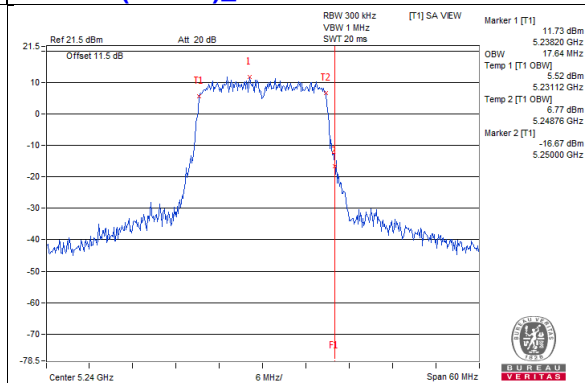

802.11ac(VHT40)_Chain0 / CH46

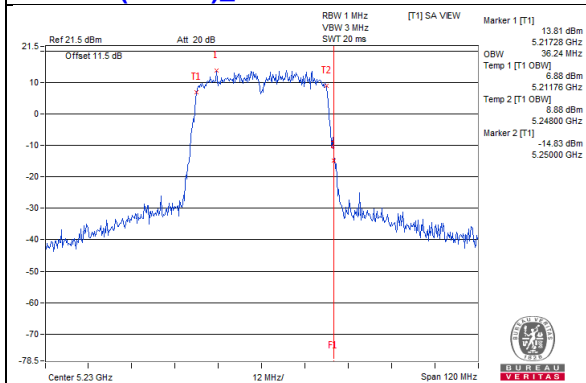

802.11ac(VHT40)_Chain1 / CH46

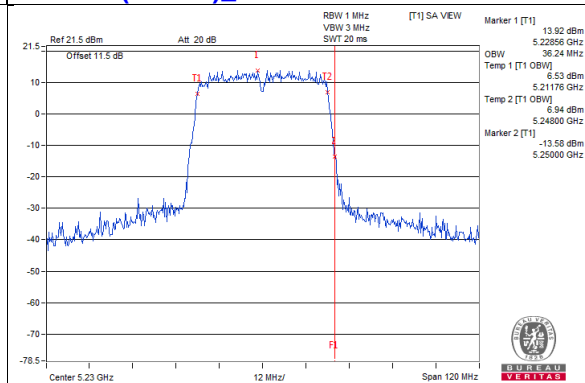

802.11ac(VHT80)_Chain0 / CH42

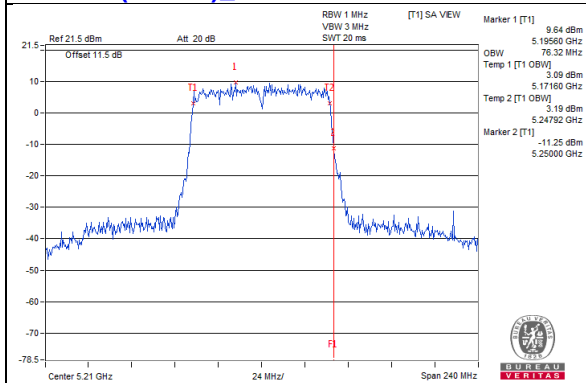

802.11ac(VHT80)_Chain1 / CH42

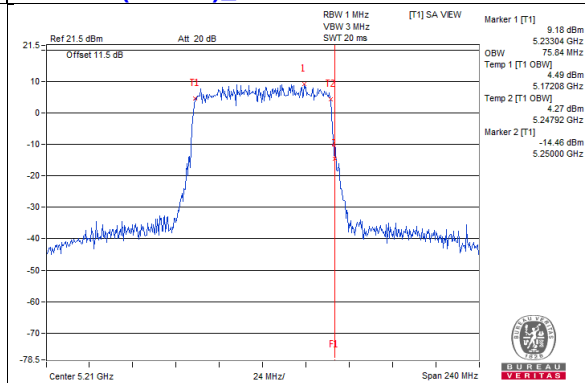

Spectrum Plot for near by DFS band (DFS is required, if 99% OCP straddle into U-NII-2C band)

802.11a_Chain0 / CH149

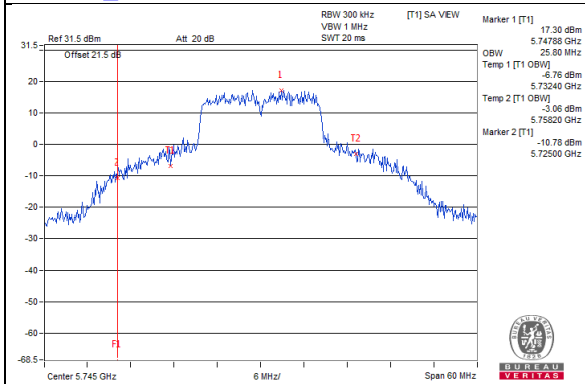

802.11a_Chain1 / CH149

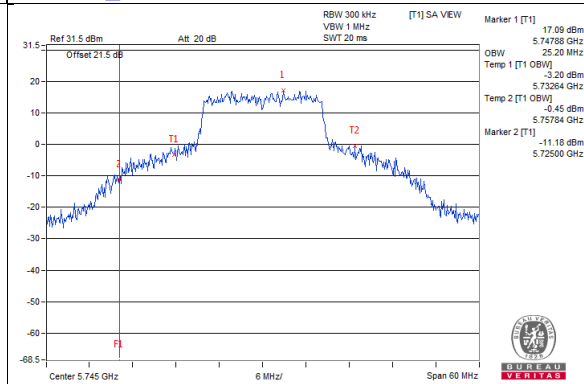

802.11ac(VHT20)_Chain0 / CH149

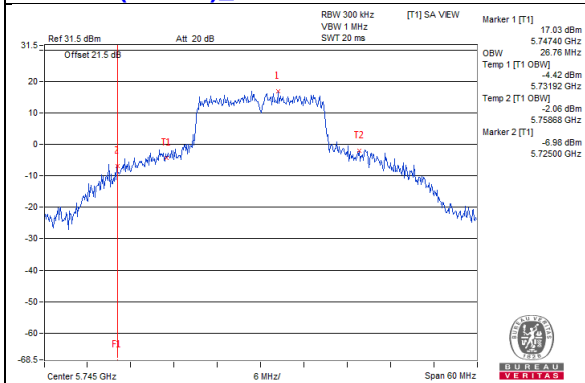

802.11ac(VHT20)_Chain1 / CH149

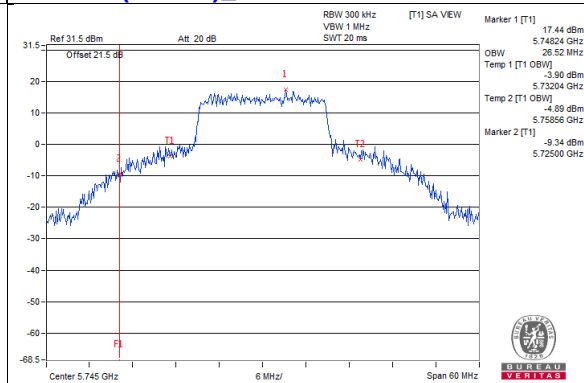

802.11ac(VHT40)_Chain0 / CH151

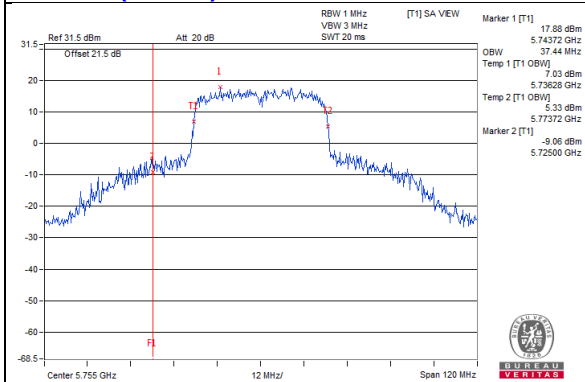

802.11ac(VHT40)_Chain1 / CH151

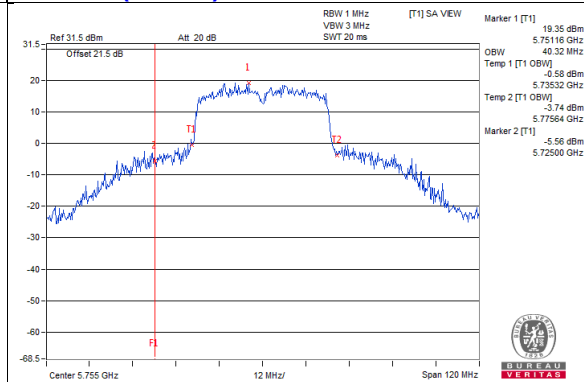

802.11ac(VHT80)_Chain0 / CH155

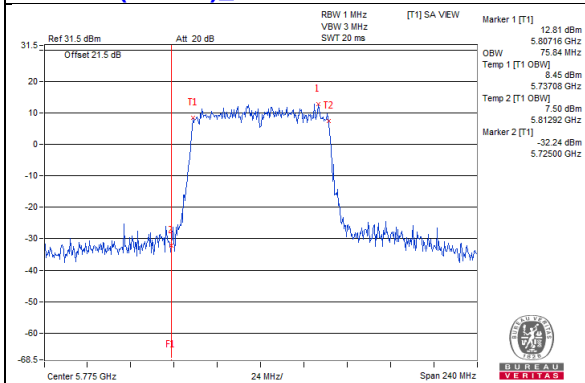

802.11ac(VHT80)_Chain1 / CH155

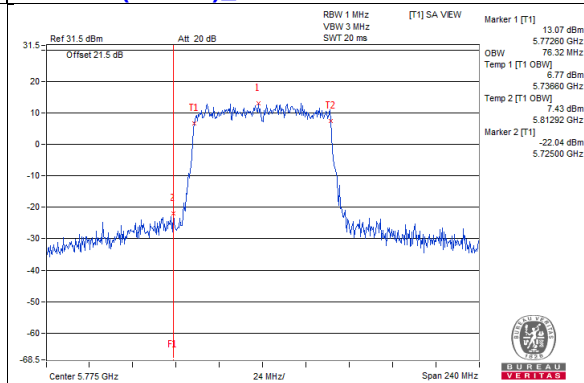

4.5 Peak Power Spectral Density Measurement

4.5.1 Limits of Peak Power Spectral Density Measurement

Operation Band	EUT Category		Limit
U-NII-1	√	Outdoor Access Point	17dBm/ MHz
		Fixed point-to-point Access Point	
		Indoor Access Point	
	√	Client device	11dBm/ MHz
U-NII-2A			11dBm/ MHz
U-NII-2C			11dBm/ MHz
U-NII-3		√	30dBm/ 500kHz

4.5.2 Test Setup



4.5.3 Test Instruments

Refer to section 4.1.2 to get information of above instrument.

4.5.4 Test Procedure

802.11a, 802.11ac (VHT40), 802.11ac (VHT80)

For U-NII-1:

Using method SA-2

1. Set span to encompass the entire emission bandwidth (EBW) of the signal.
2. Set RBW = 1 MHz, Set VBW \geq 3 MHz, Detector = RMS
3. Sweep time = auto, trigger set to "free run".
4. Trace average at least 100 traces in power averaging mode.
5. Record the max value and add 10 log (1/duty cycle)

For U-NII-3:

1. Set span to encompass the entire emission bandwidth (EBW) of the signal.
2. Set RBW = 300 kHz, Set VBW \geq 1 MHz, Detector = RMS
3. Use the peak marker function to determine the maximum power level in any 300 kHz band segment within the fundamental EBW.
4. Scale the observed power level to an equivalent value in 500 kHz by adjusting (reducing) the measured power by a bandwidth correction factor (BWCF) where $BWCF = 10\log(500 \text{ kHz}/300\text{kHz})$
5. Sweep time = auto, trigger set to "free run".
6. Trace average at least 100 traces in power averaging mode.
7. Record the max value and add 10 log (1/duty cycle)

802.11ac (VHT20)

For U-NII-1:

Using method SA-1

1. Set span to encompass the entire emission bandwidth (EBW) of the signal.
2. Set RBW = 1 MHz, Set VBW \geq 3 MHz, Detector = RMS
3. Sweep time = auto, trigger set to "free run".
4. Trace average at least 100 traces in power averaging mode.
5. Record the max value

For U-NII-3:

1. Set span to encompass the entire emission bandwidth (EBW) of the signal.
2. Set RBW = 300 kHz, Set VBW \geq 1 MHz, Detector = RMS
3. Use the peak marker function to determine the maximum power level in any 300 kHz band segment within the fundamental EBW.
4. Scale the observed power level to an equivalent value in 500 kHz by adjusting (reducing) the measured power by a bandwidth correction factor (BWCF) where $BWCF = 10\log(500 \text{ kHz}/300\text{kHz})$
5. Sweep time = auto, trigger set to "free run".
6. Trace average at least 100 traces in power averaging mode.
7. Record the max value

4.5.5 Deviation from Test Standard

No deviation.

4.5.6 EUT Operating Condition

Same as Item 4.3.6.

4.5.7 Test Results

For U-NII-1:

Master Mode

802.11a

Chan.	Chan. Freq. (MHz)	PSD W/O Duty Factor (dBm)		Duty Factor (dB)	Total PSD With Duty Factor (dBm)	MAX. Limit (dBm)	Pass / Fail
		Chain 0	Chain 1				
36	5180	6.62	6.60	0.19	9.81	13.07	Pass
40	5200	5.67	6.80	0.19	9.47	13.07	Pass
48	5240	6.74	7.29	0.19	10.22	13.07	Pass

- Note:**
- Method a) of power density measurement of KDB 662911 is using for calculating total power density. Total power density is summing entire spectra across corresponding frequency bins on the various outputs by computer.
 - Directional gain = $6.92\text{dBi} + 10 \log(2) = 9.93\text{dBi} > 6\text{dBi}$, so the power density limit shall be reduced $17-(9.93-6)=13.07$.
 - Refer to section 3.3 for duty cycle spectrum plot.

802.11ac (VHT20)

Chan.	Chan. Freq. (MHz)	PSD (dBm)		Total Power Density (dBm)	MAX. Limit (dBm)	Pass / Fail
		Chain 0	Chain 1			
36	5180	6.17	6.20	9.20	13.07	Pass
40	5200	6.43	6.52	9.49	13.07	Pass
48	5240	6.40	7.05	9.75	13.07	Pass

- Note:**
- Method a) of power density measurement of KDB 662911 is using for calculating total power density. Total power density is summing entire spectra across corresponding frequency bins on the various outputs by computer.
 - Directional gain = $6.92\text{dBi} + 10 \log(2) = 9.93\text{dBi} > 6\text{dBi}$, so the power density limit shall be reduced $17-(9.93-6)=13.07$.

802.11ac (VHT40)

Chan.	Chan. Freq. (MHz)	PSD W/O Duty Factor (dBm)		Duty Factor (dB)	Total PSD With Duty Factor (dBm)	MAX. Limit (dBm)	Pass / Fail
		Chain 0	Chain 1				
38	5190	3.33	3.86	0.18	6.79	13.07	Pass
46	5230	3.66	4.38	0.18	7.22	13.07	Pass

- Note:**
- Method a) of power density measurement of KDB 662911 is using for calculating total power density. Total power density is summing entire spectra across corresponding frequency bins on the various outputs by computer.
 - Directional gain = $6.92\text{dBi} + 10 \log(2) = 9.93\text{dBi} > 6\text{dBi}$, so the power density limit shall be reduced $17-(9.93-6)=13.07$.
 - Refer to section 3.3 for duty cycle spectrum plot.

802.11ac (VHT80)

Chan.	Chan. Freq. (MHz)	PSD W/O Duty Factor (dBm)		Duty Factor (dB)	Total PSD With Duty Factor (dBm)	MAX. Limit (dBm)	Pass / Fail
		Chain 0	Chain 1				
42	5210	-0.47	-1.31	0.30	2.44	13.07	Pass

- Note:**
- Method a) of power density measurement of KDB 662911 is using for calculating total power density. Total power density is summing entire spectra across corresponding frequency bins on the various outputs by computer.
 - Directional gain = $6.92\text{dBi} + 10 \log(2) = 9.93\text{dBi} > 6\text{dBi}$, so the power density limit shall be reduced $17-(9.93-6)=13.07$.
 - Refer to section 3.3 for duty cycle spectrum plot.

Spectrum Plot of Worst Value

802.11a_Chain 1 / CH48

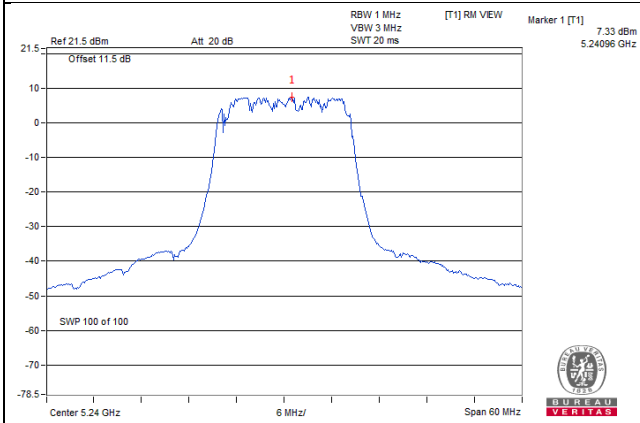

802.11ac (VHT20)_Chain 1 / CH48

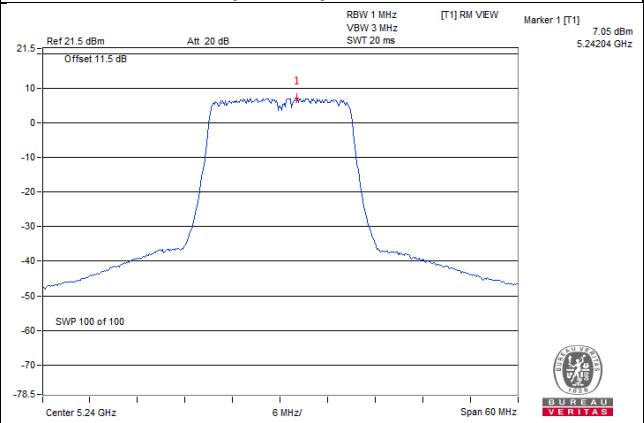

802.11ac (VHT40)_Chain 1 / CH46

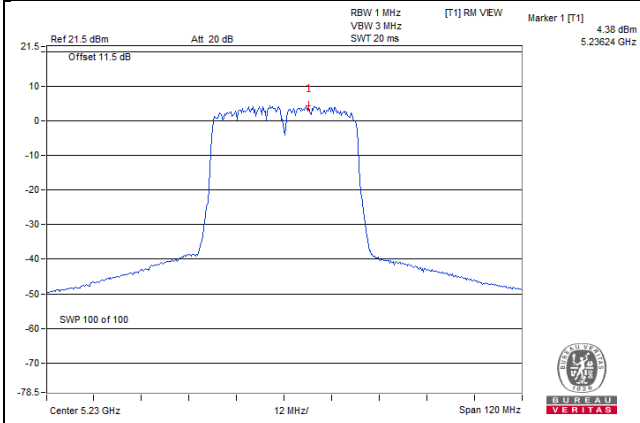

802.11ac (VHT80)_Chain 0 / CH42

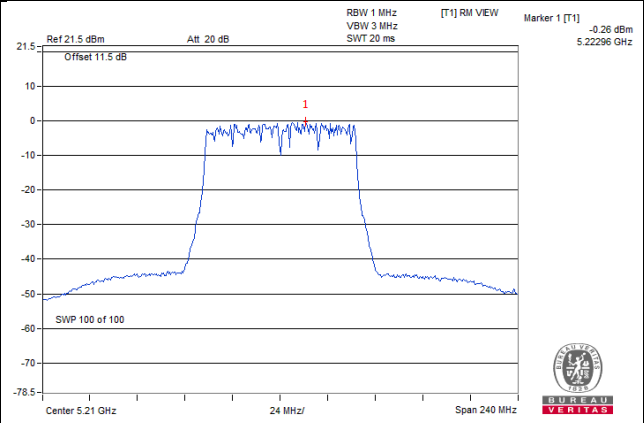

Client Mode
802.11a

Chan.	Chan. Freq. (MHz)	PSD W/O Duty Factor (dBm)		Duty Factor (dB)	Total PSD With Duty Factor (dBm)	MAX. Limit (dBm)	Pass / Fail
		Chain 0	Chain 1				
36	5180	3.67	3.55	0.19	6.81	7.07	Pass
40	5200	3.44	3.94	0.19	6.89	7.07	Pass
48	5240	3.54	3.83	0.19	6.88	7.07	Pass

- Note:**
- Method a) of power density measurement of KDB 662911 is using for calculating total power density. Total power density is summing entire spectra across corresponding frequency bins on the various outputs by computer.
 - Directional gain = $6.92\text{dBi} + 10 \log(2) = 9.93\text{dBi} > 6\text{dBi}$, so the power density limit shall be reduced $11-(9.93-6)=7.07$.
 - Refer to section 3.3 for duty cycle spectrum plot.

802.11ac (VHT20)

Chan.	Chan. Freq. (MHz)	PSD (dBm)		Total Power Density (dBm)	MAX. Limit (dBm)	Pass / Fail
		Chain 0	Chain 1			
36	5180	3.11	3.71	6.43	7.07	Pass
40	5200	3.35	3.44	6.41	7.07	Pass
48	5240	3.86	3.89	6.89	7.07	Pass

- Note:**
- Method a) of power density measurement of KDB 662911 is using for calculating total power density. Total power density is summing entire spectra across corresponding frequency bins on the various outputs by computer.
 - Directional gain = $6.92\text{dBi} + 10 \log(2) = 9.93\text{dBi} > 6\text{dBi}$, so the power density limit shall be reduced $11-(9.93-6)=7.07$.

802.11ac (VHT40)

Chan.	Chan. Freq. (MHz)	PSD W/O Duty Factor (dBm)		Duty Factor (dB)	Total PSD With Duty Factor (dBm)	MAX. Limit (dBm)	Pass / Fail
		Chain 0	Chain 1				
38	5190	3.33	3.86	0.18	6.79	7.07	Pass
46	5230	3.66	3.53	0.18	6.78	7.07	Pass

- Note:**
- Method a) of power density measurement of KDB 662911 is using for calculating total power density. Total power density is summing entire spectra across corresponding frequency bins on the various outputs by computer.
 - Directional gain = $6.92\text{dBi} + 10 \log(2) = 9.93\text{dBi} > 6\text{dBi}$, so the power density limit shall be reduced $11-(9.93-6)=7.07$.
 - Refer to section 3.3 for duty cycle spectrum plot.

802.11ac (VHT80)

Chan.	Chan. Freq. (MHz)	PSD W/O Duty Factor (dBm)		Duty Factor (dB)	Total PSD With Duty Factor (dBm)	MAX. Limit (dBm)	Pass / Fail
		Chain 0	Chain 1				
42	5210	-0.47	-1.31	0.30	2.44	7.07	Pass

- Note:**
- Method a) of power density measurement of KDB 662911 is using for calculating total power density. Total power density is summing entire spectra across corresponding frequency bins on the various outputs by computer.
 - Directional gain = $6.92\text{dBi} + 10 \log(2) = 9.93\text{dBi} > 6\text{dBi}$, so the power density limit shall be reduced $11-(9.93-6)=7.07$.
 - Refer to section 3.3 for duty cycle spectrum plot.

Spectrum Plot of Worst Value

802.11a_Chain 1 / CH40

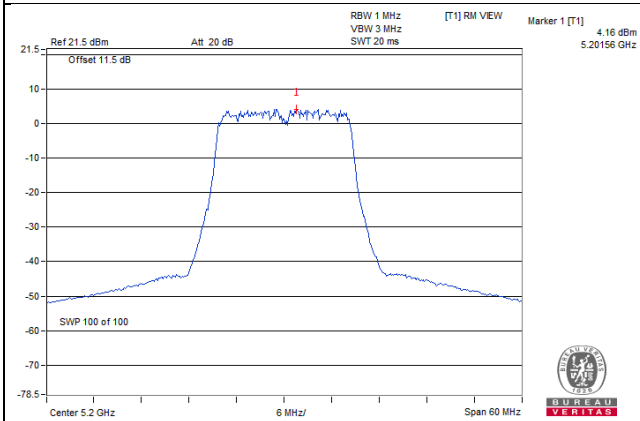

802.11ac (VHT20)_Chain 1 / CH48

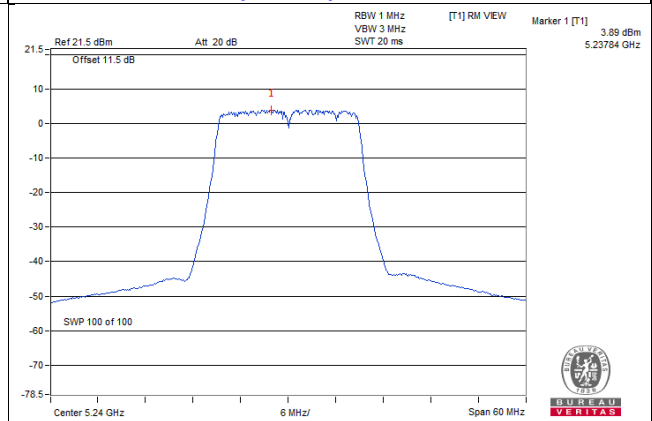

802.11ac (VHT40)_Chain 1 / CH38

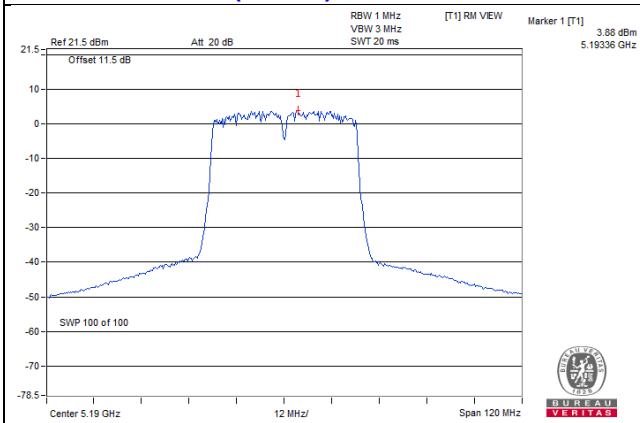

802.11ac (VHT80)_Chain 0 / CH42

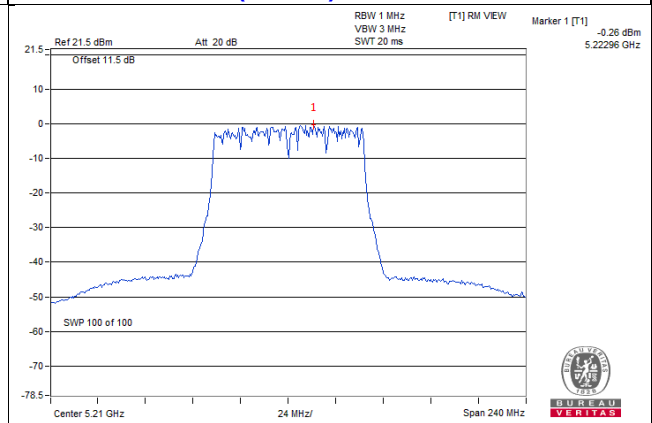

For U-NII-3:

802.11a

TX chain	Chan.	Chan. Freq. (MHz)	PSD W/O Duty Factor		10 log (N=2) dB	Duty Factor (dB)	Total PSD With Duty Factor (dBm/500kHz)	Limit (dBm/500kHz)	Pass /Fail
			(dBm/300kHz)	(dBm/500kHz)					
0	149	5745	4.30	6.52	3.01	0.19	9.72	26.07	Pass
	157	5785	3.79	6.01	3.01	0.19	9.21	26.07	Pass
	165	5825	3.60	5.82	3.01	0.19	9.02	26.07	Pass
1	149	5745	4.51	6.73	3.01	0.19	9.93	26.07	Pass
	157	5785	4.19	6.41	3.01	0.19	9.61	26.07	Pass
	165	5825	3.58	5.80	3.01	0.19	9.00	26.07	Pass

Note: 1. Directional gain = $6.92\text{dBi} + 10 \log(2) = 9.93\text{dBi} > 6\text{dBi}$, so the power density limit shall be reduced $30-(9.93-6)=26.07$.

2. Refer to section 3.3 for duty cycle spectrum plot.

802.11ac (VHT20)

TX chain	Channel	Freq. (MHz)	PSD (dBm/300kHz)	PSD (dBm/500kHz)	10 log (N=2) dB	Total PSD (dBm/500kHz)	Limit (dBm/500kHz)	Pass /Fail
0	149	5745	3.86	6.08	3.01	9.09	26.07	Pass
	157	5785	3.74	5.96	3.01	8.97	26.07	Pass
	165	5825	3.39	5.61	3.01	8.62	26.07	Pass
1	149	5745	4.06	6.28	3.01	9.29	26.07	Pass
	157	5785	4.02	6.24	3.01	9.25	26.07	Pass
	165	5825	3.76	5.98	3.01	8.99	26.07	Pass

Note: 1. Directional gain = $6.92\text{dBi} + 10 \log(2) = 9.93\text{dBi} > 6\text{dBi}$, so the power density limit shall be reduced $30-(9.93-6)=26.07$.

802.11ac (VHT40)

TX chain	Chan.	Chan. Freq. (MHz)	PSD W/O Duty Factor		10 log (N=2) dB	Duty Factor (dB)	Total PSD With Duty Factor (dBm/500kHz)	Limit (dBm/500kHz)	Pass /Fail
			(dBm/300kHz)	(dBm/500kHz)					
0	151	5755	-0.75	1.47	3.01	0.18	4.66	26.07	Pass
	159	5795	-0.50	1.72	3.01	0.18	4.91	26.07	Pass
1	151	5755	0.67	2.89	3.01	0.18	6.08	26.07	Pass
	159	5795	-0.14	2.08	3.01	0.18	5.27	26.07	Pass

Note: 1. Directional gain = $6.92\text{dBi} + 10 \log(2) = 9.93\text{dBi} > 6\text{dBi}$, so the power density limit shall be reduced $30-(9.93-6)=26.07$.

2. Refer to section 3.3 for duty cycle spectrum plot.

802.11ac (VHT80)

TX chain	Chan.	Chan. Freq. (MHz)	PSD W/O Duty Factor		10 log (N=2) dB	Duty Factor (dB)	Total PSD With Duty Factor (dBm/500kHz)	Limit (dBm/500kHz)	Pass /Fail
			(dBm/300kHz)	(dBm/500kHz)					
0	155	5775	-6.58	-4.36	3.01	0.30	-1.05	26.07	Pass
1	155	5775	-5.69	-3.47	3.01	0.30	-0.16	26.07	Pass

Note: 1. Directional gain = $6.92\text{dBi} + 10 \log(2) = 9.93\text{dBi} > 6\text{dBi}$, so the power density limit shall be reduced $30-(9.93-6)=26.07$.

2. Refer to section 3.3 for duty cycle spectrum plot.

Spectrum Plot of Worst Value

802.11a_Chain 1 / CH149

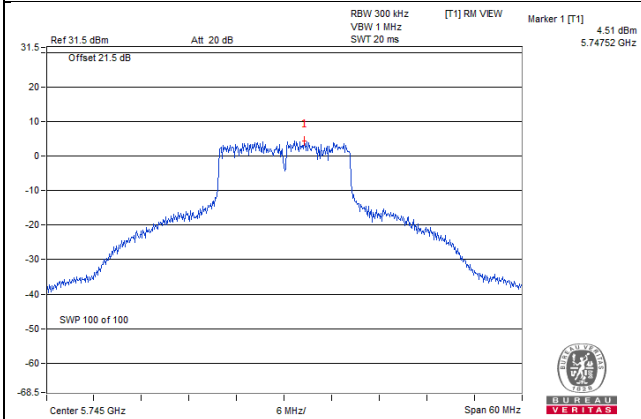

802.11ac (VHT20)_Chain 1 / CH149

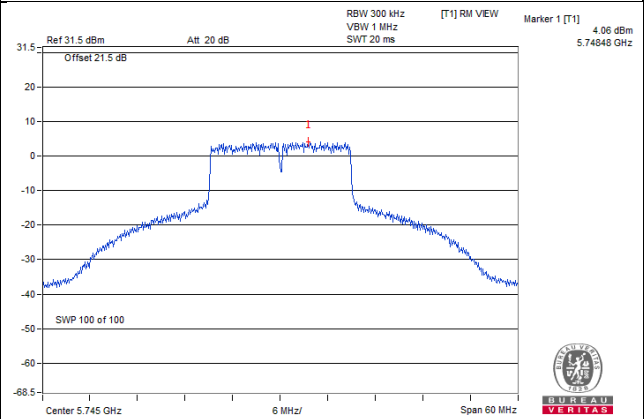

802.11ac (VHT40)_Chain 1 / CH151

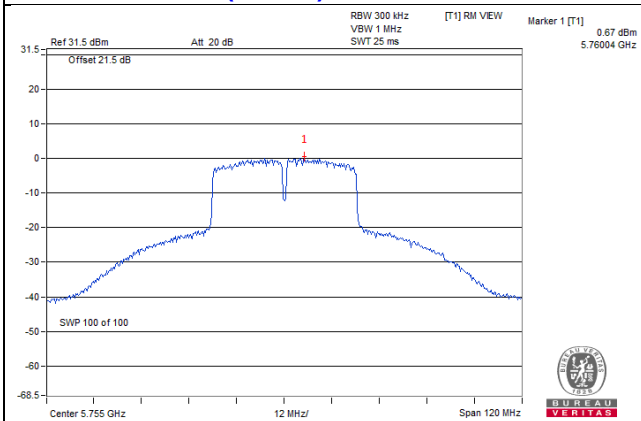

802.11ac (VHT80)_Chain 1 / CH155

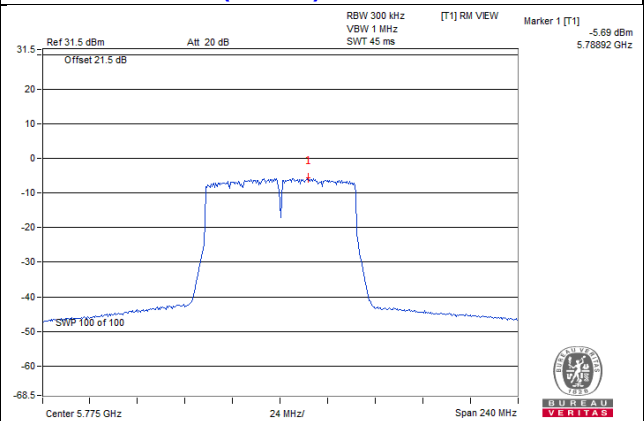

4.6 Frequency Stability Measurement

4.6.1 Limits of Frequency Stability Measurement

The frequency of the carrier signal shall be maintained within band of operation

4.6.2 Test Setup

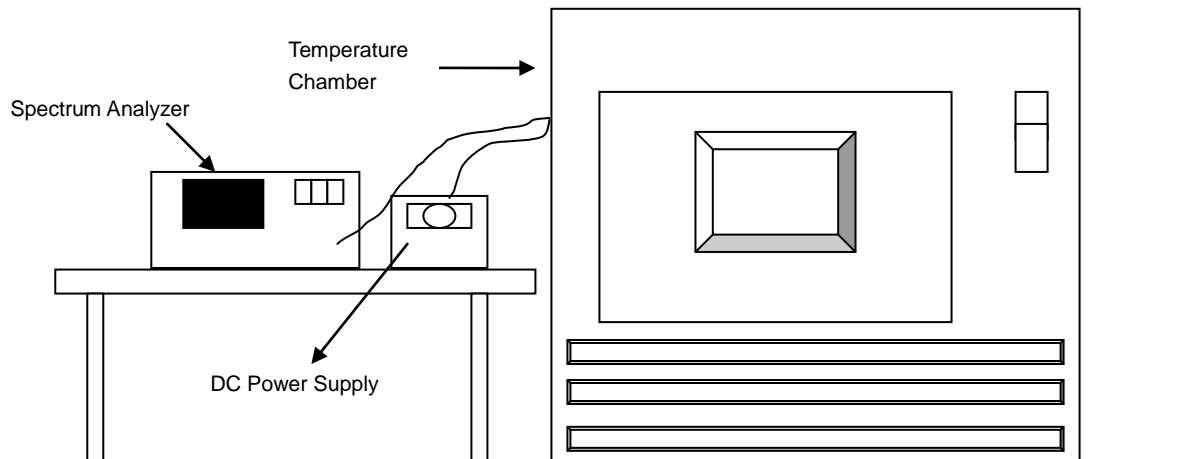

4.6.3 Test Instruments

Refer to section 4.1.2 to get information of above instrument.

4.6.4 Test Procedure

- The EUT was placed inside the environmental test chamber and powered by nominal DC voltage.
- Turn the EUT on and couple its output to a spectrum analyzer.
- Turn the EUT off and set the chamber to the highest temperature specified.
- Allow sufficient time (approximately 30 min) for the temperature of the chamber to stabilize, turn the EUT on and measure the operating frequency after 2, 5, and 10 Minutes.
- Repeat step 2 and 3 with the temperature chamber set to the lowest temperature.
- The test chamber was allowed to stabilize at +20 degree C for a minimum of 30 Minutes. The supply voltage was then adjusted on the EUT from 85% to 115% and the frequency record.

4.6.5 Deviation from Test Standard

No deviation.

4.6.6 EUT Operating Condition

Set the EUT transmit at un-modulation mode to test frequency stability.

4.6.7 Test Results

Frequency Stability Versus Temp.									
Operating Frequency: 5180 MHz									
TEMP. (°C)	Power Supply (Vdc)	0 Minute		2 Minutes		5 Minutes		10 Minutes	
		Measured Frequency (MHz)	Pass/Fail	Measured Frequency (MHz)	Pass/Fail	Measured Frequency (MHz)	Pass/Fail	Measured Frequency (MHz)	Pass/Fail
50	48	5179.9817	PASS	5179.9776	PASS	5179.9806	PASS	5179.982	PASS
40	48	5180.0234	PASS	5180.0219	PASS	5180.022	PASS	5180.0239	PASS
30	48	5179.9868	PASS	5179.9879	PASS	5179.988	PASS	5179.9838	PASS
20	48	5179.984	PASS	5179.9846	PASS	5179.9846	PASS	5179.9871	PASS
10	48	5180.0078	PASS	5180.0064	PASS	5180.0095	PASS	5180.0073	PASS
0	48	5179.9948	PASS	5179.995	PASS	5179.9924	PASS	5179.9911	PASS
-10	48	5179.9906	PASS	5179.9875	PASS	5179.9919	PASS	5179.989	PASS
-20	48	5180.0007	PASS	5180.0016	PASS	5179.999	PASS	5179.9987	PASS
-30	48	5180.0031	PASS	5180.003	PASS	5180.0072	PASS	5180.0075	PASS

Frequency Stability Versus Voltage									
Operating Frequency: 5180 MHz									
TEMP. (°C)	Power Supply (Vdc)	0 Minute		2 Minutes		5 Minutes		10 Minutes	
		Measured Frequency (MHz)	Pass/Fail	Measured Frequency (MHz)	Pass/Fail	Measured Frequency (MHz)	Pass/Fail	Measured Frequency (MHz)	Pass/Fail
20	55.2	5179.9835	PASS	5179.9855	PASS	5179.9842	PASS	5179.9862	PASS
	48	5179.984	PASS	5179.9846	PASS	5179.9846	PASS	5179.9871	PASS
	40.8	5179.984	PASS	5179.9837	PASS	5179.9856	PASS	5179.9879	PASS

4.7 6dB Bandwidth Measurement

4.7.1 Limits of 6dB Bandwidth Measurement

The minimum of 6dB Bandwidth Measurement is 0.5MHz.

4.7.2 Test Setup

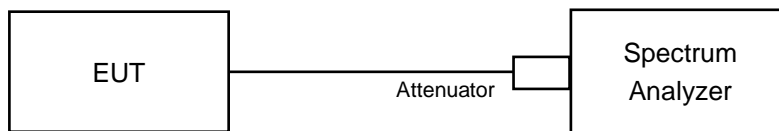

4.7.3 Test Instruments

Refer to section 4.1.2 to get information of above instrument.

4.7.4 Test Procedure

MEASUREMENT PROCEDURE REF

- a. Set resolution bandwidth (RBW) = 100kHz
- b. Set the video bandwidth (VBW) $\geq 3 \times$ RBW, Detector = Peak.
- c. Trace mode = max hold.
- d. Sweep = auto couple.
- e. Measure the maximum width of the emission that is constrained by the frequencies associated with the two amplitude points (upper and lower) that are attenuated by 6 dB relative to the maximum level measured in the fundamental emission

4.7.5 Deviation from Test Standard

No deviation.

4.7.6 EUT Operating Condition

The software provided by client to enable the EUT under transmission condition continuously at lowest, middle and highest channel frequencies individually.

4.7.7 Test Results

802.11a

Channel	Frequency (MHz)	6dB Bandwidth (MHz)		Minimum Limit (MHz)	Pass / Fail
		Chain 0	Chain 1		
149	5745	16.40	16.39	0.5	PASS
157	5785	16.37	16.36	0.5	PASS
165	5825	16.37	16.38	0.5	PASS

802.11ac (VHT20)

Channel	Frequency (MHz)	6dB Bandwidth (MHz)		Minimum Limit (MHz)	Pass / Fail
		Chain 0	Chain 1		
149	5745	17.63	17.64	0.5	PASS
157	5785	17.64	17.63	0.5	PASS
165	5825	17.60	17.37	0.5	PASS

802.11ac (VHT40)

Channel	Frequency (MHz)	6dB Bandwidth (MHz)		Minimum Limit (MHz)	Pass / Fail
		Chain 0	Chain 1		
151	5755	35.54	35.27	0.5	PASS
159	5795	35.71	35.32	0.5	PASS

802.11ac (VHT80)

Channel	Frequency (MHz)	6dB Bandwidth (MHz)		Minimum Limit (MHz)	Pass / Fail
		Chain 0	Chain 1		
155	5775	75.96	75.47	0.5	PASS

Spectrum Plot of Worst Value

802.11a_Chain 1 / CH157

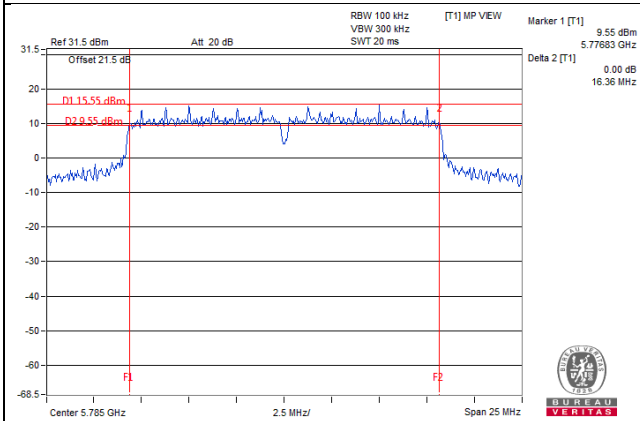

802.11ac (VHT20)_Chain 1 / CH155

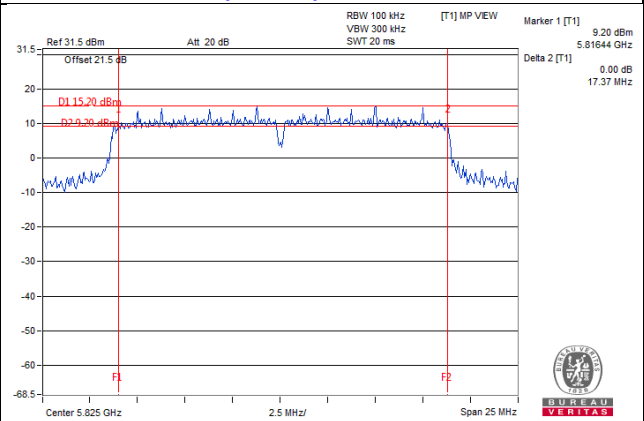

802.11ac (VHT40)_Chain 1 / CH151

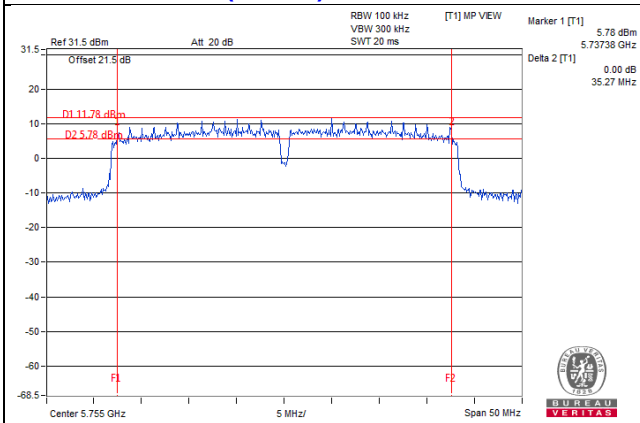

802.11ac (VHT80)_Chain 1 / CH155

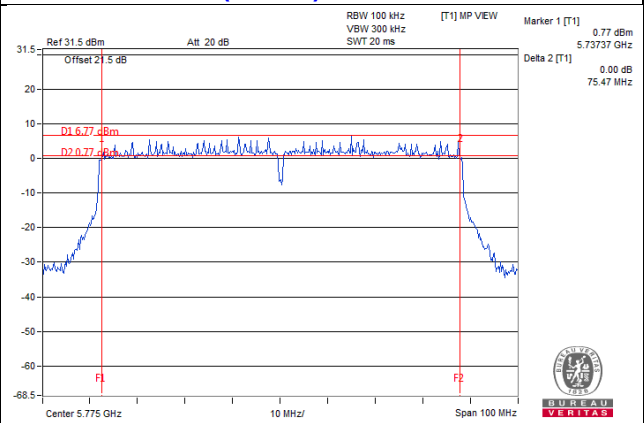

5 Pictures of Test Arrangements

Please refer to the attached file (Test Setup Photo).

Annex A- Radiated Out of Band Emission (OOBE) Measurement (For U-NII-3 band)

802.11a

CH 149 5745 MHz

Horizontal

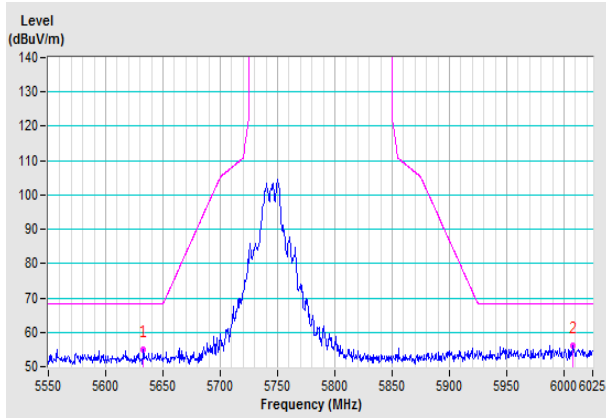

Vertical

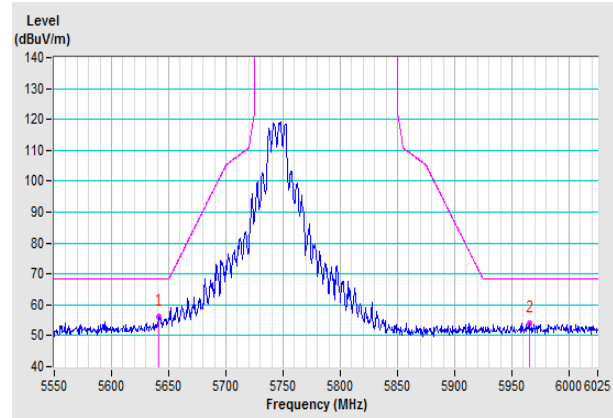

CH 157 5785 MHz

Horizontal

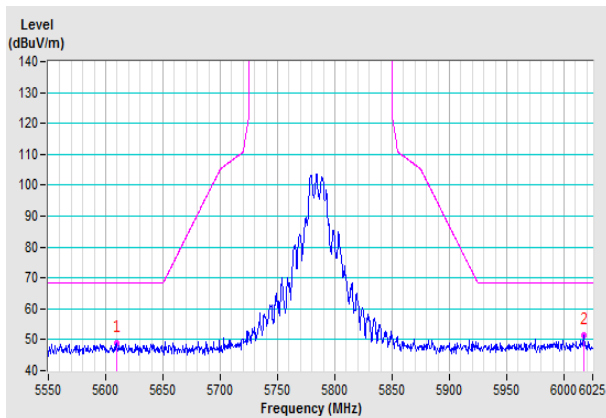

Vertical

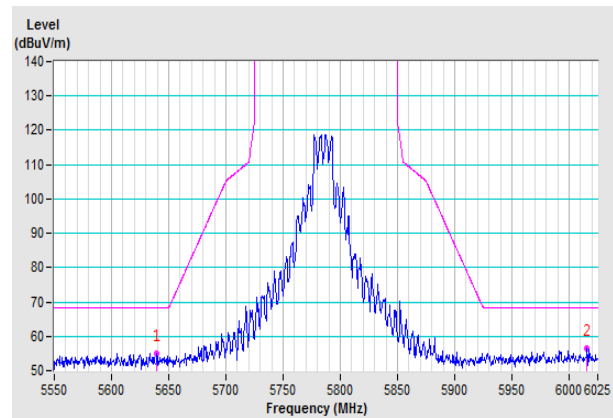

CH 165 5825 MHz

Horizontal

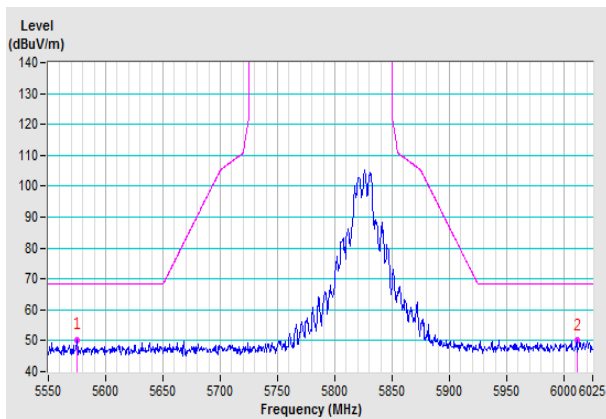

Vertical

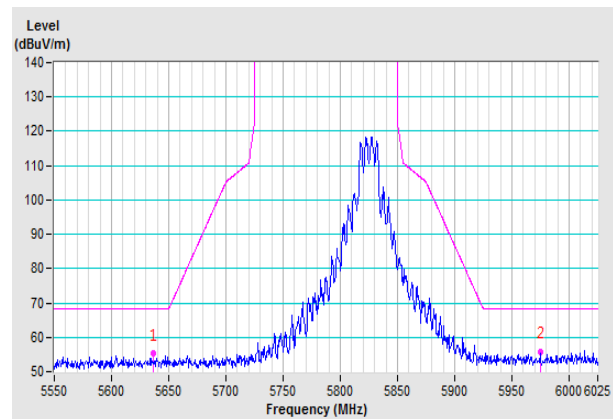

802.11ac (VHT20)

CH 149 5745 MHz

Horizontal

Vertical

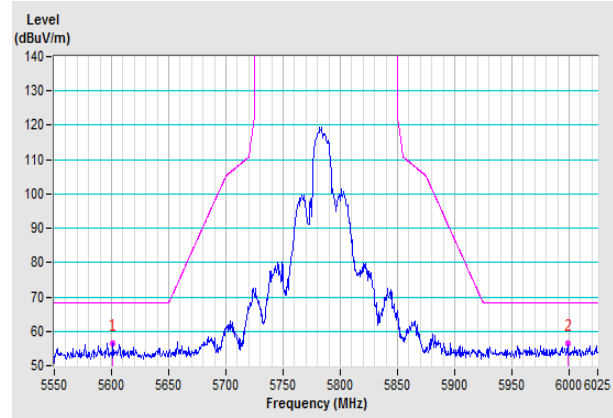
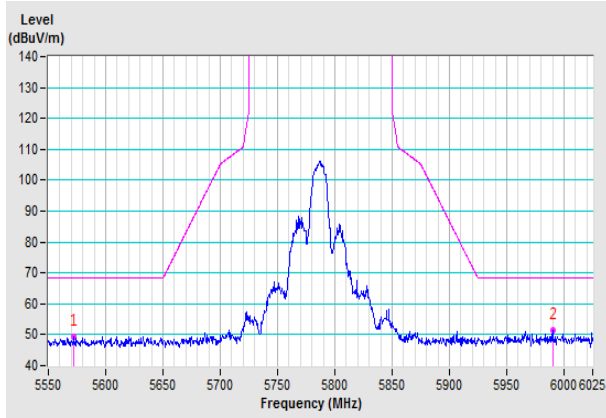

CH 157 5785 MHz

Horizontal

Vertical

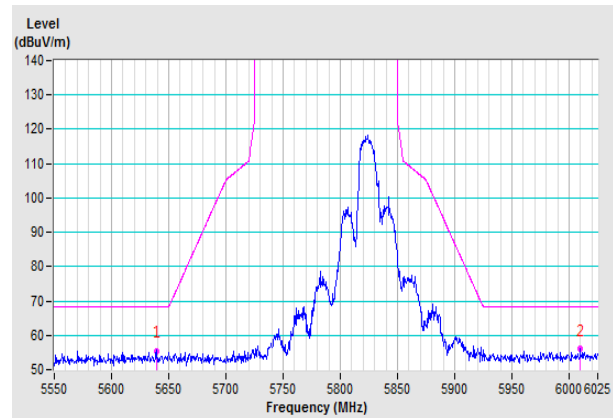
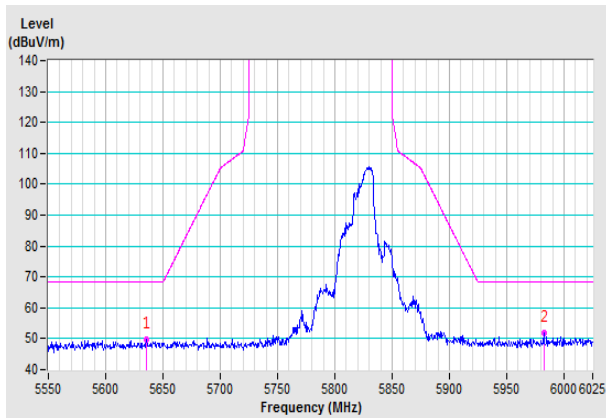

CH 165 5825 MHz

Horizontal

Vertical

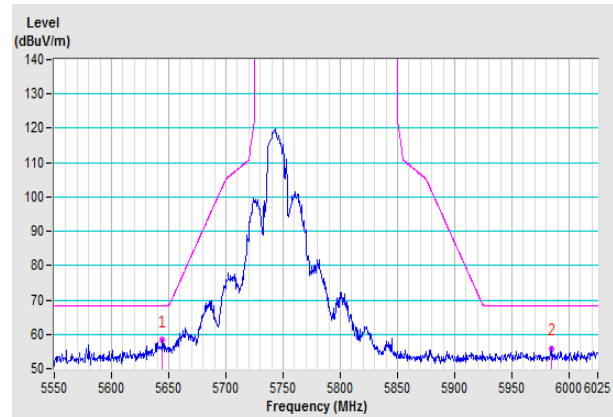
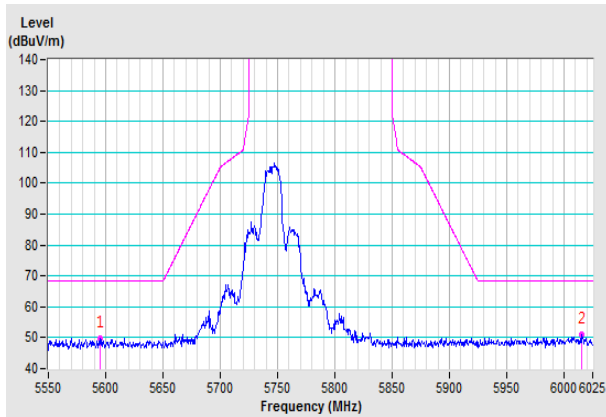

802.11ac (VHT40)

CH 151 5755 MHz

Horizontal

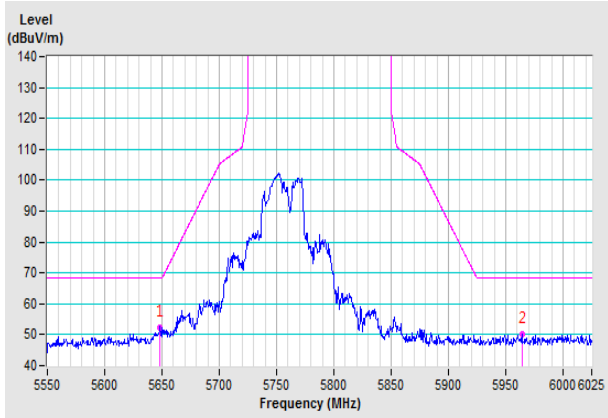

Vertical

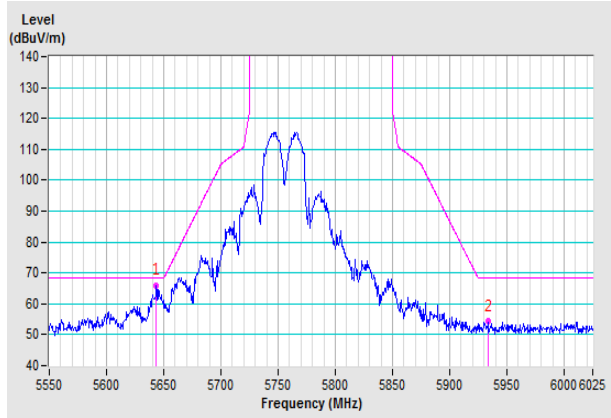

CH 159 5795 MHz

Horizontal

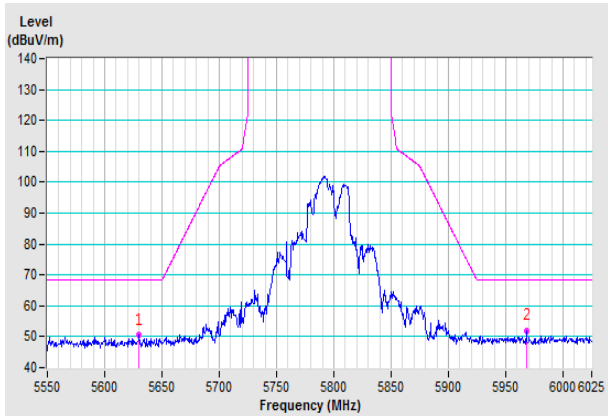

Vertical

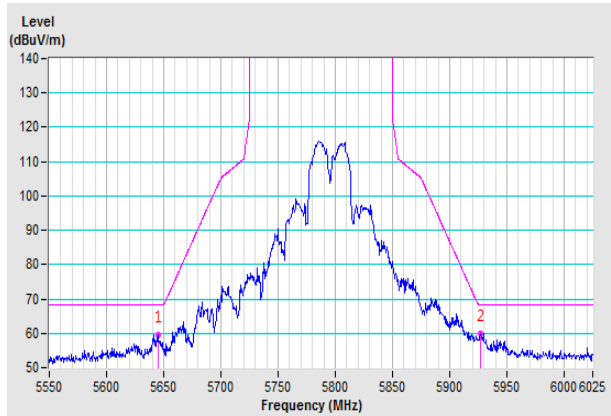

802.11ac (VHT80)

CH 155 5775 MHz

Horizontal

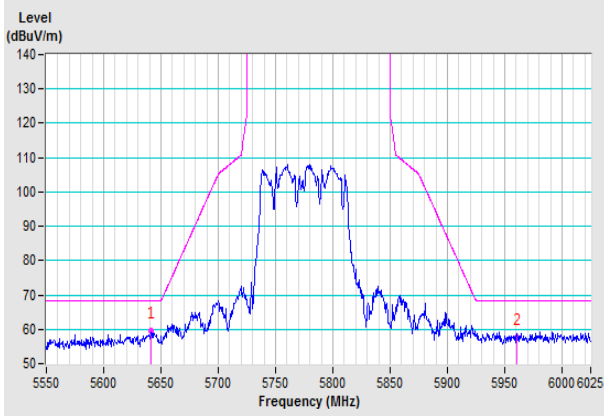

Vertical

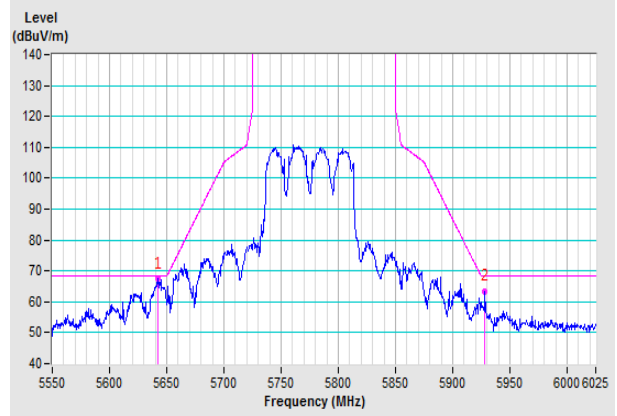

Appendix – Information on the Testing Laboratories

We, Bureau Veritas Consumer Products Services (H.K.) Ltd., Taoyuan Branch, were founded in 1988 to provide our best service in EMC, Radio, Telecom and Safety consultation. Our laboratories are FCC recognized accredited test firms and accredited according to ISO/IEC 17025.

If you have any comments, please feel free to contact us at the following:

Linko EMC/RF Lab

Tel: 886-2-26052180

Fax: 886-2-26051924

Hsin Chu EMC/RF/Telecom Lab

Tel: 886-3-6668565

Fax: 886-3-6668323

Hwa Ya EMC/RF/Safety Lab

Tel: 886-3-3183232

Fax: 886-3-3270892

Email: service.adt@tw.bureauveritas.com

Web Site: www.bureauveritas-adt.com

The address and road map of all our labs can be found in our web site also.

--- END ---