

## FCC Test Report

**Report No.:** RF171115C16

**FCC ID:** YZKECWO5210L

**Test Model:** ECWO5210-L

**Received Date:** Sep. 15, 2017

**Test Date:** Sep. 17, 2017 ~ Oct. 06, 2017

**Issued Date:** Nov. 16, 2017

**Applicant:** Edgecore Networks Corporation

**Address:** No. 1 Creation Rd. III, Hsinchu Science Park, Hsinchu 30077, Taiwan

**Issued By:** Bureau Veritas Consumer Products Services (H.K.) Ltd., Taoyuan Branch

**Lab Address:** No. 47-2, 14th Ling, Chia Pau Vil., Lin Kou Dist., New Taipei City, Taiwan  
( R.O.C )

**Test Location:** No. 19, Hwa Ya 2nd Rd, Wen Hwa Tsuen, Kwei Shan Hsiang, Taoyuan  
Hsien 333, Taiwan, R.O.C.

**FCC Registration /  
Designation Number:** 788550 / TW0003



This report is for your exclusive use. Any copying or replication of this report to or for any other person or entity, or use of our name or trademark, is permitted only with our prior written permission. This report sets forth our findings solely with respect to the test samples identified herein. The results set forth in this report are not indicative or representative of the quality or characteristics of the lot from which a test sample was taken or any similar or identical product unless specifically and expressly noted. Our report includes all of the tests requested by you and the results thereof based upon the information that you provided to us. You have 60 days from date of issuance of this report to notify us of any material error or omission caused by our negligence, provided, however, that such notice shall be in writing and shall specifically address the issue you wish to raise. A failure to raise such issue within the prescribed time shall constitute your unqualified acceptance of the completeness of this report, the tests conducted and the correctness of the report contents. Unless specific mention, the uncertainty of measurement has been explicitly taken into account to declare the compliance or non-compliance to the specification.

## Table of Contents

<b>Release Control Record</b> .....	<b>4</b>
<b>1 Certificate of Conformity</b> .....	<b>5</b>
<b>2 Summary of Test Results</b> .....	<b>6</b>
2.1 Measurement Uncertainty .....	6
2.2 Modification Record .....	6
<b>3 General Information</b> .....	<b>7</b>
3.1 General Description of EUT .....	7
3.2 Description of Test Modes .....	8
3.2.1 Test Mode Applicability and Tested Channel Detail .....	9
3.3 Duty Cycle of Test Signal .....	11
3.4 Description of Support Units .....	13
3.4.1 Configuration of System under Test .....	13
3.5 General Description of Applied Standards .....	13
<b>4 Test Types and Results</b> .....	<b>14</b>
4.1 Radiated Emission and Bandedge Measurement .....	14
4.1.1 Limits of Radiated Emission and Bandedge Measurement .....	14
4.1.2 Test Instruments .....	15
4.1.3 Test Procedures .....	17
4.1.4 Deviation from Test Standard .....	17
4.1.5 Test Set Up .....	18
4.1.6 EUT Operating Conditions .....	19
4.1.7 Test Results .....	20
4.2 Conducted Emission Measurement .....	33
4.2.1 Limits of Conducted Emission Measurement .....	33
4.2.2 Test Instruments .....	33
4.2.3 Test Procedures .....	34
4.2.4 Deviation from Test Standard .....	34
4.2.5 Test Setup .....	34
4.2.6 EUT Operating Conditions .....	34
4.2.7 Test Results .....	35
4.3 6 dB Bandwidth Measurement .....	37
4.3.1 Limits of 6 dB Bandwidth Measurement .....	37
4.3.2 Test Setup .....	37
4.3.3 Test Instruments .....	37
4.3.4 Test Procedure .....	37
4.3.5 Deviation from Test Standard .....	37
4.3.6 EUT Operating Conditions .....	37
4.3.7 Test Result .....	38
4.4 Occupied Bandwidth Measurement .....	41
4.4.1 Test Setup .....	41
4.4.2 Test Instruments .....	41
4.4.3 Test Procedure .....	41
4.4.4 Deviation from Test Standard .....	41
4.4.5 EUT Operating Conditions .....	41
4.4.6 Test Results .....	42
4.5 Conducted Output Power Measurement .....	45
4.5.1 Limits of Conducted Output Power Measurement .....	45
4.5.2 Test Setup .....	45
4.5.3 Test Instruments .....	45
4.5.4 Test Procedures .....	45
4.5.5 Deviation from Test Standard .....	45
4.5.6 EUT Operating Conditions .....	45
4.5.7 Test Results .....	46

4.6	Power Spectral Density Measurement .....	48
4.6.1	Limits of Power Spectral Density Measurement.....	48
4.6.2	Test Setup.....	48
4.6.3	Test Instruments .....	48
4.6.4	Test Procedure .....	48
4.6.5	Deviation from Test Standard .....	48
4.6.6	EUT Operating Condition .....	48
4.6.7	Test Results .....	49
4.7	Conducted Out of Band Emission Measurement .....	53
4.7.1	Limits of Conducted Out of Band Emission Measurement.....	53
4.7.2	Test Setup.....	53
4.7.3	Test Instruments .....	53
4.7.4	Test Procedure .....	53
4.7.5	Deviation from Test Standard .....	53
4.7.6	EUT Operating Condition .....	53
4.7.7	Test Results .....	54
<b>5</b>	<b>Pictures of Test Arrangements.....</b>	<b>82</b>
	<b>Appendix – Information on the Testing Laboratories .....</b>	<b>83</b>

### Release Control Record

Issue No.	Description	Date Issued
RF171115C16	Original Release	Nov. 16, 2017

## 1 Certificate of Conformity

**Product:** Access Point

**Brand:** Edgecore

**Test Model:** ECWO5210-L

**Sample Status:** Production Unit

**Applicant:** Edgecore Networks Corporation

**Test Date:** Sep. 17, 2017 ~ Oct. 06, 2017

**Standards:** 47 CFR FCC Part 15, Subpart C (Section 15.247)  
ANSI C63.10:2013

The above equipment has been tested by **Bureau Veritas Consumer Products Services (H.K.) Ltd., Taoyuan Branch**, and found compliance with the requirement of the above standards. The test record, data evaluation & Equipment Under Test (EUT) configurations represented herein are true and accurate accounts of the measurements of the sample's EMC characteristics under the conditions specified in this report.

**Prepared by :** Rona Chen, **Date:** Nov. 16, 2017  
Rona Chen / Specialist

**Approved by :** Dylan Chiou, **Date:** Nov. 16, 2017  
Dylan Chiou / Project Engineer

## 2 Summary of Test Results

47 CFR FCC Part 15, Subpart C (Section 15.247)			
FCC Clause	Test Item	Result	Remarks
15.207	AC Power Conducted Emission	Pass	Meet the requirement of limit. Minimum passing margin is -11.30 dB at 0.42600 MHz.
15.205 / 15.209 / 15.247(d)	Radiated Emissions and Band Edge Measurement	Pass	Meet the requirement of limit. Minimum passing margin is -1.52 dB at 2484 MHz.
15.247(d)	Antenna Port Emission	Pass	Meet the requirement of limit.
15.247(a)(2)	6 dB Bandwidth	Pass	Meet the requirement of limit.
---	Occupied Bandwidth Measurement	Pass	Reference only
15.247(b)	Conducted power	Pass	Meet the requirement of limit.
15.247(e)	Power Spectral Density	Pass	Meet the requirement of limit.
15.203	Antenna Requirement	Pass	Refer to section 3.1 Note 2 of this report.

### 2.1 Measurement Uncertainty

Where relevant, the following measurement uncertainty levels have been estimated for tests performed on the EUT:

The listed uncertainties are the worst case uncertainty for the entire range of measurement. Please note that the uncertainty values are provided for informational purposes only and are not used in determining the PASS/FAIL results.

Measurement	Frequency	Expanded Uncertainty (k=2) ( $\pm$ )
Conducted Emissions at mains ports	150 kHz ~ 30 MHz	2.44 dB
Radiated Emissions up to 1 GHz	30 MHz ~ 200 MHz	2.93 dB
	200 MHz ~ 1000 MHz	2.95 dB
Radiated Emissions above 1 GHz	1 GHz ~ 18 GHz	2.26 dB
	18 GHz ~ 40 GHz	1.94 dB

### 2.2 Modification Record

There were no modifications required for compliance.

### 3 General Information

#### 3.1 General Description of EUT

<b>Product</b>	Access Point
<b>Brand</b>	Edgecore
<b>Test Model</b>	ECWO5210-L
<b>Status of EUT</b>	Production Unit
<b>Power Supply Rating</b>	12.0Vdc (Adapter)
<b>Modulation Type</b>	CCK, DQPSK, DBPSK for DSSS 64QAM, 16QAM, QPSK, BPSK for OFDM
<b>Modulation Technology</b>	DSSS, OFDM
<b>Transfer Rate</b>	802.11b: 11.0 / 5.5 / 2.0 / 1.0 Mbps 802.11g: 54.0 / 48.0 / 36.0 / 24.0 / 18.0 / 12.0 / 9.0 / 6.0 Mbps 802.11n: up to MCS7
<b>Operating Frequency</b>	2412 ~ 2462 MHz
<b>Number of Channel</b>	11 for 802.11b, 802.11g, 802.11n (HT20) 7 for 802.11n (HT40)
<b>Output Power</b>	564.585mW
<b>Antenna Type</b>	Dipole antenna with 5.03 dBi gain
<b>Antenna Connector</b>	Refer to Note as below
<b>Accessory Device</b>	Refer to Note as below
<b>Data Cable Supplied</b>	Refer to Note as below

Note:

- The EUT incorporates a MIMO function. Physically, the EUT provides 3 completed transmitters and 3 receivers.

Modulation Mode	TX Function
802.11b	1TX
802.11g	1TX
802.11n (20MHz)	3TX
802.11n (40MHz)	3TX

- The EUT contains following accessory devices.

Product	Brand	Model	Description
Adapter	APD	WA-30B12	I/P: 100-240Vac, 0.8A O/P: 12Vdc, 2.5A
Antenna	Cortec	AN2450-5003BRS	--

- The above EUT information is declared by manufacturer and for more detailed features description, please refer to the manufacturer's specifications or user's manual.

### 3.2 Description of Test Modes

11 channels are provided for 802.11b, 802.11g and 802.11n (HT20):

Channel	Frequency (MHz)	Channel	Frequency (MHz)
1	2412	7	2442
2	2417	8	2447
3	2422	9	2452
4	2427	10	2457
5	2432	11	2462
6	2437		

7 channels are provided for 802.11n (HT40):

Channel	Frequency (MHz)	Channel	Frequency (MHz)
3	2422	7	2442
4	2427	8	2447
5	2432	9	2452
6	2437		



### 3.2.1 Test Mode Applicability and Tested Channel Detail

EUT Configure Mode	Applicable To				Description
	RE $\geq$ 1G	RE $<$ 1G	PLC	APCM	
-	√	√	√	√	-

Where **RE $\geq$ 1G**: Radiated Emission above 1 GHz      **RE $<$ 1G**: Radiated Emission below 1 GHz  
**PLC**: Power Line Conducted Emission      **APCM**: Antenna Port Conducted Measurement

**NOTE:** The EUT had been pre-tested on the positioned of each 3 axis. The worst case was found when positioned on **Z-plane**.

#### **Radiated Emission Test (Above 1 GHz):**

- Pre-Scan has been conducted to determine the worst-case mode from all possible combinations between available modulations, data rates and antenna ports (if EUT with antenna diversity architecture).
- Following channel(s) was (were) selected for the final test as listed below.

EUT Configure Mode	Mode	Available Channel	Tested Channel	Modulation Technology	Modulation Type	Data Rate (Mbps)
-	802.11b	1 to 11	1, 6, 11	DSSS	DBPSK	1.0
	802.11g	1 to 11	1, 6, 11	OFDM	BPSK	6.0
	802.11n (HT20)	1 to 11	1, 6, 11	OFDM	BPSK	MCS0
	802.11n (HT40)	3 to 9	3, 6, 9	OFDM	BPSK	MCS0

#### **Radiated Emission Test (Below 1 GHz):**

- Pre-Scan has been conducted to determine the worst-case mode from all possible combinations between available modulations, data rates and antenna ports (if EUT with antenna diversity architecture).
- Following channel(s) was (were) selected for the final test as listed below.

EUT Configure Mode	Mode	Available Channel	Tested Channel	Modulation Technology	Modulation Type	Data Rate (Mbps)
-	802.11n (HT40)	3 to 9	9	OFDM	BPSK	MCS0

#### **Power Line Conducted Emission Test:**

- Pre-Scan has been conducted to determine the worst-case mode from all possible combinations between available modulations, data rates and antenna ports (if EUT with antenna diversity architecture).
- Following channel(s) was (were) selected for the final test as listed below.

EUT Configure Mode	Mode	Available Channel	Tested Channel	Modulation Technology	Modulation Type	Data Rate (Mbps)
-	802.11n (HT40)	3 to 9	9	OFDM	BPSK	MCS0

**Bandedge Measurement:**

- Pre-Scan has been conducted to determine the worst-case mode from all possible combinations between available modulations, data rates and antenna ports (if EUT with antenna diversity architecture).
- Following channel(s) was (were) selected for the final test as listed below.

EUT Configure Mode	Mode	Available Channel	Tested Channel	Modulation Technology	Modulation Type	Data Rate (Mbps)
	802.11b	1 to 11	1, 11	DSSS	DBPSK	1.0
	802.11g	1 to 11	1, 11	OFDM	BPSK	6.0
	802.11n (HT20)	1 to 11	1, 11	OFDM	BPSK	MCS0
	802.11n (HT40)	3 to 9	3, 9	OFDM	BPSK	MCS0

**Antenna Port Conducted Measurement:**

- This item includes all test value of each mode, but only includes spectrum plot of worst value of each mode.
- Pre-Scan has been conducted to determine the worst-case mode from all possible combinations between available modulations, data rates and antenna ports (if EUT with antenna diversity architecture).
- Following channel(s) was (were) selected for the final test as listed below.

EUT Configure Mode	Mode	Available Channel	Tested Channel	Modulation Technology	Modulation Type	Data Rate (Mbps)
	802.11b	1 to 11	1, 6, 11	DSSS	DBPSK	1.0
	802.11g	1 to 11	1, 6, 11	OFDM	BPSK	6.0
	802.11n (HT20)	1 to 11	1, 6, 11	OFDM	BPSK	MCS0
	802.11n (HT40)	3 to 9	3, 6, 9	OFDM	BPSK	MCS0

**Test Condition:**

Applicable To	Environmental Conditions	Input Power	Tested by
RE $\geq$ 1G	25 deg. C, 65 % RH	120Vac, 60Hz	Karl Lee
RE<1G	25 deg. C, 65 % RH	120Vac, 60Hz	Karl Lee
PLC	25 deg. C, 65 % RH	120Vac, 60Hz	Anson Lin
APCM	25 deg. C, 65 % RH	12Vdc	Wayne Lin

### 3.3 Duty Cycle of Test Signal

1Tx

**802.11b:** Duty cycle of test signal is 100 %, duty factor is not required.

**802.11g:** Duty cycle =  $2.019/2.075 = 0.973$ , Duty factor =  $10 * \log(1/0.973) = 0.12$

**802.11n (20MHz):** Duty cycle =  $1.885/1.941 = 0.971$ , Duty factor =  $10 * \log(1/0.971) = 0.13$

**802.11n (40MHz):** Duty cycle =  $0.893/0.965 = 0.925$ , Duty factor =  $10 * \log(1/0.925) = 0.34$

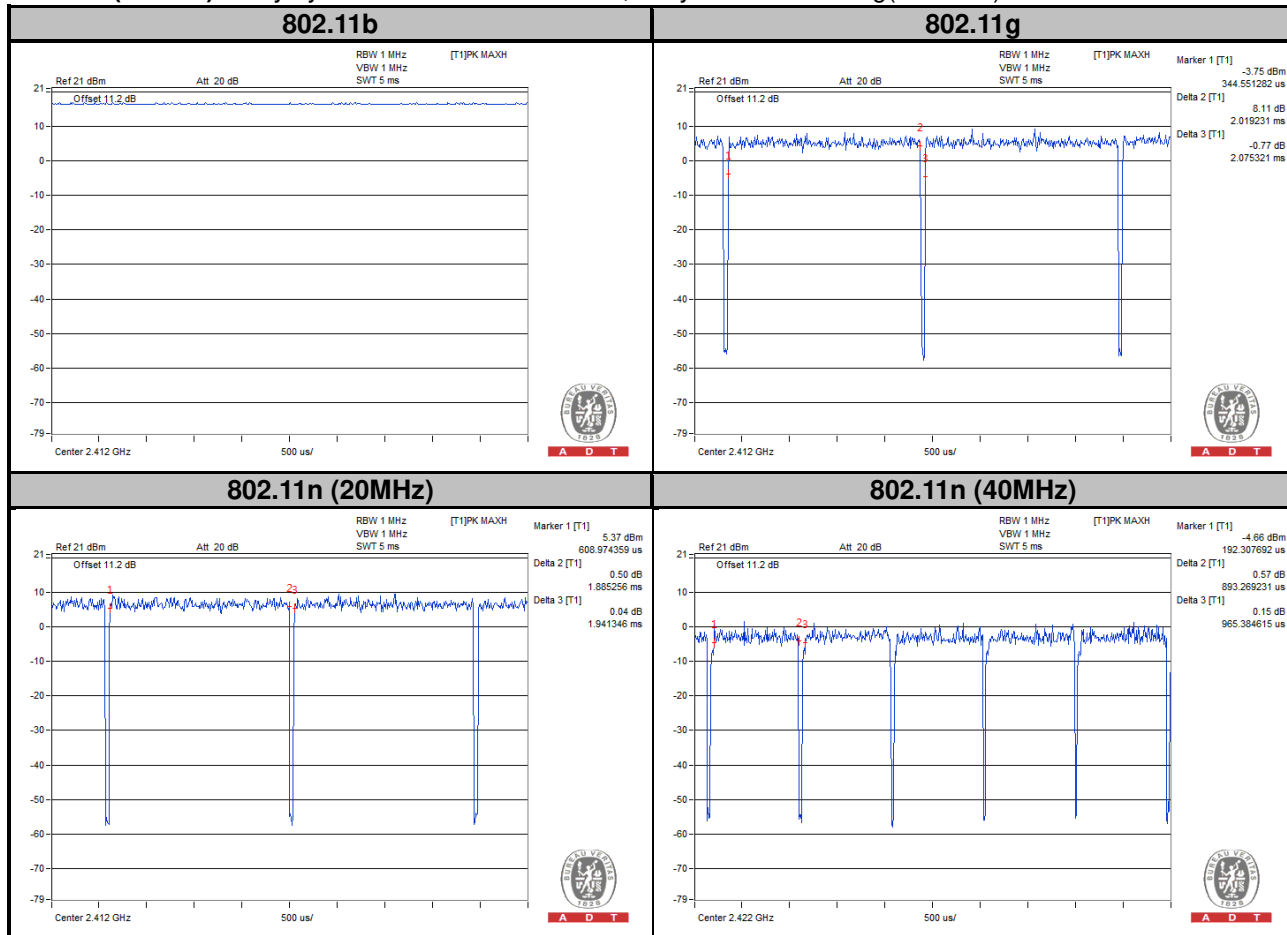

### 2Tx

802.11n (20MHz): Duty cycle =  $1.875/1.939 = 0.967$ , Duty factor =  $10 * \log(1/0.967) = 0.15$

802.11n (40MHz): Duty cycle =  $0.900/0.965 = 0.932$ , Duty factor =  $10 * \log(1/0.932) = 0.31$

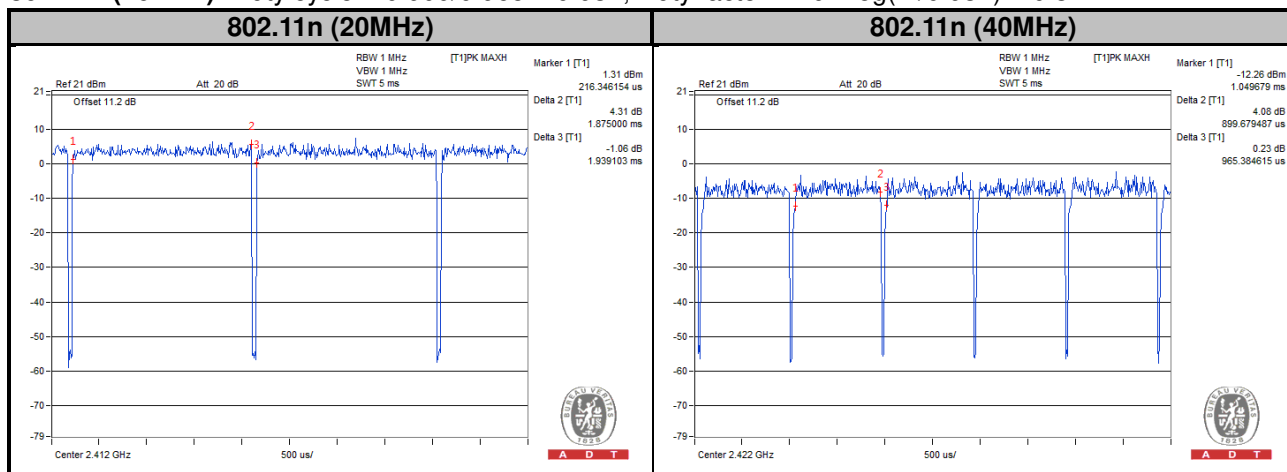

### 3Tx

802.11n (20MHz): Duty cycle =  $1.883/1.947 = 0.967$ , Duty factor =  $10 * \log(1/0.967) = 0.15$

802.11n (40MHz): Duty cycle =  $0.889/0.978 = 0.910$ , Duty factor =  $10 * \log(1/0.910) = 0.41$

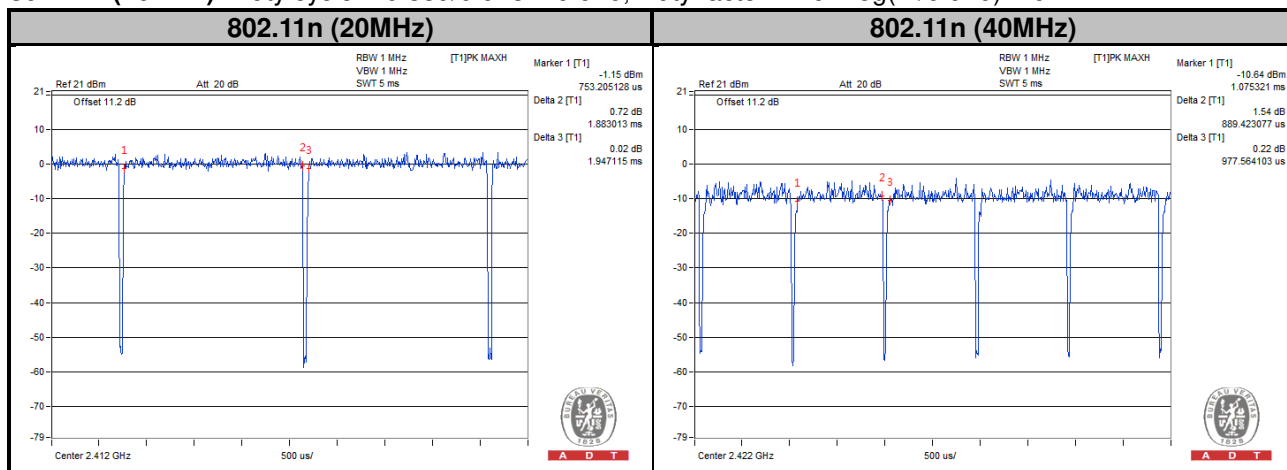

### 3.4 Description of Support Units

The EUT has been tested as an independent unit together with other necessary accessories or support units.

#### 3.4.1 Configuration of System under Test

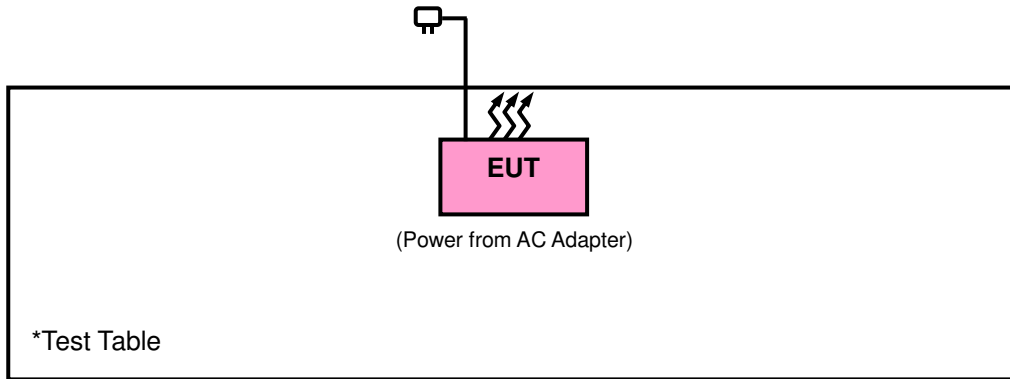

### 3.5 General Description of Applied Standards

The EUT is a RF Product. According to the specifications of the manufacturer, it must comply with the requirements of the following standards:

**FCC Part 15, Subpart C (15.247)**

**558074 D01 DTS Meas Guidance v04**

**662911 D01 Multiple Transmitter Output v02r01**

ANSI C63.10-2013

All test items have been performed and recorded as per the above standards.

**NOTE:** The EUT has been verified to comply with the requirements of FCC Part 15, Subpart B, Class B (DoC).  
The test report has been issued separately.

## 4 Test Types and Results

### 4.1 Radiated Emission and Bandedge Measurement

#### 4.1.1 Limits of Radiated Emission and Bandedge Measurement

Radiated emissions which fall in the restricted bands must comply with the radiated emission limits specified as below table. Other emissions shall be at least 20 dB below the highest level of the desired power:

Frequencies (MHz)	Field Strength (microvolts/meter)	Measurement Distance (meters)
0.009 ~ 0.490	2400/F (kHz)	300
0.490 ~ 1.705	24000/F (kHz)	30
1.705 ~ 30.0	30	30
30 ~ 88	100	3
88 ~ 216	150	3
216 ~ 960	200	3
Above 960	500	3

**NOTE:**

1. The lower limit shall apply at the transition frequencies.
2. Emission level (dBuV/m) = 20 log Emission level (uV/m).
3. For frequencies above 1000 MHz, the field strength limits are based on average detector, however, the peak field strength of any emission shall not exceed the maximum permitted average limits, specified above by more than 20 dB under any condition of modulation.

#### 4.1.2 Test Instruments

Description & Manufacturer	Model No.	Serial No.	Date of Calibration	Due Date of Calibration
Test Receiver Agilent	N9038A	MY51210203	Feb. 17, 2017	Feb. 16, 2018
Spectrum Analyzer Agilent	N9010A	MY52220314	Dec. 16, 2016	Dec. 15, 2017
Spectrum Analyzer ROHDE & SCHWARZ	FSU43	101261	Dec. 13, 2016	Dec. 12, 2017
BILOG Antenna SCHWARZBECK	VULB9168	9168-472	Dec. 26, 2016	Dec. 27, 2017
HORN Antenna SCHWARZBECK	BBHA 9120 D	9120D-969	Dec. 12, 2016	Dec. 13, 2017
HORN Antenna SCHWARZBECK	BBHA 9170	9170-480	Dec. 14, 2016	Dec. 13, 2017
Fixed Attenuator Mini-Circuits	MDCS18N-10	MDCS18N-10-01	Apr. 17, 2017	Apr. 16, 2018
Loop Antenna	HLA 6121	45745	May 19, 2017	May 18, 2018
Preamplifier EMCI	EMC001340	980201	Nov. 02, 2016	Nov. 01, 2017
Bluetooth Tester	CBT	100946	Jul. 29, 2016	Jul. 28, 2018
Preamplifier EMCI	EMC 012645	980115	Oct. 21, 2016	Oct. 20, 2017
Preamplifier EMCI	EMC 184045	980116	Oct. 21, 2016	Oct. 20, 2017
Preamplifier EMCI	EMC 330H	980112	Oct. 21, 2016	Oct. 20, 2017
Power Meter Anritsu	ML2495A	1145013	Mar. 07, 2017	Mar. 06, 2018
Power Sensor Anritsu	MA2411B	1126085	Mar. 07, 2017	Mar. 06, 2018
RF signal cable HUBER+SUHNNER	SUCOFLEX 104	309219/4 2950114	Oct. 21, 2016	Oct. 20, 2017
RF signal cable HUBER+SUHNNER	SUCOFLEX 104	250130/4	Oct. 21, 2016	Oct. 20, 2017
RF Coaxial Cable Worken	8D-FB	Cable-Ch10-01	Oct. 21, 2016	Oct. 20, 2017
Software BV ADT	E3 6.120103	NA	NA	NA
Antenna Tower MF	MFA-440H	NA	NA	NA
Turn Table MF	MFT-201SS	NA	NA	NA
Antenna Tower & Turn Table Controller MF	MF-7802	NA	NA	NA
Temperature & Humidity Chamber	GTH-120-40-CP-A R	MAA1306-019	Sep. 08, 2017	Sep. 07, 2018
DC Power Supply Topward	33010D	807748	Oct. 25, 2016	Oct. 24, 2018
Digital Multimeter Fluke	87-III	70360742	Jun. 30, 2017	Jun. 29, 2018

- Note:
1. The calibration interval of the above test instruments is 12 / 24 months and the calibrations are traceable to NML/ROC and NIST/USA.
  2. The test was performed in HwaYa Chamber 10.
  3. The horn antenna and preamplifier (model: EMC 184045) are used only for the measurement of emission frequency above 1 GHz if tested.
  4. The IC Site Registration No. is IC7450F-10.



#### 4.1.3 Test Procedures

- a. The EUT was placed on the top of a rotating table 0.8 meters (for below 1 GHz) / 1.5 meters (for above 1 GHz) above the ground at 3 meter chamber room for test. The table was rotated 360 degrees to determine the position of the highest radiation.
- b. The EUT was set 3 meters away from the interference-receiving antenna, which was mounted on the top of a variable-height antenna tower.
- c. The height of antenna is varied from one meter to four meters above the ground to determine the maximum value of the field strength. Both horizontal and vertical polarizations of the antenna are set to make the measurement.
- d. For each suspected emission, the EUT was arranged to its worst case and then the antenna was tuned to heights from 1 meter to 4 meters and the rotatable table was turned from 0 degrees to 360 degrees to find the maximum reading.
- e. The test-receiver system was set to quasi-peak detect function and specified bandwidth with maximum hold mode when the test frequency is below 1 GHz.
- f. The test-receiver system was set to peak and average detected function and specified bandwidth with maximum hold mode when the test frequency is above 1 GHz. If the peak reading value also meets average limit, measurement with the average detector is unnecessary.

**Note:**

1. The resolution bandwidth and video bandwidth of test receiver/spectrum analyzer is 120 kHz & 360 KHz for Quasi-peak detection (QP) at frequency below 1 GHz.
2. The resolution bandwidth of test receiver/spectrum analyzer is 1 MHz and the video bandwidth is 3 MHz for Peak detection (PK) at frequency above 1 GHz.
3. The resolution bandwidth of test receiver/spectrum analyzer is 1 MHz and the video bandwidth is 1/T for Average (Duty cycle < 98 %) detection at frequency above 1 GHz.
4. The resolution bandwidth of test receiver/spectrum analyzer is 1 MHz and the video bandwidth is 10 Hz (Duty cycle  $\geq$  98 %) for Average detection (AV) at frequency above 1 GHz.
5. All modes of operation were investigated and the worst-case emissions are reported.

#### 4.1.4 Deviation from Test Standard

No deviation.

4.1.5 Test Set Up

<Radiated emission below 30 MHz>

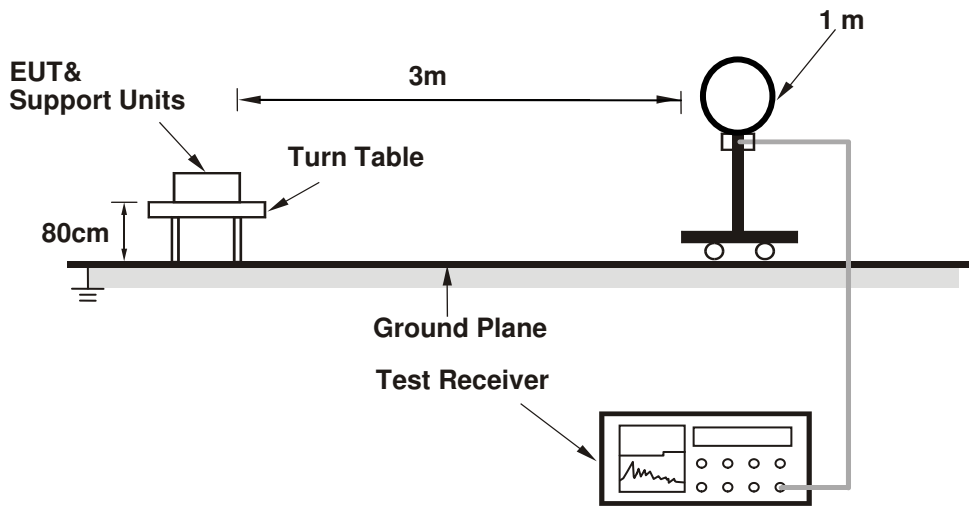

<Frequency Range below 1 GHz>

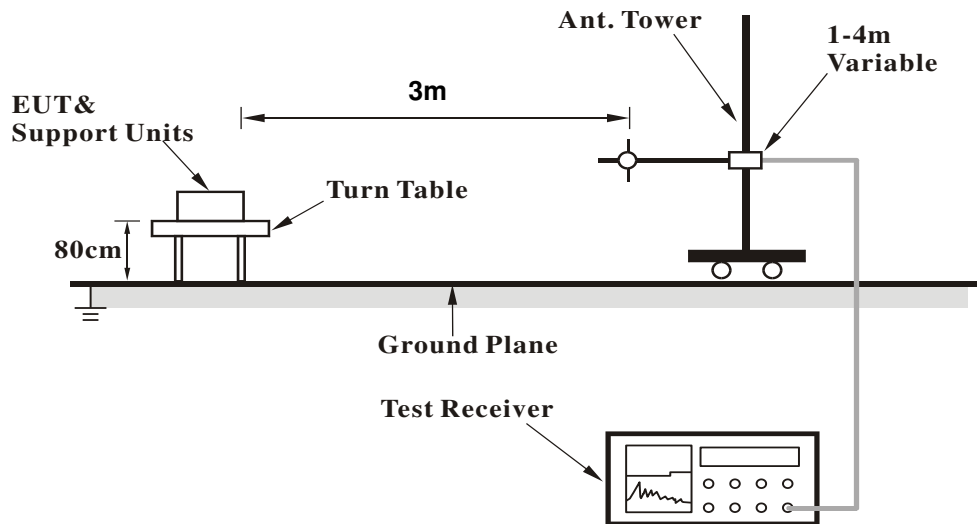

**<Frequency Range above 1 GHz>**

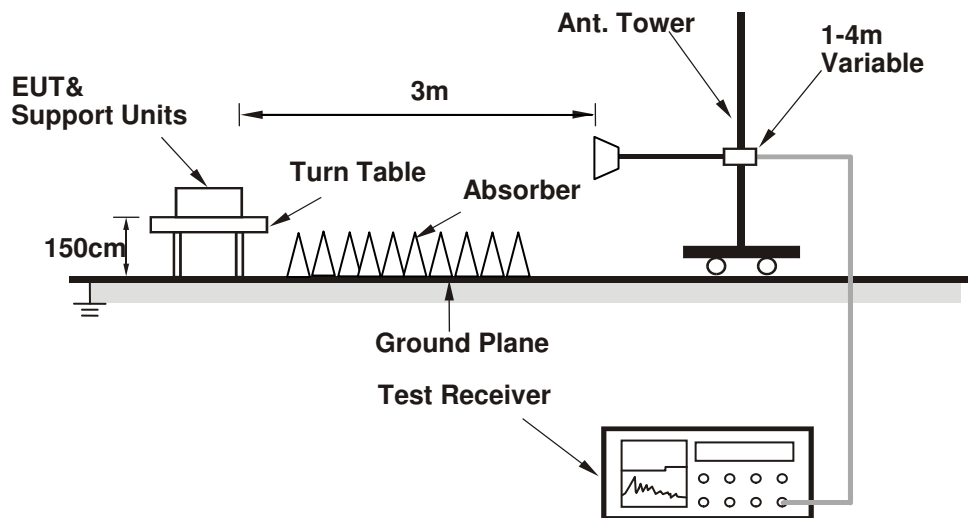

For the actual test configuration, please refer to the attached file (Test Setup Photo).

**4.1.6 EUT Operating Conditions**

- a. Placed the EUT on a testing table.
- b. Use the software to control the EUT under transmission condition continuously at specific channel frequency.

4.1.7 Test Results

Above 1 GHz Data :  
802.11b

EUT Test Condition		Measurement Detail	
Channel	Channel 1	Frequency Range	1 GHz ~ 25 GHz
Input Power	120 Vac, 60 Hz	Detector Function	Peak (PK) Average (AV)
Environmental Conditions	25 deg. C, 65 % RH	Tested By	Karl Lee

Antennal Polarity & Test Distance: Horizontal at 3 m										
Frequency (MHz)	Emission Level (dBuV/m)	Read Level (dBuV)	Limit (dBuV/m)	Margin (dB)	Antenna Factor (dB/m)	Cable Loss (dB)	Preamp Factor (dB)	Antenna Height (cm)	Table Angle (Degree)	Remark
2372	42.94	41.28	54	-11.06	31.78	5.37	35.49	334	336	Average
2372	57.04	55.38	74	-16.96	31.78	5.37	35.49	334	336	Peak
2412	105.12	103.35			31.81	5.43	35.47	334	336	Average
2412	108.19	106.42			31.81	5.43	35.47	334	336	Peak
2490	40.23	38.22	54	-13.77	31.9	5.53	35.42	334	336	Average
2490	56.23	54.22	74	-17.77	31.9	5.53	35.42	334	336	Peak

Antennal Polarity & Test Distance: Vertical at 3 m										
Frequency (MHz)	Emission Level (dBuV/m)	Read Level (dBuV)	Limit (dBuV/m)	Margin (dB)	Antenna Factor (dB/m)	Cable Loss (dB)	Preamp Factor (dB)	Antenna Height (cm)	Table Angle (Degree)	Remark
2332	51.14	49.6	54	-2.86	31.73	5.33	35.52	102	299	Average
2332	63.57	62.03	74	-10.43	31.73	5.33	35.52	102	299	Peak
2412	113.18	111.41			31.81	5.43	35.47	102	299	Average
2412	116.17	114.4			31.81	5.43	35.47	102	299	Peak
2492	42.83	40.81	54	-11.17	31.9	5.53	35.41	102	299	Average
2492	57.74	55.72	74	-16.26	31.9	5.53	35.41	102	299	Peak

Remarks:

- Emission Level = Read Level + Antenna Factor + Cable Loss - Preamp Factor  
Margin value = Emission level – Limit value
- 2412 MHz: Fundamental frequency.

EUT Test Condition		Measurement Detail	
Channel	Channel 6	Frequency Range	1 GHz ~ 25 GHz
Input Power	120 Vac, 60 Hz	Detector Function	Peak (PK) Average (AV)
Environmental Conditions	25 deg. C, 65 % RH	Tested By	Karl Lee

Antennal Polarity & Test Distance: Horizontal at 3 m										
Frequency (MHz)	Emission Level (dBuV/m)	Read Level (dBuV)	Limit (dBuV/m)	Margin (dB)	Antenna Factor (dB/m)	Cable Loss (dB)	Preamp Factor (dB)	Antenna Height (cm)	Table Angle (Degree)	Remark
2356	41.57	39.94	54	-12.43	31.76	5.37	35.5	124	18	Average
2356	57.95	56.32	74	-16.05	31.76	5.37	35.5	124	18	Peak
2437	104.84	102.99			31.85	5.46	35.46	124	18	Average
2437	107.72	105.87			31.85	5.46	35.46	124	18	Peak
2496	40.55	38.53	54	-13.45	31.9	5.53	35.41	124	18	Average
2496	55.89	53.87	74	-18.11	31.9	5.53	35.41	124	18	Peak

Antennal Polarity & Test Distance: Vertical at 3 m										
Frequency (MHz)	Emission Level (dBuV/m)	Read Level (dBuV)	Limit (dBuV/m)	Margin (dB)	Antenna Factor (dB/m)	Cable Loss (dB)	Preamp Factor (dB)	Antenna Height (cm)	Table Angle (Degree)	Remark
2358	46.03	44.4	54	-7.97	31.76	5.37	35.5	117	298	Average
2358	64.59	62.96	74	-9.41	31.76	5.37	35.5	117	298	Peak
2437	112.3	110.45			31.85	5.46	35.46	117	298	Average
2437	115.4	113.55			31.85	5.46	35.46	117	298	Peak
2486	42.96	40.97	54	-11.04	31.88	5.53	35.42	117	298	Average
2486	58.03	56.04	74	-15.97	31.88	5.53	35.42	117	298	Peak

Remarks:

- Emission Level = Read Level + Antenna Factor + Cable Loss - Preamp Factor  
Margin value = Emission level – Limit value
- 2437 MHz: Fundamental frequency.

EUT Test Condition		Measurement Detail	
Channel	Channel 11	Frequency Range	1 GHz ~ 25 GHz
Input Power	120 Vac, 60 Hz	Detector Function	Peak (PK) Average (AV)
Environmental Conditions	25 deg. C, 65 % RH	Tested By	Karl Lee

Antennal Polarity & Test Distance: Horizontal at 3 m										
Frequency (MHz)	Emission Level (dBuV/m)	Read Level (dBuV)	Limit (dBuV/m)	Margin (dB)	Antenna Factor (dB/m)	Cable Loss (dB)	Preamp Factor (dB)	Antenna Height (cm)	Table Angle (Degree)	Remark
2390	40.57	38.84	54	-13.43	31.8	5.4	35.47	116	178	Average
2390	56.26	54.53	74	-17.74	31.8	5.4	35.47	116	178	Peak
2462	104.87	102.94			31.87	5.5	35.44	116	178	Average
2462	107.97	106.04			31.87	5.5	35.44	116	178	Peak
2486	41.17	39.18	54	-12.83	31.88	5.53	35.42	116	178	Average
2486	56.02	54.03	74	-17.98	31.88	5.53	35.42	116	178	Peak

Antennal Polarity & Test Distance: Vertical at 3 m										
Frequency (MHz)	Emission Level (dBuV/m)	Read Level (dBuV)	Limit (dBuV/m)	Margin (dB)	Antenna Factor (dB/m)	Cable Loss (dB)	Preamp Factor (dB)	Antenna Height (cm)	Table Angle (Degree)	Remark
2384	46.07	44.38	54	-7.93	31.78	5.4	35.49	100	299	Average
2384	64.98	63.29	74	-9.02	31.78	5.4	35.49	100	299	Peak
2462	112.79	110.86			31.87	5.5	35.44	100	299	Average
2462	116.01	114.08			31.87	5.5	35.44	100	299	Peak
2490	49.3	47.29	54	-4.7	31.9	5.53	35.42	100	299	Average
2490	60.21	58.2	74	-13.79	31.9	5.53	35.42	100	299	Peak

Remarks:

- Emission Level = Read Level + Antenna Factor + Cable Loss - Preamp Factor  
Margin value = Emission level – Limit value
- 2462 MHz: Fundamental frequency.

802.11g

EUT Test Condition		Measurement Detail	
Channel	Channel 1	Frequency Range	1 GHz ~ 25 GHz
Input Power	120 Vac, 60 Hz	Detector Function	Peak (PK) Average (AV)
Environmental Conditions	25 deg. C, 65 % RH	Tested By	Karl Lee

Antennal Polarity & Test Distance: Horizontal at 3 m										
Frequency (MHz)	Emission Level (dBuV/m)	Read Level (dBuV)	Limit (dBuV/m)	Margin (dB)	Antenna Factor (dB/m)	Cable Loss (dB)	Preamp Factor (dB)	Antenna Height (cm)	Table Angle (Degree)	Remark
2390	44.32	42.59	54	-9.68	31.8	5.4	35.47	334	332	Average
2390	56.84	55.11	74	-17.16	31.8	5.4	35.47	334	332	Peak
2412	95.48	93.71			31.81	5.43	35.47	334	332	Average
2412	102.96	101.19			31.81	5.43	35.47	334	332	Peak
2496	41.03	39.01	54	-12.97	31.9	5.53	35.41	334	332	Average
2496	55.54	53.52	74	-18.46	31.9	5.53	35.41	334	332	Peak
Antennal Polarity & Test Distance: Vertical at 3 m										
Frequency (MHz)	Emission Level (dBuV/m)	Read Level (dBuV)	Limit (dBuV/m)	Margin (dB)	Antenna Factor (dB/m)	Cable Loss (dB)	Preamp Factor (dB)	Antenna Height (cm)	Table Angle (Degree)	Remark
2390	52.35	50.62	54	-1.65	31.8	5.4	35.47	102	299	Average
2390	68.88	67.15	74	-5.12	31.8	5.4	35.47	102	299	Peak
2412	102.15	100.38			31.81	5.43	35.47	102	299	Average
2412	110.75	108.98			31.81	5.43	35.47	102	299	Peak
2488	43.56	41.55	54	-10.44	31.9	5.53	35.42	102	299	Average
2488	56.45	54.44	74	-17.55	31.9	5.53	35.42	102	299	Peak

Remarks:

- Emission Level = Read Level + Antenna Factor + Cable Loss - Preamp Factor  
Margin value = Emission level – Limit value
- 2412 MHz: Fundamental frequency.

EUT Test Condition		Measurement Detail	
Channel	Channel 6	Frequency Range	1 GHz ~ 25 GHz
Input Power	120 Vac, 60 Hz	Detector Function	Peak (PK) Average (AV)
Environmental Conditions	25 deg. C, 65 % RH	Tested By	Karl Lee

Antennal Polarity & Test Distance: Horizontal at 3 m										
Frequency (MHz)	Emission Level (dBuV/m)	Read Level (dBuV)	Limit (dBuV/m)	Margin (dB)	Antenna Factor (dB/m)	Cable Loss (dB)	Preamp Factor (dB)	Antenna Height (cm)	Table Angle (Degree)	Remark
2354	41.85	40.26	54	-12.15	31.76	5.33	35.5	124	18	Average
2354	56.58	54.99	74	-17.42	31.76	5.33	35.5	124	18	Peak
2437	94.74	92.89			31.85	5.46	35.46	124	18	Average
2437	102.98	101.13			31.85	5.46	35.46	124	18	Peak
2498	41.5	39.48	54	-12.5	31.9	5.53	35.41	124	18	Average
2498	56.91	54.89	74	-17.09	31.9	5.53	35.41	124	18	Peak

Antennal Polarity & Test Distance: Vertical at 3 m										
Frequency (MHz)	Emission Level (dBuV/m)	Read Level (dBuV)	Limit (dBuV/m)	Margin (dB)	Antenna Factor (dB/m)	Cable Loss (dB)	Preamp Factor (dB)	Antenna Height (cm)	Table Angle (Degree)	Remark
2360	46.24	44.61	54	-7.76	31.76	5.37	35.5	117	298	Average
2360	61.86	60.23	74	-12.14	31.76	5.37	35.5	117	298	Peak
2437	102.3	100.45			31.85	5.46	35.46	117	298	Average
2437	110.8	108.95			31.85	5.46	35.46	117	298	Peak
2484	43.58	41.62	54	-10.42	31.88	5.5	35.42	117	298	Average
2484	58.21	56.25	74	-15.79	31.88	5.5	35.42	117	298	Peak

Remarks:

- Emission Level = Read Level + Antenna Factor + Cable Loss - Preamp Factor  
Margin value = Emission level – Limit value
- 2437 MHz: Fundamental frequency.



EUT Test Condition		Measurement Detail	
Channel	Channel 11	Frequency Range	1 GHz ~ 25 GHz
Input Power	120 Vac, 60 Hz	Detector Function	Peak (PK) Average (AV)
Environmental Conditions	25 deg. C, 65 % RH	Tested By	Karl Lee

Antennal Polarity & Test Distance: Horizontal at 3 m										
Frequency (MHz)	Emission Level (dBuV/m)	Read Level (dBuV)	Limit (dBuV/m)	Margin (dB)	Antenna Factor (dB/m)	Cable Loss (dB)	Preamp Factor (dB)	Antenna Height (cm)	Table Angle (Degree)	Remark
2378	41.2	39.54	54	-12.8	31.78	5.37	35.49	116	178	Average
2378	56.12	54.46	74	-17.88	31.78	5.37	35.49	116	178	Peak
2462	94.01	92.08			31.87	5.5	35.44	116	178	Average
2462	102.21	100.28			31.87	5.5	35.44	116	178	Peak
2484	41.71	39.75	54	-12.29	31.88	5.5	35.42	116	178	Average
2484	56.15	54.19	74	-17.85	31.88	5.5	35.42	116	178	Peak

Antennal Polarity & Test Distance: Vertical at 3 m										
Frequency (MHz)	Emission Level (dBuV/m)	Read Level (dBuV)	Limit (dBuV/m)	Margin (dB)	Antenna Factor (dB/m)	Cable Loss (dB)	Preamp Factor (dB)	Antenna Height (cm)	Table Angle (Degree)	Remark
2376	45.69	44.03	54	-8.31	31.78	5.37	35.49	100	299	Average
2376	61.39	59.73	74	-12.61	31.78	5.37	35.49	100	299	Peak
2462	102.21	100.28			31.87	5.5	35.44	100	299	Average
2462	110.87	108.94			31.87	5.5	35.44	100	299	Peak
2486	48.32	46.33	54	-5.68	31.88	5.53	35.42	100	299	Average
2486	67.64	65.65	74	-6.36	31.88	5.53	35.42	100	299	Peak

Remarks:

- Emission Level = Read Level + Antenna Factor + Cable Loss - Preamp Factor  
Margin value = Emission level – Limit value
- 2462 MHz: Fundamental frequency.

### 802.11n (HT20)

EUT Test Condition		Measurement Detail	
Channel	Channel 1	Frequency Range	1 GHz ~ 25 GHz
Input Power	120 Vac, 60 Hz	Detector Function	Peak (PK) Average (AV)
Environmental Conditions	25 deg. C, 65 % RH	Tested By	Karl Lee

#### Antennal Polarity & Test Distance: Horizontal at 3 m

Frequency (MHz)	Emission Level (dBuV/m)	Read Level (dBuV)	Limit (dBuV/m)	Margin (dB)	Antenna Factor (dB/m)	Cable Loss (dB)	Preamp Factor (dB)	Antenna Height (cm)	Table Angle (Degree)	Remark
2336	43.79	42.24	54	-10.21	31.74	5.33	35.52	100	347	Average
2336	56.62	55.07	74	-17.38	31.74	5.33	35.52	100	347	Peak
2412	98.88	97.11			31.81	5.43	35.47	100	347	Average
2412	106.74	104.97			31.81	5.43	35.47	100	347	Peak
2488	42.22	40.21	54	-11.78	31.9	5.53	35.42	100	347	Average
2488	56.23	54.22	74	-17.77	31.9	5.53	35.42	100	347	Peak

#### Antennal Polarity & Test Distance: Vertical at 3 m

Frequency (MHz)	Emission Level (dBuV/m)	Read Level (dBuV)	Limit (dBuV/m)	Margin (dB)	Antenna Factor (dB/m)	Cable Loss (dB)	Preamp Factor (dB)	Antenna Height (cm)	Table Angle (Degree)	Remark
2390	52.26	50.53	54	-1.74	31.8	5.4	35.47	132	260	Average
2390	64.52	62.79	74	-9.48	31.8	5.4	35.47	132	260	Peak
2412	106.86	105.09			31.81	5.43	35.47	133	261	Average
2412	114.27	112.5			31.81	5.43	35.47	133	261	Peak
2498	45.81	43.79	54	-8.19	31.9	5.53	35.41	133	261	Average
2498	59.6	57.58	74	-14.4	31.9	5.53	35.41	133	261	Peak

#### Remarks:

- Emission Level = Read Level + Antenna Factor + Cable Loss - Preamp Factor  
Margin value = Emission level – Limit value
- 2412 MHz: Fundamental frequency.

EUT Test Condition		Measurement Detail	
Channel	Channel 6	Frequency Range	1 GHz ~ 25 GHz
Input Power	120 Vac, 60 Hz	Detector Function	Peak (PK) Average (AV)
Environmental Conditions	25 deg. C, 65 % RH	Tested By	Karl Lee

Antennal Polarity & Test Distance: Horizontal at 3 m										
Frequency (MHz)	Emission Level (dBuV/m)	Read Level (dBuV)	Limit (dBuV/m)	Margin (dB)	Antenna Factor (dB/m)	Cable Loss (dB)	Preamp Factor (dB)	Antenna Height (cm)	Table Angle (Degree)	Remark
2354	43.54	41.95	54	-10.46	31.76	5.33	35.5	116	347	Average
2354	57.63	56.04	74	-16.37	31.76	5.33	35.5	116	347	Peak
2437	98.66	96.81			31.85	5.46	35.46	116	347	Average
2437	106.06	104.21			31.85	5.46	35.46	116	347	Peak
2496	41.99	39.97	54	-12.01	31.9	5.53	35.41	116	347	Average
2496	56.82	54.8	74	-17.18	31.9	5.53	35.41	116	347	Peak
Antennal Polarity & Test Distance: Vertical at 3 m										
Frequency (MHz)	Emission Level (dBuV/m)	Read Level (dBuV)	Limit (dBuV/m)	Margin (dB)	Antenna Factor (dB/m)	Cable Loss (dB)	Preamp Factor (dB)	Antenna Height (cm)	Table Angle (Degree)	Remark
2350	48.04	46.47	54	-5.96	31.74	5.33	35.5	132	297	Average
2350	60.7	59.13	74	-13.3	31.74	5.33	35.5	132	297	Peak
2437	106.48	104.63			31.85	5.46	35.46	132	297	Average
2437	114.31	112.46			31.85	5.46	35.46	132	297	Peak
2498	45.41	43.39	54	-8.59	31.9	5.53	35.41	132	297	Average
2498	57.43	55.41	74	-16.57	31.9	5.53	35.41	132	297	Peak

Remarks:

- Emission Level = Read Level + Antenna Factor + Cable Loss - Preamp Factor  
Margin value = Emission level – Limit value
- 2437 MHz: Fundamental frequency.

EUT Test Condition		Measurement Detail	
Channel	Channel 11	Frequency Range	1 GHz ~ 25 GHz
Input Power	120 Vac, 60 Hz	Detector Function	Peak (PK) Average (AV)
Environmental Conditions	25 deg. C, 65 % RH	Tested By	Karl Lee

Antennal Polarity & Test Distance: Horizontal at 3 m										
Frequency (MHz)	Emission Level (dBuV/m)	Read Level (dBuV)	Limit (dBuV/m)	Margin (dB)	Antenna Factor (dB/m)	Cable Loss (dB)	Preamp Factor (dB)	Antenna Height (cm)	Table Angle (Degree)	Remark
2380	43.08	41.42	54	-10.92	31.78	5.37	35.49	114	347	Average
2380	56.78	55.12	74	-17.22	31.78	5.37	35.49	114	347	Peak
2462	98.41	96.48			31.87	5.5	35.44	114	347	Average
2462	106.07	104.14			31.87	5.5	35.44	114	347	Peak
2484	42.88	40.92	54	-11.12	31.88	5.5	35.42	114	347	Average
2484	55.8	53.84	74	-18.2	31.88	5.5	35.42	114	347	Peak
Antennal Polarity & Test Distance: Vertical at 3 m										
Frequency (MHz)	Emission Level (dBuV/m)	Read Level (dBuV)	Limit (dBuV/m)	Margin (dB)	Antenna Factor (dB/m)	Cable Loss (dB)	Preamp Factor (dB)	Antenna Height (cm)	Table Angle (Degree)	Remark
2382	48.34	46.65	54	-5.66	31.78	5.4	35.49	101	304	Average
2382	61.04	59.35	74	-12.96	31.78	5.4	35.49	101	304	Peak
2462	106.2	104.27			31.87	5.5	35.44	101	304	Average
2462	114.64	112.71			31.87	5.5	35.44	101	304	Peak
2484	49.36	47.4	54	-4.64	31.88	5.5	35.42	100	257	Average
2484	62.54	60.58	74	-11.46	31.88	5.5	35.42	100	257	Peak

Remarks:

- Emission Level = Read Level + Antenna Factor + Cable Loss - Preamp Factor  
Margin value = Emission level – Limit value
- 2462 MHz: Fundamental frequency.

802.11n (HT40)

EUT Test Condition		Measurement Detail	
Channel	Channel 3	Frequency Range	1 GHz ~ 25 GHz
Input Power	120 Vac, 60 Hz	Detector Function	Peak (PK) Average (AV)
Environmental Conditions	25 deg. C, 65 % RH	Tested By	Karl Lee

**Antennal Polarity & Test Distance: Horizontal at 3 m**

Frequency (MHz)	Emission Level (dBuV/m)	Read Level (dBuV)	Limit (dBuV/m)	Margin (dB)	Antenna Factor (dB/m)	Cable Loss (dB)	Preamp Factor (dB)	Antenna Height (cm)	Table Angle (Degree)	Remark
2390	44.68	42.95	54	-9.32	31.8	5.4	35.47	131	346	Average
2390	57.38	55.65	74	-16.62	31.8	5.4	35.47	131	346	Peak
2422	92.83	91.03			31.83	5.43	35.46	131	346	Average
2422	100.14	98.34			31.83	5.43	35.46	131	346	Peak
2492	41.9	39.88	54	-12.1	31.9	5.53	35.41	131	346	Average
2492	56.03	54.01	74	-17.97	31.9	5.53	35.41	131	346	Peak

**Antennal Polarity & Test Distance: Vertical at 3 m**

Frequency (MHz)	Emission Level (dBuV/m)	Read Level (dBuV)	Limit (dBuV/m)	Margin (dB)	Antenna Factor (dB/m)	Cable Loss (dB)	Preamp Factor (dB)	Antenna Height (cm)	Table Angle (Degree)	Remark
2390	52.37	50.64	54	-1.63	31.8	5.4	35.47	133	252	Average
2390	66.27	64.54	74	-7.73	31.8	5.4	35.47	133	252	Peak
2422	100.71	98.91			31.83	5.43	35.46	133	261	Average
2422	108.56	106.76			31.83	5.43	35.46	133	261	Peak
2488	45.48	43.47	54	-8.52	31.9	5.53	35.42	133	261	Average
2488	58.08	56.07	74	-15.92	31.9	5.53	35.42	133	261	Peak

Remarks:

- Emission Level = Read Level + Antenna Factor + Cable Loss - Preamp Factor  
Margin value = Emission level – Limit value
- 2422 MHz: Fundamental frequency.

EUT Test Condition		Measurement Detail	
Channel	Channel 6	Frequency Range	1 GHz ~ 25 GHz
Input Power	120 Vac, 60 Hz	Detector Function	Peak (PK) Average (AV)
Environmental Conditions	25 deg. C, 65 % RH	Tested By	Karl Lee

Antennal Polarity & Test Distance: Horizontal at 3 m										
Frequency (MHz)	Emission Level (dBuV/m)	Read Level (dBuV)	Limit (dBuV/m)	Margin (dB)	Antenna Factor (dB/m)	Cable Loss (dB)	Preamp Factor (dB)	Antenna Height (cm)	Table Angle (Degree)	Remark
2390	44.68	42.95	54	-9.32	31.8	5.4	35.47	116	347	Average
2390	57.57	55.84	74	-16.43	31.8	5.4	35.47	116	347	Peak
2437	93.01	91.16			31.85	5.46	35.46	116	347	Average
2437	101.4	99.55			31.85	5.46	35.46	116	347	Peak
2498	42.41	40.39	54	-11.59	31.9	5.53	35.41	116	347	Average
2498	56.77	54.75	74	-17.23	31.9	5.53	35.41	116	347	Peak
Antennal Polarity & Test Distance: Vertical at 3 m										
Frequency (MHz)	Emission Level (dBuV/m)	Read Level (dBuV)	Limit (dBuV/m)	Margin (dB)	Antenna Factor (dB/m)	Cable Loss (dB)	Preamp Factor (dB)	Antenna Height (cm)	Table Angle (Degree)	Remark
2390	50.56	48.83	54	-3.44	31.8	5.4	35.47	137	257	Average
2390	61.78	60.05	74	-12.22	31.8	5.4	35.47	137	257	Peak
2437	101.89	100.04			31.85	5.46	35.46	132	297	Average
2437	109.86	108.01			31.85	5.46	35.46	132	297	Peak
2484	46.36	44.4	54	-7.64	31.88	5.5	35.42	132	297	Average
2484	59.3	57.34	74	-14.7	31.88	5.5	35.42	132	297	Peak

Remarks:

- Emission Level = Read Level + Antenna Factor + Cable Loss - Preamp Factor  
Margin value = Emission level – Limit value
- 2437 MHz: Fundamental frequency.

EUT Test Condition		Measurement Detail	
Channel	Channel 9	Frequency Range	1 GHz ~ 25 GHz
Input Power	120 Vac, 60 Hz	Detector Function	Peak (PK) Average (AV)
Environmental Conditions	25 deg. C, 65 % RH	Tested By	Karl Lee

Antennal Polarity & Test Distance: Horizontal at 3 m										
Frequency (MHz)	Emission Level (dBuV/m)	Read Level (dBuV)	Limit (dBuV/m)	Margin (dB)	Antenna Factor (dB/m)	Cable Loss (dB)	Preamp Factor (dB)	Antenna Height (cm)	Table Angle (Degree)	Remark
2360	43.16	41.53	54	-10.84	31.76	5.37	35.5	114	347	Average
2360	57.11	55.48	74	-16.89	31.76	5.37	35.5	114	347	Peak
2452	93.46	91.59			31.85	5.46	35.44	114	347	Average
2452	100.5	98.63			31.85	5.46	35.44	114	347	Peak
2484	45.23	43.27	54	-8.77	31.88	5.5	35.42	114	347	Average
2484	60.01	58.05	74	-13.99	31.88	5.5	35.42	114	347	Peak
Antennal Polarity & Test Distance: Vertical at 3 m										
Frequency (MHz)	Emission Level (dBuV/m)	Read Level (dBuV)	Limit (dBuV/m)	Margin (dB)	Antenna Factor (dB/m)	Cable Loss (dB)	Preamp Factor (dB)	Antenna Height (cm)	Table Angle (Degree)	Remark
2386	49.85	48.14	54	-4.15	31.8	5.4	35.49	101	241	Average
2386	60.02	58.31	74	-13.98	31.8	5.4	35.49	101	241	Peak
2452	100.52	98.65			31.85	5.46	35.44	101	241	Average
2452	108.16	106.29			31.85	5.46	35.44	101	241	Peak
<b>2484</b>	<b>52.48</b>	<b>50.52</b>	<b>54</b>	<b>-1.52</b>	<b>31.88</b>	<b>5.5</b>	<b>35.42</b>	<b>105</b>	<b>235</b>	<b>Average</b>
2484	68.67	66.71	74	-5.33	31.88	5.5	35.42	105	235	Peak

Remarks:

- Emission Level = Read Level + Antenna Factor + Cable Loss - Preamp Factor  
Margin value = Emission level – Limit value
- 2452 MHz: Fundamental frequency.

**9 kHz ~ 30 MHz Data:**

The amplitude of spurious emissions attenuated more than 20 dB below the permissible value is not required to be report.

**30 MHz ~ 1 GHz Worst-Case Data:**

**802.11n (HT40)**

EUT Test Condition		Measurement Detail	
Channel	Channel 9	Frequency Range	30 MHz ~ 1 GHz
Input Power	120 Vac, 60 Hz	Detector Function	Peak (PK) Quasi-peak (QP)
Environmental Conditions	25 deg. C, 65 % RH	Tested By	Karl Lee

Antennal Polarity & Test Distance: Horizontal at 3 m										
Frequency (MHz)	Emission Level (dBuV/m)	Read Level (dBuV)	Limit (dBuV/m)	Margin (dB)	Antenna Factor (dB/m)	Cable Loss (dB)	Preamp Factor (dB)	Antenna Height (cm)	Table Angle (Degree)	Remark
32.16	27.95	43.26	40	-12.05	16.21	0.74	32.26	165	274	Peak
192.81	26.74	46.89	43.5	-16.76	10.51	1.61	32.27	132	127	Peak
278.4	26.51	42.86	46	-19.49	13.74	2.03	32.12	175	142	Peak
599.6	28.46	36.68	46	-17.54	21.1	2.87	32.19	108	271	Peak
785.1	29.85	34.79	46	-16.15	23.87	3.27	32.08	135	217	Peak
899.9	33.67	36.66	46	-12.33	25	3.49	31.48	138	304	Peak

Antennal Polarity & Test Distance: Vertical at 3 m										
Frequency (MHz)	Emission Level (dBuV/m)	Read Level (dBuV)	Limit (dBuV/m)	Margin (dB)	Antenna Factor (dB/m)	Cable Loss (dB)	Preamp Factor (dB)	Antenna Height (cm)	Table Angle (Degree)	Remark
43.5	34.93	56.32	40	-5.07	9.93	0.9	32.22	116	127	Peak
193.35	20.58	40.67	43.5	-22.92	10.57	1.61	32.27	134	271	Peak
274.89	21.89	38.37	46	-24.11	13.7	1.94	32.12	194	212	Peak
599.6	28.03	36.25	46	-17.97	21.1	2.87	32.19	139	237	Peak
750.8	29.17	34.89	46	-16.83	23.2	3.22	32.14	175	247	Peak
899.9	33.39	36.38	46	-12.61	25	3.49	31.48	117	123	Peak

Remarks:

- Emission Level = Read Level + Antenna Factor + Cable Loss - Preamp Factor  
Margin value = Emission level – Limit value



## 4.2 Conducted Emission Measurement

### 4.2.1 Limits of Conducted Emission Measurement

Frequency (MHz)	Conducted Limit (dBuV)	
	Quasi-peak	Average
0.15 - 0.5	66 - 56	56 - 46
0.50 - 5.0	56	46
5.0 - 30.0	60	50

- Note: 1. The lower limit shall apply at the transition frequencies.  
 2. The limit decreases in line with the logarithm of the frequency in the range of 0.15 to 0.50 MHz.

### 4.2.2 Test Instruments

Description & Manufacturer	Model No.	Serial No.	Date of Calibration	Due Date of Calibration
Test Receiver ROHDE & SCHWARZ	ESCI	100613	Nov. 21, 2016	Nov. 20, 2017
RF signal cable (with 10dB PAD) Woken	5D-FB	Cable-cond1-01	Sep. 05, 2017	Sep. 04, 2018
LISN/AMN ROHDE & SCHWARZ (EUT)	ESH3-Z5	835239/001	Mar. 10, 2017	Mar. 09, 2018
LISN/AMN ROHDE & SCHWARZ (Peripheral)	ENV216	101196	Apr. 20, 2017	Apr. 19, 2018
Software ADT	BV ADT_Cond_ V7.3.7.3	NA	NA	NA

- Note: 1. The calibration interval of the above test instruments is 12 months and the calibrations are traceable to NML/ROC and NIST/USA.  
 2. The test was performed in HwaYa Shielded Room 1.  
 3. The VCCI Site Registration No. is C-2040.

#### 4.2.3 Test Procedures

- a. The EUT was placed 0.4 meters from the conducting wall of the shielded room with EUT being connected to the power mains through a line impedance stabilization network (LISN). Other support units were connected to the power mains through another LISN. The two LISNs provide 50 ohm/50 uH of coupling impedance for the measuring instrument.
- b. Both lines of the power mains connected to the EUT were checked for maximum conducted interference.
- c. The frequency range from 150 kHz to 30 MHz was searched. Emission levels under (Limit – 20 dB) was not recorded.

**NOTE:** All modes of operation were investigated and the worst-case emissions are reported.

#### 4.2.4 Deviation from Test Standard

No deviation.

#### 4.2.5 Test Setup

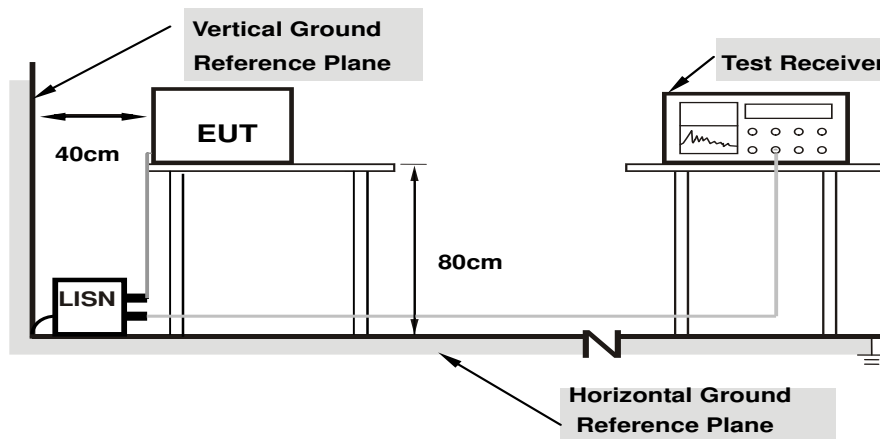

**Note:** 1.Support units were connected to second LISN.

For the actual test configuration, please refer to the attached file (Test Setup Photo).

#### 4.2.6 EUT Operating Conditions

- a. Placed the EUT on a testing table.
- b. Use the software to control the EUT under transmission condition continuously at specific channel frequency.

#### 4.2.7 Test Results

Frequency Range	150kHz ~ 30MHz	Detector Function & Resolution Bandwidth	Quasi-Peak (QP) / Average (AV), 9kHz
Input Power	120Vac, 60Hz	Environmental Conditions	25°C, 65%RH
Tested by	Getaz Yang	Test Date	2017/10/6

Phase Of Power : Line (L)										
No	Frequency (MHz)	Correction Factor (dB)	Reading Value (dBuV)		Emission Level (dBuV)		Limit (dBuV)		Margin (dB)	
			Q.P.	AV.	Q.P.	AV.	Q.P.	AV.	Q.P.	AV.
1	0.19367	10.39	35.16	23.69	45.55	34.08	63.88	53.88	-18.33	-19.80
2	0.25338	10.40	32.12	22.78	42.52	33.18	61.65	51.65	-19.13	-18.47
3	0.32203	10.40	33.13	20.88	43.53	31.28	59.65	49.65	-16.12	-18.37
<b>4</b>	<b>0.42600</b>	<b>10.41</b>	<b>35.62</b>	<b>23.55</b>	<b>46.03</b>	<b>33.96</b>	<b>57.33</b>	<b>47.33</b>	<b>-11.30</b>	<b>-13.37</b>
5	0.65800	10.41	29.97	17.55	40.38	27.96	56.00	46.00	-15.62	-18.04
6	1.19800	10.43	27.94	17.71	38.37	28.14	56.00	46.00	-17.63	-17.86

Remarks:

1. Q.P. and AV. are abbreviations of quasi-peak and average individually.
2. The emission levels of other frequencies were very low against the limit.
3. Margin value = Emission level – Limit value
4. Correction factor = Insertion loss + Cable loss
5. Emission Level = Correction Factor + Reading Value

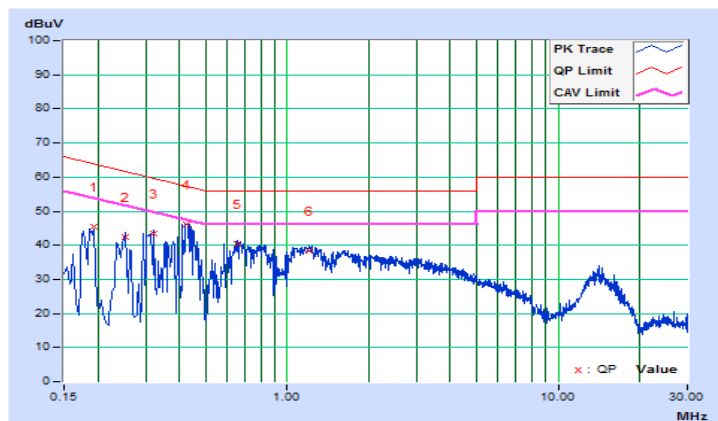

Frequency Range	150kHz ~ 30MHz	Detector Function & Resolution Bandwidth	Quasi-Peak (QP) / Average (AV), 9kHz
Input Power	120Vac, 60Hz	Environmental Conditions	25°C, 65%RH
Tested by	Getaz Yang	Test Date	2017/10/6

Phase Of Power : Neutral (N)										
No	Frequency (MHz)	Correction Factor (dB)	Reading Value (dBuV)		Emission Level (dBuV)		Limit (dBuV)		Margin (dB)	
			Q.P.	AV.	Q.P.	AV.	Q.P.	AV.	Q.P.	AV.
1	0.18180	10.16	34.29	25.50	44.45	35.66	64.40	54.40	-19.95	-18.74
2	0.25405	10.16	30.62	20.02	40.78	30.18	61.62	51.62	-20.84	-21.44
3	0.31365	10.17	31.00	20.70	41.17	30.87	59.87	49.87	-18.70	-19.00
4	0.37000	10.17	29.37	18.78	39.54	28.95	58.50	48.50	-18.96	-19.55
5	0.41799	10.17	35.40	24.01	45.57	34.18	57.49	47.49	-11.92	-13.31
6	0.65400	10.18	27.25	15.80	37.43	25.98	56.00	46.00	-18.57	-20.02

Remarks:

1. Q.P. and AV. are abbreviations of quasi-peak and average individually.
2. The emission levels of other frequencies were very low against the limit.
3. Margin value = Emission level – Limit value
4. Correction factor = Insertion loss + Cable loss
5. Emission Level = Correction Factor + Reading Value

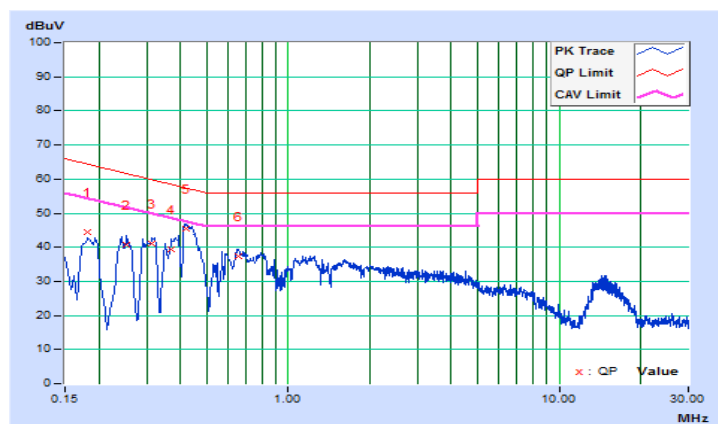

### 4.3 6 dB Bandwidth Measurement

#### 4.3.1 Limits of 6 dB Bandwidth Measurement

The minimum of 6 dB Bandwidth Measurement is 0.5 MHz.

#### 4.3.2 Test Setup

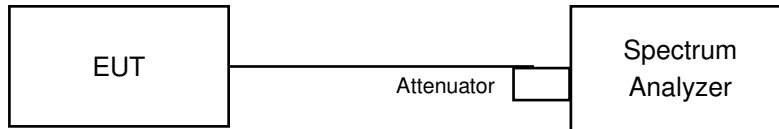

#### 4.3.3 Test Instruments

Refer to section 4.1.2 to get information of above instrument.

#### 4.3.4 Test Procedure

- Set resolution bandwidth (RBW) = 100 kHz
- Set the video bandwidth (VBW)  $\geq 3 \times$  RBW, Detector = Peak.
- Trace mode = max hold.
- Sweep = auto couple.
- Measure the maximum width of the emission that is constrained by the frequencies associated with the two amplitude points (upper and lower) that are attenuated by 6 dB relative to the maximum level measured in the fundamental emission

#### 4.3.5 Deviation from Test Standard

No deviation.

#### 4.3.6 EUT Operating Conditions

The software provided by client to enable the EUT under transmission condition continuously at lowest, middle and highest channel frequencies individually.

## 4.3.7 Test Result

## 802.11b

Channel	Frequency (MHz)	6dB Bandwidth (MHz)	Minimum Limit (MHz)	Pass / Fail
1	2412	7.11	0.5	Pass
6	2437	7.05	0.5	Pass
11	2462	7.11	0.5	Pass

## 802.11g

Channel	Frequency (MHz)	6dB Bandwidth (MHz)	Minimum Limit (MHz)	Pass / Fail
1	2412	16.38	0.5	Pass
6	2437	16.40	0.5	Pass
11	2462	16.38	0.5	Pass

## 802.11n (20MHz)

## 1Tx

Channel	Frequency (MHz)	6dB Bandwidth (MHz)	Minimum Limit (MHz)	Pass / Fail
1	2412	17.61	0.5	Pass
6	2437	17.37	0.5	Pass
11	2462	17.62	0.5	Pass

## 2Tx

Channel	Frequency (MHz)	6dB Bandwidth (MHz)		Minimum Limit (MHz)	Pass / Fail
		Chain 0	Chain 1		
1	2412	17.57	17.61	0.5	Pass
6	2437	17.63	17.61	0.5	Pass
11	2462	17.65	17.64	0.5	Pass

## 3Tx

Channel	Frequency (MHz)	6dB Bandwidth (MHz)			Minimum Limit (MHz)	Pass / Fail
		Chain 0	Chain 1	Chain 2		
1	2412	17.60	17.62	17.62	0.5	Pass
6	2437	17.62	17.62	17.62	0.5	Pass
11	2462	17.62	17.64	17.65	0.5	Pass

### 802.11n (40MHz)

#### 1Tx

Channel	Frequency (MHz)	6dB Bandwidth (MHz)	Minimum Limit (MHz)	Pass / Fail
3	2422	35.84	0.5	Pass
6	2437	35.99	0.5	Pass
9	2452	36.12	0.5	Pass

#### 2Tx

Channel	Frequency (MHz)	6dB Bandwidth (MHz)		Minimum Limit (MHz)	Pass / Fail
		Chain 0	Chain 1		
3	2422	36.40	36.10	0.5	Pass
6	2437	36.14	36.39	0.5	Pass
9	2452	35.89	36.14	0.5	Pass

#### 3Tx

Channel	Frequency (MHz)	6dB Bandwidth (MHz)			Minimum Limit (MHz)	Pass / Fail
		Chain 0	Chain 1	Chain 2		
3	2422	36.60	36.40	36.50	0.5	Pass
6	2437	35.99	36.39	36.33	0.5	Pass
9	2452	35.85	35.83	36.36	0.5	Pass

### Spectrum Plot of Worst Value

#### 802.11b

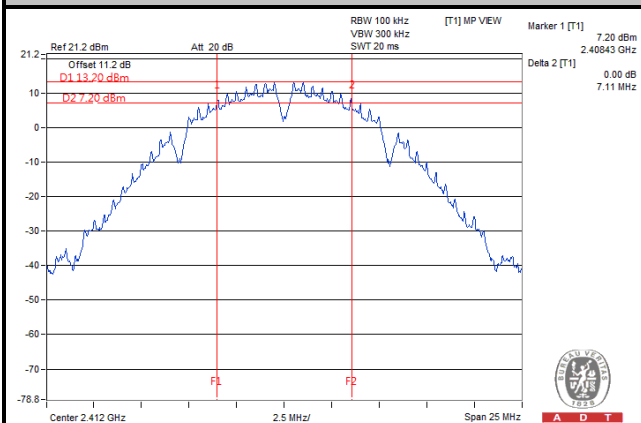

#### 802.11g

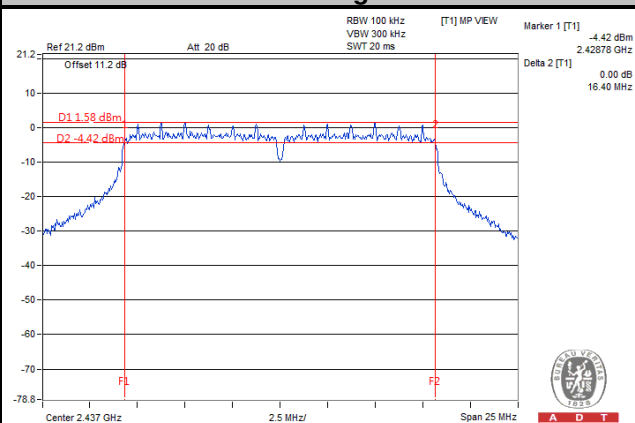

#### 802.11n (HT20)

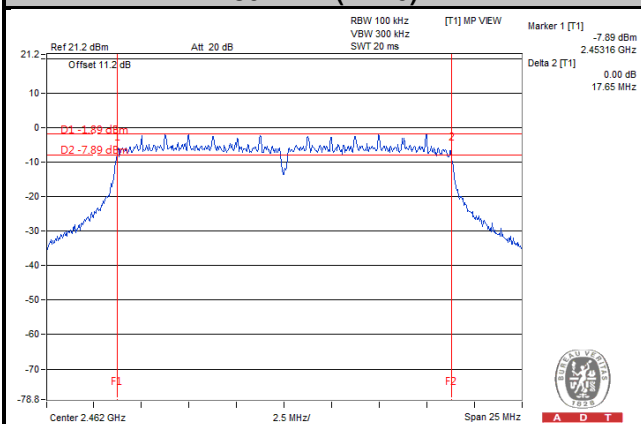

#### 802.11n (HT40)

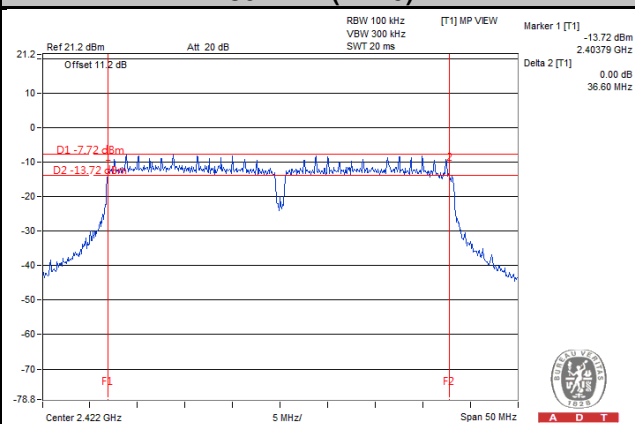



## 4.4 Occupied Bandwidth Measurement

### 4.4.1 Test Setup

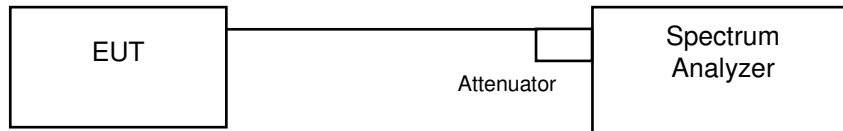

### 4.4.2 Test Instruments

Refer to section 4.1.2 to get information of above instrument.

### 4.4.3 Test Procedure

The transmitter output was connected to the spectrum analyzer through an attenuator. The bandwidth of the fundamental frequency was measured by spectrum analyzer with resolution bandwidth in the range of 1 % to 5 % of the anticipated emission bandwidth, and a video bandwidth at least 3x the resolution bandwidth and set the detector to PEAK. The width of a frequency band such that, below the lower and above the upper frequency limits, the mean powers emitted are each equal to a specified percentage 0.5 % of the total mean power of a given emission.

### 4.4.4 Deviation from Test Standard

No deviation.

### 4.4.5 EUT Operating Conditions

The software provided by client to enable the EUT under transmission condition continuously at lowest, middle and highest channel frequencies individually.

## 4.4.6 Test Results

## 802.11b

Channel	Frequency (MHz)	Occupied Bandwidth (MHz)	Pass / Fail
1	2412	12.70	Pass
6	2437	11.95	Pass
11	2462	12.10	Pass

## 802.11g

Channel	Frequency (MHz)	Occupied Bandwidth (MHz)	Pass / Fail
1	2412	17.70	Pass
6	2437	17.10	Pass
11	2462	17.70	Pass

## 802.11n (HT20)

## 1Tx

Channel	Frequency (MHz)	Occupied Bandwidth (MHz)	Pass / Fail
1	2412	18.17	Pass
6	2437	18.15	Pass
11	2462	18.15	Pass

## 2Tx

Channel	Frequency (MHz)	Occupied Bandwidth (MHz)		Pass / Fail
		Chain 0	Chain 1	
1	2412	18.13	18.80	Pass
6	2437	18.15	18.10	Pass
11	2462	18.25	18.10	Pass

## 3Tx

Channel	Frequency (MHz)	Occupied Bandwidth (MHz)			Pass / Fail
		Chain 0	Chain 1	Chain 2	
1	2412	18.13	18.13	18.80	Pass
6	2437	18.20	18.05	18.05	Pass
11	2462	18.15	18.10	18.10	Pass

### 802.11n (HT40)

#### 1Tx

Channel	Frequency (MHz)	Occupied Bandwidth (MHz)	Pass / Fail
3	2422	37.18	Pass
6	2437	37.17	Pass
9	2452	37.33	Pass

#### 2Tx

Channel	Frequency (MHz)	Occupied Bandwidth (MHz)		Pass / Fail
		Chain 0	Chain 1	
3	2422	37.18	37.18	Pass
6	2437	37.17	37.17	Pass
9	2452	37.33	37.00	Pass

#### 3Tx

Channel	Frequency (MHz)	Occupied Bandwidth (MHz)			Pass / Fail
		Chain 0	Chain 1	Chain 2	
3	2422	37.18	37.18	37.20	Pass
6	2437	37.50	37.17	37.00	Pass
9	2452	37.50	37.00	37.00	Pass

### Spectrum Plot of Worst Value

#### 802.11b

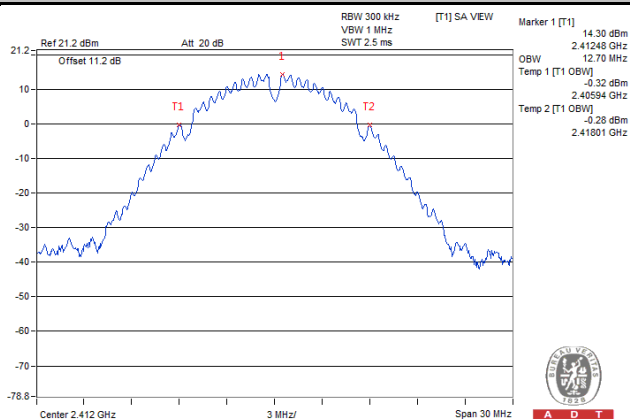

#### 802.11g

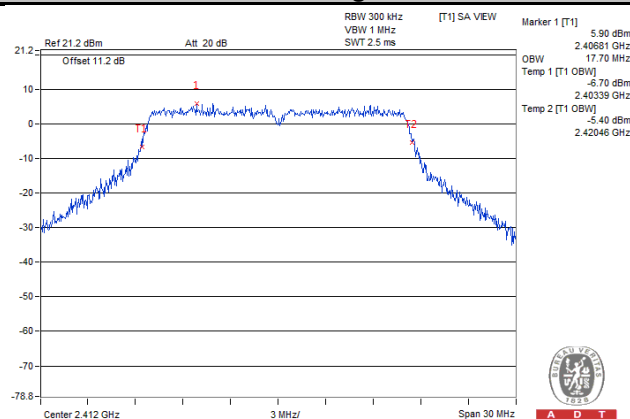

#### 802.11n (HT20)

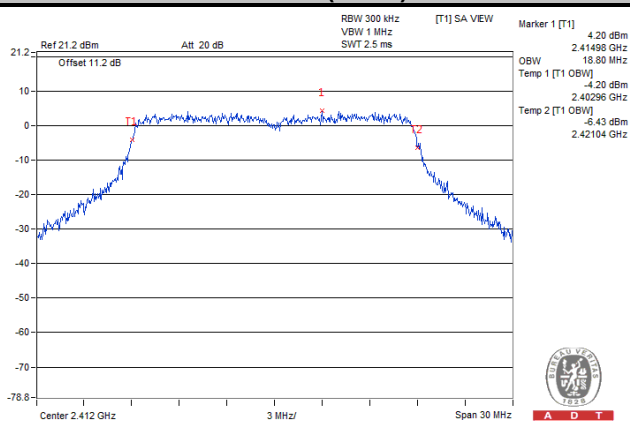

#### 802.11n (HT40)

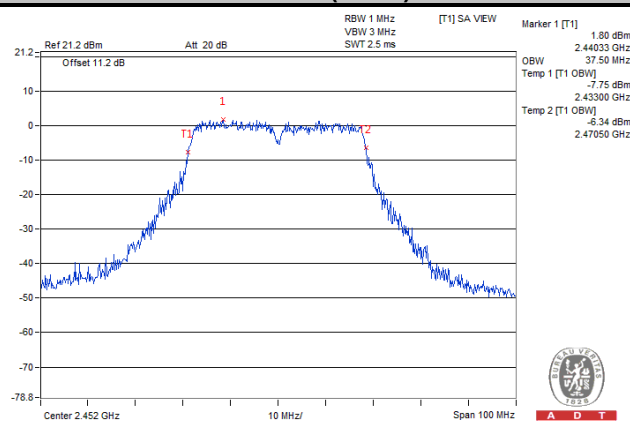

## 4.5 Conducted Output Power Measurement

### 4.5.1 Limits of Conducted Output Power Measurement

For systems using digital modulation in the 2400–2483.5 MHz bands: 1 Watt (30 dBm)

Per KDB 662911 D01 Multiple Transmitter Output Method of conducted output power measurement on IEEE 802.11 devices,

Array Gain = 0 dB (i.e., no array gain) for NANT  $\leq$  4;

Array Gain = 0 dB (i.e., no array gain) for channel widths  $\geq$  40 MHz for any NANT;

Array Gain =  $5 \log(\text{NANT}/\text{NSS})$  dB or 3 dB, whichever is less for 20 MHz channel widths with NANT  $\geq$  5.

For power measurements on all other devices: Array Gain =  $10 \log(\text{NANT}/\text{NSS})$  dB.

### 4.5.2 Test Setup

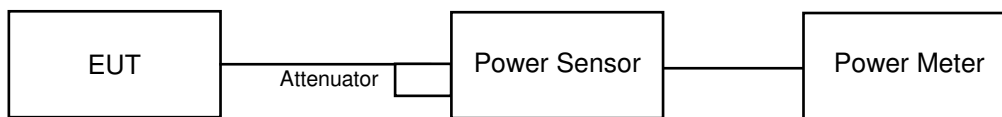

### 4.5.3 Test Instruments

Refer to section 4.1.2 to get information of above instrument.

### 4.5.4 Test Procedures

A peak power sensor was used on the output port of the EUT. A power meter was used to read the response of the peak power sensor. Record the power level.

### 4.5.5 Deviation from Test Standard

No deviation.

### 4.5.6 EUT Operating Conditions

The software provided by client to enable the EUT under transmission condition continuously at lowest, middle and highest channel frequencies individually.

#### 4.5.7 Test Results

##### 802.11b

Channel	Frequency (MHz)	Peak Power (mW)	Peak Power (dBm)	Limit (dBm)	Pass / Fail
1	2412	260.02	24.15	30	Pass
6	2437	208.93	23.20	30	Pass
11	2462	276.06	24.41	30	Pass

##### 802.11g

Channel	Frequency (MHz)	Peak Power (mW)	Peak Power (dBm)	Limit (dBm)	Pass / Fail
1	2412	267.30	24.27	30	Pass
6	2437	226.99	23.56	30	Pass
11	2462	237.68	23.76	30	Pass

##### 802.11n (HT20)

###### 1Tx

Channel	Frequency (MHz)	Peak Power (mW)	Peak Power (dBm)	Limit (dBm)	Pass / Fail
1	2412	271.64	24.34	30	Pass
6	2437	203.70	23.09	30	Pass
11	2462	199.99	23.01	30	Pass

###### 2Tx

Channel	Frequency (MHz)	Peak Power (dBm)		Total Power (mW)	Total Power (dBm)	Limit (dBm)	Pass / Fail
		Chain 0	Chain 1				
1	2412	22.26	23.47	390.598	25.92	30	Pass
6	2437	21.75	22.09	311.432	24.93	30	Pass
11	2462	20.42	22.31	280.370	24.48	30	Pass

###### 3Tx

Channel	Frequency (MHz)	Peak Power (dBm)			Total Power (mW)	Total Power (dBm)	Limit (dBm)	Pass / Fail
		Chain 0	Chain 1	Chain 2				
1	2412	21.18	21.22	21.43	402.649	26.05	30	Pass
6	2437	20.18	20.15	20.38	316.890	25.01	30	Pass
11	2462	20.09	19.81	19.86	294.641	24.69	30	Pass

### 802.11n (HT40)

#### 1Tx

Channel	Frequency (MHz)	Peak Power (mW)	Peak Power (dBm)	Limit (dBm)	Pass / Fail
3	2422	179.89	22.55	30	Pass
6	2437	261.22	24.17	30	Pass
9	2452	200.91	23.03	30	Pass

#### 2Tx

Channel	Frequency (MHz)	Peak Power (dBm)		Total Power (mW)	Total Power (dBm)	Limit (dBm)	Pass / Fail
		Chain 0	Chain 1				
3	2422	19.44	19.82	183.842	22.64	30	Pass
6	2437	20.90	22.61	305.416	24.85	30	Pass
9	2452	20.81	21.30	255.400	24.07	30	Pass

#### 3Tx

Channel	Frequency (MHz)	Peak Power (dBm)			Total Power (mW)	Total Power (dBm)	Limit (dBm)	Pass / Fail
		Chain 0	Chain 1	Chain 2				
3	2422	17.73	17.99	17.93	184.330	22.66	30	Pass
6	2437	19.19	20.61	20.45	308.983	24.90	30	Pass
9	2452	18.86	19.67	19.51	258.927	24.13	30	Pass

## 4.6 Power Spectral Density Measurement

### 4.6.1 Limits of Power Spectral Density Measurement

The Maximum of Power Spectral Density Measurement is 8 dBm.

### 4.6.2 Test Setup

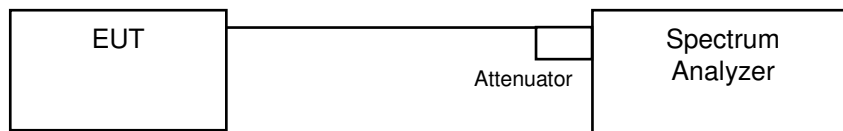

### 4.6.3 Test Instruments

Refer to section 4.1.2 to get information of above instrument.

### 4.6.4 Test Procedure

- Set analyzer center frequency to DTS channel center frequency.
- Set the span to 1.5 times the DTS bandwidth.
- Set the RBW to:  $3 \text{ kHz} \leq \text{RBW} \leq 100 \text{ kHz}$ .
- Set the VBW  $\geq 3 \times \text{RBW}$ .
- Detector = peak.
- Sweep time = auto couple.
- Trace mode = max hold.
- Allow trace to fully stabilize.
- Use the peak marker function to determine the maximum amplitude level within the RBW.

### 4.6.5 Deviation from Test Standard

No deviation.

### 4.6.6 EUT Operating Condition

The software provided by client to enable the EUT under transmission condition continuously at lowest, middle and highest channel frequencies individually.



#### 4.6.7 Test Results

##### 802.11b

Channel	Frequency (MHz)	PSD (dBm/3 kHz)	Limit (dBm/3 kHz)	Pass / Fail
1	2412	-1.40	8	Pass
6	2437	-2.25	8	Pass
11	2462	-1.67	8	Pass

##### 802.11g

Channel	Frequency (MHz)	PSD (dBm/3 kHz)	Limit (dBm/3 kHz)	Pass / Fail
1	2412	-11.10	8	Pass
6	2437	-12.10	8	Pass
11	2462	-11.70	8	Pass

### 802.11n (HT20)

#### 1Tx

Channel	Frequency (MHz)	PSD (dBm/3 kHz)	Limit (dBm/3 kHz)	Pass / Fail
1	2412	-14.37	8	Pass
6	2437	-15.58	8	Pass
11	2462	-15.64	8	Pass

#### 2Tx

Tx Chain	Channel	Freq. (MHz)	PSD (dBm/3 kHz)	10 log (N=2) dB	Total PSD (dBm/3 kHz)	Limit (dBm/3 kHz)	Pass / Fail
0	1	2412	-13.98	3.01	-10.97	5.96	Pass
	6	2437	-16.12	3.01	-13.11	5.96	Pass
	11	2462	-16.63	3.01	-13.62	5.96	Pass
1	1	2412	-12.84	3.01	-9.83	5.96	Pass
	6	2437	-13.32	3.01	-10.31	5.96	Pass
	11	2462	-13.67	3.01	-10.66	5.96	Pass

**NOTE:** Directional gain =  $5.03\text{dBi} + 10\log(2) = 8.04\text{dBi} > 6\text{dBi}$  , so the power density limit shall be reduced to  $8 - (8.04 - 6) = 5.96\text{dBm}$ .

#### 3Tx

Tx Chain	Channel	Freq. (MHz)	PSD (dBm/3 kHz)	10 log (N=3) dB	Total PSD (dBm/3 kHz)	Limit (dBm/3 kHz)	Pass / Fail
0	1	2412	-17.51	4.77	-12.74	4.2	Pass
	6	2437	-16.90	4.77	-12.13	4.2	Pass
	11	2462	-17.21	4.77	-12.44	4.2	Pass
1	1	2412	-14.41	4.77	-9.64	4.2	Pass
	6	2437	-15.60	4.77	-10.83	4.2	Pass
	11	2462	-16.34	4.77	-11.57	4.2	Pass
2	1	2412	-13.99	4.77	-9.22	4.2	Pass
	6	2437	-16.08	4.77	-11.31	4.2	Pass
	11	2462	-15.97	4.77	-11.20	4.2	Pass

**NOTE:** Directional gain =  $5.03\text{dBi} + 10\log(3) = 9.8\text{dBi} > 6\text{dBi}$  , so the power density limit shall be reduced to  $8 - (9.8 - 6) = 4.2\text{dBm}$ .

### 802.11n (HT40)

#### 1Tx

Channel	Frequency (MHz)	PSD (dBm/3 kHz)	Limit (dBm/3 kHz)	Pass / Fail
3	2422	-16.27	8	Pass
6	2437	-12.90	8	Pass
9	2452	-18.49	8	Pass

#### 2Tx

Tx Chain	Channel	Freq. (MHz)	PSD (dBm/3 kHz)	10 log (N=2) dB	Total PSD (dBm/3 kHz)	Limit (dBm/3 kHz)	Pass / Fail
0	3	2422	-20.35	3.01	-17.34	5.96	Pass
	6	2437	-18.35	3.01	-15.34	5.96	Pass
	9	2452	-16.91	3.01	-13.90	5.96	Pass
1	3	2422	-18.19	3.01	-15.18	5.96	Pass
	6	2437	-16.66	3.01	-13.65	5.96	Pass
	9	2452	-17.02	3.01	-14.01	5.96	Pass

**NOTE:** Directional gain =  $5.03\text{dBi} + 10\log(2) = 8.04\text{dBi} > 6\text{dBi}$  , so the power density limit shall be reduced to  $8-(8.04-6) = 5.96\text{dBm}$ .

#### 3Tx

Tx Chain	Channel	Freq. (MHz)	PSD (dBm/3 kHz)	10 log (N=3) dB	Total PSD (dBm/3 kHz)	Limit (dBm/3 kHz)	Pass / Fail
0	3	2422	-22.30	4.77	-17.53	4.2	Pass
	6	2437	-20.28	4.77	-15.51	4.2	Pass
	9	2452	-20.20	4.77	-15.43	4.2	Pass
1	3	2422	-21.53	4.77	-16.76	4.2	Pass
	6	2437	-18.02	4.77	-13.25	4.2	Pass
	9	2452	-19.81	4.77	-15.04	4.2	Pass
2	3	2422	-20.18	4.77	-15.41	4.2	Pass
	6	2437	-17.53	4.77	-12.76	4.2	Pass
	9	2452	-15.26	4.77	-10.49	4.2	Pass

**NOTE:** Directional gain =  $5.03\text{dBi} + 10\log(3) = 9.8\text{dBi} > 6\text{dBi}$  , so the power density limit shall be reduced to  $8-(9.8-6) = 4.2\text{dBm}$ .

### Spectrum Plot of Worst Value

#### 802.11b

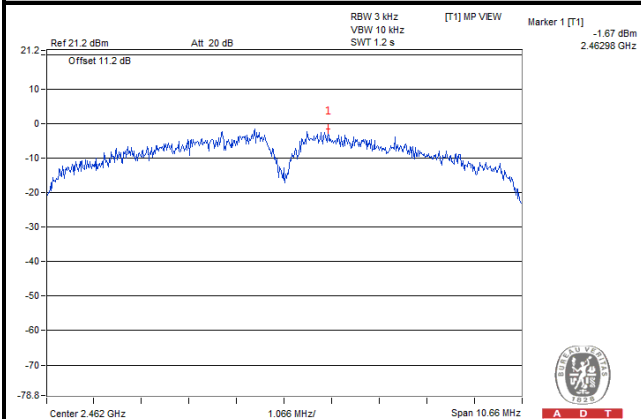

#### 802.11g

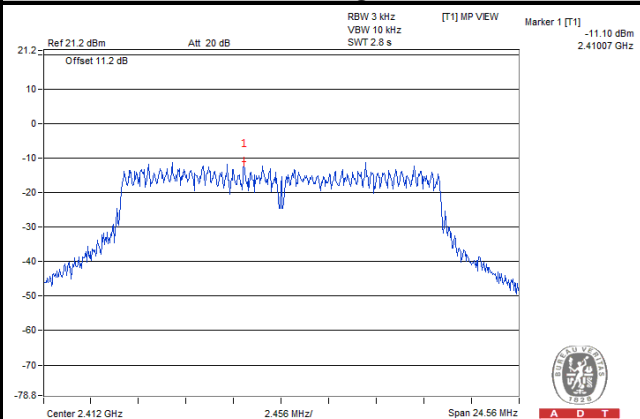

#### 802.11n (HT20)

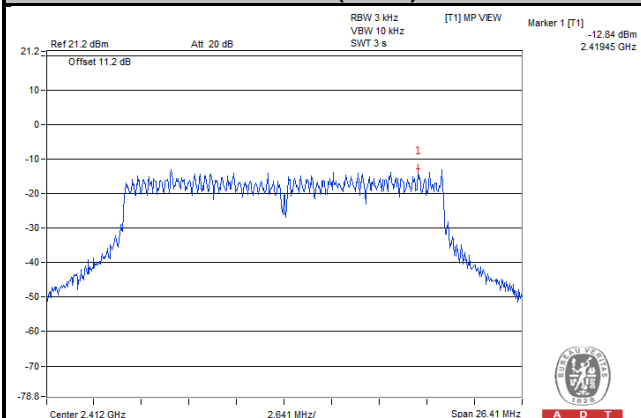

#### 802.11n (HT40)

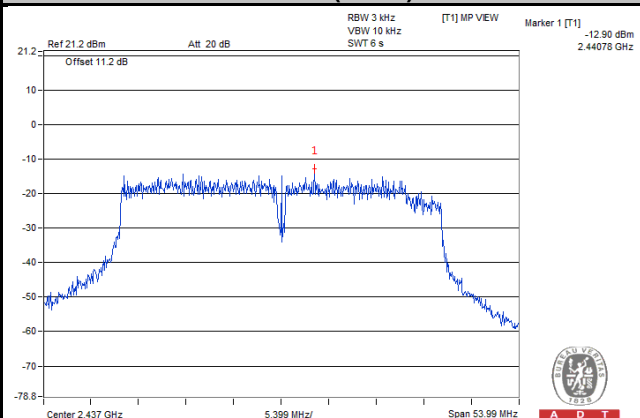

## 4.7 Conducted Out of Band Emission Measurement

### 4.7.1 Limits of Conducted Out of Band Emission Measurement

Below 20 dB of the highest emission level of operating band (in 100 kHz Resolution Bandwidth).

### 4.7.2 Test Setup

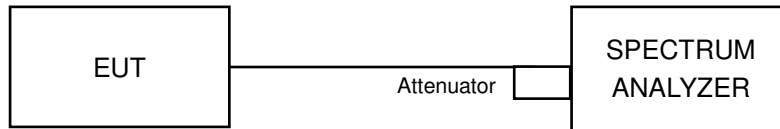

### 4.7.3 Test Instruments

Refer to section 4.1.2 to get information of above instrument.

### 4.7.4 Test Procedure

#### MEASUREMENT PROCEDURE REF

1. Set the RBW = 100 kHz.
2. Set the VBW  $\geq$  300 kHz.
3. Detector = peak.
4. Sweep time = auto couple.
5. Trace mode = max hold.
6. Allow trace to fully stabilize.
7. Use the peak marker function to determine the maximum power level in any 100 kHz band segment within the fundamental EBW.

#### MEASUREMENT PROCEDURE OOB

1. Set RBW = 100 kHz.
2. Set VBW  $\geq$  300 kHz.
3. Detector = peak.
4. Sweep = auto couple.
5. Trace Mode = max hold.
6. Allow trace to fully stabilize.
7. Use the peak marker function to determine the maximum amplitude level.

### 4.7.5 Deviation from Test Standard

No deviation.

### 4.7.6 EUT Operating Condition

The software provided by client to enable the EUT under transmission condition continuously at lowest, middle and highest channel frequencies individually.

### 4.7.7 Test Results

The conducted emission test is performed on each TX port of operating mode without summing or adding 10log (N) since the limit is relative emission limit.

The spectrum plots are attached on the following images. D1 line indicates the highest level, and D2 line indicates the 20 dB offset below D1. It shows compliance with the requirement.

#### 802.11b

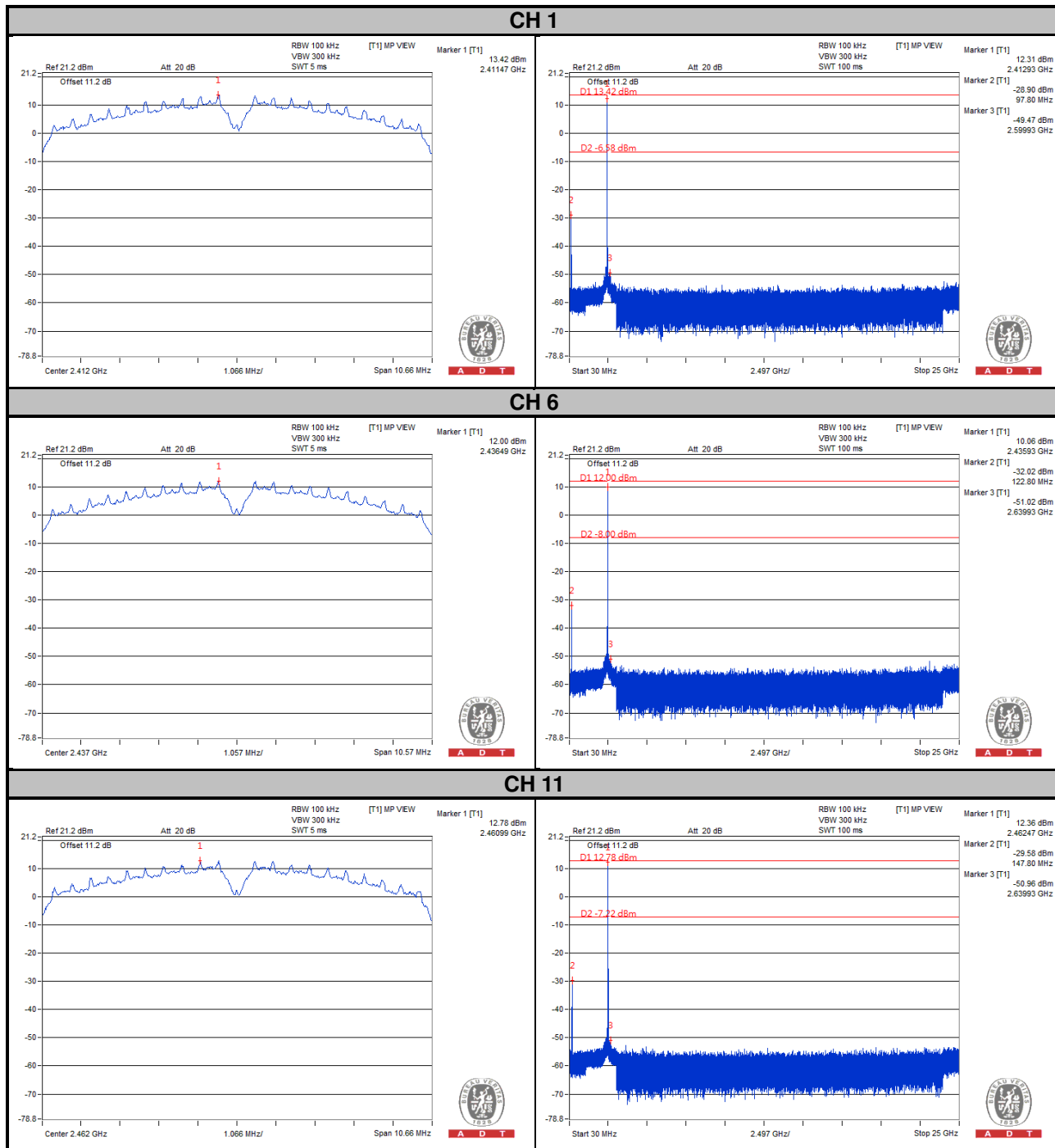

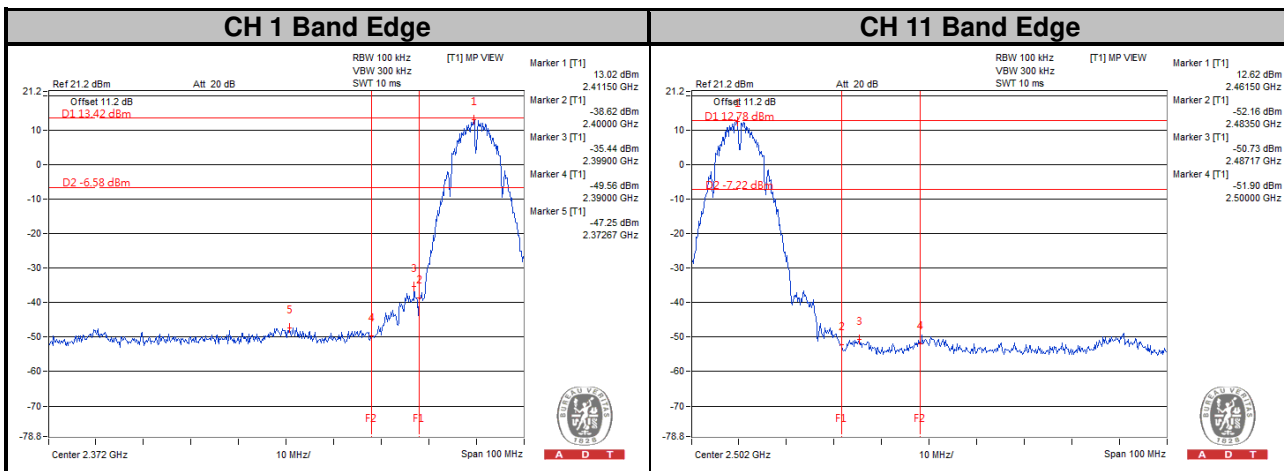

802.11g

CH 1

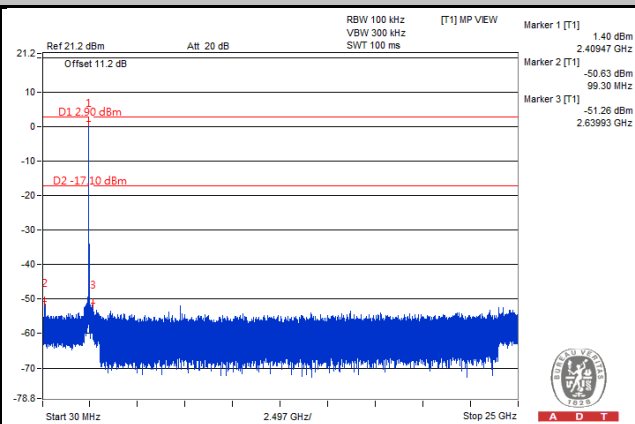
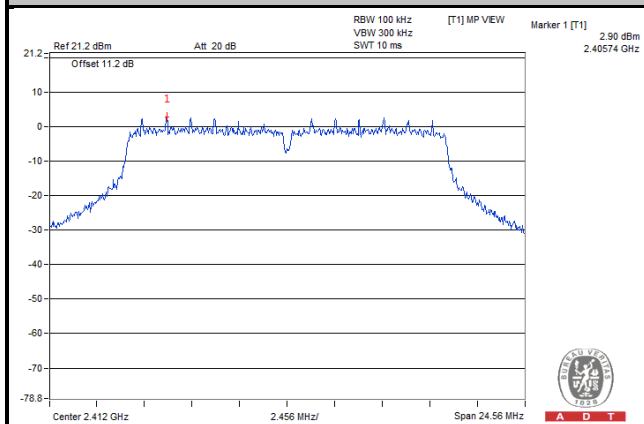

CH 6

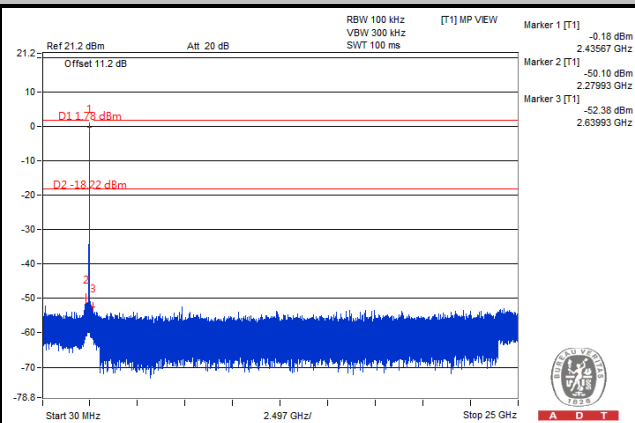
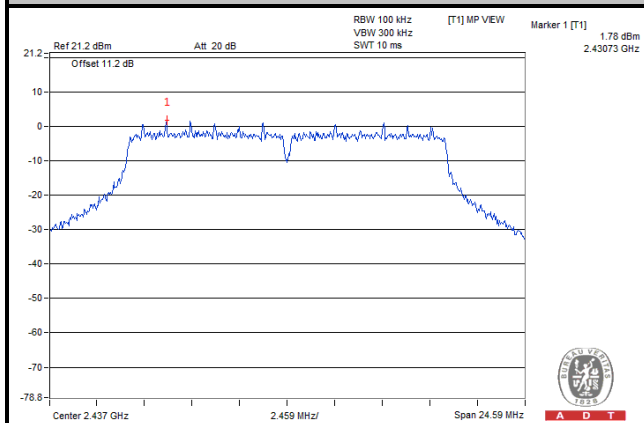

CH 11

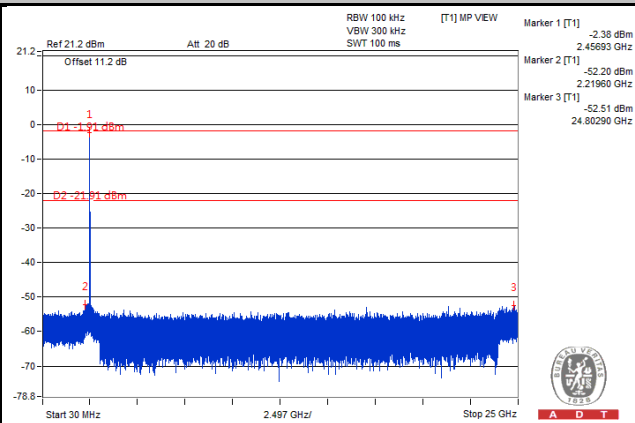
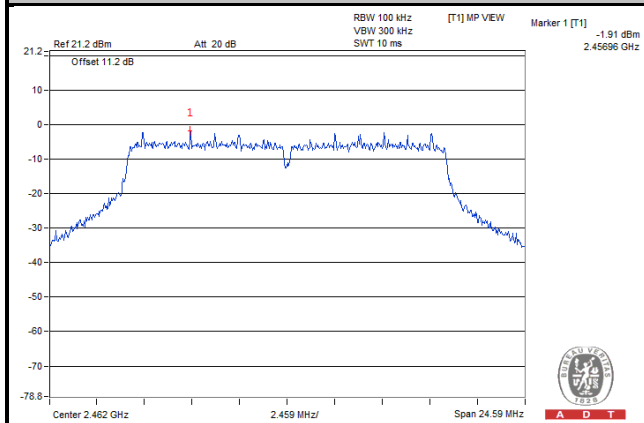



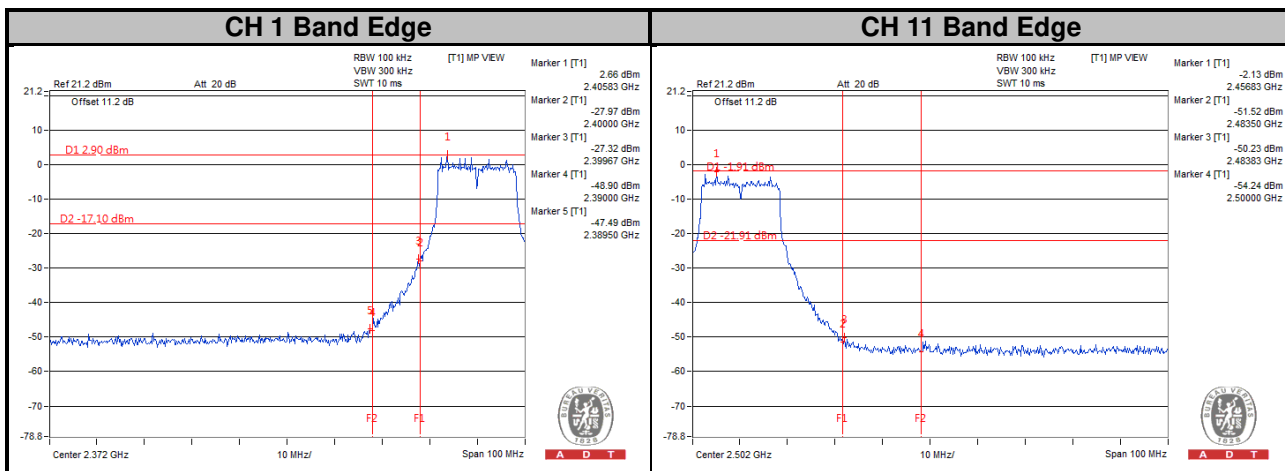

# 802.11n (20MHz)

1Tx

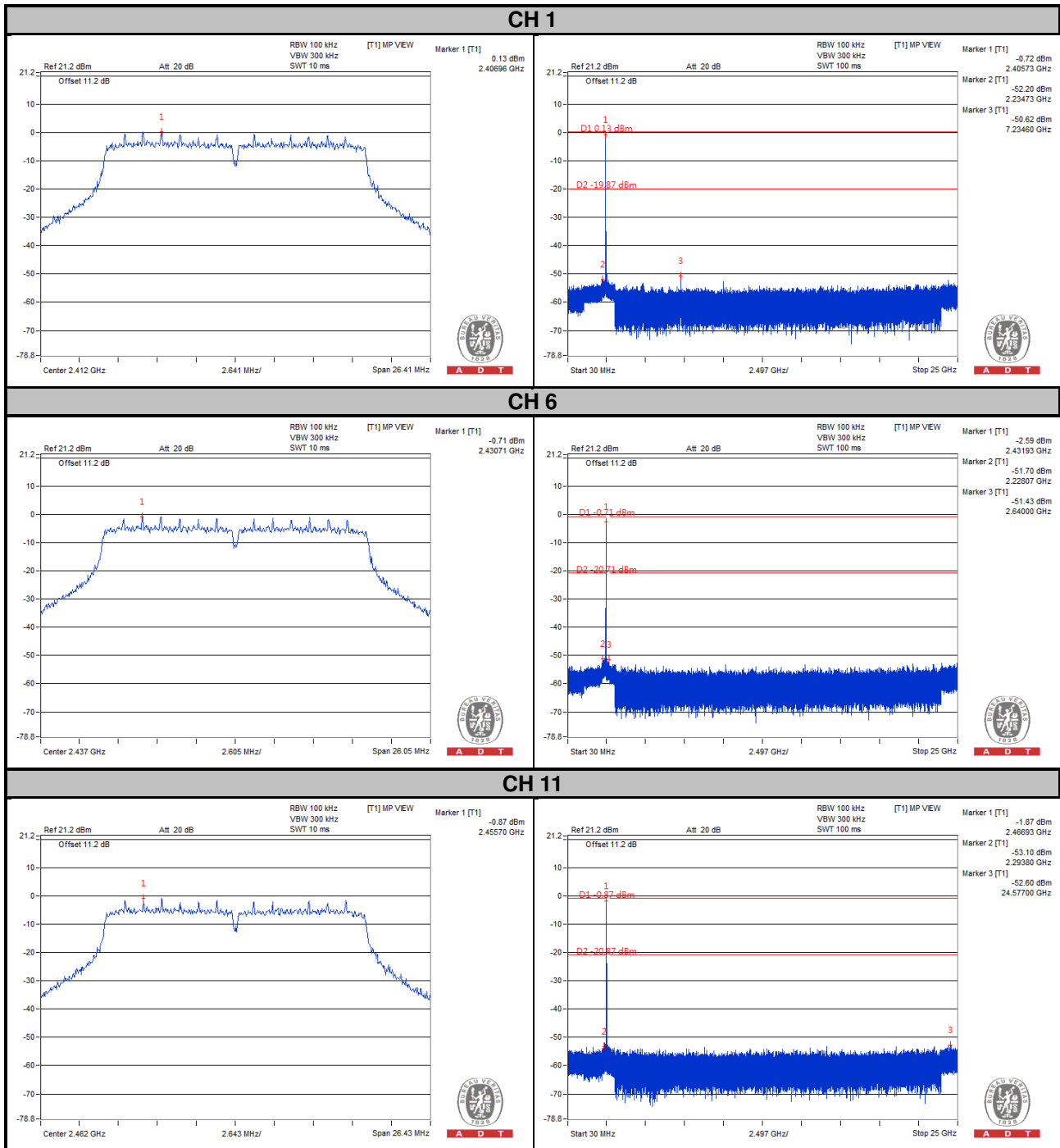

### CH 1 Band Edge

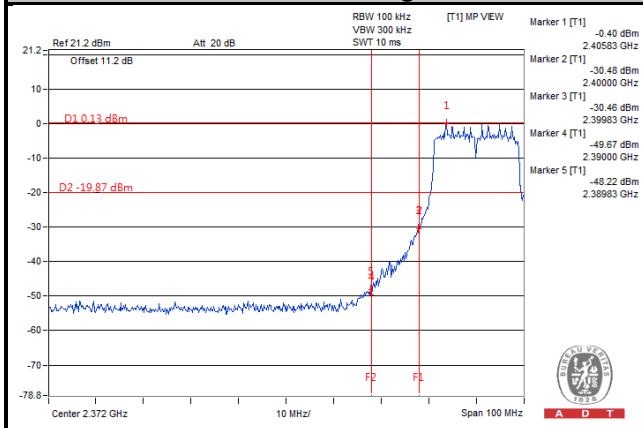

### CH 11 Band Edge

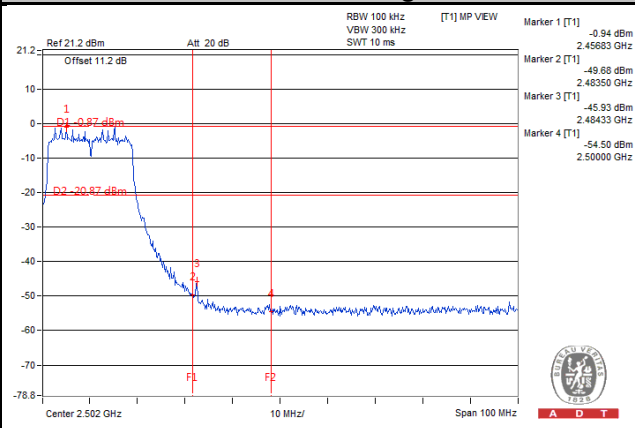

**2Tx**  
**CHAIN 0**

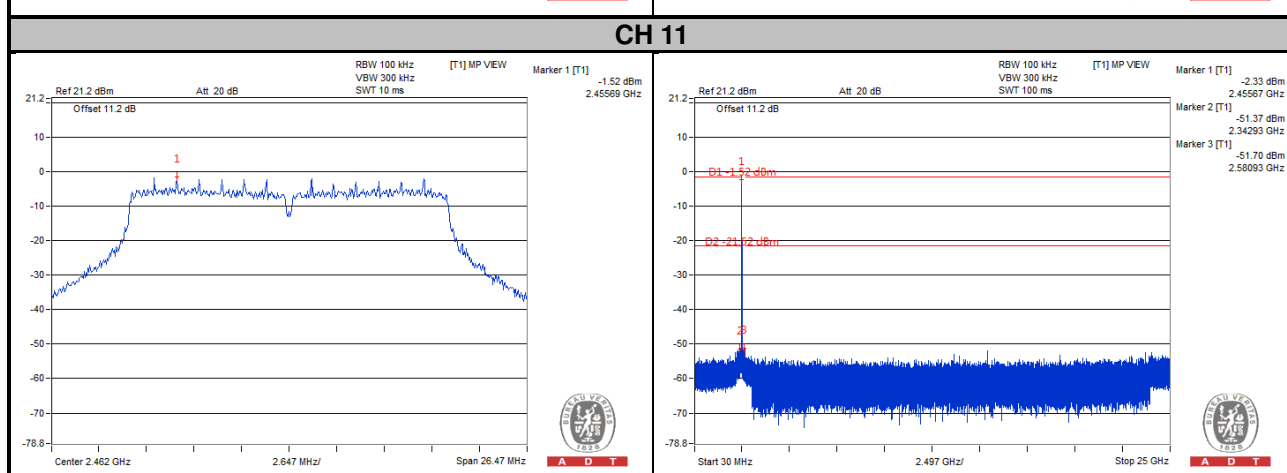
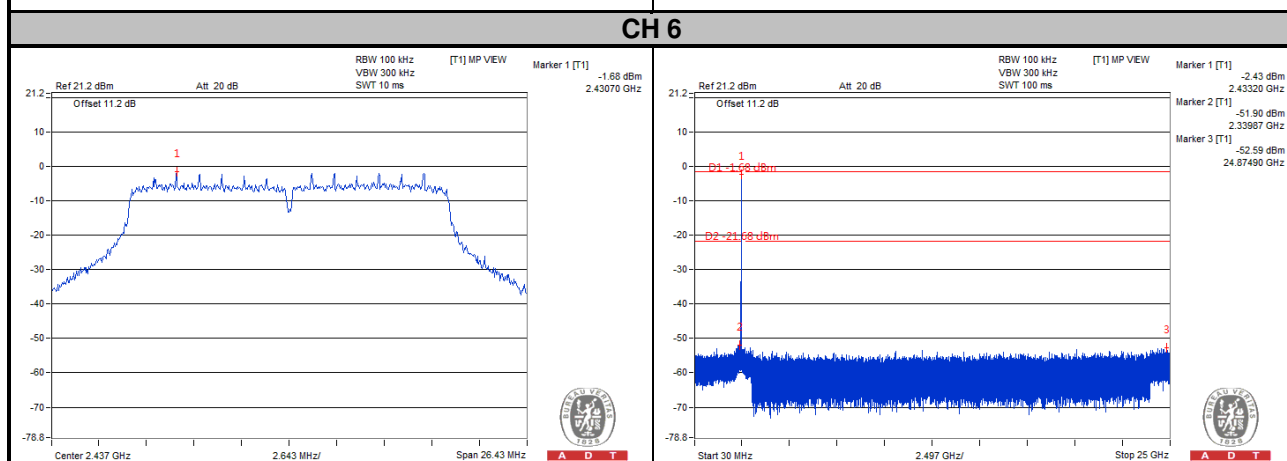
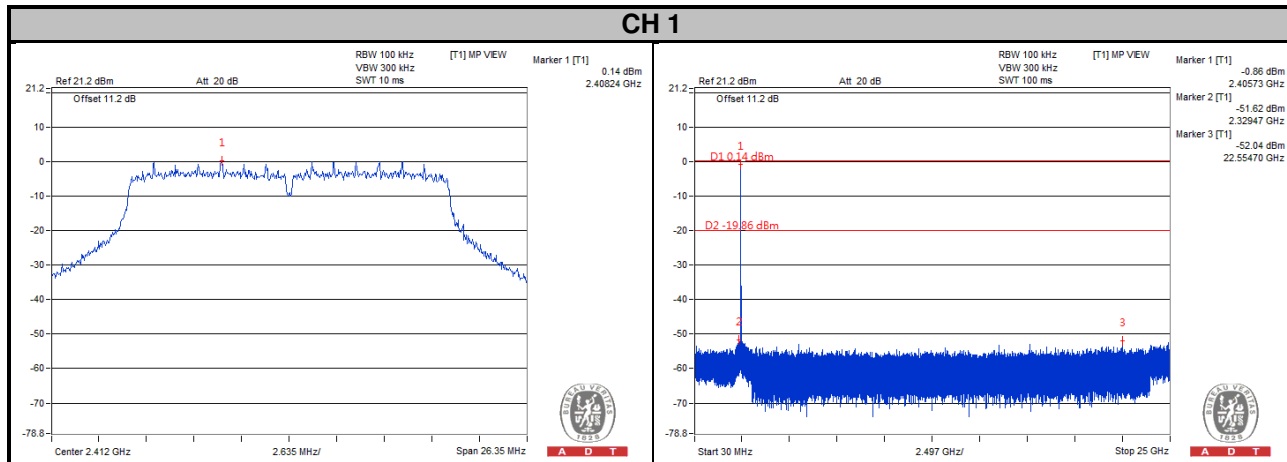

### CH 1 Band Edge

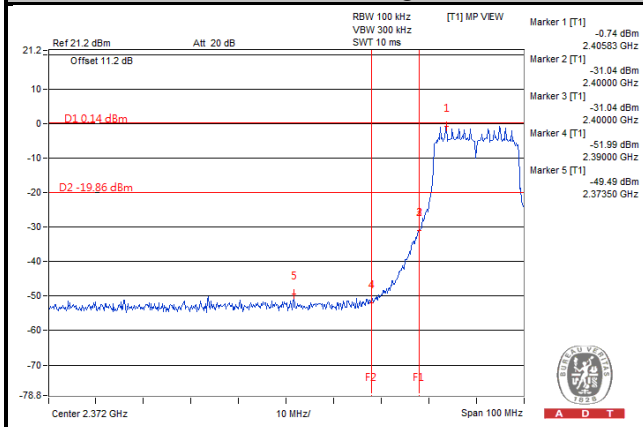

### CH 11 Band Edge

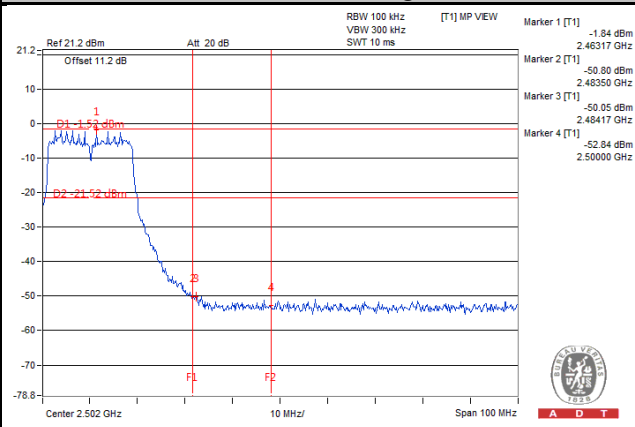

# CHAIN 1

## CH 1

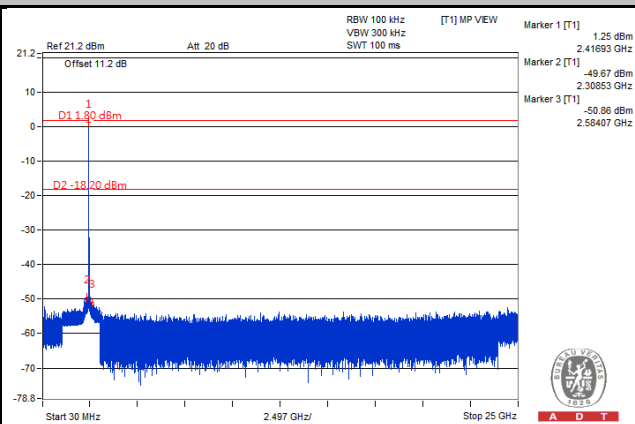
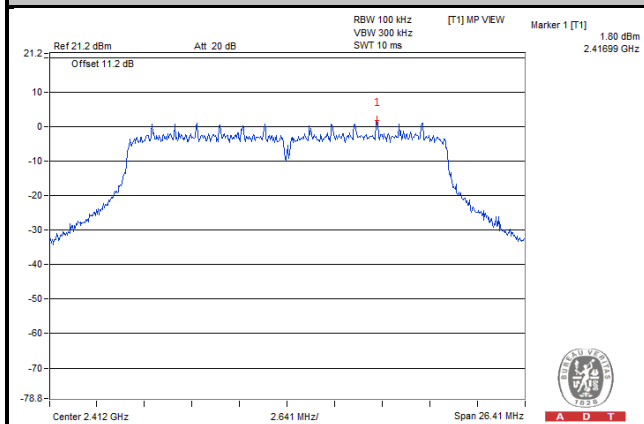

## CH 6

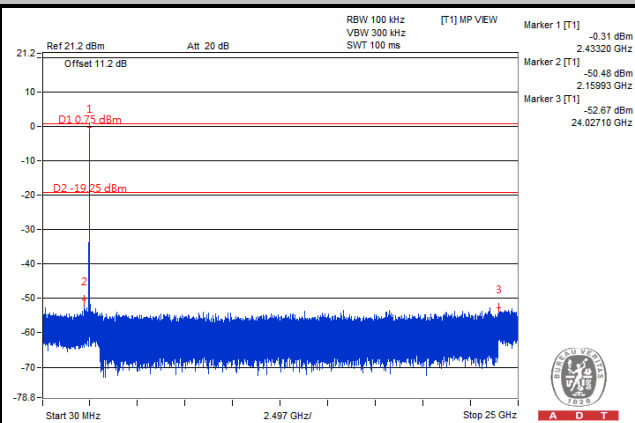
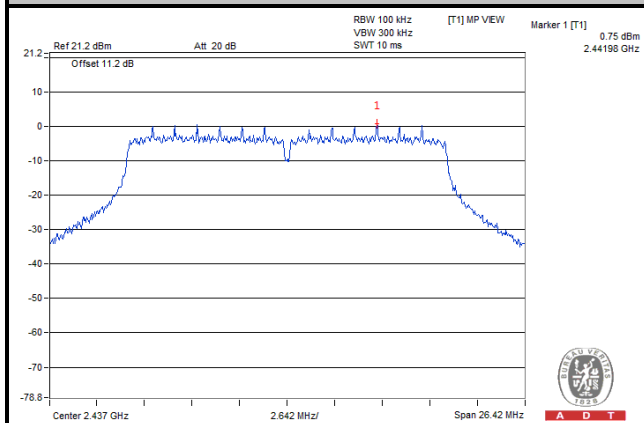

## CH 11

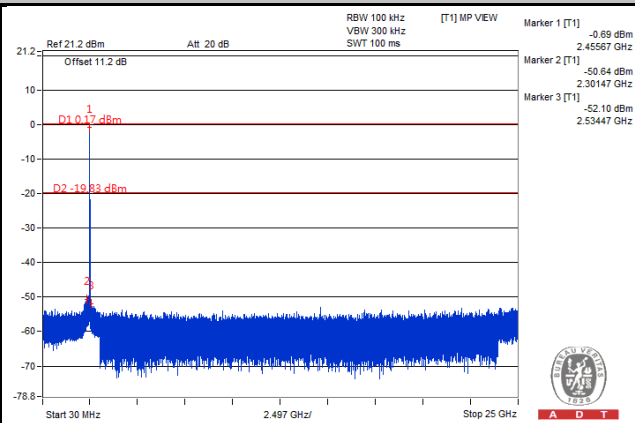
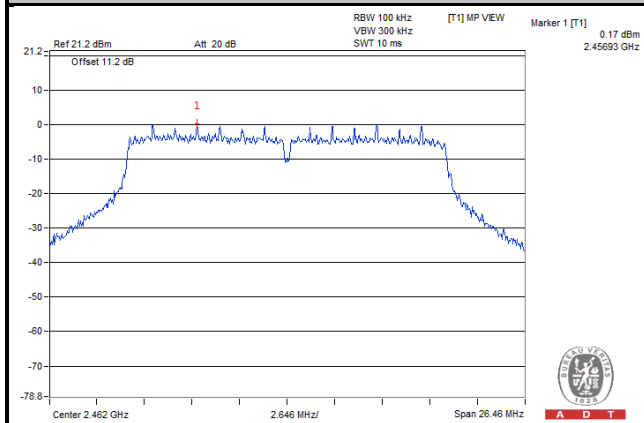

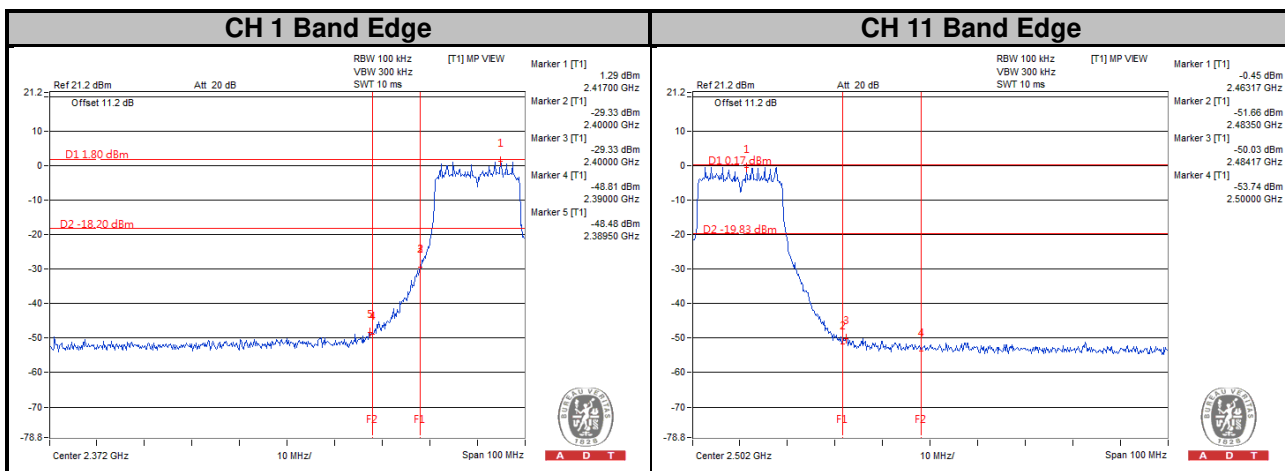

**3Tx**  
**CHAIN 0**

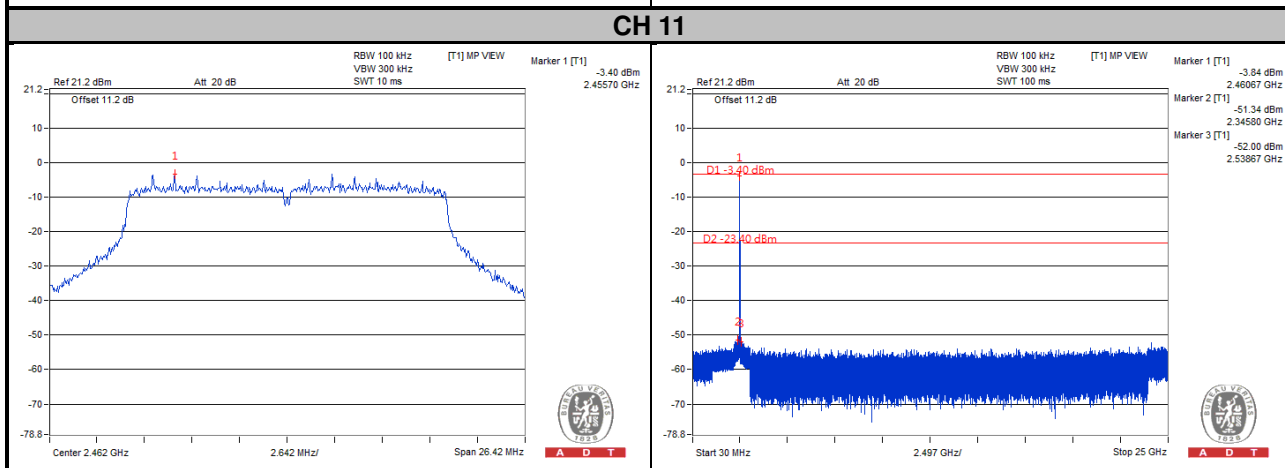
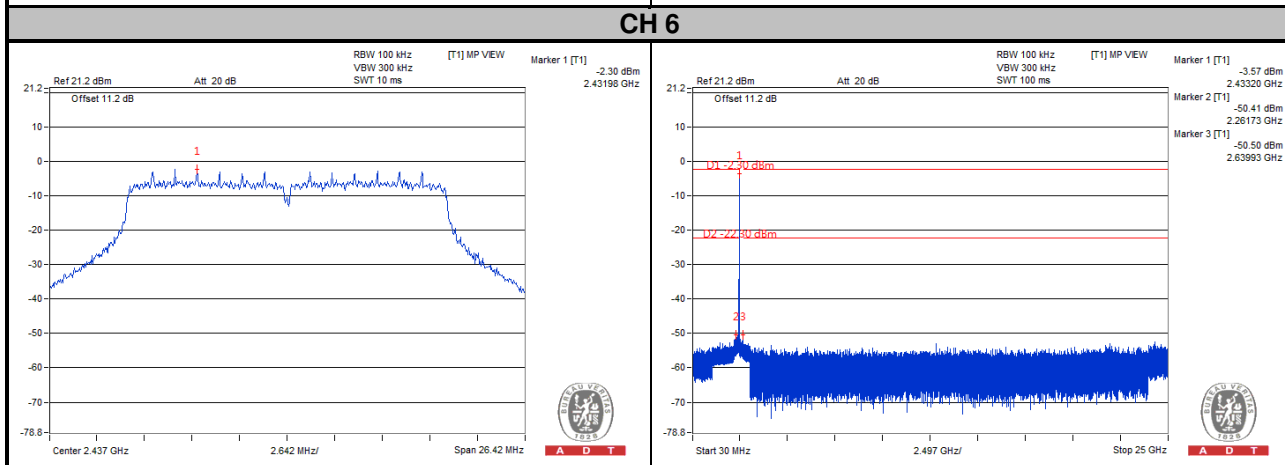
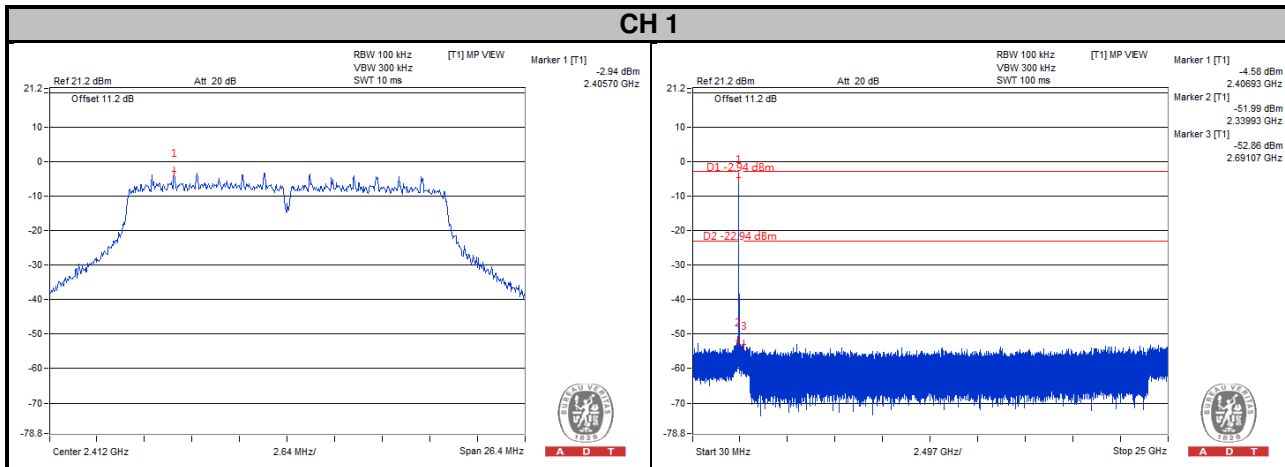



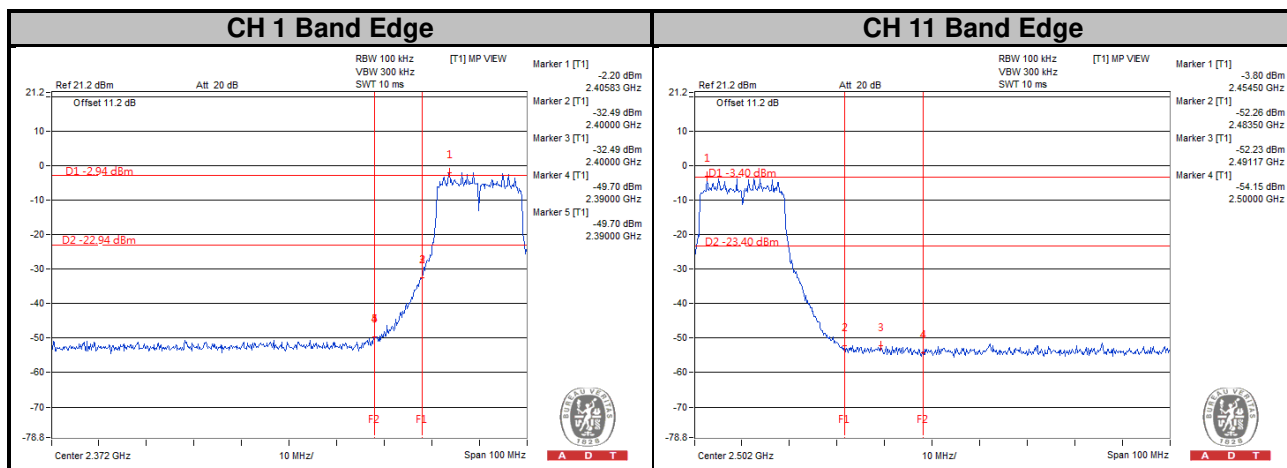

### CHAIN 1

#### CH 1

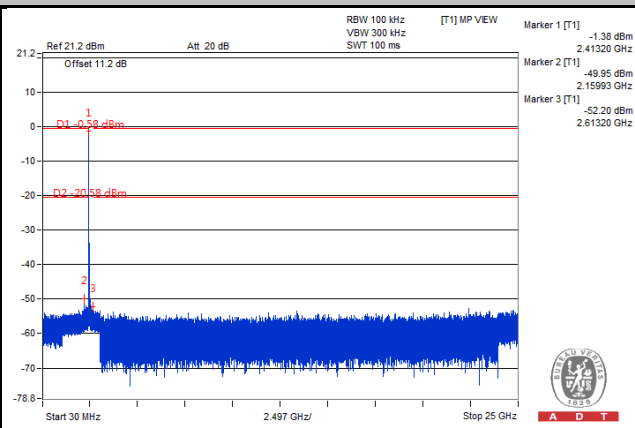
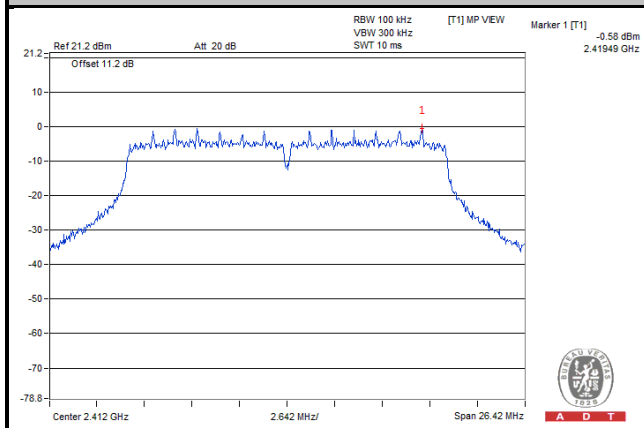

#### CH 6

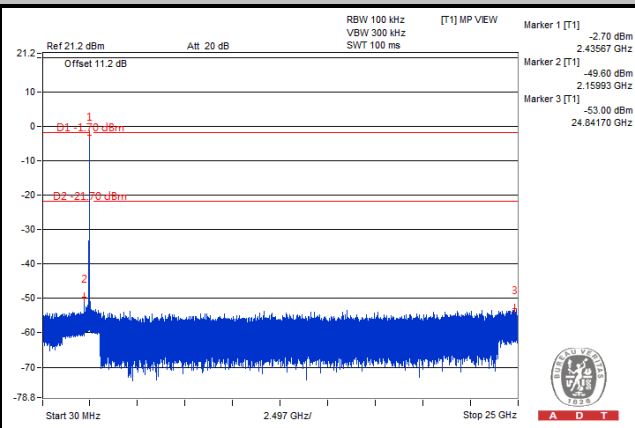
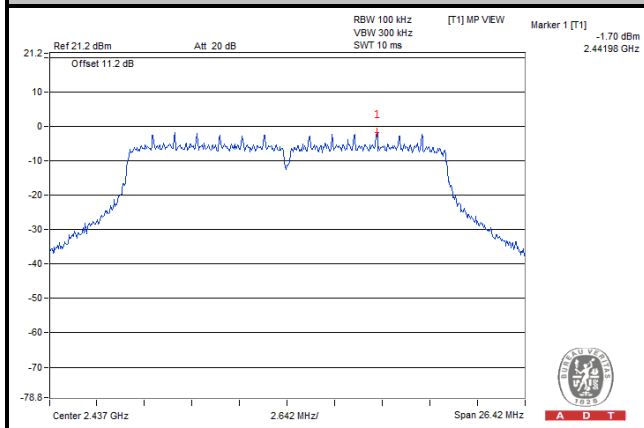

#### CH 11

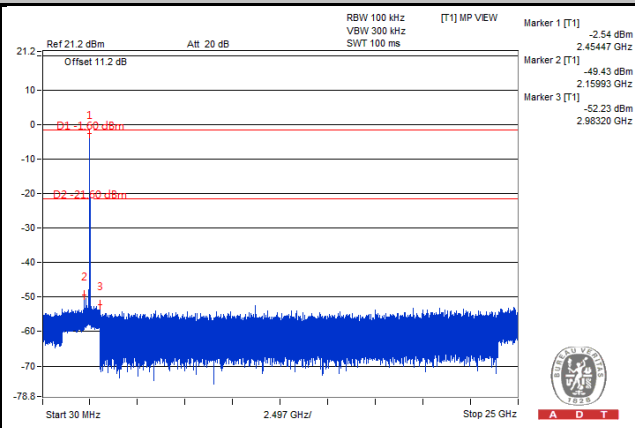
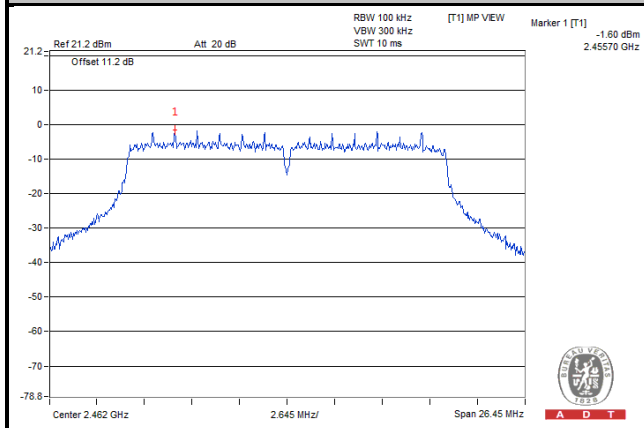

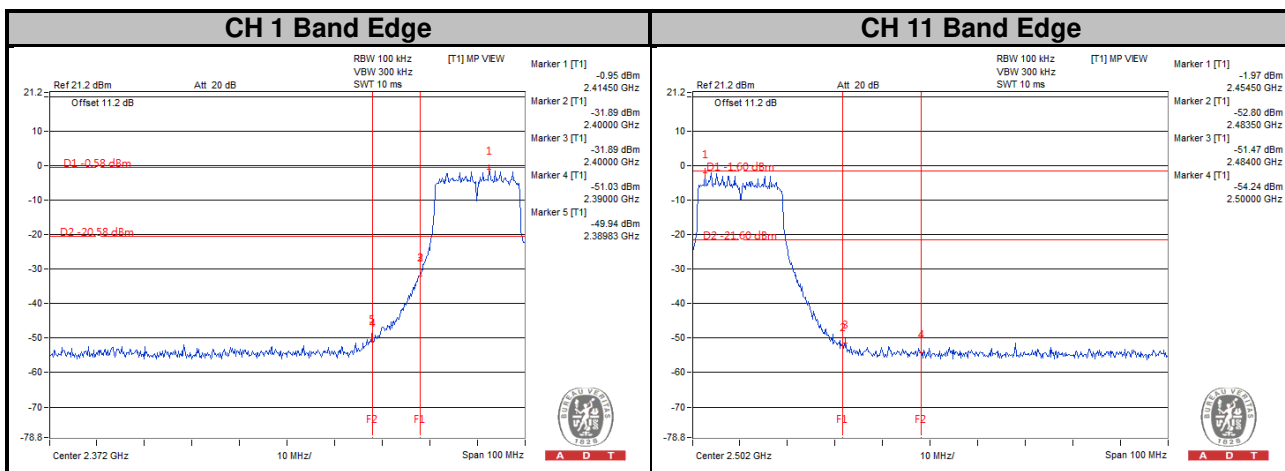

## CHAIN 2

### CH 1

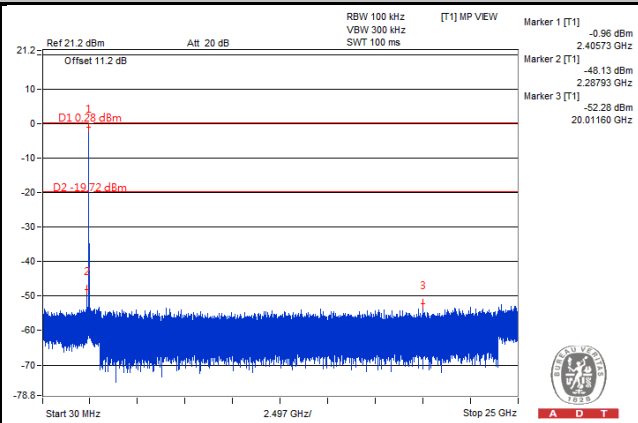
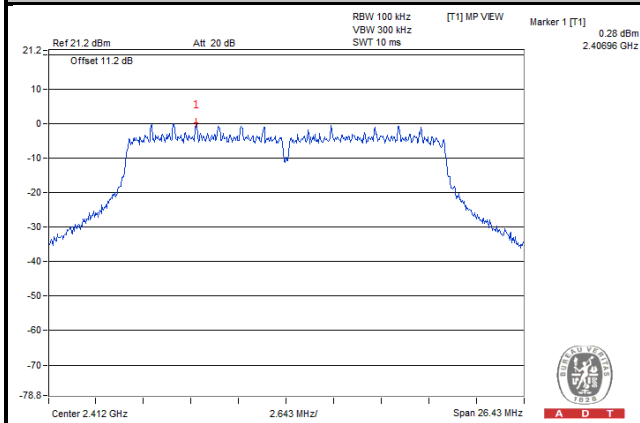

### CH 6

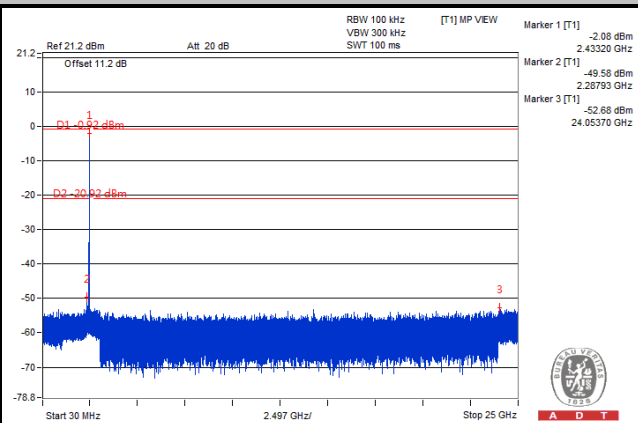
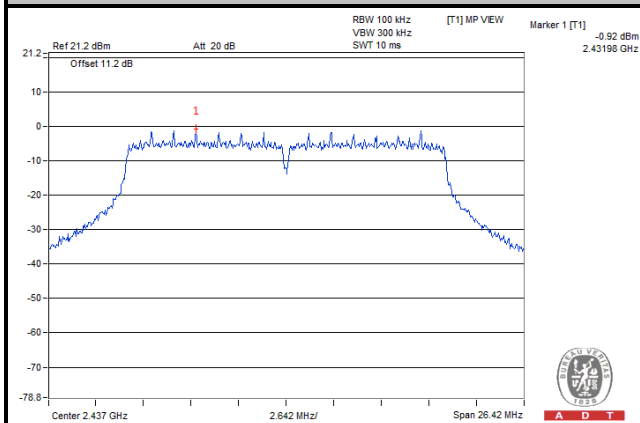

### CH 11

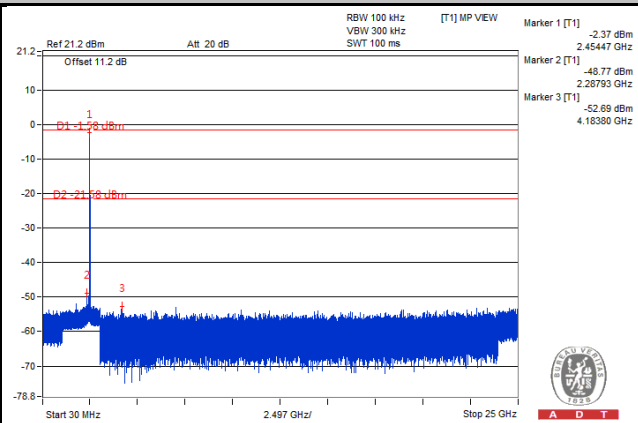
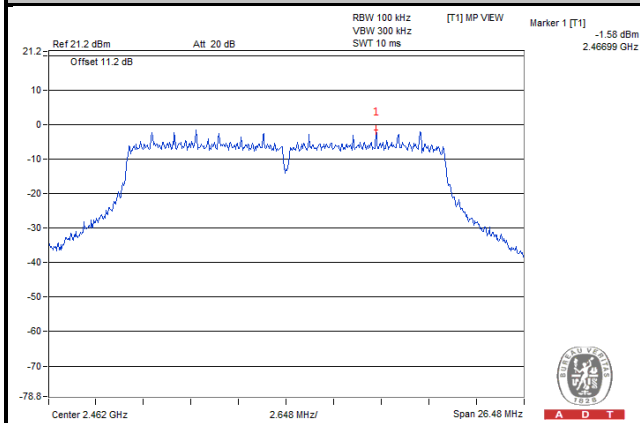

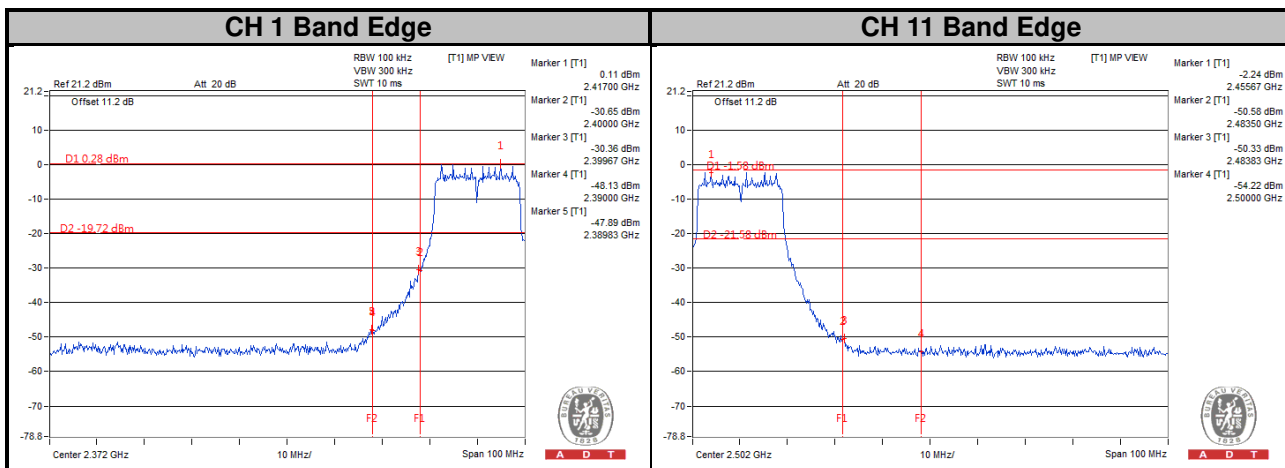

# 802.11n (40MHz) 1Tx

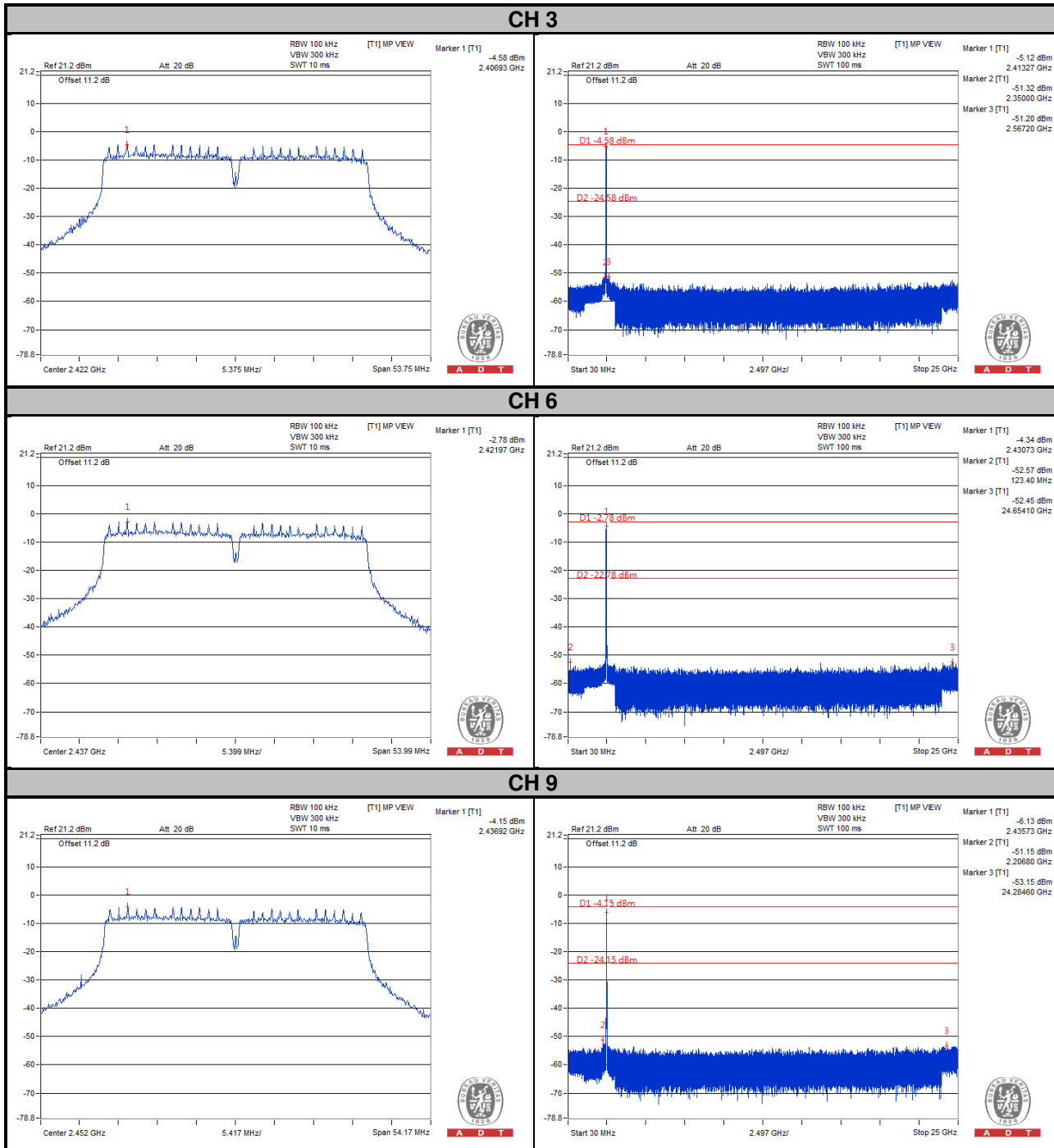

### CH 3 Band Edge

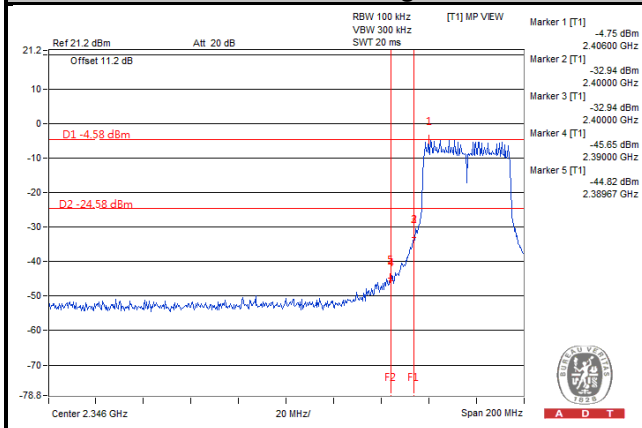

### CH 9 Band Edge

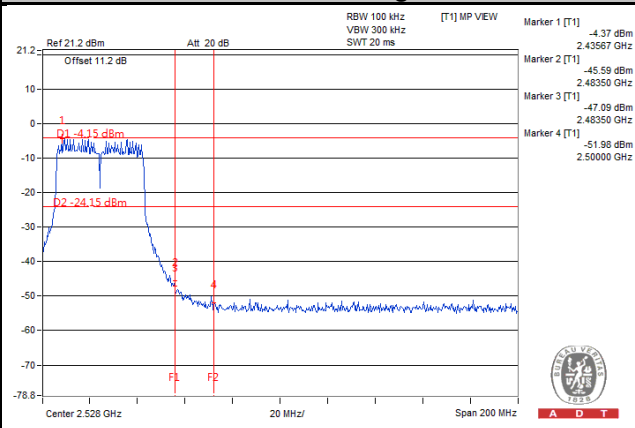

**2Tx**  
**CHAIN 0**

**CH 3**

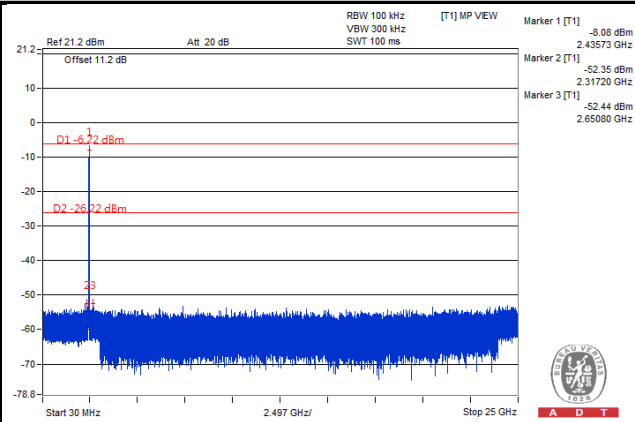
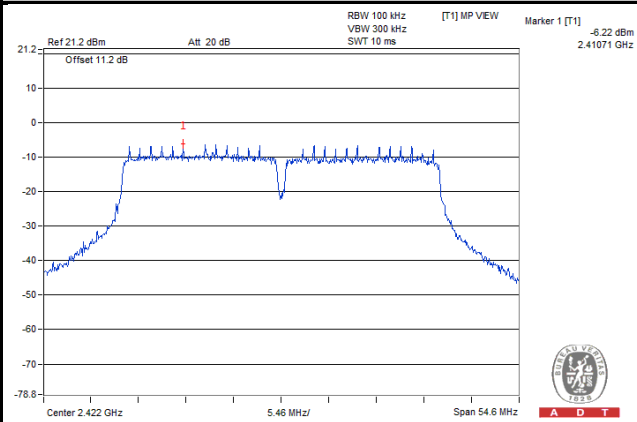

**CH 6**

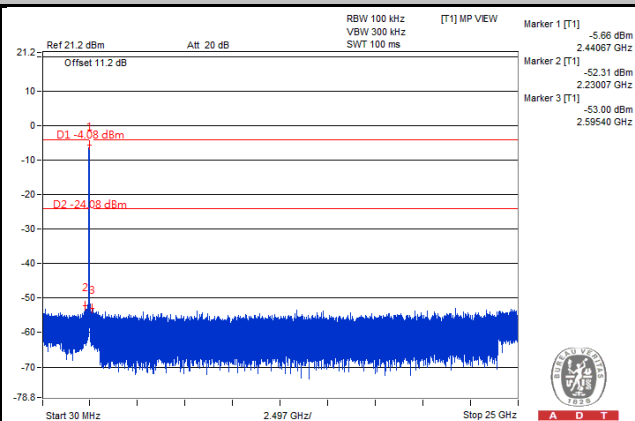
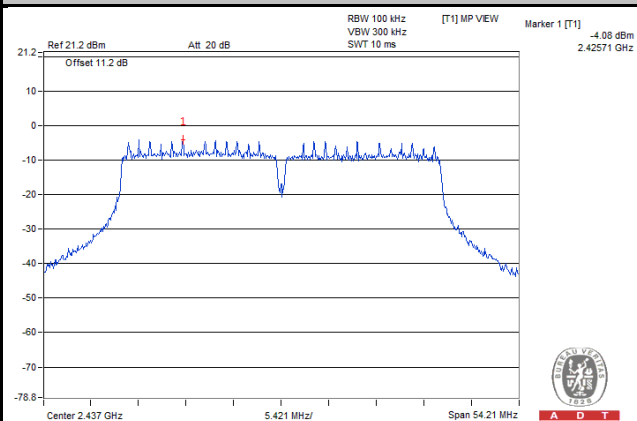

**CH 9**

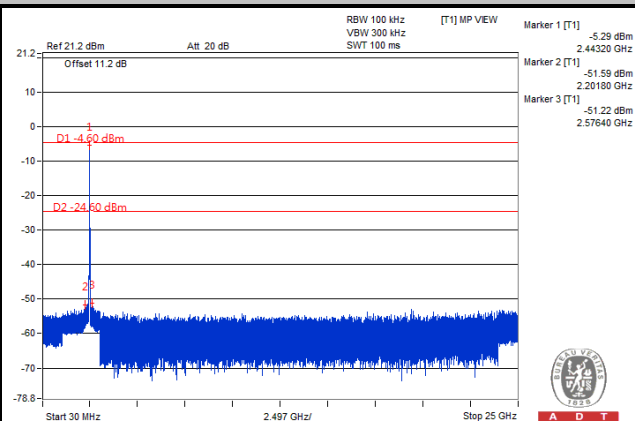
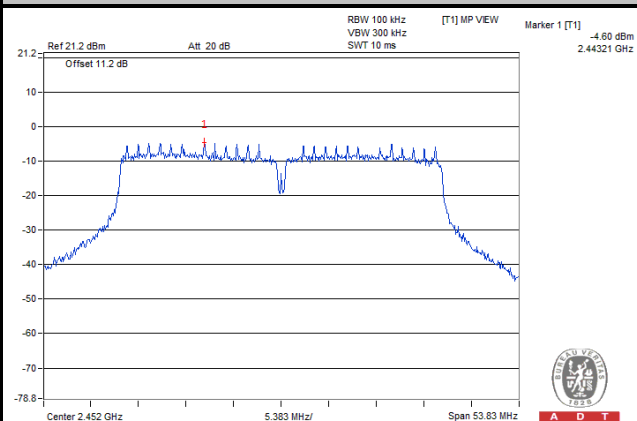



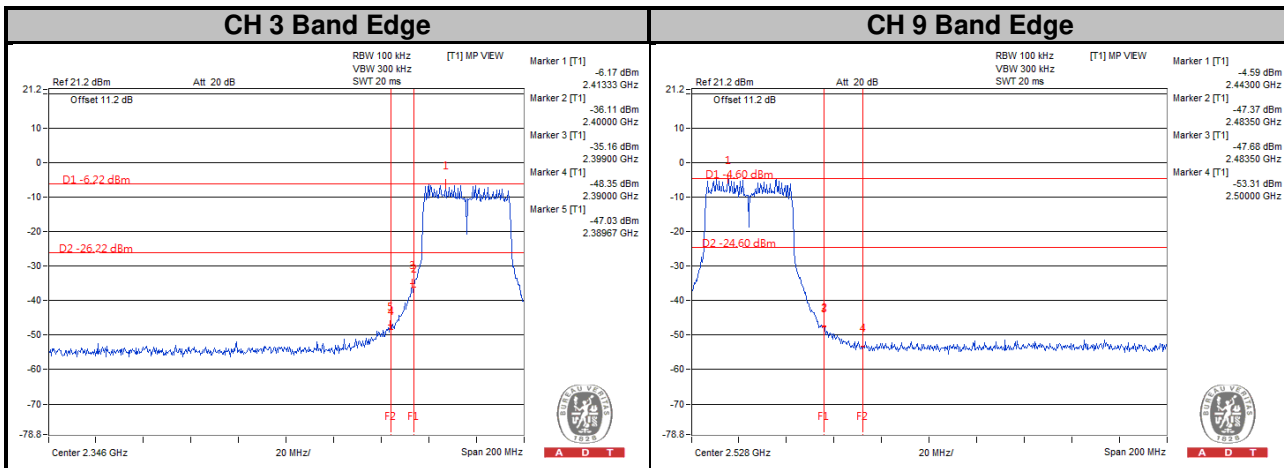

### CHAIN 1

#### CH 3

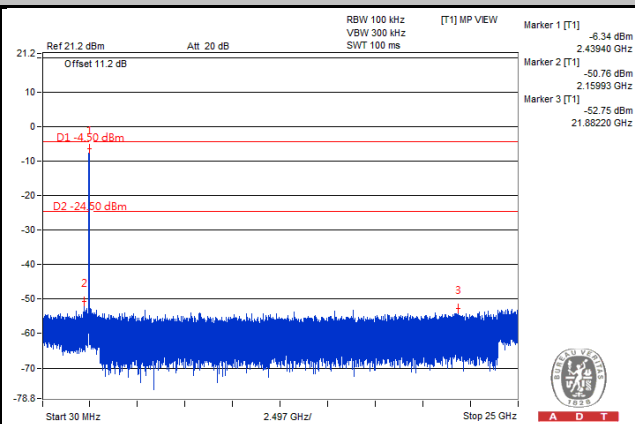
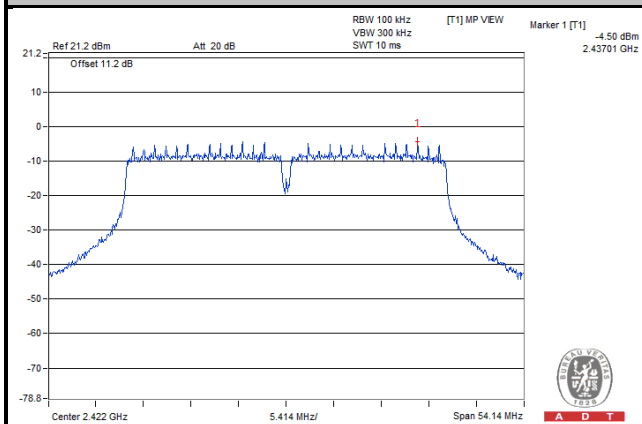

#### CH 6

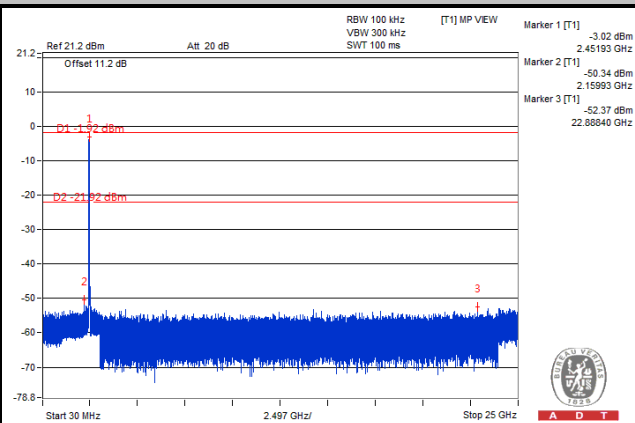
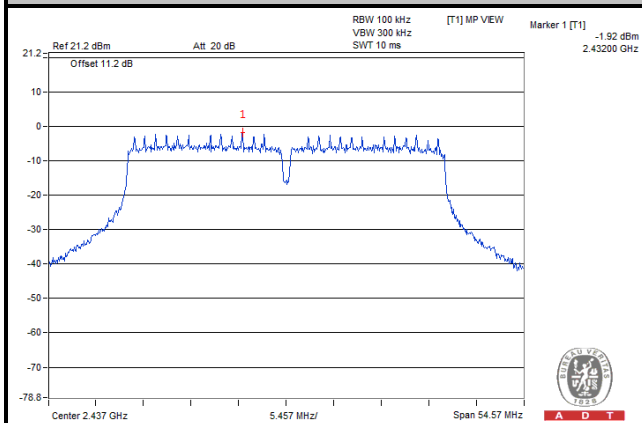

#### CH 9

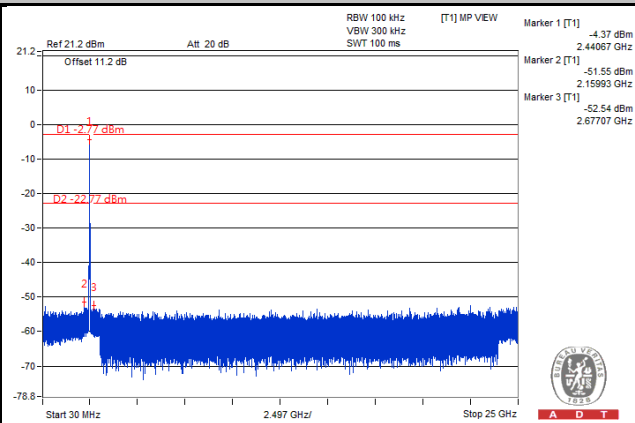
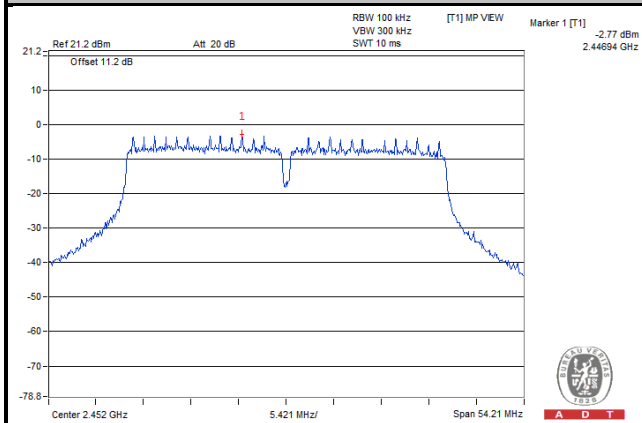

### CH 3 Band Edge

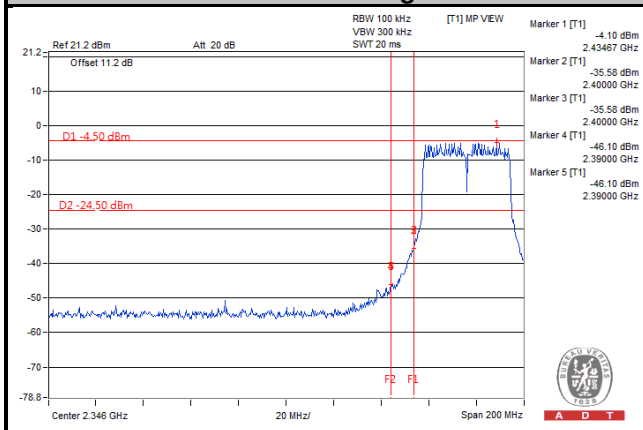

### CH 9 Band Edge

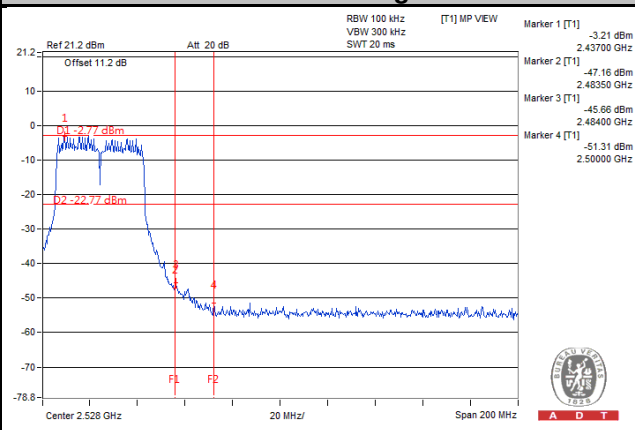

**3Tx**  
**CHAIN 0**

**CH 3**

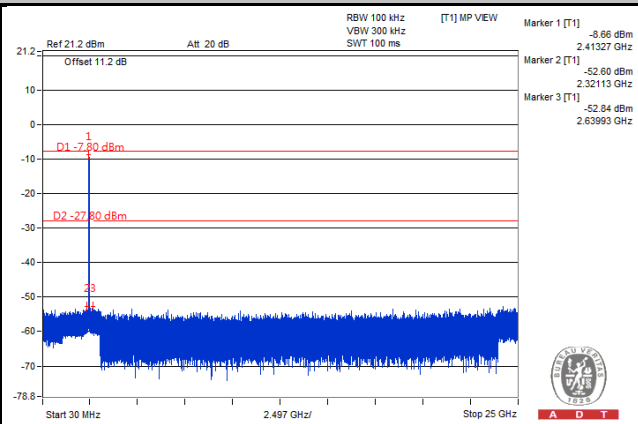
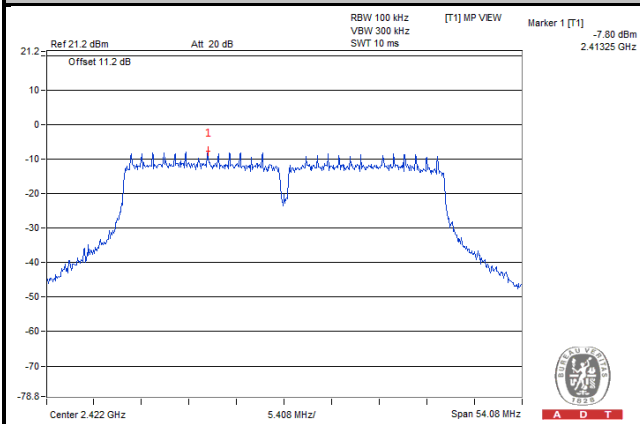

**CH 6**

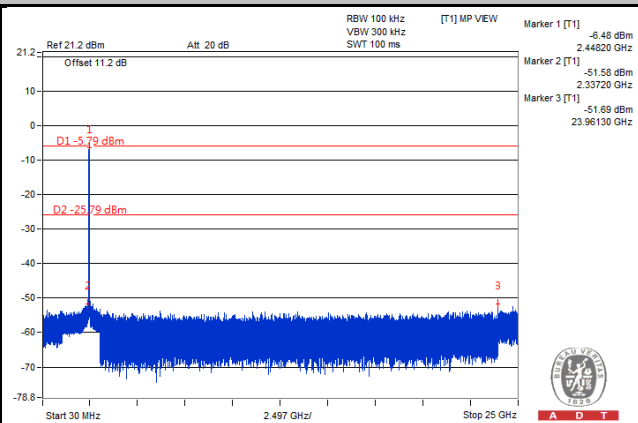
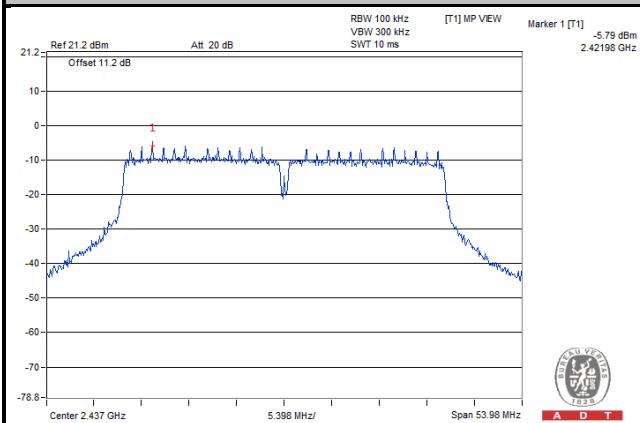

**CH 9**

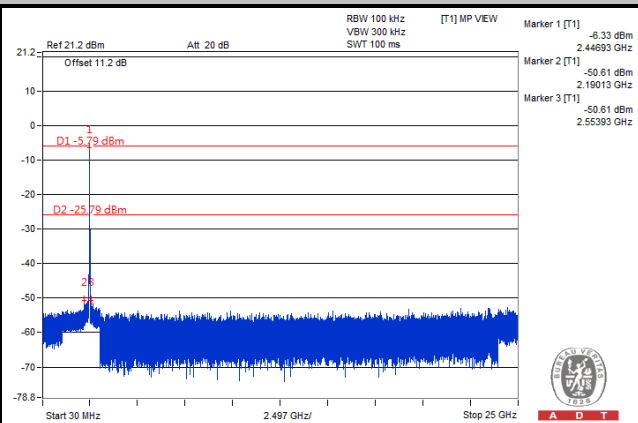
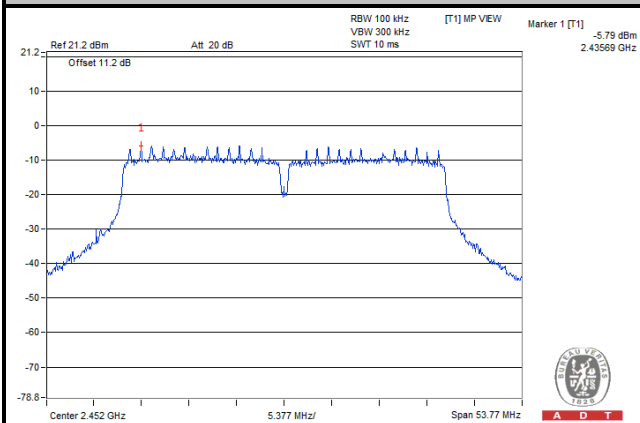

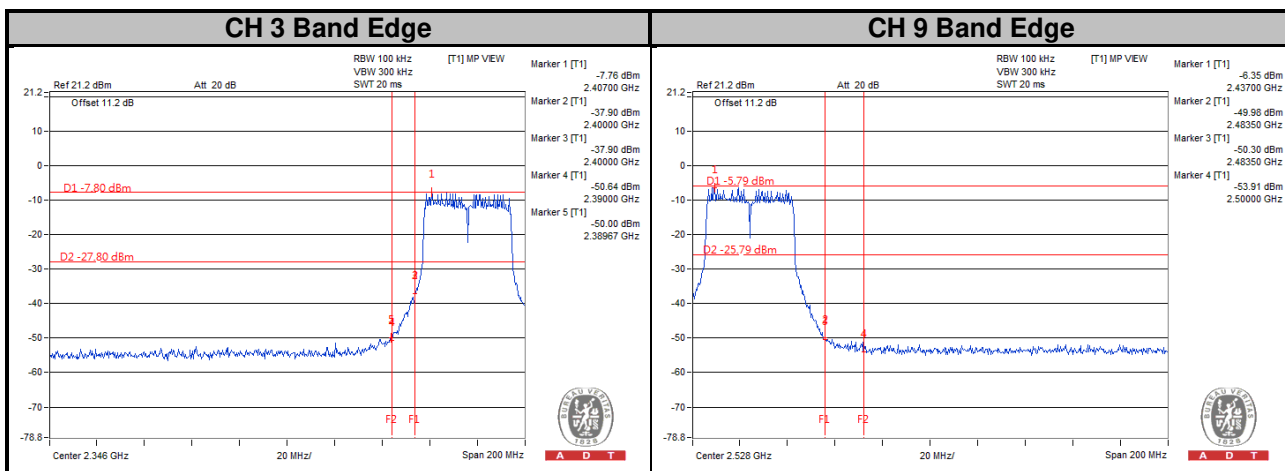

### CHAIN 1

### CH 3

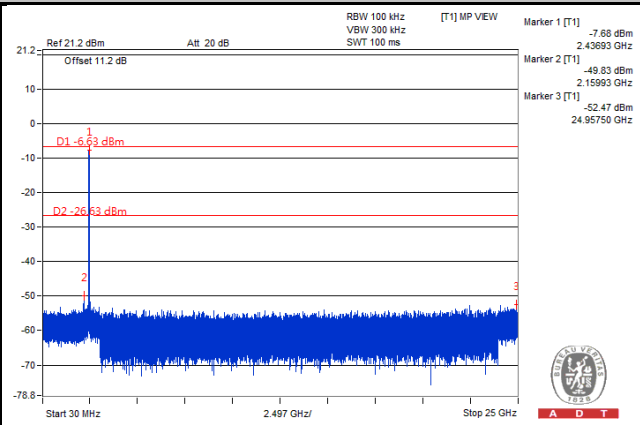
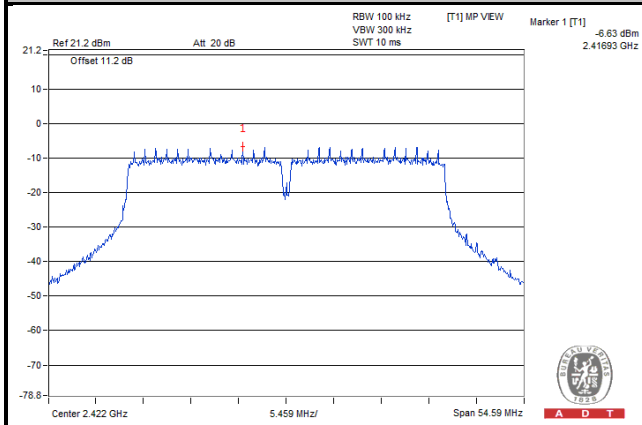

### CH 6

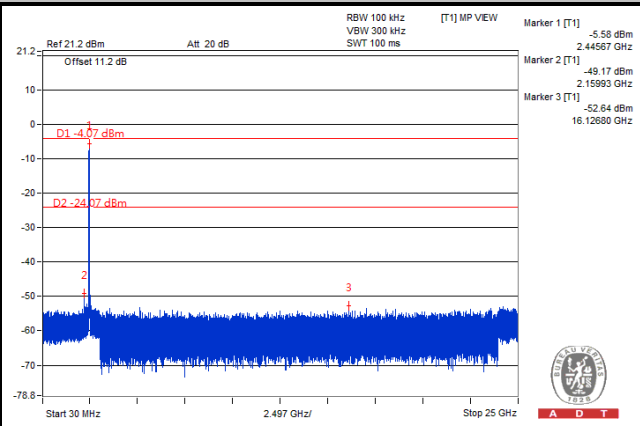
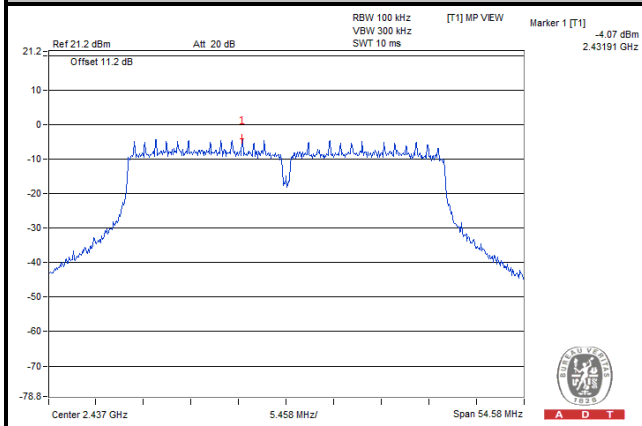

### CH 9

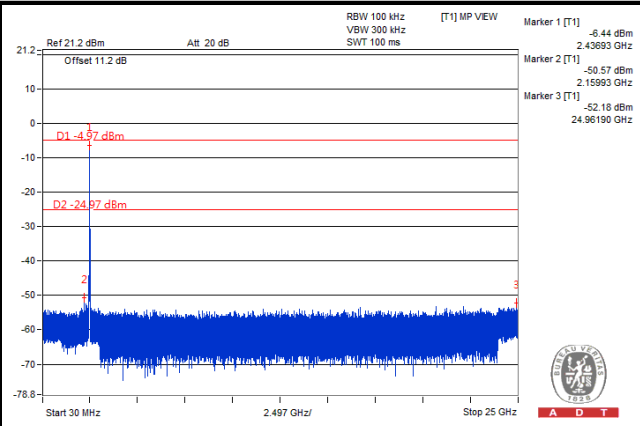
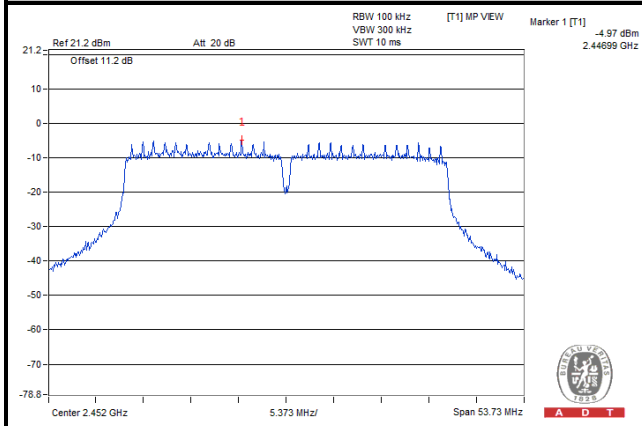

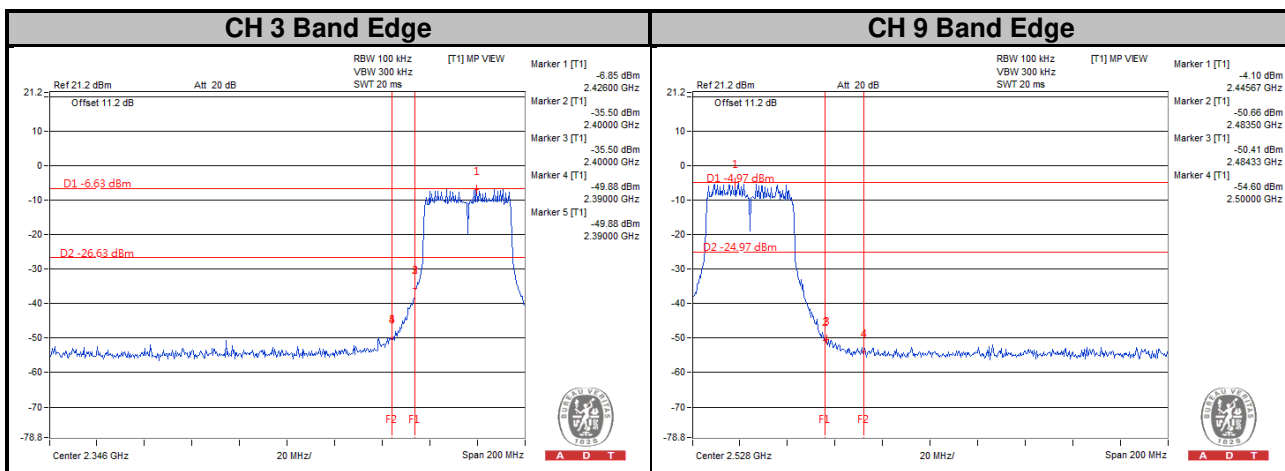

### CHAIN 2

### CH 3

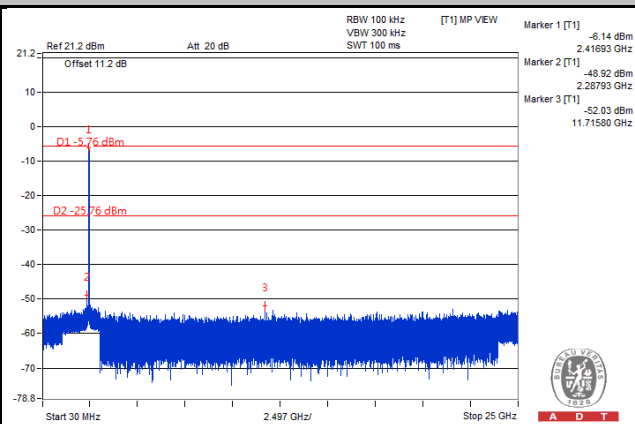
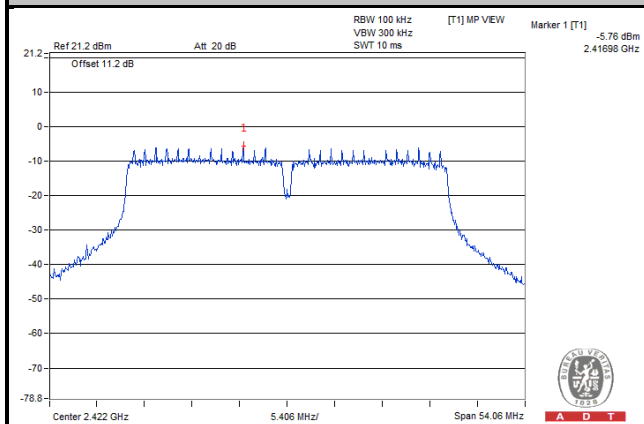

### CH 6

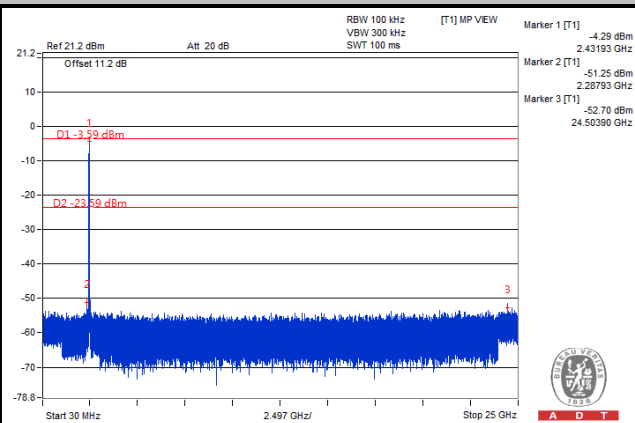
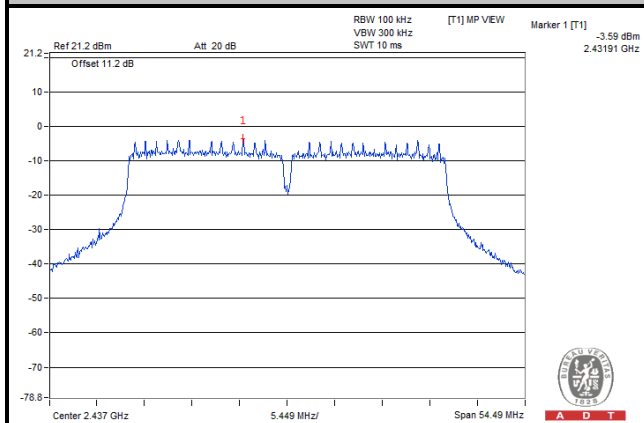

### CH 9

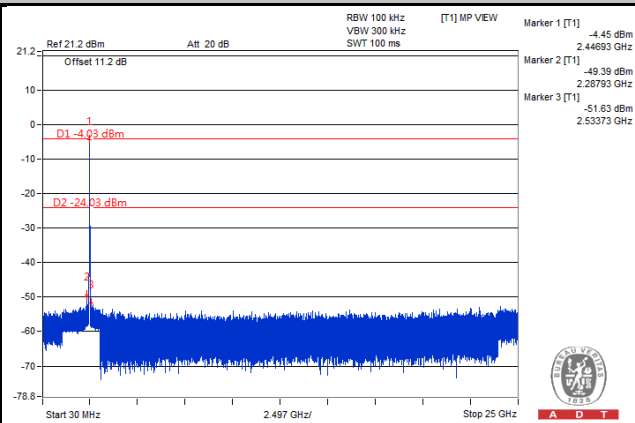
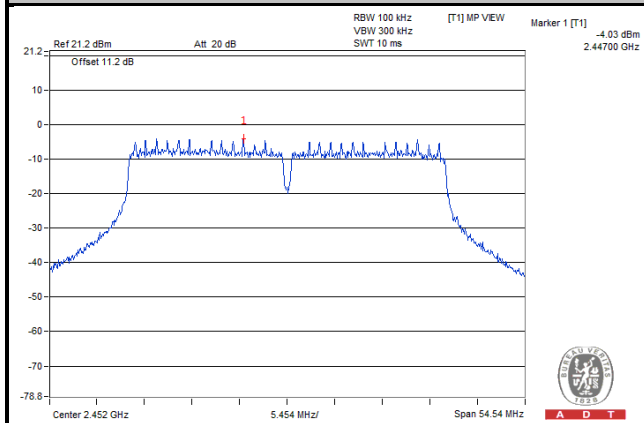



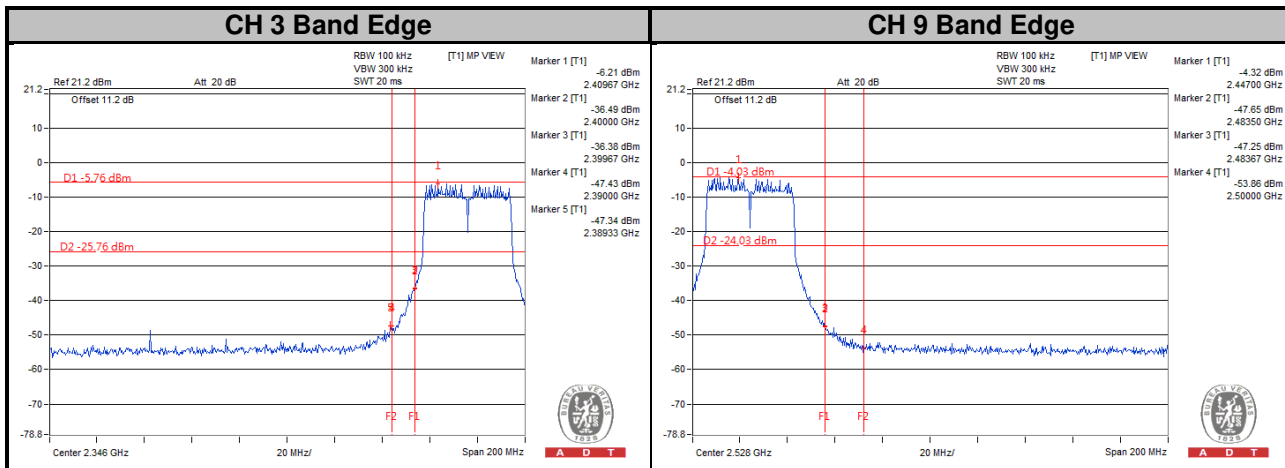

## 5 Pictures of Test Arrangements

Please refer to the attached file (Test Setup Photo).

## Appendix – Information on the Testing Laboratories

We, Bureau Veritas Consumer Products Services (H.K.) Ltd., Taoyuan Branch, were founded in 1988 to provide our best service in EMC, Radio, Telecom and Safety consultation. Our laboratories are FCC recognized accredited test firms and accredited according to ISO/IEC 17025.

If you have any comments, please feel free to contact us at the following:

**Linko EMC/RF Lab**

Tel: 886-2-26052180

Fax: 886-2-26051924

**Hsin Chu EMC/RF/Telecom Lab**

Tel: 886-3-6668565

Fax: 886-3-6668323

**Hwa Ya EMC/RF/Safety Lab**

Tel: 886-3-3183232

Fax: 886-3-3270892

**Email:** [service.adt@tw.bureauveritas.com](mailto:service.adt@tw.bureauveritas.com)

**Web Site:** [www.bureauveritas-adt.com](http://www.bureauveritas-adt.com)

The address and road map of all our labs can be found in our web site also.

--- END ---