

FCC Test Report

Report No.: RF171115C16-1

FCC ID: YZKECWO5210L

Test Model: ECWO5210-L

Received Date: Sep. 15, 2017

Test Date: Sep. 17, 2017 ~ Oct. 06, 2017

Issued Date: Nov. 16, 2017

Applicant: Edgecore Networks Corporation

Address: No. 1 Creation Rd. III, Hsinchu Science Park, Hsinchu 30077, Taiwan

Issued By: Bureau Veritas Consumer Products Services (H.K.) Ltd., Taoyuan Branch

Lab Address: No. 47-2, 14th Ling, Chia Pau Vil., Lin Kou Dist., New Taipei City, Taiwan
(R.O.C)

Test Location: No. 19, Hwa Ya 2nd Rd, Wen Hwa Tsuen, Kwei Shan Hsiang, Taoyuan
Hsien 333, Taiwan, R.O.C.

**FCC Registration /
Designation Number:** 788550 / TW0003



This report is for your exclusive use. Any copying or replication of this report to or for any other person or entity, or use of our name or trademark, is permitted only with our prior written permission. This report sets forth our findings solely with respect to the test samples identified herein. The results set forth in this report are not indicative or representative of the quality or characteristics of the lot from which a test sample was taken or any similar or identical product unless specifically and expressly noted. Our report includes all of the tests requested by you and the results thereof based upon the information that you provided to us. You have 60 days from date of issuance of this report to notify us of any material error or omission caused by our negligence, provided, however, that such notice shall be in writing and shall specifically address the issue you wish to raise. A failure to raise such issue within the prescribed time shall constitute your unqualified acceptance of the completeness of this report, the tests conducted and the correctness of the report contents. Unless specific mention, the uncertainty of measurement has been explicitly taken into account to declare the compliance or non-compliance to the specification. The report must not be used by the client to claim product certification, approval, or endorsement by TAF or any government agencies.

Table of Contents

Release Control Record	4
1 Certificate of Conformity	5
2 Summary of Test Results	6
2.1 Measurement Uncertainty	6
2.2 Modification Record	6
3 General Information	7
3.1 General Description of EUT	7
3.2 Description of Test Modes.....	8
3.2.1 Test Mode Applicability and Tested Channel Detail	9
3.3 Duty Cycle of Test Signal	11
3.4 Description of Support Units	14
3.4.1 Configuration of System under Test	14
3.5 General Description of Applied Standards.....	14
4 Test Types and Results	15
4.1 Radiated Emission and Bandedge Measurement	15
4.1.1 Limits of Radiated Emission and Bandedge Measurement	15
4.1.2 Limits of Unwanted Emission Out of the Restricted Bands	16
4.1.3 Test Instruments	17
4.1.4 Test Procedures.....	19
4.1.5 Deviation from Test Standard	19
4.1.6 Test Set Up	20
4.1.7 EUT Operating Conditions.....	21
4.1.8 Test Results	22
4.2 Conducted Emission Measurement.....	42
4.2.1 Limits of Conducted Emission Measurement	42
4.2.2 Test Instruments	42
4.2.3 Test Procedures.....	43
4.2.4 Deviation from Test Standard	43
4.2.5 Test Setup.....	43
4.2.6 EUT Operating Conditions.....	43
4.2.7 Test Results	44
4.3 Transmit Power Measurement.....	46
4.3.1 Limits of Transmit Power Measurement	46
4.3.2 Test Setup.....	46
4.3.3 Test Instruments	47
4.3.4 Test Procedure	47
4.3.5 Deviation from Test Standard	47
4.3.6 EUT Operating Conditions.....	47
4.3.7 Test Result	48
4.4 Occupied Bandwidth Measurement.....	54
4.4.1 Test Setup.....	54
4.4.2 Test Instruments	54
4.4.3 Test Procedure	54
4.4.4 Test Results	55
4.5 Peak Power Spectral Density Measurement	58
4.5.1 Limits of Peak Power Spectral Density Measurement	58
4.5.2 Test Setup.....	58
4.5.3 Test Instruments	58
4.5.4 Test Procedures.....	58
4.5.5 Deviation from Test Standard	59
4.5.6 EUT Operating Conditions.....	59
4.5.7 Test Results	60
4.6 Frequency Stability	69

4.6.1	Limit of Frequency Stability Measurement	69
4.6.2	Test Setup.....	69
4.6.3	Test Instruments	69
4.6.4	Test Procedure	69
4.6.5	Deviation from Test Standard	69
4.6.6	EUT Operating Condition	69
4.6.7	Test Results	70
4.7	6 dB Bandwidth Measurement.....	71
4.7.1	Limits of 6 dB Bandwidth Measurement.....	71
4.7.2	Test Setup.....	71
4.7.3	Test Instruments	71
4.7.4	Test Procedure	71
4.7.5	Deviation from Test Standard	71
4.7.6	EUT Operating Condition	71
4.7.7	Test Results	72
5	Pictures of Test Arrangements.....	75
	Annex A- Radiated Out of Band Emisison (OOBE) Measurement (For U-NII-3 band)	76
	Appendix – Information on the Testing Laboratories	79

Release Control Record

Issue No.	Description	Date Issued
RF171115C16-1	Original Release	Nov. 16, 2017

1 Certificate of Conformity

Product: Access Point

Brand: Edgecore

Test Model: ECWO5210-L

Sample Status: Production Unit

Applicant: Edgecore Networks Corporation

Test Date: Sep. 17, 2017 ~ Oct. 06, 2017

Standards: 47 CFR FCC Part 15, Subpart E (Section 15.407)
ANSI C63.10:2013

The above equipment has been tested by **Bureau Veritas Consumer Products Services (H.K.) Ltd., Taoyuan Branch**, and found compliance with the requirement of the above standards. The test record, data evaluation & Equipment Under Test (EUT) configurations represented herein are true and accurate accounts of the measurements of the sample's EMC characteristics under the conditions specified in this report.

Prepared by : Rona Chen, **Date:** Nov. 16, 2017
Rona Chen / Specialist

Approved by : Dylan Chiou, **Date:** Nov. 16, 2017
Dylan Chiou / Project Engineer

2 Summary of Test Results

47 CFR FCC Part 15, Subpart E (Section 15.407)			
FCC Clause	Test Item	Result	Remarks
15.407(b)(6)	AC Power Conducted Emissions	Pass	Meet the requirement of limit. Minimum passing margin is -12.15 dB at 0.42915 MHz.
15.407(b) (1/2/3/4(i/ii)/6)	Radiated Emissions & Band Edge Measurement	Pass	Meet the requirement of limit. Minimum passing margin is -1.15 dB at 5146 MHz.
15.407(a)(1/2/3)	Max Average Transmit Power	Pass	Meet the requirement of limit.
---	Occupied Bandwidth Measurement	-	Reference only
15.407(a)(1/2/3)	Peak Power Spectral Density	Pass	Meet the requirement of limit.
15.407(e)	6 dB Bandwidth	Pass	Meet the requirement of limit. (U-NII-3 Band only)
15.407(g)	Frequency Stability	Pass	Meet the requirement of limit.
15.203	Antenna Requirement	Pass	Refer to section 3.1 Note 2 of this report.

*For U-NII-3 band compliance with rule part 15.407(b)(4)(i), the OOB test plots were recorded in Annex A.

2.1 Measurement Uncertainty

Where relevant, the following measurement uncertainty levels have been estimated for tests performed on the EUT as specified in CISPR 16-4-2:

Measurement	Frequency	Expanded Uncertainty (k=2) (\pm)
Conducted Emissions at mains ports	150 kHz ~ 30 MHz	2.44 dB
Radiated Emissions up to 1 GHz	30 MHz ~ 200 MHz	2.93 dB
	200 MHz ~ 1000 MHz	2.95 dB
Radiated Emissions above 1 GHz	1 GHz ~ 18 GHz	2.26 dB
	18 GHz ~ 40 GHz	1.94 dB

2.2 Modification Record

There were no modifications required for compliance.

3 General Information

3.1 General Description of EUT

Product	Access Point
Brand	Edgecore
Test Model	ECWO5210-L
Status of EUT	Production Unit
Power Supply Rating	12.0Vdc (Adapter)
Modulation Type	256QAM, 64QAM, 16QAM, QPSK, BPSK
Modulation Technology	OFDM
Transfer Rate	802.11a: 54.0/ 48.0/ 36.0/ 24.0/ 18.0/ 12.0/ 9.0/ 6.0 Mbps 802.11n: up to MCS7 802.11ac: up to V9
Operating Frequency	5180 ~ 5240 MHz, 5745 ~ 5805 MHz
Number of Channel	5180 ~ 5240 MHz: 4 for 802.11a, 802.11n (HT20) 2 for 802.11n (HT40) 1 for 802.11ac (VHT80) 5745 ~ 5805 MHz: 4 for 802.11a, 802.11n (HT20) 2 for 802.11n (HT40) 1 for 802.11ac (VHT80)
Output Power	266.07 mW for 5180 ~ 5240 MHz 257.63 mW for 5745 ~ 5805 MHz
Antenna Type	Dipole antenna with 3.3 dBi gain (5180 ~ 5240 MHz) Dipole antenna with 5.01 dBi gain (5745 ~ 5805 MHz)
Antenna Connector	Refer to Note as below
Accessory Device	Refer to Note as below
Data Cable Supplied	Refer to Note as below

Note:

- The EUT incorporates a MIMO function. Physically, the EUT provides 3 completed transmitters and 3 receivers.

Modulation Mode	Tx Function
802.11a	1TX
802.11n (HT20)	3TX
802.11n (HT40)	3TX
802.11ac (VHT80)	3TX

* The modulation and bandwidth are similar for 802.11n mode for HT20 / HT40 and 802.11ac mode for HT20 / HT40, therefore investigated worst case to representative mode in test report. (Final test mode refer section 3.2.1)

- The EUT contains following accessory devices.

Product	Brand	Model	Description
Adapter	APD	WA-30B12	I/P: 100-240Vac, 0.8A O/P: 12Vdc, 2.5A
Antenna	Cortec	AN2450-5003BRS	--

- The above EUT information is declared by manufacturer and for more detailed features description, please refer to the manufacturer's specifications or user's manual.

3.2 Description of Test Modes

For 5180 ~ 5240 MHz

4 channels are provided for 802.11a, 802.11n (HT20):

Channel	Frequency (MHz)	Channel	Frequency (MHz)
36	5180	44	5220
40	5200	48	5240

2 channels are provided for 802.11n (HT40):

Channel	Frequency (MHz)	Channel	Frequency (MHz)
38	5190	46	5230

1 channel is provided for 802.11ac (VHT80):

Channel	Frequency (MHz)
42	5210

For 5745 ~ 5825 MHz:

4 channels are provided for 802.11a, 802.11n (HT20):

Channel	Frequency (MHz)	Channel	Frequency (MHz)
149	5745	157	5785
153	5765	161	5805

2 channels are provided for 802.11n (HT40):

Channel	Frequency (MHz)	Channel	Frequency (MHz)
151	5755	159	5795

1 channel is provided for 802.11ac (VHT80):

Channel	Frequency (MHz)
155	5775

3.2.1 Test Mode Applicability and Tested Channel Detail

EUT Configure Mode	Applicable To				Description
	RE \geq 1G	RE $<$ 1G	PLC	APCM	
-	√	√	√	√	-

Where **RE \geq 1G**: Radiated Emission above 1 GHz **RE $<$ 1G**: Radiated Emission below 1 GHz
PLC: Power Line Conducted Emission **APCM**: Antenna Port Conducted Measurement

Note:

1. The EUT had been pre-tested on the positioned of each 3 axis. The worst case was found when positioned on **Z-plane**.

Radiated Emission Test (Above 1 GHz):

Pre-Scan has been conducted to determine the worst-case mode from all possible combinations between available modulations, data rates and antenna ports (if EUT with antenna diversity architecture).

Following channel(s) was (were) selected for the final test as listed below.

EUT Configure Mode	Frequency Band (MHz)	Mode	Available Channel	Tested Channel	Modulation Technology	Modulation Type	Data Rate (Mbps)
-	5180-5240	802.11a	36 to 48	36, 44, 48	OFDM	BPSK	6.0
		802.11n (HT20)	36 to 48	36, 44, 48	OFDM	BPSK	MCS0
		802.11n (HT40)	38 to 46	38, 46	OFDM	BPSK	MCS0
		802.11ac (VHT80)	42	42	OFDM	BPSK	MCS0
-	5745-5805	802.11a	149 to 161	149, 157, 161	OFDM	BPSK	6.0
		802.11n (HT20)	149 to 161	149, 157, 161	OFDM	BPSK	MCS0
		802.11n (HT40)	151 to 159	151, 159	OFDM	BPSK	MCS0
		802.11ac (VHT80)	155	155	OFDM	BPSK	MCS0

Radiated Emission Test (Below 1 GHz):

Pre-Scan has been conducted to determine the worst-case mode from all possible combinations between available modulations, data rates and antenna ports (if EUT with antenna diversity architecture).

Following channel(s) was (were) selected for the final test as listed below.

EUT Configure Mode	Frequency Band (MHz)	Mode	Available Channel	Tested Channel	Modulation Technology	Modulation Type	Data Rate (Mbps)
-	5180-5240	802.11n (HT20)	36 to 48	36	OFDM	BPSK	MCS0
	5745-5805	802.11n (HT20)	149 to 165	165	OFDM	BPSK	MCS0

Power Line Conducted Emission Test:

Pre-Scan has been conducted to determine the worst-case mode from all possible combinations between available modulations, data rates and antenna ports (if EUT with antenna diversity architecture).

Following channel(s) was (were) selected for the final test as listed below.

EUT Configure Mode	Frequency Band (MHz)	Mode	Available Channel	Tested Channel	Modulation Technology	Modulation Type	Data Rate (Mbps)
-	5180-5240	802.11n (HT20)	36 to 48	36	OFDM	BPSK	MCS0

Antenna Port Conducted Measurement:

- This item includes all test value of each mode, but only includes spectrum plot of worst value of each mode.
- Pre-Scan has been conducted to determine the worst-case mode from all possible combinations between available modulations, data rates and antenna ports (if EUT with antenna diversity architecture).
- Following channel(s) was (were) selected for the final test as listed below.

EUT Configure Mode	Frequency Band (MHz)	Mode	Available Channel	Tested Channel	Modulation Technology	Modulation Type	Data Rate (Mbps)
-	5180-5240	802.11a	36 to 48	36, 44, 48	OFDM	BPSK	6.0
		802.11n (HT20)	36 to 48	36, 44, 48	OFDM	BPSK	MCS0
		802.11n (HT40)	38 to 46	38, 46	OFDM	BPSK	MCS0
		802.11ac (VHT80)	42	42	OFDM	BPSK	MCS0
-	5745-5805	802.11a	149 to 161	149, 157, 161	OFDM	BPSK	6.0
		802.11n (HT20)	149 to 161	149, 157, 161	OFDM	BPSK	MCS0
		802.11n (HT40)	151 to 159	151, 159	OFDM	BPSK	MCS0
		802.11ac (VHT80)	155	155	OFDM	BPSK	MCS0

Test Condition:

Applicable To	Environmental Conditions	Input Power	Tested by
RE \geq 1G	25 deg. C, 65 % RH	120Vac, 60Hz	Charles Hsiao
RE<1G	25 deg. C, 65 % RH	120Vac, 60Hz	Charles Hsiao
PLC	25 deg. C, 65 % RH	120Vac, 60Hz	Anson Lin
APCM	25 deg. C, 65 % RH	12Vdc	Wayne Lin

3.3 Duty Cycle of Test Signal

MODULATION TYPE: BPSK

1Tx

802.11a: Duty cycle = 2.692/2.788 = 0.966, Duty factor = $10 \cdot \log(1/0.966) = 0.15$

802.11n (20MHz): Duty cycle = 2.519/2.596 = 0.970, Duty factor = $10 \cdot \log(1/0.970) = 0.13$

802.11n (40MHz): Duty cycle = 1.170/1.298 = 0.901, Duty factor = $10 \cdot \log(1/0.901) = 0.45$

802.11ac (80MHz): Duty cycle = 0.561/0.665 = 0.843, Duty factor = $10 \cdot \log(1/0.843) = 0.74$

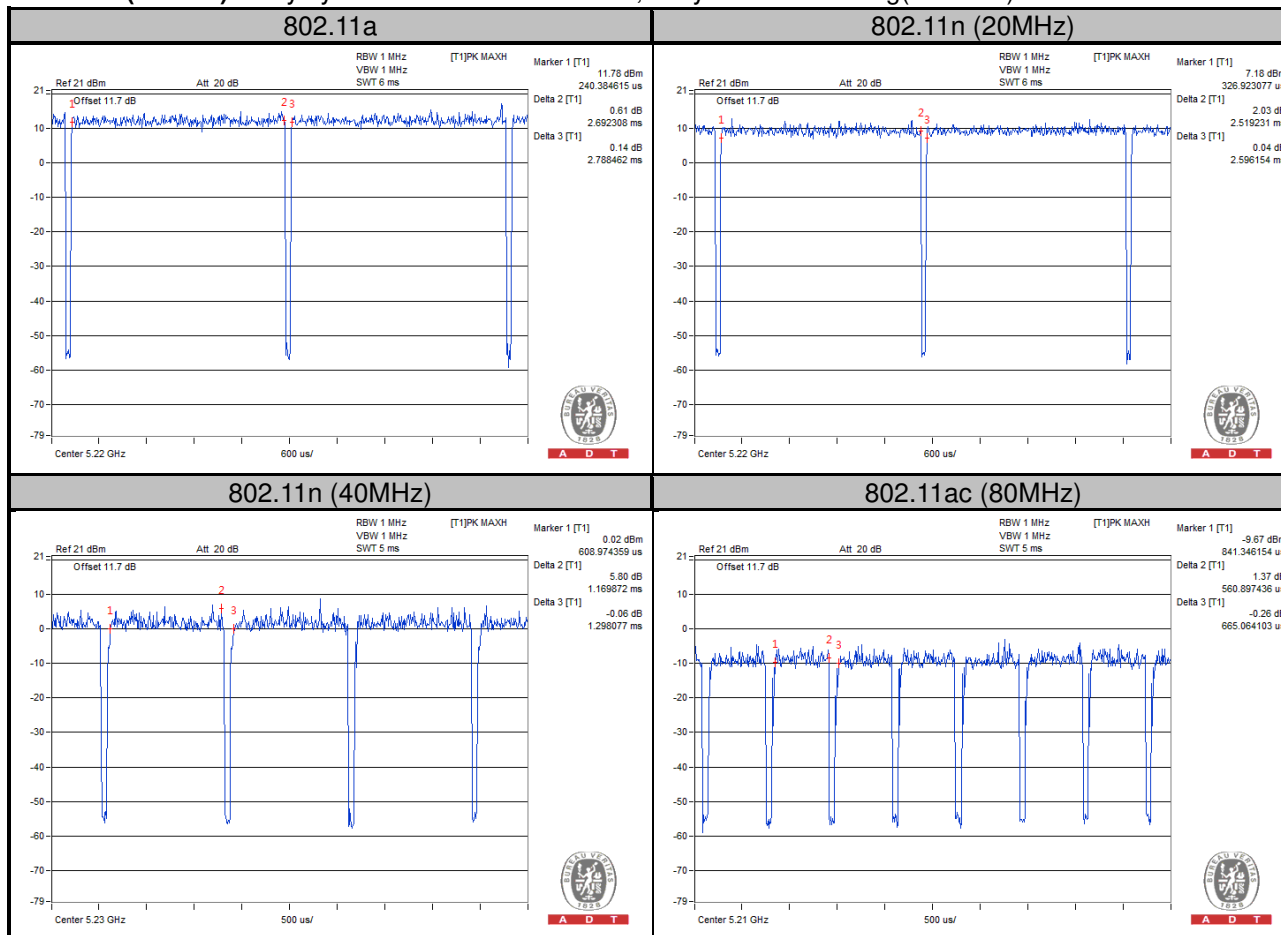

2Tx

802.11n (20MHz): Duty cycle = 2.519/2.596 = 0.970, Duty factor = $10 \cdot \log(1/0.970) = 0.13$

802.11n (40MHz): Duty cycle = 1.186/1.298 = 0.914, Duty factor = $10 \cdot \log(1/0.914) = 0.39$

802.11ac (80MHz): Duty cycle = 0.561/0.673 = 0.833, Duty factor = $10 \cdot \log(1/0.833) = 0.79$

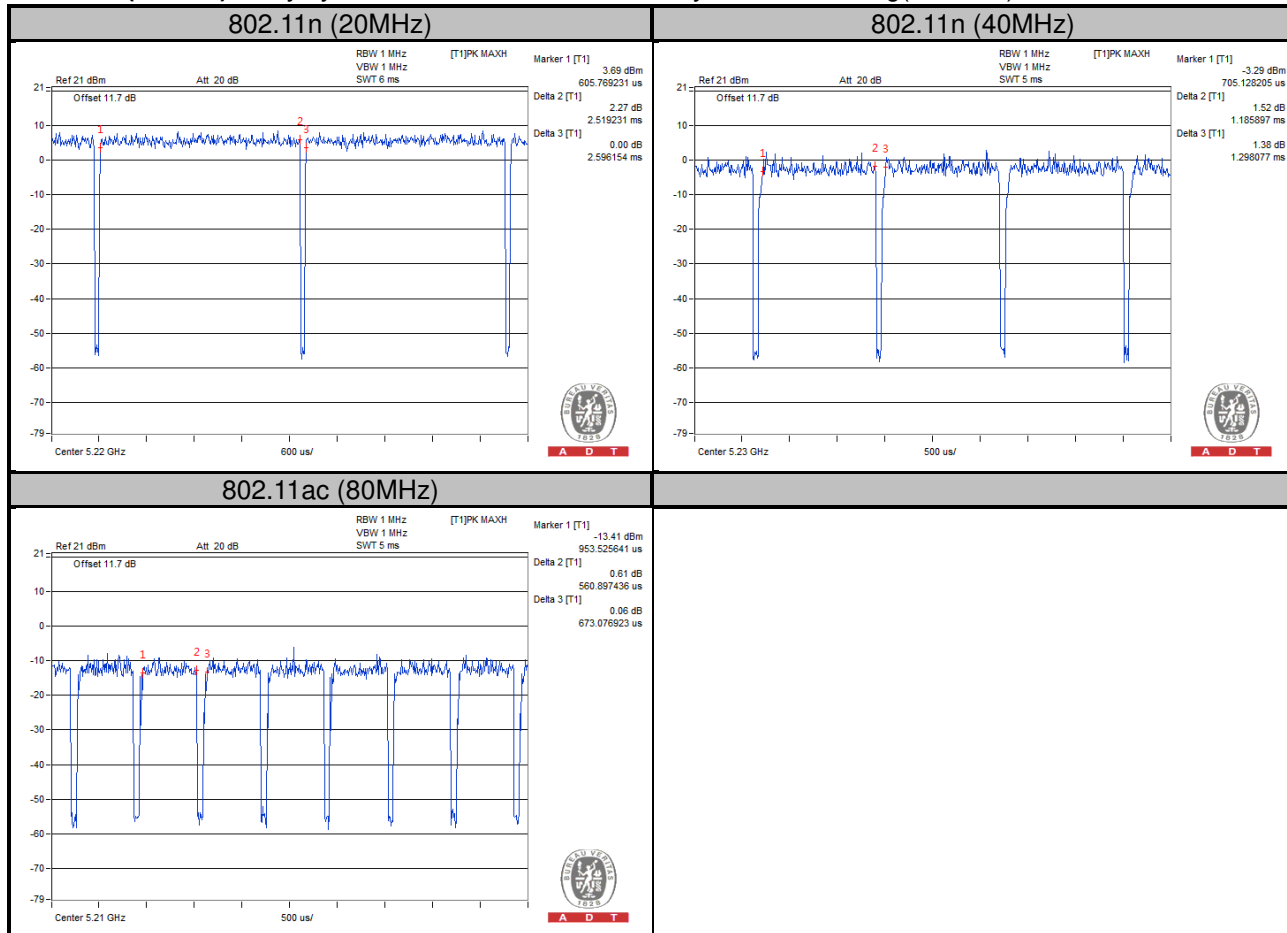

3Tx

802.11n (20MHz): Duty cycle = 2.519/2.596 = 0.970, Duty factor = $10 \cdot \log(1/0.970) = 0.13$

802.11n (40MHz): Duty cycle = 1.194/1.306 = 0.914, Duty factor = $10 \cdot \log(1/0.914) = 0.39$

802.11ac (80MHz): Duty cycle = 0.569/0.673 = 0.845, Duty factor = $10 \cdot \log(1/0.845) = 0.73$

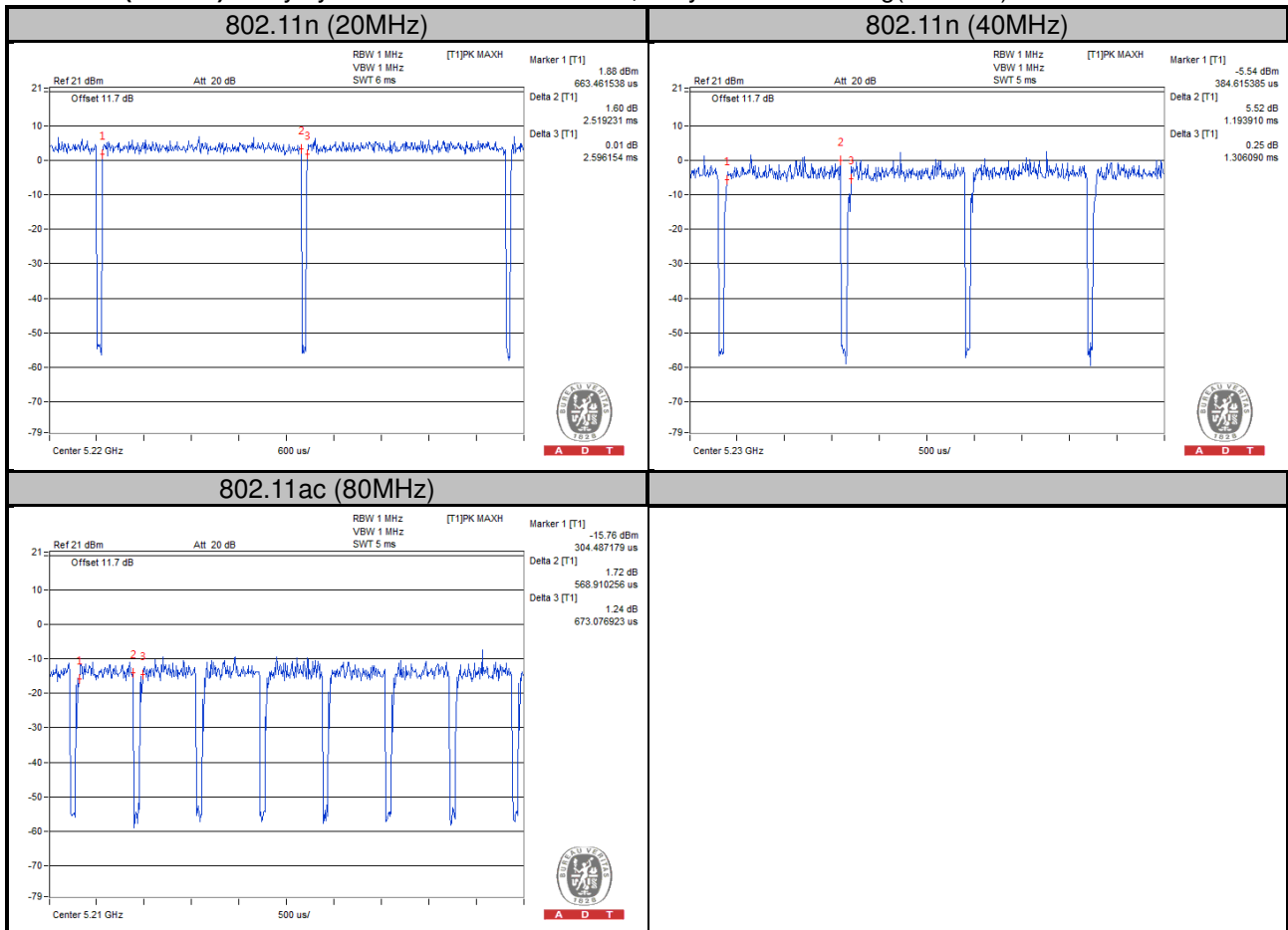

3.4 Description of Support Units

The EUT has been tested as an independent unit together with other necessary accessories or support units.

3.4.1 Configuration of System under Test

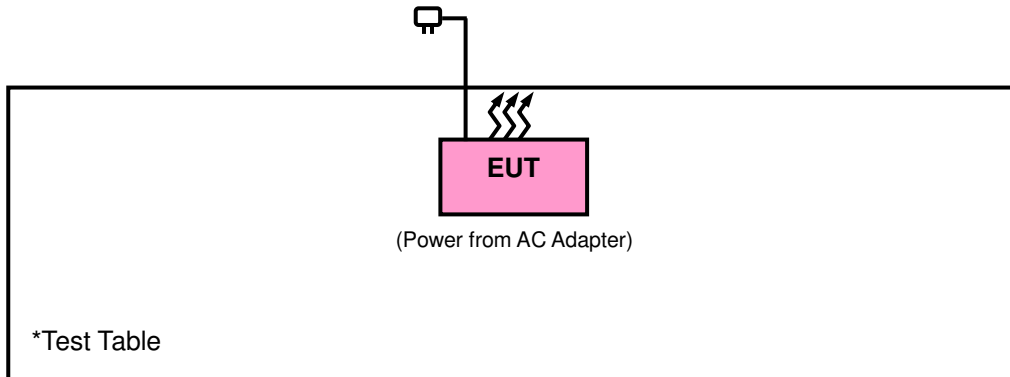

3.5 General Description of Applied Standards

The EUT is a RF Product. According to the specifications of the manufacturer, it must comply with the requirements of the following standards:

FCC Part 15, Subpart E (15.407)

789033 D02 General UNII Test Procedures New Rules v01r04

644545 D01 Guidance for IEEE 802 11ac v01r02

662911 D01 Multiple Transmitter Output v02r01

ANSI C63.10-2013

All test items have been performed and recorded as per the above standards.

Note: The EUT has been verified to comply with the requirements of FCC Part 15, Subpart B, Class B (DoC).
The test report has been issued separately.

4 Test Types and Results

4.1 Radiated Emission and Bandedge Measurement

4.1.1 Limits of Radiated Emission and Bandedge Measurement

Radiated emissions which fall in the restricted bands must comply with the radiated emission limits specified as below table. Other emissions shall be at least 20 dB below the highest level of the desired power:

Frequencies (MHz)	Field Strength (microvolts/meter)	Measurement Distance (meters)
0.009 ~ 0.490	2400/F (kHz)	300
0.490 ~ 1.705	24000/F (kHz)	30
1.705 ~ 30.0	30	30
30 ~ 88	100	3
88 ~ 216	150	3
216 ~ 960	200	3
Above 960	500	3

Note:

1. The lower limit shall apply at the transition frequencies.
2. Emission level (dBuV/m) = 20 log Emission level (uV/m).
3. For frequencies above 1000 MHz, the field strength limits are based on average detector, however, the peak field strength of any emission shall not exceed the maximum permitted average limits, specified above by more than 20 dB under any condition of modulation.

4.1.2 Limits of Unwanted Emission Out of the Restricted Bands

Applicable To		Limit	
789033 D02 General UNII Test Procedures New Rules v01r04		Field Strength at 3 m	
		PK: 74 (dBμV/m)	AV: 54 (dBμV/m)
Frequency Band	Applicable To	EIRP Limit	Equivalent Field Strength at 3 m
5150~5250 MHz	15.407(b)(1)	PK: -27 (dBm/MHz)	PK: 68.2 (dBμV/m)
5250~5350 MHz	15.407(b)(2)		
5470~5725 MHz	15.407(b)(3)		
5725~5850 MHz	15.407(b)(4)(i)	PK:-27 (dBm/MHz) ^{*1} PK:10 (dBm/MHz) ^{*2} PK:15.6 (dBm/MHz) ^{*3} PK:27 (dBm/MHz) ^{*4}	PK: 68.2 (dBμV/m) ^{*1} PK:105.2 (dBμV/m) ^{*2} PK: 110.8 (dBμV/m) ^{*3} PK:122.2 (dBμV/m) ^{*4}
	15.407(b)(4)(ii)	Emission limits in section 15.247(d)	
^{*1} beyond 75 MHz or more above of the band edge. ^{*2} below the band edge increasing linearly to 10 dBm/MHz at 25 MHz above. ^{*3} below the band edge increasing linearly to a level of 15.6 dBm/MHz at 5 MHz above. ^{*4} from 5 MHz above or below the band edge increasing linearly to a level of 27 dBm/MHz at the band edge.			

Note:

The following formula is used to convert the equipment isotropic radiated power (eirp) to field strength:

$$E = \frac{1000000\sqrt{30P}}{3} \mu\text{V/m, where P is the eirp (Watts).$$

4.1.3 Test Instruments

Description & Manufacturer	Model No.	Serial No.	Date of Calibration	Due Date of Calibration
Test Receiver Agilent	N9038A	MY51210203	Feb. 17, 2017	Feb. 16, 2018
Spectrum Analyzer Agilent	N9010A	MY52220314	Dec. 16, 2016	Dec. 15, 2017
Spectrum Analyzer ROHDE & SCHWARZ	FSU43	101261	Dec. 13, 2016	Dec. 12, 2017
BILOG Antenna SCHWARZBECK	VULB9168	9168-472	Dec. 26, 2016	Dec. 27, 2017
HORN Antenna SCHWARZBECK	BBHA 9120 D	9120D-969	Dec. 12, 2016	Dec. 13, 2017
HORN Antenna SCHWARZBECK	BBHA 9170	9170-480	Dec. 14, 2016	Dec. 13, 2017
Fixed Attenuator Mini-Circuits	MDCS18N-10	MDCS18N-10-01	Apr. 17, 2017	Apr. 16, 2018
Loop Antenna	HLA 6121	45745	May 19, 2017	May 18, 2018
Preamplifier EMCI	EMC001340	980201	Nov. 02, 2016	Nov. 01, 2017
Bluetooth Tester	CBT	100946	Jul. 29, 2016	Jul. 28, 2018
Preamplifier EMCI	EMC 012645	980115	Oct. 21, 2016	Oct. 20, 2017
Preamplifier EMCI	EMC 184045	980116	Oct. 21, 2016	Oct. 20, 2017
Preamplifier EMCI	EMC 330H	980112	Oct. 21, 2016	Oct. 20, 2017
Power Meter Anritsu	ML2495A	1145013	Mar. 07, 2017	Mar. 06, 2018
Power Sensor Anritsu	MA2411B	1126085	Mar. 07, 2017	Mar. 06, 2018
RF signal cable HUBER+SUHNNER	SUCOFLEX 104	309219/4 2950114	Oct. 21, 2016	Oct. 20, 2017
RF signal cable HUBER+SUHNNER	SUCOFLEX 104	250130/4	Oct. 21, 2016	Oct. 20, 2017
RF Coaxial Cable Worken	8D-FB	Cable-Ch10-01	Oct. 21, 2016	Oct. 20, 2017
Software BV ADT	E3 6.120103	NA	NA	NA
Antenna Tower MF	MFA-440H	NA	NA	NA
Turn Table MF	MFT-201SS	NA	NA	NA
Antenna Tower & Turn Table Controller MF	MF-7802	NA	NA	NA
Temperature & Humidity Chamber	GTH-120-40-CP-A R	MAA1306-019	Sep. 08, 2017	Sep. 07, 2018
DC Power Supply Topward	33010D	807748	Oct. 25, 2016	Oct. 24, 2018
Digital Multimeter Fluke	87-III	70360742	Jun. 30, 2017	Jun. 29, 2018

- Note:
1. The calibration interval of the above test instruments is 12 / 24 months and the calibrations are traceable to NML/ROC and NIST/USA.
 2. The test was performed in HwaYa Chamber 10.
 3. The horn antenna and preamplifier (model: EMC 184045) are used only for the measurement of emission frequency above 1 GHz if tested.
 4. The IC Site Registration No. is IC7450F-10.

4.1.4 Test Procedures

- a. The EUT was placed on the top of a rotating table 0.8 meters (for below 1 GHz) / 1.5 meters (for above 1 GHz) above the ground at 3 meter chamber room for test. The table was rotated 360 degrees to determine the position of the highest radiation.
- b. The EUT was set 3 meters away from the interference-receiving antenna, which was mounted on the top of a variable-height antenna tower.
- c. The height of antenna is varied from one meter to four meters above the ground to determine the maximum value of the field strength. Both horizontal and vertical polarizations of the antenna are set to make the measurement.
- d. For each suspected emission, the EUT was arranged to its worst case and then the antenna was tuned to heights from 1 meter to 4 meters and the rotatable table was turned from 0 degrees to 360 degrees to find the maximum reading.
- e. The test-receiver system was set to quasi-peak detect function and specified bandwidth with maximum hold mode when the test frequency is below 1 GHz.
- f. The test-receiver system was set to peak and average detected function and specified bandwidth with maximum hold mode when the test frequency is above 1 GHz. If the peak reading value also meets average limit, measurement with the average detector is unnecessary.

Note:

1. The resolution bandwidth and video bandwidth of test receiver/spectrum analyzer is 120 kHz & 360 kHz for Quasi-peak detection (QP) at frequency below 1 GHz.
2. The resolution bandwidth of test receiver/spectrum analyzer is 1 MHz and the video bandwidth is 3 MHz for Peak detection (PK) at frequency above 1 GHz.
3. The resolution bandwidth of test receiver/spectrum analyzer is 1 MHz and the video bandwidth is 1/T for Average (Duty cycle < 98 %) detection at frequency above 1 GHz.
4. The resolution bandwidth of test receiver/spectrum analyzer is 1 MHz and the video bandwidth is 10 Hz (Duty cycle ≥ 98 %) for Average detection (AV) at frequency above 1 GHz.
5. All modes of operation were investigated and the worst-case emissions are reported.

4.1.5 Deviation from Test Standard

No deviation.

4.1.6 Test Set Up

<Radiated emission below 30 MHz>

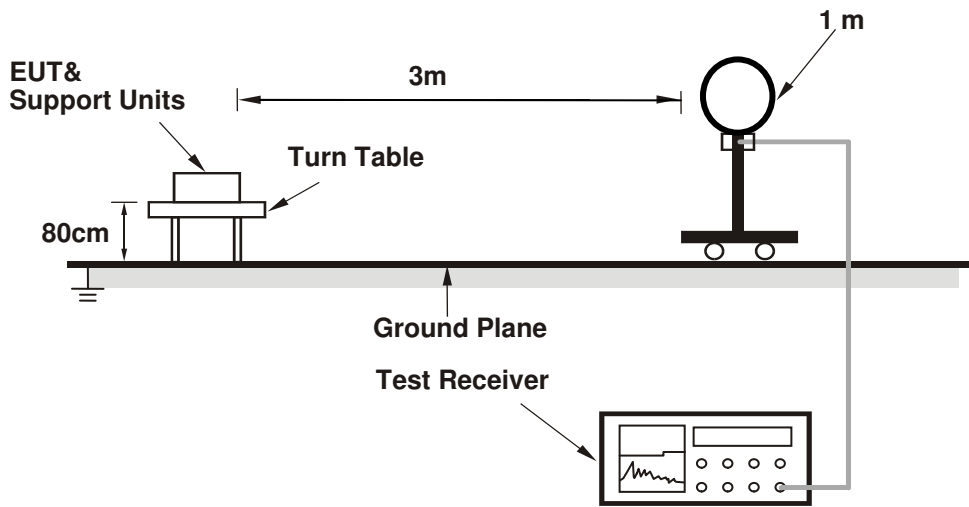

<Frequency Range below 1 GHz>

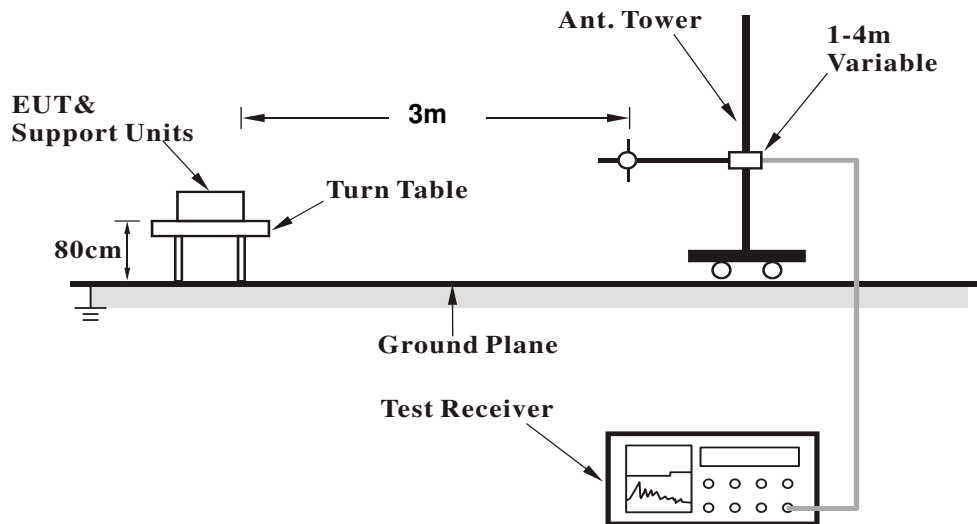

<Frequency Range above 1 GHz>

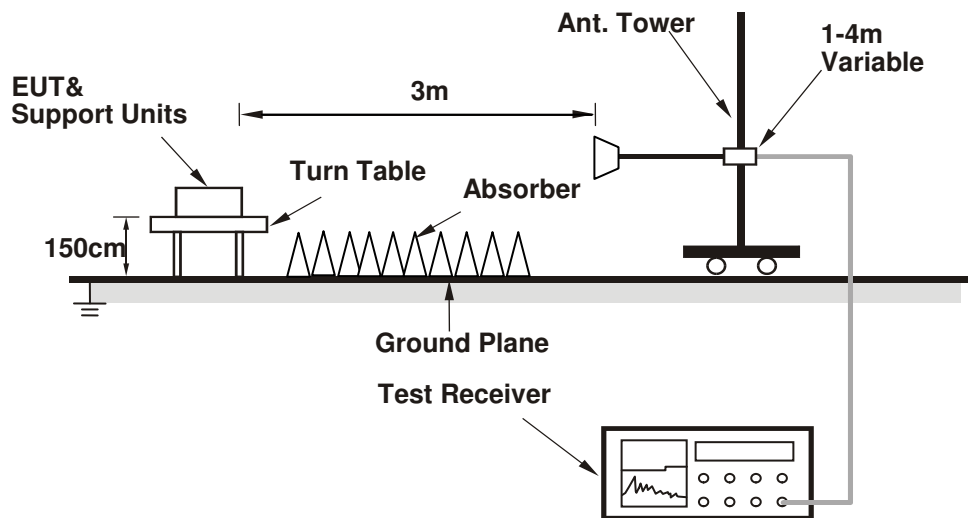

For the actual test configuration, please refer to the attached file (Test Setup Photo).

4.1.7 EUT Operating Conditions

- a. Placed the EUT on a testing table.
- b. Use the software to control the EUT under transmission condition continuously at specific channel frequency.

4.1.8 Test Results
 Above 1 GHz Data :
 802.11a

EUT Test Condition		Measurement Detail	
Channel	Channel 36	Frequency Range	1 GHz ~ 40 GHz
Input Power	120 Vac, 60 Hz	Detector Function	Peak (PK) Average (AV)
Environmental Conditions	25 deg. C, 65 % RH	Tested By	Charles Hsiao

Antenna Polarity & Test Distance: Horizontal at 3 m										
Frequency (MHz)	Emission Level (dBuV/m)	Read Level (dBuV)	Limit (dBuV/m)	Margin (dB)	Antenna Factor (dB/m)	Cable Loss (dB)	Preamp Factor (dB)	Antenna Height (cm)	Table Angle (Degree)	Remark
5148	45.55	37.3	54	-8.45	34.12	8.13	34	116	248	Average
5148	64.04	55.79	74	-9.96	34.12	8.13	34	116	248	Peak
5180	97.01	88.7			34.15	8.16	34	116	248	Average
5180	103.92	95.61			34.15	8.16	34	116	248	Peak
5390	43.22	34.54	54	-10.78	34.31	8.41	34.04	116	248	Average
5390	63.25	54.57	74	-10.75	34.31	8.41	34.04	116	248	Peak

Antenna Polarity & Test Distance: Vertical at 3 m										
Frequency (MHz)	Emission Level (dBuV/m)	Read Level (dBuV)	Limit (dBuV/m)	Margin (dB)	Antenna Factor (dB/m)	Cable Loss (dB)	Preamp Factor (dB)	Antenna Height (cm)	Table Angle (Degree)	Remark
5150	52.55	44.3	54	-1.45	34.12	8.13	34	106	73	Average
5150	65.04	56.79	74	-8.96	34.12	8.13	34	106	73	Peak
5180	104.91	96.6			34.15	8.16	34	106	73	Average
5180	111.83	103.52			34.15	8.16	34	106	73	Peak
5458	44.07	35.25	54	-9.93	34.36	8.51	34.05	106	73	Average
5458	63.37	54.55	74	-10.63	34.36	8.51	34.05	106	73	Peak

Remarks:

- Emission Level = Read Level + Antenna Factor + Cable Loss - Preamp Factor
 Margin value = Emission level – Limit value
- 5180 MHz: Fundamental Frequency
- *: Out of Restricted Band

EUT Test Condition		Measurement Detail	
Channel	Channel 44	Frequency Range	1 GHz ~ 40 GHz
Input Power	120 Vac, 60 Hz	Detector Function	Peak (PK) Average (AV)
Environmental Conditions	25 deg. C, 65 % RH	Tested By	Charles Hsiao

Antenna Polarity & Test Distance: Horizontal at 3 m										
Frequency (MHz)	Emission Level (dBuV/m)	Read Level (dBuV)	Limit (dBuV/m)	Margin (dB)	Antenna Factor (dB/m)	Cable Loss (dB)	Preamp Factor (dB)	Antenna Height (cm)	Table Angle (Degree)	Remark
5032	43.03	34.97	54	-10.97	34.03	8	33.97	116	233	Average
5032	62.94	54.88	74	-11.06	34.03	8	33.97	116	233	Peak
5220	99	90.61			34.17	8.22	34	116	233	Average
5220	106.96	98.57			34.17	8.22	34	116	233	Peak
5378	43.12	34.44	54	-10.88	34.31	8.41	34.04	116	233	Average
5378	63.33	54.65	74	-10.67	34.31	8.41	34.04	116	233	Peak
Antenna Polarity & Test Distance: Vertical at 3 m										
Frequency (MHz)	Emission Level (dBuV/m)	Read Level (dBuV)	Limit (dBuV/m)	Margin (dB)	Antenna Factor (dB/m)	Cable Loss (dB)	Preamp Factor (dB)	Antenna Height (cm)	Table Angle (Degree)	Remark
5112	44.79	36.59	54	-9.21	34.09	8.1	33.99	104	73	Average
5112	63.42	55.22	74	-10.58	34.09	8.1	33.99	104	73	Peak
5220	106	97.61			34.17	8.22	34	104	73	Average
5220	113.76	105.37			34.17	8.22	34	104	73	Peak
5452	44.47	35.65	54	-9.53	34.36	8.51	34.05	104	73	Average
5452	64.33	55.51	74	-9.67	34.36	8.51	34.05	104	73	Peak

Remarks:

- Emission Level = Read Level + Antenna Factor + Cable Loss - Preamp Factor
Margin value = Emission level – Limit value
- 5220 MHz: Fundamental Frequency
- *: Out of Restricted Band

EUT Test Condition		Measurement Detail	
Channel	Channel 48	Frequency Range	1 GHz ~ 40 GHz
Input Power	120 Vac, 60 Hz	Detector Function	Peak (PK) Average (AV)
Environmental Conditions	25 deg. C, 65 % RH	Tested By	Charles Hsiao

Antenna Polarity & Test Distance: Horizontal at 3 m										
Frequency (MHz)	Emission Level (dBuV/m)	Read Level (dBuV)	Limit (dBuV/m)	Margin (dB)	Antenna Factor (dB/m)	Cable Loss (dB)	Preamp Factor (dB)	Antenna Height (cm)	Table Angle (Degree)	Remark
5038	43.24	35.17	54	-10.76	34.04	8	33.97	116	248	Average
5038	63.47	55.4	74	-10.53	34.04	8	33.97	116	248	Peak
5240	98.34	89.9			34.19	8.26	34.01	116	248	Average
5240	106.89	98.45			34.19	8.26	34.01	116	248	Peak
5440	43.42	34.63	54	-10.58	34.35	8.48	34.04	116	248	Average
5440	62.83	54.04	74	-11.17	34.35	8.48	34.04	116	248	Peak

Antenna Polarity & Test Distance: Vertical at 3 m										
Frequency (MHz)	Emission Level (dBuV/m)	Read Level (dBuV)	Limit (dBuV/m)	Margin (dB)	Antenna Factor (dB/m)	Cable Loss (dB)	Preamp Factor (dB)	Antenna Height (cm)	Table Angle (Degree)	Remark
5100	45.15	36.99	54	-8.85	34.08	8.07	33.99	104	73	Average
5100	62.56	54.4	74	-11.44	34.08	8.07	33.99	104	73	Peak
5240	106.44	98			34.19	8.26	34.01	104	73	Average
5240	113.1	104.66			34.19	8.26	34.01	104	73	Peak
5414	43.98	35.25	54	-10.02	34.33	8.44	34.04	104	73	Average
5414	63.11	54.38	74	-10.89	34.33	8.44	34.04	104	73	Peak

Remarks:

- Emission Level = Read Level + Antenna Factor + Cable Loss - Preamp Factor
Margin value = Emission level – Limit value
- 5240 MHz: Fundamental Frequency
- *: Out of Restricted Band

EUT Test Condition		Measurement Detail	
Channel	Channel 149	Frequency Range	1 GHz ~ 40 GHz
Input Power	120 Vac, 60 Hz	Detector Function	Peak (PK) Average (AV)
Environmental Conditions	25 deg. C, 65 % RH	Tested By	Charles Hsiao

<Spurious Emission>

Antenna Polarity & Test Distance: Horizontal at 3 m										
Frequency (MHz)	Emission Level (dBuV/m)	Read Level (dBuV)	Limit (dBuV/m)	Margin (dB)	Antenna Factor (dB/m)	Cable Loss (dB)	Preamp Factor (dB)	Antenna Height (cm)	Table Angle (Degree)	Remark
5745	95.32	94.05			31.99	6.75	37.47	136	127	Average
5745	104.73	103.46			31.99	6.75	37.47	136	127	Peak
11490	46.46	48.67	54	-7.54	39.91	10.66	52.78	100	248	Average
11490	56.52	58.73	74	-17.48	39.91	10.66	52.78	100	248	Peak
Antenna Polarity & Test Distance: Vertical at 3 m										
Frequency (MHz)	Emission Level (dBuV/m)	Read Level (dBuV)	Limit (dBuV/m)	Margin (dB)	Antenna Factor (dB/m)	Cable Loss (dB)	Preamp Factor (dB)	Antenna Height (cm)	Table Angle (Degree)	Remark
5745	102.52	101.22			31.99	6.78	37.47	143	75	Average
5745	111.26	109.96			31.99	6.78	37.47	143	75	Peak
11490	45.72	47.98	54	-8.28	39.91	10.66	52.83	135	139	Average
11490	56.31	58.57	74	-17.69	39.91	10.66	52.83	135	139	Peak

<Out of Band Emission (OOBE)>

Antenna Polarity & Test Distance: Horizontal at 3 m										
Frequency (MHz)	Emission Level (dBuV/m)	Read Level (dBuV)	Limit (dBuV/m)	Margin (dB)	Antenna Factor (dB/m)	Cable Loss (dB)	Preamp Factor (dB)	Antenna Height (cm)	Table Angle (Degree)	Remark
5629.8	52.54	51.47	68.2	-15.66	31.79	6.56	37.28	136	127	Peak
5654.025	51.29	50.16	71.19	-19.9	31.85	6.62	37.34	136	127	Peak
5923.35	52.22	50.42	69.42	-17.2	32.29	7.01	37.5	136	127	Peak
5980.35	51.82	49.88	68.2	-16.38	32.37	7.08	37.51	136	127	Peak
Antenna Polarity & Test Distance: Vertical at 3 m										
Frequency (MHz)	Emission Level (dBuV/m)	Read Level (dBuV)	Limit (dBuV/m)	Margin (dB)	Antenna Factor (dB/m)	Cable Loss (dB)	Preamp Factor (dB)	Antenna Height (cm)	Table Angle (Degree)	Remark
5559.025	53.82	52.77	68.2	-14.38	31.68	6.49	37.12	143	75	Peak
5652.125	52.66	51.47	69.78	-17.12	31.85	6.62	37.28	143	75	Peak
5922.875	50.76	48.96	69.77	-19.01	32.29	7.01	37.5	143	75	Peak
5952.8	53.28	51.38	68.2	-14.92	32.32	7.08	37.5	143	75	Peak

Remarks:

- Emission Level = Read Level + Antenna Factor + Cable Loss - Preamp Factor
Margin value = Emission level – Limit value
- 5745 MHz: Fundamental Frequency
- *: Out of Restricted Band

EUT Test Condition		Measurement Detail	
Channel	Channel 157	Frequency Range	1 GHz ~ 40 GHz
Input Power	120 Vac, 60 Hz	Detector Function	Peak (PK) Average (AV)
Environmental Conditions	25 deg. C, 65 % RH	Tested By	Charles Hsiao

<Spurious Emission>

Antenna Polarity & Test Distance: Horizontal at 3 m										
Frequency (MHz)	Emission Level (dBuV/m)	Read Level (dBuV)	Limit (dBuV/m)	Margin (dB)	Antenna Factor (dB/m)	Cable Loss (dB)	Preamp Factor (dB)	Antenna Height (cm)	Table Angle (Degree)	Remark
5785	99.38	98.06			32.04	6.82	37.54	136	126	Average
5785	108.45	107.13			32.04	6.82	37.54	136	126	Peak
11570	46.39	48.86	54	-7.61	39.78	10.76	53.01	100	251	Average
11570	56.89	59.36	74	-17.11	39.78	10.76	53.01	100	251	Peak
Antenna Polarity & Test Distance: Vertical at 3 m										
Frequency (MHz)	Emission Level (dBuV/m)	Read Level (dBuV)	Limit (dBuV/m)	Margin (dB)	Antenna Factor (dB/m)	Cable Loss (dB)	Preamp Factor (dB)	Antenna Height (cm)	Table Angle (Degree)	Remark
5785	106.9	105.58			32.04	6.82	37.54	144	74	Average
5785	116.02	114.7			32.04	6.82	37.54	144	74	Peak
11570	45.96	48.75	54	-8.04	39.78	10.76	53.33	131	139	Average
11570	56.61	59.4	74	-17.39	39.78	10.76	53.33	131	139	Peak

<Out of Band Emission (OOBE)>

Antenna Polarity & Test Distance: Horizontal at 3 m										
Frequency (MHz)	Emission Level (dBuV/m)	Read Level (dBuV)	Limit (dBuV/m)	Margin (dB)	Antenna Factor (dB/m)	Cable Loss (dB)	Preamp Factor (dB)	Antenna Height (cm)	Table Angle (Degree)	Remark
5630.75	52.91	51.84	68.2	-15.29	31.79	6.56	37.28	136	126	Peak
5652.125	50.44	49.25	69.78	-19.34	31.85	6.62	37.28	136	126	Peak
5923.35	50.57	48.77	69.42	-18.85	32.29	7.01	37.5	136	126	Peak
5981.775	52.22	50.28	68.2	-15.98	32.37	7.08	37.51	136	126	Peak
Antenna Polarity & Test Distance: Vertical at 3 m										
Frequency (MHz)	Emission Level (dBuV/m)	Read Level (dBuV)	Limit (dBuV/m)	Margin (dB)	Antenna Factor (dB/m)	Cable Loss (dB)	Preamp Factor (dB)	Antenna Height (cm)	Table Angle (Degree)	Remark
5602.25	55.08	53.91	68.2	-13.12	31.77	6.56	37.16	144	74	Peak
5652.6	54.54	53.35	70.13	-15.59	31.85	6.62	37.28	144	74	Peak
5921.925	51.24	49.44	70.47	-19.23	32.29	7.01	37.5	144	74	Peak
5950.9	54.43	52.53	68.2	-13.77	32.32	7.08	37.5	144	74	Peak

Remarks:

- Emission Level = Read Level + Antenna Factor + Cable Loss - Preamp Factor
Margin value = Emission level – Limit value
- 5785 MHz: Fundamental Frequency
- *: Out of Restricted Band

EUT Test Condition		Measurement Detail	
Channel	Channel 161	Frequency Range	1 GHz ~ 40 GHz
Input Power	120 Vac, 60 Hz	Detector Function	Peak (PK) Average (AV)
Environmental Conditions	25 deg. C, 65 % RH	Tested By	Charles Hsiao

<Spurious Emission>

Antenna Polarity & Test Distance: Horizontal at 3 m										
Frequency (MHz)	Emission Level (dBuV/m)	Read Level (dBuV)	Limit (dBuV/m)	Margin (dB)	Antenna Factor (dB/m)	Cable Loss (dB)	Preamp Factor (dB)	Antenna Height (cm)	Table Angle (Degree)	Remark
5805	99.34	97.96			32.1	6.82	37.54	136	126	Average
5805	108.44	107.06			32.1	6.82	37.54	136	126	Peak
11610	46.37	48.95	54	-7.63	39.71	10.79	53.08	100	244	Average
11610	57.06	59.64	74	-16.94	39.71	10.79	53.08	100	244	Peak
Antenna Polarity & Test Distance: Vertical at 3 m										
Frequency (MHz)	Emission Level (dBuV/m)	Read Level (dBuV)	Limit (dBuV/m)	Margin (dB)	Antenna Factor (dB/m)	Cable Loss (dB)	Preamp Factor (dB)	Antenna Height (cm)	Table Angle (Degree)	Remark
5805	107.25	105.87			32.1	6.82	37.54	143	73	Average
5805	115.87	114.49			32.1	6.82	37.54	143	73	Peak
11610	45.94	48.85	54	-8.06	39.71	10.79	53.41	133	144	Average
11610	56.98	59.89	74	-17.02	39.71	10.79	53.41	133	144	Peak

<Out of Band Emission (OOBE)>

Antenna Polarity & Test Distance: Horizontal at 3 m										
Frequency (MHz)	Emission Level (dBuV/m)	Read Level (dBuV)	Limit (dBuV/m)	Margin (dB)	Antenna Factor (dB/m)	Cable Loss (dB)	Preamp Factor (dB)	Antenna Height (cm)	Table Angle (Degree)	Remark
5563.775	52.58	51.53	68.2	-15.62	31.68	6.49	37.12	136	126	Peak
5652.6	50.54	49.35	70.13	-19.59	31.85	6.62	37.28	136	126	Peak
5921.925	50.35	48.55	70.47	-20.12	32.29	7.01	37.5	136	126	Peak
6001.25	51.9	49.87	68.2	-16.3	32.4	7.14	37.51	136	126	Peak
Antenna Polarity & Test Distance: Vertical at 3 m										
Frequency (MHz)	Emission Level (dBuV/m)	Read Level (dBuV)	Limit (dBuV/m)	Margin (dB)	Antenna Factor (dB/m)	Cable Loss (dB)	Preamp Factor (dB)	Antenna Height (cm)	Table Angle (Degree)	Remark
5625.05	55.28	54.15	68.2	-12.92	31.79	6.56	37.22	143	73	Peak
5652.6	54.07	52.88	70.13	-16.06	31.85	6.62	37.28	143	73	Peak
5923.825	53.26	51.46	69.07	-15.81	32.29	7.01	37.5	143	73	Peak
6018.825	55.24	53.15	68.2	-12.96	32.45	7.14	37.5	143	73	Peak

Remarks:

- Emission Level = Read Level + Antenna Factor + Cable Loss - Preamp Factor
Margin value = Emission level – Limit value
- 5805 MHz: Fundamental Frequency
- *: Out of Restricted Band

802.11n (HT20)

EUT Test Condition		Measurement Detail	
Channel	Channel 36	Frequency Range	1 GHz ~ 40 GHz
Input Power	120 Vac, 60 Hz	Detector Function	Peak (PK) Average (AV)
Environmental Conditions	25 deg. C, 65 % RH	Tested By	Charles Hsiao

Antenna Polarity & Test Distance: Horizontal at 3 m

Frequency (MHz)	Emission Level (dBuV/m)	Read Level (dBuV)	Limit (dBuV/m)	Margin (dB)	Antenna Factor (dB/m)	Cable Loss (dB)	Preamp Factor (dB)	Antenna Height (cm)	Table Angle (Degree)	Remark
5122	45.19	36.99	54	-8.81	34.09	8.1	33.99	114	59	Average
5122	63.65	55.45	74	-10.35	34.09	8.1	33.99	114	59	Peak
5180	100.04	91.73			34.15	8.16	34	100	135	Average
5180	107.12	98.81			34.15	8.16	34	100	135	Peak
5414	43.78	35.05	54	-10.22	34.33	8.44	34.04	100	135	Average
5414	62.79	54.06	74	-11.21	34.33	8.44	34.04	100	135	Peak

Antenna Polarity & Test Distance: Vertical at 3 m

Frequency (MHz)	Emission Level (dBuV/m)	Read Level (dBuV)	Limit (dBuV/m)	Margin (dB)	Antenna Factor (dB/m)	Cable Loss (dB)	Preamp Factor (dB)	Antenna Height (cm)	Table Angle (Degree)	Remark
5146	52.85	44.6	54	-1.15	34.12	8.13	34	210	246	Average
5146	65.2	56.95	74	-8.8	34.12	8.13	34	210	246	Peak
5180	109.41	101.1			34.15	8.16	34	208	40	Average
5180	115.61	107.3			34.15	8.16	34	208	40	Peak
5368	45.71	37.04	54	-8.29	34.29	8.41	34.03	208	40	Average
5368	63.68	55.01	74	-10.32	34.29	8.41	34.03	208	40	Peak

Remarks:

- Emission Level = Read Level + Antenna Factor + Cable Loss - Preamp Factor
Margin value = Emission level – Limit value
- 5180 MHz: Fundamental Frequency
- *: Out of Restricted Band

EUT Test Condition		Measurement Detail	
Channel	Channel 44	Frequency Range	1 GHz ~ 40 GHz
Input Power	120 Vac, 60 Hz	Detector Function	Peak (PK) Average (AV)
Environmental Conditions	25 deg. C, 65 % RH	Tested By	Charles Hsiao

Antenna Polarity & Test Distance: Horizontal at 3 m										
Frequency (MHz)	Emission Level (dBuV/m)	Read Level (dBuV)	Limit (dBuV/m)	Margin (dB)	Antenna Factor (dB/m)	Cable Loss (dB)	Preamp Factor (dB)	Antenna Height (cm)	Table Angle (Degree)	Remark
5132	43.3	35.08	54	-10.7	34.11	8.1	33.99	100	57	Average
5132	62.85	54.63	74	-11.15	34.11	8.1	33.99	100	57	Peak
5220	100.8	92.41			34.17	8.22	34	100	57	Average
5220	108.37	99.98			34.17	8.22	34	100	57	Peak
5386	43.32	34.64	54	-10.68	34.31	8.41	34.04	100	57	Average
5386	63.83	55.15	74	-10.17	34.31	8.41	34.04	100	57	Peak

Antenna Polarity & Test Distance: Vertical at 3 m										
Frequency (MHz)	Emission Level (dBuV/m)	Read Level (dBuV)	Limit (dBuV/m)	Margin (dB)	Antenna Factor (dB/m)	Cable Loss (dB)	Preamp Factor (dB)	Antenna Height (cm)	Table Angle (Degree)	Remark
5104	45.95	37.79	54	-8.05	34.08	8.07	33.99	208	40	Average
5104	63.89	55.73	74	-10.11	34.08	8.07	33.99	208	40	Peak
5220	109.87	101.48			34.17	8.22	34	208	40	Average
5220	116.07	107.68			34.17	8.22	34	208	40	Peak
5362	45.87	37.23	54	-8.13	34.29	8.38	34.03	208	40	Average
5362	63.1	54.46	74	-10.9	34.29	8.38	34.03	208	40	Peak

Remarks:

- Emission Level = Read Level + Antenna Factor + Cable Loss - Preamp Factor
Margin value = Emission level – Limit value
- 5220 MHz: Fundamental Frequency
- *: Out of Restricted Band

EUT Test Condition		Measurement Detail	
Channel	Channel 48	Frequency Range	1 GHz ~ 40 GHz
Input Power	120 Vac, 60 Hz	Detector Function	Peak (PK) Average (AV)
Environmental Conditions	25 deg. C, 65 % RH	Tested By	Charles Hsiao

Antenna Polarity & Test Distance: Horizontal at 3 m										
Frequency (MHz)	Emission Level (dBuV/m)	Read Level (dBuV)	Limit (dBuV/m)	Margin (dB)	Antenna Factor (dB/m)	Cable Loss (dB)	Preamp Factor (dB)	Antenna Height (cm)	Table Angle (Degree)	Remark
5080	43.1	34.98	54	-10.9	34.07	8.03	33.98	105	138	Average
5080	62.67	54.55	74	-11.33	34.07	8.03	33.98	105	138	Peak
5240	99.84	91.4			34.19	8.26	34.01	105	138	Average
5240	107.69	99.25			34.19	8.26	34.01	105	138	Peak
5368	43.31	34.64	54	-10.69	34.29	8.41	34.03	105	138	Average
5368	64.64	55.97	74	-9.36	34.29	8.41	34.03	105	138	Peak

Antenna Polarity & Test Distance: Vertical at 3 m										
Frequency (MHz)	Emission Level (dBuV/m)	Read Level (dBuV)	Limit (dBuV/m)	Margin (dB)	Antenna Factor (dB/m)	Cable Loss (dB)	Preamp Factor (dB)	Antenna Height (cm)	Table Angle (Degree)	Remark
5020	45.88	37.87	54	-8.12	34.01	7.97	33.97	215	32	Average
5020	63.56	55.55	74	-10.44	34.01	7.97	33.97	215	32	Peak
5240	108.14	99.7			34.19	8.26	34.01	215	32	Average
5240	115.66	107.22			34.19	8.26	34.01	215	32	Peak
5380	45.92	37.24	54	-8.08	34.31	8.41	34.04	215	32	Average
5380	63.6	54.92	74	-10.4	34.31	8.41	34.04	215	32	Peak

Remarks:

- Emission Level = Read Level + Antenna Factor + Cable Loss - Preamp Factor
Margin value = Emission level – Limit value
- 5240 MHz: Fundamental Frequency
- *: Out of Restricted Band

EUT Test Condition		Measurement Detail	
Channel	Channel 149	Frequency Range	1 GHz ~ 40 GHz
Input Power	120 Vac, 60 Hz	Detector Function	Peak (PK) Average (AV)
Environmental Conditions	25 deg. C, 65 % RH	Tested By	Charles Hsiao

<Spurious Emission>

Antenna Polarity & Test Distance: Horizontal at 3 m										
Frequency (MHz)	Emission Level (dBuV/m)	Read Level (dBuV)	Limit (dBuV/m)	Margin (dB)	Antenna Factor (dB/m)	Cable Loss (dB)	Preamp Factor (dB)	Antenna Height (cm)	Table Angle (Degree)	Remark
5745	99.48	98.21			31.99	6.75	37.47	112	58	Average
5745	108.49	107.22			31.99	6.75	37.47	112	58	Peak
11490	46.02	48.23	54	-7.98	39.91	10.66	52.78	100	253	Average
11490	56.07	58.28	74	-17.93	39.91	10.66	52.78	100	253	Peak
Antenna Polarity & Test Distance: Vertical at 3 m										
Frequency (MHz)	Emission Level (dBuV/m)	Read Level (dBuV)	Limit (dBuV/m)	Margin (dB)	Antenna Factor (dB/m)	Cable Loss (dB)	Preamp Factor (dB)	Antenna Height (cm)	Table Angle (Degree)	Remark
5745	107.58	106.28			31.99	6.78	37.47	188	69	Average
5745	114.91	113.61			31.99	6.78	37.47	188	69	Peak
11490	46.06	48.32	54	-7.94	39.91	10.66	52.83	130	225	Average
11490	56.25	58.51	74	-17.75	39.91	10.66	52.83	130	225	Peak

<Out of Band Emission (OOBE)>

Antenna Polarity & Test Distance: Horizontal at 3 m										
Frequency (MHz)	Emission Level (dBuV/m)	Read Level (dBuV)	Limit (dBuV/m)	Margin (dB)	Antenna Factor (dB/m)	Cable Loss (dB)	Preamp Factor (dB)	Antenna Height (cm)	Table Angle (Degree)	Remark
5609.85	51.51	50.4	68.2	-16.69	31.77	6.56	37.22	112	58	Peak
5650.225	51.66	50.47	68.37	-16.71	31.85	6.62	37.28	112	58	Peak
5924.3	48.72	46.92	68.72	-20	32.29	7.01	37.5	112	58	Peak
6015.5	51.78	49.69	68.2	-16.42	32.45	7.14	37.5	112	58	Peak
Antenna Polarity & Test Distance: Vertical at 3 m										
Frequency (MHz)	Emission Level (dBuV/m)	Read Level (dBuV)	Limit (dBuV/m)	Margin (dB)	Antenna Factor (dB/m)	Cable Loss (dB)	Preamp Factor (dB)	Antenna Height (cm)	Table Angle (Degree)	Remark
5561.4	55.98	54.93	68.2	-12.22	31.68	6.49	37.12	188	69	Peak
5652.6	52.54	51.35	70.13	-17.59	31.85	6.62	37.28	188	69	Peak
5922.4	51.8	50	70.12	-18.32	32.29	7.01	37.5	188	69	Peak
5961.35	54.08	52.17	68.2	-14.12	32.34	7.08	37.51	188	69	Peak

Remarks:

- Emission Level = Read Level + Antenna Factor + Cable Loss - Preamp Factor
Margin value = Emission level – Limit value
- 5745 MHz: Fundamental Frequency
- *: Out of Restricted Band

EUT Test Condition		Measurement Detail	
Channel	Channel 157	Frequency Range	1 GHz ~ 40 GHz
Input Power	120 Vac, 60 Hz	Detector Function	Peak (PK) Average (AV)
Environmental Conditions	25 deg. C, 65 % RH	Tested By	Charles Hsiao

<Spurious Emission>

Antenna Polarity & Test Distance: Horizontal at 3 m										
Frequency (MHz)	Emission Level (dBuV/m)	Read Level (dBuV)	Limit (dBuV/m)	Margin (dB)	Antenna Factor (dB/m)	Cable Loss (dB)	Preamp Factor (dB)	Antenna Height (cm)	Table Angle (Degree)	Remark
5785	97.11	95.79			32.04	6.82	37.54	112	58	Average
5785	106.46	105.14			32.04	6.82	37.54	112	58	Peak
11570	45.76	48.23	54	-8.24	39.78	10.76	53.01	132	224	Average
11570	55.86	58.33	74	-18.14	39.78	10.76	53.01	132	224	Peak
Antenna Polarity & Test Distance: Vertical at 3 m										
Frequency (MHz)	Emission Level (dBuV/m)	Read Level (dBuV)	Limit (dBuV/m)	Margin (dB)	Antenna Factor (dB/m)	Cable Loss (dB)	Preamp Factor (dB)	Antenna Height (cm)	Table Angle (Degree)	Remark
5785	106.55	105.23			32.04	6.82	37.54	188	62	Average
5785	114.34	113.02			32.04	6.82	37.54	188	62	Peak
11570	45.63	48.42	54	-8.37	39.78	10.76	53.33	120	251	Average
11570	56.86	59.65	74	-17.14	39.78	10.76	53.33	120	251	Peak

<Out of Band Emission (OOBE)>

Antenna Polarity & Test Distance: Horizontal at 3 m										
Frequency (MHz)	Emission Level (dBuV/m)	Read Level (dBuV)	Limit (dBuV/m)	Margin (dB)	Antenna Factor (dB/m)	Cable Loss (dB)	Preamp Factor (dB)	Antenna Height (cm)	Table Angle (Degree)	Remark
5626.95	52.6	51.47	68.2	-15.6	31.79	6.56	37.22	112	58	Peak
5651.65	49.9	48.71	69.43	-19.53	31.85	6.62	37.28	112	58	Peak
5922.4	51.08	49.28	70.12	-19.04	32.29	7.01	37.5	112	58	Peak
5943.775	53.12	51.22	68.2	-15.08	32.32	7.08	37.5	112	58	Peak
Antenna Polarity & Test Distance: Vertical at 3 m										
Frequency (MHz)	Emission Level (dBuV/m)	Read Level (dBuV)	Limit (dBuV/m)	Margin (dB)	Antenna Factor (dB/m)	Cable Loss (dB)	Preamp Factor (dB)	Antenna Height (cm)	Table Angle (Degree)	Remark
5630.275	56.62	55.55	68.2	-11.58	31.79	6.56	37.28	188	62	Peak
5650.7	54.32	53.13	68.72	-14.4	31.85	6.62	37.28	188	62	Peak
5921.925	53.36	51.56	70.47	-17.11	32.29	7.01	37.5	188	62	Peak
5969.9	54.05	52.14	68.2	-14.15	32.34	7.08	37.51	188	62	Peak

Remarks:

- Emission Level = Read Level + Antenna Factor + Cable Loss - Preamp Factor
Margin value = Emission level – Limit value
- 5785 MHz: Fundamental Frequency
- *: Out of Restricted Band

EUT Test Condition		Measurement Detail	
Channel	Channel 161	Frequency Range	1 GHz ~ 40 GHz
Input Power	120 Vac, 60 Hz	Detector Function	Peak (PK) Average (AV)
Environmental Conditions	25 deg. C, 65 % RH	Tested By	Charles Hsiao

<Spurious Emission>

Antenna Polarity & Test Distance: Horizontal at 3 m										
Frequency (MHz)	Emission Level (dBuV/m)	Read Level (dBuV)	Limit (dBuV/m)	Margin (dB)	Antenna Factor (dB/m)	Cable Loss (dB)	Preamp Factor (dB)	Antenna Height (cm)	Table Angle (Degree)	Remark
5805	98.72	97.34			32.1	6.82	37.54	120	57	Average
5805	108.29	106.91			32.1	6.82	37.54	120	57	Peak
11610	45.76	48.34	54	-8.24	39.71	10.79	53.08	100	259	Average
11610	55.57	58.15	74	-18.43	39.71	10.79	53.08	100	259	Peak
Antenna Polarity & Test Distance: Vertical at 3 m										
Frequency (MHz)	Emission Level (dBuV/m)	Read Level (dBuV)	Limit (dBuV/m)	Margin (dB)	Antenna Factor (dB/m)	Cable Loss (dB)	Preamp Factor (dB)	Antenna Height (cm)	Table Angle (Degree)	Remark
5805	107.01	105.63			32.1	6.82	37.54	194	55	Average
5805	115.02	113.64			32.1	6.82	37.54	194	55	Peak
11610	46.63	49.54	54	-7.37	39.71	10.79	53.41	125	237	Average
11610	56.5	59.41	74	-17.5	39.71	10.79	53.41	125	237	Peak

<Out of Band Emission (OOBE)>

Antenna Polarity & Test Distance: Horizontal at 3 m										
Frequency (MHz)	Emission Level (dBuV/m)	Read Level (dBuV)	Limit (dBuV/m)	Margin (dB)	Antenna Factor (dB/m)	Cable Loss (dB)	Preamp Factor (dB)	Antenna Height (cm)	Table Angle (Degree)	Remark
5645.475	52.74	51.58	68.2	-15.46	31.82	6.62	37.28	120	57	Peak
5653.55	51.61	50.42	70.84	-19.23	31.85	6.62	37.28	120	57	Peak
5923.825	49.41	47.61	69.07	-19.66	32.29	7.01	37.5	120	57	Peak
6013.6	52.33	50.24	68.2	-15.87	32.45	7.14	37.5	120	57	Peak
Antenna Polarity & Test Distance: Vertical at 3 m										
Frequency (MHz)	Emission Level (dBuV/m)	Read Level (dBuV)	Limit (dBuV/m)	Margin (dB)	Antenna Factor (dB/m)	Cable Loss (dB)	Preamp Factor (dB)	Antenna Height (cm)	Table Angle (Degree)	Remark
5604.15	56.86	55.75	68.2	-11.34	31.77	6.56	37.22	194	55	Peak
5651.175	55.33	54.14	69.07	-13.74	31.85	6.62	37.28	194	55	Peak
5921.925	52.6	50.8	70.47	-17.87	32.29	7.01	37.5	194	55	Peak
5961.825	53.23	51.32	68.2	-14.97	32.34	7.08	37.51	194	55	Peak

Remarks:

- Emission Level = Read Level + Antenna Factor + Cable Loss - Preamp Factor
Margin value = Emission level – Limit value
- 5805 MHz: Fundamental Frequency
- *: Out of Restricted Band

802.11n (HT40)

EUT Test Condition		Measurement Detail	
Channel	Channel 38	Frequency Range	1 GHz ~ 40 GHz
Input Power	120 Vac, 60 Hz	Detector Function	Peak (PK) Average (AV)
Environmental Conditions	25 deg. C, 65 % RH	Tested By	Charles Hsiao

Antenna Polarity & Test Distance: Horizontal at 3 m

Frequency (MHz)	Emission Level (dBuV/m)	Read Level (dBuV)	Limit (dBuV/m)	Margin (dB)	Antenna Factor (dB/m)	Cable Loss (dB)	Preamp Factor (dB)	Antenna Height (cm)	Table Angle (Degree)	Remark
5128	44.2	35.98	54	-9.8	34.11	8.1	33.99	107	135	Average
5128	64.24	56.02	74	-9.76	34.11	8.1	33.99	107	135	Peak
5190	91.34	83			34.15	8.19	34	107	135	Average
5190	98.19	89.85			34.15	8.19	34	107	135	Peak
5365	43.27	34.63	54	-10.73	34.29	8.38	34.03	107	135	Average
5365	63.99	55.35	74	-10.01	34.29	8.38	34.03	107	135	Peak

Antenna Polarity & Test Distance: Vertical at 3 m

Frequency (MHz)	Emission Level (dBuV/m)	Read Level (dBuV)	Limit (dBuV/m)	Margin (dB)	Antenna Factor (dB/m)	Cable Loss (dB)	Preamp Factor (dB)	Antenna Height (cm)	Table Angle (Degree)	Remark
5110	50.95	42.75	54	-3.05	34.09	8.1	33.99	210	40	Average
5110	64.61	56.41	74	-9.39	34.09	8.1	33.99	210	40	Peak
5190	99.84	91.5			34.15	8.19	34	208	40	Average
5190	106.93	98.59			34.15	8.19	34	208	40	Peak
5376	44.71	36.05	54	-9.29	34.29	8.41	34.04	208	40	Average
5376	63.13	54.47	74	-10.87	34.29	8.41	34.04	208	40	Peak

Remarks:

- Emission Level = Read Level + Antenna Factor + Cable Loss - Preamp Factor
Margin value = Emission level – Limit value
- 5190 MHz: Fundamental Frequency
- *: Out of Restricted Band

EUT Test Condition		Measurement Detail	
Channel	Channel 46	Frequency Range	1 GHz ~ 40 GHz
Input Power	120 Vac, 60 Hz	Detector Function	Peak (PK) Average (AV)
Environmental Conditions	25 deg. C, 65 % RH	Tested By	Charles Hsiao

Antenna Polarity & Test Distance: Horizontal at 3 m										
Frequency (MHz)	Emission Level (dBuV/m)	Read Level (dBuV)	Limit (dBuV/m)	Margin (dB)	Antenna Factor (dB/m)	Cable Loss (dB)	Preamp Factor (dB)	Antenna Height (cm)	Table Angle (Degree)	Remark
5066	42.89	34.79	54	-11.11	34.05	8.03	33.98	128	51	Average
5066	63.17	55.07	74	-10.83	34.05	8.03	33.98	128	51	Peak
5230	96.77	88.37			34.19	8.22	34.01	128	51	Average
5230	103.56	95.16			34.19	8.22	34.01	128	51	Peak
5400	43.36	34.64	54	-10.64	34.32	8.44	34.04	128	51	Average
5400	62.87	54.15	74	-11.13	34.32	8.44	34.04	128	51	Peak

Antenna Polarity & Test Distance: Vertical at 3 m										
Frequency (MHz)	Emission Level (dBuV/m)	Read Level (dBuV)	Limit (dBuV/m)	Margin (dB)	Antenna Factor (dB/m)	Cable Loss (dB)	Preamp Factor (dB)	Antenna Height (cm)	Table Angle (Degree)	Remark
5036	46.53	38.47	54	-7.47	34.03	8	33.97	210	246	Average
5036	64.31	56.25	74	-9.69	34.03	8	33.97	210	246	Peak
5230	104.61	96.21			34.19	8.22	34.01	210	246	Average
5230	111.17	102.77			34.19	8.22	34.01	210	246	Peak
5460	46.07	37.25	54	-7.93	34.36	8.51	34.05	210	246	Average
5460	64.08	55.26	74	-9.92	34.36	8.51	34.05	210	246	Peak

Remarks:

- Emission Level = Read Level + Antenna Factor + Cable Loss - Preamp Factor
Margin value = Emission level – Limit value
- 5230 MHz: Fundamental Frequency
- *: Out of Restricted Band

EUT Test Condition		Measurement Detail	
Channel	Channel 151	Frequency Range	1 GHz ~ 40 GHz
Input Power	120 Vac, 60 Hz	Detector Function	Peak (PK) Average (AV)
Environmental Conditions	25 deg. C, 65 % RH	Tested By	Charles Hsiao

<Spurious Emission>

Antenna Polarity & Test Distance: Horizontal at 3 m										
Frequency (MHz)	Emission Level (dBuV/m)	Read Level (dBuV)	Limit (dBuV/m)	Margin (dB)	Antenna Factor (dB/m)	Cable Loss (dB)	Preamp Factor (dB)	Antenna Height (cm)	Table Angle (Degree)	Remark
5755	94.56	93.27			32.01	6.75	37.47	121	59	Average
5755	103.35	102.06			32.01	6.75	37.47	121	59	Peak
11510	45.35	47.57	54	-8.65	39.9	10.69	52.81	132	219	Average
11510	55.37	57.59	74	-18.63	39.9	10.69	52.81	132	219	Peak
Antenna Polarity & Test Distance: Vertical at 3 m										
Frequency (MHz)	Emission Level (dBuV/m)	Read Level (dBuV)	Limit (dBuV/m)	Margin (dB)	Antenna Factor (dB/m)	Cable Loss (dB)	Preamp Factor (dB)	Antenna Height (cm)	Table Angle (Degree)	Remark
5755	101.03	99.74			32.01	6.75	37.47	206	63	Average
5755	110.1	108.81			32.01	6.75	37.47	206	63	Peak
11510	46.17	48.65	54	-7.83	39.9	10.69	53.07	125	244	Average
11510	56.08	58.56	74	-17.92	39.9	10.69	53.07	125	244	Peak

<Out of Band Emission (OOBE)>

Antenna Polarity & Test Distance: Horizontal at 3 m										
Frequency (MHz)	Emission Level (dBuV/m)	Read Level (dBuV)	Limit (dBuV/m)	Margin (dB)	Antenna Factor (dB/m)	Cable Loss (dB)	Preamp Factor (dB)	Antenna Height (cm)	Table Angle (Degree)	Remark
5648.8	51.87	50.71	68.2	-16.33	31.82	6.62	37.28	121	59	Peak
5653.075	49.13	47.94	70.49	-21.36	31.85	6.62	37.28	121	59	Peak
5923.35	50.69	48.89	69.42	-18.73	32.29	7.01	37.5	121	59	Peak
5995.075	52.56	50.53	68.2	-15.64	32.4	7.14	37.51	121	59	Peak
Antenna Polarity & Test Distance: Vertical at 3 m										
Frequency (MHz)	Emission Level (dBuV/m)	Read Level (dBuV)	Limit (dBuV/m)	Margin (dB)	Antenna Factor (dB/m)	Cable Loss (dB)	Preamp Factor (dB)	Antenna Height (cm)	Table Angle (Degree)	Remark
5578.5	56.15	55.11	68.2	-12.05	31.71	6.49	37.16	206	63	Peak
5651.65	54.51	53.32	69.43	-14.92	31.85	6.62	37.28	206	63	Peak
5922.875	52.74	50.94	69.77	-17.03	32.29	7.01	37.5	206	63	Peak
5943.775	55.06	53.16	68.2	-13.14	32.32	7.08	37.5	206	63	Peak

Remarks:

- Emission Level = Read Level + Antenna Factor + Cable Loss - Preamp Factor
Margin value = Emission level – Limit value
- 5755 MHz: Fundamental Frequency
- *: Out of Restricted Band

EUT Test Condition		Measurement Detail	
Channel	Channel 159	Frequency Range	1 GHz ~ 40 GHz
Input Power	120 Vac, 60 Hz	Detector Function	Peak (PK) Average (AV)
Environmental Conditions	25 deg. C, 65 % RH	Tested By	Charles Hsiao

<Spurious Emission>

Antenna Polarity & Test Distance: Horizontal at 3 m										
Frequency (MHz)	Emission Level (dBuV/m)	Read Level (dBuV)	Limit (dBuV/m)	Margin (dB)	Antenna Factor (dB/m)	Cable Loss (dB)	Preamp Factor (dB)	Antenna Height (cm)	Table Angle (Degree)	Remark
5795	92.66	91.31			32.07	6.82	37.54	120	54	Average
5795	101.89	100.54			32.07	6.82	37.54	120	54	Peak
11590	45.26	47.75	54	-8.74	39.74	10.78	53.01	100	284	Average
11590	55.81	58.3	74	-18.19	39.74	10.78	53.01	100	284	Peak
Antenna Polarity & Test Distance: Vertical at 3 m										
Frequency (MHz)	Emission Level (dBuV/m)	Read Level (dBuV)	Limit (dBuV/m)	Margin (dB)	Antenna Factor (dB/m)	Cable Loss (dB)	Preamp Factor (dB)	Antenna Height (cm)	Table Angle (Degree)	Remark
5795	103.05	101.7			32.07	6.82	37.54	205	63	Average
5795	111.8	110.45			32.07	6.82	37.54	205	63	Peak
11590	46.18	48.99	54	-7.82	39.74	10.78	53.33	125	265	Average
11590	56.72	59.53	74	-17.28	39.74	10.78	53.33	125	265	Peak

<Out of Band Emission (OOBE)>

Antenna Polarity & Test Distance: Horizontal at 3 m										
Frequency (MHz)	Emission Level (dBuV/m)	Read Level (dBuV)	Limit (dBuV/m)	Margin (dB)	Antenna Factor (dB/m)	Cable Loss (dB)	Preamp Factor (dB)	Antenna Height (cm)	Table Angle (Degree)	Remark
5636.45	51.84	50.74	68.2	-16.36	31.82	6.56	37.28	120	54	Peak
5651.65	49.41	48.22	69.43	-20.02	31.85	6.62	37.28	120	54	Peak
5922.4	50.09	48.29	70.12	-20.03	32.29	7.01	37.5	120	54	Peak
6000.775	52.69	50.66	68.2	-15.51	32.4	7.14	37.51	120	54	Peak
Antenna Polarity & Test Distance: Vertical at 3 m										
Frequency (MHz)	Emission Level (dBuV/m)	Read Level (dBuV)	Limit (dBuV/m)	Margin (dB)	Antenna Factor (dB/m)	Cable Loss (dB)	Preamp Factor (dB)	Antenna Height (cm)	Table Angle (Degree)	Remark
5634.55	55.67	54.57	68.2	-12.53	31.82	6.56	37.28	205	63	Peak
5650.7	53.98	52.79	68.72	-14.74	31.85	6.62	37.28	205	63	Peak
5919.55	54.33	52.56	72.22	-17.89	32.26	7.01	37.5	205	63	Peak
5940.925	53.86	51.96	68.2	-14.34	32.32	7.08	37.5	205	63	Peak

Remarks:

- Emission Level = Read Level + Antenna Factor + Cable Loss - Preamp Factor
Margin value = Emission level – Limit value
- 5795 MHz: Fundamental Frequency
- *: Out of Restricted Band

802.11ac (VHT80)

EUT Test Condition		Measurement Detail	
Channel	Channel 42	Frequency Range	1 GHz ~ 40 GHz
Input Power	120 Vac, 60 Hz	Detector Function	Peak (PK) Average (AV)
Environmental Conditions	25 deg. C, 65 % RH	Tested By	Charles Hsiao

Antenna Polarity & Test Distance: Horizontal at 3 m

Frequency (MHz)	Emission Level (dBuV/m)	Read Level (dBuV)	Limit (dBuV/m)	Margin (dB)	Antenna Factor (dB/m)	Cable Loss (dB)	Preamp Factor (dB)	Antenna Height (cm)	Table Angle (Degree)	Remark
5116	44.19	35.99	54	-9.81	34.09	8.1	33.99	100	136	Average
5116	57.35	49.15	74	-16.65	34.09	8.1	33.99	100	136	Peak
5210	86.13	77.77			34.17	8.19	34	100	136	Average
5210	93.95	85.59			34.17	8.19	34	100	136	Peak
5460	43.48	34.66	54	-10.52	34.36	8.51	34.05	100	136	Average
5460	57.62	48.8	74	-16.38	34.36	8.51	34.05	100	136	Peak

Antenna Polarity & Test Distance: Vertical at 3 m

Frequency (MHz)	Emission Level (dBuV/m)	Read Level (dBuV)	Limit (dBuV/m)	Margin (dB)	Antenna Factor (dB/m)	Cable Loss (dB)	Preamp Factor (dB)	Antenna Height (cm)	Table Angle (Degree)	Remark
5148	52.19	43.94	54	-1.81	34.12	8.13	34	207	67	Average
5148	62.53	54.28	74	-11.47	34.12	8.13	34	207	67	Peak
5210	93.78	85.42			34.17	8.19	34	207	67	Average
5210	101.21	92.85			34.17	8.19	34	207	67	Peak
5430	44.47	35.68	54	-9.53	34.35	8.48	34.04	207	67	Average
5430	57.53	48.74	74	-16.47	34.35	8.48	34.04	207	67	Peak

Remarks:

- Emission Level = Read Level + Antenna Factor + Cable Loss - Preamp Factor
Margin value = Emission level – Limit value
- 5210 MHz: Fundamental Frequency
- *: Out of Restricted Band

EUT Test Condition		Measurement Detail	
Channel	Channel 155	Frequency Range	1 GHz ~ 40 GHz
Input Power	120 Vac, 60 Hz	Detector Function	Peak (PK) Average (AV)
Environmental Conditions	25 deg. C, 65 % RH	Tested By	Charles Hsiao

<Spurious Emission>

Antenna Polarity & Test Distance: Horizontal at 3 m										
Frequency (MHz)	Emission Level (dBuV/m)	Read Level (dBuV)	Limit (dBuV/m)	Margin (dB)	Antenna Factor (dB/m)	Cable Loss (dB)	Preamp Factor (dB)	Antenna Height (cm)	Table Angle (Degree)	Remark
5775	87.64	86.28			32.04	6.82	37.5	113	57	Average
5775	96.39	95.03			32.04	6.82	37.5	113	57	Peak
11550	45.02	47.41	54	-8.98	39.81	10.74	52.94	100	260	Average
11550	56.36	58.75	74	-17.64	39.81	10.74	52.94	100	260	Peak
Antenna Polarity & Test Distance: Vertical at 3 m										
Frequency (MHz)	Emission Level (dBuV/m)	Read Level (dBuV)	Limit (dBuV/m)	Margin (dB)	Antenna Factor (dB/m)	Cable Loss (dB)	Preamp Factor (dB)	Antenna Height (cm)	Table Angle (Degree)	Remark
5775	94.61	93.25			32.04	6.82	37.5	198	57	Average
5775	102.93	101.57			32.04	6.82	37.5	198	57	Peak
11550	45.64	48.33	54	-8.36	39.81	10.74	53.24	120	245	Average
11550	56.06	58.75	74	-17.94	39.81	10.74	53.24	120	245	Peak

<Out of Band Emission (OOBE)>

Antenna Polarity & Test Distance: Horizontal at 3 m										
Frequency (MHz)	Emission Level (dBuV/m)	Read Level (dBuV)	Limit (dBuV/m)	Margin (dB)	Antenna Factor (dB/m)	Cable Loss (dB)	Preamp Factor (dB)	Antenna Height (cm)	Table Angle (Degree)	Remark
5563.775	51.91	50.86	68.2	-16.29	31.68	6.49	37.12	113	57	Peak
5651.65	50.32	49.13	69.43	-19.11	31.85	6.62	37.28	113	57	Peak
5922.875	49.51	47.71	69.77	-20.26	32.29	7.01	37.5	113	57	Peak
5978.925	52.37	50.43	68.2	-15.83	32.37	7.08	37.51	113	57	Peak
Antenna Polarity & Test Distance: Vertical at 3 m										
Frequency (MHz)	Emission Level (dBuV/m)	Read Level (dBuV)	Limit (dBuV/m)	Margin (dB)	Antenna Factor (dB/m)	Cable Loss (dB)	Preamp Factor (dB)	Antenna Height (cm)	Table Angle (Degree)	Remark
5631.225	53.38	52.31	68.2	-14.82	31.79	6.56	37.28	198	57	Peak
5654.5	51.98	50.85	71.54	-19.56	31.85	6.62	37.34	198	57	Peak
5921.925	51.81	50.01	70.47	-18.66	32.29	7.01	37.5	198	57	Peak
5973.225	53.36	51.42	68.2	-14.84	32.37	7.08	37.51	198	57	Peak

Remarks:

- Emission Level = Read Level + Antenna Factor + Cable Loss - Preamp Factor
Margin value = Emission level – Limit value
- 5775 MHz: Fundamental Frequency
- *: Out of Restricted Band

9 kHz ~ 30 MHz Data:

The amplitude of spurious emissions attenuated more than 20 dB below the permissible value is not required to be report.

30 MHz ~ 1 GHz Worst-Case Data:

802.11n (HT20)

EUT Test Condition		Measurement Detail	
Channel	Channel 36	Frequency Range	30 MHz ~ 1 GHz
Input Power	120 Vac, 60 Hz	Detector Function	Peak (PK) Quasi-peak (QP)
Environmental Conditions	25 deg. C, 65 % RH	Tested By	Charles Hsiao

Antenna Polarity & Test Distance: Horizontal at 3 m										
Frequency (MHz)	Emission Level (dBuV/m)	Read Level (dBuV)	Limit (dBuV/m)	Margin (dB)	Antenna Factor (dB/m)	Cable Loss (dB)	Preamp Factor (dB)	Antenna Height (cm)	Table Angle (Degree)	Remark
34.86	23.14	40.27	40	-16.86	14.37	0.74	32.24	139	247	Peak
135.03	23.69	45.31	43.5	-19.81	9.25	1.38	32.25	139	321	Peak
292.71	26.45	42.7	46	-19.55	13.85	2.03	32.13	145	128	Peak
599.6	28.44	36.66	46	-17.56	21.1	2.87	32.19	105	128	Peak
813.1	31.29	36.02	46	-14.71	23.94	3.32	31.99	176	125	Peak
899.9	37.17	40.16	46	-8.83	25	3.49	31.48	139	351	Peak

Antenna Polarity & Test Distance: Vertical at 3 m										
Frequency (MHz)	Emission Level (dBuV/m)	Read Level (dBuV)	Limit (dBuV/m)	Margin (dB)	Antenna Factor (dB/m)	Cable Loss (dB)	Preamp Factor (dB)	Antenna Height (cm)	Table Angle (Degree)	Remark
66.72	28.52	52.16	40	-11.48	7.68	0.9	32.22	139	230	Peak
192.81	20.13	40.28	43.5	-23.37	10.51	1.61	32.27	125	175	Peak
300	23.89	40.1	46	-22.11	13.9	2.03	32.14	108	284	Peak
407.8	17.85	29.7	46	-28.15	17.95	2.41	32.21	128	211	Peak
673.1	29.11	34.78	46	-16.89	23.4	3.05	32.12	154	241	Peak
899.9	29.48	32.47	46	-16.52	25	3.49	31.48	139	311	Peak

Remarks:

- Emission Level = Read Level + Antenna Factor + Cable Loss - Preamp Factor
Margin value = Emission level – Limit value

802.11n (HT20)

EUT Test Condition		Measurement Detail	
Channel	Channel 165	Frequency Range	30 MHz ~ 1 GHz
Input Power	120 Vac, 60 Hz	Detector Function	Peak (PK) Quasi-peak (QP)
Environmental Conditions	25 deg. C, 65 % RH	Tested By	Charles Hsiao

Antenna Polarity & Test Distance: Horizontal at 3 m

Frequency (MHz)	Emission Level (dBuV/m)	Read Level (dBuV)	Limit (dBuV/m)	Margin (dB)	Antenna Factor (dB/m)	Cable Loss (dB)	Preamp Factor (dB)	Antenna Height (cm)	Table Angle (Degree)	Remark
44.04	11.85	33.41	40	-28.15	9.76	0.9	32.22	175	120	Peak
193.62	26.07	46.16	43.5	-17.43	10.57	1.61	32.27	136	238	Peak
299.73	31.79	48	46	-14.21	13.9	2.03	32.14	175	128	Peak
599.6	27.21	35.43	46	-18.79	21.1	2.87	32.19	175	140	Peak
825	32.06	37.1	46	-13.94	23.5	3.38	31.92	176	123	Peak
899.9	31.53	34.52	46	-14.47	25	3.49	31.48	168	120	Peak

Antenna Polarity & Test Distance: Vertical at 3 m

Frequency (MHz)	Emission Level (dBuV/m)	Read Level (dBuV)	Limit (dBuV/m)	Margin (dB)	Antenna Factor (dB/m)	Cable Loss (dB)	Preamp Factor (dB)	Antenna Height (cm)	Table Angle (Degree)	Remark
58.08	27.82	52.17	40	-12.18	6.98	0.9	32.23	170	121	Peak
193.35	19.98	40.07	43.5	-23.52	10.57	1.61	32.27	142	122	Peak
300	27.24	43.45	46	-18.76	13.9	2.03	32.14	139	140	Peak
599.6	28.72	36.94	46	-17.28	21.1	2.87	32.19	115	120	Peak
750.8	30.01	35.73	46	-15.99	23.2	3.22	32.14	138	104	Peak
899.9	32.28	35.27	46	-13.72	25	3.49	31.48	175	140	Peak

Remarks:

- Emission Level = Read Level + Antenna Factor + Cable Loss - Preamp Factor
Margin value = Emission level – Limit value

4.2 Conducted Emission Measurement

4.2.1 Limits of Conducted Emission Measurement

Frequency (MHz)	Conducted Limit (dBuV)	
	Quasi-peak	Average
0.15 - 0.5	66 - 56	56 - 46
0.50 - 5.0	56	46
5.0 - 30.0	60	50

- Note: 1. The lower limit shall apply at the transition frequencies.
 2. The limit decreases in line with the logarithm of the frequency in the range of 0.15 to 0.50 MHz.

4.2.2 Test Instruments

Description & Manufacturer	Model No.	Serial No.	Date Of Calibration	Due Date Of Calibration
Test Receiver ROHDE & SCHWARZ	ESCI	100613	Nov. 21, 2016	Nov. 20, 2017
RF signal cable (with 10dB PAD) Woken	5D-FB	Cable-cond1-01	Sep. 05, 2017	Sep. 04, 2018
LISN/AMN ROHDE & SCHWARZ (EUT)	ESH3-Z5	835239/001	Mar. 10, 2017	Mar. 09, 2018
LISN/AMN ROHDE & SCHWARZ (Peripheral)	ENV216	101196	Apr. 20, 2017	Apr. 19, 2018
Software ADT	BV ADT_Cond_ V7.3.7.3	NA	NA	NA

- Note: 1. The calibration interval of the above test instruments is 12 months and the calibrations are traceable to NML/ROC and NIST/USA.
 2. The test was performed in HwaYa Shielded Room 1.
 3. The VCCI Site Registration No. is C-2040.

4.2.3 Test Procedures

- a. The EUT was placed 0.4 meters from the conducting wall of the shielded room with EUT being connected to the power mains through a line impedance stabilization network (LISN). Other support units were connected to the power mains through another LISN. The two LISNs provide 50 ohm/ 50uH of coupling impedance for the measuring instrument.
- b. Both lines of the power mains connected to the EUT were checked for maximum conducted interference.
- c. The frequency range from 150 kHz to 30 MHz was searched. Emission levels under (Limit -20 dB) was not recorded.

Note: All modes of operation were investigated and the worst-case emissions are reported.

4.2.4 Deviation from Test Standard

No deviation.

4.2.5 Test Setup

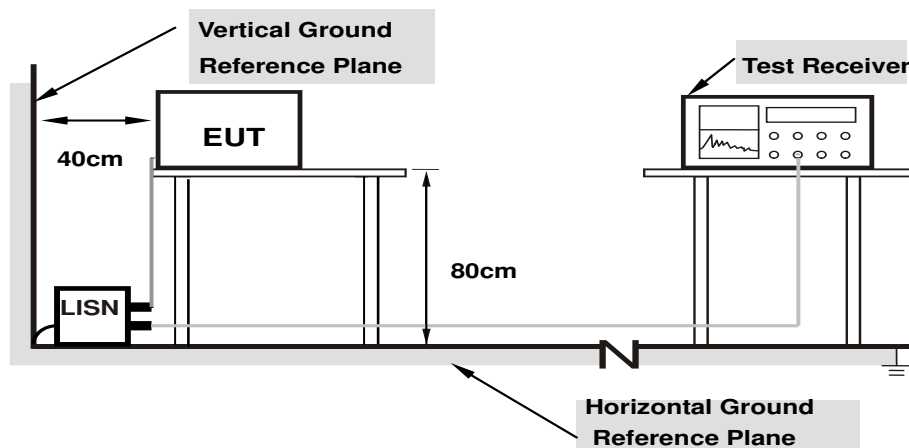

- Note:**
1. Support units were connected to second LISN.
 2. Both of LISNs (AMN) are 80 cm from EUT and at least 80 cm from other units and other metal planes

For the actual test configuration, please refer to the attached file (Test Setup Photo).

4.2.6 EUT Operating Conditions

- a. Placed the EUT on a testing table.
- b. Use the software to control the EUT under transmission condition continuously at specific channel frequency.

4.2.7 Test Results

Frequency Range	150kHz ~ 30MHz	Detector Function & Resolution Bandwidth	Quasi-Peak (QP) / Average (AV), 9kHz
Input Power	120Vac, 60Hz	Environmental Conditions	25°C, 65%RH
Tested by	Getaz Yang	Test Date	2017/10/6

Phase Of Power : Line (L)										
No	Frequency (MHz)	Correction Factor (dB)	Reading Value (dBuV)		Emission Level (dBuV)		Limit (dBuV)		Margin (dB)	
			Q.P.	AV.	Q.P.	AV.	Q.P.	AV.	Q.P.	AV.
1	0.19400	10.39	34.37	23.41	44.76	33.80	63.86	53.86	-19.10	-20.06
2	0.26200	10.40	31.31	15.76	41.71	26.16	61.37	51.37	-19.66	-25.21
3	0.32118	10.40	33.26	21.32	43.66	31.72	59.68	49.68	-16.02	-17.96
4	0.42915	10.41	34.71	23.69	45.12	34.10	57.27	47.27	-12.15	-13.17
5	0.65761	10.41	29.90	17.49	40.31	27.90	56.00	46.00	-15.69	-18.10
6	1.07800	10.43	27.59	16.45	38.02	26.88	56.00	46.00	-17.98	-19.12

Remarks:

1. Q.P. and AV. are abbreviations of quasi-peak and average individually.
2. The emission levels of other frequencies were very low against the limit.
3. Margin value = Emission level – Limit value
4. Correction factor = Insertion loss + Cable loss
5. Emission Level = Correction Factor + Reading Value

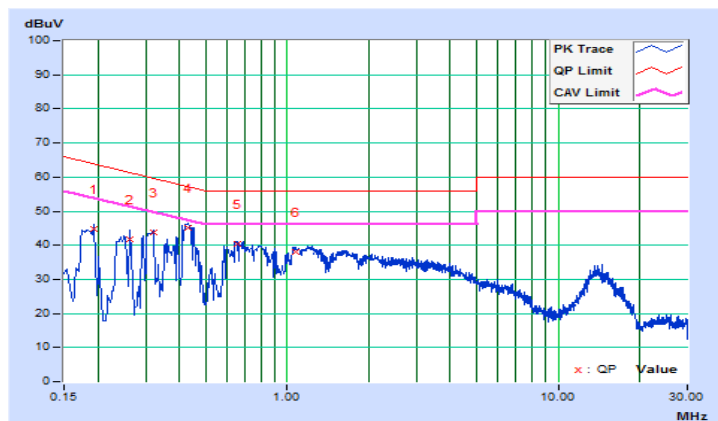

Frequency Range	150kHz ~ 30MHz	Detector Function & Resolution Bandwidth	Quasi-Peak (QP) / Average (AV), 9kHz
Input Power	120Vac, 60Hz	Environmental Conditions	25°C, 65%RH
Tested by	Getaz Yang	Test Date	2017/10/6

Phase Of Power : Neutral (N)										
No	Frequency (MHz)	Correction Factor (dB)	Reading Value (dBuV)		Emission Level (dBuV)		Limit (dBuV)		Margin (dB)	
			Q.P.	AV.	Q.P.	AV.	Q.P.	AV.	Q.P.	AV.
1	0.17400	10.16	33.51	20.14	43.67	30.30	64.77	54.77	-21.10	-24.47
2	0.26152	10.16	31.23	14.66	41.39	24.82	61.38	51.38	-19.99	-26.56
3	0.32118	10.17	32.79	20.14	42.96	30.31	59.68	49.68	-16.72	-19.37
4	0.37421	10.17	29.81	18.70	39.98	28.87	58.41	48.41	-18.43	-19.54
5	0.42802	10.17	34.89	24.10	45.06	34.27	57.29	47.29	-12.23	-13.02
6	0.65000	10.18	28.34	16.70	38.52	26.88	56.00	46.00	-17.48	-19.12

Remarks:

1. Q.P. and AV. are abbreviations of quasi-peak and average individually.
2. The emission levels of other frequencies were very low against the limit.
3. Margin value = Emission level – Limit value
4. Correction factor = Insertion loss + Cable loss
5. Emission Level = Correction Factor + Reading Value

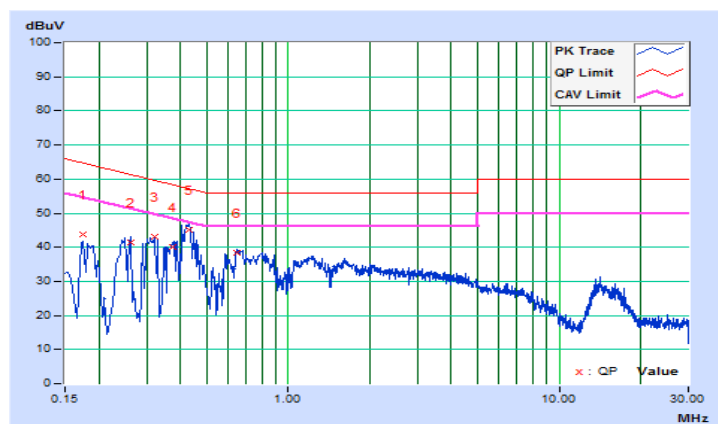

4.3 Transmit Power Measurement

4.3.1 Limits of Transmit Power Measurement

Operation Band	EUT Category		Limit
U-NII-1		Outdoor Access Point	1 Watt (30 dBm) (Max. e.i.r.p \leq 125 mW (21 dBm) at any elevation angle above 30 degrees as measured from the horizon)
		Fixed point-to-point Access Point	1 Watt (30 dBm)
	√	Indoor Access Point	1 Watt (30 dBm)
		Mobile and Portable client device	250 mW (24 dBm)
U-NII-2A	-		250 mW (24 dBm) or 11 dBm + 10 log B*
U-NII-2C	-		250 mW (24 dBm) or 11 dBm + 10 log B*
U-NII-3	√		1 Watt (30 dBm)

*B is the 26 dB emission bandwidth in megahertz

Per KDB 662911 Method of conducted output power measurement on IEEE 802.11 devices,

Array Gain = 0 dB (i.e., no array gain) for $N_{ANT} \leq 4$;

Array Gain = 0 dB (i.e., no array gain) for channel widths ≥ 40 MHz for any N_{ANT} ;

Array Gain = $5 \log(N_{ANT}/N_{SS})$ dB or 3 dB, whichever is less for 20 MHz channel widths with $N_{ANT} \geq 5$.

For power measurements on all other devices: Array Gain = $10 \log(N_{ANT}/N_{SS})$ dB.

4.3.2 Test Setup

<Power Output Measurement>

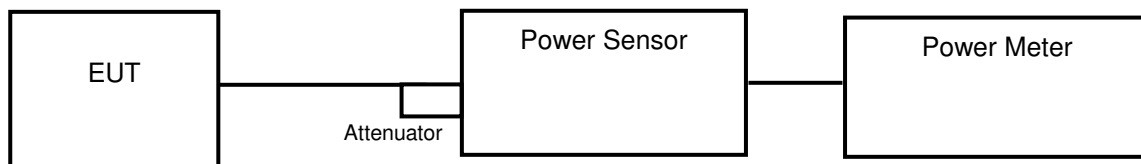

or

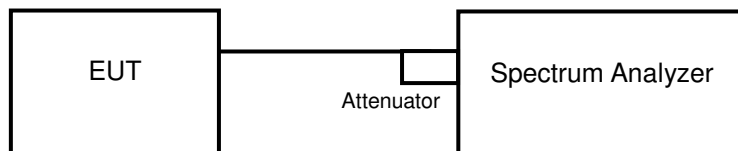

<26 dB Bandwidth>

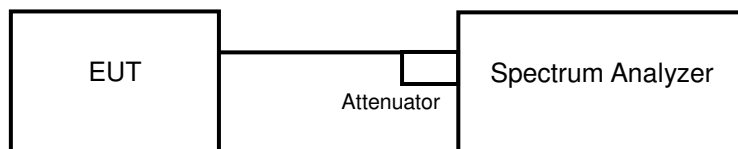

4.3.3 Test Instruments

Refer to section 4.1.2 to get information of above instrument.

4.3.4 Test Procedure

Average Power Measurement

<802.11a, 802.11n (HT20), 802.11n (HT40)>

Method PM is used to perform output power measurement, trigger and gating function of wide band power meter is enabled to measure max output power of TX on burst. Duty factor is not added to measured value.

<802.11ac (VHT80)>

Method SA-1 is used to perform output power measurement, trigger and gating function of spectrum analyzer is enabled to measure max output power of TX on burst. Duty factor is not added to measured value.

26 dB Bandwidth

- 1) Set RBW = approximately 1 % of the emission bandwidth.
- 2) Set the VBW > RBW.
- 3) Detector = Peak.
- 4) Trace mode = max hold.
- 5) Measure the maximum width of the emission that is 26 dB down from the peak of the emission. Compare this with the RBW setting of the analyzer. Readjust RBW and repeat measurement as needed until the RBW/EBW ratio is approximately 1 %.

4.3.5 Deviation from Test Standard

No deviation.

4.3.6 EUT Operating Conditions

The software provided by client to enable the EUT under transmission condition continuously at lowest, middle and highest channel frequencies individually.

4.3.7 Test Result

Power Output:
802.11a

Channel	Frequency (MHz)	Maximum Conducted Power (mW)	Maximum Conducted Power (dBm)	Power Limit (dBm)	Pass / Fail
36	5180	81.85	19.13	30	Pass
44	5220	185.78	22.69	30	Pass
48	5240	176.20	22.46	30	Pass
149	5745	58.61	17.68	30	Pass
157	5785	173.38	22.39	30	Pass
161	5805	171.40	22.34	30	Pass

802.11n (HT20)
1Tx

Channel	Frequency (MHz)	Maximum Conducted Power (mW)	Maximum Conducted Power (dBm)	Power Limit (dBm)	Pass / Fail
36	5180	90.36	19.56	30	Pass
44	5220	107.65	20.32	30	Pass
48	5240	96.16	19.83	30	Pass
149	5745	93.11	19.69	30	Pass
157	5785	103.04	20.13	30	Pass
161	5805	98.17	19.92	30	Pass

2Tx

Channel	Frequency (MHz)	Maximum Conducted Power (dBm)		Total Power (mW)	Total Power (dBm)	Power Limit (dBm)	Pass / Fail
		Chain 0	Chain 1				
36	5180	16.15	17.08	92.26	19.65	30	Pass
44	5220	16.61	17.94	108.04	20.34	30	Pass
48	5240	16.44	17.27	97.39	19.89	30	Pass
149	5745	16.04	17.36	94.629	19.76	30	Pass
157	5785	16.27	17.85	103.318	20.14	30	Pass
161	5805	16.37	17.50	99.585	19.98	30	Pass

3Tx

Channel	Frequency (MHz)	Maximum Conducted Power (dBm)			Total Power (mW)	Total Power (dBm)	Power Limit (dBm)	Pass / Fail
		Chain 0	Chain 1	Chain 2				
36	5180	14.23	15.65	14.78	93.27	19.70	30	Pass
44	5220	15.14	16.43	15.27	110.26	20.42	30	Pass
48	5240	14.84	16.16	14.35	99.01	19.96	30	Pass
149	5745	14.66	15.97	14.54	97.223	19.88	30	Pass
157	5785	15.08	16.38	15.37	110.097	20.42	30	Pass
161	5805	14.96	16.25	15.23	106.845	20.29	30	Pass

802.11n (HT40)
1Tx

Channel	Frequency (MHz)	Maximum Conducted Power (mW)	Maximum Conducted Power (dBm)	Power Limit (dBm)	Pass / Fail
38	5190	29.31	14.67	30	Pass
46	5230	84.33	19.26	30	Pass
151	5755	52.84	17.23	30	Pass
159	5795	58.75	17.69	30	Pass

2Tx

Channel	Frequency (MHz)	Maximum Conducted Power (dBm)		Total Power (mW)	Total Power (dBm)	Power Limit (dBm)	Pass / Fail
		Chain 0	Chain 1				
38	5190	11.26	12.09	29.55	14.71	30	Pass
46	5230	15.84	16.73	85.47	19.32	30	Pass
151	5755	13.64	14.89	53.953	17.32	30	Pass
159	5795	14.35	15.54	63.037	18.00	30	Pass

3Tx

Channel	Frequency (MHz)	Maximum Conducted Power (dBm)			Total Power (mW)	Total Power (dBm)	Power Limit (dBm)	Pass / Fail
		Chain 0	Chain 1	Chain 2				
38	5190	9.74	10.52	9.88	30.42	14.83	30	Pass
46	5230	14.25	15.75	14.32	91.23	19.60	30	Pass
151	5755	12.22	13.02	12.42	54.175	17.34	30	Pass
159	5795	12.80	14.04	12.83	63.593	18.03	30	Pass

802.11ac (VHT80)
1Tx

Channel	Frequency (MHz)	Maximum Conducted Power (mW)	Maximum Conducted Power (dBm)	Power Limit (dBm)	Pass / Fail
42	5210	13.43	11.28	30	Pass
155	5775	12.39	10.93	30	Pass

2Tx

Channel	Frequency (MHz)	Maximum Conducted Power (dBm)		Total Power (mW)	Total Power (dBm)	Power Limit (dBm)	Pass / Fail
		Chain 0	Chain 1				
42	5210	7.84	8.72	13.53	11.31	30	Pass
155	5775	7.92	8.16	12.741	11.05	30	Pass

3Tx

Channel	Frequency (MHz)	Maximum Conducted Power (dBm)			Total Power (mW)	Total Power (dBm)	Power Limit (dBm)	Pass / Fail
		Chain 0	Chain 1	Chain 2				
42	5210	6.23	7.31	6.42	13.97	11.45	30	Pass
155	5775	6.22	6.77	6.03	12.950	11.12	30	Pass

26 dB Bandwidth:
802.11a

Channel	Frequency (MHz)	26 dBc Bandwidth (MHz)
36	5180	22.66
44	5220	23.67
48	5240	23.25

802.11n (HT20)
1Tx

Channel	Frequency (MHz)	26 dBc Bandwidth (MHz)
36	5180	23.18
44	5220	23.28
48	5240	23.27

2Tx

Channel	Frequency (MHz)	26 dBc Bandwidth (MHz)	
		Chain 0	Chain 1
36	5180	23.22	23.64
44	5220	23.03	23.60
48	5240	23.47	23.25

3Tx

Channel	Frequency (MHz)	26 dBc Bandwidth (MHz)		
		Chain 0	Chain 1	Chain 2
36	5180	23.67	24.33	23.27
44	5220	23.66	23.27	23.76
48	5240	23.17	23.61	23.43

802.11n (HT40)
1Tx

Channel	Frequency (MHz)	26 dBc Bandwidth (MHz)
38	5190	47.29
46	5230	46.70

2Tx

Channel	Frequency (MHz)	26 dBc Bandwidth (MHz)	
		Chain 0	Chain 1
38	5190	46.73	46.46
46	5230	47.17	46.91

3Tx

Channel	Frequency (MHz)	26 dBc Bandwidth (MHz)		
		Chain 0	Chain 1	Chain 2
38	5190	46.58	46.83	45.51
46	5230	47.15	46.65	45.10

802.11ac (VHT80)
1Tx

Channel	Frequency (MHz)	26 dBc Bandwidth (MHz)
42	5210	89.65

2Tx

Channel	Frequency (MHz)	26 dBc Bandwidth (MHz)	
		Chain 0	Chain 1
42	5210	91.60	88.88

3Tx

Channel	Frequency (MHz)	26 dBc Bandwidth (MHz)		
		Chain 0	Chain 1	Chain 2
42	5210	91.19	91.36	93.73

Spectrum Plot of Worst Value

802.11a

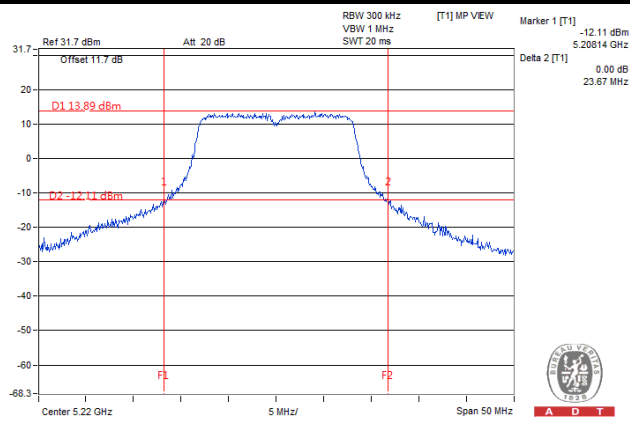

802.11n (HT20)

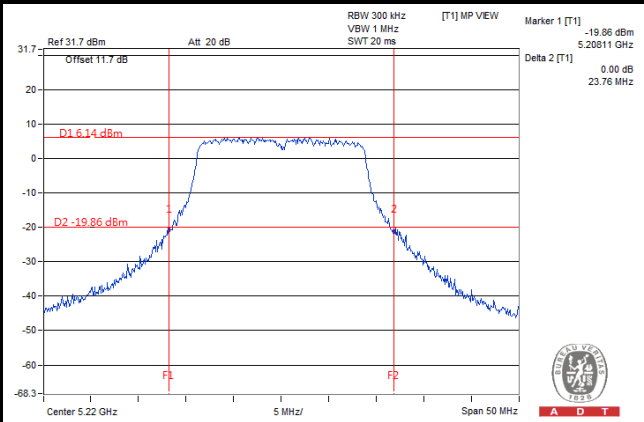

802.11n (HT40)

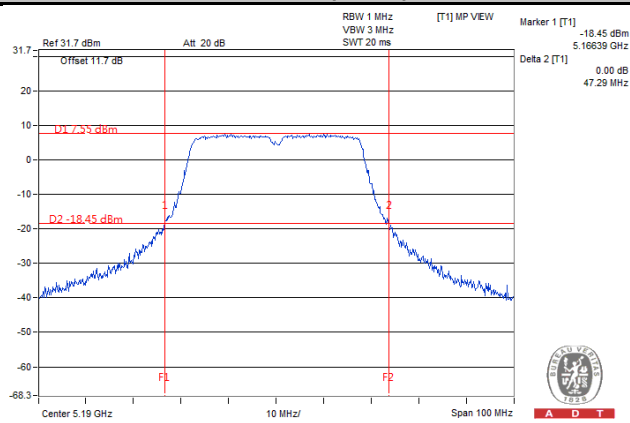

802.11ac (VHT80)

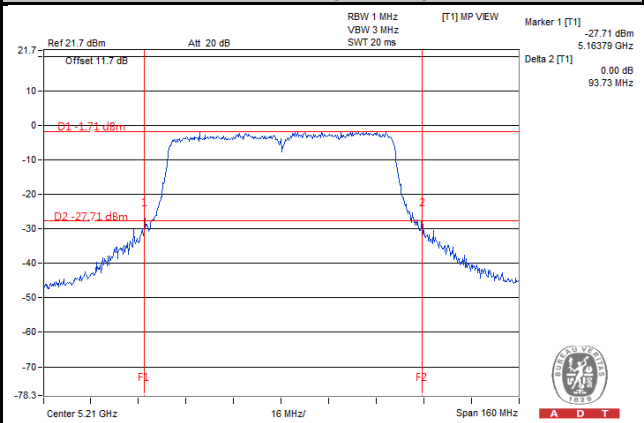

4.4 Occupied Bandwidth Measurement

4.4.1 Test Setup

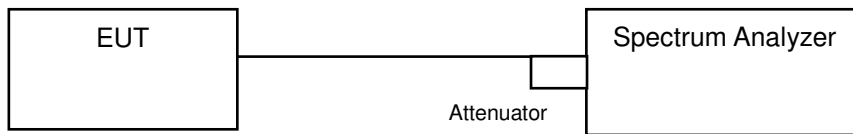

4.4.2 Test Instruments

Refer to section 4.1.2 to get information of above instrument.

4.4.3 Test Procedure

The transmitter output was connected to the spectrum analyzer through an attenuator. The bandwidth of the fundamental frequency was measured by spectrum analyzer with resolution bandwidth in the range of 1 % to 5 % of the anticipated emission bandwidth, and a video bandwidth at least 3x the resolution bandwidth and set the detector to SAMPLE. The width of a frequency band such that, below the lower and above the upper frequency limits, the mean powers emitted are each equal to a specified percentage 0.5 % of the total mean power of a given emission.

4.4.4 Test Results

802.11a

Channel	Channel Frequency (MHz)	Occupied Bandwidth (MHz)
36	5180	16.83
40	5200	17.20
48	5240	16.97
149	5745	16.78
157	5785	16.75
161	5805	16.75

802.11n (HT20)

1Tx

Channel	Channel Frequency (MHz)	Occupied Bandwidth (MHz)
36	5180	18.30
40	5200	17.98
48	5240	17.98
149	5745	17.84
157	5785	17.85
161	5805	17.90

2Tx

Channel	Channel Frequency (MHz)	Occupied Bandwidth (MHz)	
		Chain 0	Chain 1
36	5180	18.80	17.93
40	5200	18.30	17.98
48	5240	18.80	17.98
149	5745	17.84	17.84
157	5785	17.90	17.90
161	5805	17.85	17.90

3Tx

Channel	Channel Frequency (MHz)	Occupied Bandwidth (MHz)		
		Chain 0	Chain 1	Chain 2
36	5180	18.80	17.98	17.88
40	5200	17.98	17.93	17.93
48	5240	17.98	18.30	17.93
149	5745	17.93	17.93	17.88
157	5785	17.85	17.85	17.85
161	5805	17.90	17.90	17.85

802.11n (HT40)
1Tx

Channel	Channel Frequency (MHz)	Occupied Bandwidth (MHz)
38	5190	37.44
46	5230	37.05
151	5755	36.70
159	5795	36.67

2Tx

Channel	Channel Frequency (MHz)	Occupied Bandwidth (MHz)	
		Chain 0	Chain 1
38	5190	37.44	37.18
46	5230	37.44	37.18
151	5755	36.86	36.86
159	5795	37.00	36.83

3Tx

Channel	Channel Frequency (MHz)	Occupied Bandwidth (MHz)		
		Chain 0	Chain 1	Chain 2
38	5190	37.31	37.18	37.05
46	5230	37.44	37.18	37.31
151	5755	36.86	36.70	36.86
159	5795	36.67	36.67	36.67

802.11ac (VHT80)

1Tx

Channel	Channel Frequency (MHz)	Occupied Bandwidth (MHz)
42	5210	76.12
155	5775	76.12

2Tx

Channel	Channel Frequency (MHz)	Occupied Bandwidth (MHz)	
		Chain 0	Chain 1
42	5210	76.12	76.12
155	5775	76.12	75.96

3Tx

Channel	Channel Frequency (MHz)	Occupied Bandwidth (MHz)		
		Chain 0	Chain 1	Chain 2
42	5210	75.80	76.12	75.96
155	5775	76.12	76.28	76.12

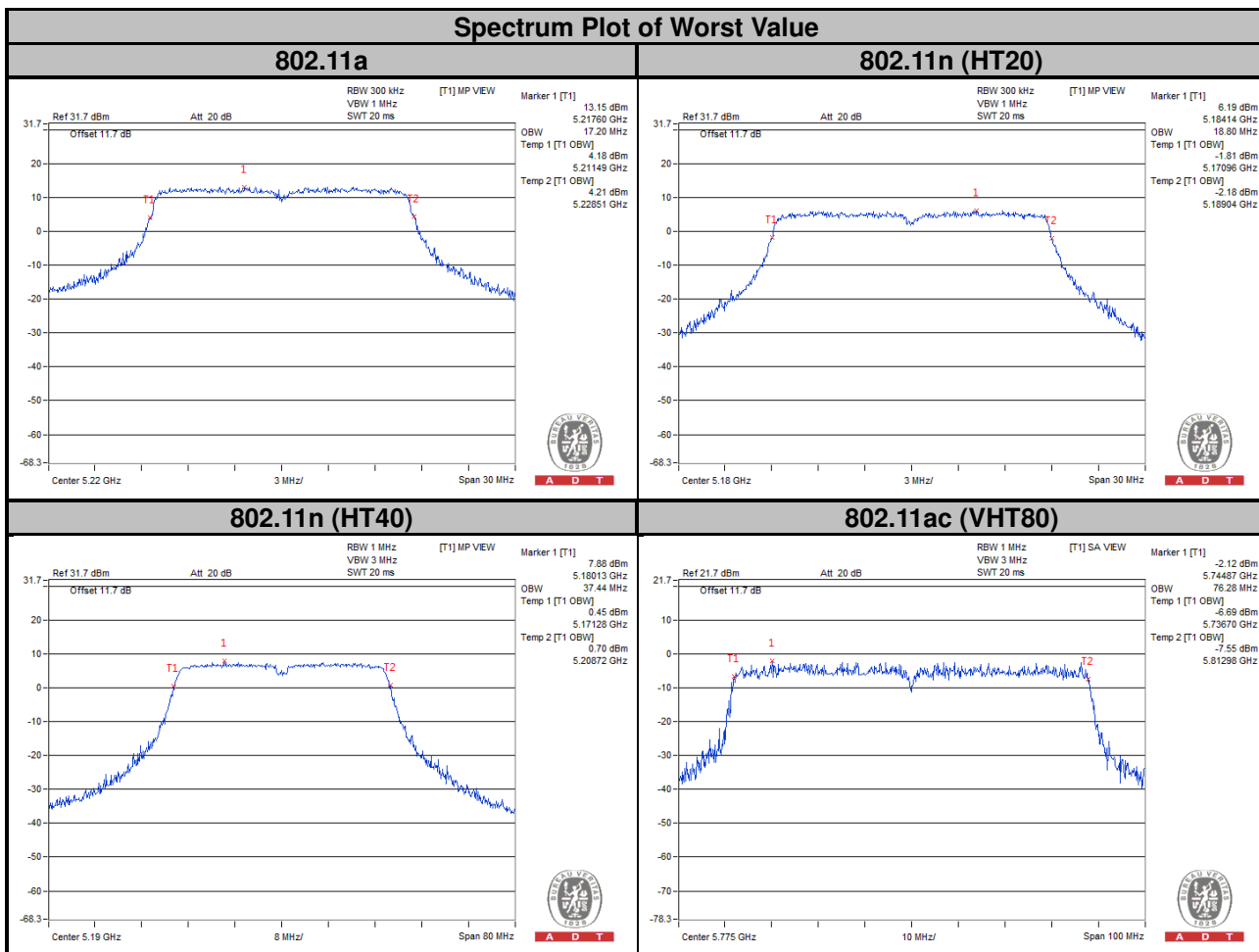

4.5 Peak Power Spectral Density Measurement

4.5.1 Limits of Peak Power Spectral Density Measurement

Operation Band	EUT Category		Limit
U-NII-1		Outdoor Access Point	17 dBm/MHz
		Fixed point-to-point Access Point	
	√	Indoor Access Point	
		Mobile and Portable client device	11 dBm/MHz
U-NII-2A	--		11 dBm/MHz
U-NII-2C	--		11 dBm/MHz
U-NII-3	√		30 dBm/500 kHz

4.5.2 Test Setup

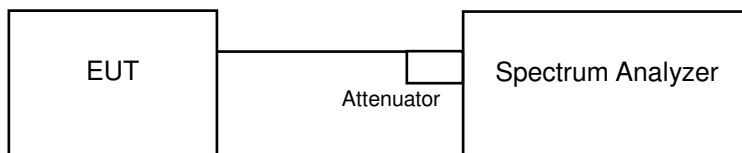

4.5.3 Test Instruments

Refer to section 4.1.3 to get information of above instrument.

4.5.4 Test Procedures

For U-NII-1 band:

Using method SA-2

1. Set span to encompass the entire emission bandwidth (EBW) of the signal.
2. Set RBW = 1 MHz, Set VBW \geq 3 RBW, Detector = RMS
3. Sweep time = auto, trigger set to "free run".
4. Trace average at least 100 traces in power averaging mode.
5. Record the max value and add $10 \log(1/\text{duty cycle})$

※For U-NII-3:

1. Set span to encompass the entire emission bandwidth (EBW) of the signal.
2. Set RBW = 500 kHz, Set VBW \geq 3 RBW, Detector = RMS
3. Use the peak marker function to determine the maximum power level in any 500 kHz band segment within the fundamental EBW.
4. Sweep time = auto, trigger set to "free run".
5. Trace average at least 100 traces in power averaging mode.
6. Record the max value and add $10 \log(1/\text{duty cycle})$

4.5.5 Deviation from Test Standard

No deviation.

4.5.6 EUT Operating Conditions

The software provided by client to enable the EUT under transmission condition continuously at lowest, middle and highest channel frequencies individually.

4.5.7 Test Results

For U-NII-1 Band

802.11a

Channel	Frequency (MHz)	PSD w/o Duty Factor (dBm/MHz)	Duty Factor (dB)	PSD with Duty Factor (dBm/MHz)	Maximum Limit (dBm/MHz)	Pass / Fail
36	5180	6.18	0.15	6.33	17	Pass
44	5220	9.97	0.15	10.12	17	Pass
48	5240	9.72	0.15	9.87	17	Pass

Note: Refer to section 3.3 for duty cycle spectrum plot.

802.11n (HT20)

1Tx

Channel	Frequency (MHz)	PSD w/o Duty Factor (dBm/MHz)	Duty Factor (dB)	PSD with Duty Factor (dBm/MHz)	Maximum Limit (dBm/MHz)	Pass / Fail
36	5180	6.28	0.13	6.41	17	Pass
44	5220	7.16	0.13	7.29	17	Pass
48	5240	6.56	0.13	6.69	17	Pass

Note: Refer to section 3.3 for duty cycle spectrum plot.

2Tx

Channel	Frequency (MHz)	PSD (dBm/MHz)		Duty Factor (dB)	Total PSD with Duty Factor (dBm/MHz)	Max. Limit (dBm/MHz)	Pass / Fail
		Chain 0	Chain 1				
36	5180	2.91	4.89	0.13	7.15	16.69	Pass
44	5220	3.41	5.43	0.13	7.68	16.69	Pass
48	5240	3.33	5.17	0.13	7.49	16.69	Pass

Note:

- Method 1 of power density measurement of KDB 662911 is using for calculating total power density. Total power density is summing entire spectra across corresponding frequency bins on the various outputs by computer.
- Directional gain = $3.3\text{dBi} + 10\log(2) = 6.31\text{dBi} > 6\text{dBi}$, so the power density limit shall be reduced to $17 - (6.31 - 6) = 16.69\text{dBm}$.
- Refer to section 3.3 for duty cycle spectrum plot.

3Tx

Channel	Frequency (MHz)	PSD (dBm/MHz)			Duty Factor (dB)	Total PSD with Duty Factor (dBm/MHz)	Max. Limit (dBm/MHz)	Pass / Fail
		Chain 0	Chain 1	Chain 2				
36	5180	0.84	2.89	2.50	0.13	7.06	14.93	Pass
44	5220	1.89	3.81	2.66	0.13	7.76	14.93	Pass
48	5240	1.75	3.67	2.22	0.13	7.53	14.93	Pass

Note:

- Method 1 of power density measurement of KDB 662911 is using for calculating total power density. Total power density is summing entire spectra across corresponding frequency bins on the various outputs by computer.
- Directional gain = $3.3\text{dBi} + 10\log(3) = 8.07\text{dBi} > 6\text{dBi}$, so the power density limit shall be reduced to $17-(8.07-6) = 14.93\text{dBm}$.
- Refer to section 3.3 for duty cycle spectrum plot.

802.11n (HT40)

1Tx

Channel	Frequency (MHz)	PSD w/o Duty Factor (dBm/MHz)	Duty Factor (dB)	PSD with Duty Factor (dBm/MHz)	Maximum Limit (dBm/MHz)	Pass / Fail
38	5190	-1.68	0.45	-1.23	17	Pass
46	5230	3.16	0.45	3.61	17	Pass

Note: Refer to section 3.3 for duty cycle spectrum plot.

2Tx

Channel	Frequency (MHz)	PSD (dBm/MHz)		Duty Factor (dB)	Total PSD with Duty Factor (dBm/MHz)	Max. Limit (dBm/MHz)	Pass / Fail
		Chain 0	Chain 1				
38	5190	-5.34	-3.44	0.39	-0.89	16.69	Pass
46	5230	-0.51	1.31	0.39	3.89	16.69	Pass

Note:

- Method 1 of power density measurement of KDB 662911 is using for calculating total power density. Total power density is summing entire spectra across corresponding frequency bins on the various outputs by computer.
- Directional gain = $3.3\text{dBi} + 10\log(2) = 6.31\text{dBi} > 6\text{dBi}$, so the power density limit shall be reduced to $17-(6.31-6) = 16.69\text{dBm}$.
- Refer to section 3.3 for duty cycle spectrum plot.

3Tx

Channel	Frequency (MHz)	PSD (dBm/MHz)			Duty Factor (dB)	Total PSD with Duty Factor (dBm/MHz)	Max. Limit (dBm/MHz)	Pass / Fail
		Chain 0	Chain 1	Chain 2				
38	5190	-6.45	-4.68	-4.77	0.39	-0.07	14.93	Pass
46	5230	-1.63	0.33	-0.41	0.39	4.66	14.93	Pass

Note:

- Method 1 of power density measurement of KDB 662911 is using for calculating total power density. Total power density is summing entire spectra across corresponding frequency bins on the various outputs by computer.
- Directional gain = $3.3\text{dBi} + 10\log(3) = 8.07\text{dBi} > 6\text{dBi}$, so the power density limit shall be reduced to $17 - (8.07 - 6) = 14.93\text{dBm}$.
- Refer to section 3.3 for duty cycle spectrum plot.

802.11ac (VHT80)

1Tx

Channel	Frequency (MHz)	PSD w/o Duty Factor (dBm/MHz)	Duty Factor (dB)	PSD with Duty Factor (dBm/MHz)	Maximum Limit (dBm/MHz)	Pass / Fail
42	5210	-9.82	0.74	-9.08	17	Pass

Note: Refer to section 3.3 for duty cycle spectrum plot.

2Tx

Channel	Frequency (MHz)	PSD (dBm/MHz)		Duty Factor (dB)	Total PSD with Duty Factor (dBm/MHz)	Max. Limit (dBm/MHz)	Pass / Fail
		Chain 0	Chain 1				
42	5210	-13.46	-11.71	0.79	-8.70	16.69	Pass

Note:

- Method 1 of power density measurement of KDB 662911 is using for calculating total power density. Total power density is summing entire spectra across corresponding frequency bins on the various outputs by computer.
- Directional gain = $3.3\text{dBi} + 10\log(2) = 6.31\text{dBi} > 6\text{dBi}$, so the power density limit shall be reduced to $17 - (6.31 - 6) = 16.69\text{dBm}$.
- Refer to section 3.3 for duty cycle spectrum plot.

3Tx

Channel	Frequency (MHz)	PSD (dBm/MHz)			Duty Factor (dB)	Total PSD with Duty Factor (dBm/MHz)	Max. Limit (dBm/MHz)	Pass / Fail
		Chain 0	Chain 1	Chain 2				
42	5210	-14.86	-12.78	-13.46	0.73	-8.12	14.93	Pass

Note:

1. Method 1 of power density measurement of KDB 662911 is using for calculating total power density. Total power density is summing entire spectra across corresponding frequency bins on the various outputs by computer.
2. Directional gain = $3.3\text{dBi} + 10\log(3) = 8.07\text{dBi} > 6\text{dBi}$, so the power density limit shall be reduced to $17 - (8.07 - 6) = 14.93\text{dBm}$.
3. Refer to section 3.3 for duty cycle spectrum plot.

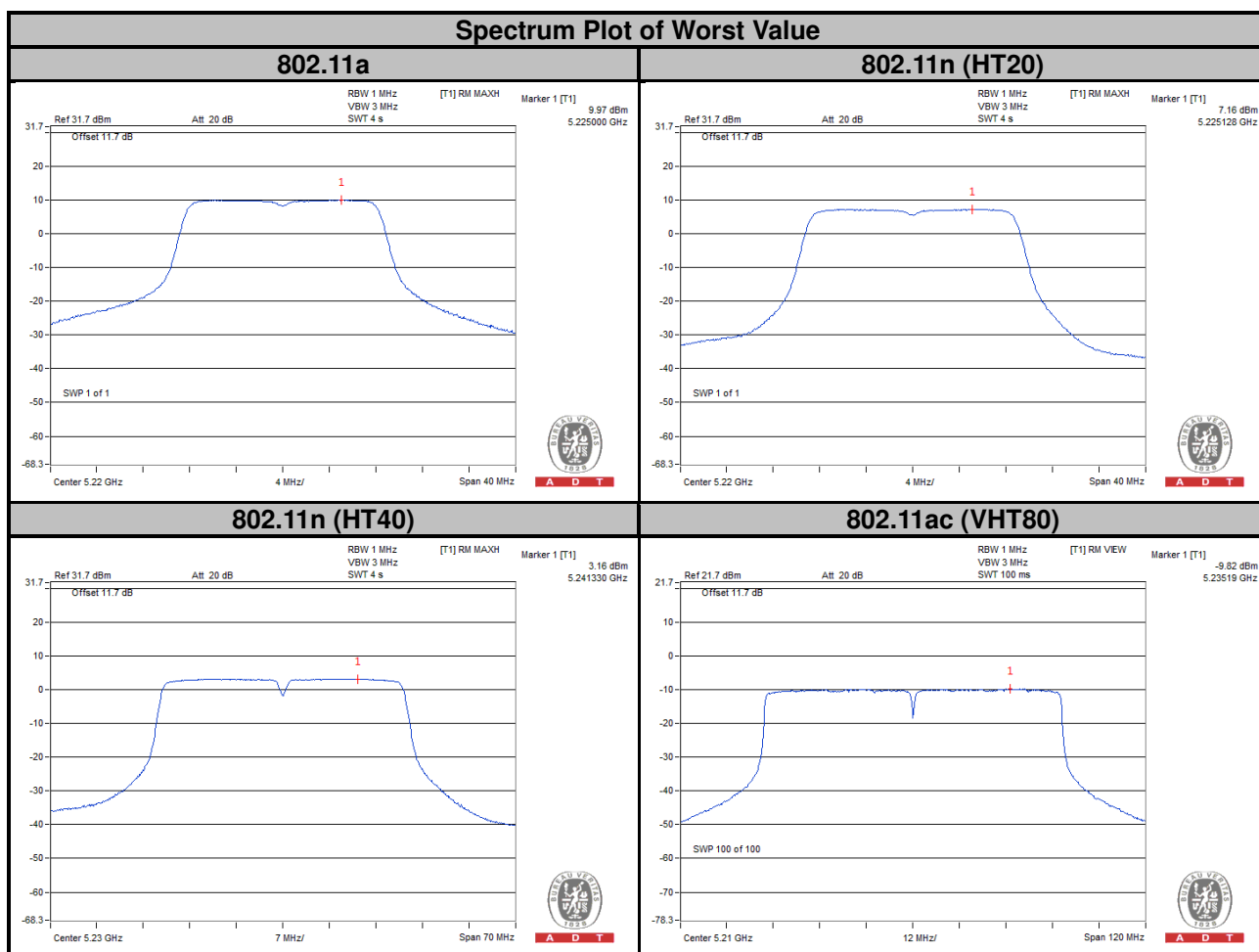

For U-NII-3 Band

802.11a

Channel	Frequency (MHz)	PSD w/o Duty Factor (dBm/500 kHz)	Duty Factor (dB)	PSD with Duty Factor (dBm/500 kHz)	Limit (dBm/500 kHz)	Pass / Fail
149	5745	2.45	0.15	2.60	30	Pass
157	5785	7.12	0.15	7.27	30	Pass
161	5805	7.68	0.15	7.83	30	Pass

Note: Refer to section 3.3 for duty cycle spectrum plot.

802.11n (HT20)

1Tx

Channel	Frequency (MHz)	PSD w/o Duty Factor (dBm/500 kHz)	Duty Factor (dB)	PSD with Duty Factor (dBm/500 kHz)	Limit (dBm/500 kHz)	Pass / Fail
149	5745	4.43	0.13	4.56	30	Pass
157	5785	4.73	0.13	4.86	30	Pass
161	5805	4.79	0.13	4.92	30	Pass

Note: Refer to section 3.3 for duty cycle spectrum plot.

2Tx

Tx Chain	Channel	Frequency (MHz)	PSD (dBm/500 kHz)	10 log (N=2) dB	Duty Factor (dB)	Total PSD with Duty Factor (dBm/500 kHz)	Limit (dBm/500 kHz)	Pass / Fail
0	149	5745	0.71	3.01	0.13	3.85	27.98	Pass
	157	5785	1.15	3.01	0.13	4.29	27.98	Pass
	161	5805	1.45	3.01	0.13	4.59	27.98	Pass
1	149	5745	1.91	3.01	0.13	5.05	27.98	Pass
	157	5785	2.22	3.01	0.13	5.36	27.98	Pass
	161	5805	1.91	3.01	0.13	5.05	27.98	Pass

Note:

- Method 1 of power density measurement of KDB 662911 is using for calculating total power density. Total power density is summing entire spectra across corresponding frequency bins on the various outputs by computer.
- Directional gain = $5.01\text{dBi} + 10\log(2) = 8.02\text{dBi} > 6\text{dBi}$, so the power density limit shall be reduced to $30-(8.02-6) = 27.98\text{dBm}$.
- Refer to section 3.3 for duty cycle spectrum plot.

3Tx

TX Chain	Channel	Frequency (MHz)	PSD (dBm/500 kHz)	10 log (N=3) dB	Duty Factor (dB)	Total PSD with Duty Factor (dBm/500 kHz)	Limit (dBm/500 kHz)	Pass / Fail
0	149	5745	-0.38	4.77	0.13	4.52	26.22	Pass
	157	5785	0.11	4.77	0.13	5.01	26.22	Pass
	161	5805	0.70	4.77	0.13	5.60	26.22	Pass
1	149	5745	0.38	4.77	0.13	5.28	26.22	Pass
	157	5785	0.77	4.77	0.13	5.67	26.22	Pass
	161	5805	1.12	4.77	0.13	6.02	26.22	Pass
2	149	5745	-0.86	4.77	0.13	4.04	26.22	Pass
	157	5785	0.17	4.77	0.13	5.07	26.22	Pass
	161	5805	0.80	4.77	0.13	5.70	26.22	Pass

Note:

- Method 1 of power density measurement of KDB 662911 is using for calculating total power density. Total power density is summing entire spectra across corresponding frequency bins on the various outputs by computer.
- Directional gain = $5.01\text{dBi} + 10\log(3) = 9.78\text{dBi} > 6\text{dBi}$, so the power density limit shall be reduced to $30 - (9.78 - 6) = 26.22\text{dBm}$.
- Refer to section 3.3 for duty cycle spectrum plot.

802.11n (HT40)

1Tx

Channel	Frequency (MHz)	PSD w/o Duty Factor (dBm/500 kHz)	Duty Factor (dB)	PSD with Duty Factor (dBm/500 kHz)	Limit (dBm/500 kHz)	Pass / Fail
151	5755	-1.23	0.45	-0.78	30	Pass
159	5795	-0.33	0.45	0.12	30	Pass

Note: Refer to section 3.3 for duty cycle spectrum plot.

2Tx

TX Chain	Channel	Frequency (MHz)	PSD (dBm/500 kHz)	10 log (N=2) dB	Duty Factor (dB)	Total PSD with Duty Factor (dBm/500 kHz)	Limit (dBm/500 kHz)	Pass / Fail
0	151	5755	-4.46	3.01	0.39	-1.06	27.98	Pass
	159	5795	-3.36	3.01	0.39	0.04	27.98	Pass
1	151	5755	-3.84	3.01	0.39	-0.44	27.98	Pass
	159	5795	-2.63	3.01	0.39	0.77	27.98	Pass

Note:

- Method 1 of power density measurement of KDB 662911 is using for calculating total power density. Total power density is summing entire spectra across corresponding frequency bins on the various outputs by computer.
- Directional gain = $5.01\text{dBi} + 10\log(2) = 8.02\text{dBi} > 6\text{dBi}$, so the power density limit shall be reduced to $30 - (8.02 - 6) = 27.98\text{dBm}$.
- Refer to section 3.3 for duty cycle spectrum plot.

3Tx

TX Chain	Channel	Frequency (MHz)	PSD (dBm/500 kHz)	10 log (N=3) dB	Duty Factor (dB)	Total PSD with Duty Factor (dBm/500 kHz)	Limit (dBm/500 kHz)	Pass / Fail
0	151	5755	-5.93	4.77	0.39	-0.77	26.22	Pass
	159	5795	-4.82	4.77	0.39	0.34	26.22	Pass
1	151	5755	-5.45	4.77	0.39	-0.29	26.22	Pass
	159	5795	-4.37	4.77	0.39	0.79	26.22	Pass
2	151	5755	-6.19	4.77	0.39	-1.03	26.22	Pass
	159	5795	-5.21	4.77	0.39	-0.05	26.22	Pass

Note:

- Method 1 of power density measurement of KDB 662911 is using for calculating total power density. Total power density is summing entire spectra across corresponding frequency bins on the various outputs by computer.
- Directional gain = $5.01\text{dBi} + 10\log(3) = 9.78\text{dBi} > 6\text{dBi}$, so the power density limit shall be reduced to $30 - (9.78 - 6) = 26.22\text{dBm}$.
- Refer to section 3.3 for duty cycle spectrum plot.

802.11ac (VHT80)

1Tx

Channel	Frequency (MHz)	PSD w/o Duty Factor (dBm/500 kHz)	Duty Factor (dB)	PSD with Duty Factor (dBm/500 kHz)	Limit (dBm/500 kHz)	Pass / Fail
155	5775	-10.33	0.74	-9.59	30	Pass

Note: Refer to section 3.3 for duty cycle spectrum plot.

2Tx

Tx Chain	Channel	Frequency (MHz)	PSD (dBm/500 kHz)	10 log (N=2) dB	Duty Factor (dB)	Total PSD with Duty Factor (dBm/500 kHz)	Limit (dBm/500 kHz)	Pass / Fail
0	155	5775	-12.88	3.01	0.79	-9.08	27.98	Pass
1	155	5775	-12.26	3.01	0.79	-8.46	27.98	Pass

Note:

- Method 1 of power density measurement of KDB 662911 is using for calculating total power density. Total power density is summing entire spectra across corresponding frequency bins on the various outputs by computer.
- Directional gain = $5.01\text{dBi} + 10\log(2) = 8.02\text{dBi} > 6\text{dBi}$, so the power density limit shall be reduced to $30 - (8.02 - 6) = 27.98\text{dBm}$.
- Refer to section 3.3 for duty cycle spectrum plot.

3Tx

Tx Chain	Channel	Frequency (MHz)	PSD (dBm/500 kHz)	10 log (N=3) dB	Duty Factor (dB)	Total PSD with Duty Factor (dBm/500 kHz)	Limit (dBm/500 kHz)	Pass / Fail
0	155	5775	-13.95	4.77	0.73	-8.45	26.22	Pass
1	155	5775	-13.57	4.77	0.73	-8.07	26.22	Pass
2	155	5775	-14.31	4.77	0.73	-8.81	26.22	Pass

Note:

- Method 1 of power density measurement of KDB 662911 is using for calculating total power density. Total power density is summing entire spectra across corresponding frequency bins on the various outputs by computer.
- Directional gain = $5.01\text{dBi} + 10\log(3) = 9.78\text{dBi} > 6\text{dBi}$, so the power density limit shall be reduced to $30 - (9.78 - 6) = 26.22\text{dBm}$.
- Refer to section 3.3 for duty cycle spectrum plot.

Spectrum Plot of Worst Value

802.11a

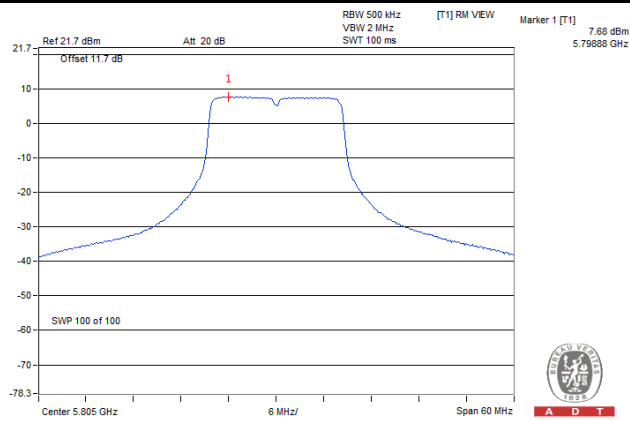

802.11n (HT20)

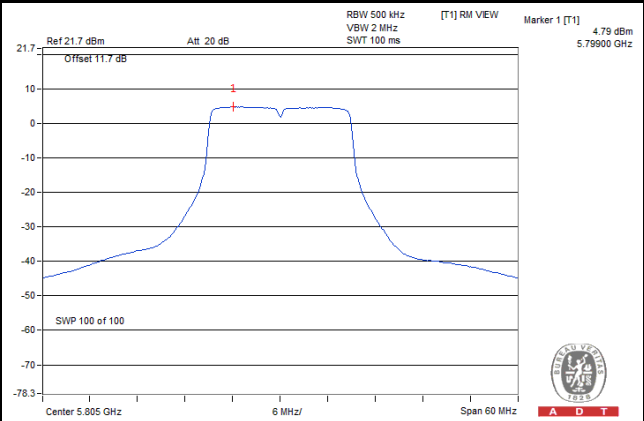

802.11n (HT40)

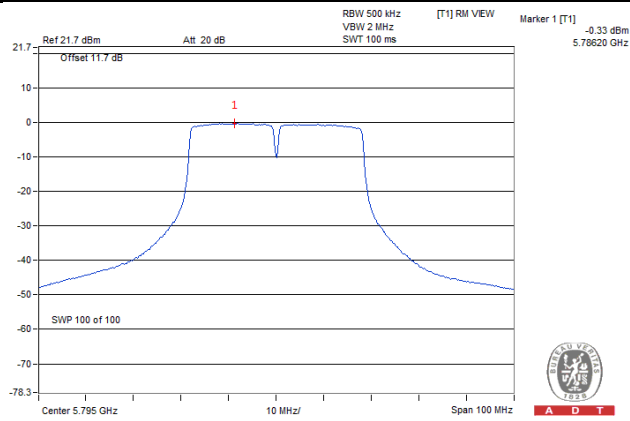

802.11ac (VHT80)

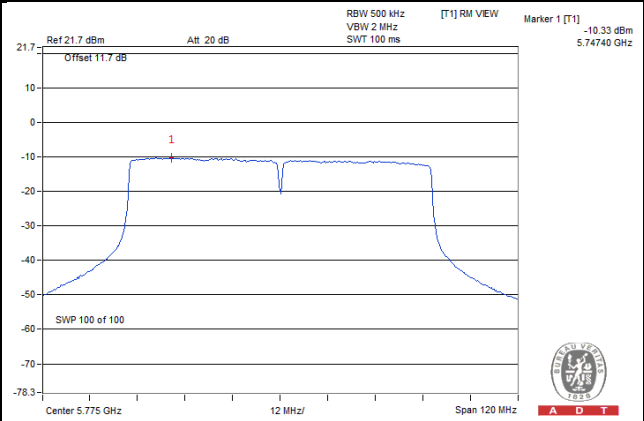

4.6 Frequency Stability

4.6.1 Limit of Frequency Stability Measurement

The frequency of the carrier signal shall be maintained within band of operation.

4.6.2 Test Setup

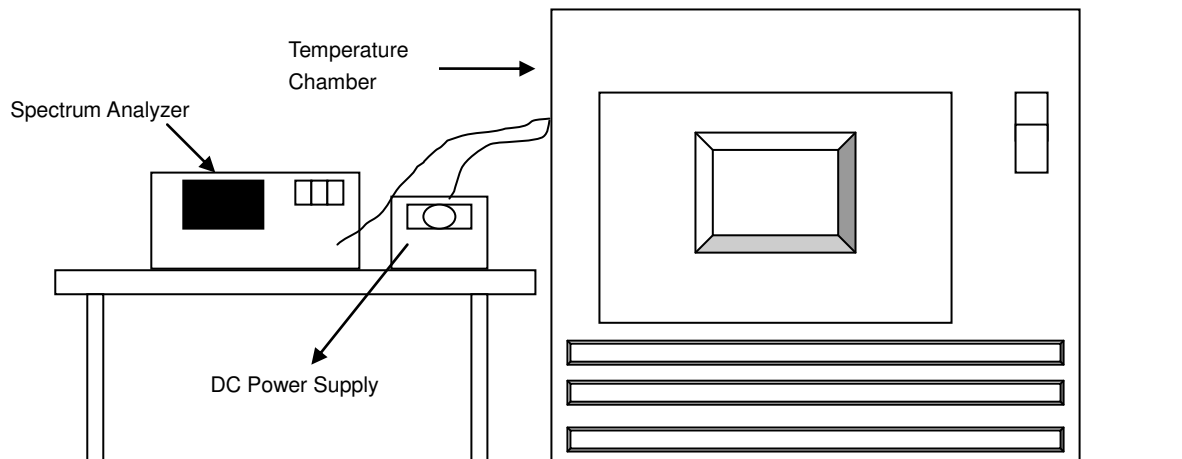

4.6.3 Test Instruments

Refer to section 4.1.3 to get information of above instrument.

4.6.4 Test Procedure

- To ensure emission at the band edge is maintained within the authorized band, those values shall be measured by radiation emissions at upper and lower frequency points, and finally compensated by frequency deviation as procedures below.
- The EUT was operated at the maximum output power, and connected to the spectrum analyzer, which is set to maximum hold function and peak detector. The peak value of the power envelope was measured and noted. The upper and lower frequency points were respectively measured relatively 10 dB lower than the measured peak value.
- The frequency deviation was calculated by adding the upper frequency point and the lower frequency point divided by two. Those detailed values of frequency deviation are provided in table below.

4.6.5 Deviation from Test Standard

No deviation.

4.6.6 EUT Operating Condition

Set the EUT transmit at un-modulation mode to test frequency stability.

4.6.7 Test Results

Frequency Stability Versus Temp.									
Operating Frequency: 5180 MHz									
Temp. (°C)	Power Supply (Vdc)	0 Minute		2 Minute		5 Minute		10 Minute	
		Measured Frequency (MHz)	Frequency Drift (ppm)	Measured Frequency (MHz)	Frequency Drift (ppm)	Measured Frequency (MHz)	Frequency Drift (ppm)	Measured Frequency (MHz)	Frequency Drift (ppm)
50	12.0	5180.029476	5.690	5180.030019	5.795	5180.029603	5.715	5180.029823	5.757
40	12.0	5180.029962	5.784	5180.029576	5.710	5180.029805	5.754	5180.029944	5.781
30	12.0	5180.031252	6.033	5180.031032	5.991	5180.031191	6.021	5180.030951	5.975
20	12.0	5180.034239	6.610	5180.033928	6.550	5180.033935	6.551	5180.033890	6.542
10	12.0	5180.033685	6.503	5180.033889	6.542	5180.033361	6.440	5180.033382	6.444
0	12.0	5180.032349	6.245	5180.032201	6.216	5180.031990	6.176	5180.032067	6.191
-10	12.0	5180.030700	5.927	5180.030828	5.951	5180.030664	5.920	5180.030394	5.868
-20	12.0	5180.030476	5.883	5180.030280	5.846	5180.029902	5.773	5180.029969	5.786
-30	12.0	5180.029146	5.627	5180.028812	5.562	5180.029164	5.630	5180.028769	5.554

Frequency Stability Versus Temp.									
Operating Frequency: 5180 MHz									
Temp. (°C)	Power Supply (Vdc)	0 Minute		2 Minute		5 Minute		10 Minute	
		Measured Frequency (MHz)	Frequency Drift (ppm)	Measured Frequency (MHz)	Frequency Drift (ppm)	Measured Frequency (MHz)	Frequency Drift (ppm)	Measured Frequency (MHz)	Frequency Drift (ppm)
20	11.4	5180.033505	6.468	5180.033658	6.498	5180.033879	6.540	5180.033986	6.561
	12.0	5180.034239	6.610	5180.033928	6.550	5180.033935	6.551	5180.033890	6.542
	12.6	5180.035216	6.798	5180.035176	6.791	5180.035219	6.799	5180.035696	6.891

4.7 6 dB Bandwidth Measurement

4.7.1 Limits of 6 dB Bandwidth Measurement

The minimum of 6 dB Bandwidth Measurement is 0.5 MHz.

4.7.2 Test Setup

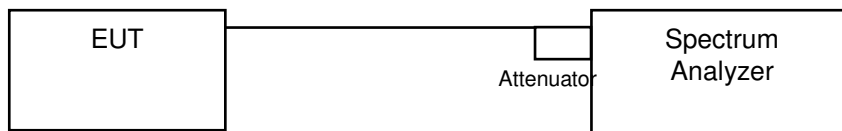

4.7.3 Test Instruments

Refer to section 4.1.3 to get information of above instrument.

4.7.4 Test Procedure

MEASUREMENT PROCEDURE REF

- Set resolution bandwidth (RBW) = 100 kHz
- Set the video bandwidth (VBW) $\geq 3 \times$ RBW, Detector = Peak.
- Trace mode = max hold.
- Sweep = auto couple.
- Measure the maximum width of the emission that is constrained by the frequencies associated with the two amplitude points (upper and lower) that are attenuated by 6 dB relative to the maximum level measured in the fundamental emission

4.7.5 Deviation from Test Standard

No deviation.

4.7.6 EUT Operating Condition

The software provided by client to enable the EUT under transmission condition continuously at lowest, middle and highest channel frequencies individually.

4.7.7 Test Results

802.11a

Channel	Frequency (MHz)	6 dB Bandwidth (MHz)	Minimum Limit (MHz)	Pass / Fail
149	5745	16.40	0.5	Pass
157	5785	16.40	0.5	Pass
161	5805	16.37	0.5	Pass

802.11n (HT20)

1Tx

Channel	Frequency (MHz)	6 dB Bandwidth (MHz)	Minimum Limit (MHz)	Pass / Fail
149	5745	17.62	0.5	Pass
157	5785	17.61	0.5	Pass
161	5805	17.61	0.5	Pass

2Tx

Channel	Frequency (MHz)	6 dB Bandwidth (MHz)		Minimum Limit (MHz)	Pass / Fail
		Chain 0	Chain 1		
149	5745	17.62	17.59	0.5	Pass
157	5785	17.62	17.62	0.5	Pass
161	5805	17.60	17.61	0.5	Pass

3Tx

Channel	Frequency (MHz)	6 dB Bandwidth (MHz)			Minimum Limit (MHz)	Pass / Fail
		Chain 0	Chain 1	Chain 2		
149	5745	17.61	17.62	17.61	0.5	Pass
157	5785	17.62	17.62	17.63	0.5	Pass
161	5805	17.62	17.63	17.61	0.5	Pass

802.11n (HT40)

1Tx

Channel	Frequency (MHz)	6 dB Bandwidth (MHz)	Minimum Limit (MHz)	Pass / Fail
151	5755	36.36	0.5	Pass
159	5795	36.23	0.5	Pass

2Tx

Channel	Frequency (MHz)	6 dB Bandwidth (MHz)		Minimum Limit (MHz)	Pass / Fail
		Chain 0	Chain 1		
151	5755	36.37	36.36	0.5	Pass
159	5795	36.45	36.40	0.5	Pass

3Tx

Channel	Frequency (MHz)	6 dB Bandwidth (MHz)			Minimum Limit (MHz)	Pass / Fail
		Chain 0	Chain 1	Chain 2		
151	5755	36.42	36.45	36.44	0.5	Pass
159	5795	36.42	36.43	36.44	0.5	Pass

802.11ac (VHT80)

1Tx

Channel	Frequency (MHz)	6 dB Bandwidth (MHz)	Minimum Limit (MHz)	Pass / Fail
155	5775	76.38	0.5	Pass

2Tx

Channel	Frequency (MHz)	6 dB Bandwidth (MHz)		Minimum Limit (MHz)	Pass / Fail
		Chain 0	Chain 1		
155	5775	75.89	76.48	0.5	Pass

3Tx

Channel	Frequency (MHz)	6 dB Bandwidth (MHz)			Minimum Limit (MHz)	Pass / Fail
		Chain 0	Chain 1	Chain 2		
155	5775	75.88	76.46	76.51	0.5	Pass

Spectrum Plot of Worst Value

802.11a

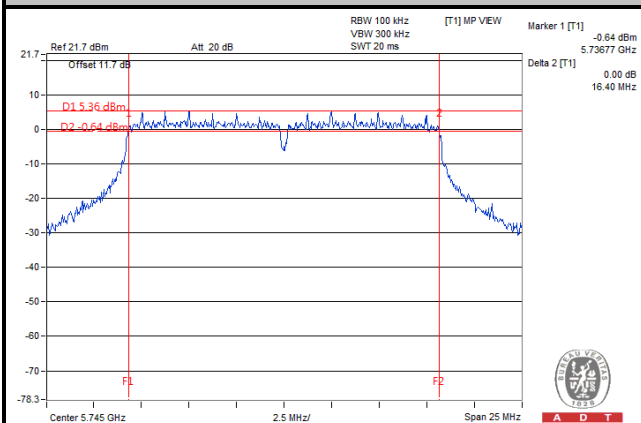

802.11n (HT20)

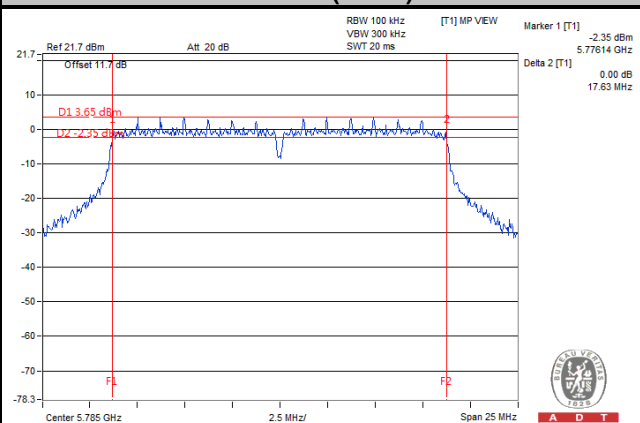

802.11n (HT40)

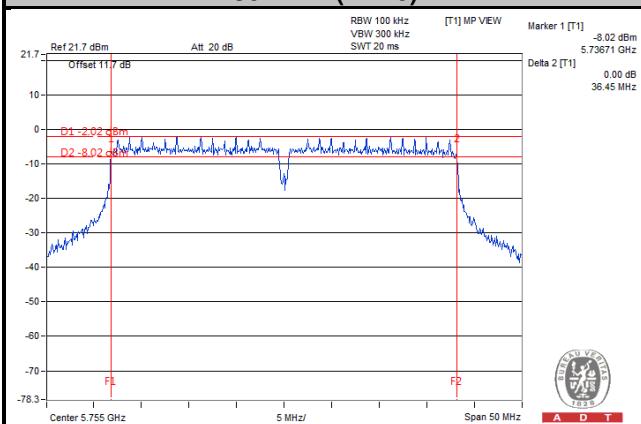

802.11ac (VHT80)

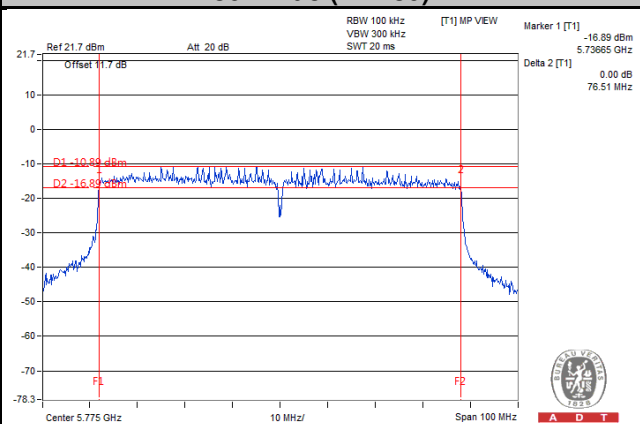

5 Pictures of Test Arrangements

Please refer to the attached file (Test Setup Photo).

Annex A- Radiated Out of Band Emisison (OOBE) Measurement (For U-NII-3 band)

802.11a

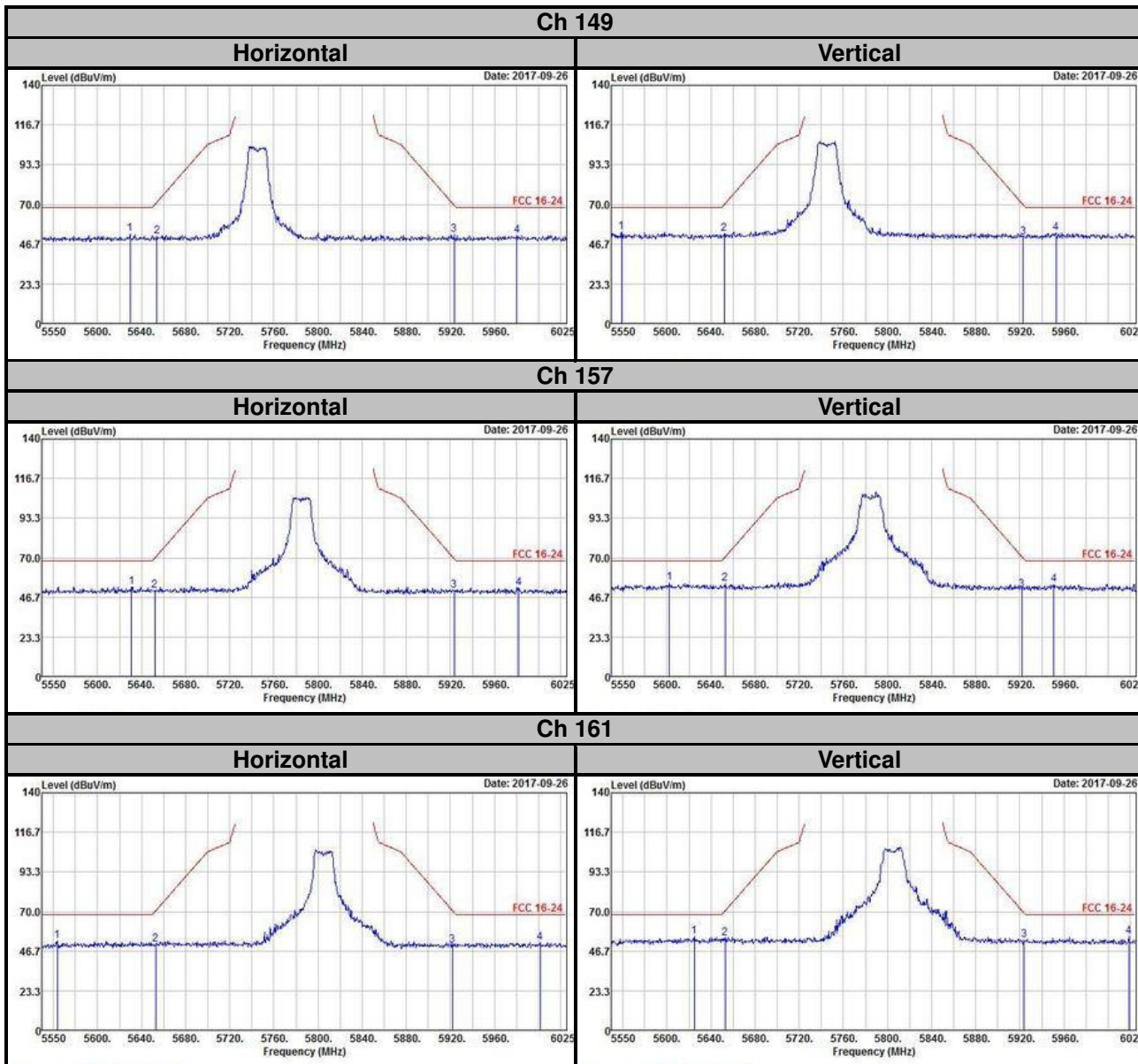

802.11n (HT20)

Ch 149

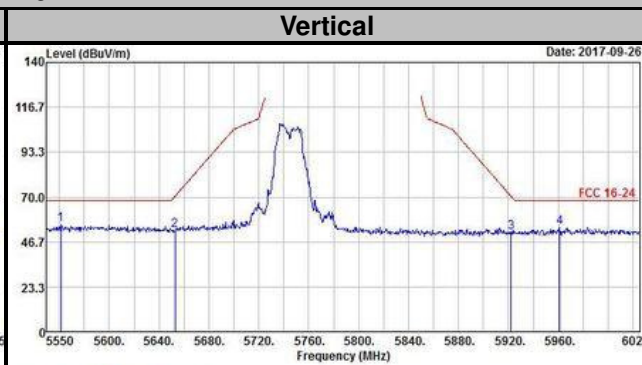
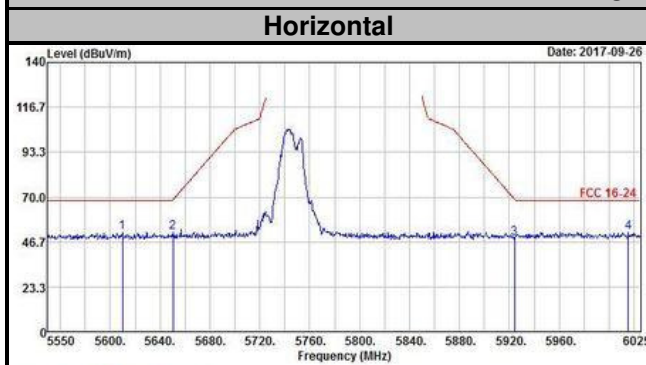

Ch 157

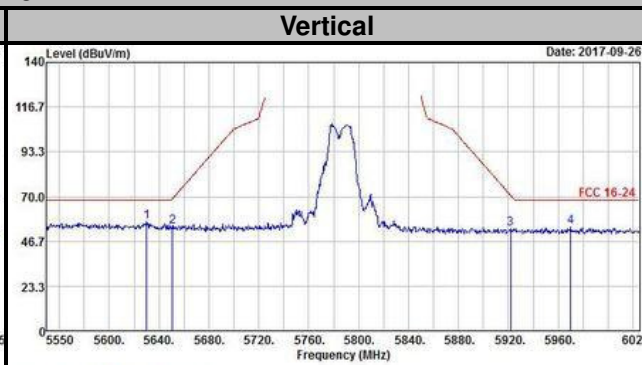
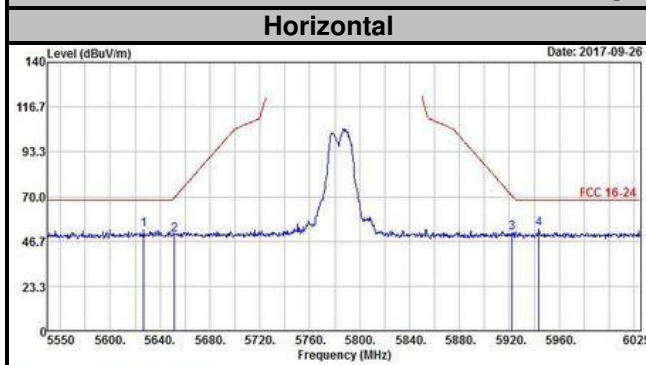

Ch 161

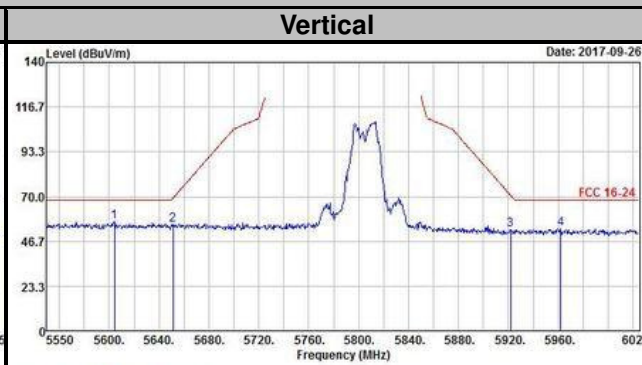
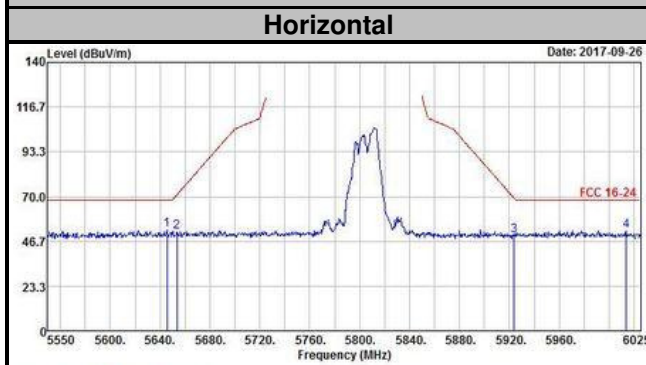

802.11n (HT40)

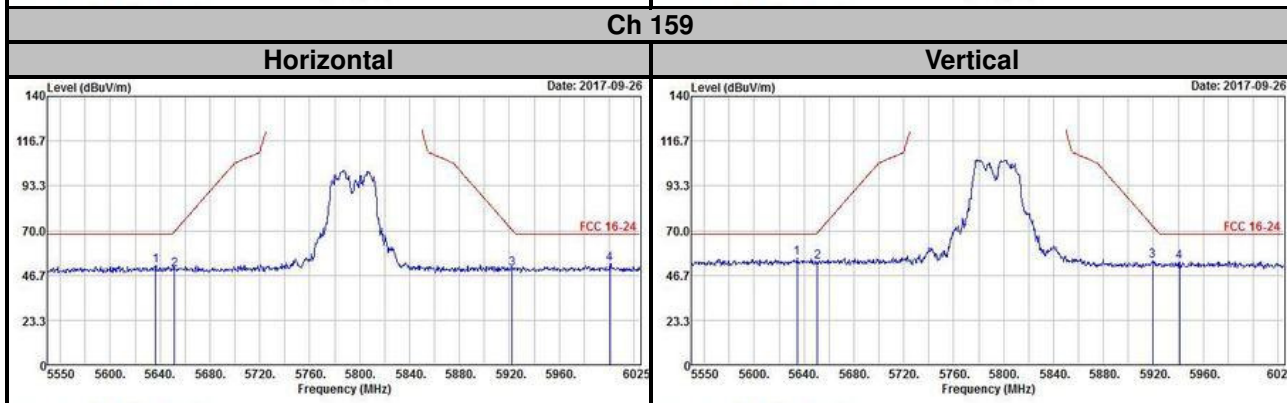
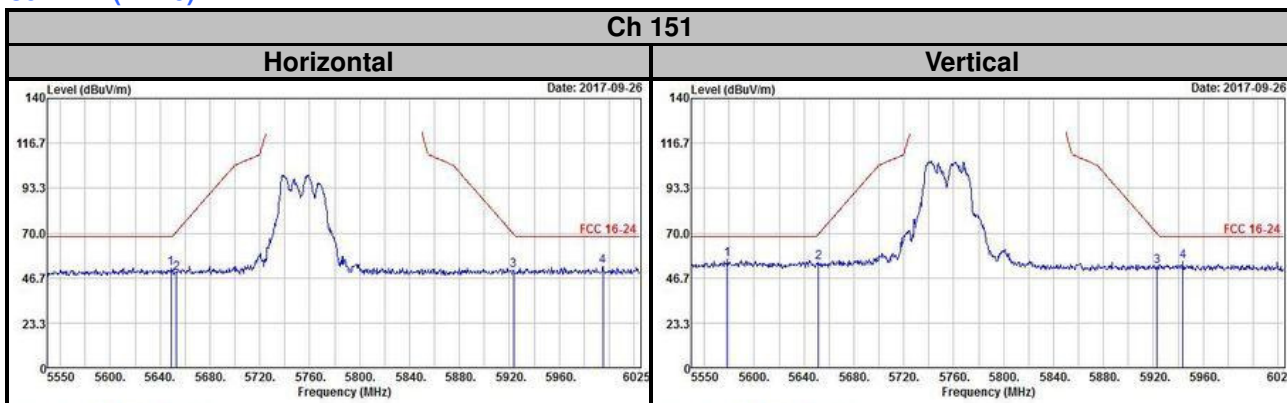

802.11ac (VHT80)

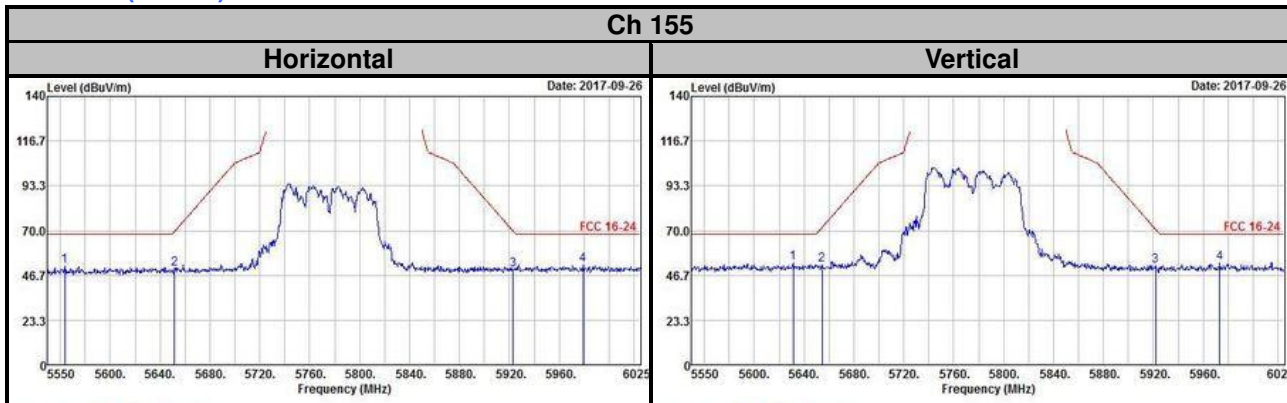

Appendix – Information on the Testing Laboratories

We, Bureau Veritas Consumer Products Services (H.K.) Ltd., Taoyuan Branch, were founded in 1988 to provide our best service in EMC, Radio, Telecom and Safety consultation. Our laboratories are FCC recognized accredited test firms and accredited according to ISO/IEC 17025.

If you have any comments, please feel free to contact us at the following:

Linko EMC/RF Lab

Tel: 886-2-26052180

Fax: 886-2-26051924

Hsin Chu EMC/RF/Telecom Lab

Tel: 886-3-6668565

Fax: 886-3-6668323

Hwa Ya EMC/RF/Safety

Tel: 886-3-3183232

Fax: 886-3-3270892

Email: service.adt@tw.bureauveritas.com

Web Site: www.bureauveritas-adt.com

The address and road map of all our labs can be found in our web site also.

--- END ---