

FCC Test Report

Report No.: RF160315E13-1

FCC ID: YZKECW5212

Test Model: ECW5212

Received Date: Mar. 15, 2016

Test Date: Mar. 21 to 31, 2016

Issued Date: Apr. 12, 2016

Applicant: Edgecore Networks Corporation

Address: No.1 Creation Rd.3, Hsinchu Science Park, Hsinchu, 30077, Taiwan, R.O.C.

Issued By: Bureau Veritas Consumer Products Services (H.K.) Ltd., Taoyuan Branch
Hsin Chu Laboratory

Lab Address: E-2, No.1, Li Hsin 1st Road, Hsinchu Science Park, Hsinchu City 300,
Taiwan R.O.C.

Test Location (1): E-2, No.1, Li Hsin 1st Road, Hsinchu Science Park, Hsinchu City 300,
Taiwan R.O.C.

Test Location (2): No. 49, Ln. 206, Wende Rd., Shangshan Tsuen, Chiung Lin Hsiang, Hsin
Chu Hsien 307, Taiwan R.O.C.



This report is for your exclusive use. Any copying or replication of this report to or for any other person or entity, or use of our name or trademark, is permitted only with our prior written permission. This report sets forth our findings solely with respect to the test samples identified herein. The results set forth in this report are not indicative or representative of the quality or characteristics of the lot from which a test sample was taken or any similar or identical product unless specifically and expressly noted. Our report includes all of the tests requested by you and the results thereof based upon the information that you provided to us. You have 60 days from date of issuance of this report to notify us of any material error or omission caused by our negligence, provided, however, that such notice shall be in writing and shall specifically address the issue you wish to raise. A failure to raise such issue within the prescribed time shall constitute your unqualified acceptance of the completeness of this report, the tests conducted and the correctness of the report contents. Unless specific mention, the uncertainty of measurement has been explicitly taken into account to declare the compliance or non-compliance to the specification. The report must not be used by the client to claim product certification, approval, or endorsement by TAF or any government agencies.

Table of Contents

Release Control Record	4
1 Certificate of Conformity	5
2 Summary of Test Results	6
2.1 Measurement Uncertainty.....	6
2.2 Modification Record.....	6
3 General Information	7
3.1 General Description of EUT.....	7
3.2 Description of Test Modes.....	10
3.2.1 Test Mode Applicability and Tested Channel Detail.....	11
3.3 Duty Cycle of Test Signal.....	13
3.4 Description of Support Units.....	14
3.4.1 Configuration of System under Test.....	15
3.5 General Description of Applied Standard.....	16
4 Test Types and Results	17
4.1 Radiated Emission and Bandedge Measurement.....	17
4.1.1 Limits of Radiated Emission and Bandedge Measurement.....	17
4.1.2 Test Instruments.....	18
4.1.3 Test Procedure.....	20
4.1.4 Deviation from Test Standard.....	20
4.1.5 Test Setup.....	21
4.1.6 EUT Operating Condition.....	21
4.1.7 Test Results.....	22
4.2 Conducted Emission Measurement.....	41
4.2.1 Limits of Conducted Emission Measurement.....	41
4.2.2 Test Instruments.....	41
4.2.3 Test Procedure.....	42
4.2.4 Deviation from Test Standard.....	42
4.2.5 Test Setup.....	42
4.2.6 EUT Operating Condition.....	42
4.2.7 Test Results (Mode 1).....	43
4.2.8 Test Results (Mode 2).....	45
4.2.9 Test Results (Mode 3).....	47
4.3 Transmit Power Measurement.....	49
4.3.1 Limits of Transmit Power Measurement.....	49
4.3.2 Test Setup.....	49
4.3.3 Test Instruments.....	49
4.3.4 Test Procedure.....	50
4.3.5 Deviation from Test Standard.....	50
4.3.6 EUT Operating Condition.....	50
4.3.7 Test Result.....	51
4.4 Peak Power Spectral Density Measurement.....	53
4.4.1 Limits of Peak Power Spectral Density Measurement.....	53
4.4.2 Test Setup.....	53
4.4.3 Test Instruments.....	53
4.4.4 Test Procedure.....	54
4.4.5 Deviation from Test Standard.....	55
4.4.6 EUT Operating Condition.....	55
4.4.7 Test Results.....	56
4.5 Frequency Stability Measurement.....	62
4.5.1 Limits of Frequency Stability Measurement.....	62
4.5.2 Test Setup.....	62
4.5.3 Test Instruments.....	62
4.5.4 Test Procedure.....	62

4.5.5	Deviation from Test Standard	62
4.5.6	EUT Operating Condition	62
4.5.7	Test Results	63
4.6	6dB Bandwidth Measurement	64
4.6.1	Limits of 6dB Bandwidth Measurement	64
4.6.2	Test Setup	64
4.6.3	Test Instruments	64
4.6.4	Test Procedure	64
4.6.5	Deviation from Test Standard	64
4.6.6	EUT Operating Condition	64
4.6.7	Test Results	65
5	Pictures of Test Arrangements	67
	Appendix – Information on the Testing Laboratories	68



A D T

Release Control Record

Issue No.	Description	Date Issued
RF160315E13-1	Original release.	Apr. 12, 2016

2 Summary of Test Results

47 CFR FCC Part 15, Subpart E (SECTION 15.407)			
FCC Clause	Test Item	Result	Remarks
15.407(b)(6)	AC Power Conducted Emissions	PASS	Meet the requirement of limit. Minimum passing margin is -8.09dB at 13.33794MHz.
15.407(b) (1/2/3/4/6)	Radiated Emissions & Band Edge Measurement	PASS	Meet the requirement of limit. Minimum passing margin is -0.1dB at 11650.00MHz & 11570.00MHz
15.407(a)(1/2 /3)	Max Average Transmit Power	PASS	Meet the requirement of limit.
15.407(a)(1/2 /3)	Peak Power Spectral Density	PASS	Meet the requirement of limit.
15.407(e)	6dB bandwidth	PASS	Meet the requirement of limit. (U-NII-3 Band only)
15.407(g)	Frequency Stability	PASS	Meet the requirement of limit.
15.203	Antenna Requirement	PASS	Antenna connector is i-PEX not a standard connector.

Note: The EUT was operating in 2.4~2.4835GHz, 5.15~5.25GHz and 5.725~5.85GHz frequencies band. This report was recorded the 5.15~5.25GHz and 5.725~5.850GHz RF parameters including. For the 2.4 ~ 2.4835GHz RF parameters was recorded in another test report.

2.1 Measurement Uncertainty

Where relevant, the following measurement uncertainty levels have been estimated for tests performed on the EUT as specified in CISPR 16-4-2:

Measurement	Frequency	Expanded Uncertainty (k=2) (±)
Conducted Emissions at mains ports	150kHz ~ 30MHz	2.86 dB
Radiated Emissions up to 1 GHz	30MHz ~ 1GHz	5.19 dB
Radiated Emissions above 1 GHz	1GHz ~ 6GHz	3.40 dB
	6GHz ~ 18GHz	3.73 dB
	18GHz ~ 40GHz	4.11 dB

2.2 Modification Record

There were no modifications required for compliance.

3 General Information

3.1 General Description of EUT

Product	802.11a/ac/b/g/n Wireless Access Point
Brand	Edge-corE
Test Model	ECW5212
Status of EUT	ENGINEERING SAMPLE
Power Supply rating	DC 12V from adapter or DC 44~57V from POE
Modulation Type	CCK, DQPSK, DBPSK for DSSS 64QAM, 16QAM, QPSK, BPSK for OFDM 256QAM for OFDM in 11ac mode only
Modulation Technology	DSSS, OFDM
Transfer Rate	802.11b: up to 11Mbps 802.11a/g: up to 54Mbps 802.11n : up to 300Mbps 802.11ac: up to 866.7Mbps
Operating Frequency	2.4GHz: 2.412GHz ~ 2.462GHz 5GHz: 5.18GHz ~ 5.24GHz, 5.745GHz ~ 5.825GHz
Number of Channel	2.4GHz: 11 for 802.11b, 802.11g, 802.11n (HT20) 7 for 802.11n (HT40) 5GHz: 9 for 802.11a, 802.11n (HT20), 802.11ac (VHT20) 4 for 802.11n (HT40), 802.11ac (VHT40) 2 for 802.11ac (VHT80)
Output Power	2.4GHz: 985.291mW 5GHz: 5.18 ~ 5.24GHz: 239.918mW 5.745 ~ 5.825GHz: 137.893mW
Antenna Type	Refer to Note
Antenna Connector	Refer to Note
Accessory Device	Adapter x 1
Data Cable Supplied	NA

Note:

- 2.4GHz and 5GHz technology can transmit at same time.
- The EUT power needs to be supplied from adapters or POE, the information is as below table:

Adapter			
No	Brand	Model No.	Spec.
1	LEI	MU12AR120100-A1	Input: 100-240V, 0.3A, 50/60Hz Output: 12V, 1.0A DC output cable (1.5m, unshielded)
2	APD	WA-12M12FU	Input: 100-240V, 0.5A, 50/60Hz Output: 12V, 1.0A DC output cable (1.5m, unshielded)

POE (Only for test not for sale)

No	Brand	Model No.	Spec.
1	MOTOROLA	PD-7001G	Input: 100-240V, 0.8A, 50-60Hz Output: 55V, 570mA

- The antennas provided to the EUT, please refer to the following table:

For 2.4GHz									
Antenna No	PCB Chain No.	Brand	Model	Antenna Type	Antenna Connector	Gain (dBi) <excluding cable loss>	Cable Loss(dB)	Cable Length (mm)	Frequency (GHz to GHz)
1	Chain 0 (2.4GHz)	NA	120G00000112A	Monopole	i-PEX	5.87	0.34 (black)	70	2.4~2.4835
2	Chain 1 (2.4GHz)	NA	120G00000112A	Monopole	i-PEX	5.87	0.43 (white)	110	2.4~2.4835
For 5GHz									
Antenna No	PCB Chain No.	Brand	Model	Antenna Type	Antenna Connector	Gain (dBi) <excluding cable loss>	Cable Loss(dB)	Cable Length (mm)	Frequency (GHz to GHz)
3	Chain 0 (5GHz)	NA	120G00000120A	Monopole	i-PEX	8	0.65 (red)	120	5.15~5.85
4	Chain 1 (5GHz)	NA	120G00000120A	Monopole	i-PEX	8	0.7 (blue)	115	5.15~5.85

4. The EUT incorporates a MIMO function.

2.4GHz Band			
MODULATION MODE	DATA RATE (MCS)	TX & RX CONFIGURATION	
802.11b	1 ~ 11Mbps	2TX	2RX
802.11g	6 ~ 54Mbps	2TX	2RX
802.11n (HT20)	MCS 0~7	2TX	2RX
	MCS 8~15	2TX	2RX
802.11n (HT40)	MCS 0~7	2TX	2RX
	MCS 8~15	2TX	2RX
5GHz Band			
MODULATION MODE	DATA RATE (MCS)	TX & RX CONFIGURATION	
802.11a	6 ~ 54Mbps	2TX	2RX
802.11n (HT20)	MCS 0~7	2TX	2RX
	MCS 8~15	2TX	2RX
802.11n (HT40)	MCS 0~7	2TX	2RX
	MCS 8~15	2TX	2RX
802.11ac (VHT20)	MCS 0~8, NSS=1	2TX	2RX
	MCS 0~8, NSS=2	2TX	2RX
802.11ac (VHT40)	MCS 0~9, NSS=1	2TX	2RX
	MCS 0~9, NSS=2	2TX	2RX
802.11ac (VHT80)	MCS 0~9, NSS=1	2TX	2RX
	MCS 0~9, NSS=2	2TX	2RX

5. For radiated, the EUT was pre-tested under the following modes:

Test Mode	Description
Mode A	With adapter 1
Mode B	With adapter 2
Mode C	With POE

From the above modes, the worst cases were found in Mode A. Therefore only the test data of the modes were recorded in this report.

6. Spurious emission of the simultaneous operation (2.4GHz and 5GHz) has been evaluated and no non-compliance was found.
7. The above EUT information is declared by manufacturer and for more detailed features description, please refer to the manufacturer's specifications or user's manual.

3.2 Description of Test Modes

For 5180 ~ 5240MHz

4 channels are provided for 802.11a, 802.11n (HT20), 802.11ac (VHT20):

Channel	Frequency	Channel	Frequency
36	5180 MHz	44	5220 MHz
40	5200 MHz	48	5240 MHz

2 channels are provided for 802.11n (HT40), 802.11ac (VHT40):

Channel	Frequency	Channel	Frequency
38	5190 MHz	46	5230 MHz

1 channel is provided for 802.11ac (VHT80):

Channel	Frequency
42	5210MHz

For 5745 ~ 5825MHz:

5 channels are provided for 802.11a, 802.11n (HT20), 802.11ac (VHT20):

Channel	Frequency	Channel	Frequency
149	5745MHz	161	5805MHz
153	5765MHz	165	5825MHz
157	5785MHz		

2 channels are provided for 802.11n (HT40), 802.11ac (VHT40):

Channel	Frequency	Channel	Frequency
151	5755MHz	159	5795MHz

1 channel is provided for 802.11ac (VHT80):

Channel	Frequency
155	5775MHz

3.2.1 Test Mode Applicability and Tested Channel Detail

EUT CONFIGURE MODE	APPLICABLE TO				DESCRIPTION
	RE \geq 1G	RE $<$ 1G	PLC	APCM	
1	√	√	√	-	With adapter 1
2	-	-	√	√	With adapter 2
3	-	-	√	-	With POE

Where RE \geq 1G: Radiated Emission above 1GHz & Bandedge Measurement
 RE $<$ 1G: Radiated Emission below 1GHz
 PLC: Power Line Conducted Emission
 APCM: Antenna Port Conducted Measurement

NOTE: The EUT had been pre-tested on the positioned of each 2 axis. The worst case was found when positioned on **X-plane**.(below 1GHz) and **Y-plane**.(above 1GHz)

Radiated Emission Test (Above 1GHz):

- Pre-Scan has been conducted to determine the worst-case mode from all possible combinations between available modulations, data rates and antenna ports (if EUT with antenna diversity architecture).
- Following channel(s) was (were) selected for the final test as listed below.

MODE	FREQ. BAND (MHz)	AVAILABLE CHANNEL	TESTED CHANNEL	MODULATION TECHNOLOGY	MODULATION TYPE	DATA RATE (Mbps)
802.11a	5180-5240	36 to 48	36, 40, 48	OFDM	BPSK	6
802.11ac (VHT20)		36 to 48	36, 40, 48	OFDM	BPSK	6.5
802.11ac (VHT40)		38 to 46	38, 46	OFDM	BPSK	13.5
802.11ac (VHT80)		42	42	OFDM	BPSK	29.3
802.11a	5745-5825	149 to 165	149, 157, 165	OFDM	BPSK	6
802.11ac (VHT20)		149 to 165	149, 157, 165	OFDM	BPSK	6.5
802.11ac (VHT40)		151 to 159	151, 159	OFDM	BPSK	13.5
802.11ac (VHT80)		155	155	OFDM	BPSK	29.3

Radiated Emission Test (Below 1GHz):

- Pre-Scan has been conducted to determine the worst-case mode from all possible combinations between available modulations, data rates and antenna ports (if EUT with antenna diversity architecture).
- Following channel(s) was (were) selected for the final test as listed below.

MODE	FREQ. BAND (MHz)	AVAILABLE CHANNEL	TESTED CHANNEL	MODULATION TECHNOLOGY	MODULATION TYPE	DATA RATE (Mbps)
802.11a	5180-5240	36 to 48	48	OFDM	BPSK	6
	5745-5825	149 to 165				

Power Line Conducted Emission Test:

- Pre-Scan has been conducted to determine the worst-case mode from all possible combinations between available modulations, data rates and antenna ports (if EUT with antenna diversity architecture).
- Following channel(s) was (were) selected for the final test as listed below.

MODE	FREQ. BAND (MHz)	AVAILABLE CHANNEL	TESTED CHANNEL	MODULATION TECHNOLOGY	MODULATION TYPE	DATA RATE (Mbps)
802.11a	5180-5240	36 to 48	48	OFDM	BPSK	6
	5745-5825	149 to 165				

Antenna Port Conducted Measurement:

- This item includes all test value of each mode, but only includes spectrum plot of worst value of each mode.
- Pre-Scan has been conducted to determine the worst-case mode from all possible combinations between available modulations, data rates and antenna ports (if EUT with antenna diversity architecture).
- Following channel(s) was (were) selected for the final test as listed below.

MODE	FREQ. BAND (MHz)	AVAILABLE CHANNEL	TESTED CHANNEL	MODULATION TECHNOLOGY	MODULATION TYPE	DATA RATE (Mbps)
802.11a	5180-5240	36 to 48	36, 40, 48	OFDM	BPSK	6
802.11ac (VHT20)		36 to 48	36, 40, 48	OFDM	BPSK	6.5
802.11ac (VHT40)		38 to 46	38, 46	OFDM	BPSK	13.5
802.11ac (VHT80)		42	42	OFDM	BPSK	29.3
802.11a	5745-5825	149 to 165	149, 157, 165	OFDM	BPSK	6
802.11ac (VHT20)		149 to 165	149, 157, 165	OFDM	BPSK	6.5
802.11ac (VHT40)		151 to 159	151, 159	OFDM	BPSK	13.5
802.11ac (VHT80)		155	155	OFDM	BPSK	29.3

Test Condition:

APPLICABLE TO	ENVIRONMENTAL CONDITIONS	INPUT POWER	TESTED BY
RE \geq 1G	23deg. C, 67%RH	120Vac, 60Hz	Gary Cheng
RE<1G	21deg. C, 69%RH	120Vac, 60Hz	Gary Cheng
PLC	21deg. C, 57%RH	120Vac, 60Hz	Wythe Lin
APCM	18deg. C, 66%RH	120Vac, 60Hz	Anderson Chen

3.3 Duty Cycle of Test Signal

If duty cycle of test signal is $\geq 98\%$, duty factor is not required.

If duty cycle of test signal is $< 98\%$, duty factor shall be considered.

802.11a: Duty cycle = $5.363 \text{ ms} / 5.463 \text{ ms} = 0.982$

802.11ac (VHT20): Duty cycle = $4.96 \text{ ms} / 5.052 \text{ ms} = 0.982$

802.11ac (VHT40): Duty cycle = $2.403 \text{ ms} / 2.485 \text{ ms} = 0.967$, Duty factor = $10 * \log(1/0.967) = 0.15$

802.11ac (VHT80): Duty cycle = $0.456 \text{ ms} / 0.52 \text{ ms} = 0.877$, Duty factor = $10 * \log(1/0.877) = 0.57$

802.11a

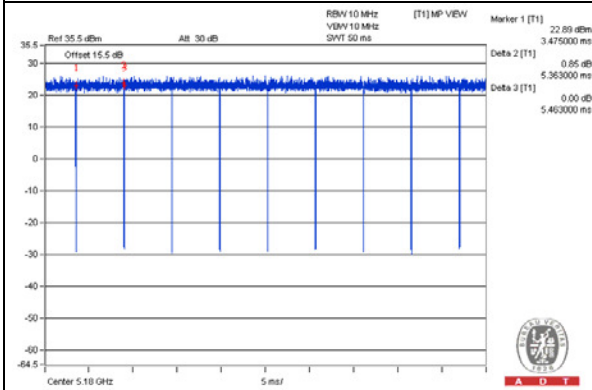

802.11ac (VHT20)

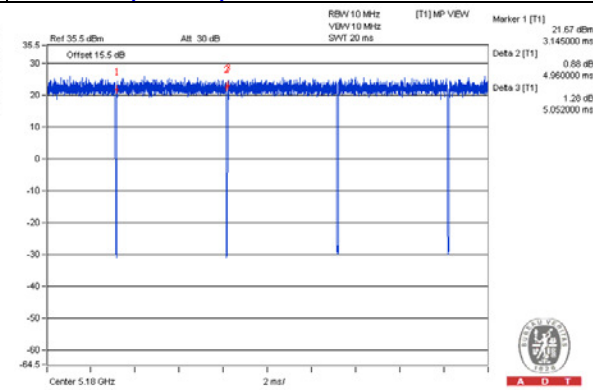

802.11ac (VHT40)

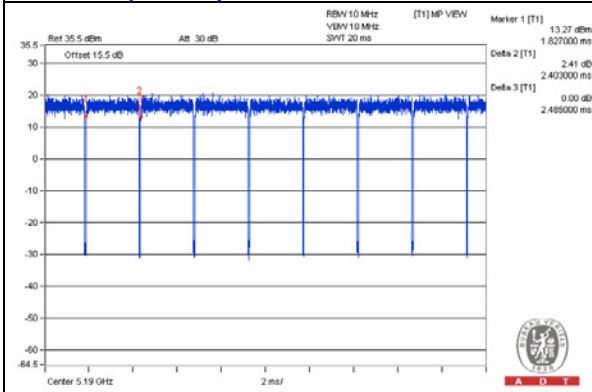

802.11ac (VHT80)

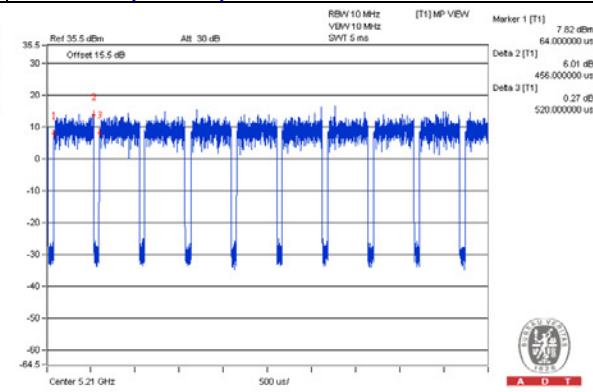

3.4 Description of Support Units

The EUT has been tested as an independent unit together with other necessary accessories or support units. The following support units or accessories were used to form a representative test configuration during the tests.

ID	Product	Brand	Model No.	Serial No.	FCC ID	Remarks
A.	POE	MOTOROLA	PD-7001G	NA	NA	Supplied by client
B.	NOTEBOOK COMPUTER	DELL	E5440	6FC7F12	FCC DoC	Provided by Lab

Note:

1. All power cords of the above support units are non-shielded (1.8m).

ID	Descriptions	Qty.	Length (m)	Shielding (Yes/No)	Cores (Qty.)	Remarks
1.	DC cable	1	1.5	No	0	Supplied by client
2.	RJ45 cable	1	10	No	0	Provided by Lab
3.	RJ45 cable	1	1	No	0	Provided by Lab

3.4.1 Configuration of System under Test

With adapter mode:

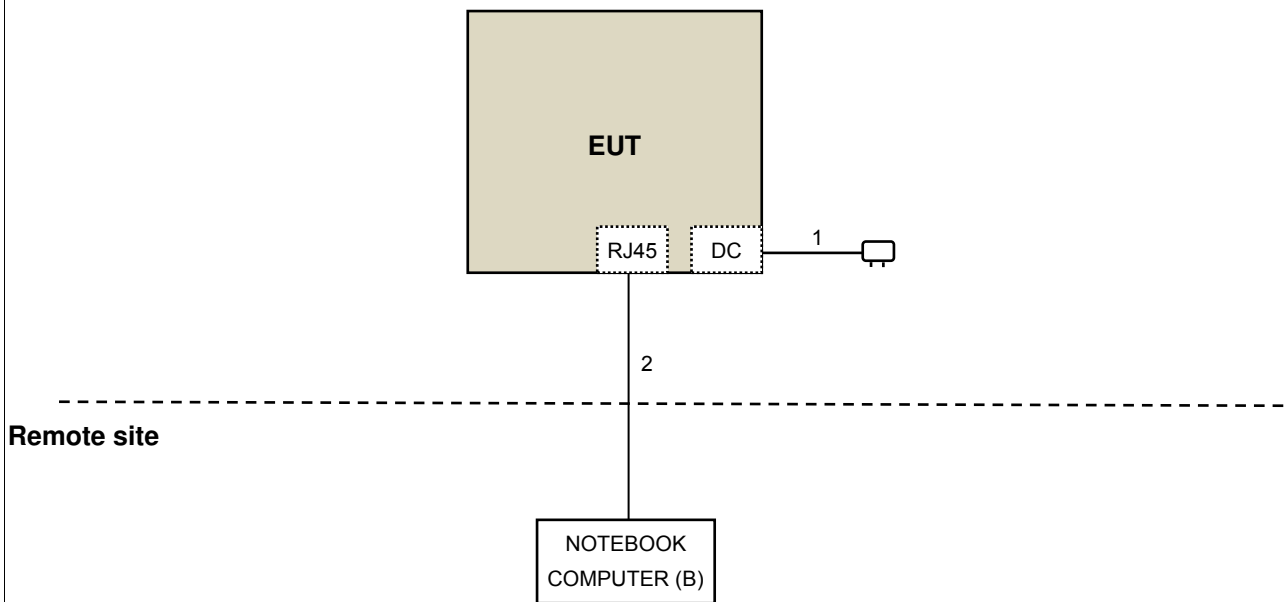

With POE mode:

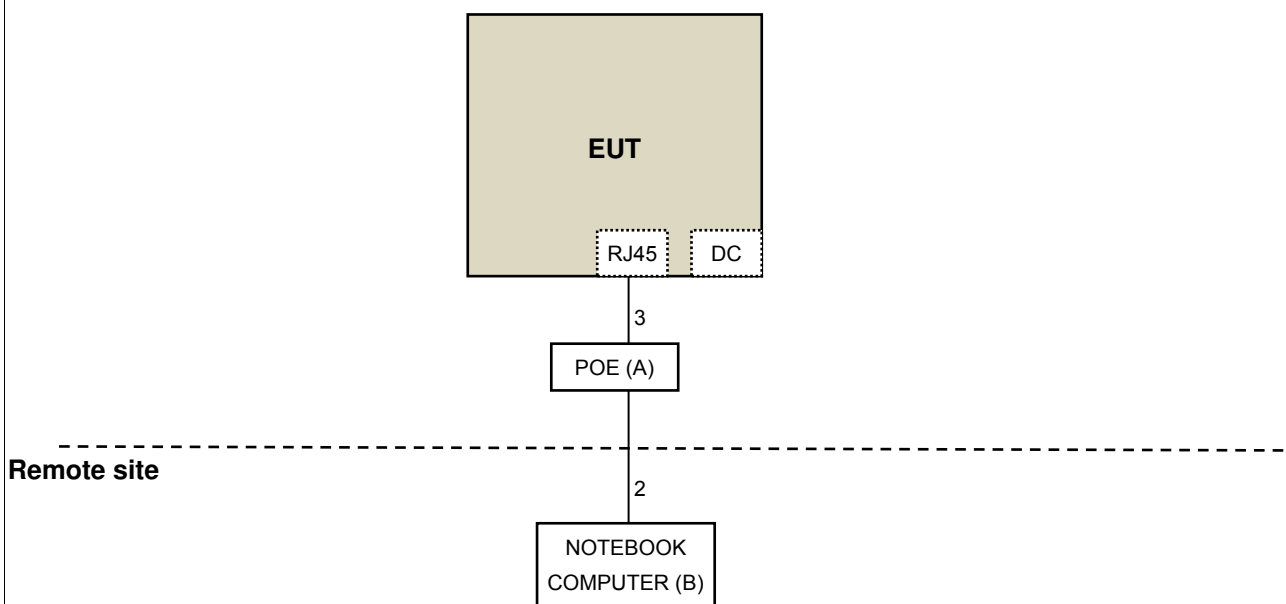

3.5 General Description of Applied Standard

The EUT is a RF Product. According to the specifications of the manufacturer, it must comply with the requirements of the following standards:

FCC Part 15, Subpart E (15.407)

KDB 789033 D02 General UNII Test Procedure New Rules v01r02

KDB 662911 D01 Multiple Transmitter Output v02r01

ANSI C63.10-2013

All test items have been performed and recorded as per the above standards.

NOTE: The EUT has been verified to comply with the requirements of FCC Part 15, Subpart B, Class B (DoC). The test report has been issued separately.

4 Test Types and Results

4.1 Radiated Emission and Bandedge Measurement

4.1.1 Limits of Radiated Emission and Bandedge Measurement

Radiated emissions which fall in the restricted bands must comply with the radiated emission limits specified as below table.

Frequencies (MHz)	Field Strength (microvolts/meter)	Measurement Distance (meters)
0.009 ~ 0.490	2400/F(kHz)	300
0.490 ~ 1.705	24000/F(kHz)	30
1.705 ~ 30.0	30	30
30 ~ 88	100	3
88 ~ 216	150	3
216 ~ 960	200	3
Above 960	500	3

NOTE:

1. The lower limit shall apply at the transition frequencies.
2. Emission level (dBuV/m) = 20 log Emission level (uV/m).
3. For frequencies above 1000MHz, the field strength limits are based on average detector, however, the peak field strength of any emission shall not exceed the maximum permitted average limits, specified above by more than 20dB under any condition of modulation.

LIMITS OF UNWANTED EMISSION OUT OF THE RESTRICTED BANDS

APPLICABLE TO	LIMIT	
KDB 789033 D02 General UNII Test Procedure New Rules v01r02	FIELD STRENGTH AT 3m	
	PK:74 (dBμV/m)	AV:54 (dBμV/m)
APPLICABLE TO	EIRP LIMIT	EQUIVALENT FIELD STRENGTH AT 3m
15.407(b)(1)	PK:-27 (dBm/MHz)	PK:68.2(dBμV/m)
15.407(b)(2)		
15.407(b)(3)		
15.407(b)(4)	PK:-27 (dBm/MHz) ^{*1} PK:-17 (dBm/MHz) ^{*2}	PK: 68.2(dBμV/m) ^{*1} PK:78.2 (dBμV/m) ^{*2}

NOTE: ^{*1} beyond 10MHz of the band edge ^{*2} within 10 MHz of band edge

The following formula is used to convert the equipment isotropic radiated power (eirp) to field strength:

$$E = \frac{1000000\sqrt{30P}}{3} \mu\text{V/m, where P is the eirp (Watts).}$$

4.1.2 Test Instruments

Below 1GHz test:

DESCRIPTION & MANUFACTURER	MODEL NO.	SERIAL NO.	CALIBRATED DATE	CALIBRATED UNTIL
Pre-Amplifier ^(*) EMCI	EMC001340	980142	Jan. 20, 2016	Jan. 19, 2018
Loop Antenna ^(*) Electro-Metrics	EM-6879	264	Dec. 16, 2014	Dec. 15, 2016
RF Cable	NA	LOOPCAB-001 LOOPCAB-002	Jan. 18, 2016	Jan. 17, 2017
Pre-Amplifier Mini-Circuits	ZFL-1000VH2 B	AMP-ZFL-01	Nov. 11, 2015	Nov. 10, 2016
Trilog Broadband Antenna SCHWARZBECK	VULB 9168	9168-406	Jan. 04, 2016	Jan. 03, 2017
RF Cable	8D	966-4-1 966-4-2 966-4-3	Apr. 03, 2015	Apr. 02, 2016
Software	ADT_Radiated _V8.7.07	NA	NA	NA
Antenna Tower & Turn Table CT	NA	NA	NA	NA
Boresight Antenna Fixture	NA	NA	NA	NA

Note:

1. The calibration interval of the above test instruments is 12 months and the calibrations are traceable to NML/ROC and NIST/USA.
2. *The calibration interval of the above test instruments is 24 months and the calibrations are traceable to NML/ROC and NIST/USA.
3. Loop antenna was used for all emissions below 30 MHz.
4. The test was performed in 966 Chamber No. 4.
5. The FCC Site Registration No. is 292998
6. The CANADA Site Registration No. is 20331-2
7. Tested Date: Mar. 21, 2016

**Above 1GHz test:**

DESCRIPTION & MANUFACTURER	MODEL NO.	SERIAL NO.	CALIBRATED DATE	CALIBRATED UNTIL
Test Receiver Agilent	N9038A	MY50010156	Aug. 12, 2015	Aug. 11, 2016
Horn_Antenna SCHWARZBECK	BBHA9120-D	9120D-406	Jan. 20, 2016	Jan. 19, 2017
Pre-Amplifier Agilent	8449B	3008A02465	Apr. 06, 2015	Apr. 05, 2016
RF Cable	EMC104-SM- SM-2000 EMC104-SM- SM-5000 EMC104-SM- SM-5000	150317 150321 150322	Mar. 31, 2015	Mar. 30, 2016
Spectrum Analyzer Keysight	N9030A	MY54490520	July 26, 2015	July 25, 2016
Pre-Amplifier EMCI	EMC184045	980143	Jan. 15, 2016	Jan. 14, 2017
Horn_Antenna SCHWARZBECK	BBHA 9170	BBHA9170608	Jan. 08, 2016	Jan. 07, 2017
RF Cable	SUCOFLEX 102	36432/2 36441/2	Jan. 16, 2016	Jan. 15, 2017
Software	ADT_Radiated _V8.7.07	NA	NA	NA
Antenna Tower & Turn Table CT	NA	NA	NA	NA
Boresight Antenna Fixture	NA	NA	NA	NA
Spectrum Analyzer R&S	FSP 40	100036	Jan. 27, 2016	Jan. 26, 2017
Power meter Anritsu	ML2495A	0824006	May 25, 2015	May 24, 2016
Power sensor Anritsu	MA2411B	0738172	May 25, 2015	May 24, 2016

Note:

1. The calibration interval of the above test instruments is 12 months and the calibrations are traceable to NML/ROC and NIST/USA.
2. The test was performed in 966 Chamber No. 3.
3. The FCC Site Registration No. is 147459
4. The CANADA Site Registration No. is 20331-1
5. Tested Date: Mar. 29, 2016

4.1.3 Test Procedure

- a. The EUT was placed on the top of a rotating table 0.8 meters (for below 1GHz) / 1.5 meters (for above 1GHz) above the ground at 3 meter chamber room for test. The table was rotated 360 degrees to determine the position of the highest radiation.
- b. The EUT was set 3 meters away from the interference-receiving antenna, which was mounted on the top of a variable-height antenna tower.
- c. The height of antenna is varied from one meter to four meters above the ground to determine the maximum value of the field strength. Both horizontal and vertical polarizations of the antenna are set to make the measurement.
- d. For each suspected emission, the EUT was arranged to its worst case and then the antenna was tuned to heights from 1 meter to 4 meters and the rotatable table was turned from 0 degrees to 360 degrees to find the maximum reading.
- e. The test-receiver system was set to quasi-peak detect function and specified bandwidth with maximum hold mode when the test frequency is below 1 GHz.
- f. The test-receiver system was set to peak and average detect function and specified bandwidth with maximum hold mode when the test frequency is above 1 GHz. If the peak reading value also meets average limit, measurement with the average detector is unnecessary.

Note:

1. The resolution bandwidth and video bandwidth of test receiver/spectrum analyzer is 120kHz for Quasi-peak detection (QP) at frequency below 1GHz.
2. The resolution bandwidth of test receiver/spectrum analyzer is 1 MHz and the video bandwidth is 3 MHz for Peak detection (PK) at frequency above 1GHz.
3. The resolution bandwidth of test receiver/spectrum analyzer is 1MHz and the video bandwidth is 3MHz for RMS Average (Duty cycle < 98%) for Average detection (AV) at frequency above 1GHz, then the measurement results was added to a correction factor ($10 \log(1/\text{duty cycle})$).
4. The resolution bandwidth of test receiver/spectrum analyzer is 1MHz and the video bandwidth is 10Hz (Duty cycle $\geq 98\%$) for Average detection (AV) at frequency above 1GHz.
5. All modes of operation were investigated and the worst-case emissions are reported.

4.1.4 Deviation from Test Standard

No deviation.

4.1.5 Test Setup

<Frequency Range below 1GHz>

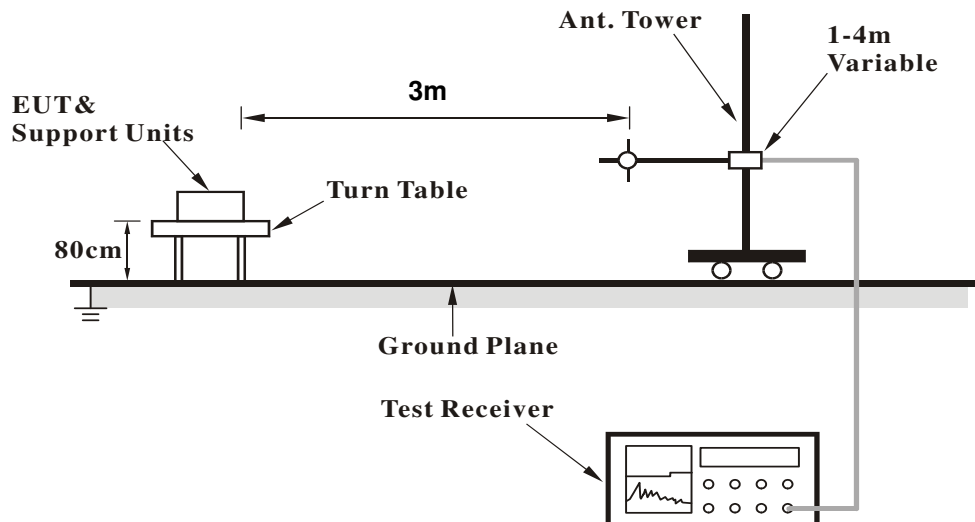

<Frequency Range above 1GHz>

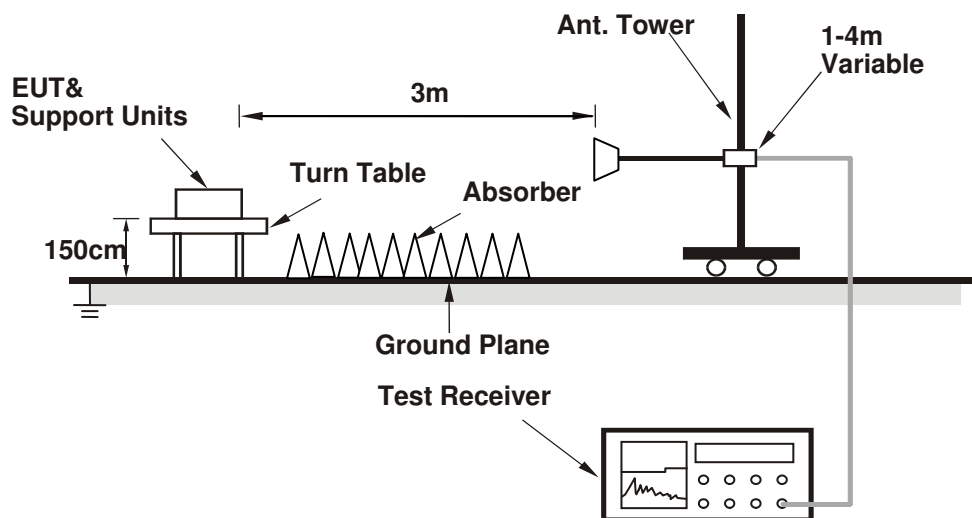

For the actual test configuration, please refer to the attached file (Test Setup Photo).

4.1.6 EUT Operating Condition

- Placed the EUT on the testing table.
- Prepared support unit B (Notebook computer) to act as communication partner and placed it outside of testing area.
- The communication partner run test program "artgui.exe V2.3" to enable EUT under transmission/receiving condition continuously at specific channel frequency.

4.1.7 Test Results

Above 1GHz Data

802.11a

CHANNEL	TX Channel 36	DETECTOR FUNCTION	Peak (PK)
FREQUENCY RANGE	1GHz ~ 40GHz		Average (AV)

ANTENNA POLARITY & TEST DISTANCE: HORIZONTAL AT 3 M

NO.	FREQ. (MHz)	EMISSION LEVEL (dBuV/m)	LIMIT (dBuV/m)	MARGIN (dB)	ANTENNA HEIGHT (m)	TABLE ANGLE (Degree)	RAW VALUE (dBuV)	CORRECTION FACTOR (dB/m)
1	5150.00	60.0 PK	74.0	-14.0	2.36 H	55	59.41	0.59
2	5150.00	48.5 AV	54.0	-5.5	2.36 H	55	47.91	0.59
3	*5180.00	117.0 PK			2.36 H	55	116.31	0.69
4	*5180.00	105.1 AV			2.36 H	55	104.41	0.69
5	#10360.00	68.3 PK	74.0	-5.7	2.49 H	84	57.58	10.72
6	#10360.00	53.5 AV	54.0	-0.5	2.49 H	84	42.78	10.72
7	15540.00	51.2 PK	74.0	-22.8	2.50 H	177	38.50	12.70
8	15540.00	40.6 AV	54.0	-13.4	2.50 H	177	27.90	12.70

ANTENNA POLARITY & TEST DISTANCE: VERTICAL AT 3 M

NO.	FREQ. (MHz)	EMISSION LEVEL (dBuV/m)	LIMIT (dBuV/m)	MARGIN (dB)	ANTENNA HEIGHT (m)	TABLE ANGLE (Degree)	RAW VALUE (dBuV)	CORRECTION FACTOR (dB/m)
1	5150.00	56.9 PK	74.0	-17.1	2.07 V	346	56.31	0.59
2	5150.00	45.0 AV	54.0	-9.0	2.07 V	346	44.41	0.59
3	*5180.00	106.1 PK			2.07 V	346	105.41	0.69
4	*5180.00	94.3 AV			2.07 V	346	93.61	0.69
5	#10360.00	65.1 PK	74.0	-8.9	2.31 V	168	54.38	10.72
6	#10360.00	51.2 AV	54.0	-2.8	2.31 V	168	40.48	10.72
7	15540.00	52.1 PK	74.0	-21.9	1.65 V	121	39.40	12.70
8	15540.00	40.1 AV	54.0	-13.9	1.65 V	121	27.40	12.70

REMARKS:

1. Emission Level(dBuV/m) = Raw Value(dBuV) + Correction Factor(dB/m)
2. Correction Factor(dB/m) = Antenna Factor(dB/m) + Cable Factor(dB) – Pre-Amplifier Factor(dB)
3. The other emission levels were very low against the limit.
4. Margin value = Emission Level – Limit value
5. " * ": Fundamental frequency.
6. " # ": The radiated frequency is out of the restricted band.

CHANNEL	TX Channel 40	DETECTOR FUNCTION	Peak (PK)
FREQUENCY RANGE	1GHz ~ 40GHz		Average (AV)

ANTENNA POLARITY & TEST DISTANCE: HORIZONTAL AT 3 M

NO.	FREQ. (MHz)	EMISSION LEVEL (dBuV/m)	LIMIT (dBuV/m)	MARGIN (dB)	ANTENNA HEIGHT (m)	TABLE ANGLE (Degree)	RAW VALUE (dBuV)	CORRECTION FACTOR (dB/m)
1	*5200.00	117.2 PK			2.36 H	39	116.45	0.75
2	*5200.00	105.3 AV			2.36 H	39	104.55	0.75
3	#10400.00	68.0 PK	74.0	-6.0	2.47 H	83	56.96	11.04
4	#10400.00	53.4 AV	54.0	-0.6	2.47 H	83	42.36	11.04
5	15600.00	51.1 PK	74.0	-22.9	2.45 H	164	38.36	12.74
6	15600.00	40.3 AV	54.0	-13.7	2.45 H	164	27.56	12.74

ANTENNA POLARITY & TEST DISTANCE: VERTICAL AT 3 M

NO.	FREQ. (MHz)	EMISSION LEVEL (dBuV/m)	LIMIT (dBuV/m)	MARGIN (dB)	ANTENNA HEIGHT (m)	TABLE ANGLE (Degree)	RAW VALUE (dBuV)	CORRECTION FACTOR (dB/m)
1	*5200.00	106.4 PK			2.10 V	360	105.65	0.75
2	*5200.00	94.6 AV			2.10 V	360	93.85	0.75
3	#10400.00	65.8 PK	74.0	-8.2	2.35 V	165	54.76	11.04
4	#10400.00	51.6 AV	54.0	-2.4	2.35 V	165	40.56	11.04
5	15600.00	52.7 PK	74.0	-21.3	1.61 V	127	39.96	12.74
6	15600.00	40.5 AV	54.0	-13.5	1.61 V	127	27.76	12.74

REMARKS:

1. Emission Level(dBuV/m) = Raw Value(dBuV) + Correction Factor(dB/m)
2. Correction Factor(dB/m) = Antenna Factor(dB/m) + Cable Factor(dB) – Pre-Amplifier Factor(dB)
3. The other emission levels were very low against the limit.
4. Margin value = Emission Level – Limit value
5. " * ": Fundamental frequency.
6. " # ": The radiated frequency is out of the restricted band.



CHANNEL	TX Channel 48	DETECTOR FUNCTION	Peak (PK)
FREQUENCY RANGE	1GHz ~ 40GHz		Average (AV)

ANTENNA POLARITY & TEST DISTANCE: HORIZONTAL AT 3 M

NO.	FREQ. (MHz)	EMISSION LEVEL (dBuV/m)	LIMIT (dBuV/m)	MARGIN (dB)	ANTENNA HEIGHT (m)	TABLE ANGLE (Degree)	RAW VALUE (dBuV)	CORRECTION FACTOR (dB/m)
1	*5240.00	117.0 PK			2.38 H	52	116.11	0.89
2	*5240.00	106.1 AV			2.38 H	52	105.21	0.89
3	5350.00	57.5 PK	74.0	-16.5	2.38 H	52	56.34	1.16
4	5350.00	44.9 AV	54.0	-9.1	2.38 H	52	43.74	1.16
5	#10480.00	68.1 PK	74.0	-5.9	2.44 H	79	57.27	10.83
6	#10480.00	53.5 AV	54.0	-0.5	2.44 H	79	42.67	10.83
7	15720.00	50.7 PK	74.0	-23.3	2.52 H	185	38.72	11.98
8	15720.00	40.3 AV	54.0	-13.7	2.52 H	185	28.32	11.98

ANTENNA POLARITY & TEST DISTANCE: VERTICAL AT 3 M

NO.	FREQ. (MHz)	EMISSION LEVEL (dBuV/m)	LIMIT (dBuV/m)	MARGIN (dB)	ANTENNA HEIGHT (m)	TABLE ANGLE (Degree)	RAW VALUE (dBuV)	CORRECTION FACTOR (dB/m)
1	*5240.00	106.2 PK			2.15 V	360	105.31	0.89
2	*5240.00	95.3 AV			2.15 V	360	94.41	0.89
3	5350.00	54.3 PK	74.0	-19.7	2.15 V	360	53.14	1.16
4	5350.00	41.6 AV	54.0	-12.4	2.15 V	360	40.44	1.16
5	#10480.00	65.5 PK	74.0	-8.5	2.41 V	152	54.67	10.83
6	#10480.00	51.4 AV	54.0	-2.6	2.41 V	152	40.57	10.83
7	15720.00	52.8 PK	74.0	-21.2	1.56 V	130	40.82	11.98
8	15720.00	40.6 AV	54.0	-13.4	1.56 V	130	28.62	11.98

REMARKS:

1. Emission Level(dBuV/m) = Raw Value(dBuV) + Correction Factor(dB/m)
2. Correction Factor(dB/m) = Antenna Factor(dB/m) + Cable Factor(dB) – Pre-Amplifier Factor(dB)
3. The other emission levels were very low against the limit.
4. Margin value = Emission Level – Limit value
5. " * ": Fundamental frequency.
6. " # ": The radiated frequency is out of the restricted band.

CHANNEL	TX Channel 149	DETECTOR FUNCTION	Peak (PK)
FREQUENCY RANGE	1GHz ~ 40GHz		Average (AV)

ANTENNA POLARITY & TEST DISTANCE: HORIZONTAL AT 3 M

NO.	FREQ. (MHz)	EMISSION LEVEL (dBuV/m)	LIMIT (dBuV/m)	MARGIN (dB)	ANTENNA HEIGHT (m)	TABLE ANGLE (Degree)	RAW VALUE (dBuV)	CORRECTION FACTOR (dB/m)
1	#5715.00	58.7 PK	74.0	-15.3	2.29 H	65	57.00	1.70
2	#5715.00	46.3 AV	54.0	-7.7	2.29 H	65	44.60	1.70
3	#5725.00	70.9 PK	78.2	-7.3	2.29 H	65	69.19	1.71
4	*5745.00	115.2 PK			2.29 H	65	113.46	1.74
5	*5745.00	103.2 AV			2.29 H	65	101.46	1.74
6	11490.00	66.7 PK	74.0	-7.3	2.36 H	135	54.29	12.41
7	11490.00	53.5 AV	54.0	-0.5	2.36 H	135	41.09	12.41
8	#17235.00	50.8 PK	74.0	-23.2	2.49 H	188	34.08	16.72
9	#17235.00	40.2 AV	54.0	-13.8	2.49 H	188	23.48	16.72

ANTENNA POLARITY & TEST DISTANCE: VERTICAL AT 3 M

NO.	FREQ. (MHz)	EMISSION LEVEL (dBuV/m)	LIMIT (dBuV/m)	MARGIN (dB)	ANTENNA HEIGHT (m)	TABLE ANGLE (Degree)	RAW VALUE (dBuV)	CORRECTION FACTOR (dB/m)
1	#5715.00	55.6 PK	74.0	-18.4	2.16 V	360	53.90	1.70
2	#5715.00	42.9 AV	54.0	-11.1	2.16 V	360	41.20	1.70
3	#5725.00	66.8 PK	78.2	-11.4	2.16 V	360	65.09	1.71
4	*5745.00	104.3 PK			2.16 V	360	102.56	1.74
5	*5745.00	92.4 AV			2.16 V	360	90.66	1.74
6	11490.00	66.2 PK	74.0	-7.8	2.38 V	140	53.79	12.41
7	11490.00	51.9 AV	54.0	-2.1	2.38 V	140	39.49	12.41
8	#17235.00	52.4 PK	74.0	-21.6	1.59 V	120	35.68	16.72
9	#17235.00	40.2 AV	54.0	-13.8	1.59 V	120	23.48	16.72

REMARKS:

1. Emission Level(dBuV/m) = Raw Value(dBuV) + Correction Factor(dB/m)
2. Correction Factor(dB/m) = Antenna Factor(dB/m) + Cable Factor(dB) – Pre-Amplifier Factor(dB)
3. The other emission levels were very low against the limit.
4. Margin value = Emission Level – Limit value
5. " * ": Fundamental frequency.
6. " # ": The radiated frequency is out of the restricted band.

CHANNEL	TX Channel 157	DETECTOR FUNCTION	Peak (PK)
FREQUENCY RANGE	1GHz ~ 40GHz		Average (AV)

ANTENNA POLARITY & TEST DISTANCE: HORIZONTAL AT 3 M

NO.	FREQ. (MHz)	EMISSION LEVEL (dBuV/m)	LIMIT (dBuV/m)	MARGIN (dB)	ANTENNA HEIGHT (m)	TABLE ANGLE (Degree)	RAW VALUE (dBuV)	CORRECTION FACTOR (dB/m)
1	#5715.00	57.1 PK	74.0	-16.9	2.33 H	67	55.40	1.70
2	#5715.00	43.9 AV	54.0	-10.1	2.33 H	67	42.20	1.70
3	#5725.00	56.8 PK	78.2	-21.4	2.33 H	67	55.09	1.71
4	*5785.00	115.8 PK			2.33 H	67	114.00	1.80
5	*5785.00	103.4 AV			2.33 H	67	101.60	1.80
6	#5850.00	55.1 PK	78.2	-23.1	2.33 H	67	53.28	1.82
7	#5860.00	54.8 PK	74.0	-19.2	2.33 H	67	52.98	1.82
8	#5860.00	43.1 AV	54.0	-10.9	2.33 H	67	41.28	1.82
9	11570.00	67.4 PK	74.0	-6.6	2.42 H	136	55.22	12.18
10	11570.00	53.4 AV	54.0	-0.6	2.42 H	136	41.22	12.18
11	#17355.00	50.4 PK	74.0	-23.6	2.50 H	190	33.13	17.27
12	#17355.00	39.8 AV	54.0	-14.2	2.50 H	190	22.53	17.27

ANTENNA POLARITY & TEST DISTANCE: VERTICAL AT 3 M

NO.	FREQ. (MHz)	EMISSION LEVEL (dBuV/m)	LIMIT (dBuV/m)	MARGIN (dB)	ANTENNA HEIGHT (m)	TABLE ANGLE (Degree)	RAW VALUE (dBuV)	CORRECTION FACTOR (dB/m)
1	#5715.00	54.0 PK	74.0	-20.0	1.27 V	211	52.30	1.70
2	#5715.00	40.4 AV	54.0	-13.6	1.27 V	211	38.70	1.70
3	#5725.00	52.7 PK	78.2	-25.5	1.27 V	211	50.99	1.71
4	*5785.00	107.8 PK			1.27 V	211	106.00	1.80
5	*5785.00	96.1 AV			1.27 V	211	94.30	1.80
6	#5850.00	53.1 PK	78.2	-25.1	1.27 V	211	51.28	1.82
7	#5860.00	52.8 PK	74.0	-21.2	1.27 V	211	50.98	1.82
8	#5860.00	40.3 AV	54.0	-13.7	1.27 V	211	38.48	1.82
9	11570.00	66.2 PK	74.0	-7.8	2.41 V	146	54.02	12.18
10	11570.00	51.8 AV	54.0	-2.2	2.41 V	146	39.62	12.18
11	#17355.00	52.3 PK	74.0	-21.7	1.54 V	115	35.03	17.27
12	#17355.00	39.9 AV	54.0	-14.1	1.54 V	115	22.63	17.27

REMARKS:

1. Emission Level(dBuV/m) = Raw Value(dBuV) + Correction Factor(dB/m)
2. Correction Factor(dB/m) = Antenna Factor(dB/m) + Cable Factor(dB) – Pre-Amplifier Factor(dB)
3. The other emission levels were very low against the limit.
4. Margin value = Emission Level – Limit value
5. " * ": Fundamental frequency.
6. " # ": The radiated frequency is out of the restricted band.

CHANNEL	TX Channel 165	DETECTOR FUNCTION	Peak (PK)
FREQUENCY RANGE	1GHz ~ 40GHz		Average (AV)

ANTENNA POLARITY & TEST DISTANCE: HORIZONTAL AT 3 M

NO.	FREQ. (MHz)	EMISSION LEVEL (dBuV/m)	LIMIT (dBuV/m)	MARGIN (dB)	ANTENNA HEIGHT (m)	TABLE ANGLE (Degree)	RAW VALUE (dBuV)	CORRECTION FACTOR (dB/m)
1	*5825.00	115.2 PK			2.42 H	67	113.37	1.83
2	*5825.00	103.4 AV			2.42 H	67	101.57	1.83
3	#5850.00	61.8 PK	78.2	-16.4	2.42 H	67	59.98	1.82
4	#5860.00	55.4 PK	74.0	-18.6	2.42 H	67	53.58	1.82
5	#5860.00	43.7 AV	54.0	-10.3	2.42 H	67	41.88	1.82
6	11650.00	66.9 PK	74.0	-7.1	2.44 H	162	54.87	12.03
7	11650.00	53.4 AV	54.0	-0.6	2.44 H	162	41.37	12.03
8	#17475.00	50.3 PK	74.0	-23.7	2.56 H	199	32.54	17.76
9	#17475.00	39.8 AV	54.0	-14.2	2.56 H	199	22.04	17.76

ANTENNA POLARITY & TEST DISTANCE: VERTICAL AT 3 M

NO.	FREQ. (MHz)	EMISSION LEVEL (dBuV/m)	LIMIT (dBuV/m)	MARGIN (dB)	ANTENNA HEIGHT (m)	TABLE ANGLE (Degree)	RAW VALUE (dBuV)	CORRECTION FACTOR (dB/m)
1	*5825.00	108.0 PK			1.23 V	214	106.17	1.83
2	*5825.00	96.4 AV			1.23 V	214	94.57	1.83
3	#5850.00	58.5 PK	78.2	-19.7	1.23 V	214	56.68	1.82
4	#5860.00	52.4 PK	74.0	-21.6	1.23 V	214	50.58	1.82
5	#5860.00	40.4 AV	54.0	-13.6	1.23 V	214	38.58	1.82
6	11650.00	66.7 PK	74.0	-7.3	2.43 V	156	54.67	12.03
7	11650.00	52.1 AV	54.0	-1.9	2.43 V	156	40.07	12.03
8	#17475.00	52.2 PK	74.0	-21.8	1.60 V	102	34.44	17.76
9	#17475.00	39.5 AV	54.0	-14.5	1.60 V	102	21.74	17.76

REMARKS:

1. Emission Level(dBuV/m) = Raw Value(dBuV) + Correction Factor(dB/m)
2. Correction Factor(dB/m) = Antenna Factor(dB/m) + Cable Factor(dB) – Pre-Amplifier Factor(dB)
3. The other emission levels were very low against the limit.
4. Margin value = Emission Level – Limit value
5. " * ": Fundamental frequency.
6. " # ": The radiated frequency is out of the restricted band.

802.11ac (VHT20)

CHANNEL	TX Channel 36	DETECTOR FUNCTION	Peak (PK)
FREQUENCY RANGE	1GHz ~ 40GHz		Average (AV)

ANTENNA POLARITY & TEST DISTANCE: HORIZONTAL AT 3 M								
NO.	FREQ. (MHz)	EMISSION LEVEL (dBuV/m)	LIMIT (dBuV/m)	MARGIN (dB)	ANTENNA HEIGHT (m)	TABLE ANGLE (Degree)	RAW VALUE (dBuV)	CORRECTION FACTOR (dB/m)
1	5150.00	59.7 PK	74.0	-14.3	2.37 H	58	59.11	0.59
2	5150.00	48.2 AV	54.0	-5.8	2.37 H	58	47.61	0.59
3	*5180.00	117.0 PK			2.37 H	58	116.31	0.69
4	*5180.00	105.2 AV			2.37 H	58	104.51	0.69
5	#10360.00	69.7 PK	74.0	-4.3	2.49 H	86	58.98	10.72
6	#10360.00	53.6 AV	54.0	-0.4	2.49 H	86	42.88	10.72
7	15540.00	50.5 PK	74.0	-23.5	2.45 H	186	37.80	12.70
8	15540.00	40.0 AV	54.0	-14.0	2.45 H	186	27.30	12.70

ANTENNA POLARITY & TEST DISTANCE: VERTICAL AT 3 M								
NO.	FREQ. (MHz)	EMISSION LEVEL (dBuV/m)	LIMIT (dBuV/m)	MARGIN (dB)	ANTENNA HEIGHT (m)	TABLE ANGLE (Degree)	RAW VALUE (dBuV)	CORRECTION FACTOR (dB/m)
1	5150.00	56.5 PK	74.0	-17.5	1.18 V	206	55.91	0.59
2	5150.00	44.6 AV	54.0	-9.4	1.18 V	206	44.01	0.59
3	*5180.00	106.1 PK			1.18 V	206	105.41	0.69
4	*5180.00	94.4 AV			1.18 V	206	93.71	0.69
5	#10360.00	64.7 PK	74.0	-9.3	2.43 V	146	53.98	10.72
6	#10360.00	50.9 AV	54.0	-3.1	2.43 V	146	40.18	10.72
7	15540.00	53.1 PK	74.0	-20.9	1.61 V	121	40.40	12.70
8	15540.00	41.1 AV	54.0	-12.9	1.61 V	121	28.40	12.70

REMARKS:

1. Emission Level(dBuV/m) = Raw Value(dBuV) + Correction Factor(dB/m)
2. Correction Factor(dB/m) = Antenna Factor(dB/m) + Cable Factor(dB) – Pre-Amplifier Factor(dB)
3. The other emission levels were very low against the limit.
4. Margin value = Emission Level – Limit value
5. " * ": Fundamental frequency.
6. " # ": The radiated frequency is out of the restricted band.

CHANNEL	TX Channel 40	DETECTOR FUNCTION	Peak (PK)
FREQUENCY RANGE	1GHz ~ 40GHz		Average (AV)

ANTENNA POLARITY & TEST DISTANCE: HORIZONTAL AT 3 M

NO.	FREQ. (MHz)	EMISSION LEVEL (dBuV/m)	LIMIT (dBuV/m)	MARGIN (dB)	ANTENNA HEIGHT (m)	TABLE ANGLE (Degree)	RAW VALUE (dBuV)	CORRECTION FACTOR (dB/m)
1	*5200.00	116.9 PK			2.35 H	45	116.15	0.75
2	*5200.00	105.1 AV			2.35 H	45	104.35	0.75
3	#10400.00	69.9 PK	74.0	-4.1	2.49 H	82	58.86	11.04
4	#10400.00	53.2 AV	54.0	-0.8	2.49 H	82	42.16	11.04
5	15600.00	50.7 PK	74.0	-23.3	2.45 H	177	37.96	12.74
6	15600.00	40.4 AV	54.0	-13.6	2.45 H	177	27.66	12.74

ANTENNA POLARITY & TEST DISTANCE: VERTICAL AT 3 M

NO.	FREQ. (MHz)	EMISSION LEVEL (dBuV/m)	LIMIT (dBuV/m)	MARGIN (dB)	ANTENNA HEIGHT (m)	TABLE ANGLE (Degree)	RAW VALUE (dBuV)	CORRECTION FACTOR (dB/m)
1	*5200.00	105.9 PK			1.19 V	204	105.15	0.75
2	*5200.00	94.1 AV			1.19 V	204	93.35	0.75
3	#10400.00	65.1 PK	74.0	-8.9	2.38 V	142	54.06	11.04
4	#10400.00	51.2 AV	54.0	-2.8	2.38 V	142	40.16	11.04
5	15600.00	53.0 PK	74.0	-21.0	1.60 V	123	40.26	12.74
6	15600.00	40.8 AV	54.0	-13.2	1.60 V	123	28.06	12.74

REMARKS:

1. Emission Level(dBuV/m) = Raw Value(dBuV) + Correction Factor(dB/m)
2. Correction Factor(dB/m) = Antenna Factor(dB/m) + Cable Factor(dB) – Pre-Amplifier Factor(dB)
3. The other emission levels were very low against the limit.
4. Margin value = Emission Level – Limit value
5. " * ": Fundamental frequency.
6. " # ": The radiated frequency is out of the restricted band.

CHANNEL	TX Channel 48	DETECTOR FUNCTION	Peak (PK)
FREQUENCY RANGE	1GHz ~ 40GHz		Average (AV)

ANTENNA POLARITY & TEST DISTANCE: HORIZONTAL AT 3 M

NO.	FREQ. (MHz)	EMISSION LEVEL (dBuV/m)	LIMIT (dBuV/m)	MARGIN (dB)	ANTENNA HEIGHT (m)	TABLE ANGLE (Degree)	RAW VALUE (dBuV)	CORRECTION FACTOR (dB/m)
1	*5240.00	117.4 PK			2.37 H	40	116.51	0.89
2	*5240.00	106.5 AV			2.37 H	40	105.61	0.89
3	5350.00	59.9 PK	74.0	-14.1	2.37 H	40	58.74	1.16
4	5350.00	48.7 AV	54.0	-5.3	2.37 H	40	47.54	1.16
5	#10480.00	69.5 PK	74.0	-4.5	2.50 H	84	58.67	10.83
6	#10480.00	53.5 AV	54.0	-0.5	2.50 H	84	42.67	10.83
7	15720.00	51.1 PK	74.0	-22.9	2.50 H	177	39.12	11.98
8	15720.00	40.6 AV	54.0	-13.4	2.50 H	177	28.62	11.98

ANTENNA POLARITY & TEST DISTANCE: VERTICAL AT 3 M

NO.	FREQ. (MHz)	EMISSION LEVEL (dBuV/m)	LIMIT (dBuV/m)	MARGIN (dB)	ANTENNA HEIGHT (m)	TABLE ANGLE (Degree)	RAW VALUE (dBuV)	CORRECTION FACTOR (dB/m)
1	*5240.00	106.5 PK			1.21 V	209	105.61	0.89
2	*5240.00	95.7 AV			1.21 V	209	94.81	0.89
3	5350.00	56.4 PK	74.0	-17.6	1.21 V	209	55.24	1.16
4	5350.00	44.5 AV	54.0	-9.5	1.21 V	209	43.34	1.16
5	#10480.00	65.3 PK	74.0	-8.7	2.40 V	150	54.47	10.83
6	#10480.00	51.7 AV	54.0	-2.3	2.40 V	150	40.87	10.83
7	15720.00	53.0 PK	74.0	-21.0	1.60 V	129	41.02	11.98
8	15720.00	40.6 AV	54.0	-13.4	1.60 V	129	28.62	11.98

REMARKS:

1. Emission Level(dBuV/m) = Raw Value(dBuV) + Correction Factor(dB/m)
2. Correction Factor(dB/m) = Antenna Factor(dB/m) + Cable Factor(dB) – Pre-Amplifier Factor(dB)
3. The other emission levels were very low against the limit.
4. Margin value = Emission Level – Limit value
5. " * ": Fundamental frequency.
6. " # ": The radiated frequency is out of the restricted band.

CHANNEL	TX Channel 149	DETECTOR FUNCTION	Peak (PK)
FREQUENCY RANGE	1GHz ~ 40GHz		Average (AV)

ANTENNA POLARITY & TEST DISTANCE: HORIZONTAL AT 3 M

NO.	FREQ. (MHz)	EMISSION LEVEL (dBuV/m)	LIMIT (dBuV/m)	MARGIN (dB)	ANTENNA HEIGHT (m)	TABLE ANGLE (Degree)	RAW VALUE (dBuV)	CORRECTION FACTOR (dB/m)
1	#5715.00	58.5 PK	74.0	-15.5	2.33 H	51	56.80	1.70
2	#5715.00	46.1 AV	54.0	-7.9	2.33 H	51	44.40	1.70
3	#5725.00	70.2 PK	78.2	-8.0	2.33 H	51	68.49	1.71
4	*5745.00	115.4 PK			2.33 H	51	113.66	1.74
5	*5745.00	103.2 AV			2.33 H	51	101.46	1.74
6	11490.00	69.2 PK	74.0	-4.8	2.35 H	136	56.79	12.41
7	11490.00	53.8 AV	54.0	-0.2	2.35 H	136	41.39	12.41
8	#17235.00	51.2 PK	74.0	-22.8	2.48 H	168	34.48	16.72
9	#17235.00	40.7 AV	54.0	-13.3	2.48 H	168	23.98	16.72

ANTENNA POLARITY & TEST DISTANCE: VERTICAL AT 3 M

NO.	FREQ. (MHz)	EMISSION LEVEL (dBuV/m)	LIMIT (dBuV/m)	MARGIN (dB)	ANTENNA HEIGHT (m)	TABLE ANGLE (Degree)	RAW VALUE (dBuV)	CORRECTION FACTOR (dB/m)
1	#5715.00	55.3 PK	74.0	-18.7	1.19 V	195	53.60	1.70
2	#5715.00	42.7 AV	54.0	-11.3	1.19 V	195	41.00	1.70
3	#5725.00	66.1 PK	78.2	-12.1	1.19 V	195	64.39	1.71
4	*5745.00	104.5 PK			1.19 V	195	102.76	1.74
5	*5745.00	92.4 AV			1.19 V	195	90.66	1.74
6	11490.00	65.8 PK	74.0	-8.2	2.45 V	150	53.39	12.41
7	11490.00	51.9 AV	54.0	-2.1	2.45 V	150	39.49	12.41
8	#17235.00	52.7 PK	74.0	-21.3	1.65 V	113	35.98	16.72
9	#17235.00	40.3 AV	54.0	-13.7	1.65 V	113	23.58	16.72

REMARKS:

1. Emission Level(dBuV/m) = Raw Value(dBuV) + Correction Factor(dB/m)
2. Correction Factor(dB/m) = Antenna Factor(dB/m) + Cable Factor(dB) – Pre-Amplifier Factor(dB)
3. The other emission levels were very low against the limit.
4. Margin value = Emission Level – Limit value
5. " * ": Fundamental frequency.
6. " # ": The radiated frequency is out of the restricted band.

CHANNEL	TX Channel 157	DETECTOR FUNCTION	Peak (PK)
FREQUENCY RANGE	1GHz ~ 40GHz		Average (AV)

ANTENNA POLARITY & TEST DISTANCE: HORIZONTAL AT 3 M

NO.	FREQ. (MHz)	EMISSION LEVEL (dBuV/m)	LIMIT (dBuV/m)	MARGIN (dB)	ANTENNA HEIGHT (m)	TABLE ANGLE (Degree)	RAW VALUE (dBuV)	CORRECTION FACTOR (dB/m)
1	#5715.00	57.6 PK	74.0	-16.4	2.38 H	78	55.90	1.70
2	#5715.00	44.1 AV	54.0	-9.9	2.38 H	78	42.40	1.70
3	#5725.00	56.9 PK	78.2	-21.3	2.38 H	78	55.19	1.71
4	*5785.00	115.9 PK			2.38 H	78	114.10	1.80
5	*5785.00	103.3 AV			2.38 H	78	101.50	1.80
6	#5850.00	54.5 PK	78.2	-23.7	2.38 H	78	52.68	1.82
7	#5860.00	55.2 PK	74.0	-18.8	2.38 H	78	53.38	1.82
8	#5860.00	43.3 AV	54.0	-10.7	2.38 H	78	41.48	1.82
9	11570.00	68.7 PK	74.0	-5.3	2.35 H	135	56.52	12.18
10	11570.00	53.9 AV	54.0	-0.1	2.35 H	135	41.72	12.18
11	#17355.00	51.7 PK	74.0	-22.3	2.43 H	181	34.43	17.27
12	#17355.00	41.0 AV	54.0	-13.0	2.43 H	181	23.73	17.27

ANTENNA POLARITY & TEST DISTANCE: VERTICAL AT 3 M

NO.	FREQ. (MHz)	EMISSION LEVEL (dBuV/m)	LIMIT (dBuV/m)	MARGIN (dB)	ANTENNA HEIGHT (m)	TABLE ANGLE (Degree)	RAW VALUE (dBuV)	CORRECTION FACTOR (dB/m)
1	#5715.00	54.4 PK	74.0	-19.6	1.19 V	209	52.70	1.70
2	#5715.00	41.0 AV	54.0	-13.0	1.19 V	209	39.30	1.70
3	#5725.00	52.7 PK	78.2	-25.5	1.19 V	209	50.99	1.71
4	*5785.00	104.1 PK			1.19 V	209	102.30	1.80
5	*5785.00	92.1 AV			1.19 V	209	90.30	1.80
6	#5850.00	50.7 PK	78.2	-27.5	1.19 V	209	48.88	1.82
7	#5860.00	52.0 PK	74.0	-22.0	1.19 V	209	50.18	1.82
8	#5860.00	40.1 AV	54.0	-13.9	1.19 V	209	38.28	1.82
9	11570.00	66.0 PK	74.0	-8.0	2.47 V	162	53.82	12.18
10	11570.00	51.9 AV	54.0	-2.1	2.47 V	162	39.72	12.18
11	#17355.00	52.6 PK	74.0	-21.4	1.69 V	98	35.33	17.27
12	#17355.00	40.1 AV	54.0	-13.9	1.69 V	98	22.83	17.27

REMARKS:

1. Emission Level(dBuV/m) = Raw Value(dBuV) + Correction Factor(dB/m)
2. Correction Factor(dB/m) = Antenna Factor(dB/m) + Cable Factor(dB) – Pre-Amplifier Factor(dB)
3. The other emission levels were very low against the limit.
4. Margin value = Emission Level – Limit value
5. " * ": Fundamental frequency.
6. " # ": The radiated frequency is out of the restricted band.

CHANNEL	TX Channel 165	DETECTOR FUNCTION	Peak (PK)
FREQUENCY RANGE	1GHz ~ 40GHz		Average (AV)

ANTENNA POLARITY & TEST DISTANCE: HORIZONTAL AT 3 M

NO.	FREQ. (MHz)	EMISSION LEVEL (dBuV/m)	LIMIT (dBuV/m)	MARGIN (dB)	ANTENNA HEIGHT (m)	TABLE ANGLE (Degree)	RAW VALUE (dBuV)	CORRECTION FACTOR (dB/m)
1	*5825.00	114.9 PK			2.47 H	59	113.07	1.83
2	*5825.00	103.1 AV			2.47 H	59	101.27	1.83
3	#5850.00	61.4 PK	78.2	-16.8	2.47 H	59	59.58	1.82
4	#5860.00	55.7 PK	74.0	-18.3	2.47 H	59	53.88	1.82
5	#5860.00	44.1 AV	54.0	-9.9	2.47 H	59	42.28	1.82
6	11650.00	68.4 PK	74.0	-5.6	2.41 H	161	56.37	12.03
7	11650.00	53.9 AV	54.0	-0.1	2.41 H	161	41.87	12.03
8	#17475.00	51.7 PK	74.0	-22.3	2.43 H	179	33.94	17.76
9	#17475.00	41.1 AV	54.0	-12.9	2.43 H	179	23.34	17.76

ANTENNA POLARITY & TEST DISTANCE: VERTICAL AT 3 M

NO.	FREQ. (MHz)	EMISSION LEVEL (dBuV/m)	LIMIT (dBuV/m)	MARGIN (dB)	ANTENNA HEIGHT (m)	TABLE ANGLE (Degree)	RAW VALUE (dBuV)	CORRECTION FACTOR (dB/m)
1	*5825.00	104.3 PK			1.20 V	193	102.47	1.83
2	*5825.00	92.3 AV			1.20 V	193	90.47	1.83
3	#5850.00	57.2 PK	78.2	-21.0	1.20 V	193	55.38	1.82
4	#5860.00	52.5 PK	74.0	-21.5	1.20 V	193	50.68	1.82
5	#5860.00	40.5 AV	54.0	-13.5	1.20 V	193	38.68	1.82
6	11650.00	66.2 PK	74.0	-7.8	2.43 V	172	54.17	12.03
7	11650.00	52.0 AV	54.0	-2.0	2.43 V	172	39.97	12.03
8	#17475.00	52.2 PK	74.0	-21.8	1.72 V	105	34.44	17.76
9	#17475.00	39.9 AV	54.0	-14.1	1.72 V	105	22.14	17.76

REMARKS:

1. Emission Level(dBuV/m) = Raw Value(dBuV) + Correction Factor(dB/m)
2. Correction Factor(dB/m) = Antenna Factor(dB/m) + Cable Factor(dB) – Pre-Amplifier Factor(dB)
3. The other emission levels were very low against the limit.
4. Margin value = Emission Level – Limit value
5. " * ": Fundamental frequency.
6. " # ": The radiated frequency is out of the restricted band.

802.11ac (VHT40)

CHANNEL	TX Channel 38	DETECTOR FUNCTION	Peak (PK)
FREQUENCY RANGE	1GHz ~ 40GHz		Average (AV)

ANTENNA POLARITY & TEST DISTANCE: HORIZONTAL AT 3 M

NO.	FREQ. (MHz)	EMISSION LEVEL (dBuV/m)	LIMIT (dBuV/m)	MARGIN (dB)	ANTENNA HEIGHT (m)	TABLE ANGLE (Degree)	RAW VALUE (dBuV)	CORRECTION FACTOR (dB/m)
1	5150.00	67.7 PK	74.0	-6.3	2.32 H	53	67.11	0.59
2	5150.00	53.6 AV	54.0	-0.4	2.32 H	53	53.01	0.59
3	*5190.00	110.3 PK			2.32 H	53	109.59	0.71
4	*5190.00	102.1 AV			2.32 H	53	101.39	0.71
5	5350.00	56.4 PK	74.0	-17.6	2.32 H	53	55.24	1.16
6	5350.00	42.7 AV	54.0	-11.3	2.32 H	53	41.54	1.16
7	#10380.00	64.1 PK	74.0	-9.9	2.40 H	166	53.21	10.89
8	#10380.00	50.1 AV	54.0	-3.9	2.40 H	166	39.21	10.89
9	15570.00	51.5 PK	74.0	-22.5	2.47 H	194	38.78	12.72
10	15570.00	41.0 AV	54.0	-13.0	2.47 H	194	28.28	12.72

ANTENNA POLARITY & TEST DISTANCE: VERTICAL AT 3 M

NO.	FREQ. (MHz)	EMISSION LEVEL (dBuV/m)	LIMIT (dBuV/m)	MARGIN (dB)	ANTENNA HEIGHT (m)	TABLE ANGLE (Degree)	RAW VALUE (dBuV)	CORRECTION FACTOR (dB/m)
1	5150.00	64.4 PK	74.0	-9.6	1.17 V	187	63.81	0.59
2	5150.00	50.2 AV	54.0	-3.8	1.17 V	187	49.61	0.59
3	*5190.00	99.4 PK			1.17 V	187	98.69	0.71
4	*5190.00	91.3 AV			1.17 V	187	90.59	0.71
5	5350.00	53.3 PK	74.0	-20.7	1.17 V	187	52.14	1.16
6	5350.00	39.6 AV	54.0	-14.4	1.17 V	187	38.44	1.16
7	#10380.00	62.6 PK	74.0	-11.4	2.45 V	171	51.71	10.89
8	#10380.00	48.5 AV	54.0	-5.5	2.45 V	171	37.61	10.89
9	15570.00	52.3 PK	74.0	-21.7	1.76 V	100	39.58	12.72
10	15570.00	40.3 AV	54.0	-13.7	1.76 V	100	27.58	12.72

REMARKS:

- Emission Level(dBuV/m) = Raw Value(dBuV) + Correction Factor(dB/m)
- Correction Factor(dB/m) = Antenna Factor(dB/m) + Cable Factor(dB) – Pre-Amplifier Factor(dB)
- The other emission levels were very low against the limit.
- Margin value = Emission Level – Limit value
- " * ": Fundamental frequency.
- " # ": The radiated frequency is out of the restricted band.

CHANNEL	TX Channel 46	DETECTOR FUNCTION	Peak (PK)
FREQUENCY RANGE	1GHz ~ 40GHz		Average (AV)

ANTENNA POLARITY & TEST DISTANCE: HORIZONTAL AT 3 M

NO.	FREQ. (MHz)	EMISSION LEVEL (dBuV/m)	LIMIT (dBuV/m)	MARGIN (dB)	ANTENNA HEIGHT (m)	TABLE ANGLE (Degree)	RAW VALUE (dBuV)	CORRECTION FACTOR (dB/m)
1	5150.00	56.0 PK	74.0	-18.0	2.45 H	53	55.41	0.59
2	5150.00	45.0 AV	54.0	-9.0	2.45 H	53	44.41	0.59
3	*5230.00	113.7 PK			2.45 H	53	112.84	0.86
4	*5230.00	105.3 AV			2.45 H	53	104.44	0.86
5	5350.00	54.1 PK	74.0	-19.9	2.45 H	53	52.94	1.16
6	5350.00	40.1 AV	54.0	-13.9	2.45 H	53	38.94	1.16
7	#10460.00	64.5 PK	74.0	-9.5	2.51 H	103	53.63	10.87
8	#10460.00	50.3 AV	54.0	-3.7	2.51 H	103	39.43	10.87
9	15690.00	51.6 PK	74.0	-22.4	2.49 H	202	39.50	12.10
10	15690.00	40.9 AV	54.0	-13.1	2.49 H	202	28.80	12.10

ANTENNA POLARITY & TEST DISTANCE: VERTICAL AT 3 M

NO.	FREQ. (MHz)	EMISSION LEVEL (dBuV/m)	LIMIT (dBuV/m)	MARGIN (dB)	ANTENNA HEIGHT (m)	TABLE ANGLE (Degree)	RAW VALUE (dBuV)	CORRECTION FACTOR (dB/m)
1	5150.00	52.8 PK	74.0	-21.2	1.20 V	178	52.21	0.59
2	5150.00	41.9 AV	54.0	-12.1	1.20 V	178	41.31	0.59
3	*5230.00	102.9 PK			1.20 V	178	102.04	0.86
4	*5230.00	94.5 AV			1.20 V	178	93.64	0.86
5	5350.00	51.0 PK	74.0	-23.0	1.20 V	178	49.84	1.16
6	5350.00	38.3 AV	54.0	-15.7	1.20 V	178	37.14	1.16
7	#10460.00	62.0 PK	74.0	-12.0	2.41 V	181	51.13	10.87
8	#10460.00	48.2 AV	54.0	-5.8	2.41 V	181	37.33	10.87
9	15690.00	51.9 PK	74.0	-22.1	1.70 V	112	39.80	12.10
10	15690.00	40.2 AV	54.0	-13.8	1.70 V	112	28.10	12.10

REMARKS:

1. Emission Level(dBuV/m) = Raw Value(dBuV) + Correction Factor(dB/m)
2. Correction Factor(dB/m) = Antenna Factor(dB/m) + Cable Factor(dB) – Pre-Amplifier Factor(dB)
3. The other emission levels were very low against the limit.
4. Margin value = Emission Level – Limit value
5. " * ": Fundamental frequency.
6. " # ": The radiated frequency is out of the restricted band.

CHANNEL	TX Channel 151	DETECTOR FUNCTION	Peak (PK)
FREQUENCY RANGE	1GHz ~ 40GHz		Average (AV)

ANTENNA POLARITY & TEST DISTANCE: HORIZONTAL AT 3 M

NO.	FREQ. (MHz)	EMISSION LEVEL (dBuV/m)	LIMIT (dBuV/m)	MARGIN (dB)	ANTENNA HEIGHT (m)	TABLE ANGLE (Degree)	RAW VALUE (dBuV)	CORRECTION FACTOR (dB/m)
1	#5715.00	68.0 PK	68.2	-0.2	2.52 H	66	66.30	1.70
2	#5725.00	74.2 PK	78.2	-4.0	2.52 H	66	72.49	1.71
3	*5755.00	111.0 PK			2.52 H	66	109.24	1.76
4	*5755.00	102.4 AV			2.52 H	66	100.64	1.76
5	11510.00	64.3 PK	74.0	-9.7	2.55 H	105	51.92	12.38
6	11510.00	50.2 AV	54.0	-3.8	2.55 H	105	37.82	12.38
7	#17265.00	51.7 PK	74.0	-22.3	2.46 H	210	34.90	16.80
8	#17265.00	41.2 AV	54.0	-12.8	2.46 H	210	24.40	16.80

ANTENNA POLARITY & TEST DISTANCE: VERTICAL AT 3 M

NO.	FREQ. (MHz)	EMISSION LEVEL (dBuV/m)	LIMIT (dBuV/m)	MARGIN (dB)	ANTENNA HEIGHT (m)	TABLE ANGLE (Degree)	RAW VALUE (dBuV)	CORRECTION FACTOR (dB/m)
1	#5715.00	63.9 PK	68.2	-4.3	1.25 V	186	62.20	1.70
2	#5725.00	69.6 PK	78.2	-8.6	1.25 V	186	67.89	1.71
3	*5755.00	100.1 PK			1.25 V	186	98.34	1.76
4	*5755.00	91.6 AV			1.25 V	186	89.84	1.76
5	11510.00	62.2 PK	74.0	-11.8	2.42 V	181	49.82	12.38
6	11510.00	48.5 AV	54.0	-5.5	2.42 V	181	36.12	12.38
7	#17265.00	51.2 PK	74.0	-22.8	1.68 V	118	34.40	16.80
8	#17265.00	39.8 AV	54.0	-14.2	1.68 V	118	23.00	16.80

REMARKS:

1. Emission Level(dBuV/m) = Raw Value(dBuV) + Correction Factor(dB/m)
2. Correction Factor(dB/m) = Antenna Factor(dB/m) + Cable Factor(dB) – Pre-Amplifier Factor(dB)
3. The other emission levels were very low against the limit.
4. Margin value = Emission Level – Limit value
5. " * ": Fundamental frequency.
6. " # ": The radiated frequency is out of the restricted band.

CHANNEL	TX Channel 159	DETECTOR FUNCTION	Peak (PK)
FREQUENCY RANGE	1GHz ~ 40GHz		Average (AV)

ANTENNA POLARITY & TEST DISTANCE: HORIZONTAL AT 3 M

NO.	FREQ. (MHz)	EMISSION LEVEL (dBuV/m)	LIMIT (dBuV/m)	MARGIN (dB)	ANTENNA HEIGHT (m)	TABLE ANGLE (Degree)	RAW VALUE (dBuV)	CORRECTION FACTOR (dB/m)
1	*5795.00	113.3 PK			2.22 H	64	111.48	1.82
2	*5795.00	104.0 AV			2.22 H	64	102.18	1.82
3	#5850.00	58.4 PK	78.2	-19.8	2.22 H	64	56.58	1.82
4	#5860.00	54.3 PK	74.0	-19.7	2.22 H	64	52.48	1.82
5	#5860.00	44.3 AV	54.0	-9.7	2.22 H	64	42.48	1.82
6	11590.00	63.4 PK	74.0	-10.6	2.30 H	150	51.29	12.11
7	11590.00	53.6 AV	54.0	-0.4	2.30 H	150	41.49	12.11
8	#17385.00	51.5 PK	74.0	-22.5	2.45 H	220	34.04	17.46
9	#17385.00	41.1 AV	54.0	-12.9	2.45 H	220	23.64	17.46

ANTENNA POLARITY & TEST DISTANCE: VERTICAL AT 3 M

NO.	FREQ. (MHz)	EMISSION LEVEL (dBuV/m)	LIMIT (dBuV/m)	MARGIN (dB)	ANTENNA HEIGHT (m)	TABLE ANGLE (Degree)	RAW VALUE (dBuV)	CORRECTION FACTOR (dB/m)
1	*5795.00	102.4 PK			1.24 V	172	100.58	1.82
2	*5795.00	93.2 AV			1.24 V	172	91.38	1.82
3	#5850.00	54.2 PK	78.2	-24.0	1.24 V	172	52.38	1.82
4	#5860.00	51.2 PK	74.0	-22.8	1.24 V	172	49.38	1.82
5	#5860.00	40.7 AV	54.0	-13.3	1.24 V	172	38.88	1.82
6	11590.00	61.8 PK	74.0	-12.2	2.41 V	193	49.69	12.11
7	11590.00	48.1 AV	54.0	-5.9	2.41 V	193	35.99	12.11
8	#17385.00	50.8 PK	74.0	-23.2	1.66 V	118	33.34	17.46
9	#17385.00	39.5 AV	54.0	-14.5	1.66 V	118	22.04	17.46

REMARKS:

1. Emission Level(dBuV/m) = Raw Value(dBuV) + Correction Factor(dB/m)
2. Correction Factor(dB/m) = Antenna Factor(dB/m) + Cable Factor(dB) – Pre-Amplifier Factor(dB)
3. The other emission levels were very low against the limit.
4. Margin value = Emission Level – Limit value
5. " * ": Fundamental frequency.
6. " # ": The radiated frequency is out of the restricted band.

802.11ac (VHT80)

CHANNEL	TX Channel 42	DETECTOR FUNCTION	Peak (PK)
FREQUENCY RANGE	1GHz ~ 40GHz		Average (AV)

ANTENNA POLARITY & TEST DISTANCE: HORIZONTAL AT 3 M

NO.	FREQ. (MHz)	EMISSION LEVEL (dBuV/m)	LIMIT (dBuV/m)	MARGIN (dB)	ANTENNA HEIGHT (m)	TABLE ANGLE (Degree)	RAW VALUE (dBuV)	CORRECTION FACTOR (dB/m)
1	5150.00	65.9 PK	74.0	-8.1	2.41 H	53	65.31	0.59
2	5150.00	53.7 AV	54.0	-0.3	2.41 H	53	53.11	0.59
3	*5210.00	107.4 PK			2.41 H	53	106.61	0.79
4	*5210.00	96.6 AV			2.41 H	53	95.81	0.79
5	5350.00	52.8 PK	74.0	-21.2	2.41 H	53	51.64	1.16
6	5350.00	41.2 AV	54.0	-12.8	2.41 H	53	40.04	1.16
7	#10420.00	64.4 PK	74.0	-9.6	2.52 H	96	53.41	10.99
8	#10420.00	50.1 AV	54.0	-3.9	2.52 H	96	39.11	10.99
9	15630.00	51.4 PK	74.0	-22.6	2.51 H	207	38.87	12.53
10	15630.00	41.2 AV	54.0	-12.8	2.51 H	207	28.67	12.53

ANTENNA POLARITY & TEST DISTANCE: VERTICAL AT 3 M

NO.	FREQ. (MHz)	EMISSION LEVEL (dBuV/m)	LIMIT (dBuV/m)	MARGIN (dB)	ANTENNA HEIGHT (m)	TABLE ANGLE (Degree)	RAW VALUE (dBuV)	CORRECTION FACTOR (dB/m)
1	5150.00	62.8 PK	74.0	-11.2	1.22 V	172	62.21	0.59
2	5150.00	50.4 AV	54.0	-3.6	1.22 V	172	49.81	0.59
3	*5210.00	96.6 PK			1.22 V	172	95.81	0.79
4	*5210.00	85.9 AV			1.22 V	172	85.11	0.79
5	5350.00	52.2 PK	74.0	-21.8	1.22 V	172	51.04	1.16
6	5350.00	38.9 AV	54.0	-15.1	1.22 V	172	37.74	1.16
7	#10420.00	62.9 PK	74.0	-11.1	2.42 V	186	51.91	10.99
8	#10420.00	48.9 AV	54.0	-5.1	2.42 V	186	37.91	10.99
9	15630.00	51.2 PK	74.0	-22.8	1.72 V	129	38.67	12.53
10	15630.00	40.0 AV	54.0	-14.0	1.72 V	129	27.47	12.53

REMARKS:

1. Emission Level(dBuV/m) = Raw Value(dBuV) + Correction Factor(dB/m)
2. Correction Factor(dB/m) = Antenna Factor(dB/m) + Cable Factor(dB) – Pre-Amplifier Factor(dB)
3. The other emission levels were very low against the limit.
4. Margin value = Emission Level – Limit value
5. " * ": Fundamental frequency.
6. " # ": The radiated frequency is out of the restricted band.

CHANNEL	TX Channel 155	DETECTOR FUNCTION	Peak (PK)
FREQUENCY RANGE	1GHz ~ 40GHz		Average (AV)

ANTENNA POLARITY & TEST DISTANCE: HORIZONTAL AT 3 M

NO.	FREQ. (MHz)	EMISSION LEVEL (dBuV/m)	LIMIT (dBuV/m)	MARGIN (dB)	ANTENNA HEIGHT (m)	TABLE ANGLE (Degree)	RAW VALUE (dBuV)	CORRECTION FACTOR (dB/m)
1	#5715.00	68.0 PK	68.2	-0.2	2.38 H	65	66.30	1.70
2	#5725.00	74.7 PK	78.2	-3.5	2.38 H	65	72.99	1.71
3	*5775.00	104.0 PK			2.38 H	65	102.21	1.79
4	*5775.00	95.1 AV			2.38 H	65	93.31	1.79
5	#5850.00	63.8 PK	78.2	-14.4	2.38 H	65	61.98	1.82
6	#5860.00	59.1 PK	74.0	-14.9	2.38 H	65	57.28	1.82
7	#5860.00	45.9 AV	54.0	-8.1	2.38 H	65	44.08	1.82
8	11550.00	64.9 PK	74.0	-9.1	2.49 H	89	52.66	12.24
9	11550.00	50.4 AV	54.0	-3.6	2.49 H	89	38.16	12.24
10	#17325.00	51.2 PK	74.0	-22.8	2.47 H	192	34.15	17.05
11	#17325.00	41.2 AV	54.0	-12.8	2.47 H	192	24.15	17.05

ANTENNA POLARITY & TEST DISTANCE: VERTICAL AT 3 M

NO.	FREQ. (MHz)	EMISSION LEVEL (dBuV/m)	LIMIT (dBuV/m)	MARGIN (dB)	ANTENNA HEIGHT (m)	TABLE ANGLE (Degree)	RAW VALUE (dBuV)	CORRECTION FACTOR (dB/m)
1	#5715.00	63.7 PK	68.2	-4.5	1.22 V	166	62.00	1.70
2	#5725.00	70.2 PK	78.2	-8.0	1.22 V	166	68.49	1.71
3	*5775.00	93.4 PK			1.22 V	166	91.61	1.79
4	*5775.00	84.5 AV			1.22 V	166	82.71	1.79
5	#5850.00	59.5 PK	78.2	-18.7	1.22 V	166	57.68	1.82
6	#5860.00	55.8 PK	74.0	-18.2	1.22 V	166	53.98	1.82
7	#5860.00	42.1 AV	54.0	-11.9	1.22 V	166	40.28	1.82
8	11550.00	62.9 PK	74.0	-11.1	2.38 V	183	50.66	12.24
9	11550.00	49.1 AV	54.0	-4.9	2.38 V	183	36.86	12.24
10	#17325.00	51.3 PK	74.0	-22.7	1.70 V	131	34.25	17.05
11	#17325.00	39.9 AV	54.0	-14.1	1.70 V	131	22.85	17.05

REMARKS:

- Emission Level(dBuV/m) = Raw Value(dBuV) + Correction Factor(dB/m)
- Correction Factor(dB/m) = Antenna Factor(dB/m) + Cable Factor(dB) – Pre-Amplifier Factor(dB)
- The other emission levels were very low against the limit.
- Margin value = Emission Level – Limit value
- " * ": Fundamental frequency.
- " # ": The radiated frequency is out of the restricted band.

Below 1GHz Data

802.11a

CHANNEL	TX Channel 48	DETECTOR FUNCTION	Quasi-Peak (QP)
FREQUENCY RANGE	Below 1GHz		

ANTENNA POLARITY & TEST DISTANCE: HORIZONTAL AT 3 M

NO.	FREQ. (MHz)	EMISSION LEVEL (dBuV/m)	LIMIT (dBuV/m)	MARGIN (dB)	ANTENNA HEIGHT (m)	TABLE ANGLE (Degree)	RAW VALUE (dBuV)	CORRECTION FACTOR (dB/m)
1	104.82	25.6 QP	43.5	-17.9	1.90 H	100	37.84	-12.24
2	224.90	34.4 QP	46.0	-11.6	1.26 H	220	46.42	-11.98
3	275.00	42.9 QP	46.0	-3.1	1.20 H	70	51.43	-8.53
4	300.19	29.7 QP	46.0	-16.3	1.00 H	108	37.58	-7.88
5	400.11	26.2 QP	46.0	-19.8	1.20 H	291	31.66	-5.46
6	680.19	34.1 QP	46.0	-11.9	1.00 H	101	33.72	0.40

ANTENNA POLARITY & TEST DISTANCE: VERTICAL AT 3 M

NO.	FREQ. (MHz)	EMISSION LEVEL (dBuV/m)	LIMIT (dBuV/m)	MARGIN (dB)	ANTENNA HEIGHT (m)	TABLE ANGLE (Degree)	RAW VALUE (dBuV)	CORRECTION FACTOR (dB/m)
1	43.88	33.5 QP	40.0	-6.5	1.10 V	106	42.27	-8.77
2	64.77	28.9 QP	40.0	-11.1	1.10 V	191	38.68	-9.78
3	129.90	22.8 QP	43.5	-20.7	1.40 V	340	32.69	-9.89
4	225.11	25.4 QP	46.0	-20.6	1.10 V	270	37.37	-11.95
5	275.11	36.4 QP	46.0	-9.6	1.20 V	150	44.89	-8.51
6	680.19	34.9 QP	46.0	-11.1	1.20 V	320	34.50	0.40

REMARKS:

1. Emission Level(dBuV/m) = Raw Value(dBuV) + Correction Factor(dB/m)
2. Correction Factor(dB/m) = Antenna Factor(dB/m) + Cable Factor(dB) – Pre-Amplifier Factor(dB)
3. The other emission levels were very low against the limit.
4. Margin value = Emission Level – Limit value

4.2 Conducted Emission Measurement

4.2.1 Limits of Conducted Emission Measurement

Frequency (MHz)	Conducted Limit (dBuV)	
	Quasi-peak	Average
0.15 - 0.5	66 - 56	56 - 46
0.50 - 5.0	56	46
5.0 - 30.0	60	50

Note: 1. The lower limit shall apply at the transition frequencies.

2. The limit decreases in line with the logarithm of the frequency in the range of 0.15 to 0.50MHz.

4.2.2 Test Instruments

DESCRIPTION & MANUFACTURER	MODEL NO.	SERIAL NO.	CALIBRATED DATE	CALIBRATED UNTIL
Test Receiver R&S	ESCS 30	100375	May 06, 2015	May 05, 2016
Line-Impedance Stabilization Network (for EUT) SCHWARZBECK	NSLK-8127	8127-522	Sep. 01, 2015	Aug. 31, 2016
Line-Impedance Stabilization Network (for Peripheral) R&S	ENV216	100072	June 11, 2015	June 10, 2016
RF Cable	5D-FB	COCCAB-001	Mar. 08, 2016	Mar. 07, 2017
50 ohms Terminator	N/A	EMC-03	Sep. 23, 2015	Sep. 22, 2016
50 ohms Terminator	N/A	EMC-02	Oct. 01, 2015	Sep. 30, 2016
50 ohms Terminator	E1-011315	13	Dec. 11, 2015	Dec. 10, 2016
Software BVADT	BVADT_Cond_ V7.3.7.3	NA	NA	NA

Note:

1. The calibration interval of the above test instruments are 12 months and the calibrations are traceable to NML/ROC and NIST/USA.
2. The test was performed in Shielded Room No. C.
3. The VCCI Con C Registration No. is C-3611.
4. Tested Date: Mar. 30 to 31, 2016

4.2.3 Test Procedure

- a. The EUT was placed 0.4 meters from the conducting wall of the shielded room with EUT being connected to the power mains through a line impedance stabilization network (LISN). Other support units were connected to the power mains through another LISN. The two LISNs provide 50 ohm/ 50uH of coupling impedance for the measuring instrument.
- b. Both lines of the power mains connected to the EUT were checked for maximum conducted interference.
- c. The frequency range from 150kHz to 30MHz was searched. Emission levels under (Limit - 20dB) was not recorded.

NOTE: All modes of operation were investigated and the worst-case emissions are reported.

4.2.4 Deviation from Test Standard

No deviation.

4.2.5 Test Setup

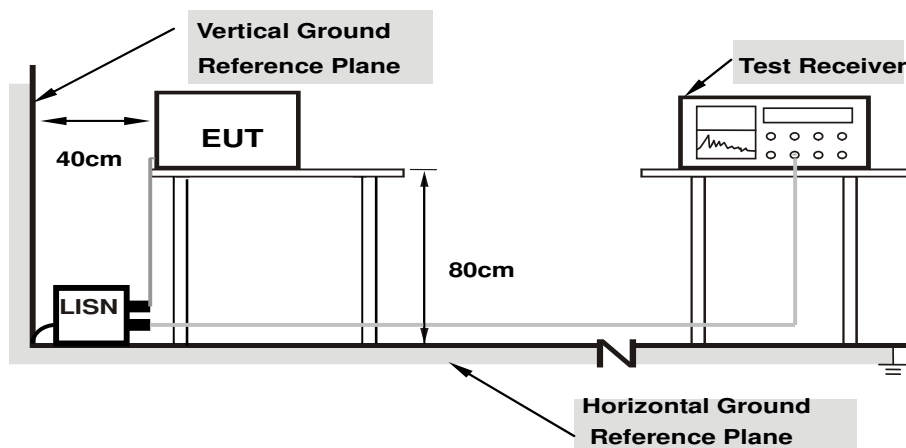

- Note:**
- 1.Support units were connected to second LISN.
 - 2.Both of LISNs (AMN) are 80 cm from EUT and at least 80 from other units and other metal planes

For the actual test configuration, please refer to the attached file (Test Setup Photo).

4.2.6 EUT Operating Condition

Same as 4.1.6.

4.2.7 Test Results (Mode 1)

Phase	Line (L)	Detector Function	Quasi-Peak (QP) / Average (AV)
-------	----------	-------------------	--------------------------------

Phase Of Power : Line (L)										
No	Frequency (MHz)	Correction Factor (dB)	Reading Value (dBuV)		Emission Level (dBuV)		Limit (dBuV)		Margin (dB)	
			Q.P.	AV.	Q.P.	AV.	Q.P.	AV.	Q.P.	AV.
1	0.19297	10.41	29.71	17.41	40.12	27.82	63.91	53.91	-23.79	-26.09
2	0.23594	10.41	25.22	14.87	35.63	25.28	62.24	52.24	-26.61	-26.96
3	0.36094	10.42	27.70	20.81	38.12	31.23	58.71	48.71	-20.58	-17.47
4	0.45469	10.43	16.44	6.63	26.87	17.06	56.79	46.79	-29.92	-29.73
5	0.67734	10.41	14.05	8.47	24.46	18.88	56.00	46.00	-31.54	-27.12
6	5.55078	10.70	23.24	15.71	33.94	26.41	60.00	50.00	-26.06	-23.59

Remarks:

1. Q.P. and AV. are abbreviations of quasi-peak and average individually.
2. The emission levels of other frequencies were very low against the limit.
3. Margin value = Emission level – Limit value
4. Correction factor = Insertion loss + Cable loss
5. Emission Level = Correction Factor + Reading Value

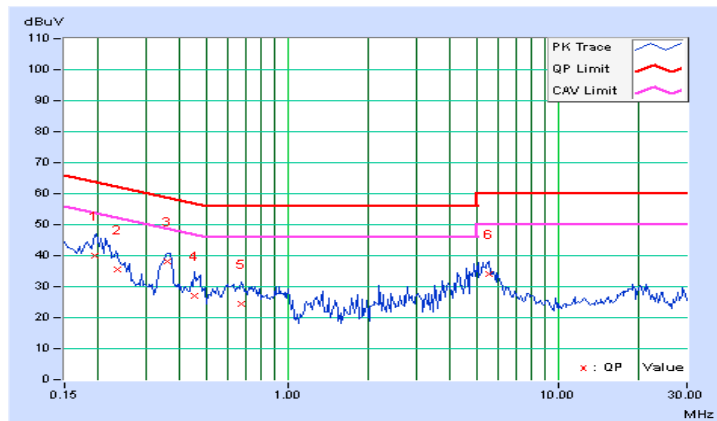

Phase	Neutral (N)	Detector Function	Quasi-Peak (QP) / Average (AV)
-------	-------------	-------------------	--------------------------------

Phase Of Power : Neutral (N)										
No	Frequency (MHz)	Correction Factor (dB)	Reading Value (dBuV)		Emission Level (dBuV)		Limit (dBuV)		Margin (dB)	
			Q.P.	AV.	Q.P.	AV.	Q.P.	AV.	Q.P.	AV.
1	0.17734	10.45	28.09	16.06	38.54	26.51	64.61	54.61	-26.07	-28.10
2	0.19687	10.45	29.28	15.65	39.73	26.10	63.74	53.74	-24.01	-27.64
3	0.23594	10.46	24.07	12.85	34.53	23.31	62.24	52.24	-27.71	-28.93
4	0.34531	10.47	27.34	19.09	37.81	29.56	59.07	49.07	-21.26	-19.51
5	0.46641	10.47	17.61	8.84	28.08	19.31	56.58	46.58	-28.49	-27.26
6	5.19531	10.77	19.44	11.63	30.21	22.40	60.00	50.00	-29.79	-27.60

Remarks:

1. Q.P. and AV. are abbreviations of quasi-peak and average individually.
2. The emission levels of other frequencies were very low against the limit.
3. Margin value = Emission level – Limit value
4. Correction factor = Insertion loss + Cable loss
5. Emission Level = Correction Factor + Reading Value

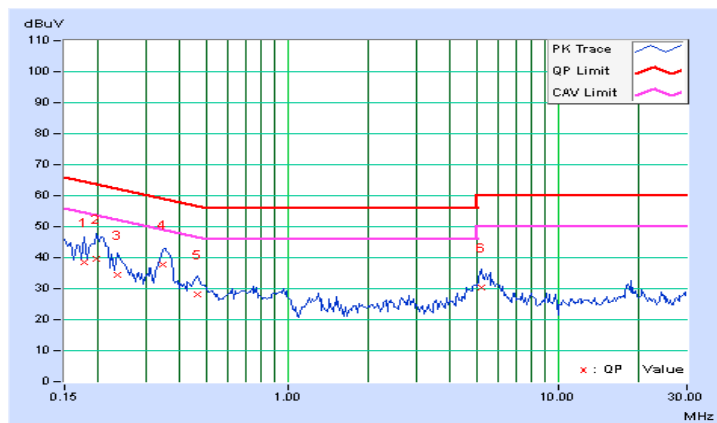

4.2.8 Test Results (Mode 2)

Phase	Line (L)	Detector Function	Quasi-Peak (QP) / Average (AV)
-------	----------	-------------------	--------------------------------

Phase Of Power : Line (L)										
No	Frequency (MHz)	Correction Factor (dB)	Reading Value (dBuV)		Emission Level (dBuV)		Limit (dBuV)		Margin (dB)	
			Q.P.	AV.	Q.P.	AV.	Q.P.	AV.	Q.P.	AV.
1	0.18516	10.41	28.51	17.33	38.92	27.74	64.25	54.25	-25.33	-26.51
2	0.20469	10.40	29.47	15.80	39.87	26.20	63.42	53.42	-23.55	-27.22
3	0.23984	10.41	26.01	16.54	36.42	26.95	62.10	52.10	-25.69	-25.16
4	0.35703	10.42	28.91	23.04	39.33	33.46	58.80	48.80	-19.46	-15.33
5	0.47031	10.42	17.43	8.21	27.85	18.63	56.51	46.51	-28.65	-27.87
6	5.48047	10.70	23.85	16.58	34.55	27.28	60.00	50.00	-25.45	-22.72

Remarks:

1. Q.P. and AV. are abbreviations of quasi-peak and average individually.
2. The emission levels of other frequencies were very low against the limit.
3. Margin value = Emission level – Limit value
4. Correction factor = Insertion loss + Cable loss
5. Emission Level = Correction Factor + Reading Value

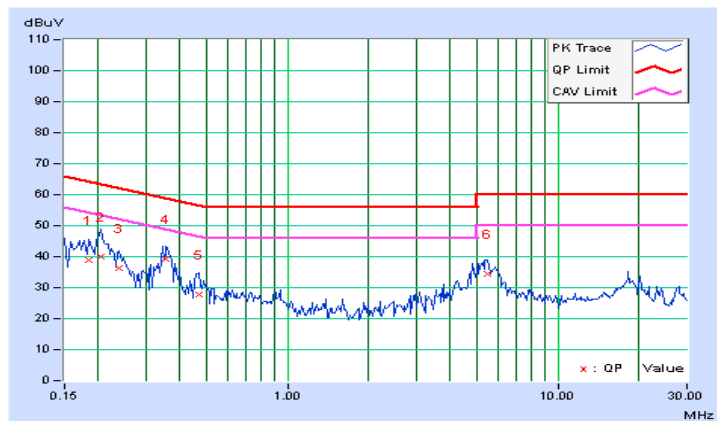

Phase	Neutral (N)	Detector Function	Quasi-Peak (QP) / Average (AV)
-------	-------------	-------------------	--------------------------------

Phase Of Power : Neutral (N)										
No	Frequency (MHz)	Correction Factor (dB)	Reading Value (dBuV)		Emission Level (dBuV)		Limit (dBuV)		Margin (dB)	
			Q.P.	AV.	Q.P.	AV.	Q.P.	AV.	Q.P.	AV.
1	0.17734	10.45	28.57	16.74	39.02	27.19	64.61	54.61	-25.59	-27.42
2	0.20078	10.45	29.27	14.79	39.72	25.24	63.58	53.58	-23.86	-28.34
3	0.21250	10.45	28.23	15.73	38.68	26.18	63.11	53.11	-24.43	-26.93
4	0.36094	10.47	24.11	18.92	34.58	29.39	58.71	48.71	-24.12	-19.31
5	5.59375	10.79	18.83	10.26	29.62	21.05	60.00	50.00	-30.38	-28.95
6	19.41797	11.46	9.75	0.97	21.21	12.43	60.00	50.00	-38.79	-37.57

Remarks:

1. Q.P. and AV. are abbreviations of quasi-peak and average individually.
2. The emission levels of other frequencies were very low against the limit.
3. Margin value = Emission level – Limit value
4. Correction factor = Insertion loss + Cable loss
5. Emission Level = Correction Factor + Reading Value

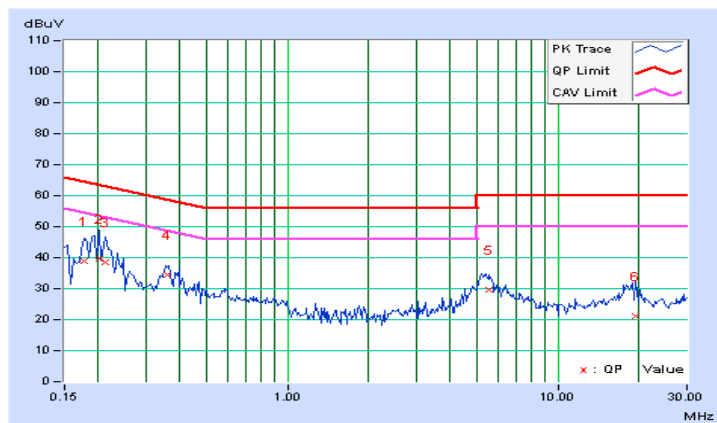

4.2.9 Test Results (Mode 3)

Phase	Line (L)	Detector Function	Quasi-Peak (QP) / Average (AV)
-------	----------	-------------------	--------------------------------

Phase Of Power : Line (L)										
No	Frequency (MHz)	Correction Factor (dB)	Reading Value (dBuV)		Emission Level (dBuV)		Limit (dBuV)		Margin (dB)	
			Q.P.	AV.	Q.P.	AV.	Q.P.	AV.	Q.P.	AV.
1	0.15000	10.32	35.34	26.64	45.66	36.96	66.00	56.00	-20.34	-19.04
2	0.18125	10.30	29.19	19.74	39.49	30.04	64.43	54.43	-24.94	-24.39
3	0.22031	10.28	25.11	15.63	35.39	25.91	62.81	52.81	-27.42	-26.90
4	0.52003	10.29	28.08	25.19	38.37	35.48	56.00	46.00	-17.63	-10.52
5	13.33984	10.71	32.17	31.17	42.88	41.88	60.00	50.00	-17.12	-8.12
6	25.91406	11.05	28.89	23.46	39.94	34.51	60.00	50.00	-20.06	-15.49

Remarks:

1. Q.P. and AV. are abbreviations of quasi-peak and average individually.
2. The emission levels of other frequencies were very low against the limit.
3. Margin value = Emission level – Limit value
4. Correction factor = Insertion loss + Cable loss
5. Emission Level = Correction Factor + Reading Value

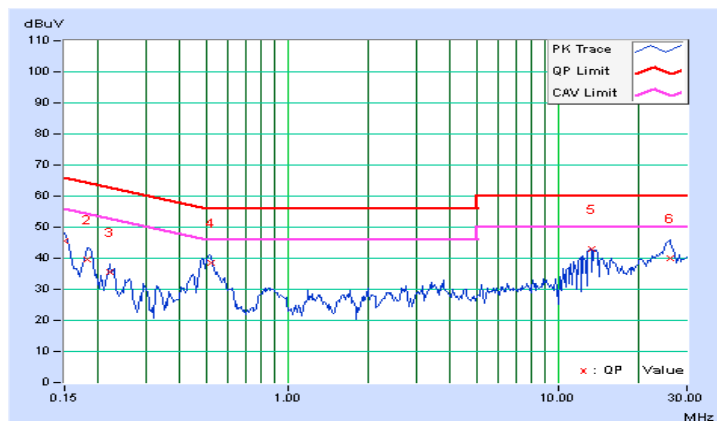

Phase	Neutral (N)	Detector Function	Quasi-Peak (QP) / Average (AV)
-------	-------------	-------------------	--------------------------------

Phase Of Power : Neutral (N)										
No	Frequency (MHz)	Correction Factor (dB)	Reading Value (dBuV)		Emission Level (dBuV)		Limit (dBuV)		Margin (dB)	
			Q.P.	AV.	Q.P.	AV.	Q.P.	AV.	Q.P.	AV.
1	0.15000	10.30	35.72	27.47	46.02	37.77	66.00	56.00	-19.98	-18.23
2	0.18516	10.27	31.33	23.86	41.60	34.13	64.25	54.25	-22.65	-20.12
3	0.52109	10.27	28.87	24.46	39.14	34.73	56.00	46.00	-16.86	-11.27
4	3.67969	10.41	18.57	11.61	28.98	22.02	56.00	46.00	-27.02	-23.98
5	13.33794	10.72	31.25	31.19	41.97	41.91	60.00	50.00	-18.03	-8.09
6	25.41797	11.04	29.78	24.30	40.82	35.34	60.00	50.00	-19.18	-14.66

Remarks:

1. Q.P. and AV. are abbreviations of quasi-peak and average individually.
2. The emission levels of other frequencies were very low against the limit.
3. Margin value = Emission level – Limit value
4. Correction factor = Insertion loss + Cable loss
5. Emission Level = Correction Factor + Reading Value

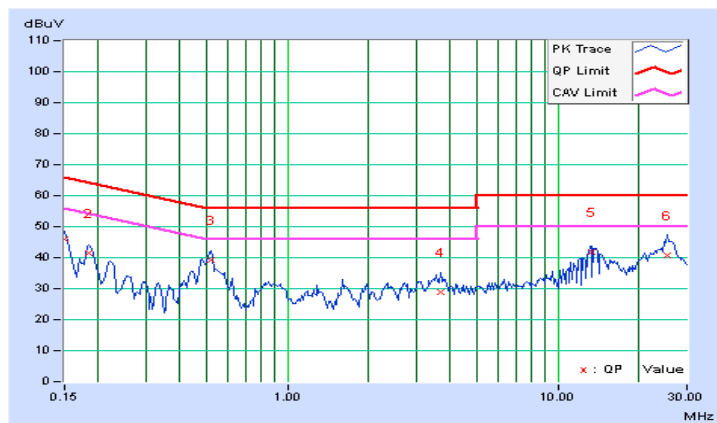

4.3 Transmit Power Measurement

4.3.1 Limits of Transmit Power Measurement

Operation Band	EUT Category		LIMIT
U-NII-1		Outdoor Access Point	1 Watt (30 dBm) (Max. e.i.r.p \leq 125mW(21 dBm) at any elevation angle above 30 degrees as measured from the horizon)
		Fixed point-to-point Access Point	1 Watt (30 dBm)
	√	Indoor Access Point	1 Watt (30 dBm)
		Mobile and Portable client device	250mW (24 dBm)
U-NII-2A			250mW (24 dBm) or 11 dBm+10 log B*
U-NII-2C			250mW (24 dBm) or 11 dBm+10 log B*
U-NII-3		√	1 Watt (30 dBm)

*B is the 26 dB emission bandwidth in megahertz

Per KDB 662911 Method of conducted output power measurement on IEEE 802.11 devices,

Array Gain = 0 dB (i.e., no array gain) for $N_{ANT} \leq 4$;

Array Gain = 0 dB (i.e., no array gain) for channel widths ≥ 40 MHz for any N_{ANT} ;

Array Gain = $5 \log(N_{ANT}/N_{SS})$ dB or 3 dB, whichever is less for 20-MHz channel widths with $N_{ANT} \geq 5$.

For power measurements on all other devices: Array Gain = $10 \log(N_{ANT}/N_{SS})$ dB.

4.3.2 Test Setup

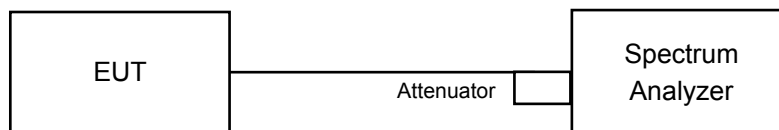

4.3.3 Test Instruments

Refer to section 4.1.2 to get information of above instrument.

4.3.4 Test Procedure

Method PM is used to perform output power measurement, trigger and gating function of wide band power meter is enabled to measure max output power of TX on burst. Duty factor is not added to measured value.

4.3.5 Deviation from Test Standard

No deviation.

4.3.6 EUT Operating Condition

The software provided by client to enable the EUT under transmission condition continuously at lowest, middle and highest channel frequencies individually.

4.3.7 Test Result

802.11a

Chan.	Chan. Freq. (MHz)	Average Power (dBm)		Total Power (mW)	Total Power (dBm)	Limit (dBm)	Pass / Fail
		Chain 0	Chain 1				
36	5180	20.93	20.31	231.279	23.64	28.65	Pass
40	5200	20.87	20.27	228.594	23.59	28.65	Pass
48	5240	21.00	20.57	239.918	23.80	28.65	Pass
149	5745	17.88	17.53	118	20.72	28.65	Pass
157	5785	17.77	17.69	118.59	20.74	28.65	Pass
165	5825	17.56	17.20	109.497	20.39	28.65	Pass

Note: 1. The directional gain is 7.35dBi > 6dBi, therefore the limit needs to reduce, so the power limit shall be reduced to $30-(7.35-6) = 28.65\text{dBm}$.

802.11ac (VHT20)

Chan.	Chan. Freq. (MHz)	Average Power (dBm)		Total Power (mW)	Total Power (dBm)	Limit (dBm)	Pass / Fail
		Chain 0	Chain 1				
36	5180	20.55	20.02	213.963	23.30	28.65	Pass
40	5200	20.70	20.05	218.648	23.40	28.65	Pass
48	5240	20.56	20.36	222.406	23.47	28.65	Pass
149	5745	17.85	17.46	116.673	20.67	28.65	Pass
157	5785	18.24	17.86	127.775	21.06	28.65	Pass
165	5825	17.56	17.28	110.472	20.43	28.65	Pass

Note: 1. The directional gain is 7.35dBi > 6dBi, therefore the limit needs to reduce, so the power limit shall be reduced to $30-(7.35-6) = 28.65\text{dBm}$.

802.11ac (VHT40)

Chan.	Chan. Freq. (MHz)	Average Power (dBm)		Total Power (mW)	Total Power (dBm)	Limit (dBm)	Pass / Fail
		Chain 0	Chain 1				
38	5190	18.00	17.78	123.075	20.90	28.65	Pass
46	5230	20.56	20.33	221.658	23.46	28.65	Pass
151	5755	16.55	16.21	86.969	19.39	28.65	Pass
159	5795	18.42	18.35	137.893	21.40	28.65	Pass

Note: 1. The directional gain is 7.35dBi > 6dBi, therefore the limit needs to reduce, so the power limit shall be reduced to $30-(7.35-6) = 28.65\text{dBm}$.

802.11ac (VHT80)

Chan.	Chan. Freq. (MHz)	Average Power (dBm)		Total Power (mW)	Total Power (dBm)	Limit (dBm)	Pass / Fail
		Chain 0	Chain 1				
42	5210	15.68	15.22	70.249	18.47	28.65	Pass
155	5775	14.10	13.90	50.251	17.01	28.65	Pass

Note: 1. The directional gain is 7.35dBi > 6dBi, therefore the limit needs to reduce, so the power limit shall be reduced to $30-(7.35-6) = 28.65\text{dBm}$.

4.4 Peak Power Spectral Density Measurement

4.4.1 Limits of Peak Power Spectral Density Measurement

Operation Band	EUT Category		LIMIT
U-NII-1		Outdoor Access Point	17dBm/ MHz
		Fixed point-to-point Access Point	
	√	Indoor Access Point	
		Mobile and Portable client device	11dBm/ MHz
U-NII-2A	---		11dBm/ MHz
U-NII-2C	---		11dBm/ MHz
U-NII-3	√		30dBm/ 500kHz

4.4.2 Test Setup

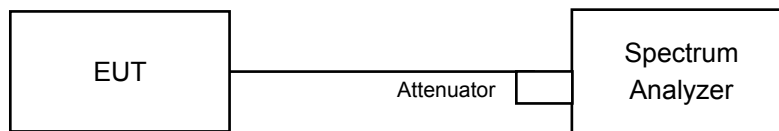

4.4.3 Test Instruments

Refer to section 4.1.2 to get information of above instrument.

4.4.4 Test Procedure

For U-NII-1 band - 802.11a, 802.11ac (VHT20):

Using method SA-1

1. Set span to encompass the entire emission bandwidth (EBW) of the signal.
2. Set RBW = 1 MHz, Set VBW \geq 3 MHz, Detector = RMS
3. Set Channel power measure = 1MHz
4. Sweep time = auto, trigger set to "free run".
5. Trace average at least 100 traces in power averaging mode.
6. Record the max value

For U-NII-1 band - 802.11ac(VHT40) and 802.11ac(VHT80):

Using method SA-2

1. Set span to encompass the entire emission bandwidth (EBW) of the signal.
2. Set RBW = 30 kHz, Set VBW \geq 1 MHz, Detector = RMS
3. Set Channel power measure = 1MHz
4. Sweep time = auto, trigger set to "free run".
5. Trace average at least 100 traces in power averaging mode.
6. Record the max value and add 10 log (1/duty cycle)

For U-NII-3 band - 802.11a, 802.11ac (VHT20):

1. Set span to encompass the entire emission bandwidth (EBW) of the signal.
2. Set RBW = 300 kHz, Set VBW \geq 1 MHz, Detector = RMS
3. Use the peak marker function to determine the maximum power level in any 300 kHz band segment within the fundamental EBW.
4. Scale the observed power level to an equivalent value in 500 kHz by adjusting (reducing) the measured power by a bandwidth correction factor (BWCF) where $BWCF = 10\log(500 \text{ kHz}/300\text{kHz})$
5. Sweep time = auto, trigger set to "free run".
6. Trace average at least 100 traces in power averaging mode.
7. Record the max value

For U-NII-3 band - 802.11ac(VHT40) and 802.11ac(VHT80):

1. Set span to encompass the entire emission bandwidth (EBW) of the signal.
2. Set RBW = 300 kHz, Set VBW \geq 1 MHz, Detector = RMS
3. Use the peak marker function to determine the maximum power level in any 300 kHz band segment within the fundamental EBW.
4. Scale the observed power level to an equivalent value in 500 kHz by adjusting (reducing) the measured power by a bandwidth correction factor (BWCF) where $BWCF = 10\log(500 \text{ kHz}/300\text{kHz})$
5. Sweep time = auto, trigger set to "free run".
6. Trace average at least 100 traces in power averaging mode.
7. Record the max value and add 10 log (1/duty cycle)

4.4.5 Deviation from Test Standard

No deviation.

4.4.6 EUT Operating Condition

Same as Item 4.3.6.

4.4.7 Test Results

For U-NII-1 Band

802.11a

Chan.	Chan. Freq. (MHz)	PSD (dBm/MHz)		Total Power Density (dBm/MHz)	MAX. Limit (dBm/MHz)	Pass / Fail
		Chain 0	Chain 1			
36	5180	6.08	5.91	9.01	12.66	Pass
40	5200	6.44	6.47	9.47	12.66	Pass
48	5240	7.22	7.22	10.23	12.66	Pass

- Note:** 1. Method a) of power density measurement of KDB 662911 is using for calculating total power density. Total power density is summing entire spectra across corresponding frequency bins on the various outputs by computer.
2. Directional gain = $10 \log[(10^{G1/20} + 10^{G2/20})^2 / 2] = 10.34\text{dBi} > 6\text{dBi}$, so the power density limit shall be reduced to $17-(10.34-6) = 12.66\text{Bm}$.

802.11ac (VHT20)

Chan.	Chan. Freq. (MHz)	PSD (dBm/MHz)		Total Power Density (dBm/MHz)	MAX. Limit (dBm/MHz)	Pass / Fail
		Chain 0	Chain 1			
36	5180	5.70	5.72	8.72	12.66	Pass
40	5200	6.24	6.28	9.27	12.66	Pass
48	5240	6.67	6.72	9.71	12.66	Pass

- Note:** 1. Method a) of power density measurement of KDB 662911 is using for calculating total power density. Total power density is summing entire spectra across corresponding frequency bins on the various outputs by computer.
2. Directional gain = $10 \log[(10^{G1/20} + 10^{G2/20})^2 / 2] = 10.34\text{dBi} > 6\text{dBi}$, so the power density limit shall be reduced to $17-(10.34-6) = 12.66\text{Bm}$.

802.11ac (VHT40)

Chan.	Chan. Freq. (MHz)	PSD W/O Duty Factor (dBm)		Duty Factor (dB)	Total PSD With Duty Factor (dBm)	MAX. Limit (dBm)	Pass / Fail
		Chain 0	Chain 1				
38	5190	0.29	0.37	0.15	3.49	12.66	Pass
46	5230	2.60	3.30	0.15	6.12	12.66	Pass

- Note:**
- Method a) of power density measurement of KDB 662911 is using for calculating total power density. Total power density is summing entire spectra across corresponding frequency bins on the various outputs by computer.
 - Directional gain = $10 \log[(10^{G1/20} + 10^{G2/20})^2 / 2] = 10.34\text{dBi} > 6\text{dBi}$, so the power density limit shall be reduced to $17-(10.34-6) = 12.66\text{Bm}$.
 - Refer to section 3.3 for duty cycle spectrum plot.

802.11ac (VHT80)

Chan.	Chan. Freq. (MHz)	PSD W/O Duty Factor (dBm)		Duty Factor (dB)	Total PSD With Duty Factor (dBm)	MAX. Limit (dBm)	Pass / Fail
		Chain 0	Chain 1				
42	5210	-5.41	-5.36	0.57	-1.80	12.66	Pass

- Note:**
- Method a) of power density measurement of KDB 662911 is using for calculating total power density. Total power density is summing entire spectra across corresponding frequency bins on the various outputs by computer.
 - Directional gain = $10 \log[(10^{G1/20} + 10^{G2/20})^2 / 2] = 10.34\text{dBi} > 6\text{dBi}$, so the power density limit shall be reduced to $17-(10.34-6) = 12.66\text{Bm}$.
 - Refer to section 3.3 for duty cycle spectrum plot.

Spectrum Plot of Worst Value

802.11a / Chain 0 : CH48

802.11ac(VHT20) / Chain 1 : CH48

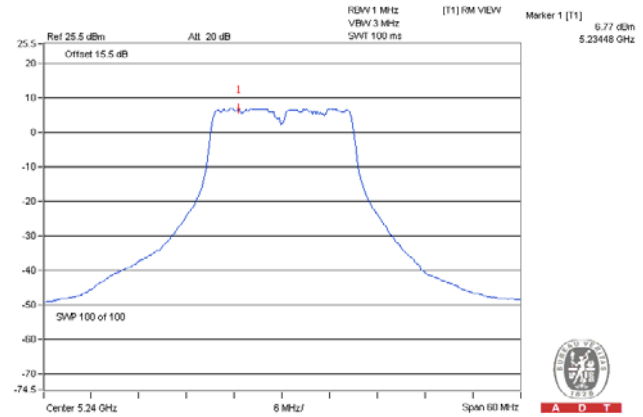
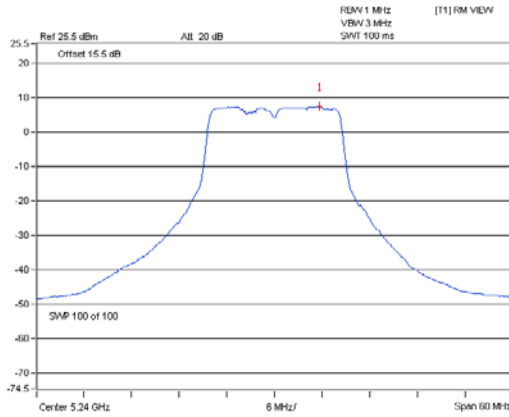

802.11ac(VHT40) / Chain 1 : CH46

802.11ac(VHT40) / Chain 1 : CH42

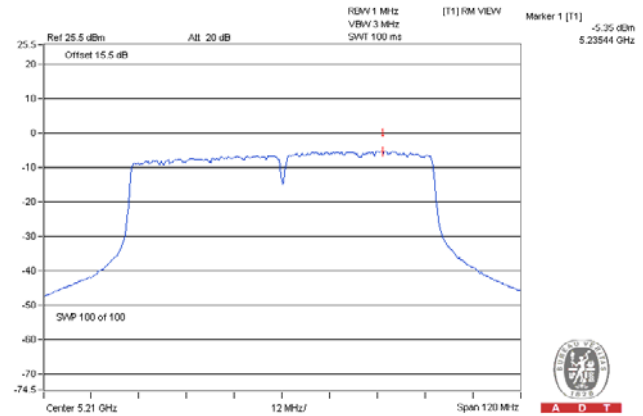
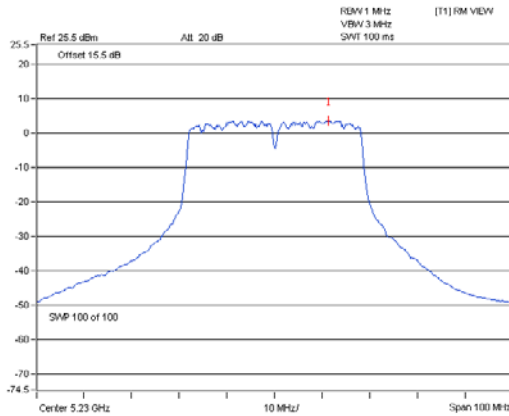

**For U-NII-3 Band
802.11a**

TX chain	Channel	Freq. (MHz)	PSD (dBm/300kHz)	PSD (dBm/500kHz)	10 log (N=2) dB	Total PSD (dBm/500kHz)	Limit (dBm/500kHz)	Pass /Fail
0	149	5745	-2.81	-0.59	3.01	2.42	25.66	Pass
	157	5785	-3.15	-0.93	3.01	2.08	25.66	Pass
	165	5825	-2.53	-0.31	3.01	2.70	25.66	Pass
1	149	5745	-3.83	-1.61	3.01	1.40	25.66	Pass
	157	5785	-3.88	-1.66	3.01	1.35	25.66	Pass
	165	5825	-4.50	-2.28	3.01	0.73	25.66	Pass

Note: 1. Directional gain = $10 \log[(10^{G1/20} + 10^{G2/20})^2 / 2] = 10.34\text{dBi} > 6\text{dBi}$, so the power density limit shall be reduced to $30-(10.34-6) = 25.66\text{Bm}$.

802.11ac (VHT20)

TX chain	Channel	Freq. (MHz)	PSD (dBm/300kHz)	PSD (dBm/500kHz)	10 log (N=2) dB	Total PSD (dBm/500kHz)	Limit (dBm/500kHz)	Pass /Fail
0	149	5745	-3.07	-0.85	3.01	2.16	25.66	Pass
	157	5785	-3.27	-1.05	3.01	1.96	25.66	Pass
	165	5825	-2.95	-0.73	3.01	2.28	25.66	Pass
1	149	5745	-4.07	-1.85	3.01	1.16	25.66	Pass
	157	5785	-4.30	-2.08	3.01	0.93	25.66	Pass
	165	5825	-4.98	-2.76	3.01	0.25	25.66	Pass

Note: 1. Directional gain = $10 \log[(10^{G1/20} + 10^{G2/20})^2 / 2] = 10.34\text{dBi} > 6\text{dBi}$, so the power density limit shall be reduced to $30-(10.34-6) = 25.66\text{Bm}$.

802.11ac (VHT40)

TX chain	Chan.	Chan. Freq. (MHz)	PSD W/O Duty Factor		10 log (N=2) dB	Duty Factor (dB)	Total PSD With Duty Factor (dBm/500kHz)	Limit (dBm/500kHz)	Pass /Fail
			(dBm/300kHz)	(dBm/500kHz)					
0	151	5755	-7.69	-5.47	3.01	0.15	-2.31	25.66	Pass
	159	5795	-5.86	-3.64	3.01	0.15	-0.48	25.66	Pass
1	151	5755	-8.95	-6.73	3.01	0.15	-3.57	25.66	Pass
	159	5795	-6.91	-4.69	3.01	0.15	-1.53	25.66	Pass

Note: 1. Directional gain = $10 \log[(10^{G1/20} + 10^{G2/20})^2 / 2] = 10.34\text{dBi} > 6\text{dBi}$, so the power density limit shall be reduced to $30-(10.34-6) = 25.66\text{Bm}$.

2. Refer to section 3.3 for duty cycle spectrum plot.

802.11ac (VHT80)

TX chain	Chan.	Chan. Freq. (MHz)	PSD W/O Duty Factor		10 log (N=2) dB	Duty Factor (dB)	Total PSD With Duty Factor (dBm/500kHz)	Limit (dBm/500kHz)	Pass /Fail
			(dBm/300kHz)	(dBm/500kHz)					
0	155	5775	-14.83	-12.61	3.01	0.57	-9.03	25.66	Pass
1	155	5775	-15.38	-13.16	3.01	0.57	-9.58	25.66	Pass

Note: 1. Directional gain = $10 \log[(10^{G1/20} + 10^{G2/20})^2 / 2] = 10.34\text{dBi} > 6\text{dBi}$, so the power density limit shall be reduced to $30-(10.34-6) = 25.66\text{Bm}$.

2. Refer to section 3.3 for duty cycle spectrum plot.

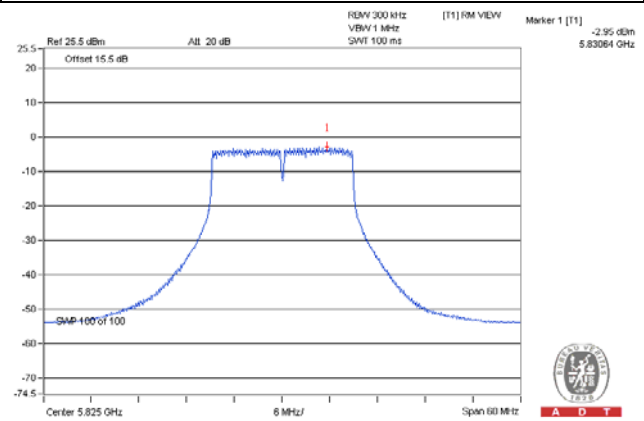
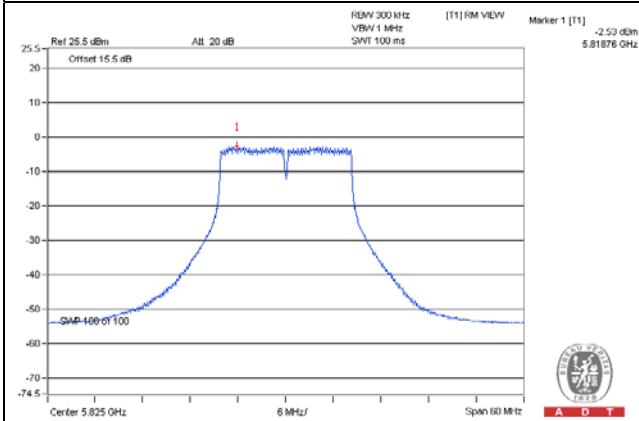
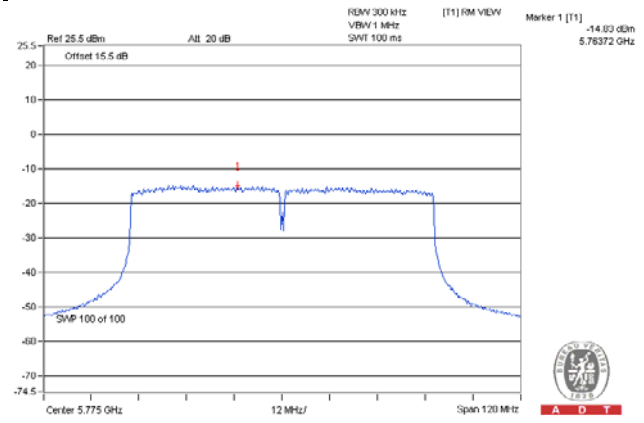
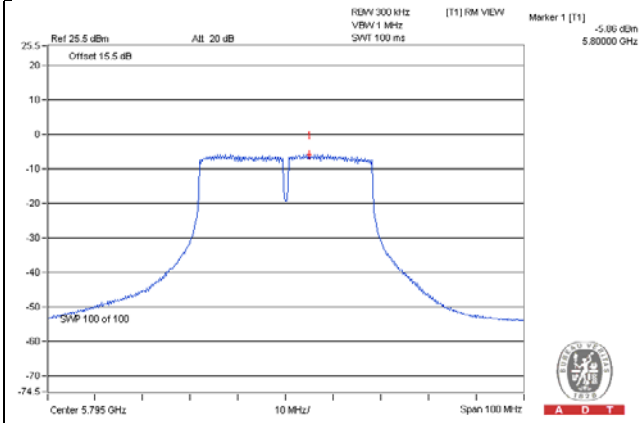
Spectrum Plot of Worst Value
802.11a / Chain 0 : CH165
802.11ac(VHT20) / Chain 0 : CH165

802.11ac(VHT40) / Chain 0 : CH159
802.11ac(VHT40) / Chain 0 : CH155

4.5 Frequency Stability Measurement

4.5.1 Limits of Frequency Stability Measurement

The frequency of the carrier signal shall be maintained within band of operation

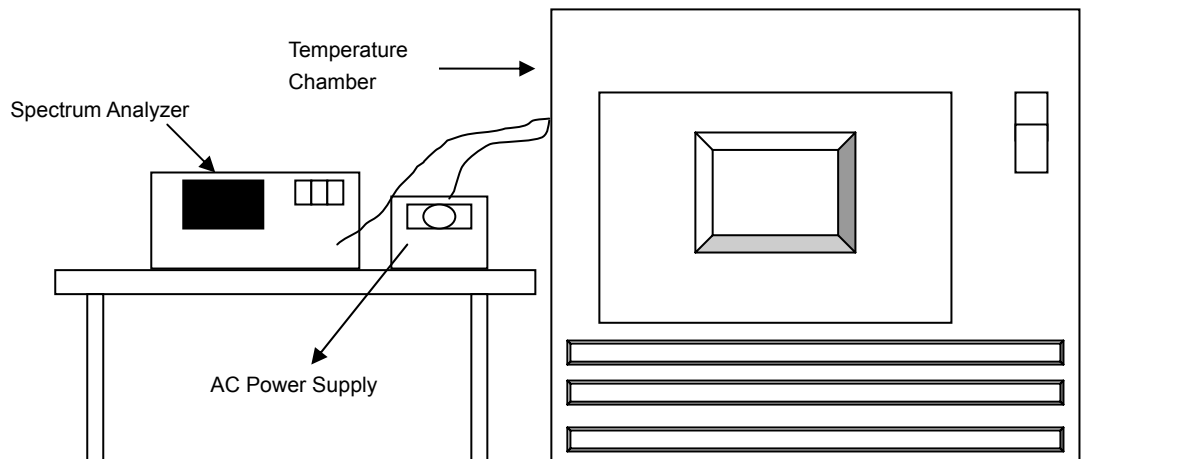
4.5.2 Test Setup



4.5.3 Test Instruments

Refer to section 4.1.2 to get information of above instrument.

4.5.4 Test Procedure

- The EUT was placed inside the environmental test chamber and powered by nominal AC voltage.
- Turn the EUT on and couple its output to a spectrum analyzer.
- Turn the EUT off and set the chamber to the highest temperature specified.
- Allow sufficient time (approximately 30 min) for the temperature of the chamber to stabilize, turn the EUT on and measure the operating frequency after 2, 5, and 10 minutes.
- Repeat step 2 and 3 with the temperature chamber set to the lowest temperature.
- The test chamber was allowed to stabilize at +20 degree C for a minimum of 30 minutes. The supply voltage was then adjusted on the EUT from 85% to 115% and the frequency record.

4.5.5 Deviation from Test Standard

No deviation.

4.5.6 EUT Operating Condition

Set the EUT transmit at un-modulation mode to test frequency stability.

4.5.7 Test Results

FREQUENCY STABILITY VERSUS TEMP.									
OPERATING FREQUENCY: 5180MHz									
TEMP. (°C)	POWER SUPPLY (Vac)	0 MINUTE		2 MINUTE		5 MINUTE		10 MINUTE	
		Measured Frequency (MHz)	Frequency Drift (%)	Measured Frequency (MHz)	Frequency Drift (%)	Measured Frequency (MHz)	Frequency Drift (%)	Measured Frequency (MHz)	Frequency Drift (%)
50	120	5180.0129	0.00025	5180.0116	0.00022	5180.0103	0.00020	5180.0131	0.00025
40	120	5180.0185	0.00036	5180.0181	0.00035	5180.0191	0.00037	5180.0221	0.00043
30	120	5180.0109	0.00021	5180.0096	0.00019	5180.0104	0.00020	5180.013	0.00025
20	120	5180.0195	0.00038	5180.0188	0.00036	5180.0211	0.00041	5180.0206	0.00040
10	120	5180.0187	0.00036	5180.02	0.00039	5180.0188	0.00036	5180.0179	0.00035
0	120	5180.0071	0.00014	5180.0079	0.00015	5180.007	0.00014	5180.0045	0.00009
-10	120	5180.0157	0.00030	5180.0172	0.00033	5180.017	0.00033	5180.0161	0.00031
-20	120	5179.9887	-0.00022	5179.9905	-0.00018	5179.989	-0.00021	5179.9895	-0.00020
-30	120	5179.9778	-0.00043	5179.9775	-0.00043	5179.9758	-0.00047	5179.9768	-0.00045

FREQUENCY STABILITY VERSUS VOLTAGE									
OPERATING FREQUENCY: 5180MHz									
TEMP. (°C)	POWER SUPPLY (Vac)	0 MINUTE		2 MINUTE		5 MINUTE		10 MINUTE	
		Measured Frequency (MHz)	Frequency Drift (%)	Measured Frequency (MHz)	Frequency Drift (%)	Measured Frequency (MHz)	Frequency Drift (%)	Measured Frequency (MHz)	Frequency Drift (%)
20	138	5180.0185	0.00036	5180.0179	0.00035	5180.0208	0.00040	5180.0202	0.00039
	120	5180.0195	0.00038	5180.0188	0.00036	5180.0211	0.00041	5180.0206	0.00040
	102	5180.0203	0.00039	5180.0191	0.00037	5180.0208	0.00040	5180.0201	0.00039

4.6 6dB Bandwidth Measurement

4.6.1 Limits of 6dB Bandwidth Measurement

The minimum of 6dB Bandwidth Measurement is 0.5MHz.

4.6.2 Test Setup

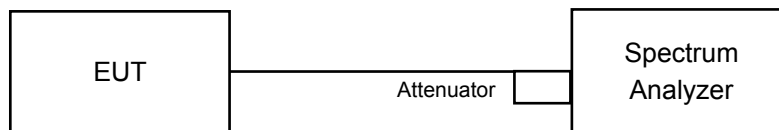

4.6.3 Test Instruments

Refer to section 4.1.2 to get information of above instrument.

4.6.4 Test Procedure

MEASUREMENT PROCEDURE REF

- Set resolution bandwidth (RBW) = 100kHz
- Set the video bandwidth (VBW) $\geq 3 \times$ RBW, Detector = Peak.
- Trace mode = max hold.
- Sweep = auto couple.
- Measure the maximum width of the emission that is constrained by the frequencies associated with the two amplitude points (upper and lower) that are attenuated by 6 dB relative to the maximum level measured in the fundamental emission

4.6.5 Deviation from Test Standard

No deviation.

4.6.6 EUT Operating Condition

The software provided by client to enable the EUT under transmission condition continuously at lowest, middle and highest channel frequencies individually.

4.6.7 Test Results

802.11a

Channel	Frequency (MHz)	6dB Bandwidth (MHz)		Minimum Limit (MHz)	Pass / Fail
		Chain 0	Chain 1		
149	5745	16.45	16.40	0.5	Pass
157	5785	16.43	16.43	0.5	Pass
165	5825	16.41	16.43	0.5	Pass

802.11ac (VHT20)

Channel	Frequency (MHz)	6dB Bandwidth (MHz)		Minimum Limit (MHz)	Pass / Fail
		Chain 0	Chain 1		
149	5745	17.63	17.65	0.5	Pass
157	5785	17.67	17.65	0.5	Pass
165	5825	17.65	17.63	0.5	Pass

802.11ac (VHT40)

Channel	Frequency (MHz)	6dB Bandwidth (MHz)		Minimum Limit (MHz)	Pass / Fail
		Chain 0	Chain 1		
151	5755	36.43	36.03	0.5	Pass
159	5795	36.46	36.45	0.5	Pass

802.11ac (VHT80)

Channel	Frequency (MHz)	6dB Bandwidth (MHz)		Minimum Limit (MHz)	Pass / Fail
		Chain 0	Chain 1		
155	5775	75.89	75.88	0.5	Pass

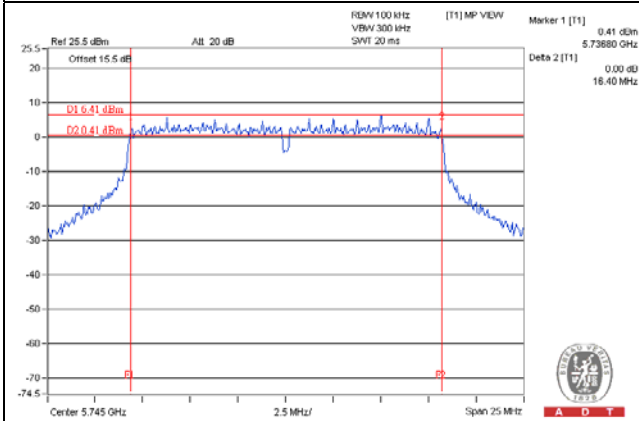
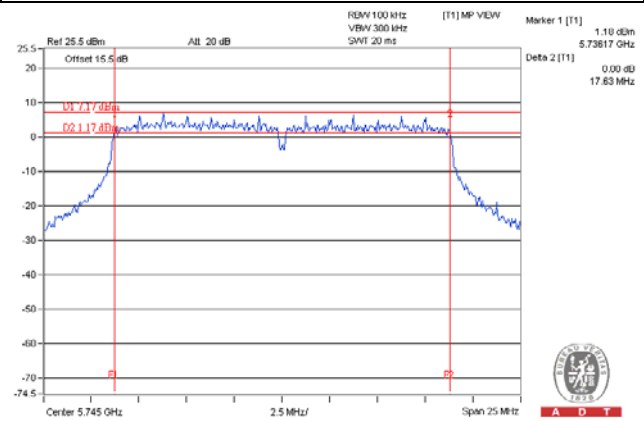
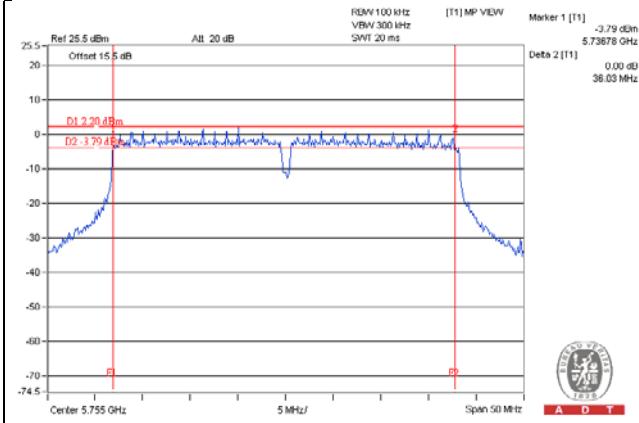
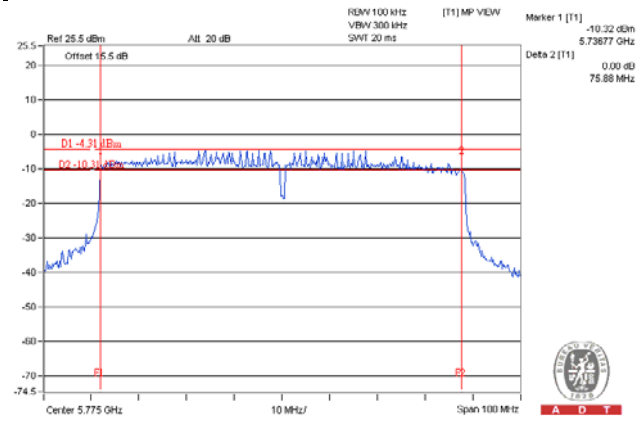
Spectrum Plot of Worst Value**802.11a / Chain 1 : CH149****802.11ac(VHT20) / Chain 0 : CH149****802.11ac(VHT40) / Chain 1 : CH151****802.11ac(VHT40) / Chain 1 : CH155**

5 Pictures of Test Arrangements

Please refer to the attached file (Test Setup Photo).



Appendix – Information on the Testing Laboratories

We, Bureau Veritas Consumer Products Services (H.K.) Ltd., Taoyuan Branch, were founded in 1988 to provide our best service in EMC, Radio, Telecom and Safety consultation. Our laboratories are accredited and approved according to ISO/IEC 17025.

If you have any comments, please feel free to contact us at the following:

Linko EMC/RF Lab

Tel: 886-2-26052180

Fax: 886-2-26051924

Hsin Chu EMC/RF/Telecom Lab

Tel: 886-3-6668565

Fax: 886-3-6668323

Hwa Ya EMC/RF/Safety Lab

Tel: 886-3-3183232

Fax: 886-3-3270892

Email: service.adt@tw.bureauveritas.com

Web Site: www.bureauveritas-adt.com

The address and road map of all our labs can be found in our web site also.

--- END ---