

FCC Test Report

Report No.: RF140423C02B

FCC ID: YZKECW5210L

Test Model: ECW5210-L

Received Date: Oct. 26, 2017

Test Date: Nov. 11, 2017

Issued Date: Nov. 16, 2017

Applicant: Edgecore Networks Corporation

Address: No. 1 Creation Rd. III, Hsinchu Science Park, Hsinchu 30077, Taiwan

Issued By: Bureau Veritas Consumer Products Services (H.K.) Ltd., Taoyuan Branch

Lab Address: No. 47-2, 14th Ling, Chia Pau Vil., Lin Kou Dist., New Taipei City, Taiwan
(R.O.C)

Test Location: No. 19, Hwa Ya 2nd Rd, Wen Hwa Tsuen, Kwei Shan Hsiang, Taoyuan
Hsien 333, Taiwan, R.O.C.

**FCC Registration /
Designation Number:** 788550 / TW0003



This report is for your exclusive use. Any copying or replication of this report to or for any other person or entity, or use of our name or trademark, is permitted only with our prior written permission. This report sets forth our findings solely with respect to the test samples identified herein. The results set forth in this report are not indicative or representative of the quality or characteristics of the lot from which a test sample was taken or any similar or identical product unless specifically and expressly noted. Our report includes all of the tests requested by you and the results thereof based upon the information that you provided to us. You have 60 days from date of issuance of this report to notify us of any material error or omission caused by our negligence, provided, however, that such notice shall be in writing and shall specifically address the issue you wish to raise. A failure to raise such issue within the prescribed time shall constitute your unqualified acceptance of the completeness of this report, the tests conducted and the correctness of the report contents. Unless specific mention, the uncertainty of measurement has been explicitly taken into account to declare the compliance or non-compliance to the specification.

Table of Contents

Release Control Record	4
1 Certificate of Conformity	5
2 Summary of Test Results	6
2.1 Measurement Uncertainty	6
2.2 Modification Record	6
3 General Information	7
3.1 General Description of EUT	7
3.2 Description of Test Modes	8
3.2.1 Test Mode Applicability and Tested Channel Detail	9
3.3 Duty Cycle of Test Signal	11
3.4 Description of Support Units	12
3.4.1 Configuration of System under Test	12
3.5 General Description of Applied Standards	13
4 Test Types and Results	14
4.1 Radiated Emission and Bandedge Measurement	14
4.1.1 Limits of Radiated Emission and Bandedge Measurement	14
4.1.2 Test Instruments	15
4.1.3 Test Procedures	17
4.1.4 Deviation from Test Standard	17
4.1.5 Test Set Up	18
4.1.6 EUT Operating Conditions	19
4.1.7 Test Results	20
4.2 Conducted Emission Measurement	34
4.2.1 Limits of Conducted Emission Measurement	34
4.2.2 Test Instruments	34
4.2.3 Test Procedures	35
4.2.4 Deviation from Test Standard	35
4.2.5 Test Setup	35
4.2.6 EUT Operating Conditions	35
4.2.7 Test Results	36
4.3 6 dB Bandwidth Measurement	38
4.3.1 Limits of 6 dB Bandwidth Measurement	38
4.3.2 Test Setup	38
4.3.3 Test Instruments	38
4.3.4 Test Procedure	38
4.3.5 Deviation from Test Standard	38
4.3.6 EUT Operating Conditions	38
4.3.7 Test Result	39
4.4 Occupied Bandwidth Measurement	41
4.4.1 Test Setup	41
4.4.2 Test Instruments	41
4.4.3 Test Procedure	41
4.4.4 Deviation from Test Standard	41
4.4.5 EUT Operating Conditions	41
4.4.6 Test Results	42
4.5 Conducted Output Power Measurement	44
4.5.1 Limits of Conducted Output Power Measurement	44
4.5.2 Test Setup	44
4.5.3 Test Instruments	44
4.5.4 Test Procedures	44
4.5.5 Deviation from Test Standard	44
4.5.6 EUT Operating Conditions	44
4.5.7 Test Results	45

4.6	Power Spectral Density Measurement	46
4.6.1	Limits of Power Spectral Density Measurement.....	46
4.6.2	Test Setup.....	46
4.6.3	Test Instruments	46
4.6.4	Test Procedure	46
4.6.5	Deviation from Test Standard	46
4.6.6	EUT Operating Condition	46
4.6.7	Test Results	47
4.7	Conducted Out of Band Emission Measurement	50
4.7.1	Limits of Conducted Out of Band Emission Measurement.....	50
4.7.2	Test Setup.....	50
4.7.3	Test Instruments	50
4.7.4	Test Procedure	50
4.7.5	Deviation from Test Standard	50
4.7.6	EUT Operating Condition	50
4.7.7	Test Results	51
5	Pictures of Test Arrangements.....	67
	Appendix – Information on the Testing Laboratories	68

Release Control Record

Issue No.	Description	Date Issued
RF140423C02B	Original Release	Nov. 16, 2017

1 Certificate of Conformity

Product: Enterprise Access Point

Brand: Edgecore

Test Model: ECW5210-L

Sample Status: Production Unit

Applicant: Edgecore Networks Corporation

Test Date: Nov. 11, 2017

Standards: 47 CFR FCC Part 15, Subpart C (Section 15.247)
ANSI C63.10:2013

The above equipment has been tested by **Bureau Veritas Consumer Products Services (H.K.) Ltd., Taoyuan Branch**, and found compliance with the requirement of the above standards. The test record, data evaluation & Equipment Under Test (EUT) configurations represented herein are true and accurate accounts of the measurements of the sample's RF characteristics under the conditions specified in this report.

Prepared by :

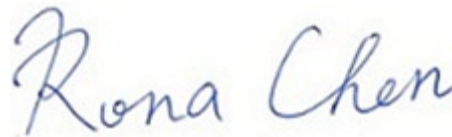

Date: Nov. 16, 2017

Rona Chen / Specialist

Approved by :

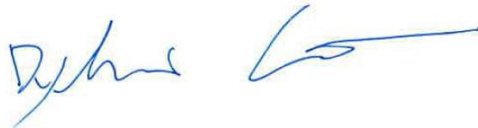

Date: Nov. 16, 2017

Dylan Chiou / Project Engineer

2 Summary of Test Results

47 CFR FCC Part 15, Subpart C (Section 15.247)			
FCC Clause	Test Item	Result	Remarks
15.207	AC Power Conducted Emission	Pass	Meet the requirement of limit. Minimum passing margin is -7.10 dB at 0.15391 MHz.
15.205 / 15.209 / 15.247(d)	Radiated Emissions and Band Edge Measurement	Pass	Meet the requirement of limit. Minimum passing margin is -0.94 dB at 2483.5 MHz.
15.247(d)	Antenna Port Emission	Pass	Meet the requirement of limit.
15.247(a)(2)	6 dB Bandwidth	Pass	Meet the requirement of limit.
---	Occupied Bandwidth Measurement	Pass	Reference only
15.247(b)	Conducted power	Pass	Meet the requirement of limit.
15.247(e)	Power Spectral Density	Pass	Meet the requirement of limit.
15.203	Antenna Requirement	Pass	No antenna connector is used.

2.1 Measurement Uncertainty

Where relevant, the following measurement uncertainty levels have been estimated for tests performed on the EUT:

The listed uncertainties are the worst case uncertainty for the entire range of measurement. Please note that the uncertainty values are provided for informational purposes only and are not used in determining the PASS/FAIL results.

Measurement	Frequency	Expanded Uncertainty (k=2) (\pm)
Conducted Emissions at mains ports	150 kHz ~ 30 MHz	2.44 dB
Radiated Emissions up to 1 GHz	30 MHz ~ 200 MHz	2.93 dB
	200 MHz ~ 1000 MHz	2.95 dB
Radiated Emissions above 1 GHz	1 GHz ~ 18 GHz	2.26 dB
	18 GHz ~ 40 GHz	1.94 dB

2.2 Modification Record

There were no modifications required for compliance.

3 General Information

3.1 General Description of EUT

Product	Enterprise Access Point
Brand	Edgecore
Test Model	ECW5210-L
Status of EUT	Production Unit
Power Supply Rating	12Vdc (Adapter)
Modulation Type	CCK, DQPSK, DBPSK for DSSS 64QAM, 16QAM, QPSK, BPSK for OFDM
Modulation Technology	DSSS, OFDM
Transfer Rate	802.11b: 11.0 / 5.5 / 2.0 / 1.0 Mbps 802.11g: 54.0 / 48.0 / 36.0 / 24.0 / 18.0 / 12.0 / 9.0 / 6.0 Mbps 802.11n: up to MCS7
Operating Frequency	2412 ~ 2462 MHz
Number of Channel	11 for 802.11b, 802.11g, 802.11n (HT20) 7 for 802.11n (HT40)
Output Power	737.625 mW
Antenna Type	Refer to Note as below
Antenna Connector	N/A
Accessory Device	Refer to Note as below
Data Cable Supplied	Refer to Note as below

Note:

1. The antenna information is listed as below.

Antenna Type	Antenna Model	Band	Frequency Band	Tx Antenna	Antenna Gain
PCB	AP331AI	sercomm	2412 ~ 2462	1	4.28
				2	1.34
				3	2.54

2. The EUT contains following accessory devices.

Item	Brand	Model	Specification
Adapter	Asian	WA-30B12	I/P: 100-240Vac, 50-60Hz, 0.8A O/P: 12Vdc, 2.5A AC power code 1.5m

3. The EUT incorporates a MIMO function. Physically, the EUT provides 3 completed transmitters and 3 receivers.

Modulation Mode	Tx Function
802.11b	1TX
802.11g	1TX
802.11n (HT20)	3TX
802.11n (HT40)	3TX

4. The above EUT information is declared by manufacturer and for more detailed features description, please refer to the manufacturer's specifications or user's manual.

3.2 Description of Test Modes

11 channels are provided for 802.11b, 802.11g and 802.11n (HT20):

Channel	Frequency (MHz)	Channel	Frequency (MHz)
1	2412	7	2442
2	2417	8	2447
3	2422	9	2452
4	2427	10	2457
5	2432	11	2462
6	2437		

7 channels are provided for 802.11n (HT40):

Channel	Frequency (MHz)	Channel	Frequency (MHz)
3	2422	7	2442
4	2427	8	2447
5	2432	9	2452
6	2437		

3.2.1 Test Mode Applicability and Tested Channel Detail

EUT Configure Mode	Applicable To				Description
	RE \geq 1G	RE $<$ 1G	PLC	APCM	
-	√	√	√	√	-

Where **RE \geq 1G**: Radiated Emission above 1 GHz **RE $<$ 1G**: Radiated Emission below 1 GHz
PLC: Power Line Conducted Emission **APCM**: Antenna Port Conducted Measurement

NOTE: The EUT had been pre-tested on the positioned of each 3 axis. The worst case was found when positioned on **X-plane**.

Radiated Emission Test (Above 1 GHz):

- Pre-Scan has been conducted to determine the worst-case mode from all possible combinations between available modulations, data rates and antenna ports (if EUT with antenna diversity architecture).
- Following channel(s) was (were) selected for the final test as listed below.

EUT Configure Mode	Mode	Available Channel	Tested Channel	Modulation Technology	Modulation Type	Data Rate (Mbps)
-	802.11b	1 to 11	1, 6, 11	DSSS	DBPSK	1.0
-	802.11g	1 to 11	1, 6, 11	OFDM	BPSK	6.0
-	802.11n (HT20)	1 to 11	1, 6, 11	OFDM	BPSK	MCS0
-	802.11n (HT40)	3 to 9	3, 6, 9	OFDM	BPSK	MCS0

Radiated Emission Test (Below 1 GHz):

- Pre-Scan has been conducted to determine the worst-case mode from all possible combinations between available modulations, data rates and antenna ports (if EUT with antenna diversity architecture).
- Following channel(s) was (were) selected for the final test as listed below.

EUT Configure Mode	Mode	Available Channel	Tested Channel	Modulation Technology	Modulation Type	Data Rate (Mbps)
-	802.11n (HT40)	3 to 9	6	OFDM	BPSK	MCS0

Power Line Conducted Emission Test:

- Pre-Scan has been conducted to determine the worst-case mode from all possible combinations between available modulations, data rates and antenna ports (if EUT with antenna diversity architecture).
- Following channel(s) was (were) selected for the final test as listed below.

EUT Configure Mode	Mode	Available Channel	Tested Channel	Modulation Technology	Modulation Type	Data Rate (Mbps)
-	802.11n (HT40)	3 to 9	6	OFDM	BPSK	MCS0

Bandedge Measurement:

- Pre-Scan has been conducted to determine the worst-case mode from all possible combinations between available modulations, data rates and antenna ports (if EUT with antenna diversity architecture).
- Following channel(s) was (were) selected for the final test as listed below.

EUT Configure Mode	Mode	Available Channel	Tested Channel	Modulation Technology	Modulation Type	Data Rate (Mbps)
-	802.11b	1 to 11	1, 11	DSSS	DBPSK	1.0
-	802.11g	1 to 11	1, 11	OFDM	BPSK	6.0
-	802.11n (HT20)	1 to 11	1, 11	OFDM	BPSK	MCS0
-	802.11n (HT40)	3 to 9	3, 9	OFDM	BPSK	MCS0

Antenna Port Conducted Measurement:

- This item includes all test value of each mode, but only includes spectrum plot of worst value of each mode.
- Pre-Scan has been conducted to determine the worst-case mode from all possible combinations between available modulations, data rates and antenna ports (if EUT with antenna diversity architecture).
- Following channel(s) was (were) selected for the final test as listed below.

EUT Configure Mode	Mode	Available Channel	Tested Channel	Modulation Technology	Modulation Type	Data Rate (Mbps)
-	802.11b	1 to 11	1, 6, 11	DSSS	DBPSK	1.0
-	802.11g	1 to 11	1, 6, 11	OFDM	BPSK	6.0
-	802.11n (HT20)	1 to 11	1, 6, 11	OFDM	BPSK	MCS0
-	802.11n (HT40)	3 to 9	3, 6, 9	OFDM	BPSK	MCS0

Test Condition:

Applicable To	Environmental Conditions	Input Power	Tested by
RE \geq 1G	25 deg. C, 65 % RH	120 Vac, 60 Hz	Greg Lin
RE<1G	25 deg. C, 65 % RH	120 Vac, 60 Hz	Greg Lin
PLC	25 deg. C, 65 % RH	120 Vac, 60 Hz	Anson Lin
APCM	25 deg. C, 65 % RH	120 Vac, 60 Hz	Luke Chen

3.3 Duty Cycle of Test Signal

802.11b: Duty cycle of test signal is 100 %, duty factor is not required.

802.11g: Duty cycle = $2.012/2.076 = 0.969$, Duty factor = $10 * \log(1/0.969) = 0.14$

802.11n (HT20): Duty cycle = $1.883/1.947 = 0.967$, Duty factor = $10 * \log(1/0.967) = 0.15$

802.11n (HT40): Duty cycle = $630.512/675.384 = 0.934$, Duty factor = $10 * \log(1/0.934) = 0.30$

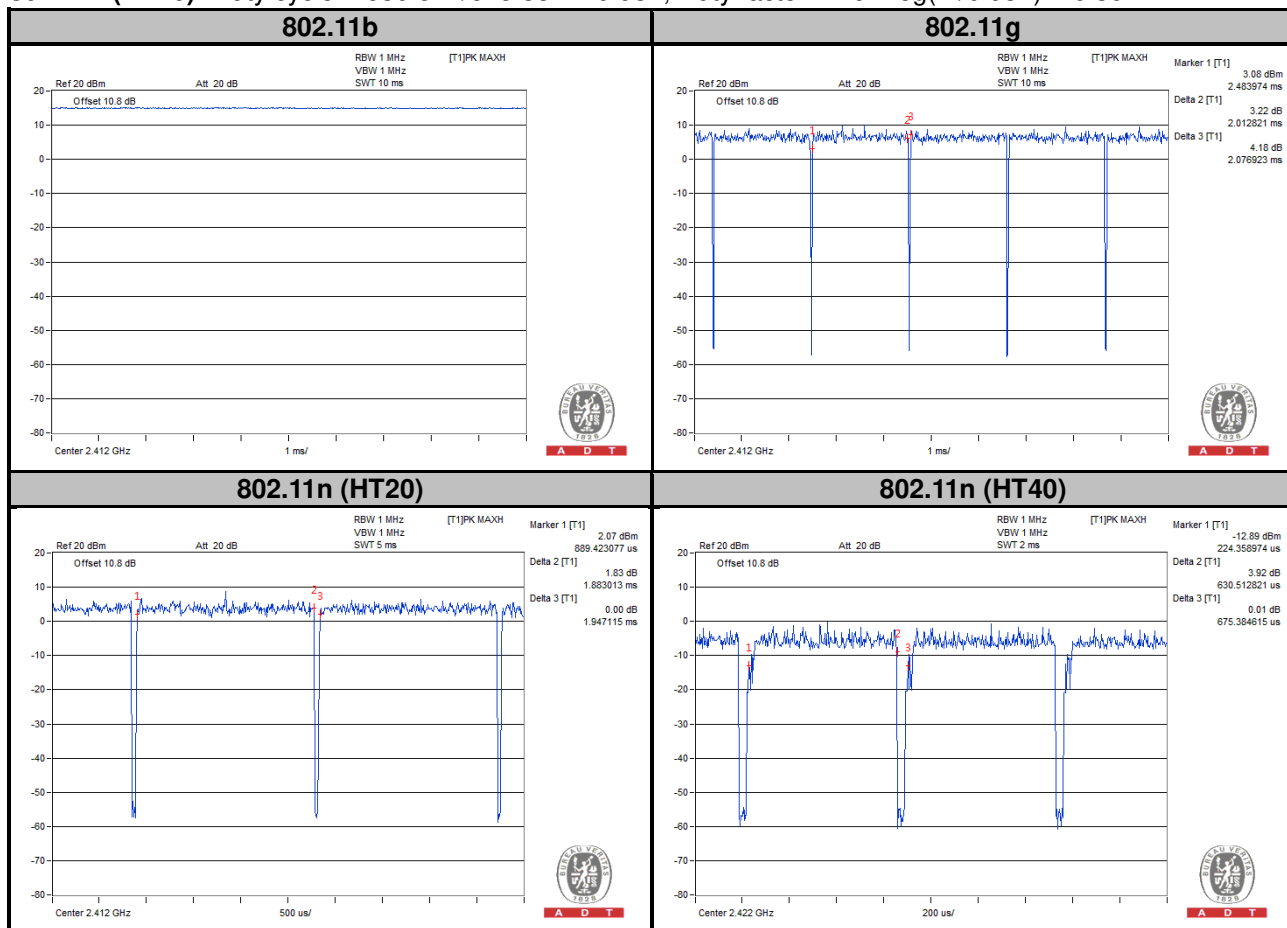

3.4 Description of Support Units

The EUT has been tested as an independent unit together with other necessary accessories or support units. The following support units or accessories were used to form a representative test configuration during the tests.

No.	Product	Brand	Model No.	Serial No.	FCC ID
1.	Notebook	DELL	E6420	D3T96R1	N/A

No.	Signal Cable Description Of The Above Support Units
1.	N/A

Note:

1. All power cords of the above support units are non-shielded (1.8m).

3.4.1 Configuration of System under Test

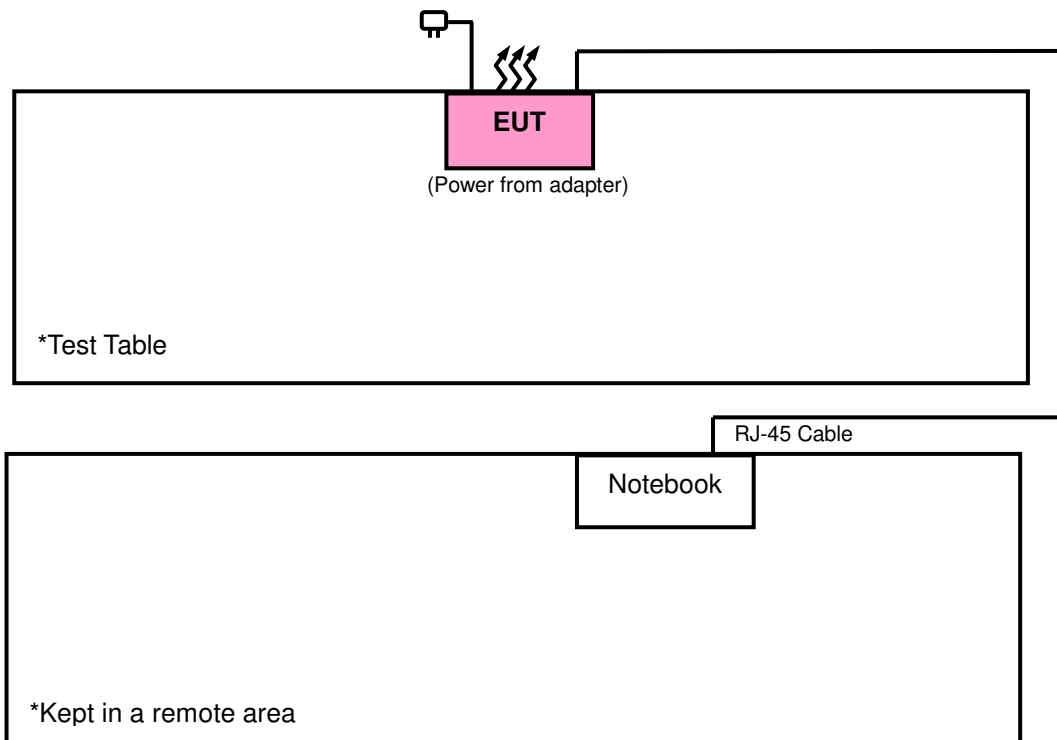

3.5 General Description of Applied Standards

The EUT is a RF Product. According to the specifications of the manufacturer, it must comply with the requirements of the following standards:

FCC Part 15, Subpart C (15.247)

558074 D01 DTS Meas Guidance v04

662911 D01 Multiple Transmitter Output v02r01

ANSI C63.10-2013

All test items have been performed and recorded as per the above standards.

NOTE: The EUT has been verified to comply with the requirements of FCC Part 15, Subpart B, Class B (DoC).
The test report has been issued separately.

4 Test Types and Results

4.1 Radiated Emission and Bandedge Measurement

4.1.1 Limits of Radiated Emission and Bandedge Measurement

Radiated emissions which fall in the restricted bands must comply with the radiated emission limits specified as below table. Other emissions shall be at least 20 dB below the highest level of the desired power:

Frequencies (MHz)	Field Strength (microvolts/meter)	Measurement Distance (meters)
0.009 ~ 0.490	2400/F (kHz)	300
0.490 ~ 1.705	24000/F (kHz)	30
1.705 ~ 30.0	30	30
30 ~ 88	100	3
88 ~ 216	150	3
216 ~ 960	200	3
Above 960	500	3

NOTE:

1. The lower limit shall apply at the transition frequencies.
2. Emission level (dBuV/m) = 20 log Emission level (uV/m).
3. For frequencies above 1000 MHz, the field strength limits are based on average detector, however, the peak field strength of any emission shall not exceed the maximum permitted average limits, specified above by more than 20 dB under any condition of modulation.

4.1.2 Test Instruments

Description & Manufacturer	Model No.	Serial No.	Date of Calibration	Due Date of Calibration
Test Receiver Agilent	N9038A	MY51210203	Feb. 17, 2017	Feb. 16, 2018
Spectrum Analyzer Agilent	N9010A	MY52220314	Dec. 16, 2016	Dec. 15, 2017
Spectrum Analyzer ROHDE & SCHWARZ	FSU43	101261	Dec. 13, 2016	Dec. 12, 2017
BILOG Antenna SCHWARZBECK	VULB9168	9168-472	Dec. 26, 2016	Dec. 27, 2017
HORN Antenna SCHWARZBECK	BBHA 9120 D	9120D-969	Dec. 12, 2016	Dec. 13, 2017
HORN Antenna SCHWARZBECK	BBHA 9170	9170-480	Dec. 14, 2016	Dec. 13, 2017
Fixed Attenuator Mini-Circuits	MDCS18N-10	MDCS18N-10-01	Apr. 17, 2017	Apr. 16, 2018
Loop Antenna	HLA 6121	45745	May 19, 2017	May 18, 2018
Preamplifier EMCI	EMC001340	980201	Nov. 01, 2017	Oct. 31, 2018
Bluetooth Tester	CBT	100946	Jul. 29, 2016	Jul. 28, 2018
Preamplifier EMCI	EMC 012645	980115	Oct. 20, 2017	Oct. 19, 2018
Preamplifier EMCI	EMC 184045	980116	Oct. 20, 2017	Oct. 19, 2018
Preamplifier EMCI	EMC 330H	980112	Oct. 13, 2017	Oct. 12, 2018
Power Meter Anritsu	ML2495A	1012010	Aug. 15, 2017	Aug. 14, 2018
Power Sensor Anritsu	MA2411B	1315050	Aug. 15, 2017	Aug. 14, 2018
RF Coaxial Cable EMCI	5D-NM-BM	140903+140902	Oct. 20, 2017	Oct. 19, 2018
RF Coaxial Cable EMCI	5D-NM-BM	140901	Oct. 20, 2017	Oct. 19, 2018
RF Coaxial Cable Worken	8D-FB	Cable-Ch10-01	Oct. 20, 2017	Oct. 19, 2018
Software BV ADT	E3 6.120103	NA	NA	NA
Antenna Tower MF	MFA-440H	NA	NA	NA
Turn Table MF	MFT-201SS	NA	NA	NA
Antenna Tower & Turn Table Controller MF	MF-7802	NA	NA	NA

- Note:
1. The calibration interval of the above test instruments is 12 months and the calibrations are traceable to NML/ROC and NIST/USA.
 2. The test was performed in HwaYa Chamber 10.
 3. The horn antenna and preamplifier (model: EMC 184045) are used only for the measurement of emission frequency above 1 GHz if tested.
 4. The FCC Designation Number is TW0003. The number will be varied with the Lab location and scope as attached.
 5. The IC Site Registration No. is IC7450F-10.

4.1.3 Test Procedures

- a. The EUT was placed on the top of a rotating table 0.8 meters (for below 1 GHz) / 1.5 meters (for above 1 GHz) above the ground at 3 meter chamber room for test. The table was rotated 360 degrees to determine the position of the highest radiation.
- b. The EUT was set 3 meters away from the interference-receiving antenna, which was mounted on the top of a variable-height antenna tower.
- c. The height of antenna is varied from one meter to four meters above the ground to determine the maximum value of the field strength. Both horizontal and vertical polarizations of the antenna are set to make the measurement.
- d. For each suspected emission, the EUT was arranged to its worst case and then the antenna was tuned to heights from 1 meter to 4 meters and the rotatable table was turned from 0 degrees to 360 degrees to find the maximum reading.
- e. The test-receiver system was set to quasi-peak detect function and specified bandwidth with maximum hold mode when the test frequency is below 1 GHz.
- f. The test-receiver system was set to peak and average detected function and specified bandwidth with maximum hold mode when the test frequency is above 1 GHz. If the peak reading value also meets average limit, measurement with the average detector is unnecessary.

Note:

1. The resolution bandwidth and video bandwidth of test receiver/spectrum analyzer is 120 kHz & 360 KHz for Quasi-peak detection (QP) at frequency below 1 GHz.
2. The resolution bandwidth of test receiver/spectrum analyzer is 1 MHz and the video bandwidth is 3 MHz for Peak detection (PK) at frequency above 1 GHz.
3. The resolution bandwidth of test receiver/spectrum analyzer is 1 MHz and the video bandwidth is 1/T for Average (Duty cycle < 98 %) detection at frequency above 1 GHz.
4. The resolution bandwidth of test receiver/spectrum analyzer is 1 MHz and the video bandwidth is 10 Hz (Duty cycle \geq 98 %) for Average detection (AV) at frequency above 1 GHz.
5. All modes of operation were investigated and the worst-case emissions are reported.

4.1.4 Deviation from Test Standard

No deviation.

4.1.5 Test Set Up

<Radiated emission below 30 MHz>

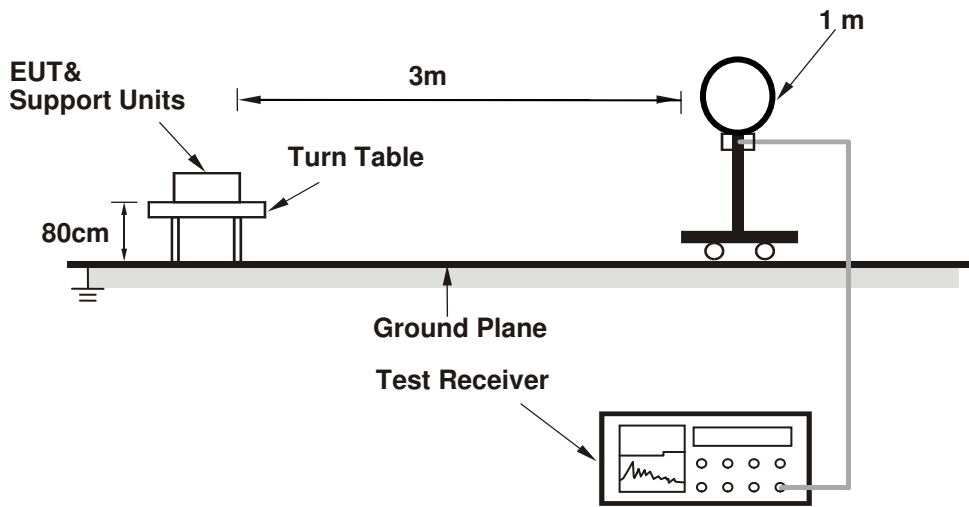

<Frequency Range below 1 GHz>

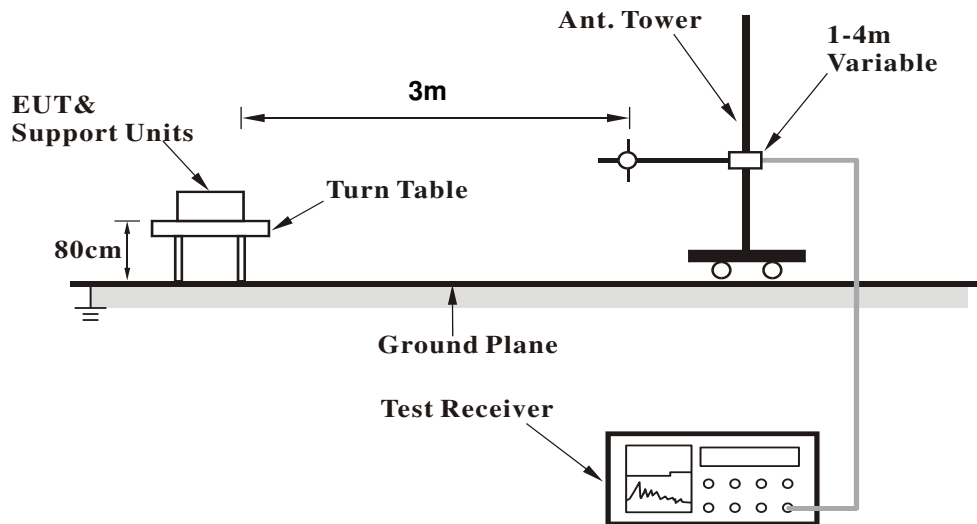

<Frequency Range above 1 GHz>

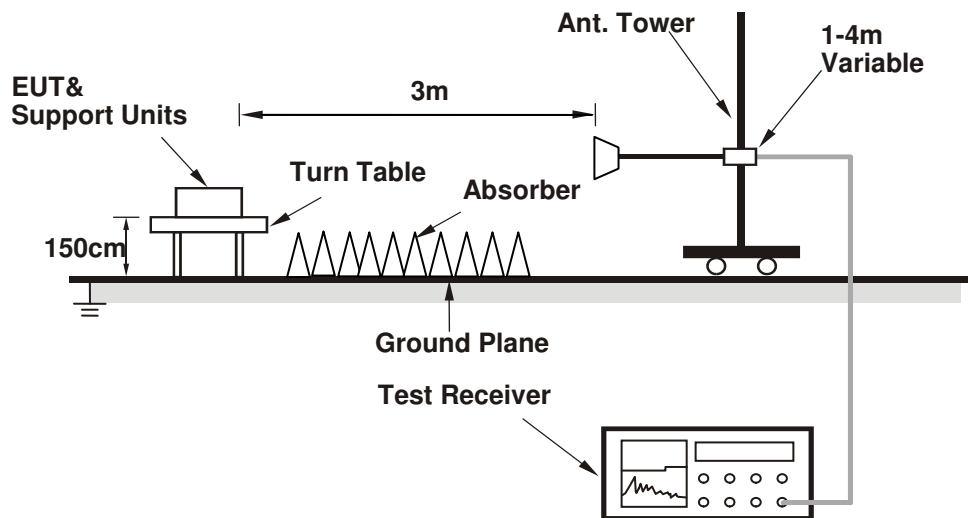

For the actual test configuration, please refer to the attached file (Test Setup Photo).

4.1.6 EUT Operating Conditions

- a. Placed the EUT on a testing table.
- b. Use the software to control the EUT under transmission condition continuously at specific channel frequency.

4.1.7 Test Results

 Above 1 GHz Data :
 802.11b

EUT Test Condition		Measurement Detail	
Channel	Channel 1	Frequency Range	1 GHz ~ 25 GHz
Input Power	120 Vac, 60 Hz	Detector Function	Peak (PK) Average (AV)
Environmental Conditions	25 deg. C, 65 % RH	Tested By	Greg Lin

Antennal Polarity & Test Distance: Horizontal at 3 m										
Frequency (MHz)	Emission Level (dBuV/m)	Read Level (dBuV)	Limit (dBuV/m)	Margin (dB)	Antenna Factor (dB/m)	Cable Loss (dB)	Preamp Factor (dB)	Antenna Height (cm)	Table Angle (Degree)	Remark
2146	59.75	58.77	90.4	-30.65	31.54	5.07	35.63	124	126	Average
2146	67.59	66.61	92.86	-25.27	31.54	5.07	35.63	124	126	Peak
2386	45.76	44.05	54	-8.24	31.8	5.4	35.49	124	126	Average
2386	56.2	54.49	74	-17.8	31.8	5.4	35.49	124	126	Peak
2412	110.4	108.63			31.81	5.43	35.47	124	126	Average
2412	112.86	111.09			31.81	5.43	35.47	124	126	Peak
2492	51.96	49.94	54	-2.04	31.9	5.53	35.41	124	126	Average
2492	63.61	61.59	74	-10.39	31.9	5.53	35.41	124	126	Peak
Antennal Polarity & Test Distance: Vertical at 3 m										
Frequency (MHz)	Emission Level (dBuV/m)	Read Level (dBuV)	Limit (dBuV/m)	Margin (dB)	Antenna Factor (dB/m)	Cable Loss (dB)	Preamp Factor (dB)	Antenna Height (cm)	Table Angle (Degree)	Remark
2148	59.7	58.66	88.93	-29.23	31.56	5.11	35.63	159	308	Average
2148	68.93	67.89	90.77	-21.84	31.56	5.11	35.63	159	308	Peak
2390	42.72	40.99	54	-11.28	31.8	5.4	35.47	159	308	Average
2390	56.49	54.76	74	-17.51	31.8	5.4	35.47	159	308	Peak
2412	108.93	107.16			31.81	5.43	35.47	159	308	Average
2412	110.77	109			31.81	5.43	35.47	159	308	Peak
2494	52.96	50.94	54	-1.04	31.9	5.53	35.41	159	308	Average
2494	61.46	59.44	74	-12.54	31.9	5.53	35.41	159	308	Peak

Remarks:

- Emission Level = Read Level + Antenna Factor + Cable Loss - Preamp Factor
Margin value = Emission level – Limit value
- 2412 MHz: Fundamental frequency.
- 2146 MHz & 2148 MHz: Out of restricted band

EUT Test Condition		Measurement Detail	
Channel	Channel 6	Frequency Range	1 GHz ~ 25 GHz
Input Power	120 Vac, 60 Hz	Detector Function	Peak (PK) Average (AV)
Environmental Conditions	25 deg. C, 65 % RH	Tested By	Greg Lin

Antennal Polarity & Test Distance: Horizontal at 3 m										
Frequency (MHz)	Emission Level (dBuV/m)	Read Level (dBuV)	Limit (dBuV/m)	Margin (dB)	Antenna Factor (dB/m)	Cable Loss (dB)	Preamp Factor (dB)	Antenna Height (cm)	Table Angle (Degree)	Remark
2382	44.04	42.35	54	-9.96	31.78	5.4	35.49	130	120	Average
2382	56.12	54.43	74	-17.88	31.78	5.4	35.49	130	120	Peak
2437	110.01	108.16			31.85	5.46	35.46	130	120	Average
2437	112.91	111.06			31.85	5.46	35.46	130	120	Peak
2500	45	42.98	54	-9	31.9	5.53	35.41	130	120	Average
2500	56.33	54.31	74	-17.67	31.9	5.53	35.41	130	120	Peak

Antennal Polarity & Test Distance: Vertical at 3 m										
Frequency (MHz)	Emission Level (dBuV/m)	Read Level (dBuV)	Limit (dBuV/m)	Margin (dB)	Antenna Factor (dB/m)	Cable Loss (dB)	Preamp Factor (dB)	Antenna Height (cm)	Table Angle (Degree)	Remark
2346	42.61	41.04	54	-11.39	31.74	5.33	35.5	159	308	Average
2346	54.85	53.28	74	-19.15	31.74	5.33	35.5	159	308	Peak
2437	108.28	106.43			31.85	5.46	35.46	159	308	Average
2437	110.98	109.13			31.85	5.46	35.46	159	308	Peak
2500	45.96	43.94	54	-8.04	31.9	5.53	35.41	159	308	Average
2500	58.23	56.21	74	-15.77	31.9	5.53	35.41	159	308	Peak

Remarks:

- Emission Level = Read Level + Antenna Factor + Cable Loss - Preamp Factor
Margin value = Emission level – Limit value
- 2437 MHz: Fundamental frequency.

EUT Test Condition		Measurement Detail	
Channel	Channel 11	Frequency Range	1 GHz ~ 25 GHz
Input Power	120 Vac, 60 Hz	Detector Function	Peak (PK) Average (AV)
Environmental Conditions	25 deg. C, 65 % RH	Tested By	Greg Lin

Antennal Polarity & Test Distance: Horizontal at 3 m										
Frequency (MHz)	Emission Level (dBuV/m)	Read Level (dBuV)	Limit (dBuV/m)	Margin (dB)	Antenna Factor (dB/m)	Cable Loss (dB)	Preamp Factor (dB)	Antenna Height (cm)	Table Angle (Degree)	Remark
2382	50.7	49.01	54	-3.3	31.78	5.4	35.49	127	122	Average
2382	60.66	58.97	74	-13.34	31.78	5.4	35.49	127	122	Peak
2462	110.93	109			31.87	5.5	35.44	127	122	Average
2462	112.93	111			31.87	5.5	35.44	127	122	Peak
2500	52.96	50.94	54	-1.04	31.9	5.53	35.41	127	122	Average
2500	61.3	59.28	74	-12.7	31.9	5.53	35.41	127	122	Peak
Antennal Polarity & Test Distance: Vertical at 3 m										
Frequency (MHz)	Emission Level (dBuV/m)	Read Level (dBuV)	Limit (dBuV/m)	Margin (dB)	Antenna Factor (dB/m)	Cable Loss (dB)	Preamp Factor (dB)	Antenna Height (cm)	Table Angle (Degree)	Remark
2384	46.75	45.06	54	-7.25	31.78	5.4	35.49	156	301	Average
2384	54.95	53.26	74	-19.05	31.78	5.4	35.49	156	301	Peak
2462	107.93	106			31.87	5.5	35.44	156	301	Average
2462	110.18	108.25			31.87	5.5	35.44	156	301	Peak
2500	52	49.98	54	-2	31.9	5.53	35.41	156	301	Average
2500	59.47	57.45	74	-14.53	31.9	5.53	35.41	156	301	Peak

Remarks:

- Emission Level = Read Level + Antenna Factor + Cable Loss - Preamp Factor
Margin value = Emission level – Limit value
- 2462 MHz: Fundamental frequency.

802.11g

EUT Test Condition		Measurement Detail	
Channel	Channel 1	Frequency Range	1 GHz ~ 25 GHz
Input Power	120 Vac, 60 Hz	Detector Function	Peak (PK) Average (AV)
Environmental Conditions	25 deg. C, 65 % RH	Tested By	Greg Lin

Antennal Polarity & Test Distance: Horizontal at 3 m										
Frequency (MHz)	Emission Level (dBuV/m)	Read Level (dBuV)	Limit (dBuV/m)	Margin (dB)	Antenna Factor (dB/m)	Cable Loss (dB)	Preamp Factor (dB)	Antenna Height (cm)	Table Angle (Degree)	Remark
2154	44.27	43.23	81.21	-36.94	31.56	5.11	35.63	132	129	Average
2154	59.5	58.46	89.48	-29.98	31.56	5.11	35.63	132	129	Peak
2390	52.52	50.79	54	-1.48	31.8	5.4	35.47	132	129	Average
2390	70.2	68.47	74	-3.8	31.8	5.4	35.47	132	129	Peak
2412	101.21	99.44			31.81	5.43	35.47	132	129	Average
2412	109.48	107.71			31.81	5.43	35.47	132	129	Peak
2488	42.96	40.95	54	-11.04	31.9	5.53	35.42	132	129	Average
2488	57.08	55.07	74	-16.92	31.9	5.53	35.42	132	129	Peak

Antennal Polarity & Test Distance: Vertical at 3 m										
Frequency (MHz)	Emission Level (dBuV/m)	Read Level (dBuV)	Limit (dBuV/m)	Margin (dB)	Antenna Factor (dB/m)	Cable Loss (dB)	Preamp Factor (dB)	Antenna Height (cm)	Table Angle (Degree)	Remark
2148	45.92	44.88	78.81	-32.89	31.56	5.11	35.63	159	308	Average
2148	63.28	62.24	86.99	-23.71	31.56	5.11	35.63	159	308	Peak
2390	51.23	49.5	54	-2.77	31.8	5.4	35.47	159	308	Average
2390	66.26	64.53	74	-7.74	31.8	5.4	35.47	159	308	Peak
2412	98.81	97.04			31.81	5.43	35.47	159	308	Average
2412	106.99	105.22			31.81	5.43	35.47	159	308	Peak
2500	42	39.98	54	-12	31.9	5.53	35.41	159	308	Average
2500	57.14	55.12	74	-16.86	31.9	5.53	35.41	159	308	Peak

Remarks:

- Emission Level = Read Level + Antenna Factor + Cable Loss - Preamp Factor
Margin value = Emission level – Limit value
- 2412 MHz: Fundamental frequency.
- 2154 MHz & 2148 MHz: Out of restricted band

EUT Test Condition		Measurement Detail	
Channel	Channel 6	Frequency Range	1 GHz ~ 25 GHz
Input Power	120 Vac, 60 Hz	Detector Function	Peak (PK) Average (AV)
Environmental Conditions	25 deg. C, 65 % RH	Tested By	Greg Lin

Antennal Polarity & Test Distance: Horizontal at 3 m										
Frequency (MHz)	Emission Level (dBuV/m)	Read Level (dBuV)	Limit (dBuV/m)	Margin (dB)	Antenna Factor (dB/m)	Cable Loss (dB)	Preamp Factor (dB)	Antenna Height (cm)	Table Angle (Degree)	Remark
2390	42.88	41.15	54	-11.12	31.8	5.4	35.47	154	273	Average
2390	57.66	55.93	74	-16.34	31.8	5.4	35.47	154	273	Peak
2437	105.88	104.03			31.85	5.46	35.46	154	273	Average
2437	113.68	111.83			31.85	5.46	35.46	154	273	Peak
2483.5	47.28	45.32	54	-6.72	31.88	5.5	35.42	154	273	Average
2483.5	60.44	58.48	74	-13.56	31.88	5.5	35.42	154	273	Peak

Antennal Polarity & Test Distance: Vertical at 3 m										
Frequency (MHz)	Emission Level (dBuV/m)	Read Level (dBuV)	Limit (dBuV/m)	Margin (dB)	Antenna Factor (dB/m)	Cable Loss (dB)	Preamp Factor (dB)	Antenna Height (cm)	Table Angle (Degree)	Remark
2390	42.88	41.15	54	-11.12	31.8	5.4	35.47	165	303	Average
2390	57.9	56.17	74	-16.1	31.8	5.4	35.47	165	303	Peak
2437	102.88	101.03			31.85	5.46	35.46	165	303	Average
2437	110.52	108.67			31.85	5.46	35.46	165	303	Peak
2500	44	41.98	54	-10	31.9	5.53	35.41	165	303	Average
2500	57.19	55.17	74	-16.81	31.9	5.53	35.41	165	303	Peak

Remarks:

- Emission Level = Read Level + Antenna Factor + Cable Loss - Preamp Factor
Margin value = Emission level – Limit value
- 2437 MHz: Fundamental frequency.

EUT Test Condition		Measurement Detail	
Channel	Channel 11	Frequency Range	1 GHz ~ 25 GHz
Input Power	120 Vac, 60 Hz	Detector Function	Peak (PK) Average (AV)
Environmental Conditions	25 deg. C, 65 % RH	Tested By	Greg Lin

Antennal Polarity & Test Distance: Horizontal at 3 m										
Frequency (MHz)	Emission Level (dBuV/m)	Read Level (dBuV)	Limit (dBuV/m)	Margin (dB)	Antenna Factor (dB/m)	Cable Loss (dB)	Preamp Factor (dB)	Antenna Height (cm)	Table Angle (Degree)	Remark
2384	41.74	40.05	54	-12.26	31.78	5.4	35.49	125	120	Average
2384	57.08	55.39	74	-16.92	31.78	5.4	35.49	125	120	Peak
2462	101.72	99.79			31.87	5.5	35.44	125	120	Average
2462	109.61	107.68			31.87	5.5	35.44	125	120	Peak
2483.5	53.01	51.05	54	-0.99	31.88	5.5	35.42	125	120	Average
2483.5	68.68	66.72	74	-5.32	31.88	5.5	35.42	125	120	Peak

Antennal Polarity & Test Distance: Vertical at 3 m										
Frequency (MHz)	Emission Level (dBuV/m)	Read Level (dBuV)	Limit (dBuV/m)	Margin (dB)	Antenna Factor (dB/m)	Cable Loss (dB)	Preamp Factor (dB)	Antenna Height (cm)	Table Angle (Degree)	Remark
2390	39.72	37.99	54	-14.28	31.8	5.4	35.47	163	303	Average
2390	54.9	53.17	74	-19.1	31.8	5.4	35.47	163	303	Peak
2462	99.93	98			31.87	5.5	35.44	163	303	Average
2462	107.1	105.17			31.87	5.5	35.44	163	303	Peak
2483.5	50.98	49.02	54	-3.02	31.88	5.5	35.42	163	303	Average
2483.5	65.76	63.8	74	-8.24	31.88	5.5	35.42	163	303	Peak

Remarks:

- Emission Level = Read Level + Antenna Factor + Cable Loss - Preamp Factor
Margin value = Emission level – Limit value
- 2462 MHz: Fundamental frequency.

802.11n (HT20)

EUT Test Condition		Measurement Detail	
Channel	Channel 1	Frequency Range	1 GHz ~ 25 GHz
Input Power	120 Vac, 60 Hz	Detector Function	Peak (PK) Average (AV)
Environmental Conditions	25 deg. C, 65 % RH	Tested By	Greg Lin

Antennal Polarity & Test Distance: Horizontal at 3 m

Frequency (MHz)	Emission Level (dBuV/m)	Read Level (dBuV)	Limit (dBuV/m)	Margin (dB)	Antenna Factor (dB/m)	Cable Loss (dB)	Preamp Factor (dB)	Antenna Height (cm)	Table Angle (Degree)	Remark
2390	46.06	44.33	54	-7.94	31.8	5.4	35.47	115	156	Average
2390	61.55	59.82	74	-12.45	31.8	5.4	35.47	115	156	Peak
2412	105.1	103.33			31.81	5.43	35.47	115	156	Average
2412	112.76	110.99			31.81	5.43	35.47	115	156	Peak
2500	43.06	41.04	54	-10.94	31.9	5.53	35.41	115	156	Average
2500	56.92	54.9	74	-17.08	31.9	5.53	35.41	115	156	Peak

Antennal Polarity & Test Distance: Vertical at 3 m

Frequency (MHz)	Emission Level (dBuV/m)	Read Level (dBuV)	Limit (dBuV/m)	Margin (dB)	Antenna Factor (dB/m)	Cable Loss (dB)	Preamp Factor (dB)	Antenna Height (cm)	Table Angle (Degree)	Remark
2390	48.76	47.03	54	-5.24	31.8	5.4	35.47	107	37	Average
2390	66.35	64.62	74	-7.65	31.8	5.4	35.47	107	37	Peak
2412	105.6	103.83			31.81	5.43	35.47	106	176	Average
2412	113.35	111.58			31.81	5.43	35.47	106	176	Peak
2486	45.27	43.28	54	-8.73	31.88	5.53	35.42	106	176	Average
2486	60.06	58.07	74	-13.94	31.88	5.53	35.42	106	176	Peak

Remarks:

- Emission Level = Read Level + Antenna Factor + Cable Loss - Preamp Factor
Margin value = Emission level – Limit value
- 2412 MHz: Fundamental frequency.

EUT Test Condition		Measurement Detail	
Channel	Channel 6	Frequency Range	1 GHz ~ 25 GHz
Input Power	120 Vac, 60 Hz	Detector Function	Peak (PK) Average (AV)
Environmental Conditions	25 deg. C, 65 % RH	Tested By	Greg Lin

Antennal Polarity & Test Distance: Horizontal at 3 m										
Frequency (MHz)	Emission Level (dBuV/m)	Read Level (dBuV)	Limit (dBuV/m)	Margin (dB)	Antenna Factor (dB/m)	Cable Loss (dB)	Preamp Factor (dB)	Antenna Height (cm)	Table Angle (Degree)	Remark
2388	43.06	41.35	54	-10.94	31.8	5.4	35.49	112	154	Average
2388	55.86	54.15	74	-18.14	31.8	5.4	35.49	112	154	Peak
2437	105.9	104.05			31.85	5.46	35.46	112	154	Average
2437	112.79	110.94			31.85	5.46	35.46	112	154	Peak
2500	44.29	42.27	54	-9.71	31.9	5.53	35.41	112	154	Average
2500	58.7	56.68	74	-15.3	31.9	5.53	35.41	112	154	Peak
Antennal Polarity & Test Distance: Vertical at 3 m										
Frequency (MHz)	Emission Level (dBuV/m)	Read Level (dBuV)	Limit (dBuV/m)	Margin (dB)	Antenna Factor (dB/m)	Cable Loss (dB)	Preamp Factor (dB)	Antenna Height (cm)	Table Angle (Degree)	Remark
2390	43.09	41.36	54	-10.91	31.8	5.4	35.47	104	186	Average
2390	57.76	56.03	74	-16.24	31.8	5.4	35.47	104	186	Peak
2437	105.67	103.82			31.85	5.46	35.46	104	186	Average
2437	113.41	111.56			31.85	5.46	35.46	104	186	Peak
2500	44	41.98	54	-10	31.9	5.53	35.41	104	186	Average
2500	57.9	55.88	74	-16.1	31.9	5.53	35.41	104	186	Peak

Remarks:

- Emission Level = Read Level + Antenna Factor + Cable Loss - Preamp Factor
Margin value = Emission level – Limit value
- 2437 MHz: Fundamental frequency.

EUT Test Condition		Measurement Detail	
Channel	Channel 11	Frequency Range	1 GHz ~ 25 GHz
Input Power	120 Vac, 60 Hz	Detector Function	Peak (PK) Average (AV)
Environmental Conditions	25 deg. C, 65 % RH	Tested By	Greg Lin

Antennal Polarity & Test Distance: Horizontal at 3 m										
Frequency (MHz)	Emission Level (dBuV/m)	Read Level (dBuV)	Limit (dBuV/m)	Margin (dB)	Antenna Factor (dB/m)	Cable Loss (dB)	Preamp Factor (dB)	Antenna Height (cm)	Table Angle (Degree)	Remark
2384	42.73	41.04	54	-11.27	31.78	5.4	35.49	111	191	Average
2384	55.57	53.88	74	-18.43	31.78	5.4	35.49	111	191	Peak
2462	105.93	104			31.87	5.5	35.44	111	191	Average
2462	112.02	110.09			31.87	5.5	35.44	111	191	Peak
2483.5	52.07	50.11	54	-1.93	31.88	5.5	35.42	112	178	Average
2483.5	68.2	66.24	74	-5.8	31.88	5.5	35.42	112	178	Peak

Antennal Polarity & Test Distance: Vertical at 3 m										
Frequency (MHz)	Emission Level (dBuV/m)	Read Level (dBuV)	Limit (dBuV/m)	Margin (dB)	Antenna Factor (dB/m)	Cable Loss (dB)	Preamp Factor (dB)	Antenna Height (cm)	Table Angle (Degree)	Remark
2390	46.06	44.33	54	-7.94	31.8	5.4	35.47	105	182	Average
2390	58.47	56.74	74	-15.53	31.8	5.4	35.47	105	182	Peak
2462	105.48	103.55			31.87	5.5	35.44	105	182	Average
2462	113.89	111.96			31.87	5.5	35.44	105	182	Peak
2483.5	52.07	50.11	54	-1.93	31.88	5.5	35.42	125	170	Average
2483.5	70.53	68.57	74	-3.47	31.88	5.5	35.42	125	170	Peak

Remarks:

- Emission Level = Read Level + Antenna Factor + Cable Loss - Preamp Factor
Margin value = Emission level – Limit value
- 2462 MHz: Fundamental frequency.

802.11n (HT40)

EUT Test Condition		Measurement Detail	
Channel	Channel 3	Frequency Range	1 GHz ~ 25 GHz
Input Power	120 Vac, 60 Hz	Detector Function	Peak (PK) Average (AV)
Environmental Conditions	25 deg. C, 65 % RH	Tested By	Greg Lin

Antennal Polarity & Test Distance: Horizontal at 3 m

Frequency (MHz)	Emission Level (dBuV/m)	Read Level (dBuV)	Limit (dBuV/m)	Margin (dB)	Antenna Factor (dB/m)	Cable Loss (dB)	Preamp Factor (dB)	Antenna Height (cm)	Table Angle (Degree)	Remark
2388	50.32	48.61	54	-3.68	31.8	5.4	35.49	114	168	Average
2388	64.24	62.53	74	-9.76	31.8	5.4	35.49	114	168	Peak
2422	100.12	98.32			31.83	5.43	35.46	114	168	Average
2422	107.02	105.22			31.83	5.43	35.46	114	168	Peak
2500	46.29	44.27	54	-7.71	31.9	5.53	35.41	114	168	Average
2500	58.8	56.78	74	-15.2	31.9	5.53	35.41	114	168	Peak

Antennal Polarity & Test Distance: Vertical at 3 m

Frequency (MHz)	Emission Level (dBuV/m)	Read Level (dBuV)	Limit (dBuV/m)	Margin (dB)	Antenna Factor (dB/m)	Cable Loss (dB)	Preamp Factor (dB)	Antenna Height (cm)	Table Angle (Degree)	Remark
2390	52.18	50.45	54	-1.82	31.8	5.4	35.47	108	213	Average
2390	67.35	65.62	74	-6.65	31.8	5.4	35.47	108	213	Peak
2422	100.83	99.03			31.83	5.43	35.46	107	184	Average
2422	108.36	106.56			31.83	5.43	35.46	107	184	Peak
2500	43	40.98	54	-11	31.9	5.53	35.41	107	184	Average
2500	58.92	56.9	74	-15.08	31.9	5.53	35.41	107	184	Peak

Remarks:

- Emission Level = Read Level + Antenna Factor + Cable Loss - Preamp Factor
Margin value = Emission level – Limit value
- 2422 MHz: Fundamental frequency.

EUT Test Condition		Measurement Detail	
Channel	Channel 6	Frequency Range	1 GHz ~ 25 GHz
Input Power	120 Vac, 60 Hz	Detector Function	Peak (PK) Average (AV)
Environmental Conditions	25 deg. C, 65 % RH	Tested By	Greg Lin

Antennal Polarity & Test Distance: Horizontal at 3 m										
Frequency (MHz)	Emission Level (dBuV/m)	Read Level (dBuV)	Limit (dBuV/m)	Margin (dB)	Antenna Factor (dB/m)	Cable Loss (dB)	Preamp Factor (dB)	Antenna Height (cm)	Table Angle (Degree)	Remark
2390	46.06	44.33	54	-7.94	31.8	5.4	35.47	111	155	Average
2390	57.1	55.37	74	-16.9	31.8	5.4	35.47	111	155	Peak
2437	100.88	99.03			31.85	5.46	35.46	111	155	Average
2437	109.11	107.26			31.85	5.46	35.46	111	155	Peak
2486	51.27	49.28	54	-2.73	31.88	5.53	35.42	111	155	Average
2486	63.47	61.48	74	-10.53	31.88	5.53	35.42	111	155	Peak
Antennal Polarity & Test Distance: Vertical at 3 m										
Frequency (MHz)	Emission Level (dBuV/m)	Read Level (dBuV)	Limit (dBuV/m)	Margin (dB)	Antenna Factor (dB/m)	Cable Loss (dB)	Preamp Factor (dB)	Antenna Height (cm)	Table Angle (Degree)	Remark
2390	45.77	44.04	54	-8.23	31.8	5.4	35.47	104	184	Average
2390	61.75	60.02	74	-12.25	31.8	5.4	35.47	104	184	Peak
2437	101.47	99.62			31.85	5.46	35.46	104	184	Average
2437	110.08	108.23			31.85	5.46	35.46	104	184	Peak
2483.5	53.06	51.1	54	-0.94	31.88	5.5	35.42	110	178	Average
2483.5	64.11	62.15	74	-9.89	31.88	5.5	35.42	110	178	Peak

Remarks:

- Emission Level = Read Level + Antenna Factor + Cable Loss - Preamp Factor
Margin value = Emission level – Limit value
- 2437 MHz: Fundamental frequency.

EUT Test Condition		Measurement Detail	
Channel	Channel 9	Frequency Range	1 GHz ~ 25 GHz
Input Power	120 Vac, 60 Hz	Detector Function	Peak (PK) Average (AV)
Environmental Conditions	25 deg. C, 65 % RH	Tested By	Greg Lin

Antennal Polarity & Test Distance: Horizontal at 3 m										
Frequency (MHz)	Emission Level (dBuV/m)	Read Level (dBuV)	Limit (dBuV/m)	Margin (dB)	Antenna Factor (dB/m)	Cable Loss (dB)	Preamp Factor (dB)	Antenna Height (cm)	Table Angle (Degree)	Remark
2390	41.72	39.99	54	-12.28	31.8	5.4	35.47	111	155	Average
2390	55.6	53.87	74	-18.4	31.8	5.4	35.47	111	155	Peak
2452	97.84	95.97			31.85	5.46	35.44	111	155	Average
2452	106.29	104.42			31.85	5.46	35.44	111	155	Peak
2483.5	50.95	48.99	54	-3.05	31.88	5.5	35.42	111	155	Average
2483.5	66.55	64.59	74	-7.45	31.88	5.5	35.42	111	155	Peak

Antennal Polarity & Test Distance: Vertical at 3 m										
Frequency (MHz)	Emission Level (dBuV/m)	Read Level (dBuV)	Limit (dBuV/m)	Margin (dB)	Antenna Factor (dB/m)	Cable Loss (dB)	Preamp Factor (dB)	Antenna Height (cm)	Table Angle (Degree)	Remark
2384	43.04	41.35	54	-10.96	31.78	5.4	35.49	104	184	Average
2384	59.7	58.01	74	-14.3	31.78	5.4	35.49	104	184	Peak
2452	99.88	98.01			31.85	5.46	35.44	104	184	Average
2452	107.54	105.67			31.85	5.46	35.44	104	184	Peak
2483.5	52.74	50.78	54	-1.26	31.88	5.5	35.42	106	183	Average
2483.5	69.39	67.43	74	-4.61	31.88	5.5	35.42	106	183	Peak

Remarks:

- Emission Level = Read Level + Antenna Factor + Cable Loss - Preamp Factor
Margin value = Emission level – Limit value
- 2452 MHz: Fundamental frequency.

Co-location:

802.11n (40MHz) + 802.11ac (80MHz)

EUT Test Condition		Measurement Detail	
Channel	Channel 6 + Channel 42	Frequency Range	1 GHz ~ 25 GHz
Input Power	120 Vac, 60 Hz	Detector Function	Peak (PK) Average (AV)
Environmental Conditions	25 deg. C, 65 % RH	Tested By	Greg Lin

Antennal Polarity & Test Distance: Horizontal at 3 m

Frequency (MHz)	Emission Level (dBuV/m)	Read Level (dBuV)	Limit (dBuV/m)	Margin (dB)	Antenna Factor (dB/m)	Cable Loss (dB)	Preamp Factor (dB)	Antenna Height (cm)	Table Angle (Degree)	Remark
2388	45.85	52.9	54	-8.15	26.91	3.54	37.5	100	198	Average
2388	65.2	72.25	74	-8.8	26.91	3.54	37.5	100	198	Peak
2437	99.72	106.56			27.06	3.56	37.46	100	198	Average
2437	108.44	115.28			27.06	3.56	37.46	100	198	Peak
2488	49.54	56.04	54	-4.46	27.2	3.62	37.32	100	198	Average
2488	62.84	69.34	74	-11.16	27.2	3.62	37.32	100	198	Peak
5150	49.3	50.01	54	-4.7	31.32	5.29	37.32	100	205	Average
5150	64.44	65.15	74	-9.56	31.32	5.29	37.32	100	205	Peak
5210	87.83	88.5			31.37	5.32	37.36	100	205	Average
5210	98.07	98.74			31.37	5.32	37.36	100	205	Peak
5386	38.93	39.2	54	-15.07	31.51	5.4	37.18	100	205	Average
5386	60.25	60.52	74	-13.75	31.51	5.4	37.18	100	205	Peak

Antennal Polarity & Test Distance: Vertical at 3 m

Frequency (MHz)	Emission Level (dBuV/m)	Read Level (dBuV)	Limit (dBuV/m)	Margin (dB)	Antenna Factor (dB/m)	Cable Loss (dB)	Preamp Factor (dB)	Antenna Height (cm)	Table Angle (Degree)	Remark
2390	46.11	53.18	54	-7.89	26.91	3.54	37.52	105	196	Average
2390	61.05	68.12	74	-12.95	26.91	3.54	37.52	105	196	Peak
2437	100.09	106.93			27.06	3.56	37.46	105	196	Average
2437	109.56	116.4			27.06	3.56	37.46	105	196	Peak
2486	52.16	58.73	54	-1.84	27.15	3.6	37.32	105	196	Average
2486	62.67	69.24	74	-11.33	27.15	3.6	37.32	105	196	Peak
5150	51.39	52.1	54	-2.61	31.32	5.29	37.32	121	164	Average
5150	61.42	62.13	74	-12.58	31.32	5.29	37.32	121	164	Peak
5210	89.22	89.89			31.37	5.32	37.36	121	164	Average
5210	99.08	99.75			31.37	5.32	37.36	121	164	Peak
5400	39.25	39.5	54	-14.75	31.52	5.41	37.18	121	164	Average
5400	59.49	59.74	74	-14.51	31.52	5.41	37.18	121	164	Peak

Remarks:

- Emission Level = Read Level + Antenna Factor + Cable Loss - Preamp Factor
Margin value = Emission level – Limit value
- 2437 MHz & 5210 MHz: Fundamental frequency.

9 kHz ~ 30 MHz Data:

The amplitude of spurious emissions attenuated more than 20 dB below the permissible value is not required to be report.

30 MHz ~ 1 GHz Worst-Case Data:

802.11n (HT40)

EUT Test Condition		Measurement Detail	
Channel	Channel 6	Frequency Range	30 MHz ~ 1 GHz
Input Power	120 Vac, 60 Hz	Detector Function	Peak (PK) Quasi-peak (QP)
Environmental Conditions	25 deg. C, 65 % RH	Tested By	Greg Lin

Antennal Polarity & Test Distance: Horizontal at 3 m										
Frequency (MHz)	Emission Level (dBuV/m)	Read Level (dBuV)	Limit (dBuV/m)	Margin (dB)	Antenna Factor (dB/m)	Cable Loss (dB)	Preamp Factor (dB)	Antenna Height (cm)	Table Angle (Degree)	Remark
95.88	31.35	52.73	43.5	-12.15	9.38	1.28	32.04	132	111	Peak
163.11	33.91	54.07	43.5	-9.59	10.58	1.52	32.26	127	165	Peak
224.94	33.07	51.52	46	-12.93	11.9	1.85	32.2	102	37	Peak
374.9	37.98	51.57	46	-8.02	16.3	2.26	32.15	189	32	Peak
599.6	37.41	45.63	46	-8.59	21.1	2.87	32.19	153	138	Peak
875.4	31.22	34.56	46	-14.78	24.8	3.49	31.63	155	74	Peak

Antennal Polarity & Test Distance: Vertical at 3 m										
Frequency (MHz)	Emission Level (dBuV/m)	Read Level (dBuV)	Limit (dBuV/m)	Margin (dB)	Antenna Factor (dB/m)	Cable Loss (dB)	Preamp Factor (dB)	Antenna Height (cm)	Table Angle (Degree)	Remark
44.31	27.63	49.27	40	-12.37	9.68	0.9	32.22	187	94	Peak
94.26	32.16	53.72	43.5	-11.34	9.26	1.11	31.93	163	187	Peak
166.62	35.11	55.55	43.5	-8.39	10.29	1.52	32.25	177	21	Peak
374.9	31.54	45.13	46	-14.46	16.3	2.26	32.15	128	71	Peak
599.6	34.61	42.83	46	-11.39	21.1	2.87	32.19	145	113	Peak
870.5	35.99	39.62	46	-10.01	24.6	3.44	31.67	201	89	Peak

Remarks:

1. Emission Level = Read Level + Antenna Factor + Cable Loss - Preamp Factor

Margin value = Emission level – Limit value

4.2 Conducted Emission Measurement

4.2.1 Limits of Conducted Emission Measurement

Frequency (MHz)	Conducted Limit (dBuV)	
	Quasi-peak	Average
0.15 - 0.5	66 - 56	56 - 46
0.50 - 5.0	56	46
5.0 - 30.0	60	50

- Note: 1. The lower limit shall apply at the transition frequencies.
 2. The limit decreases in line with the logarithm of the frequency in the range of 0.15 to 0.50 MHz.

4.2.2 Test Instruments

Description & Manufacturer	Model No.	Serial No.	Date of Calibration	Due Date of Calibration
Test Receiver ROHDE & SCHWARZ	ESCS 30	100288	Aug. 17, 2017	Aug. 16, 2018
RF signal cable (with 10dB PAD) Woken	5D-FB	Cable-cond2-01	Sep. 08, 2017	Sep. 07, 2018
LISN/AMN ROHDE & SCHWARZ (EUT)	ESH2-Z5	100100	Jan. 17, 2017	Jan. 16, 2018
LISN/AMN ROHDE & SCHWARZ (Peripheral)	ESH3-Z5	100312	Aug. 02, 2017	Aug. 01, 2018
Software ADT	BV ADT_Cond_ V7.3.7.3	NA	NA	NA

- Note: 1. The calibration interval of the above test instruments is 12 months and the calibrations are traceable to NML/ROC and NIST/USA.
 2. The test was performed in HwaYa Shielded Room 2.
 3. The VCCI Site Registration No. is C-2047.

4.2.3 Test Procedures

- a. The EUT was placed 0.4 meters from the conducting wall of the shielded room with EUT being connected to the power mains through a line impedance stabilization network (LISN). Other support units were connected to the power mains through another LISN. The two LISNs provide 50 ohm/50 uH of coupling impedance for the measuring instrument.
- b. Both lines of the power mains connected to the EUT were checked for maximum conducted interference.
- c. The frequency range from 150 kHz to 30 MHz was searched. Emission levels under (Limit – 20 dB) was not recorded.

NOTE: All modes of operation were investigated and the worst-case emissions are reported.

4.2.4 Deviation from Test Standard

No deviation.

4.2.5 Test Setup

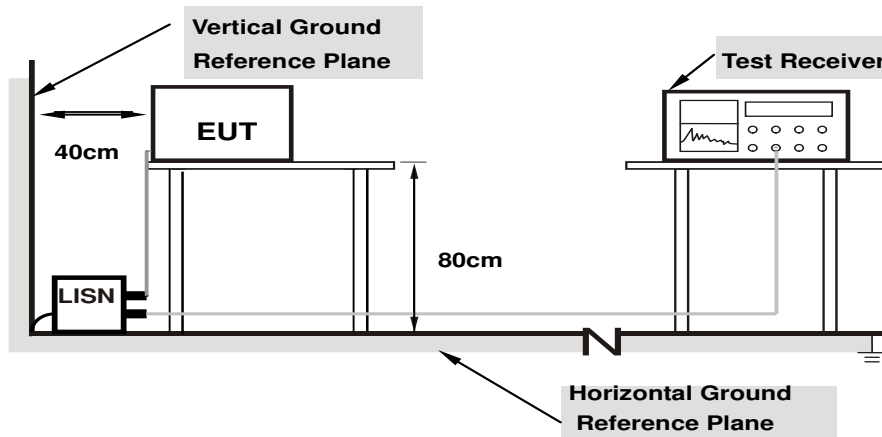

Note: 1.Support units were connected to second LISN.

For the actual test configuration, please refer to the attached file (Test Setup Photo).

4.2.6 EUT Operating Conditions

- a. Placed the EUT on a testing table.
- b. Use the software to control the EUT under transmission condition continuously at specific channel frequency.

4.2.7 Test Results

Frequency Range	150kHz ~ 30MHz	Detector Function & Resolution Bandwidth	Quasi-Peak (QP), 9kHz Average (AV), 9kHz
Input Power	120Vac, 60Hz	Environmental Conditions	25°C, 65%RH
POWER SUPPLY	Adapter		

Phase Of Power : Line (L)										
No	Frequency (MHz)	Correction Factor (dB)	Reading Value (dBuV)		Emission Level (dBuV)		Limit (dBuV)		Margin (dB)	
			Q.P.	AV.	Q.P.	AV.	Q.P.	AV.	Q.P.	AV.
1	0.18125	0.27	47.58	42.52	47.85	42.79	64.43	54.43	-16.57	-11.63
2	0.32188	0.29	43.36	31.03	43.65	31.32	59.66	49.66	-16.01	-18.34
3	0.46641	0.30	46.33	33.21	46.63	33.51	56.58	46.58	-9.94	-13.06
4	0.92344	0.33	38.00	26.25	38.33	26.58	56.00	46.00	-17.67	-19.42
5	1.38281	0.35	37.32	28.61	37.67	28.96	56.00	46.00	-18.33	-17.04
6	14.30078	0.53	25.75	19.81	26.28	20.34	60.00	50.00	-33.72	-29.66

Remarks:

1. Q.P. and AV. are abbreviations of quasi-peak and average individually.
2. The emission levels of other frequencies were very low against the limit.
3. Margin value = Emission level – Limit value
4. Correction factor = Insertion loss + Cable loss
5. Emission Level = Correction Factor + Reading Value

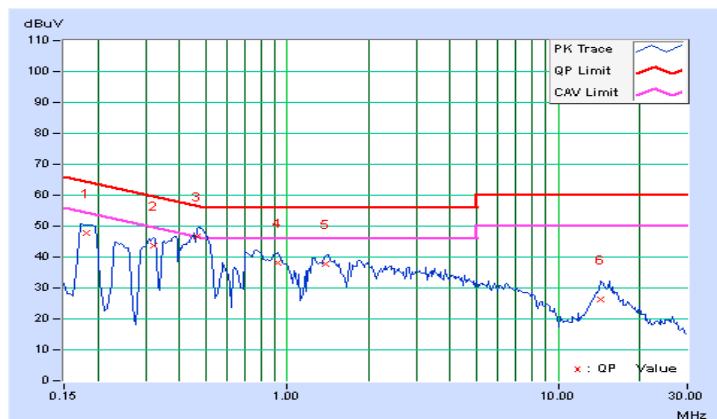

Frequency Range	150kHz ~ 30MHz	Detector Function & Resolution Bandwidth	Quasi-Peak (QP), 9kHz Average (AV), 9kHz
Input Power	120Vac, 60Hz	Environmental Conditions	25°C, 65%RH
POWER SUPPLY	Adapter		

Phase Of Power : Neutral (N)										
No	Frequency (MHz)	Correction Factor (dB)	Reading Value (dBuV)		Emission Level (dBuV)		Limit (dBuV)		Margin (dB)	
			Q.P.	AV.	Q.P.	AV.	Q.P.	AV.	Q.P.	AV.
1	0.18125	0.27	45.63	39.91	45.90	40.18	64.43	54.43	-18.52	-14.24
2	0.47422	0.30	47.88	37.43	48.18	37.73	56.44	46.44	-8.25	-8.70
3	0.77109	0.32	39.11	29.60	39.43	29.92	56.00	46.00	-16.57	-16.08
4	1.39844	0.35	35.42	27.64	35.77	27.99	56.00	46.00	-20.23	-18.01
5	5.99609	0.47	25.44	20.97	25.91	21.44	60.00	50.00	-34.09	-28.56
6	15.00391	0.57	25.79	18.49	26.36	19.06	60.00	50.00	-33.64	-30.94

Remarks:

1. Q.P. and AV. are abbreviations of quasi-peak and average individually.
2. The emission levels of other frequencies were very low against the limit.
3. Margin value = Emission level – Limit value
4. Correction factor = Insertion loss + Cable loss
5. Emission Level = Correction Factor + Reading Value

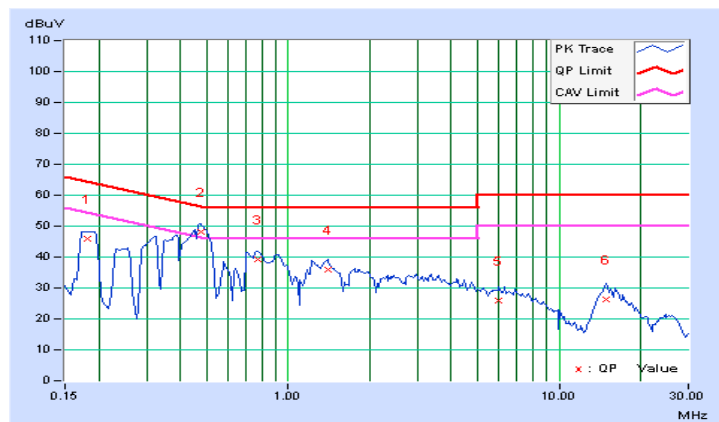

4.3 6 dB Bandwidth Measurement

4.3.1 Limits of 6 dB Bandwidth Measurement

The minimum of 6 dB Bandwidth Measurement is 0.5 MHz.

4.3.2 Test Setup

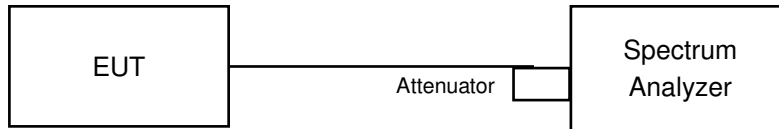

4.3.3 Test Instruments

Refer to section 4.1.2 to get information of above instrument.

4.3.4 Test Procedure

- Set resolution bandwidth (RBW) = 100 kHz
- Set the video bandwidth (VBW) $\geq 3 \times$ RBW, Detector = Peak.
- Trace mode = max hold.
- Sweep = auto couple.
- Measure the maximum width of the emission that is constrained by the frequencies associated with the two amplitude points (upper and lower) that are attenuated by 6 dB relative to the maximum level measured in the fundamental emission

4.3.5 Deviation from Test Standard

No deviation.

4.3.6 EUT Operating Conditions

The software provided by client to enable the EUT under transmission condition continuously at lowest, middle and highest channel frequencies individually.

4.3.7 Test Result

802.11b

Channel	Frequency (MHz)	6 dB Bandwidth (MHz)	Minimum Limit (MHz)	Pass / Fail
1	2412	6.54	0.5	Pass
6	2437	6.06	0.5	Pass
11	2462	6.06	0.5	Pass

802.11g

Channel	Frequency (MHz)	6 dB Bandwidth (MHz)	Minimum Limit (MHz)	Pass / Fail
1	2412	16.39	0.5	Pass
6	2437	16.43	0.5	Pass
11	2462	16.39	0.5	Pass

802.11n (HT20)

Channel	Frequency (MHz)	6 dB Bandwidth (MHz)			Minimum Limit (MHz)	Pass / Fail
		Chain 0	Chain 1	Chain 2		
1	2412	17.63	17.35	17.61	0.5	Pass
6	2437	17.63	17.63	17.65	0.5	Pass
11	2462	17.62	17.60	17.62	0.5	Pass

802.11n (HT40)

Channel	Frequency (MHz)	6 dB Bandwidth (MHz)			Minimum Limit (MHz)	Pass / Fail
		Chain 0	Chain 1	Chain 2		
3	2422	36.42	36.36	36.36	0.5	Pass
6	2437	36.40	36.12	36.38	0.5	Pass
9	2452	36.34	36.37	36.11	0.5	Pass

Spectrum Plot of Worst Value

802.11b

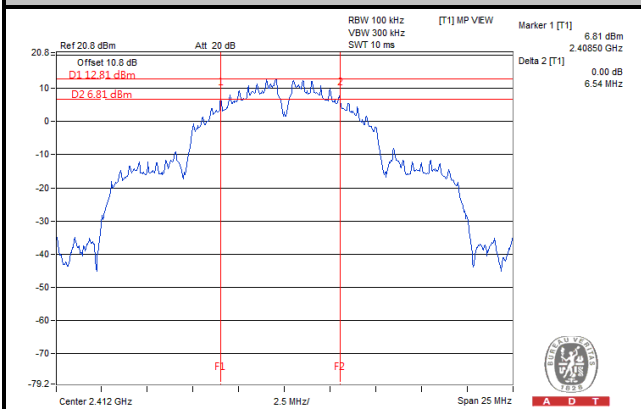

802.11g

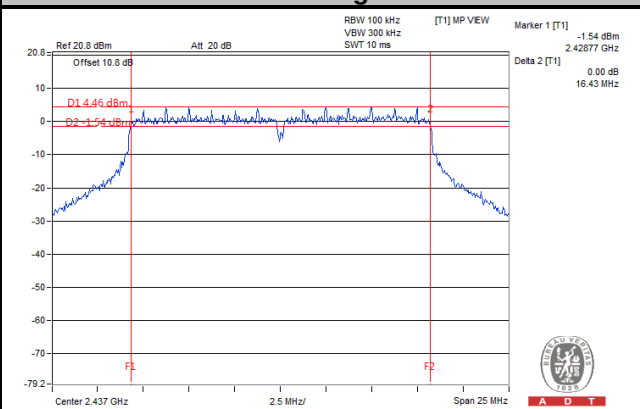

802.11n (HT20)

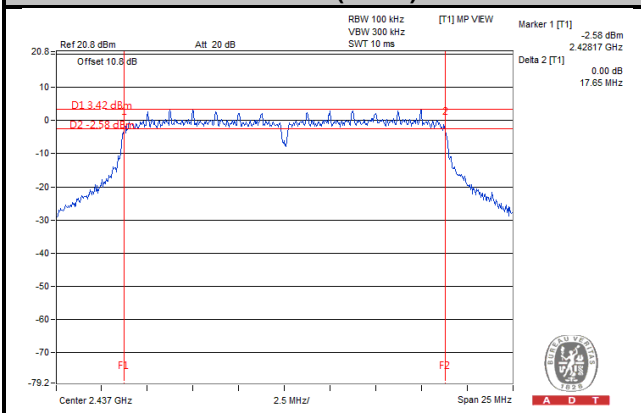

802.11n (HT40)

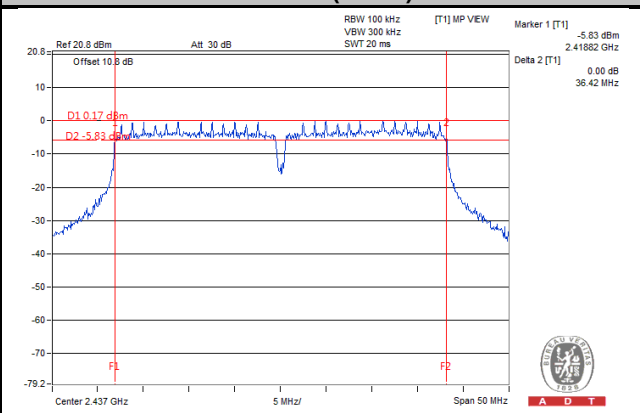

4.4 Occupied Bandwidth Measurement

4.4.1 Test Setup

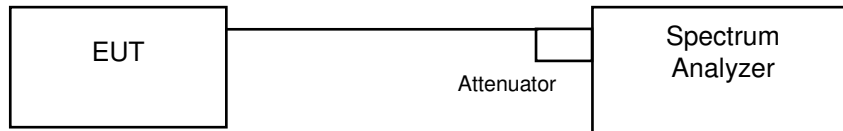

4.4.2 Test Instruments

Refer to section 4.1.2 to get information of above instrument.

4.4.3 Test Procedure

The transmitter output was connected to the spectrum analyzer through an attenuator. The bandwidth of the fundamental frequency was measured by spectrum analyzer with resolution bandwidth in the range of 1 % to 5 % of the anticipated emission bandwidth, and a video bandwidth at least 3x the resolution bandwidth and set the detector to PEAK. The width of a frequency band such that, below the lower and above the upper frequency limits, the mean powers emitted are each equal to a specified percentage 0.5 % of the total mean power of a given emission.

4.4.4 Deviation from Test Standard

No deviation.

4.4.5 EUT Operating Conditions

The software provided by client to enable the EUT under transmission condition continuously at lowest, middle and highest channel frequencies individually.

4.4.6 Test Results

802.11b

Channel	Frequency (MHz)	Occupied Bandwidth (MHz)	Pass / Fail
1	2412	10.10	Pass
6	2437	10.20	Pass
11	2462	10.20	Pass

802.11g

Channel	Frequency (MHz)	Occupied Bandwidth (MHz)	Pass / Fail
1	2412	17.12	Pass
6	2437	17.10	Pass
11	2462	17.10	Pass

802.11n (HT20)

Channel	Frequency (MHz)	Occupied Bandwidth (MHz)			Pass / Fail
		Chain 0	Chain 1	Chain 2	
1	2412	18.08	17.98	18.08	Pass
6	2437	18.10	18.00	18.10	Pass
11	2462	18.10	18.20	18.00	Pass

802.11n (HT40)

Channel	Frequency (MHz)	Occupied Bandwidth (MHz)			Pass / Fail
		Chain 0	Chain 1	Chain 2	
3	2422	37.34	37.17	37.17	Pass
6	2437	37.33	37.17	37.17	Pass
9	2452	37.17	37.17	37.00	Pass

Spectrum Plot of Worst Value

802.11b

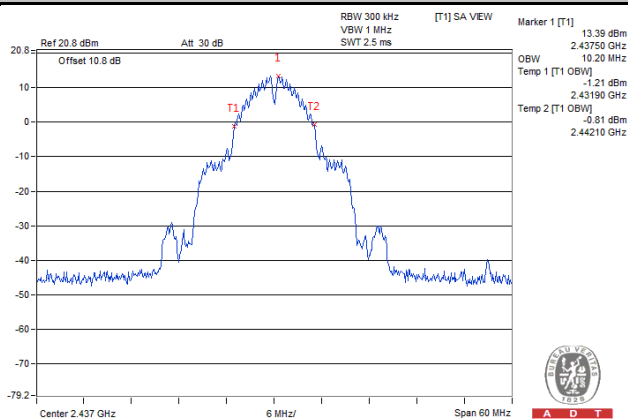

802.11g

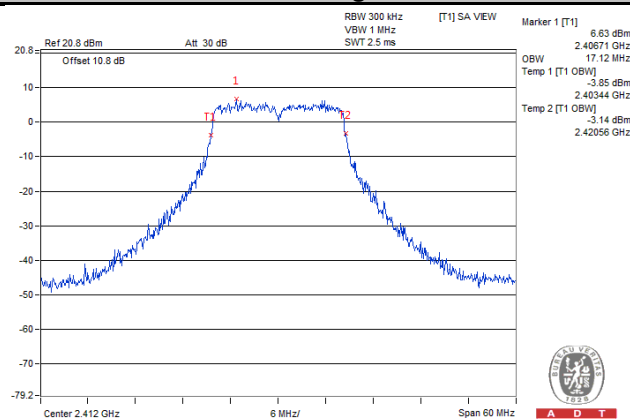

802.11n (HT20)

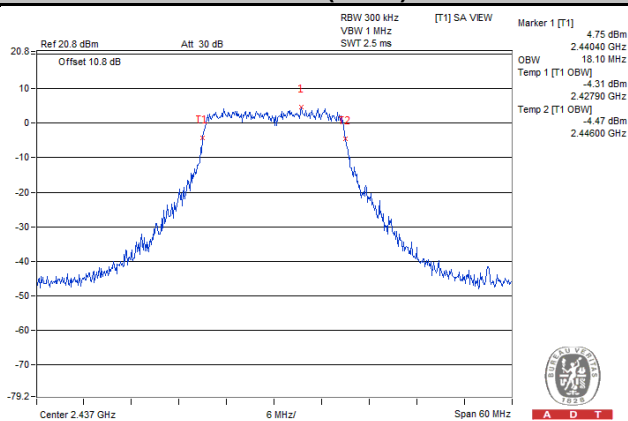

802.11n (HT40)

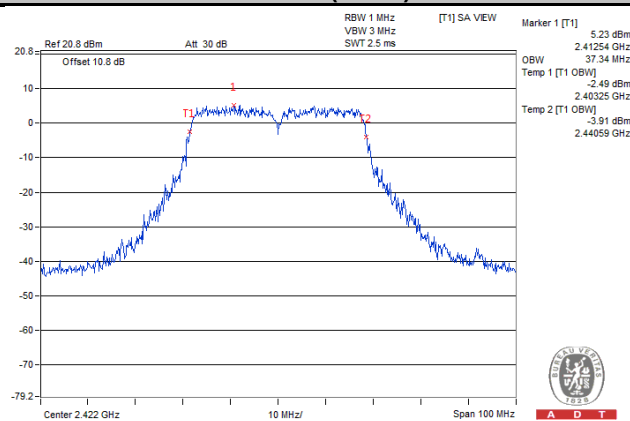

4.5 Conducted Output Power Measurement

4.5.1 Limits of Conducted Output Power Measurement

For systems using digital modulation in the 2400–2483.5 MHz bands: 1 Watt (30 dBm)

Per KDB 662911 D01 Multiple Transmitter Output Method of conducted output power measurement on IEEE 802.11 devices,

Array Gain = 0 dB (i.e., no array gain) for $NANT \leq 4$;

Array Gain = 0 dB (i.e., no array gain) for channel widths ≥ 40 MHz for any NANT;

Array Gain = $5 \log(NANT/NSS)$ dB or 3 dB, whichever is less for 20 MHz channel widths with $NANT \geq 5$.

For power measurements on all other devices: Array Gain = $10 \log(NANT/NSS)$ dB.

4.5.2 Test Setup

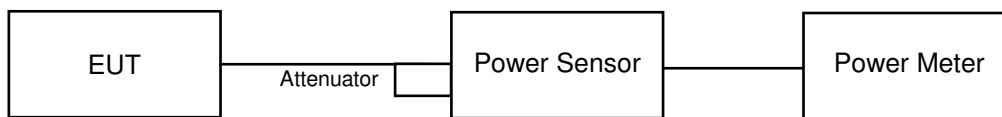

4.5.3 Test Instruments

Refer to section 4.1.2 to get information of above instrument.

4.5.4 Test Procedures

A peak power sensor was used on the output port of the EUT. A power meter was used to read the response of the peak power sensor. Record the power level.

4.5.5 Deviation from Test Standard

No deviation.

4.5.6 EUT Operating Conditions

The software provided by client to enable the EUT under transmission condition continuously at lowest, middle and highest channel frequencies individually.

4.5.7 Test Results

802.11b

Channel	Frequency (MHz)	Peak Power (mW)	Peak Power (dBm)	Limit (dBm)	Pass / Fail
1	2412	244.91	23.89	30	Pass
6	2437	251.77	24.01	30	Pass
11	2462	248.31	23.95	30	Pass

802.11g

Channel	Frequency (MHz)	Peak Power (mW)	Peak Power (dBm)	Limit (dBm)	Pass / Fail
1	2412	408.32	26.11	30	Pass
6	2437	452.90	26.56	30	Pass
11	2462	427.56	26.31	30	Pass

802.11n (HT20)

Channel	Frequency (MHz)	Peak Power (dBm)			Total Power (mW)	Total Power (dBm)	Limit (dBm)	Pass / Fail
		Chain 0	Chain 1	Chain 2				
1	2412	24.78	22.73	23.55	714.572	28.54	30	Pass
6	2437	24.83	22.65	23.97	737.625	28.68	30	Pass
11	2462	24.61	22.86	23.73	718.313	28.56	30	Pass

802.11n (HT40)

Channel	Frequency (MHz)	Peak Power (dBm)			Total Power (mW)	Total Power (dBm)	Limit (dBm)	Pass / Fail
		Chain 0	Chain 1	Chain 2				
3	2422	23.12	22.09	21.41	505.281	27.04	30	Pass
6	2437	24.19	22.57	23.02	643.586	28.09	30	Pass
9	2452	23.21	21.19	21.45	480.571	26.82	30	Pass

4.6 Power Spectral Density Measurement

4.6.1 Limits of Power Spectral Density Measurement

The Maximum of Power Spectral Density Measurement is 8 dBm.

4.6.2 Test Setup

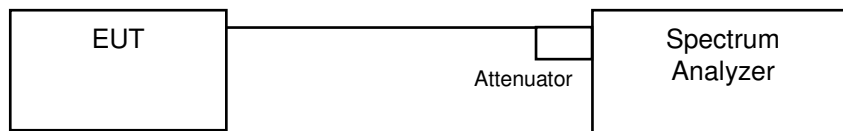

4.6.3 Test Instruments

Refer to section 4.1.2 to get information of above instrument.

4.6.4 Test Procedure

- a. Set analyzer center frequency to DTS channel center frequency.
- b. Set the span to 1.5 times the DTS bandwidth.
- c. Set the RBW to: $3 \text{ kHz} \leq \text{RBW} \leq 100 \text{ kHz}$.
- d. Set the VBW $\geq 3 \times \text{RBW}$.
- e. Detector = peak.
- f. Sweep time = auto couple.
- g. Trace mode = max hold.
- h. Allow trace to fully stabilize.
- i. Use the peak marker function to determine the maximum amplitude level within the RBW.

4.6.5 Deviation from Test Standard

No deviation.

4.6.6 EUT Operating Condition

The software provided by client to enable the EUT under transmission condition continuously at lowest, middle and highest channel frequencies individually.

4.6.7 Test Results

802.11b

Channel	Frequency (MHz)	PSD (dBm/3 kHz)	Limit (dBm/3 kHz)	Pass / Fail
1	2412	-1.72	8	Pass
6	2437	-1.10	8	Pass
11	2462	-2.00	8	Pass

802.11g

Channel	Frequency (MHz)	PSD (dBm/3 kHz)	Limit (dBm/3 kHz)	Pass / Fail
1	2412	-10.92	8	Pass
6	2437	-9.82	8	Pass
11	2462	-9.01	8	Pass

802.11n (HT20)

TX Chain	Channel	Freq. (MHz)	PSD (dBm/3 kHz)	10 log (N=3) dB	Total PSD (dBm/3 kHz)	Limit (dBm/3 kHz)	Pass / Fail
0	1	2412	-12.38	4.77	-7.61	6.42	Pass
	6	2437	-12.36	4.77	-7.59	6.42	Pass
	11	2462	-12.33	4.77	-7.56	6.42	Pass
1	1	2412	-13.98	4.77	-9.21	6.42	Pass
	6	2437	-15.14	4.77	-10.37	6.42	Pass
	11	2462	-14.64	4.77	-9.87	6.42	Pass
2	1	2412	-13.82	4.77	-9.05	6.42	Pass
	6	2437	-14.30	4.77	-9.53	6.42	Pass
	11	2462	-13.08	4.77	-8.31	6.42	Pass

NOTE: Directional gain = $10 \log[(10^{G1/20} + 10^{G2/20} + \dots + 10^{GN/20})^2 / N_{ANT}] = 7.58 \text{dBi} > 6 \text{dBi}$, so the power density limit shall be reduced to $8 - (7.58 - 6) = 6.42 \text{dBm}$.

802.11n (HT40)

TX Chain	Channel	Freq. (MHz)	PSD (dBm/3 kHz)	10 log (N=3) dB	Total PSD (dBm/3 kHz)	Limit (dBm/3 kHz)	Pass / Fail
0	3	2422	-17.22	4.77	-12.45	6.42	Pass
	6	2437	-15.02	4.77	-10.25	6.42	Pass
	9	2452	-14.38	4.77	-9.61	6.42	Pass
1	3	2422	-17.86	4.77	-13.09	6.42	Pass
	6	2437	-15.63	4.77	-10.86	6.42	Pass
	9	2452	-16.46	4.77	-11.69	6.42	Pass
2	3	2422	-17.30	4.77	-12.53	6.42	Pass
	6	2437	-14.73	4.77	-9.96	6.42	Pass
	9	2452	-16.93	4.77	-12.16	6.42	Pass

NOTE: Directional gain = $10 \log[(10^{G1/20} + 10^{G2/20} + \dots + 10^{GN/20})^2 / N_{ANT}] = 7.58 \text{dBi} > 6 \text{dBi}$, so the power density limit shall be reduced to $8 - (7.58 - 6) = 6.42 \text{dBm}$.

Spectrum Plot of Worst Value

802.11b

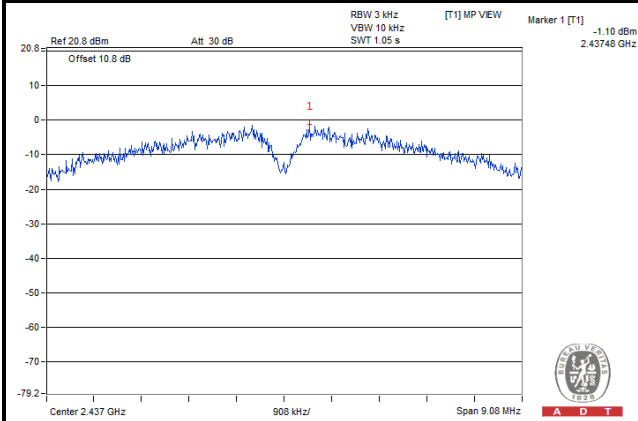

802.11g

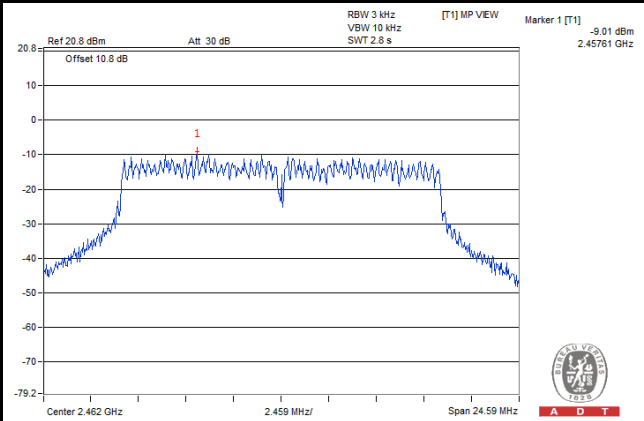

802.11n (HT20)

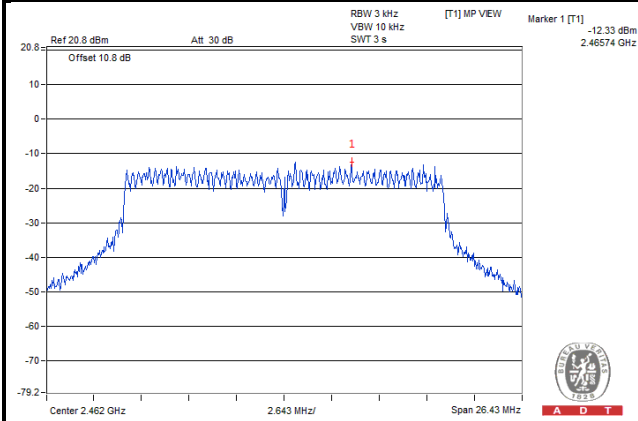

802.11n (HT40)

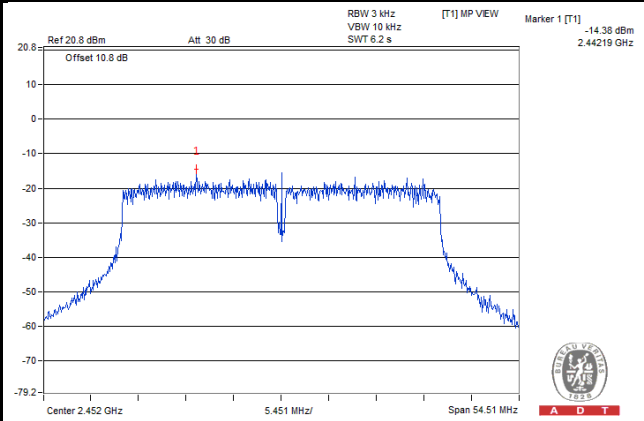

4.7 Conducted Out of Band Emission Measurement

4.7.1 Limits of Conducted Out of Band Emission Measurement

Below 20 dB of the highest emission level of operating band (in 100 kHz Resolution Bandwidth).

4.7.2 Test Setup

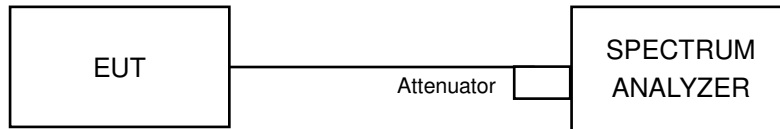

4.7.3 Test Instruments

Refer to section 4.1.2 to get information of above instrument.

4.7.4 Test Procedure

MEASUREMENT PROCEDURE REF

1. Set the RBW = 100 kHz.
2. Set the VBW \geq 300 kHz.
3. Detector = peak.
4. Sweep time = auto couple.
5. Trace mode = max hold.
6. Allow trace to fully stabilize.
7. Use the peak marker function to determine the maximum power level in any 100 kHz band segment within the fundamental EBW.

MEASUREMENT PROCEDURE OOB

1. Set RBW = 100 kHz.
2. Set VBW \geq 300 kHz.
3. Detector = peak.
4. Sweep = auto couple.
5. Trace Mode = max hold.
6. Allow trace to fully stabilize.
7. Use the peak marker function to determine the maximum amplitude level.

4.7.5 Deviation from Test Standard

No deviation.

4.7.6 EUT Operating Condition

The software provided by client to enable the EUT under transmission condition continuously at lowest, middle and highest channel frequencies individually.

4.7.7 Test Results

The conducted emission test is performed on each TX port of operating mode without summing or adding 10log (N) since the limit is relative emission limit.

The spectrum plots are attached on the following images. D1 line indicates the highest level, and D2 line indicates the 20 dB offset below D1. It shows compliance with the requirement.

802.11b

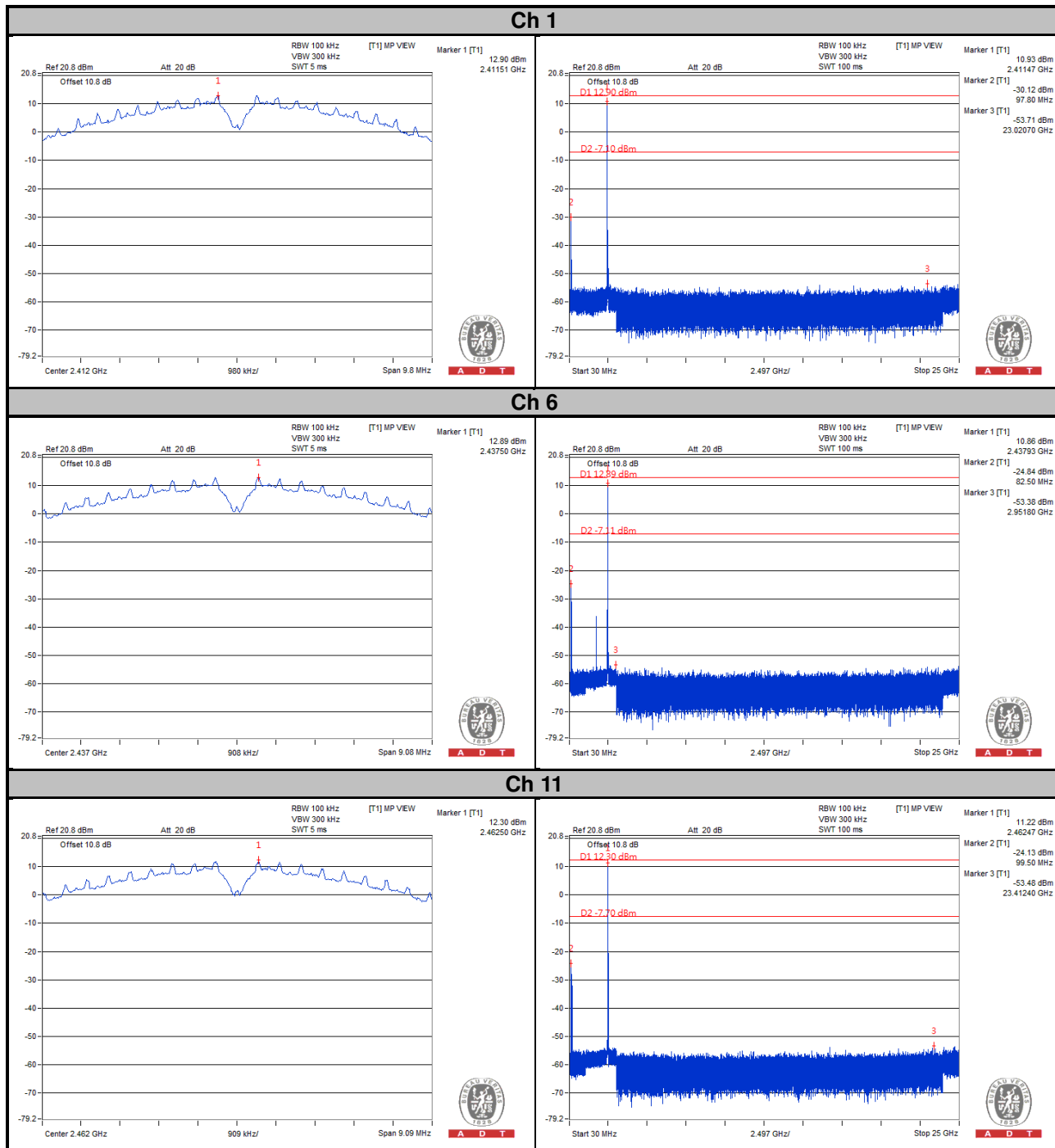

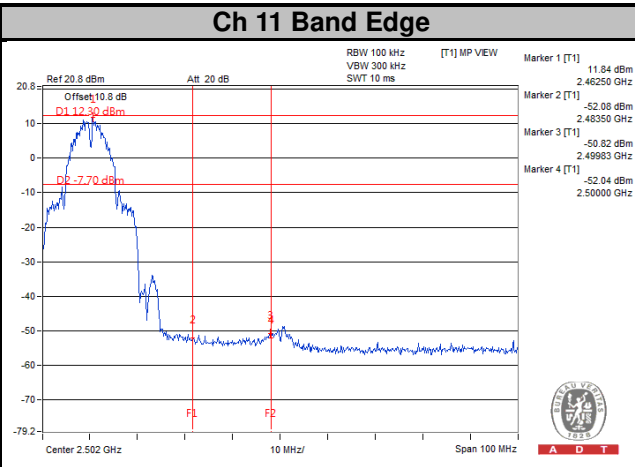
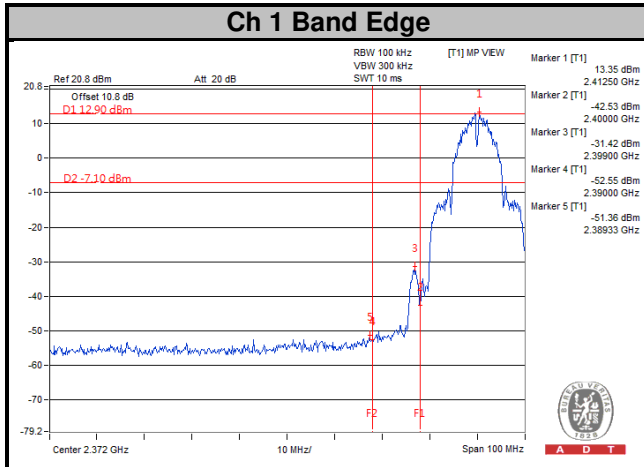

802.11g

Ch 1

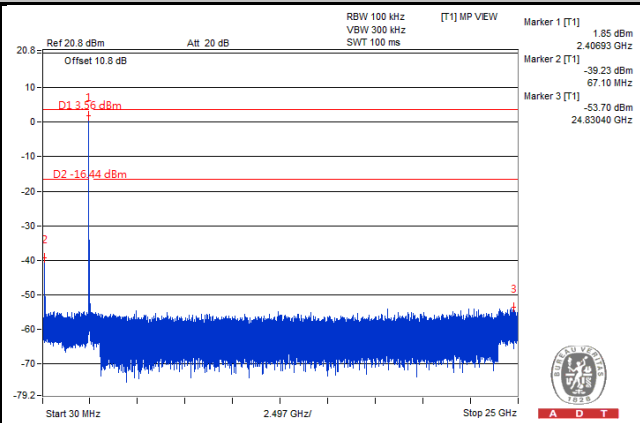
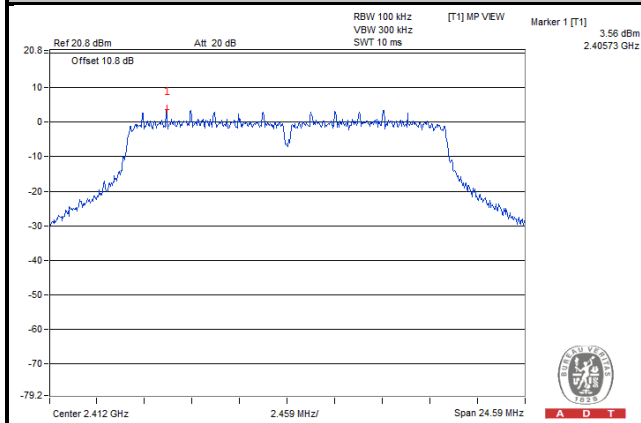

Ch 6

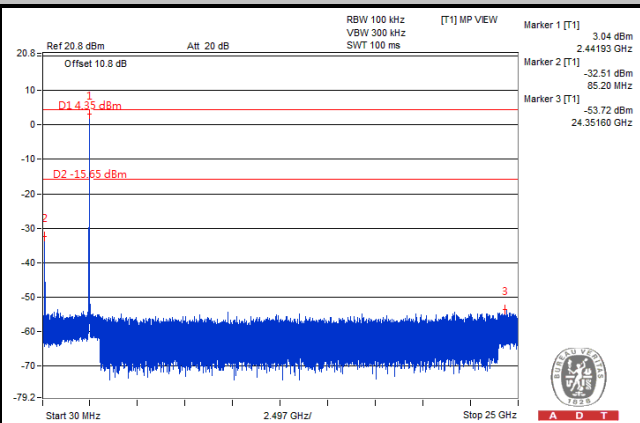
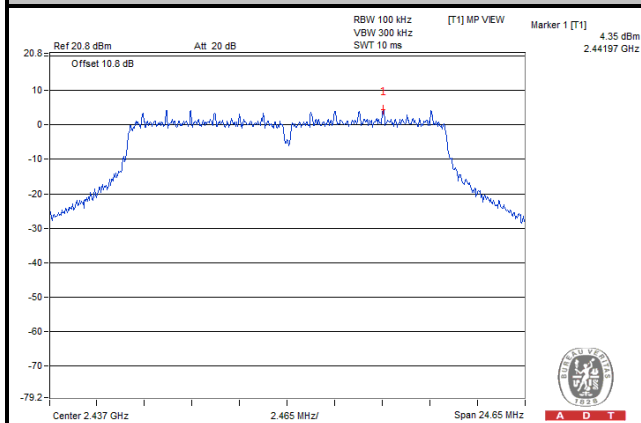

Ch 11

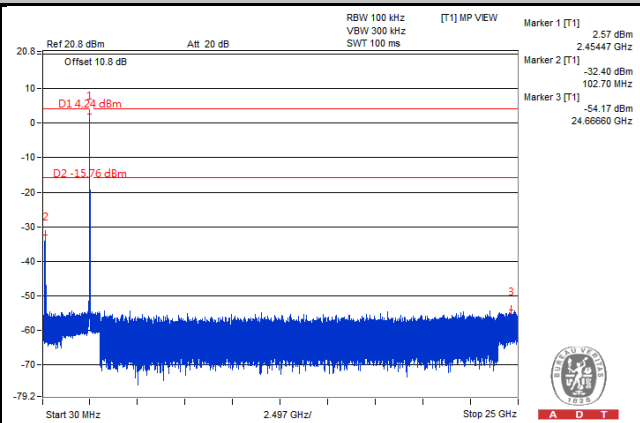
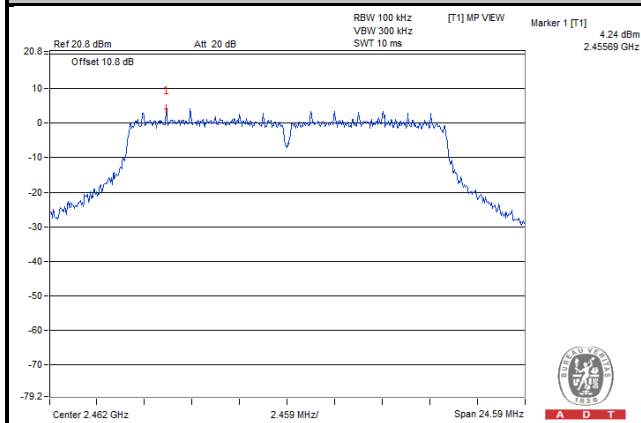

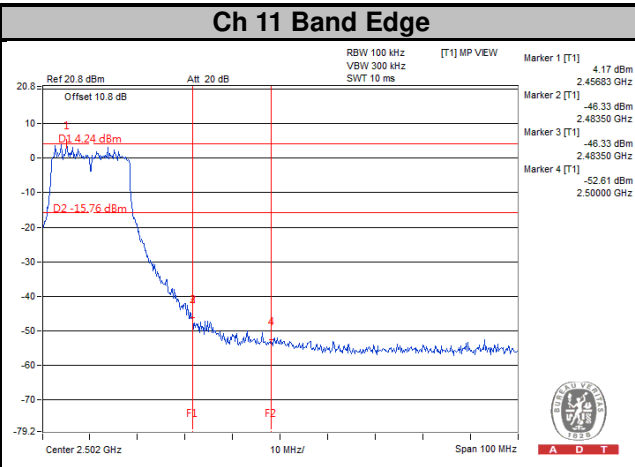
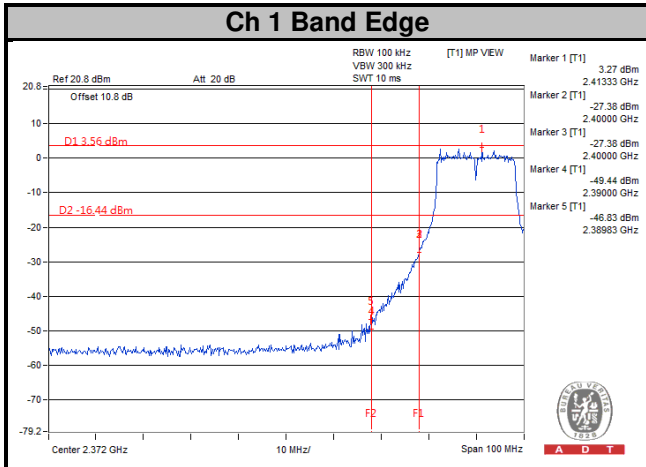

802.11n (HT20)
CHAIN 0

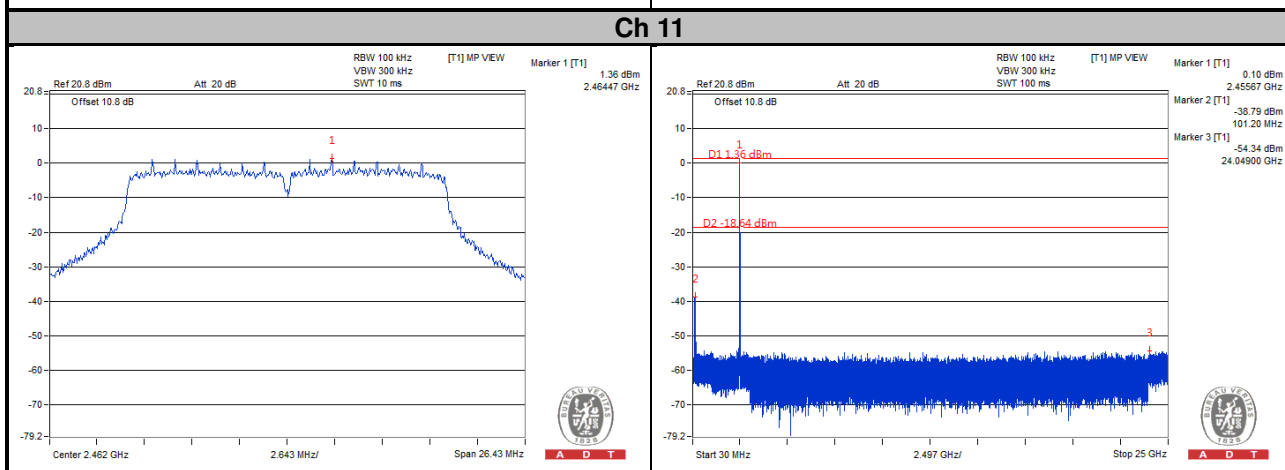
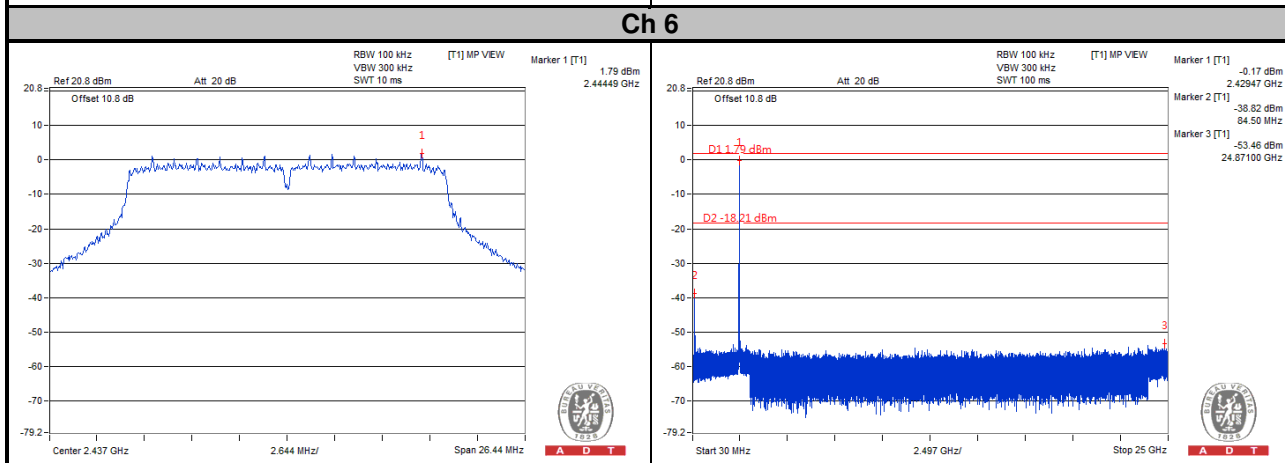
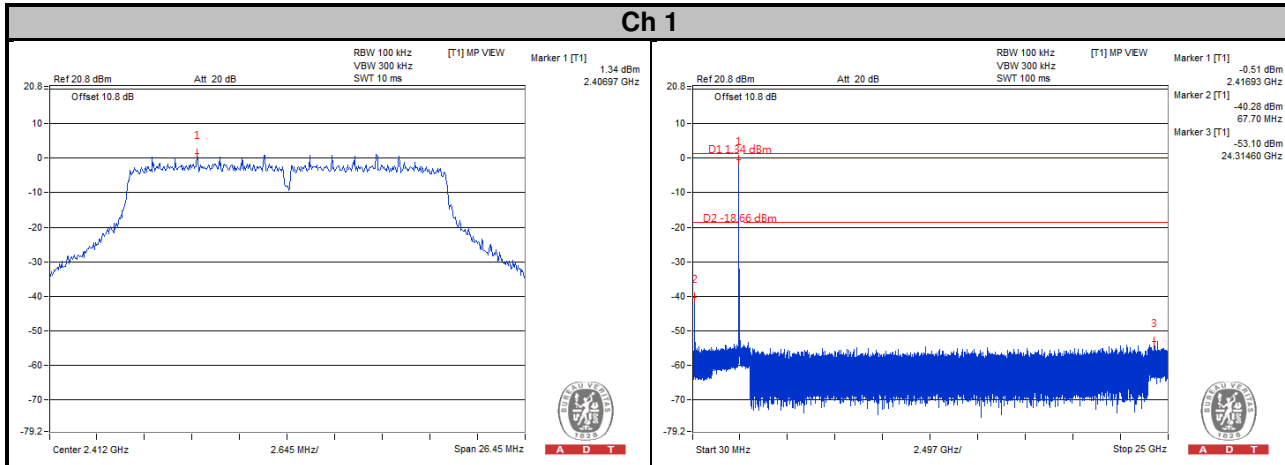

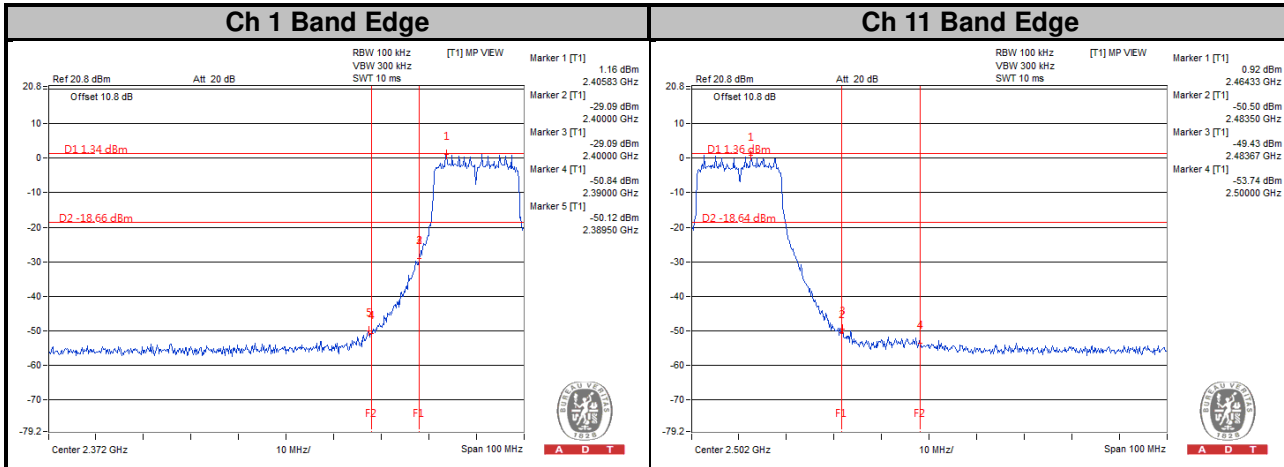

CHAIN 1

Ch 1

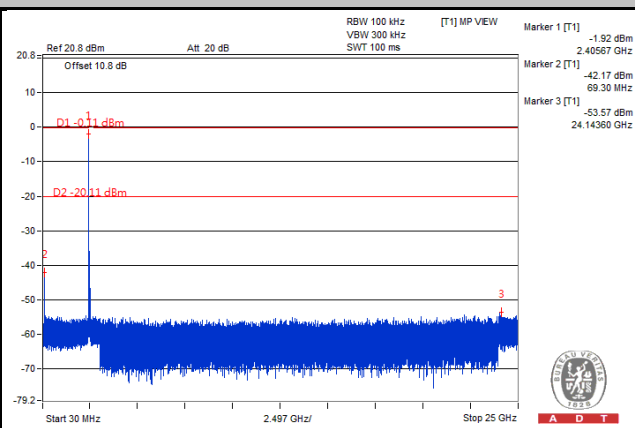
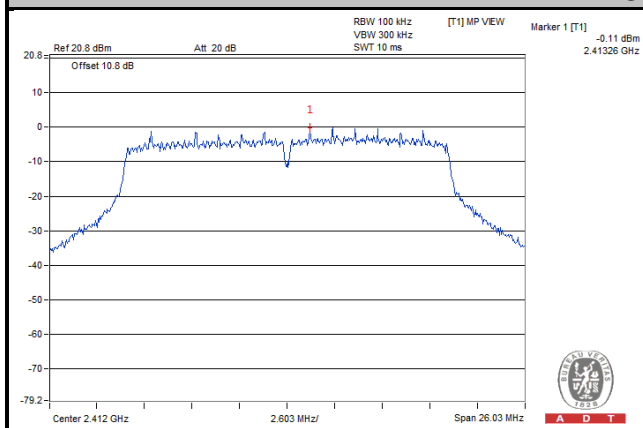

Ch 6

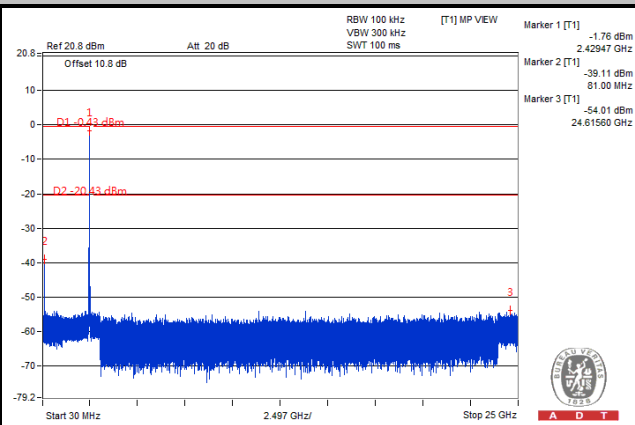
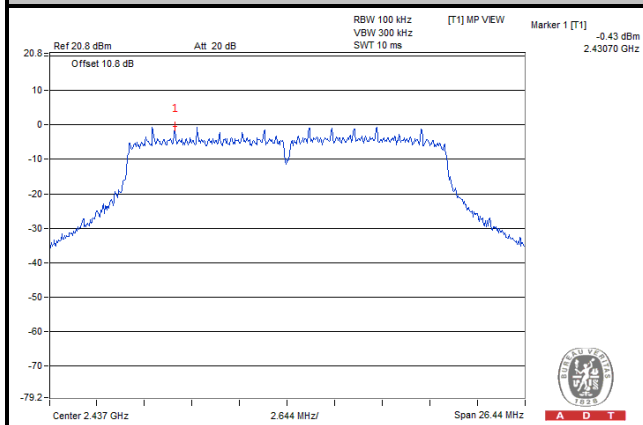

Ch 11

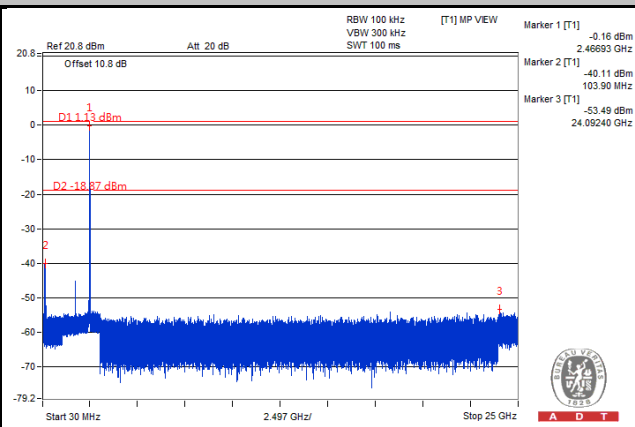
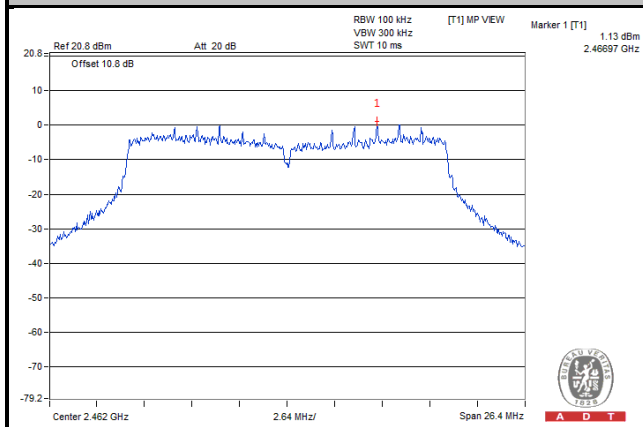

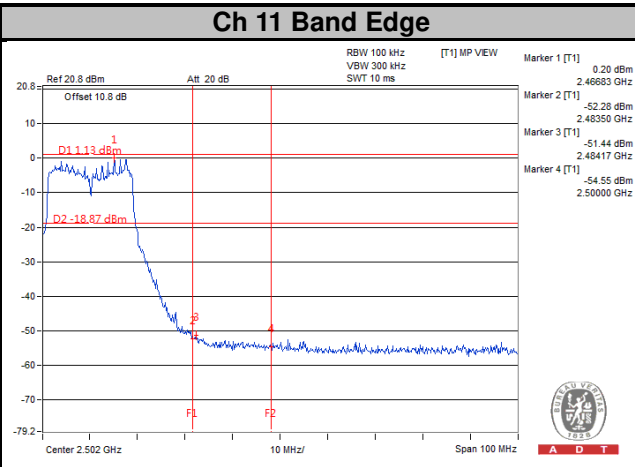
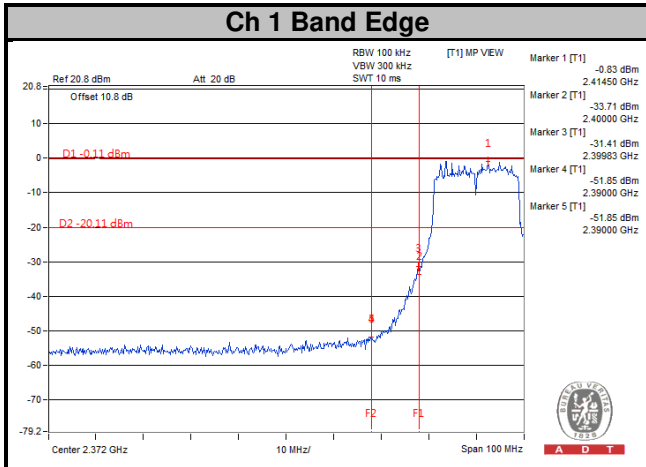

CHAIN 2

Ch 1

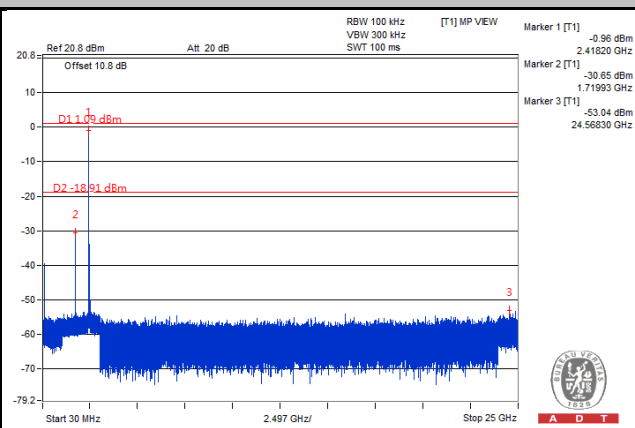
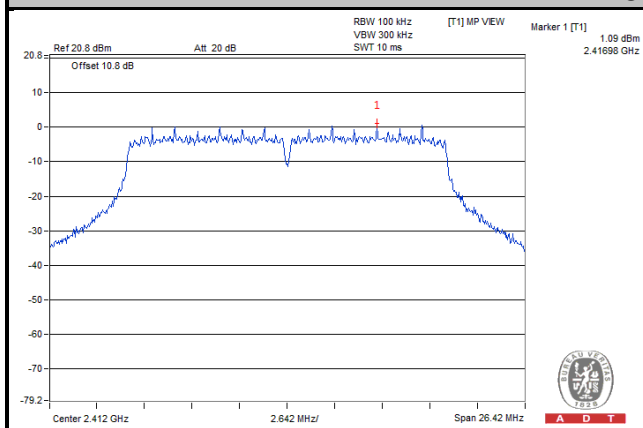

Ch 6

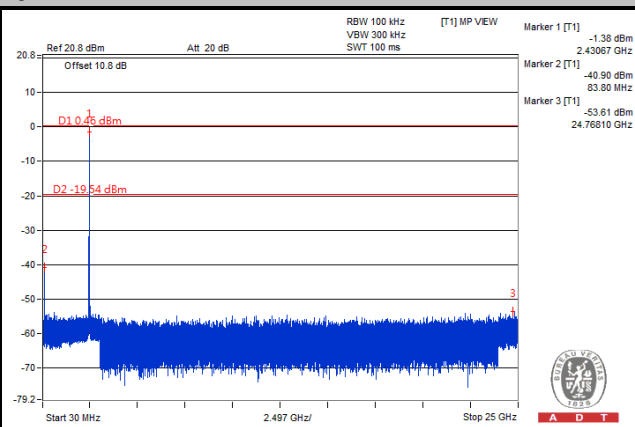
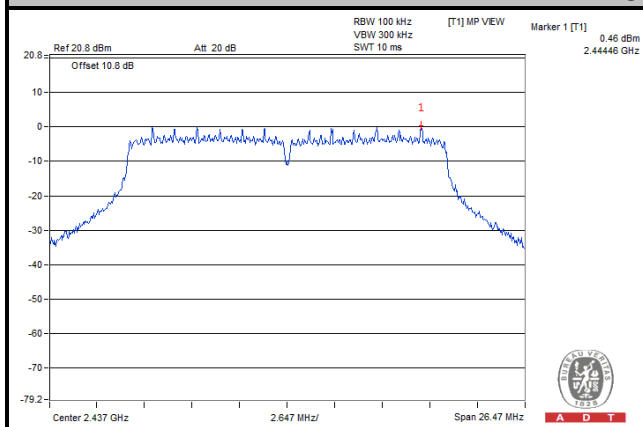

Ch 11

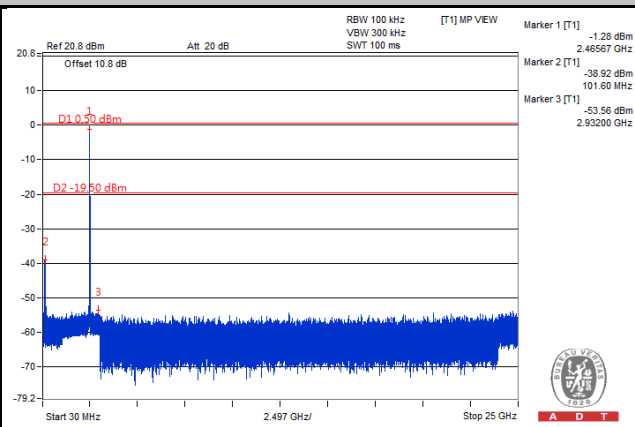
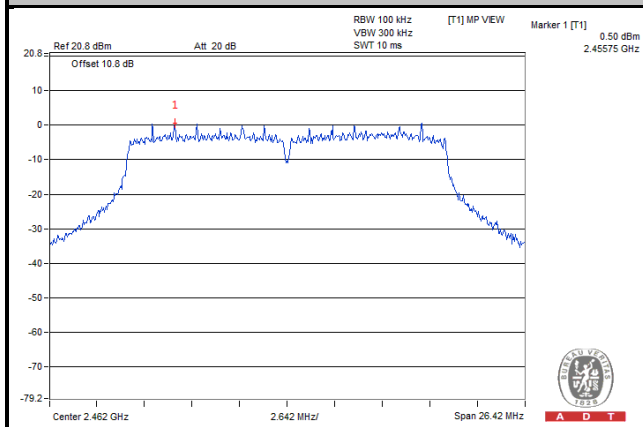

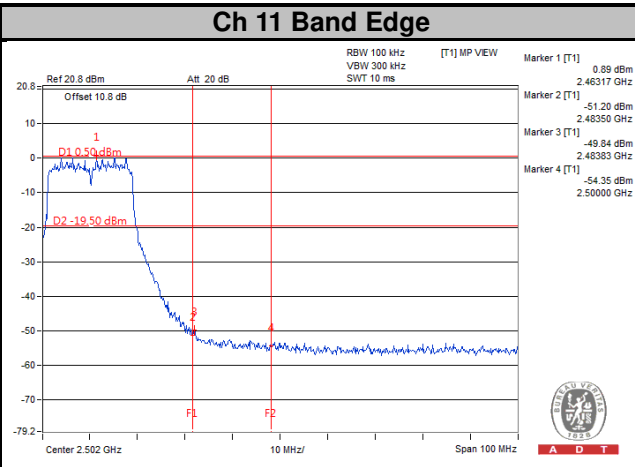
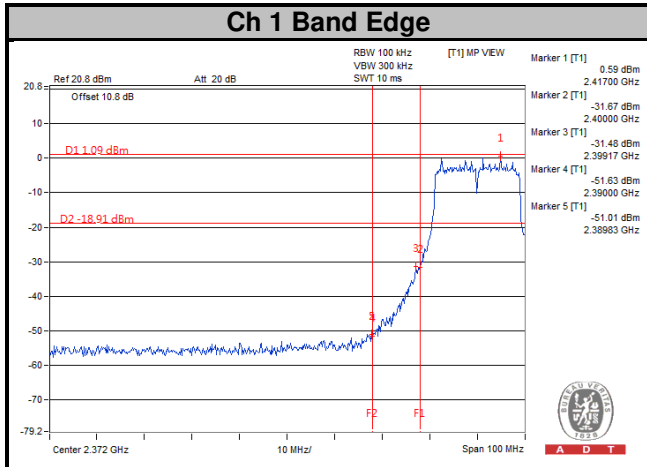

802.11n (HT40)
CHAIN 0

Ch 3

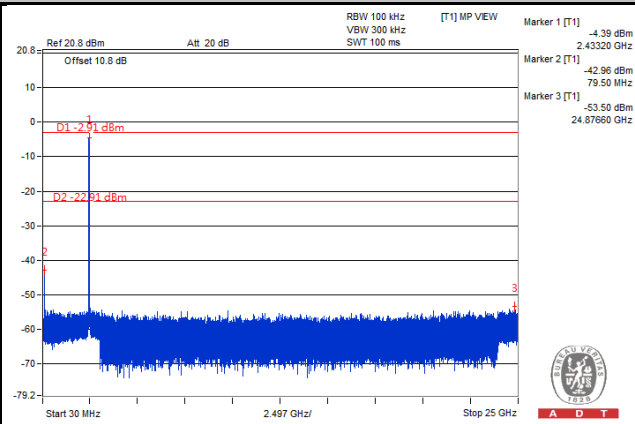
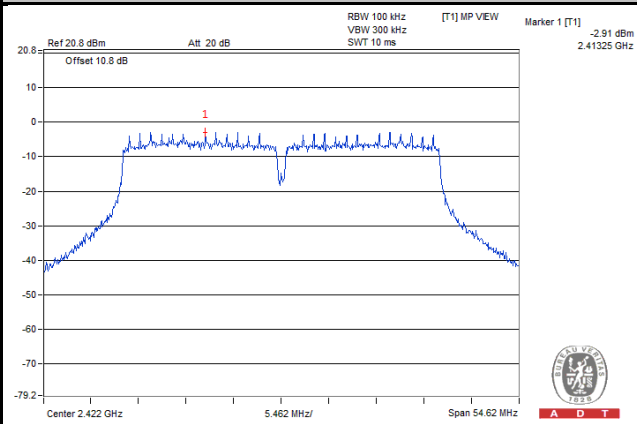

Ch 6

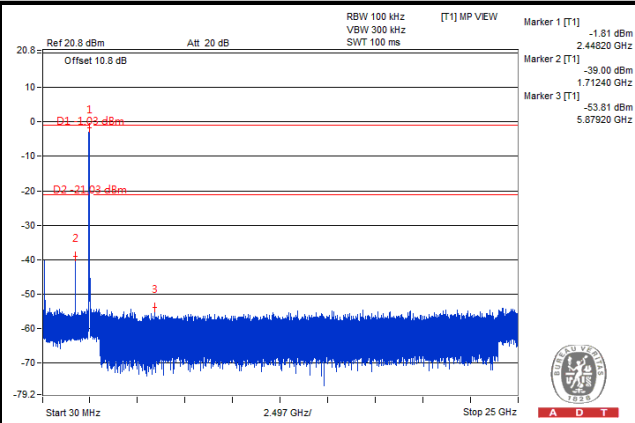
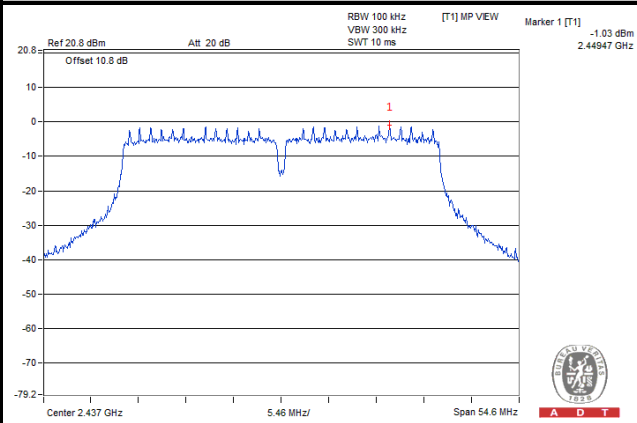

Ch 9

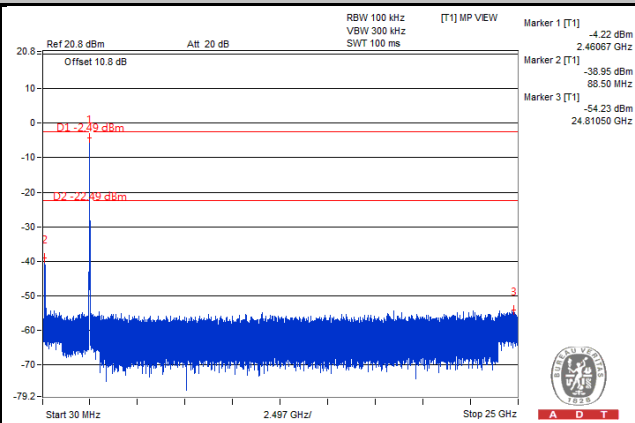
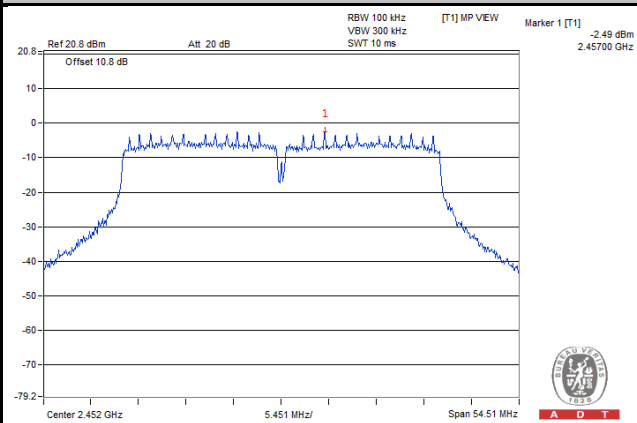

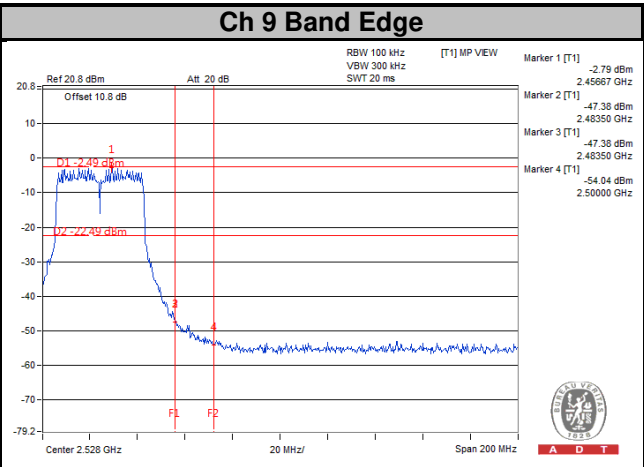
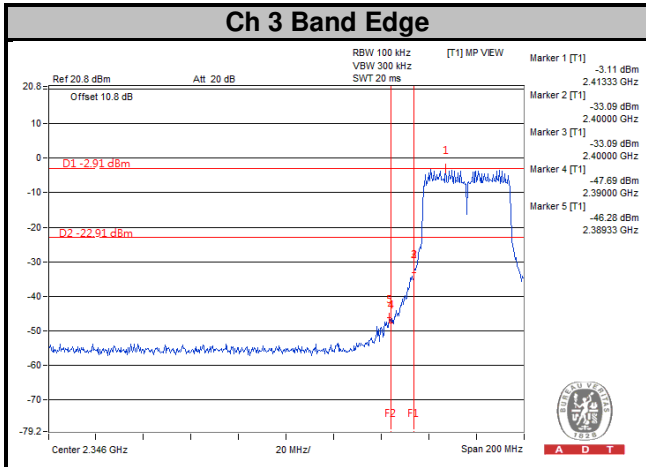

CHAIN 1

Ch 3

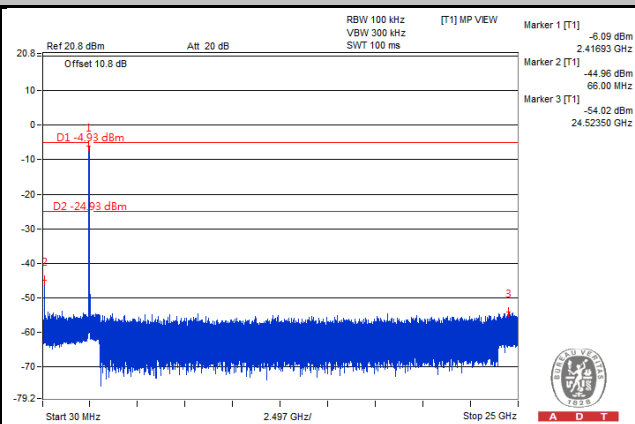
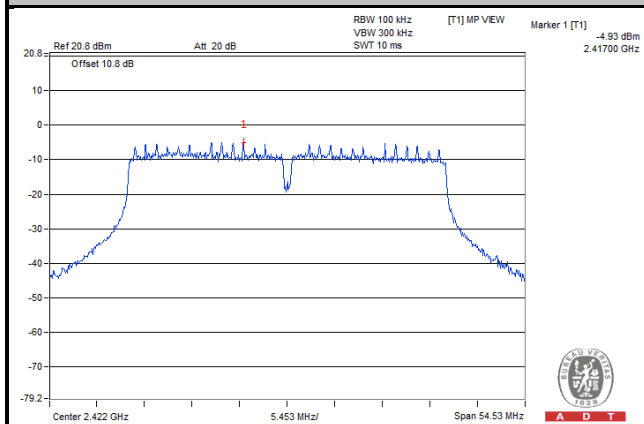

Ch 6

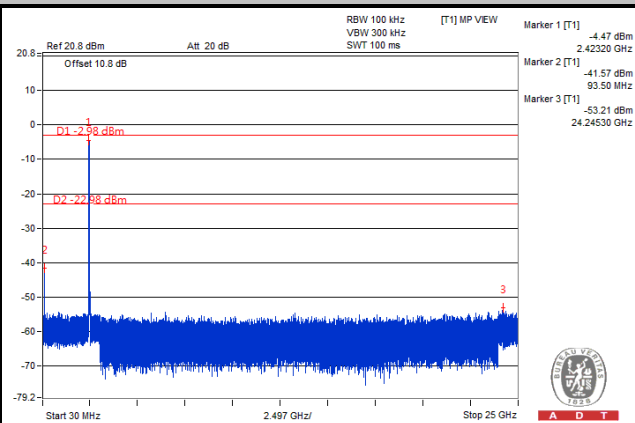
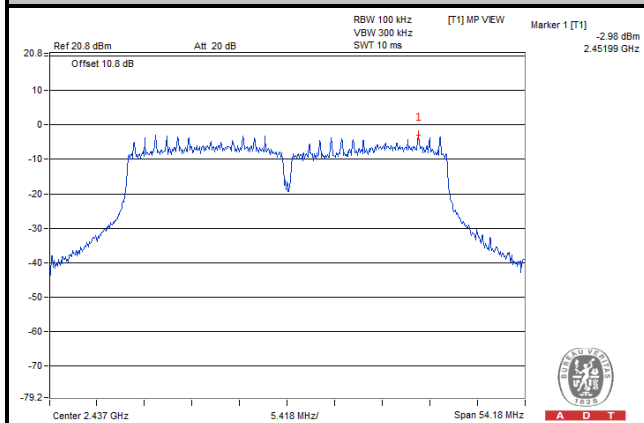

Ch 9

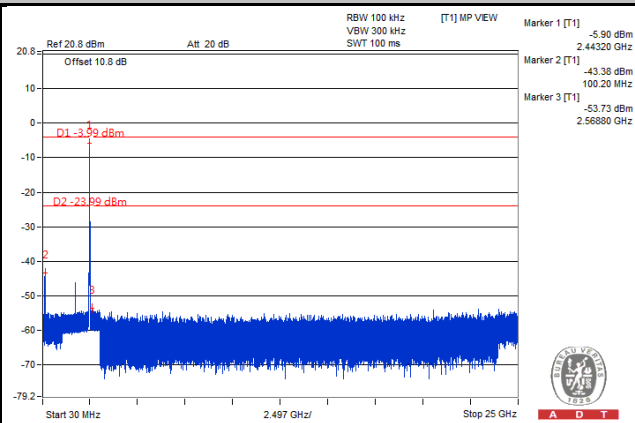
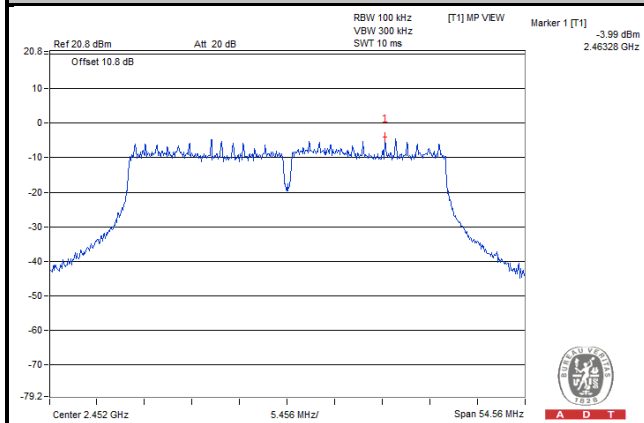

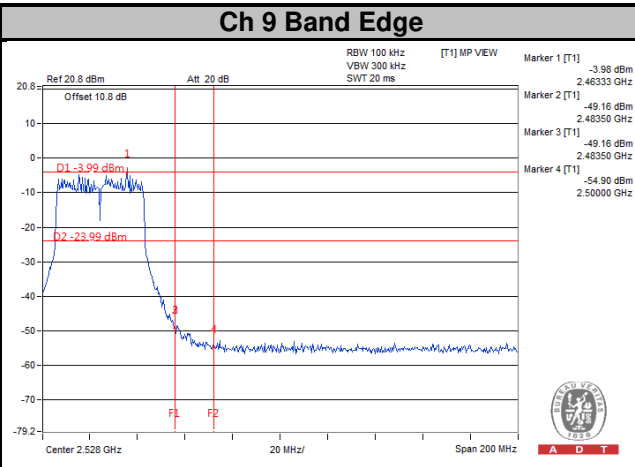
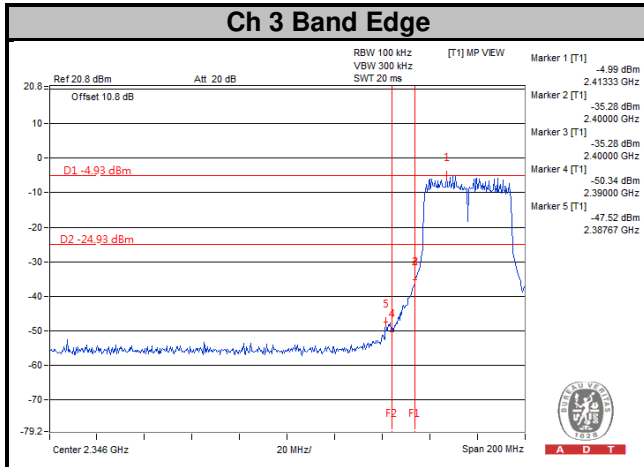

CHAIN 2

Ch 3

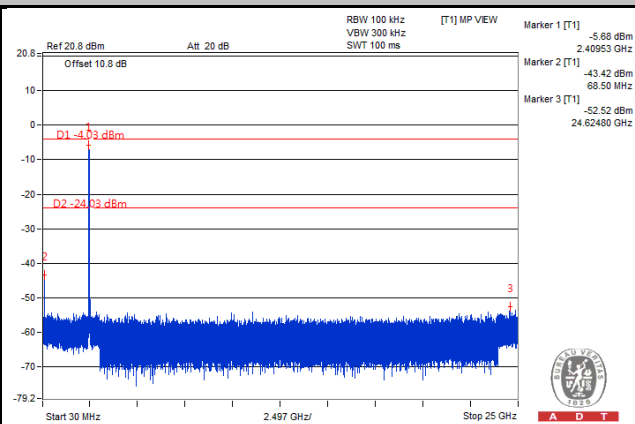
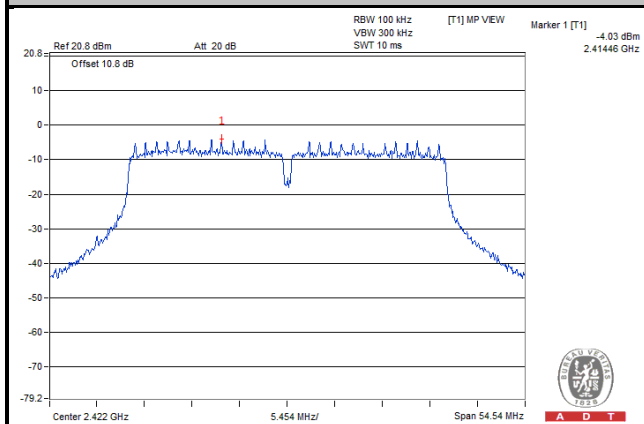

Ch 6

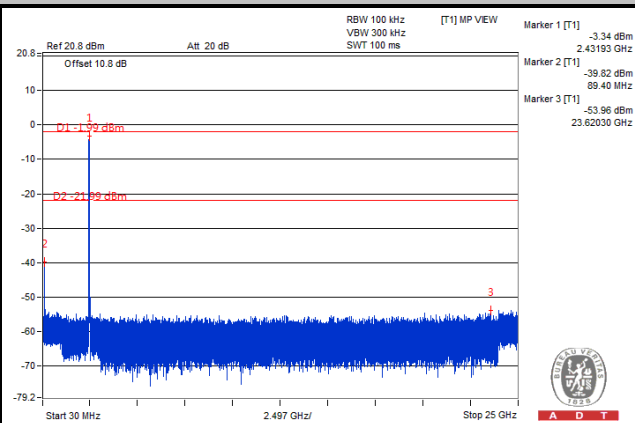
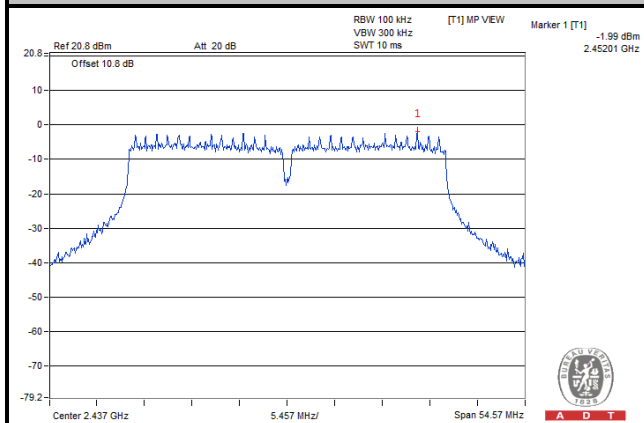

Ch 9

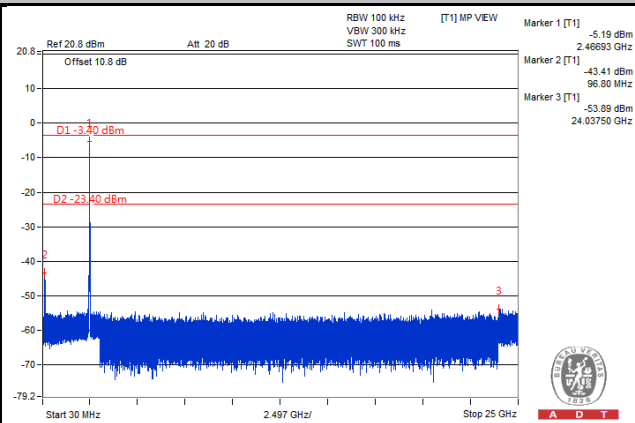
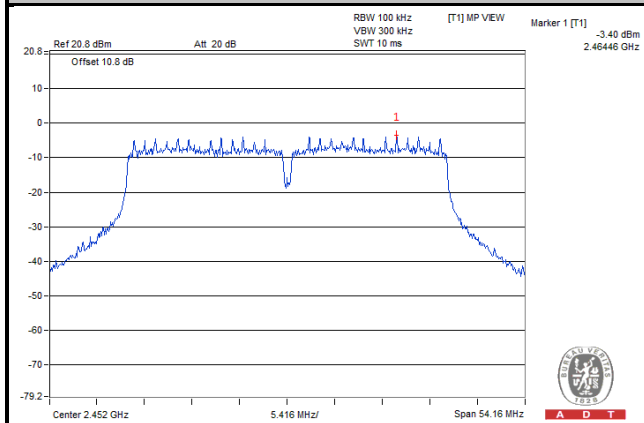

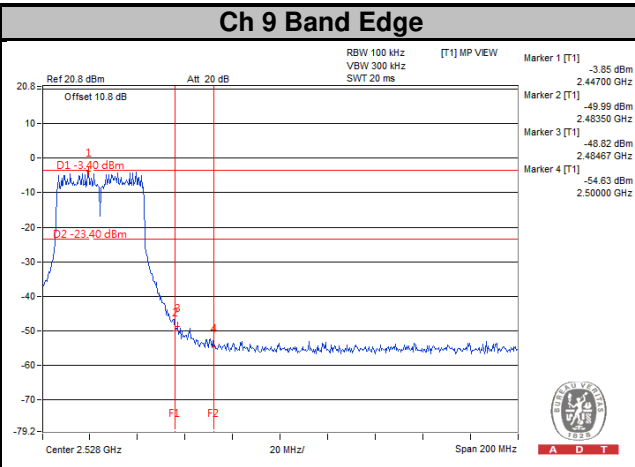
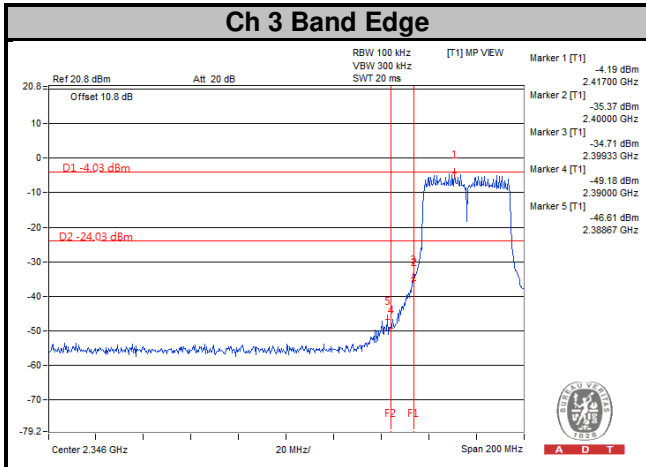

5 Pictures of Test Arrangements

Please refer to the attached file (Test Setup Photo).

Appendix – Information on the Testing Laboratories

We, Bureau Veritas Consumer Products Services (H.K.) Ltd., Taoyuan Branch, were founded in 1988 to provide our best service in EMC, Radio, Telecom and Safety consultation. Our laboratories are FCC recognized accredited test firms and accredited according to ISO/IEC 17025.

If you have any comments, please feel free to contact us at the following:

Linko EMC/RF Lab

Tel: 886-2-26052180

Fax: 886-2-26051924

Hsin Chu EMC/RF/Telecom Lab

Tel: 886-3-6668565

Fax: 886-3-6668323

Hwa Ya EMC/RF/Safety Lab

Tel: 886-3-3183232

Fax: 886-3-3270892

Email: service.adt@tw.bureauveritas.com

Web Site: www.bureauveritas-adt.com

The address and road map of all our labs can be found in our web site also.

--- END ---