

FCC RADIO TEST REPORT

Applicant..... : Raffel Systems, LLC
Address..... : N112 W14600 Mequon Road, Germantown, Wisconsin, United States, 53022
Manufacturer..... : FORTRESS ELECTRONICS (XIAMEN) CO., LTD.
Address..... : East of the fifth floor, 181 banqiao road, jimei district, Xiamen, Fujian, China
Factory..... : FORTRESS ELECTRONICS (XIAMEN) CO., LTD.
Address..... : East of the fifth floor, 181 banqiao road, jimei district, Xiamen, Fujian, China
Product Name..... : Embedded wireless charger
Brand Name..... : Raffel Systems
Model No. : WCP HBP 01-02, WCP BL 02
(For additional model and model difference refer to section 2)
FCC ID..... : YZHWCPXXX01
Measurement Standard..... : 47 CFR FCC Part 15, Subpart C
Receipt Date of Samples.... : April 13, 2023
Date of Tested..... : April 13, 2023 to April 26, 2023
Date of Report..... : May 11, 2023

This report shows that above equipment is technically compliant with the requirements of the standards above. All test results in this report apply only to the tested sample(s). Without prior written approval of Dongguan Nore Testing Center Co., Ltd, this report shall not be reproduced except in full.



Prepared by

Rose Hu / Project Engineer



Approved by

Iori Fan / Authorized Signatory

Table of Contents

1. Summary of Test Result.....	4
2. General Description of EUT	5
3. Test Channels and Modes Detail.....	7
4. Configuration of EUT.....	7
5. Modification of EUT	7
6. Description of Support Device.....	8
7. Test Facility and Location	8
8. Applicable Standards and References.....	9
9. Deviations and Abnormalities from Standard Conditions	9
10. Test Conditions	9
11. Measurement Uncertainty.....	10
12. Sample Calculations	11
13. Test Items and Results	12
13.1 Conducted Emissions Measurement.....	12
13.2 Radiated Spurious Emissions and Restricted Bands Measurement.....	18
13.3 20dB Bandwidth Measurement.....	34
13.4 Antenna Requirement.....	36
14. Test Equipment List.....	37

Revision History

Report Number	Description	Issued Date
NTC2304183FV00	Initial Issue	2023-05-11

1. Summary of Test Result

FCC Rules	Description of Test	Result	Remarks
§15.207 (a)	AC Power Conducted Emission	PASS	---
§15.209	Radiated Emissions	PASS	---
§15.215(c)	20dB Bandwidth	PASS	---
§15.203	Antenna Requirement	PASS	---

2. General Description of EUT

Product Information	
Product Name:	Embedded wireless charger
Main Model Name:	WCP HBP 01-02, WCP BL 02
Additional Model Name:	WCP XX 01, WCP XX 01-YY, WCP XX 02, WCP XX 02-YY (The XX in the middle represents the treatment of the shell, which is composed of two or three letters, the letters may be a-z, which are 26 letters. YY represents length of DC input line(0.1-1.8m)
Model Difference:	These models have the same circuit schematic, construction, PCB Layout and critical components. Their differences are size of shell, indicator light, the design of DC input Port, color, the length of DC input line and model number only due to trading purpose.
S/N:	2304-1891 for model WCP HBP 01-02; 2304-1892 for model WCP BL 02
Brand Name:	Raffel Systems
Hardware Version:	V01
Software Version:	V01
Rating:	Input DC 5V 2A, Output: 5W Max Input DC 9V 2A, Output: 10W Max
Typical Arrangement:	Table-top
I/O Port:	DC Port*1
Accessories Information	
Adapter:	N/A
Cable:	For model WCP HBP 01-02, DC Line: 1.22 unshielded, undetachable For model WCP BL 02, DC Line: 0.19 unshielded, undetachable
Other:	N/A
Additional Information	
Note:	According to the model difference, all tests were performed on model WCP HBP 01-02, and for model WCP BL 02 we have re-test items: conducted emission and radiated emission. This report only applies to wireless charging function.
Remark:	All the information above are provided by the manufacturer. More detailed feature of the EUT please refers to the user manual.

Technical Specification	
Frequency Range:	110.5-205KHz
Modulation Type:	FSK
Antenna Type:	Coil antenna
Output power for each coil:	5W, 10W

3. Test Channels and Modes Detail

Mode		Modulation
1	5V2A Full Load	FSK
2	5V2A Half Load	FSK
3	5V2A Empty Load	FSK
4	9V2A Full Load	FSK
5	9V2A Half Load	FSK
6	9V2A Empty Load	FSK

4. Configuration of EUT

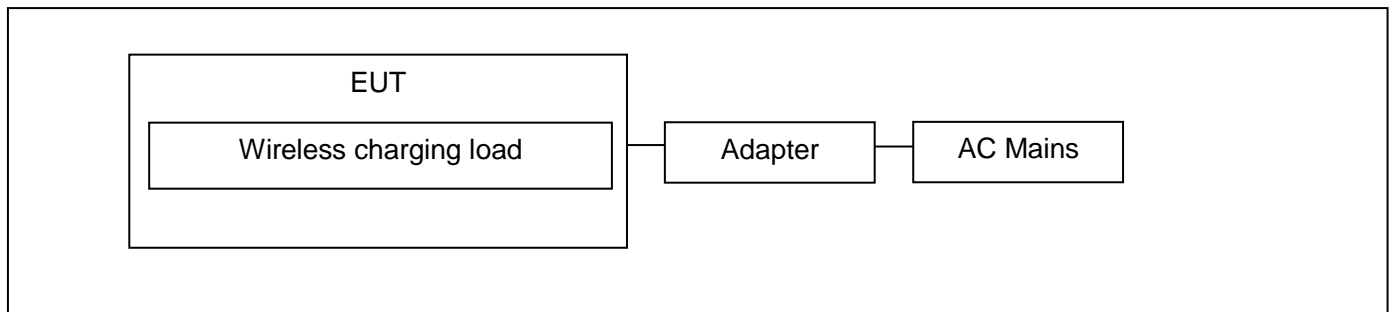

5. Modification of EUT

No modifications are made to the EUT during all test items.

6. Description of Support Device

The EUT has been tested as an independent unit together with other necessary accessories or support units. The following support units or accessories were used to form a representative test configuration during the tests.

No.	Equipment	Brand	M/N	S/N	Cable Specification	Remarks
1.	Wireless charging load	---	---	---	---	Provided by manufacturer
2.	Adapter	HUAWEI	HW-050200 C01	---	---	Provided by manufacturer

7. Test Facility and Location

Test Site	:	Dongguan Nore Testing Center Co., Ltd. (Dongguan NTC Co., Ltd.)
Accreditations and Authorizations	:	<p>The Laboratory has been assessed and proved to be in compliance with CNAS/CL01 Listed by CNAS, August 13, 2018 The Certificate Registration Number is L5795. The Certificate is valid until August 13, 2024</p> <p>The Laboratory has been assessed and proved to be in compliance with ISO17025 Listed by A2LA, November 01, 2017 The Certificate Registration Number is 4429.01 The Certificate is valid until December 31, 2023</p> <p>Listed by FCC, November 06, 2017 Test Firm Registration Number: 907417</p> <p>Listed by Industry Canada, June 08, 2017 The Certificate Registration Number. Is 46405-9743A</p>
Test Site Location	:	Building D, Gaosheng Science and Technology Park, Hongtu Road, Nancheng District, Dongguan City, Guangdong Province, China

8. Applicable Standards and References

According to the specifications of the manufacturer, the EUT must comply with the requirements of the following standards:

Test Standards:

47 CFR Part 15, Subpart C

ANSI C63.10-2013

References Test Guidance:

N/A

9. Deviations and Abnormalities from Standard Conditions

No additions, deviations and exclusions from the standard.

10. Test Conditions

No.	Test Item	Test Mode	Test Voltage	Tested by	Remarks
1.	AC Power Conducted Emission	1-6	AC 120V 60Hz	Sean Yuan	See note 1
2.	Radiated Emissions	1-6	AC 120V 60Hz	Sean Yuan	See note 1
3.	20dB Bandwidth	1	AC 120V 60Hz	Sean Yuan	See note 1
4.	Antenna Requirement	---	---	---	See note 1

Note:

- The testing climatic conditions for temperature, humidity, and atmospheric pressure are within: 15~35℃, 30~70%, 86~106kPa.
- For the test voltage AC 120V 60Hz was come from power adapter, only the worst case was recorded in this report.

11. Measurement Uncertainty

No.	Test Item	Frequency	Uncertainty	Remarks
1.	Conducted Emission	150KHz ~ 30MHz	±2.52 dB	---
2.	Radiated Emission Test	9kHz ~ 30MHz	±2.60 dB	---
		30MHz ~ 1GHz	±4.68 dB	---
		1GHz ~ 18GHz	±5.14 dB	---
		18GHz ~ 40GHz	±5.14 dB	---
3.	RF Conducted Test	10Hz ~ 40GHz	±1.06 dB	---
4.	Occupied Channel Bandwidth	---	±1.42 x10 ⁻⁴ % MHz	---

Note:

1. This uncertainty represents an expanded uncertainty expressed at approximately the 95% confidence level using a coverage factor of k=2.
2. The measurement uncertainty levels above are estimated and calculated according to CISPR 16-4-2.
3. The conformity assessment statement in this report is based solely on the test results, measurement uncertainty is excluded.

12. Sample Calculations

Conducted Emission						
Freq. (MHz)	Reading Level (dBuV)	Correct Factor (dB)	Measurement (dBuV)	Limit (dBuV)	Over (dB)	Detector
0.1620	35.14	10.56	45.70	65.36	-19.66	QP

Where,

Freq. = Emission frequency in MHz
 Reading Level = Uncorrected Analyzer/Receiver reading
 Corrector Factor = Insertion loss of LISN + Cable Loss + RF Switching Unit attenuation
 Measurement = Reading + Corrector Factor
 Limit = Limit stated in standard
 Margin = Measurement - Limit
 Detector = Reading for Quasi-Peak / Average / Peak

Radiated Spurious Emissions and Restricted Bands						
Freq. (MHz)	Reading Level (dBuV)	Correct Factor (dB/m)	Measurement (dBuV/m)	Limit (dBuV/m)	Over (dB)	Detector
36.7900	44.06	-8.61	35.45	40.00	-4.55	AVG

Where,

Freq. = Emission frequency in MHz
 Reading Level = Uncorrected Analyzer/Receiver reading
 Corrector Factor = Antenna Factor + Cable Loss - Pre-amplifier
 Measurement = Reading + Corrector Factor
 Limit = Limit stated in standard
 Over = Margin, which calculated by Measurement - Limit
 Detector = Reading for Quasi-Peak / Average / Peak

Note: For all conducted test items, the spectrum analyzer offset or transducer is derived from RF cable loss and attenuator factor. The offset or transducer is equal to the RF cable loss plus attenuator factor.

13. Test Items and Results

13.1 Conducted Emissions Measurement

LIMITS

According to the requirements of FCC PART 15.207, the limits are as follows:

Frequency (MHz)	Quasi-peak	Average
0.15 to 0.5	66 to 56	56 to 46
0.5 to 5	56	46
5 to 30	60	50

Note: 1. If the limits for the average detector are met when using the quasi-peak detector, then the limits for the measurements with the average detector are considered to be met.
 2. The lower limit shall apply at the transition frequencies.
 3. The limit decreases linearly with the logarithm of the frequency in the range 0.15 MHz to 0.5MHz.

BLOCK DIAGRAM OF TEST SETUP

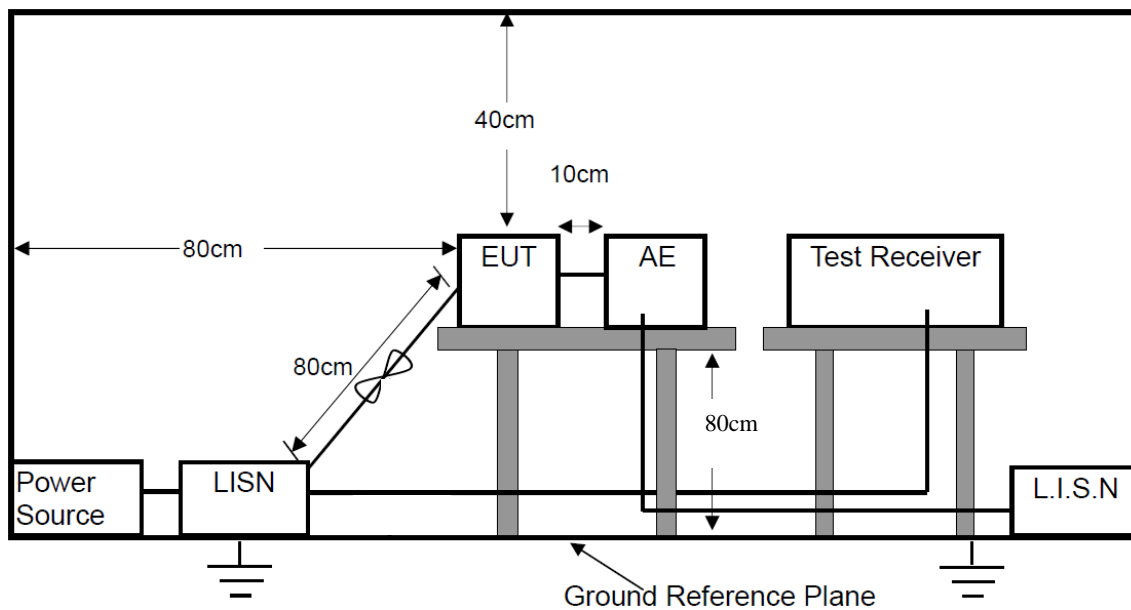

TEST PROCEDURES

- a. The EUT was placed on a wooden table 0.8m height from the metal ground plan and 0.4m from the conducting wall of the shielding room and it was kept at 0.8m from any other grounded conducting surface.
- b. All I/O cables and support devices were positioned as per ANSI C63.10.
- c. Connect mains power port of the EUT to a line impedance stabilization network (LISN).
- d. Connect all support devices to the other LISN and AAN, if needed.
- e. Scan the frequency range from 150KHz to 30MHz at both sides of AC line for maximum conducted interference checking and record the test data.

TEST RESULTS

PASS

Please refer to the following pages of the worst case.

M/N: WCP HBP 01-02	Testing Voltage: AC 120V / 60Hz
Phase: L1	Detector: QP & AVG
Test Mode: 4	

Conducted Emission Measurement

Date: 2023/4/20

Time: 14:47:39

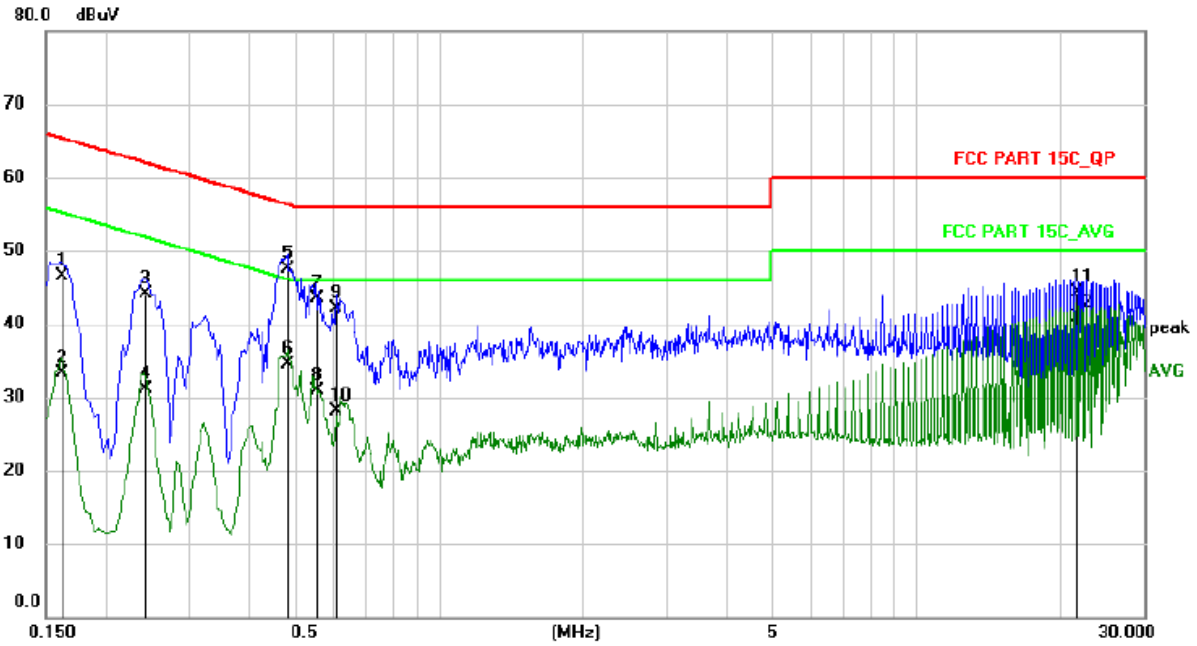

No. Mk.	Freq. MHz	Reading Level dBuV	Correct Factor dB	Measurement dBuV	Limit dBuV	Over dB	Detector	Comment
1	0.1620	35.90	10.60	46.50	65.36	-18.86	QP	
2	0.1620	22.80	10.60	33.40	55.36	-21.96	AVG	
3	0.2419	33.49	10.61	44.10	62.03	-17.93	QP	
4	0.2419	20.59	10.61	31.20	52.03	-20.83	AVG	
5 *	0.4819	36.89	10.61	47.50	56.31	-8.81	QP	
6	0.4819	23.89	10.61	34.50	46.31	-11.81	AVG	
7	0.5540	32.90	10.60	43.50	56.00	-12.50	QP	
8	0.5540	20.30	10.60	30.90	46.00	-15.10	AVG	
9	0.6100	31.50	10.60	42.10	56.00	-13.90	QP	
10	0.6100	17.50	10.60	28.10	46.00	-17.90	AVG	
11	21.6140	33.49	10.81	44.30	60.00	-15.70	QP	
12	21.6140	30.19	10.81	41.00	50.00	-9.00	AVG	

M/N: WCP HBP 01-02	Testing Voltage: AC 120V / 60Hz
Phase: N	Detector: QP & AVG
Test Mode: 4	

Conducted Emission Measurement

Date: 2023/4/20

Time: 14:54:08

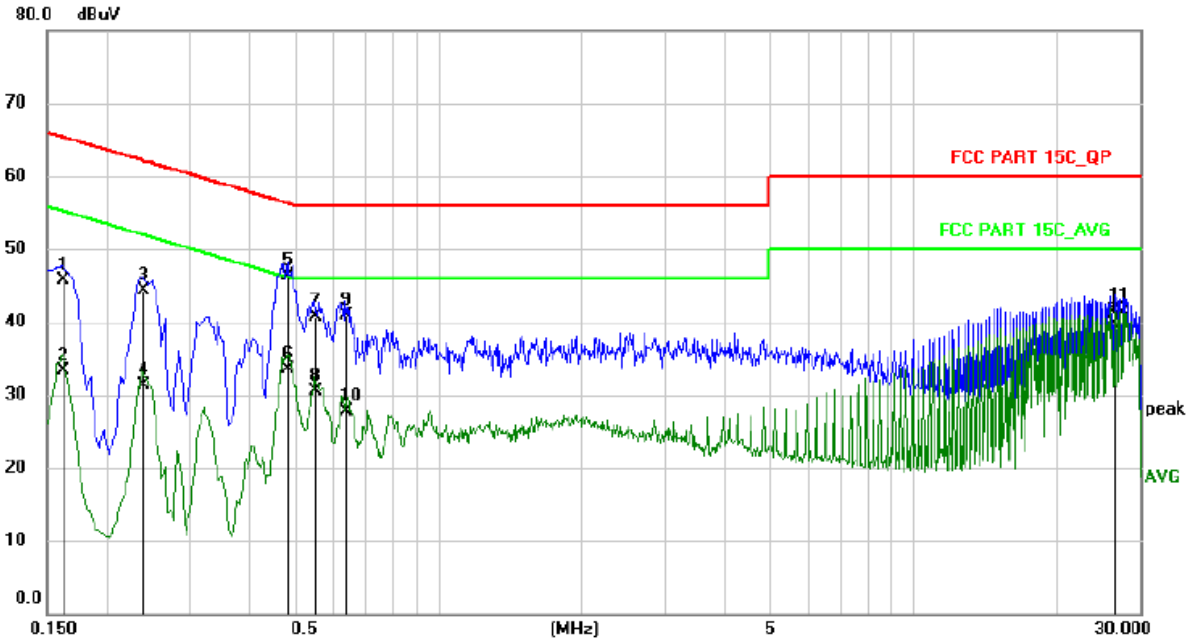

No. Mk.	Freq.	Reading Level	Correct Factor	Measurement	Limit	Over	Detector	Comment
	MHz	dBuV	dB	dBuV	dBuV	dB		
1	0.1620	35.14	10.56	45.70	65.36	-19.66	QP	
2	0.1620	22.84	10.56	33.40	55.36	-21.96	AVG	
3	0.2379	33.74	10.56	44.30	62.17	-17.87	QP	
4	0.2379	20.84	10.56	31.40	52.17	-20.77	AVG	
5 *	0.4820	35.73	10.57	46.30	56.30	-10.00	QP	
6	0.4820	22.93	10.57	33.50	46.30	-12.80	AVG	
7	0.5500	30.23	10.57	40.80	56.00	-15.20	QP	
8	0.5500	19.93	10.57	30.50	46.00	-15.50	AVG	
9	0.6380	30.33	10.57	40.90	56.00	-15.10	QP	
10	0.6380	17.13	10.57	27.70	46.00	-18.30	AVG	
11	26.4460	30.61	10.99	41.60	60.00	-18.40	QP	
12	26.4460	28.81	10.99	39.80	50.00	-10.20	AVG	

M/N: WCP BL 02	Testing Voltage: AC 120V / 60Hz
Phase: L1	Detector: QP & AVG
Test Mode: 4	

Conducted Emission Measurement

Date: 2023/4/20

Time: 15:02:59

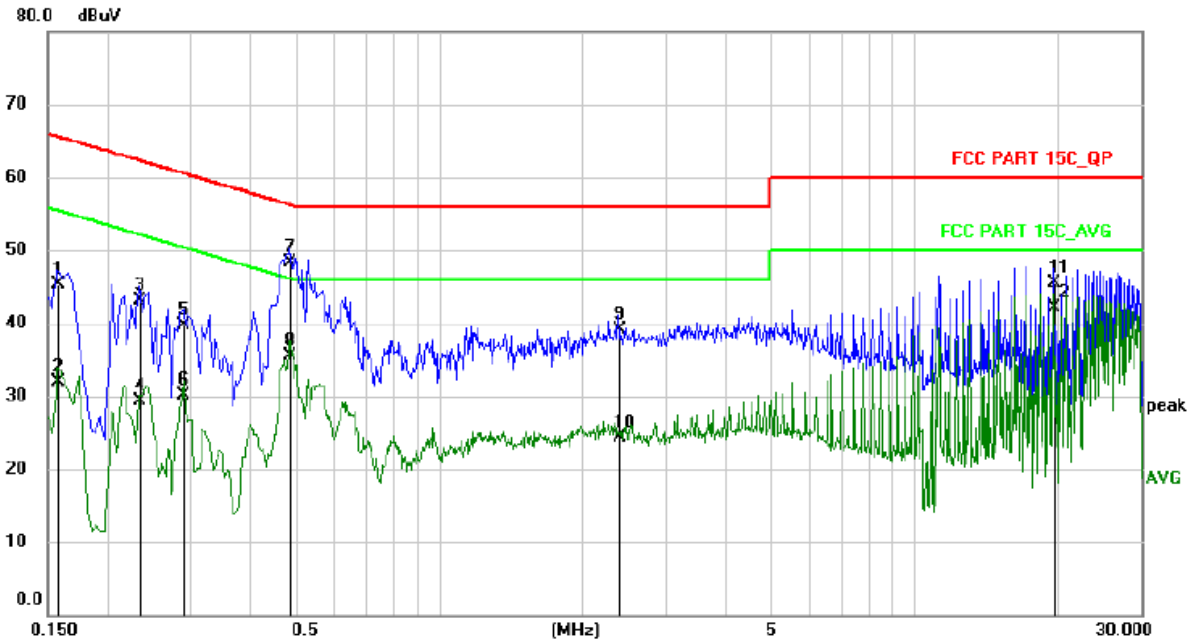

No. Mk.	Freq.	Reading Level	Correct Factor	Measurement	Limit	Over	Detector	Comment
	MHz	dBuV	dB	dBuV	dBuV	dB		
1	0.1580	34.71	10.59	45.30	65.57	-20.27	QP	
2	0.1580	21.31	10.59	31.90	55.57	-23.67	AVG	
3	0.2340	32.60	10.60	43.20	62.31	-19.11	QP	
4	0.2340	18.70	10.60	29.30	52.31	-23.01	AVG	
5	0.2900	29.18	10.62	39.80	60.52	-20.72	QP	
6	0.2900	19.48	10.62	30.10	50.52	-20.42	AVG	
7	0.4859	37.69	10.61	48.30	56.24	-7.94	QP	
8	0.4859	24.99	10.61	35.60	46.24	-10.64	AVG	
9	2.3900	28.58	10.62	39.20	56.00	-16.80	QP	
10	2.3900	13.68	10.62	24.30	46.00	-21.70	AVG	
11	19.6178	34.76	10.84	45.60	60.00	-14.40	QP	
12 *	19.6178	31.36	10.84	42.20	50.00	-7.80	AVG	

M/N: WCP BL 02	Testing Voltage: AC 120V / 60Hz
Phase: N	Detector: QP & AVG
Test Mode: 4	

Conducted Emission Measurement

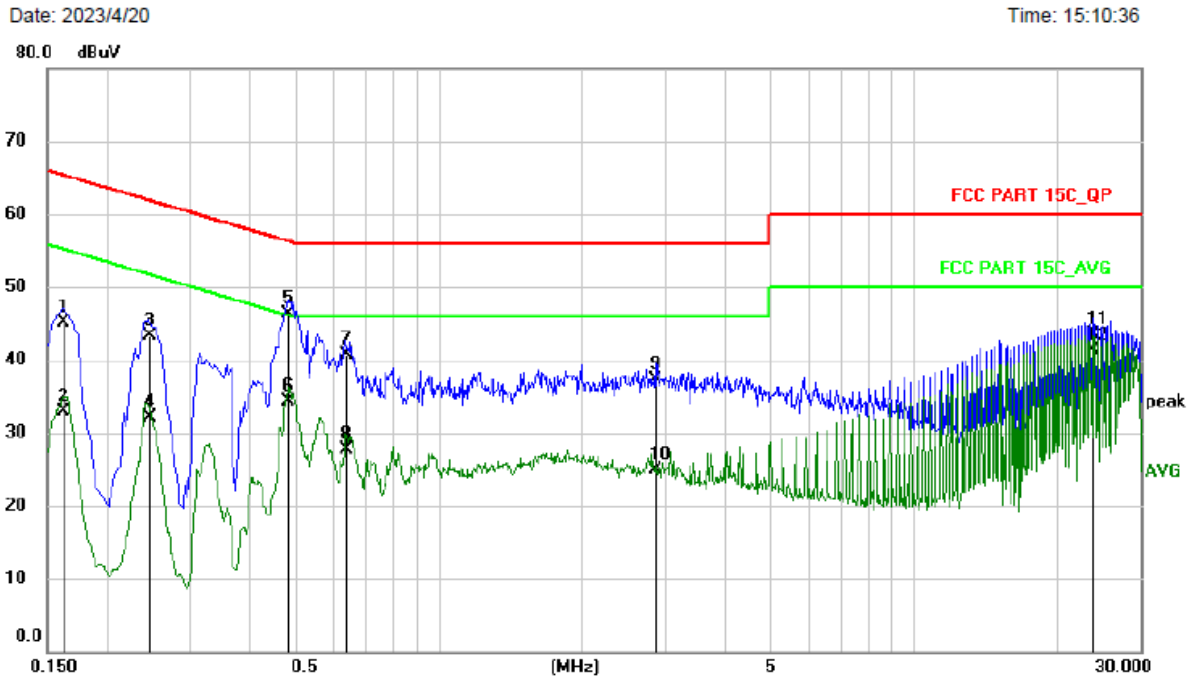

No. Mk.	Freq.	Reading Level	Correct Factor	Measurement	Limit	Over	Detector	Comment
	MHz	dBuV	dB	dBuV	dBuV	dB		
1	0.1620	34.64	10.56	45.20	65.36	-20.16	QP	
2	0.1620	22.34	10.56	32.90	55.36	-22.46	AVG	
3	0.2459	32.83	10.57	43.40	61.89	-18.49	QP	
4	0.2459	21.63	10.57	32.20	51.89	-19.69	AVG	
5	0.4820	35.83	10.57	46.40	56.30	-9.90	QP	
6	0.4820	23.73	10.57	34.30	46.30	-12.00	AVG	
7	0.6380	30.13	10.57	40.70	56.00	-15.30	QP	
8	0.6380	17.23	10.57	27.80	46.00	-18.20	AVG	
9	2.8620	26.82	10.58	37.40	56.00	-18.60	QP	
10	2.8620	14.42	10.58	25.00	46.00	-21.00	AVG	
11	23.8220	32.88	10.72	43.60	60.00	-16.40	QP	
12 *	23.8220	30.58	10.72	41.30	50.00	-8.70	AVG	

13.2 Radiated Spurious Emissions and Restricted Bands Measurement

LIMITS

Frequency range MHz	Distance Meters	Field Strengths Limit (15.209)	
		μV/m	
0.009 ~ 0.490	300	2400/F(kHz)	
0.490 ~ 1.705	30	24000/F(kHz)	
1.705 ~ 30	30	30	
30 ~ 88	3	100	
88 ~ 216	3	150	
216 ~ 960	3	200	
Above 960	3	500	
Frequency range MHz	Distance Meters	Field Strengths Limit (15.249)	
		mV/m (Field strength of fundamental)	μV/m (Field strength of Harmonics)
902 ~ 928	3	50	500
2400 ~ 2483.5	3	50	500
5725 ~ 5875	3	50	500
24000 ~ 2425000	3	250	2500

- Remark: (1) Emission level (dB)μV = 20 log Emission level μV/m
- (2) The smaller limit shall apply at the cross point between two frequency bands.
- (3) As shown in 15.35(b), for frequencies above 1000MHz, the field strength limits are based on average detector, however, the peak field strength of any emission shall not exceed the maximum permitted average limits, specified above by more than 20dB under any condition of modulation.
- (4) The frequency range scanned is from the lowest radio frequency signal generated in the device which is greater than 9 kHz to the tenth harmonic of the highest fundamental frequency or 40 GHz, whichever is lower.
- (5) §15.249(d) specifies that emissions which fall in the restricted bands, as defined in §15.205 comply with radiated emission limits specified in §15.209.

BLOCK DIAGRAM OF TEST SETUP

For Radiated Emission below 30MHz

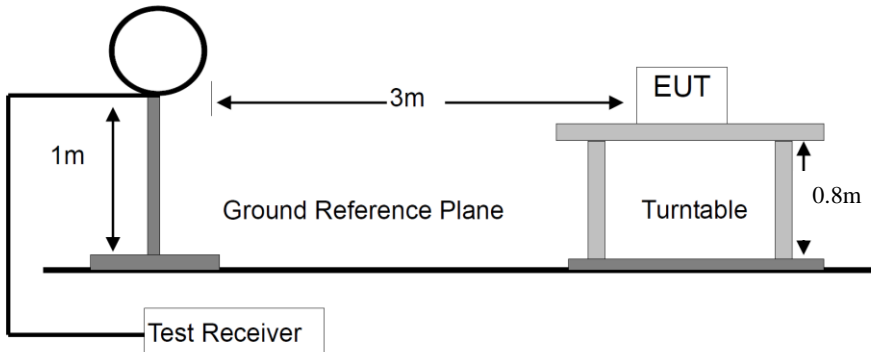

For Radiated Emission 30-1000MHz

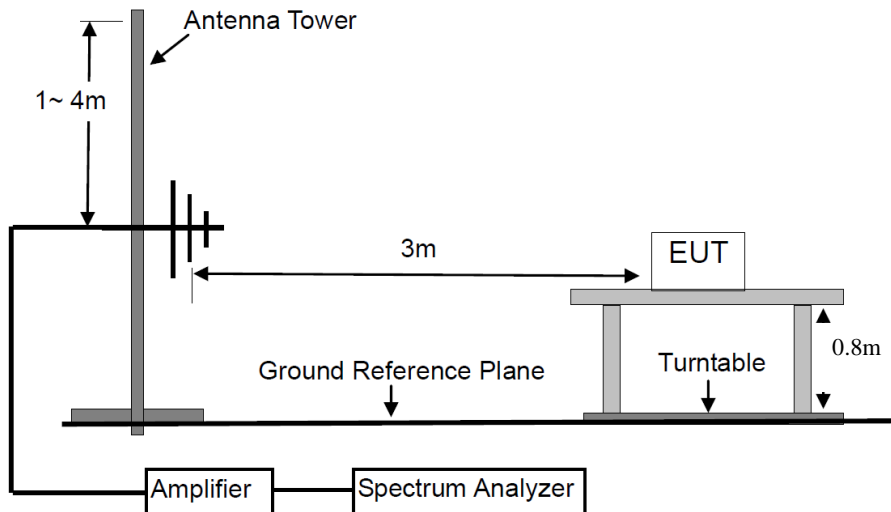

For Radiated Emission Above 1000MHz.

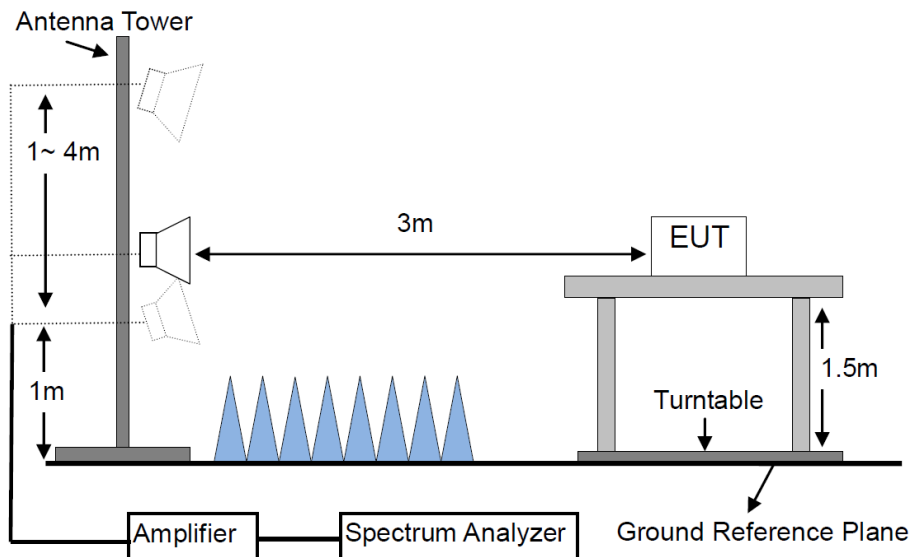

TEST PROCEDURES

- a. Below 1GHz, the EUT was placed on the top of a rotating table 0.8 meters above the ground at a 3 meter semi- anechoic chamber room.
- b. For the radiated emission test above 1GHz:
The EUT was placed on the top of a rotating table 1.5 meters above the ground at a 3 meter full anechoic chamber room. The table was rotated 360 degrees to determine the position of the highest radiation. Place the measurement antenna away from each area of the EUT determined to be a source of emissions at the specified measurement distance, while keeping the measurement antenna aimed at the source of emissions at each frequency of significant emissions, with polarization oriented for maximum response. The measurement antenna may have to be higher or lower than the EUT, depending on the radiation pattern of the emission and staying aimed at the emission source for receiving the maximum signal. The final measurement antenna elevation shall be that which maximizes the emissions. The measurement antenna elevation for maximum emissions shall be restricted to a range of heights of from 1 m to 4 m above the ground or reference ground plane.
- c. The EUT was set 3 meters away from the interference-receiving antenna, which was mounted on the top of a variable-height antenna tower.
- d. The height of antenna is varied from one meter to four meters above the ground to determine the maximum value of the field strength. Both horizontal and vertical polarizations of the antenna are set to make the measurement.
- e. For each suspected emission, the EUT was arranged to its worst case and then the antenna was tuned to heights from 1 meter to 4 meters and the rotatable table was turned from 0 degrees to 360 degrees to find the maximum reading. The test-receiver system was set to peak detect function and specified bandwidth with maximum hold mode.
- f. A Quasi-peak measurement was then made for that frequency point for below 1GHz test. PK and AV for above 1GHz emission test.

During the radiated emission test, the spectrum analyzer was set with the following configurations:

Frequency Band	Detector	Resolution Bandwidth	Video Bandwidth
9KHz-90KHz	AVG	300Hz	1KHz
91KHz-109KHz	QP	300Hz	1KHz
110KHz-490KHz	AVG	300Hz/ 9KHz	1KHz /30KHz
150KHz-30MHz	QP	10KHz	30KHz
30MHz-1000MHz	QP	120KHz	300KHz
Above 1000MHz	Peak	1 MHz	3 MHz
	Average	1 MHz	10 Hz

TEST RESULTS

PASS

Please refer to the following pages of the worst case.

M/N: WCP HBP 01-02	Testing Voltage: AC 120V 60Hz
Polarization: Horizontal	Detector: AV,QP
Test Mode: 1	Distance: 3m

Radiated Emission Measurement

Date: 2023/4/19

Time: 9:20:35

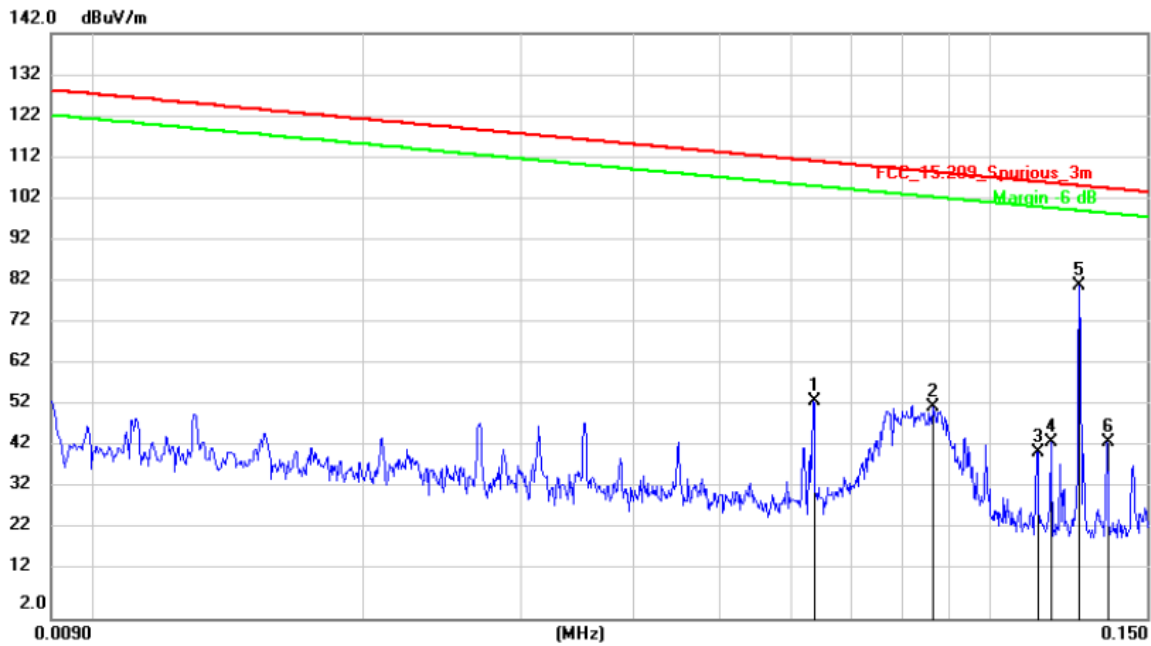

No.	Mk.	Freq.	Reading Level	Correct Factor	Measurement	Limit	Over	Detector	Comment
		MHz	dBuV	dB/m	dBuV/m	dBuV/m	dB		
1		0.0636	33.50	20.53	54.03	111.44	-57.41	AVG	
2		0.0864	32.13	20.54	52.67	108.79	-56.12	AVG	
3		0.1132	21.30	20.53	41.83	106.46	-64.63	AVG	
4		0.1171	23.72	20.53	44.25	106.16	-61.91	AVG	
5	*	0.1259	61.07	20.53	81.60	105.54	-23.94	AVG	
6		0.1352	23.80	20.53	44.33	104.92	-60.59	AVG	

M/N: WCP HBP 01-02	Testing Voltage: AC 120V 60Hz
Polarization: Vertical	Detector: AV,QP
Test Mode: 1	Distance: 3m

Radiated Emission Measurement

Date: 2023/4/19

Time: 9:38:15

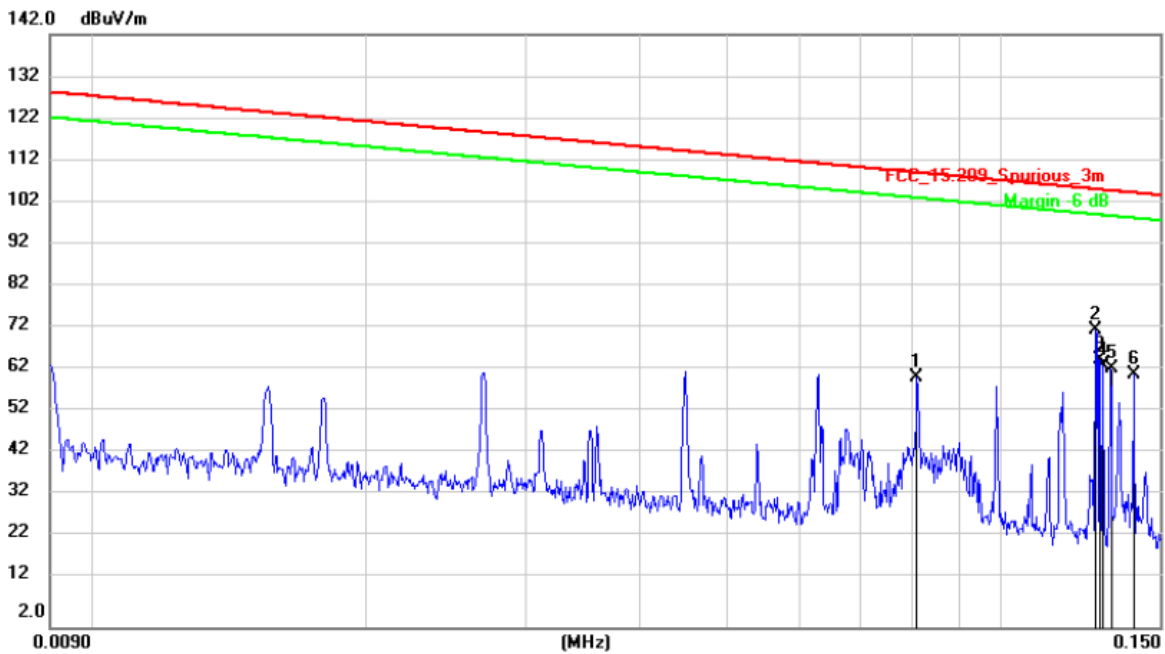

No.	Mk.	Freq.	Reading Level	Correct Factor	Measurement	Limit	Over	Detector	Comment
		MHz	dBuV	dB/m	dBuV/m	dBuV/m	dB		
1		0.0810	40.31	20.53	60.84	109.35	-48.51	AVG	
2	*	0.1274	51.52	20.53	72.05	105.44	-33.39	AVG	
3		0.1285	44.72	20.53	65.25	105.36	-40.11	AVG	
4		0.1296	43.11	20.53	63.64	105.29	-41.65	AVG	
5		0.1322	42.65	20.53	63.18	105.12	-41.94	AVG	
6		0.1402	41.20	20.53	61.73	104.61	-42.88	AVG	

M/N: WCP HBP 01-02	Testing Voltage: AC 120V 60Hz
Polarization: Horizontal	Detector: AV,QP
Test Mode: 1	Distance: 3m

Radiated Emission Measurement

Date: 2023/4/19

Time: 9:26:46

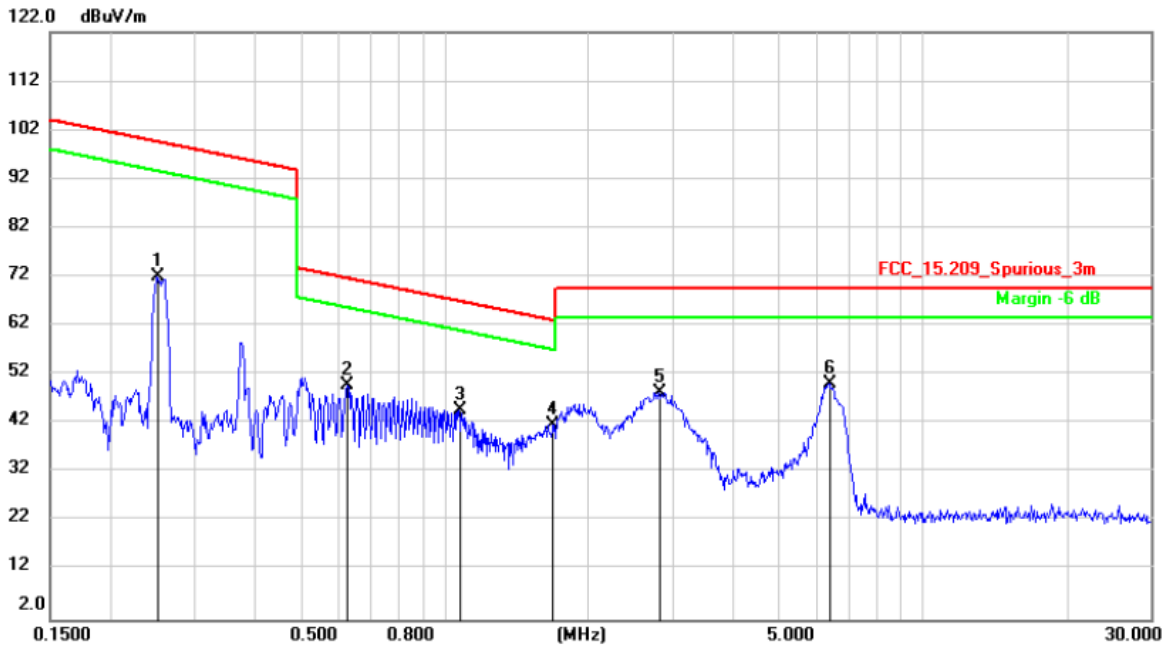

No.	Mk.	Freq.	Reading Level	Correct Factor	Measurement	Limit	Over	Detector	Comment
		MHz	dBuV	dB/m	dBuV/m	dBuV/m	dB		
1		0.2508	51.48	20.50	71.98	99.58	-27.60	AVG	
2		0.6271	29.43	20.43	49.86	71.66	-21.80	QP	
3		1.0710	24.21	20.40	44.61	67.01	-22.40	QP	
4		1.6891	21.41	20.40	41.81	63.05	-21.24	QP	
5		2.8091	28.07	20.40	48.47	69.50	-21.03	QP	
6	*	6.3859	29.80	20.47	50.27	69.50	-19.23	QP	

M/N: WCP HBP 01-02	Testing Voltage: AC 120V 60Hz
Polarization: Vertical	Detector: AV,QP
Test Mode: 1	Distance: 3m

Radiated Emission Measurement

Date: 2023/4/19

Time: 9:32:50

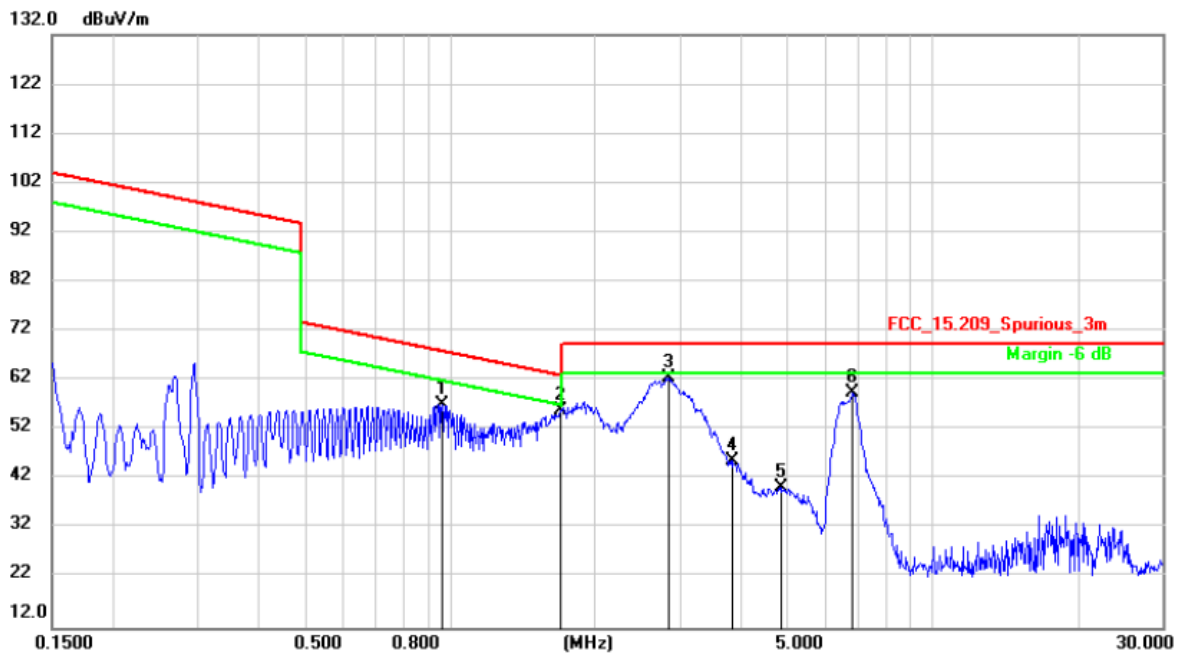

No.	Mk.	Freq.	Reading Level	Correct Factor	Measurement	Limit	Over	Detector	Comment
		MHz	dBuV	dB/m	dBuV/m	dBuV/m	dB		
1		0.9632	36.74	20.40	57.14	67.93	-10.79	QP	
2	*	1.6980	35.64	20.40	56.04	63.01	-6.97	QP	
3		2.8389	42.05	20.40	62.45	69.50	-7.05	QP	
4		3.8603	25.45	20.43	45.88	69.50	-23.62	QP	
5		4.8738	19.87	20.45	40.32	69.50	-29.18	QP	
6		6.8412	38.99	20.48	59.47	69.50	-10.03	QP	

M/N: WCP HBP 01-02	Testing Voltage: AC 120V 60Hz
Polarization: Horizontal	Detector: QP
Test Mode: 1	Distance: 3m

Radiated Emission Measurement

Date: 2023/4/19

Time: 9:43:47

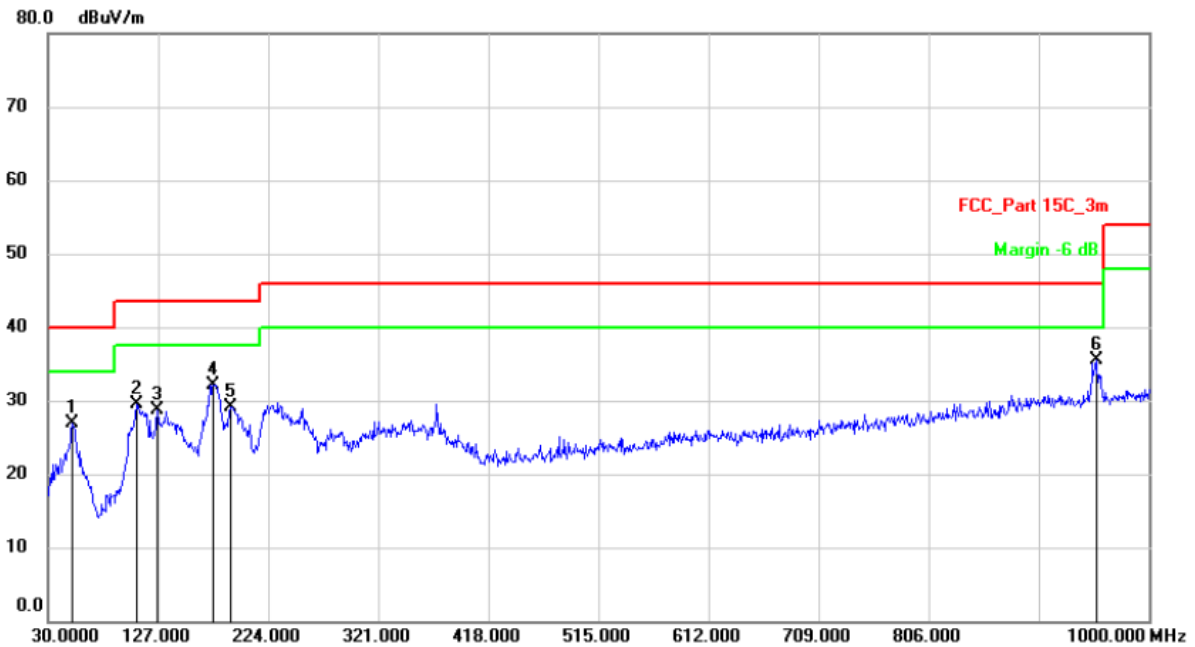

No.	Mk.	Freq.	Reading Level	Correct Factor	Measurement	Limit	Over	Detector	Comment
		MHz	dBuV	dB/m	dBuV/m	dBuV/m	dB		
1		51.3400	34.01	-7.05	26.96	40.00	-13.04	QP	
2		107.6000	36.96	-7.54	29.42	43.50	-14.08	QP	
3		126.0300	38.71	-10.10	28.61	43.50	-14.89	QP	
4		175.5000	41.68	-9.61	32.07	43.50	-11.43	QP	
5		191.0200	37.24	-8.20	29.04	43.50	-14.46	QP	
6	*	953.4400	29.19	6.28	35.47	46.00	-10.53	QP	

M/N: WCP HBP 01-02	Testing Voltage: AC 120V 60Hz
Polarization: Vertical	Detector: QP
Test Mode: 1	Distance: 3m

Radiated Emission Measurement

Date: 2023/4/19

Time: 9:49:03

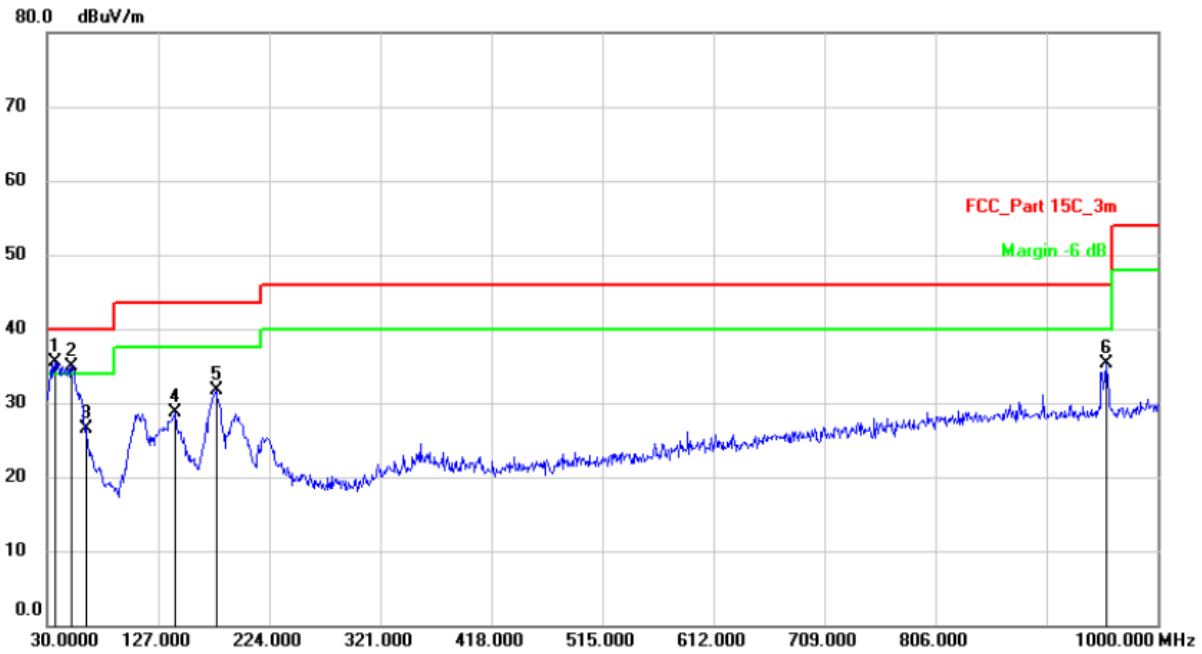

No.	Mk.	Freq. MHz	Reading Level dBuV	Correct Factor dB/m	Measure- ment dBuV/m	Limit dBuV/m	Over dB	Detector	Comment
1	*	36.7900	44.06	-8.61	35.45	40.00	-4.55	QP	
2	!	51.3400	42.10	-7.13	34.97	40.00	-5.03	QP	
3		63.9500	35.51	-9.06	26.45	40.00	-13.55	QP	
4		141.5500	40.29	-11.54	28.75	43.50	-14.75	QP	
5		177.4400	41.29	-9.62	31.67	43.50	-11.83	QP	
6		955.3800	30.21	5.10	35.31	46.00	-10.69	QP	

M/N: WCP BL 02	Testing Voltage: AC 120V 60Hz
Polarization: Horizontal	Detector: AV,QP
Test Mode: 1	Distance: 3m

Radiated Emission Measurement

Date: 2023/4/19

Time: 10:04:35

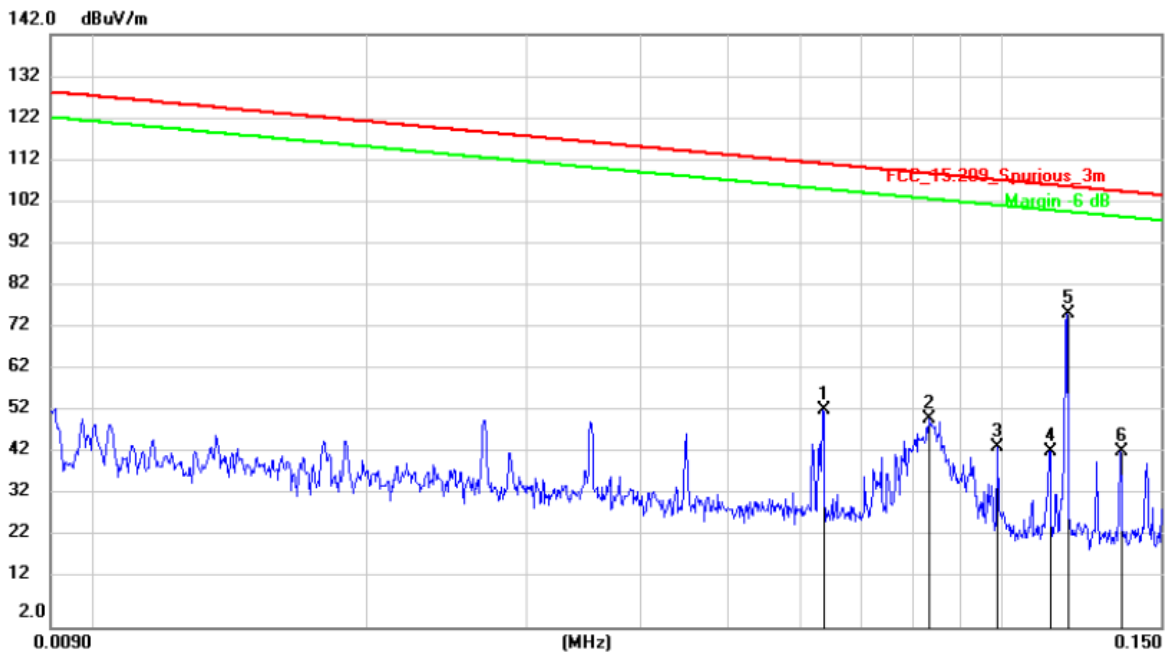

No.	Mk.	Freq.	Reading Level	Correct Factor	Measurement	Limit	Over	Detector	Comment
		MHz	dBuV	dB/m	dBuV/m	dBuV/m	dB		
1		0.0636	32.83	20.53	53.36	111.44	-58.08	AVG	
2		0.0833	30.59	20.53	51.12	109.11	-57.99	AVG	
3		0.0991	24.03	20.54	44.57	107.61	-63.04	QP	
4		0.1132	22.98	20.53	43.51	106.46	-62.95	AVG	
5	*	0.1181	55.57	20.53	76.10	106.09	-29.99	AVG	
6		0.1352	22.80	20.53	43.33	104.92	-61.59	AVG	

M/N: WCP BL 02	Testing Voltage: AC 120V 60Hz
Polarization: Vertical	Detector: AV,QP
Test Mode: 1	Distance: 3m

Radiated Emission Measurement

Date: 2023/4/19

Time: 10:20:47

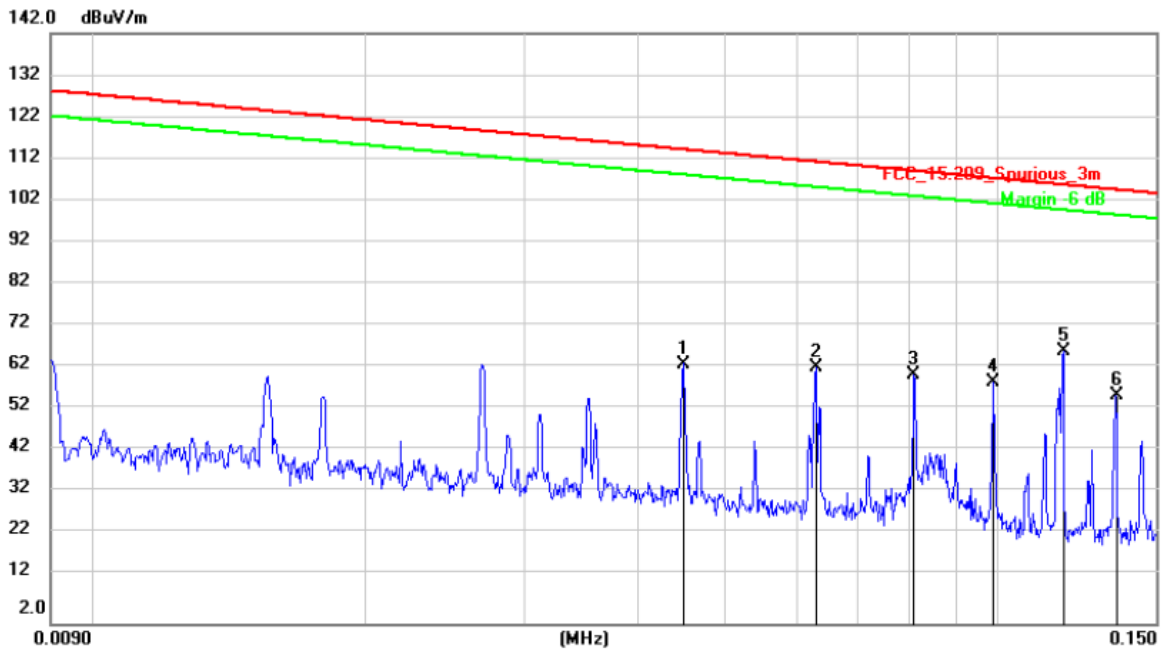

No.	Mk.	Freq.	Reading Level	Correct Factor	Measurement	Limit	Over	Detector	Comment
		MHz	dBuV	dB/m	dBuV/m	dBuV/m	dB		
1		0.0450	43.01	20.59	63.60	114.42	-50.82	AVG	
2		0.0631	42.30	20.53	62.83	111.50	-48.67	AVG	
3		0.0810	40.60	20.53	61.13	109.35	-48.22	AVG	
4		0.0991	38.76	20.54	59.30	107.61	-48.31	QP	
5	*	0.1184	45.97	20.53	66.50	106.07	-39.57	AVG	
6		0.1352	35.51	20.53	56.04	104.92	-48.88	AVG	

M/N: WCP BL 02	Testing Voltage: AC 120V 60Hz
Polarization: Horizontal	Detector: AV,QP
Test Mode: 1	Distance: 3m

Radiated Emission Measurement

Date: 2023/4/19

Time: 10:10:01

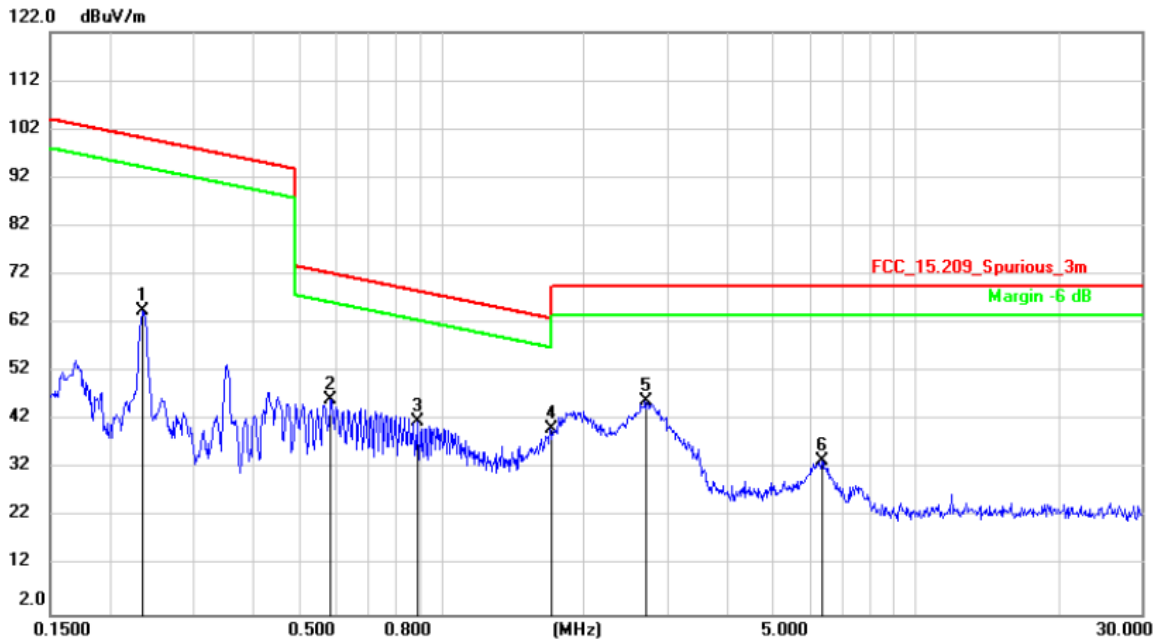

No.	Mk.	Freq.	Reading Level	Correct Factor	Measurement	Limit	Over	Detector	Comment
		MHz	dBuV	dB/m	dBuV/m	dBuV/m	dB		
1		0.2353	44.03	20.50	64.53	100.14	-35.61	AVG	
2		0.5854	25.78	20.44	46.22	72.25	-26.03	QP	
3		0.8897	21.41	20.40	41.81	68.62	-26.81	QP	
4	*	1.6981	19.80	20.40	40.20	63.01	-22.81	QP	
5		2.6925	25.52	20.40	45.92	69.50	-23.58	QP	
6		6.3520	13.07	20.47	33.54	69.50	-35.96	QP	

M/N: WCP BL 02	Testing Voltage: AC 120V 60Hz
Polarization: Vertical	Detector: AV,QP
Test Mode: 1	Distance: 3m

Radiated Emission Measurement

Date: 2023/4/19

Time: 10:15:39

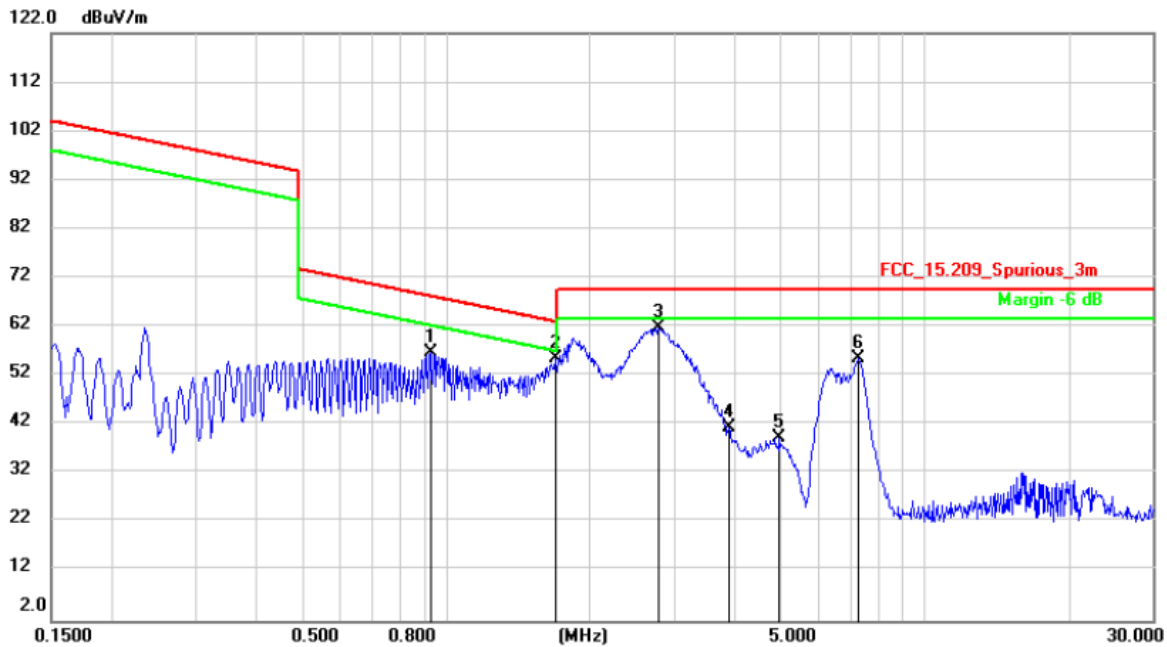

No.	Mk.	Freq.	Reading Level	Correct Factor	Measurement	Limit	Over	Detector	Comment
		MHz	dBuV	dB/m	dBuV/m	dBuV/m	dB		
1		0.9282	36.25	20.40	56.65	68.25	-11.60	QP	
2	*	1.6980	35.17	20.40	55.57	63.01	-7.44	QP	
3		2.7794	41.42	20.40	61.82	69.50	-7.68	QP	
4		3.9014	20.96	20.43	41.39	69.50	-28.11	QP	
5		4.9780	18.83	20.45	39.28	69.50	-30.22	QP	
6		7.2517	35.15	20.50	55.65	69.50	-13.85	QP	

M/N: WCP BL 02	Testing Voltage: AC 120V 60Hz
Polarization: Horizontal	Detector: QP
Test Mode: 1	Distance: 3m

Radiated Emission Measurement

Date: 2023/4/19

Time: 9:59:17

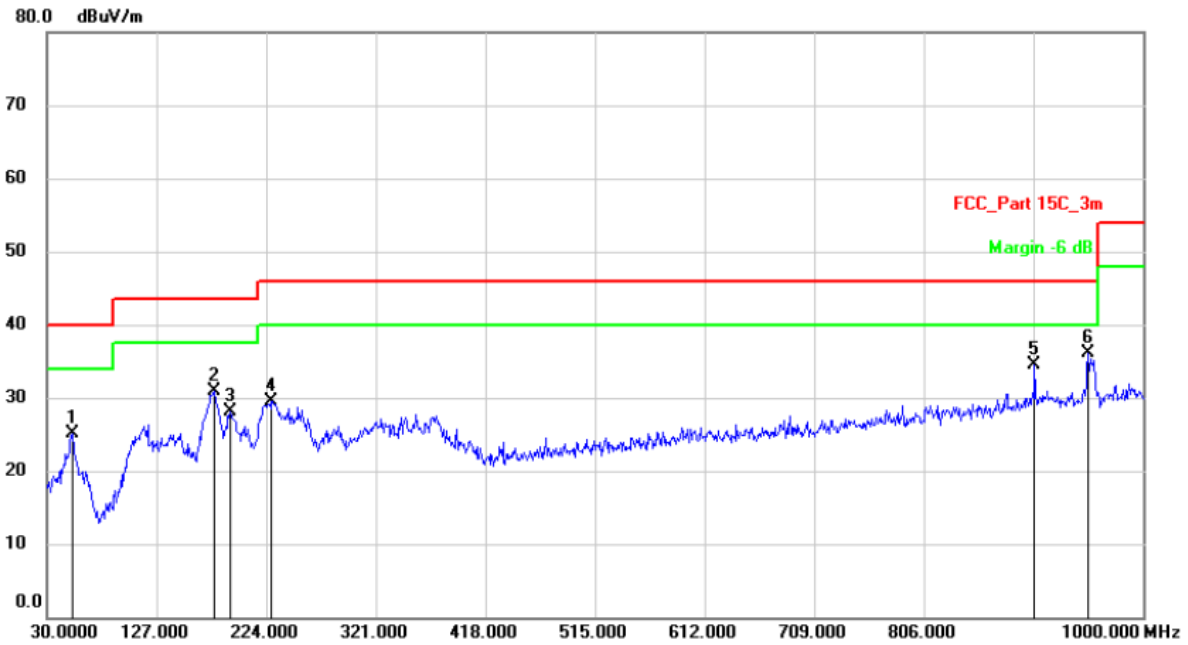

No.	Mk.	Freq.	Reading Level	Correct Factor	Measurement	Limit	Over	Detector	Comment
		MHz	dBuV	dB/m	dBuV/m	dBuV/m	dB		
1		52.3100	32.25	-7.17	25.08	40.00	-14.92	QP	
2		177.4400	40.40	-9.45	30.95	43.50	-12.55	QP	
3		191.9900	36.26	-8.12	28.14	43.50	-15.36	QP	
4		228.8500	36.58	-7.02	29.56	46.00	-16.44	QP	
5		903.9700	28.38	6.20	34.58	46.00	-11.42	QP	
6	*	951.5000	29.81	6.28	36.09	46.00	-9.91	QP	

M/N: WCP BL 02	Testing Voltage: AC 120V 60Hz
Polarization: Vertical	Detector: QP
Test Mode: 1	Distance: 3m

Radiated Emission Measurement

Date: 2023/4/19

Time: 9:54:11

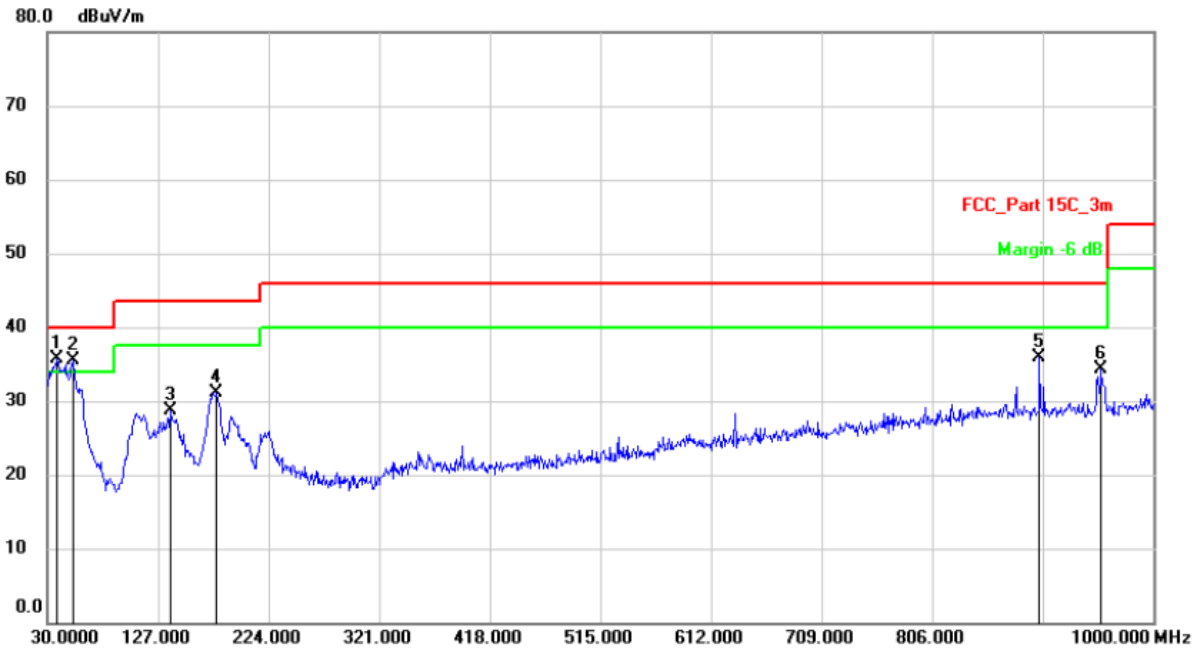

No.	Mk.	Freq. MHz	Reading Level dBuV	Correct Factor dB/m	Measure- ment dBuV/m	Limit dBuV/m	Over dB	Detector	Comment
1	*	38.7300	43.89	-8.11	35.78	40.00	-4.22	QP	
2	!	52.3100	42.77	-7.30	35.47	40.00	-4.53	QP	
3		137.6700	40.11	-11.42	28.69	43.50	-14.81	QP	
4		178.4100	40.73	-9.54	31.19	43.50	-12.31	QP	
5		900.0900	30.85	4.96	35.81	46.00	-10.19	QP	
6		954.4100	29.15	5.10	34.25	46.00	-11.75	QP	

13.3 20dB Bandwidth Measurement

LIMITS

There is no limit.

BLOCK DIAGRAM OF TEST SETUP

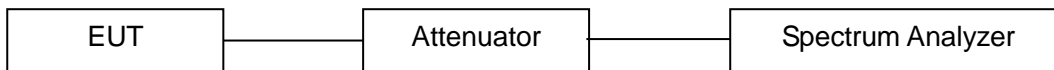

TEST PROCEDURES

The 20dB bandwidth of the emission was contained within the frequency band designated which the EUT operated. The effects, if any, from frequency sweeping, frequency hopping, other modulation techniques and frequency stability over excepted variations in temperature and supply voltage were considered, FCC Rule 15.35:

The antenna port of the EUT was connected to the input of a spectrum analyzer. Analyzer RBW was chosen so that the display was a result of the tested channel modulation. For each RF output channel investigated, the spectrum analyzer center frequency was set to the channel carrier. Use the spectrum 20dB down delta function to measure the bandwidth.

TEST RESULTS

PASS

Please refer to the following table.

FSK		
Frequency (KHz)	20dB Bandwidth (Hz)	Result
121.0516	278.4	PASS



*RBW 100 Hz Marker 1 [T1]
 *VBW 300 Hz 51.34 dBμV
 Ref 70 dBμV *Att 25 dB SWT 100 ms 121.051600000 kHz

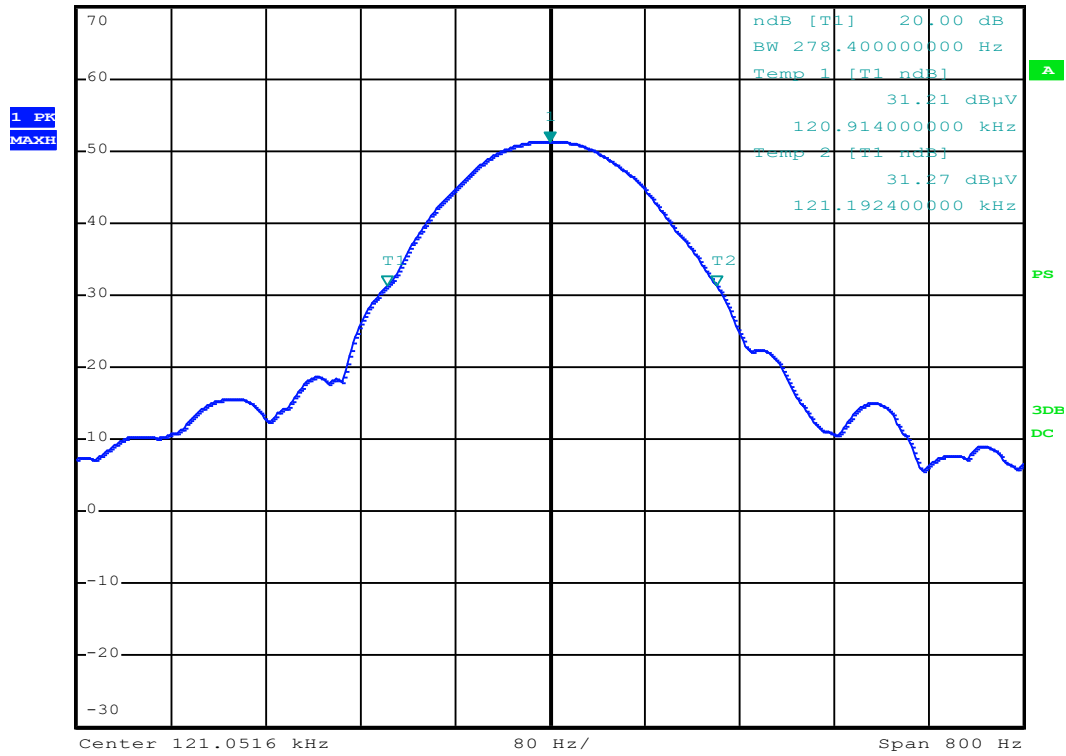

Date: 17.APR.2063 23:56:04

13.4 Antenna Requirement

STANDARD APPLICABLE

According to of FCC part 15C section 15.203:

An intentional radiator shall be designed to ensure that no antenna other than that furnished by the responsible party shall be used with the device. The use of a permanently attached antenna or of an antenna that uses a unique coupling to the intentional radiator, the manufacturer may design the unit so that a broken antenna can be replaced by the user, but the use of a standard antenna jack or electrical connector is prohibited.

Systems operating in the 2400-2483.5MHz band that are used exclusively for fixed, point-to-point operations may employ transmitting antennas with directional gain greater than 6dBi provided the maximum peak output power of the intentional radiator is reduced by 1dB for every 3dB that the directional gain of the antenna exceeds 6dBi.

ANTENNA CONNECTED CONSTRUCTION

The antenna is Coil antenna that no antenna other than furnished by the responsible party shall be used with the device. Therefore, the antenna is consider meet the requirement.

14. Test Equipment List

Item	Equipment	Manufacturer	Model No.	Serial No.	Last Cal.	Cal. Interval
1.	Test Receiver	Rohde & Schwarz	ESCI7	100837	Mar. 13, 2023	1 Year
2.	Antenna	Schwarzbeck	VULB9162	9162-010	Mar. 23, 2022	2 Year
3.	Spectrum Analyzer	Rohde & Schwarz	FSU26	200409/026	Mar. 13, 2023	1 Year
4.	Spectrum Analyzer	Keysight	N9020A	MY54200831	Mar. 13, 2023	1 Year
5.	Spectrum Analyzer	Rohde & Schwarz	FSV40	101094	Mar. 13, 2023	1 Year
6.	Horn Antenna	Schwarzbeck	BBHA9170	9170-172	Mar. 23, 2022	2 Year
7.	Power Sensor	DARE	RPR3006W	15I00041SNO 64	Mar. 13, 2023	1 Year
8.	Communication Tester	Rohde & Schwarz	CMW500	149004	Mar. 13, 2023	1 Year
9.	Horn Antenna	COM-Power	AH-118	071078	Mar. 23, 2022	2 Year
10.	Pre-Amplifier	HP	HP 8449B	3008A00964	Mar. 13, 2023	1 Year
11.	Pre-Amplifier	HP	HP 8447D	1145A00203	Mar. 13, 2023	1 Year
12.	Loop Antenna	Schwarzbeck	FMZB 1513	1513-272	Mar. 23, 2022	2 Year
13.	Test Receiver	Rohde & Schwarz	ESCI	101152	Mar. 14, 2023	1 Year
14.	L.I.S.N	Rohde & Schwarz	ENV 216	101317	Mar. 13, 2023	1 Year
15.	L.I.S.N	Rohde & Schwarz	ESH2-Z5	893606/014	Mar. 13, 2023	1 Year
16.	RF Switching Unit	Compliance Direction Systems Inc.	RSU-M2	38311	Mar.13, 2023	1 Year
17.	Temperature & Humidity Chamber	REMAFEE	SYHR225L	N/A	Mar. 13, 2023	1 Year
18.	DC Source	Maynuo	MY8811	N/A	Mar. 13, 2023	1 Year
19.	Temporary antenna connector	TESCOM	SS402	N/A	N/A	N/A
20.	Chamber	SAEMC	9*7*7m	N/A	Apr. 21, 2023	2 Year
21.	Test Software	EZ	EZ_EMCC, NTC-3A1.1	N/A	N/A	N/A

Note: For photographs of EUT and measurement, please refer to appendix in separate documents.

---End---