



Report No.: EA1909290F 01001

1 of 39

**ELECTROMAGNETIC EMISSIONS COMPLIANCE REPORT
INTENTIONAL RADIATOR CERTIFICATION TO
FCC PART 15 SUBPART C REQUIREMENT**

OF

Embedded wireless charger

Model No.: WCP BL 02

Trademark: 

FCC ID: YZHWCPBL02

Report No.: EA1909290F 01001

Issue Date: September 28, 2019

Prepared for

**Raffel Systems, LLC
N112 W14600 Mequon Road, Germantown, WI 53022, USA**

Prepared by

Dong Guan Anci Electronic Technology Co., Ltd.

**1-2 Floor, Building A, No.11, Headquarters 2 Road, Songshan, Lake
Hi-tech Industrial Development Zone, Dongguan City, evelopment
Zone, Dongguan City, Guangdong Pr., China.**

**This report shall not be reproduced, except in full, without the written approval of
Dong Guan Anci Electronic Technology Co., Ltd.**



VERIFICATION OF COMPLIANCE

Applicant:	Raffel Systems, LLC N112 W14600 Mequon Road, Germantown, WI 53022, USA
Manufacturer:	Raffel Systems, LLC N112 W14600 Mequon Road, Germantown, WI 53022, USA
Factory:	FORTRESS ELECTRONICS (XIAMEN) CO.,LTD East of the fifth floor, 181 banqiao road, jimei district, Xiamen, Fujian, China
Product Description:	Embedded wireless charger
Trade Mark:	
Model Number:	WCP BL 02

We hereby certify that:

The above equipment was tested by Dong Guan Anci Electronic Technology Co., Ltd. The test data, data evaluation, test procedures, and equipment configurations shown in this report were made in accordance with the procedures given in ANSI C63.10-2013 and the energy emitted by the sample EUT tested as described in this report is in compliance with conducted and radiated emission limits of FCC Rules Part 15.209.

Date of Test : September 26, 2019 to September 28, 2019

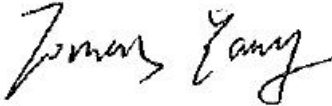
Prepared by : 
Tomas Yang/Supervisor

Reviewer & Authorized Signer : 
Alan He/Manager



Report No.: EA1909290F 01001

3 of 39

Modified Information

Version	Summary	Revision Date	Report No.
Ver.1.0	Original Report	/	EA1909290F 01001



Table of Contents

- 1 GENERAL INFORMATION.....5**

 - 1.1 PRODUCT DESCRIPTION..... 5
 - 1.2 RELATED SUBMITTAL(S) / GRANT(S)..... 6
 - 1.3 TEST METHODOLOGY..... 6
 - 1.4 SPECIAL ACCESSORIES..... 6
 - 1.5 EQUIPMENT MODIFICATIONS..... 6
 - 1.6 TEST FACILITY..... 6

- 2 SYSTEM TEST CONFIGURATION.....7**

 - 2.1 EUT CONFIGURATION..... 7
 - 2.2 EUT EXERCISE..... 7
 - 2.3 TEST PROCEDURE..... 7
 - 2.4 CONFIGURATION OF TESTED SYSTEM..... 8

- 3 SUMMARY OF TEST RESULTS..... 8**
- 4 CONDUCTED EMISSIONS TEST..... 9**

 - 4.1 MEASUREMENT PROCEDURE..... 9
 - 4.2 TEST SET-UP (BLOCK DIAGRAM OF CONFIGURATION)..... 9
 - 4.3 MEASUREMENT EQUIPMENT USED..... 9
 - 4.4 CONDUCTED EMISSION LIMIT..... 9
 - 4.5 MEASUREMENT RESULT..... 10
 - 4.6 CONDUCTED MEASUREMENT PHOTO..... 19

- 5 RADIATED EMISSION TEST.....20**

 - 5.1 MEASUREMENT PROCEDURE..... 20
 - 5.2 TEST SET-UP (BLOCK DIAGRAM OF CONFIGURATION).....20
 - 5.3 MEASUREMENT EQUIPMENT USED..... 21
 - 5.4 RADIATED EMISSION LIMIT..... 21
 - 5.5 MEASUREMENT RESULT..... 23
 - 5.6 RADIATED MEASUREMENT PHOTOS..... 32

- 6 20DB BANDWIDTH.....33**

 - 6.1 20dB BANDWIDTH LIMIT..... 33
 - 6.2 TEST INSTRUMENTS..... 33
 - 6.3 TEST PROCEDURE..... 33
 - 6.4 TEST SETUP..... 33
 - 6.5 TEST RESULT..... 33

- 7 ANTENNA APPLICATION.....35**

 - 7.1 ANTENNA REQUIREMENT..... 35
 - 7.2 RESULT..... 35



1 General Information

1.1 Product Description

Characteristics	Description
Product Name	Embedded wireless charger
Model number	WCP BL 02
Operation Mode	Wireless Charging
Input Rating	AC 100-120V 50/60Hz 1.5A
Power Supply	AC120V/60Hz and AC 240V/50Hz for adapter
Operating Frequency	110-205KHz
Wireless Charging Power	10W Max(Backward compatible with 5W)
Modulation Technique	ASK
Antenna Type	Induction coil



1.2 Related Submittal(s) / Grant(s)

This submittal(s) (test report) is intended for FCC ID: YZHWCPBL02 filing to comply with the FCC Part 15, Subpart C Rules.

1.3 Test Methodology

Both conducted and radiated testing was performed according to the procedures in ANSI C63.10 (2013). Radiated testing was performed at an antenna to EUT distance 3 meters.

1.4 Special Accessories

Not available for this EUT intended for grant.

1.5 Equipment Modifications

Not available for this EUT intended for grant.

1.6 Test Facility

Site Description
EMC Lab. : Accredited by CNAS, 2017.06.26
The certificate is valid until 2022.10.28
The Laboratory has been assessed and proved to be in compliance with
CNAS-CL01:2006 (identical to ISO/IEC 17025:2005)
The Certificate Registration Number is L0468.

Accredited by A2LA, 2018.03.15
The Certificate Number is 4422.01.

Name of Firm : Dong Guan Anci Electronic Technology Co., Ltd.
Site Location : 1-2 Floor, Building A, No.11, Headquarters 2 Road, Songshan, Lake
Hi-tech Industrial Development Zone, Dongguan City, development Zone,
Dongguan City, Guangdong Pr., China.



2 System Test Configuration

2.1 EUT Configuration

The EUT configuration for testing is installed on RF field strength measurement to meet the Commissions requirement and operating in a manner which intends to maximize its emission characteristics in a continuous normal application.

2.2 EUT Exercise

The Transmitter was operated in the normal operating mode. The TX frequency was fixed which was for the purpose of the measurements.

2.3 Test Procedure

2.3.1 Conducted Emissions

The EUT is a placed on as turn table which is 0.8 m above ground plane. According to the requirements in Section 13.1.4.1 of ANSI C63.10-2013 Conducted emissions from the EUT measured in the frequency range between 0.15 MHz and 30 MHz using CISPR Quasi-Peak and average detector mode.

2.3.2 Radiated Emissions

The EUT is a placed on as turn table which is 0.8 m above ground plane. The turn table shall rotate 360 degrees to determine the position of maximum emission level. EUT is set 3m away from the receiving antenna which varied from 1m to 4m to find out the highest emission. And also, each emission was to be maximized by changing the polarization of receiving antenna both horizontal and vertical. In order to find out the max. emission, the fixed in a particular direction according to the requirements in Section 13.1.4.1 of ANSI C63.10-2013.

2.4 Configuration of Tested System

Fig. 2-1 Configuration of Tested System

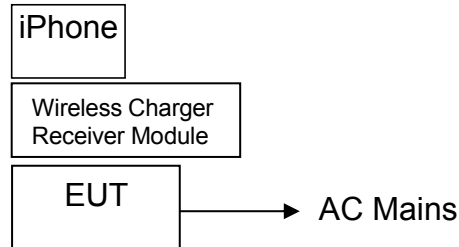

Table 2-1 Equipment Used in Tested System

Item	Equipment	Trade Mark	Model No.	FCC ID	Note
1.	Embedded wireless charger	Raffel Systems	WCP BL 02	YZHWCPBL02	EUT
2.	Adapter	N/A	Model:FS0900-2000 Input: AC 100-240V, 50/60Hz Output: DC 9V, 2000mA	N/A	Support EUT
3.	iPhone	Apple	A1524	N/A	Support Equipment
4.	SAMSUNG S9	SAMSUNG	Samsung Galaxy S9	N/A	Support Equipment
5.	Wireless Charger Receiver Module	Universal	N/A	N/A	Support Equipment

Note:

- (1) Unless otherwise denoted as EUT in 『Remark』 column, device(s) used in tested system is a support equipment.

3 Summary of Test Results

FCC Rules	Description Of Test	Result
§15.207	AC Power Conducted Emission	Compliant
§15.209	Radiated Emission	Compliant
§2.1049	20dB Bandwidth	Compliant
§15.203	Antenna Requirement	Compliant

4 Conducted Emissions Test

4.1 Measurement Procedure

1. The EUT was placed on a table which is 0.8m above ground plane.
2. Maximum procedure was performed on the six highest emissions to ensure EUT compliance.
3. Repeat above procedures until all frequency measured was complete.

4.2 Test SET-UP (Block Diagram of Configuration)

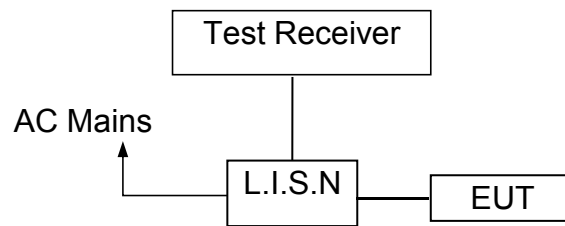

4.3 Measurement Equipment Used

EQUIPMENT TYPE	MFR	MODEL NUMBER	SERIAL NUMBER	Calibrated until
L.I.S.N	SCHWARZBECK	NSLK 8127	8127-669	2020-05-19
10 db attenuator	JFW	50FP-010-H4	4360846-427-1	2020-05-19
RF Cable	N/A	N/A	2#	2020-05-19
EMI Test Receiver	ROHDE&SCHWARZ	ESCI	101358	2020-05-19

4.4 Conducted Emission Limit

Conducted Emission Frequency(MHz)	Quasi-peak	Average
0.15-0.5	66-56	56-46
0.5-5.0	56	46
5.0-30.0	60	50

- Note:** 1. The lower limit shall apply at the transition frequencies
 2. The limit decreases in line with the logarithm of the frequency in the range of 0.15 to 0.50MHz.



4.5 Measurement Result

Operation Mode:	TX	Test Date :	September 26, 2019
Frequency Range:	0.15MHz~30MHz	Temperature :	28°C
Test Result:	PASS	Humidity :	65 %
Test By:	Best		

Pass

We pretested modes (Wireless Charging(10W),Wireless Charging(5W)) for EUT. The test data see follow the table.



Report No.: EA1909290F 01001

11 of 39

Test mode: Wireless Charging 5W use iphone

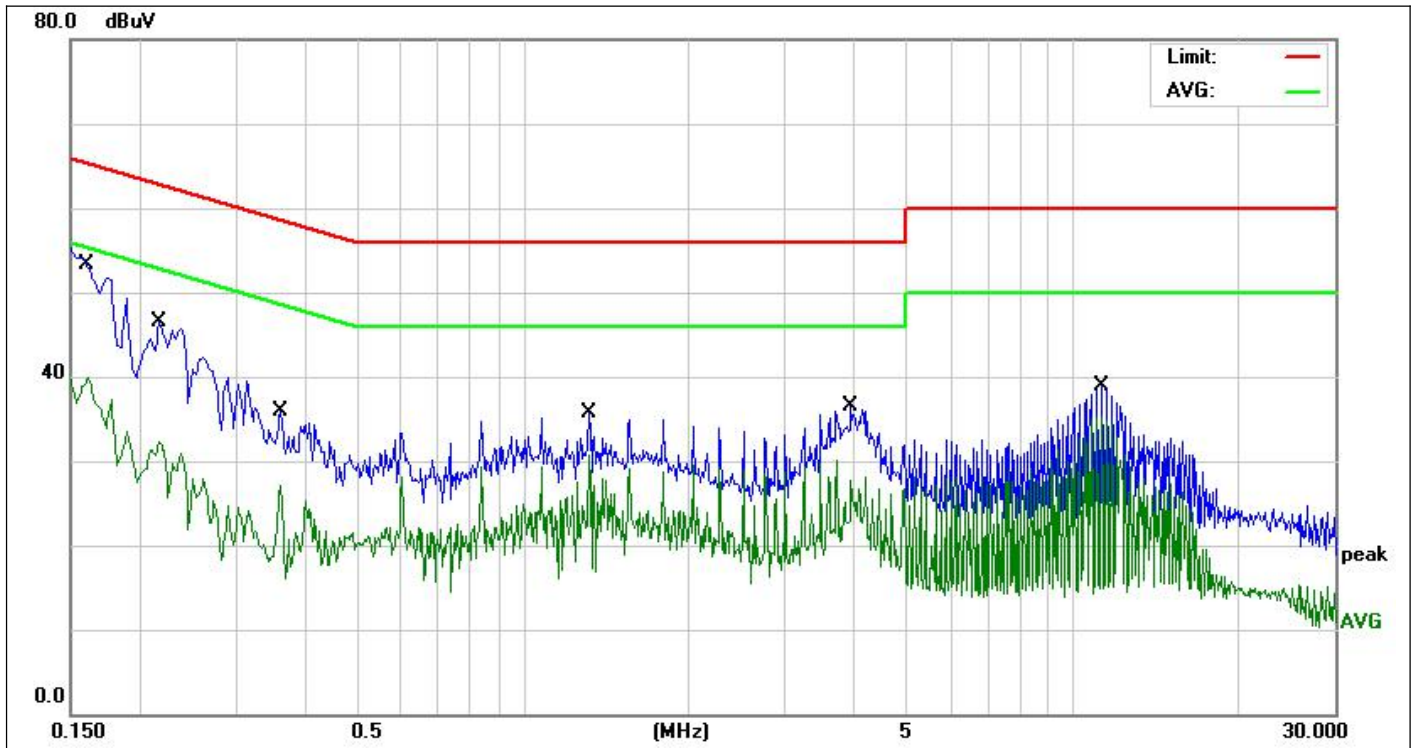

Site:	843	Phase:	N	Temperature(C):	26(C)
Limit:	FCC Part 15 C Conduction(QP)	Test Time:	2019/9/26	Humidity(%):	60%
EUT:	Wireless Charger	Power Rating:	AC 240V/50Hz	Test Engineer:	Jack
M/N.:	WCP BL 02				
Mode:	Wireless Charging 5W				
Note:					

No.	Frequency (MHz)	Reading Level(dBuV)	Factor (dB)	Measurement(dBuV)	Limit (dBuV)	Over (dB)	Detector	Comment
1 *	0.1624	40.52	9.74	50.26	65.34	-15.08	QP	
2	0.1624	25.73	9.74	35.47	55.34	-19.87	AVG	
3	0.2180	34.51	9.81	44.32	62.89	-18.57	QP	
4	0.2180	21.35	9.81	31.16	52.89	-21.73	AVG	
5	0.3620	22.52	9.88	32.40	58.68	-26.28	QP	
6	0.3620	16.80	9.88	26.68	48.68	-22.00	AVG	
7	1.3220	24.19	9.96	34.15	56.00	-21.85	QP	
8	1.3220	20.08	9.96	30.04	46.00	-15.96	AVG	
9	3.9620	24.89	9.94	34.83	56.00	-21.17	QP	
10	3.9620	18.69	9.94	28.63	46.00	-17.37	AVG	
11	11.2940	26.63	9.88	36.51	60.00	-23.49	QP	
12	11.2940	21.76	9.88	31.64	50.00	-18.36	AVG	

*:Maximum data x:Over limit !:over margin

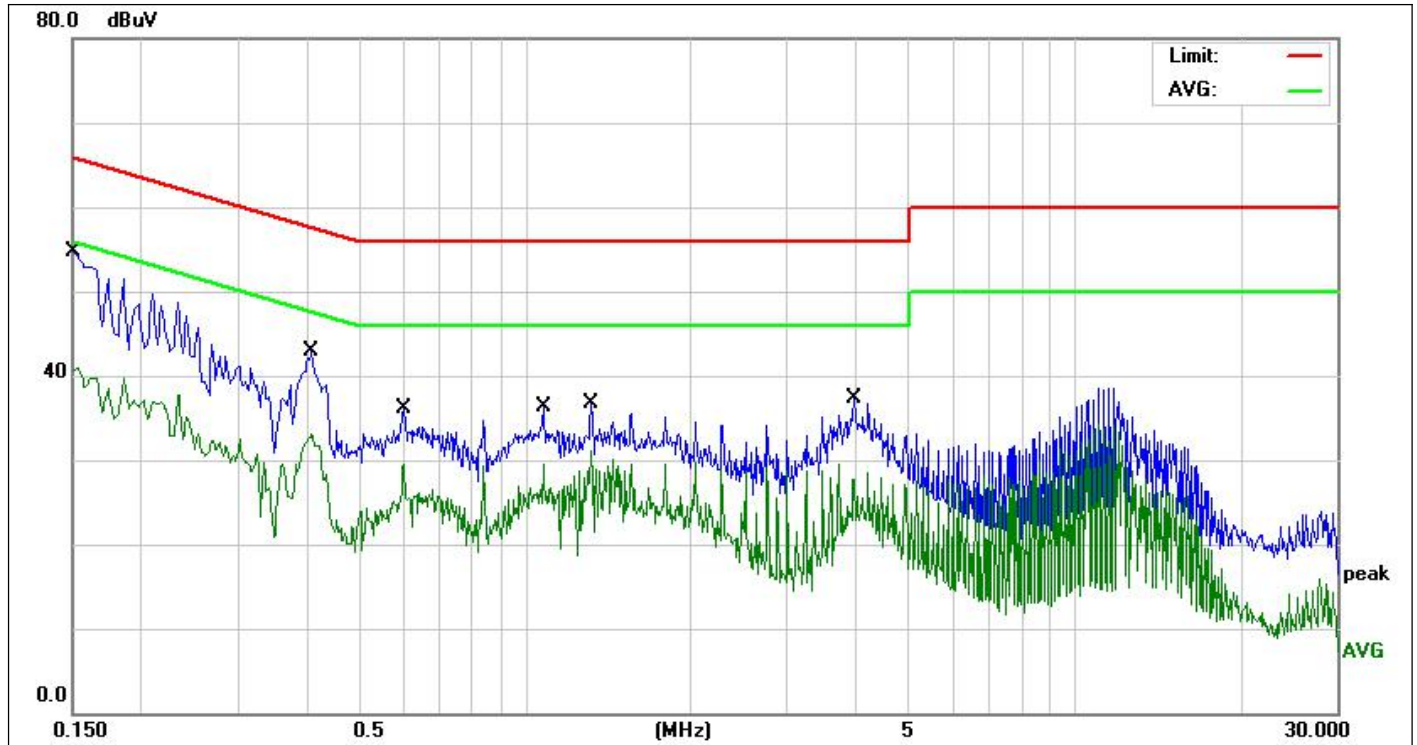

Site:	843	Phase:	L1	Temperature(C):	26(C)
Limit:	FCC Part 15 C Conduction(QP)	Test Time:	2019/9/26	Humidity(%):	60%
EUT:	Wireless Charger	Power Rating:	AC 240V/50Hz	Test Engineer:	Jack
M/N.:	WCP BL 02				
Mode:	Wireless Charging 5W				
Note:					

No.	Frequency (MHz)	Reading Level(dBuV)	Factor (dB)	Measurement(dBuV)	Limit (dBuV)	Over (dB)	Detector	Comment
1 *	0.1500	42.00	9.72	51.72	65.99	-14.27	QP	
2	0.1500	28.03	9.72	37.75	55.99	-18.24	AVG	
3	0.4100	29.66	9.90	39.56	57.65	-18.09	QP	
4	0.4100	21.94	9.90	31.84	47.65	-15.81	AVG	
5	0.6020	23.74	9.96	33.70	56.00	-22.30	QP	
6	0.6020	19.20	9.96	29.16	46.00	-16.84	AVG	
7	1.0820	24.31	10.01	34.32	56.00	-21.68	QP	
8	1.0820	19.92	10.01	29.93	46.00	-16.07	AVG	
9	1.3220	25.23	9.96	35.19	56.00	-20.81	QP	
10	1.3220	20.59	9.96	30.55	46.00	-15.45	AVG	
11	3.9660	24.11	9.94	34.05	56.00	-21.95	QP	
12	3.9660	18.16	9.94	28.10	46.00	-17.90	AVG	

*:Maximum data x:Over limit !:over margin

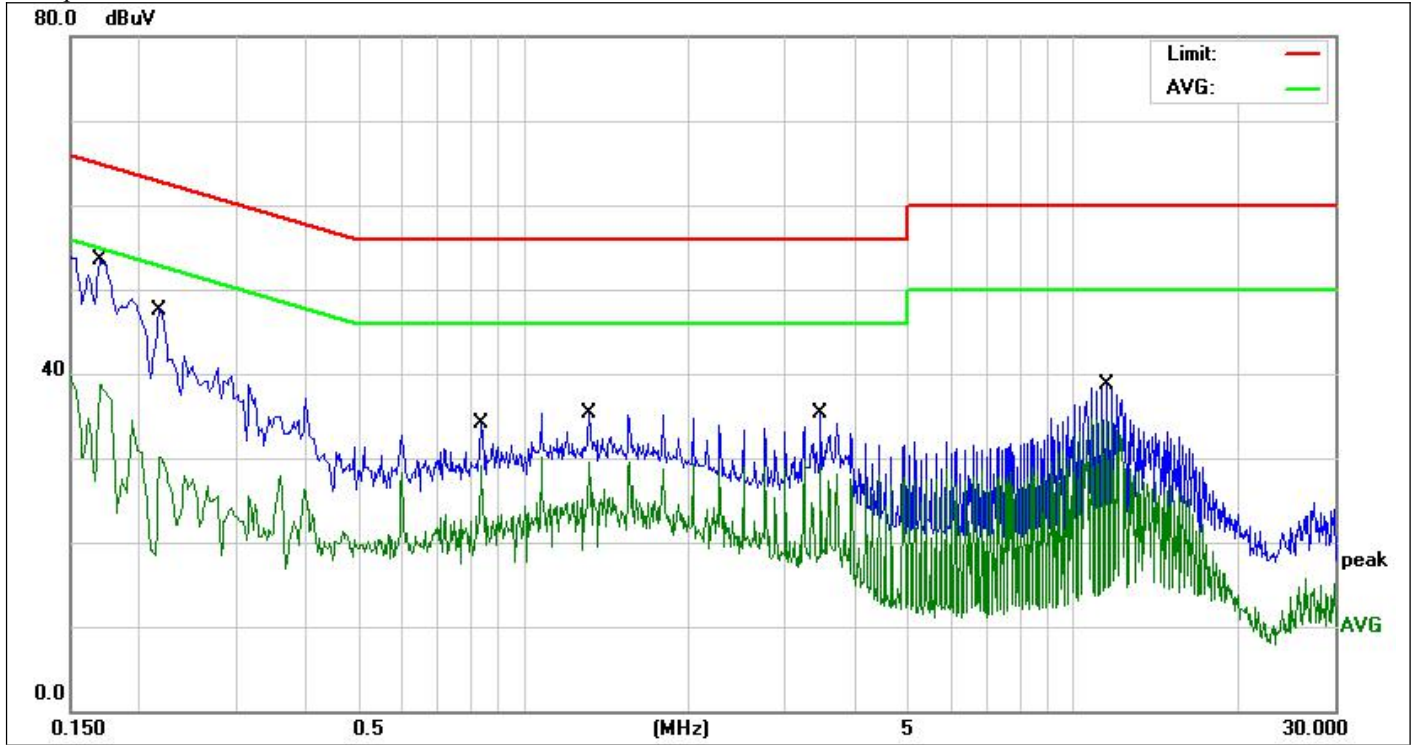

Site:	843	Phase:	N	Temperature(C):	26(C)
Limit:	FCC Part 15 C Conduction(QP)	Test Time:	2019/9/26	Humidity(%):	60%
EUT:	Wireless Charger	Power Rating:	AC 120V/60Hz	Test Engineer:	Jack
M/N.:	WCP BL 02				
Mode:	Wireless Charging 5W				
Note:					

No.	Frequency (MHz)	Reading Level(dBuV)	Factor (dB)	Measurement(dBuV)	Limit (dBuV)	Over (dB)	Detector	Comment
1 *	0.1700	39.17	9.75	48.92	64.96	-16.04	QP	
2	0.1700	21.45	9.75	31.20	54.96	-23.76	AVG	
3	0.2180	32.61	9.81	42.42	62.89	-20.47	QP	
4	0.2180	17.08	9.81	26.89	52.89	-26.00	AVG	
5	0.8420	22.88	10.01	32.89	56.00	-23.11	QP	
6	0.8420	19.12	10.01	29.13	46.00	-16.87	AVG	
7	1.3220	23.98	9.96	33.94	56.00	-22.06	QP	
8	1.3220	19.91	9.96	29.87	46.00	-16.13	AVG	
9	3.4820	22.53	9.91	32.44	56.00	-23.56	QP	
10	3.4820	19.64	9.91	29.55	46.00	-16.45	AVG	
11	11.5300	27.47	9.88	37.35	60.00	-22.65	QP	
12	11.5300	24.04	9.88	33.92	50.00	-16.08	AVG	

*:Maximum data x:Over limit !:over margin

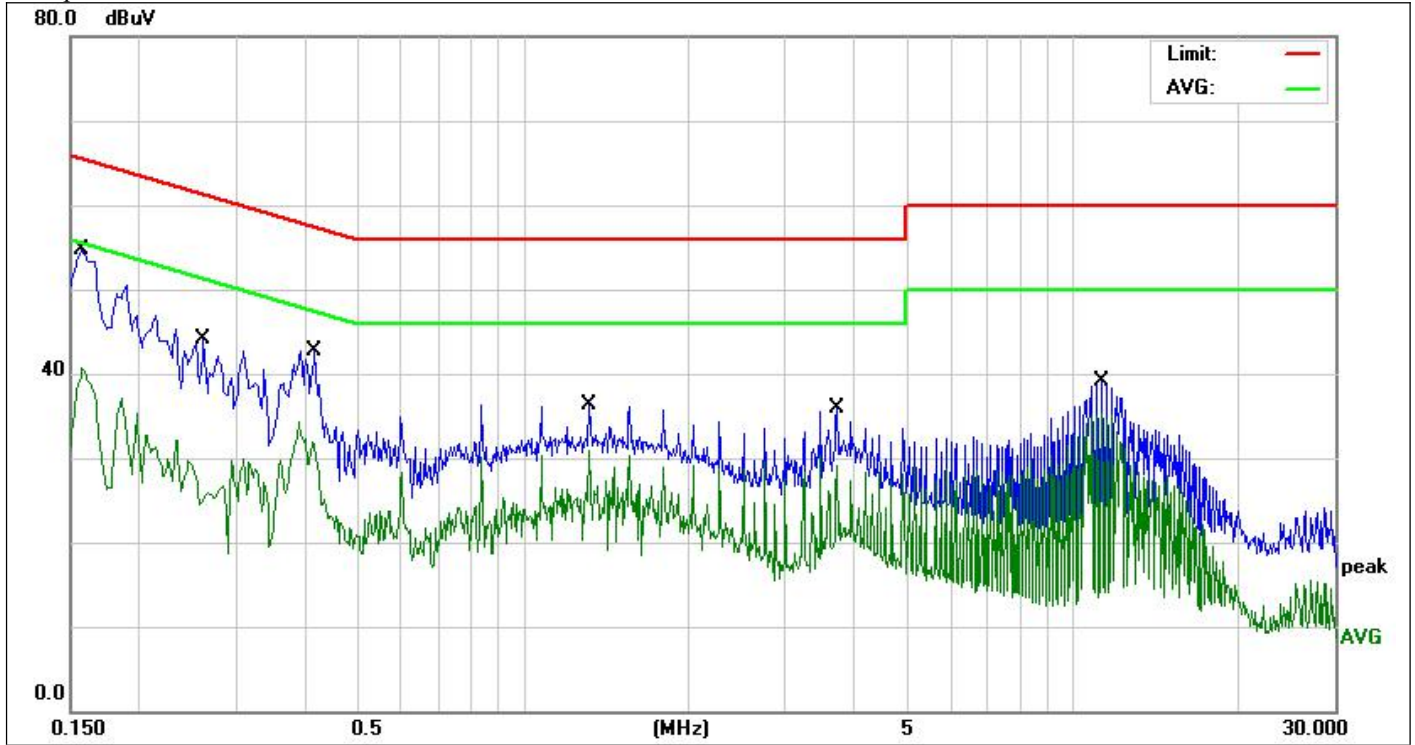

Site:	843	Phase:L1	Temperature(C):26(C)
Limit:	FCC Part 15 C Conduction(QP)		Humidity(%):60%
EUT:	Wireless Charger	Test Time:	2019/9/26
M/N.:	WCP BL 02	Power Rating:	AC 120V/60Hz
Mode:	Wireless Charging 5W	Test Engineer:	Jack
Note:			

No.	Frequency (MHz)	Reading Level(dBuV)	Factor (dB)	Measurement(dBuV)	Limit (dBuV)	Over (dB)	Detector	Comment
1 *	0.1580	42.75	9.74	52.49	65.56	-13.07	QP	
2	0.1580	29.63	9.74	39.37	55.56	-16.19	AVG	
3	0.2620	28.38	9.83	38.21	61.36	-23.15	QP	
4	0.2620	15.41	9.83	25.24	51.36	-26.12	AVG	
5	0.4180	27.37	9.91	37.28	57.49	-20.21	QP	
6	0.4180	19.63	9.91	29.54	47.49	-17.95	AVG	
7	1.3220	24.67	9.96	34.63	56.00	-21.37	QP	
8	1.3220	20.29	9.96	30.25	46.00	-15.75	AVG	
9	3.7220	21.51	9.93	31.44	56.00	-24.56	QP	
10	3.7220	17.63	9.93	27.56	46.00	-18.44	AVG	
11	11.2900	27.43	9.88	37.31	60.00	-22.69	QP	
12	11.2900	24.15	9.88	34.03	50.00	-15.97	AVG	

*:Maximum data x:Over limit !:over margin



Report No.: EA1909290F 01001

15 of 39

Test mode: **Wireless Charging 10W use Samsung S9**

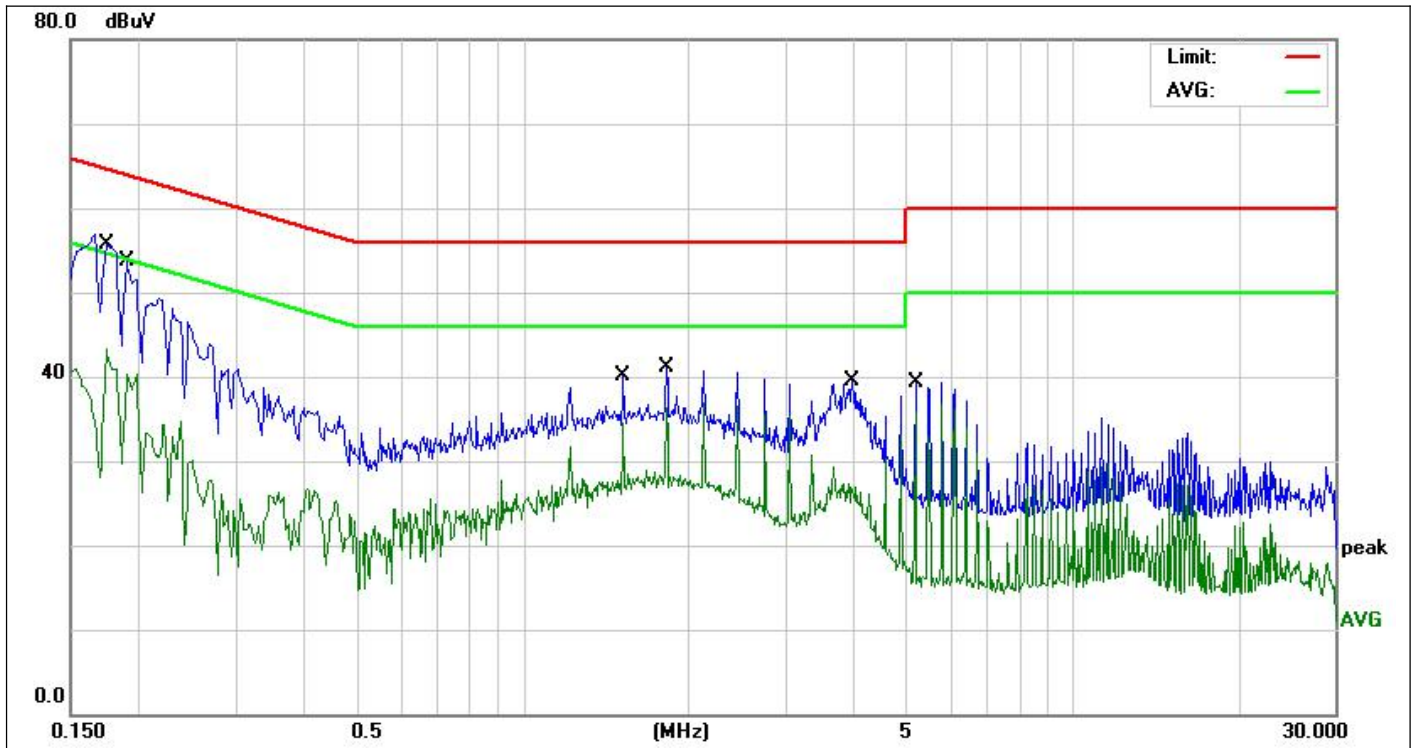

Site:	843	Phase:	N	Temperature(C):	26(C)
Limit:	FCC Part 15 C Conduction(QP)	Test Time:	2019/9/26	Humidity(%):	60%
EUT:	Wireless Charger	Power Rating:	AC 240V/50Hz	Test Engineer:	Jack
M/N.:	WCP BL 02				
Mode:	Wireless Charging 10W				
Note:					

No.	Frequency (MHz)	Reading Level(dBuV)	Factor (dB)	Measurement(dBuV)	Limit (dBuV)	Over (dB)	Detector	Comment
1	0.1740	41.88	9.75	51.63	64.76	-13.13	QP	
2	0.1740	26.25	9.75	36.00	54.76	-18.76	AVG	
3	0.1900	39.70	9.78	49.48	64.03	-14.55	QP	
4	0.1900	25.94	9.78	35.72	54.03	-18.31	AVG	
5	1.5220	28.40	9.91	38.31	56.00	-17.69	QP	
6	1.5220	25.15	9.91	35.06	46.00	-10.94	AVG	
7	1.8260	29.32	9.84	39.16	56.00	-16.84	QP	
8 *	1.8260	26.54	9.84	36.38	46.00	-9.62	AVG	
9	3.9740	23.28	9.94	33.22	56.00	-22.78	QP	
10	3.9740	15.21	9.94	25.15	46.00	-20.85	AVG	
11	5.1740	21.04	9.99	31.03	60.00	-28.97	QP	
12	5.1740	12.54	9.99	22.53	50.00	-27.47	AVG	

*:Maximum data x:Over limit !:over margin

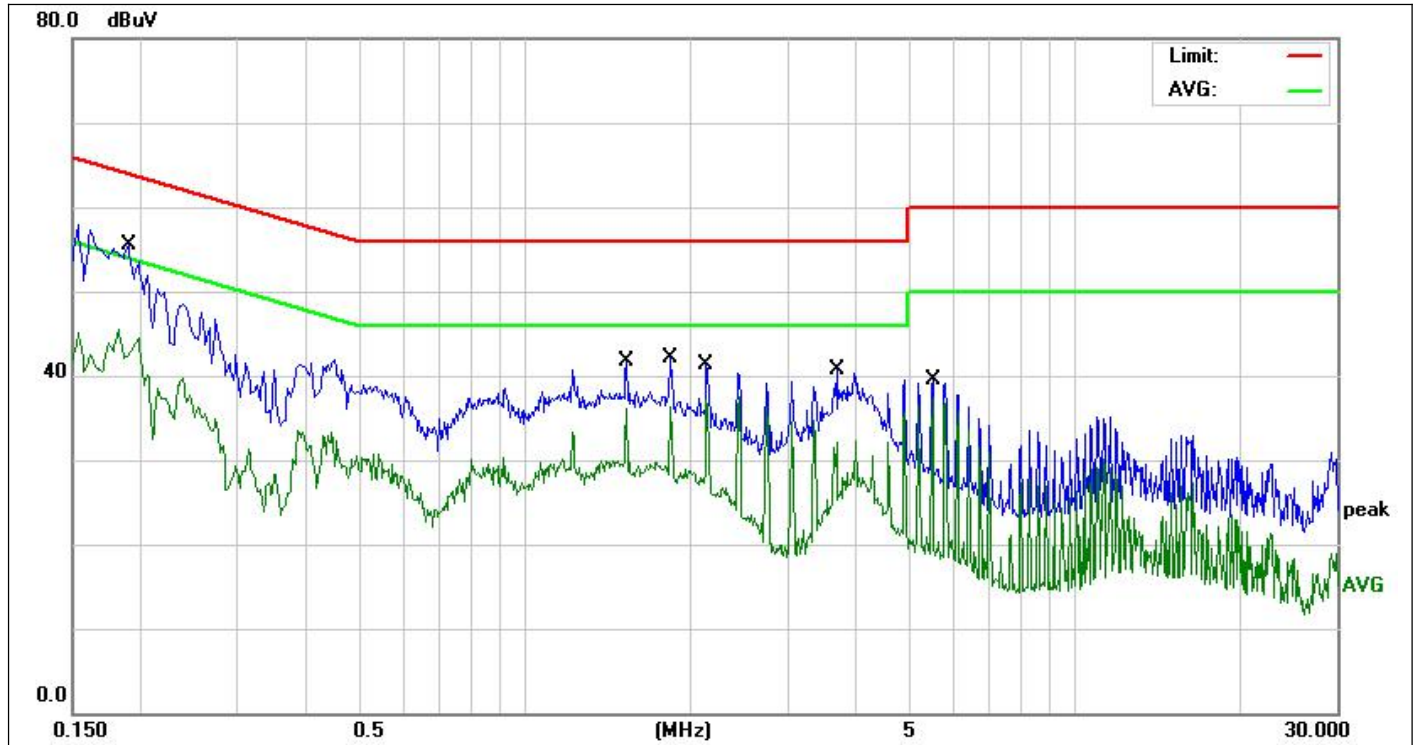

Site:	843	Phase: L1	Temperature(C): 26(C)
Limit:	FCC Part 15 C Conduction(QP)		Humidity(%): 60%
EUT:	Wireless Charger	Test Time:	2019/9/26
M/N.:	WCP BL 02	Power Rating:	AC 240V/50Hz
Mode:	Wireless Charging 10W	Test Engineer:	Jack
Note:			

No.	Frequency (MHz)	Reading Level(dBuV)	Factor (dB)	Measurement(dBuV)	Limit (dBuV)	Over (dB)	Detector	Comment
1	0.1900	40.36	9.78	50.14	64.03	-13.89	QP	
2	0.1900	29.97	9.78	39.75	54.03	-14.28	AVG	
3	1.5300	26.14	9.90	36.04	56.00	-19.96	QP	
4	1.5300	21.70	9.90	31.60	46.00	-14.40	AVG	
5	1.8340	27.43	9.84	37.27	56.00	-18.73	QP	
6 *	1.8340	23.76	9.84	33.60	46.00	-12.40	AVG	
7	2.1420	24.17	9.81	33.98	56.00	-22.02	QP	
8	2.1420	19.74	9.81	29.55	46.00	-16.45	AVG	
9	3.6820	21.55	9.93	31.48	56.00	-24.52	QP	
10	3.6820	14.16	9.93	24.09	46.00	-21.91	AVG	
11	5.5140	13.80	9.99	23.79	60.00	-36.21	QP	
12	5.5140	7.96	9.99	17.95	50.00	-32.05	AVG	

*:Maximum data x:Over limit !:over margin

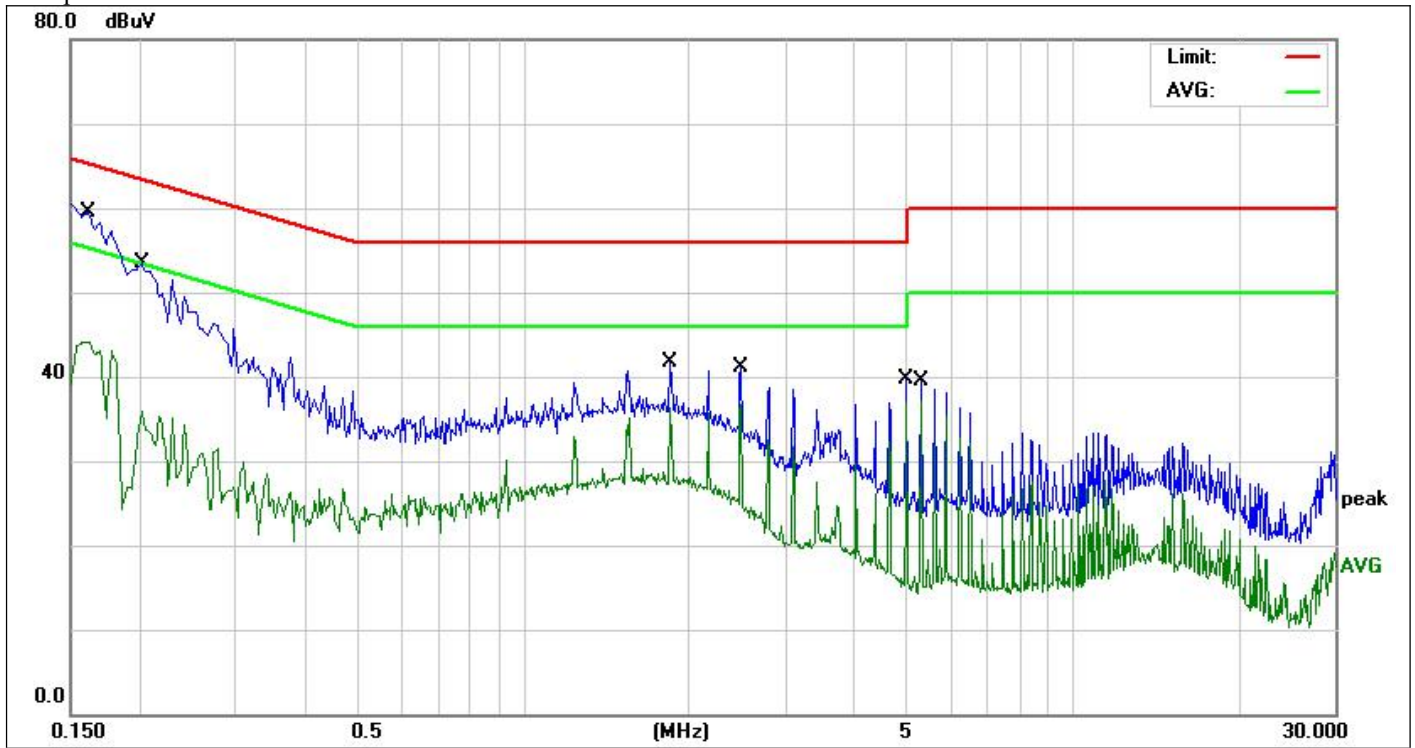

Site:	843	Phase:	N	Temperature(C):	26(C)
Limit:	FCC Part 15 C Conduction(QP)	Test Time:	2019/9/26	Humidity(%):	60%
EUT:	Wireless Charger	Power Rating:	AC 120V/60Hz	Test Engineer:	Jack
M/N.:	WCP BL 02				
Mode:	Wireless Charging 10W				
Note:					

No.	Frequency (MHz)	Reading Level(dBuV)	Factor (dB)	Measurement(dBuV)	Limit (dBuV)	Over (dB)	Detector	Comment
1 *	0.1620	45.44	9.74	55.18	65.36	-10.18	QP	
2	0.1620	28.41	9.74	38.15	55.36	-17.21	AVG	
3	0.2020	38.73	9.79	48.52	63.52	-15.00	QP	
4	0.2020	22.75	9.79	32.54	53.52	-20.98	AVG	
5	1.8580	23.57	9.83	33.40	56.00	-22.60	QP	
6	1.8580	18.79	9.83	28.62	46.00	-17.38	AVG	
7	2.4900	25.04	9.84	34.88	56.00	-21.12	QP	
8	2.4900	21.60	9.84	31.44	46.00	-14.56	AVG	
9	4.9860	18.97	9.99	28.96	56.00	-27.04	QP	
10	4.9860	10.25	9.99	20.24	46.00	-25.76	AVG	
11	5.2980	11.47	9.99	21.46	60.00	-38.54	QP	
12	5.2980	5.88	9.99	15.87	50.00	-34.13	AVG	

*:Maximum data x:Over limit !:over margin

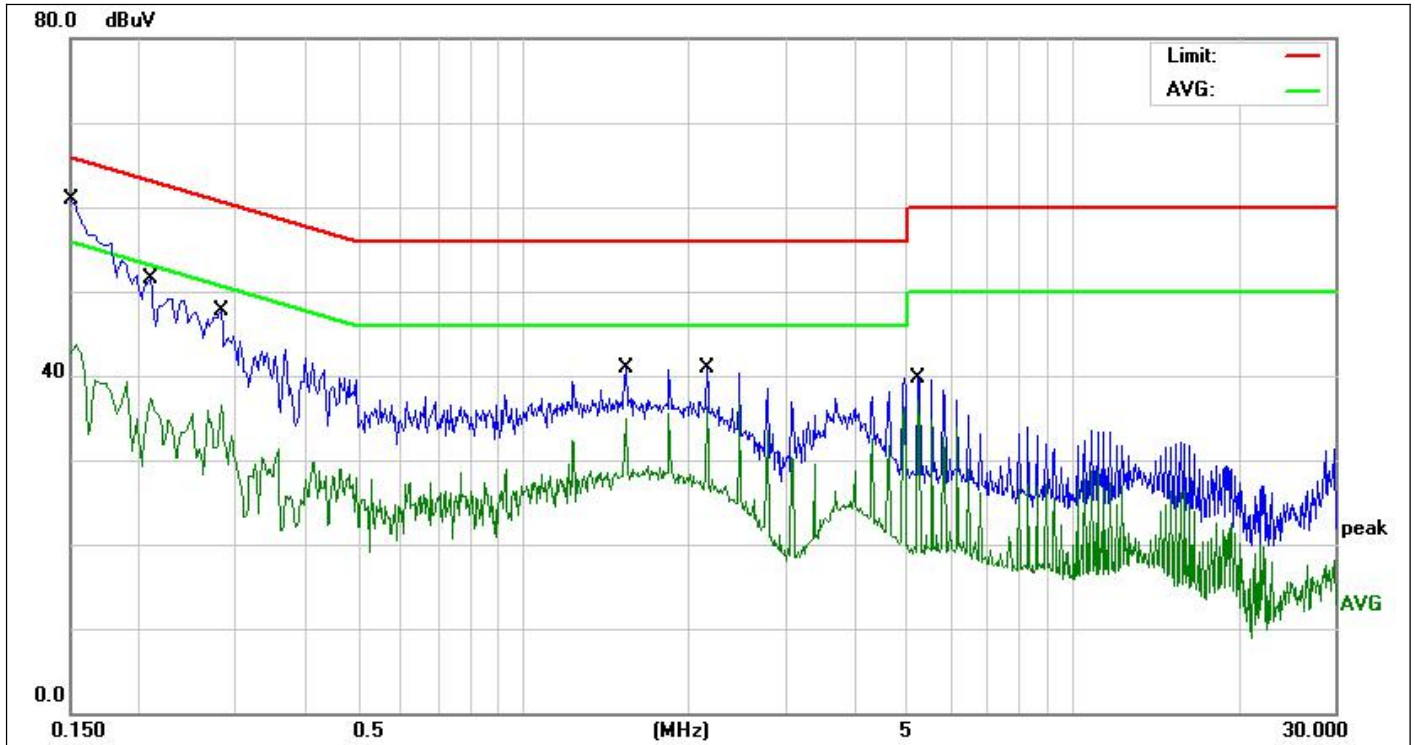

Site:	843	Phase:	L1	Temperature(C):	26(C)
Limit:	FCC Part 15 C Conduction(QP)	Humidity(%):	60%	Test Time:	2019/9/26
EUT:	Wireless Charger	Power Rating:	AC 120V/60Hz	Test Engineer:	Jack
M/N.:	WCP BL 02				
Mode:	Wireless Charging 10W				
Note:					

No.	Frequency (MHz)	Reading Level(dBuV)	Factor (dB)	Measurement(dBuV)	Limit (dBuV)	Over (dB)	Detector	Comment
1 *	0.1500	45.29	9.72	55.01	65.99	-10.98	QP	
2	0.1500	30.55	9.72	40.27	55.99	-15.72	AVG	
3	0.2100	37.36	9.79	47.15	63.20	-16.05	QP	
4	0.2100	23.81	9.79	33.60	53.20	-19.60	AVG	
5	0.2819	32.25	9.83	42.08	60.76	-18.68	QP	
6	0.2819	20.46	9.83	30.29	50.76	-20.47	AVG	
7	1.5380	28.31	9.90	38.21	56.00	-17.79	QP	
8	1.5380	24.41	9.90	34.31	46.00	-11.69	AVG	
9	2.1660	22.44	9.82	32.26	56.00	-23.74	QP	
10	2.1660	16.97	9.82	26.79	46.00	-19.21	AVG	
11	5.2460	15.37	9.99	25.36	60.00	-34.64	QP	
12	5.2460	9.94	9.99	19.93	50.00	-30.07	AVG	

*:Maximum data x:Over limit !:over margin

4.6 Conducted Measurement Photo



5 Radiated Emission Test

5.1 Measurement Procedure

1. The EUT was placed on a turn table which is 0.8m above ground plane.
2. Maximum procedure was performed on the six highest emissions to ensure EUT compliance.
3. And also, each emission was to be maximized by changing the polarization of receiving antenna both horizontal and vertical.
4. Repeat above procedures until all frequency measured were complete.

5.2 Test SET-UP (Block Diagram of Configuration)

(A) Radiated Emission Test Set-Up, Frequency Below 30MHz

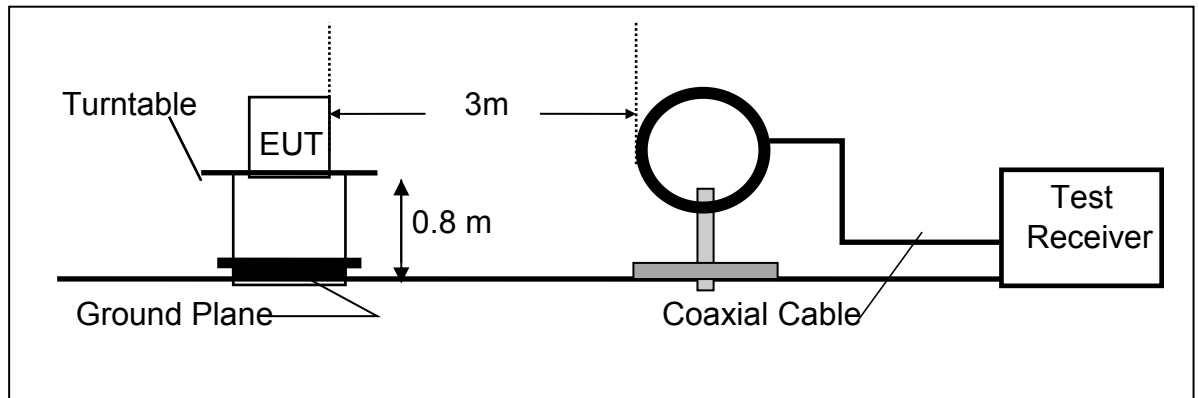

(B) Radiated Emission Test Set-Up, Frequency Below 1000MHz

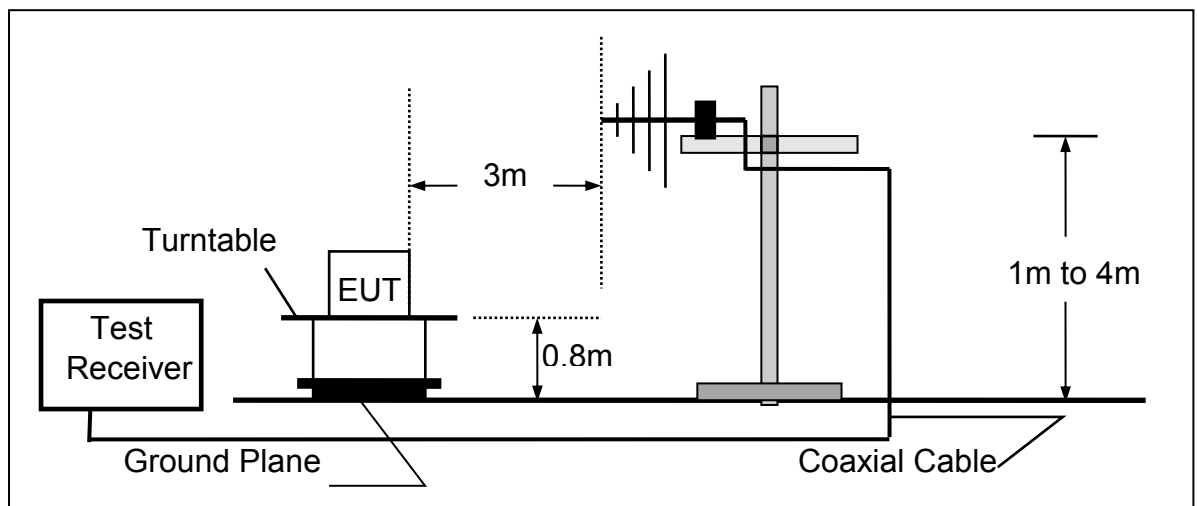



5.3 Measurement Equipment Used

Item	Equipment	Manufacturer	Model No.	Serial No.	Calibrated until
1.	EMI Test Receiver	Rohde & Schwarz	ESPI	100502	2019-11-29
2.	Pre-Amplifier	HP	8447D	2727A06172	2020-05-19
3.	Bilog Antenna	Schwarzbeck	VULB9163	VULB9163-588	2020-05-19
4.	Loop Antenna	Schwarzbeck	FMZB 1516	1516-141	2020-01-04
5.	RF Cable	Gigalink Microwave	ZT40-2.92J-2.92 J-2m	N/A	2020-03-12
6.	RF Cable	Gigalink Microwave	ZT40-2.92J-2.92 J-0.3m	N/A	2020-03-12
7.	RF Cable	N/A	N/A	6#	2020-05-19
8.	3m Semi-anechoic Chamber	chengyu	9m*6m*6m	N/A	2020-05-19
9.	Test Software	Farad	EZ-EMC Ver:ANCI-3A1	N/A	N/A

5.4 Radiated Emission Limit

The emissions from an intentional radiator shall not exceed the field strength levels specified in the following table 15.209(a):

FCC Part 15.209				
Frequency (MHz)	Field Strength Limitation		Field Strength Limitation Frequency tion at 3m Measurement Dist	
	(uV/m)	Dist	(uV/m)	(dBuV/m)
0.009 – 0.490	2400 / F(KHz)	300m	10000 * 2400/F(KHz)	20log 2400/F(KHz) + 80
0.490 – 1.705	24000 / F(KHz)	30m	100 * 24000/F(KHz)	20log 24000/F(KHz) + 40
1.705 – 30.00	30	30m	100* 30	20log 30 + 40
30.0 – 88.0	100	3m	100	20log 100
88.0 – 216.0	150	3m	150	20log 150
216.0 – 960.0	200	3m	200	20log 200
Above 960.0	500	3m	500	20log 500



15.205 Restricted bands of operation

MHz	MHz	MHz	GHz
0.090 - 0.110	16.42 - 16.423	399.9 - 410	4.5 - 5.15
¹ 0.495 - 0.505	16.69475 - 16.69525	608 - 614	5.35 - 5.46
2.1735 - 2.1905	16.80425 - 16.80475	960 - 1240	7.25 - 7.75
4.125 - 4.128	25.5 - 25.67	1300 - 1427	8.025 - 8.5
4.17725 - 4.17775	37.5 - 38.25	1435 - 1626.5	9.0 - 9.2
4.20725 - 4.20775	73 - 74.6	1645.5 - 1646.5	9.3 - 9.5
6.215 - 6.218	74.8 - 75.2	1660 - 1710	10.6 - 12.7
6.26775 - 6.26825	108 - 121.94	1718.8 - 1722.2	13.25 - 13.4
6.31175 - 6.31225	123 - 138	2200 - 2300	14.47 - 14.5
8.291 - 8.294	149.9 - 150.05	2310 - 2390	15.35 - 16.2
8.362 - 8.366	156.52475 - 156.52525	2483.5 - 2500	17.7 - 21.4
8.37625 - 8.38675	156.7 - 156.9	2690 - 2900	22.01 - 23.12
8.41425 - 8.41475	162.0125 - 167.17	3260 - 3267	23.6 - 24.0
12.29 - 12.293	167.72 - 173.2	3332 - 3339	31.2 - 31.8
12.51975 - 12.52025	240 - 285	3345.8 - 3358	36.43 - 36.5
12.57675 - 12.57725	322 - 335.4	3600 - 4400	(²)

- Remark:
1. Emission level in dBuV/m=20 log (uV/m)
 2. Measurement was performed at an antenna to the closed point of EUT distance of meters.
 3. Only spurious frequency is permitted to locate within the Restricted Bands specified in provision of ξ 15.205, and the emissions located in restricted bands also comply with 15.209 limit.



5.5 Measurement Result

We pretested modes (Wireless Charging(10W),Wireless Charging(5W)) for EUT. The worst mode (Wireless Charging(10W))test data see follow the table.

Operation Mode:	Low frequency	Test Date :	September 27, 2019
Frequency Range:	9KHz~30MHz	Temperature :	20°C
Test Result:	PASS	Humidity :	55 %
Measured Distance:	3m	Test By:	Best

Freq. (MHz)	Ant.Pol. H/V	Emission Level (dBuV/m)	Limit 3m (dBuV/m)	Over (dB)	Note
0.180(F)	H	76.25	102.50	-26.25	PK
0.3602	H	63.58	96.47	-32.89	PK
0.5421	H	63.25	72.92	-9.67	PK
0.7213	H	56.32	70.44	-14.12	PK
0.9035	H	55.14	68.49	-13.35	PK
0.180(F)	V	76.21	102.50	-26.29	PK
0.3602	V	63.44	96.47	-33.03	PK
0.5421	V	63.20	72.92	-9.72	PK
0.7213	V	56.98	70.44	-13.46	PK
0.9035	V	55.31	68.49	-13.18	PK

- Note:**
- (1) All Readings are Peak Value.
 - (2) Emission Level= Reading Level+Probe Factor +Cable Loss.
 - (3) The average measurement was not performed when the peak measured data under the limit of average detection.
 - (4) EUT lying on the table position is the worst case result in the report.

We pretested modes (Wireless Charging(10W),Wireless Charging(5W)) for EUT. The test data see follow the table.



Test mode: Wireless Charging 5W use iphone



Site:	LAB	Antenna::	Horizontal	Temperature(C):	23.4(C)
Limit:	FCC Part 15 Class B 3m Radiation(QP)	Test Time:	2019/9/27	Humidity(%):	56.7%
EUT:	Embedded wireless charger	Power Rating:	AC 120V/60Hz	Test Engineer:	sunshine
M/N.:	WCP BL 02				
Mode:	Wireless Charging 5W				
Note:					

No.	Frequency (MHz)	Reading (dBuV)	Factor (dB/m)	Level (dBuV/m)	Limit (dBuV/m)	Margin (dB)	Det.	Height (cm)	Azimuth (deg)	Remark
1	44.1202	27.13	-12.53	14.60	40.00	-25.40	QP			
2	48.5867	26.10	-12.45	13.65	40.00	-26.35	QP			
3	57.8977	27.77	-13.21	14.56	40.00	-25.44	QP			
4	110.7627	25.23	-12.71	12.52	43.50	-30.98	QP			
5	243.8043	28.72	-10.39	18.33	46.00	-27.67	QP			
6 *	266.1419	34.51	-9.56	24.95	46.00	-21.05	QP			

*:Maximum data x:Over limit !:over margin



Site:	LAB	Antenna::Vertical	Temperature(C):23.4(C)
Limit:	FCC Part 15 Class B 3m Radiation(QP)		Humidity(%):56.7%
EUT:	Embedded wireless charger	Test Time:	2019/9/27
M/N.:	WCP BL 02	Power Rating:	AC 120V/60Hz
Mode:	Wireless Charging 5W	Test Engineer:	sunshine
Note:			

No.	Frequency (MHz)	Reading (dBuV)	Factor (dB/m)	Level (dBuV/m)	Limit (dBuV/m)	Margin (dB)	Det.	Height (cm)	Azimuth (deg)	Remark
1 *	43.3534	48.84	-12.54	36.30	40.00	-3.70	QP			
2	49.8814	38.30	-12.43	25.87	40.00	-14.13	QP			
3	56.8914	39.61	-13.18	26.43	40.00	-13.57	QP			
4	88.9639	34.42	-14.49	19.93	43.50	-23.57	QP			
5	227.2918	31.17	-11.25	19.92	46.00	-26.08	QP			
6	273.2341	32.69	-9.34	23.35	46.00	-22.65	QP			

*:Maximum data x:Over limit !:over margin



Site:	LAB	Antenna::Vertical	Temperature(C):23.4(C)
Limit:	FCC Part 15 Class B 3m Radiation(QP)	Test Time:	Humidity(%):56.7%
EUT:	Embedded wireless charger	Power Rating:	2019/9/27
M/N.:	WCP BL 02	Test Engineer:	AC 240V/50Hz
Mode:	Wireless Charging 5W		sunshine
Note:			

No.	Frequency (MHz)	Reading (dBuV)	Factor (dB/m)	Level (dBuV/m)	Limit (dBuV/m)	Margin (dB)	Det.	Height (cm)	Azimuth (deg)	Remark
1 *	42.6000	47.19	-12.56	34.63	40.00	-5.37	QP			
2	49.0145	41.71	-12.45	29.26	40.00	-10.74	QP			
3	56.3948	42.71	-13.18	29.53	40.00	-10.47	QP			
4	88.9639	36.35	-14.49	21.86	43.50	-21.64	QP			
5	114.7156	31.04	-12.96	18.08	43.50	-25.42	QP			
6	270.8493	31.78	-9.41	22.37	46.00	-23.63	QP			

*:Maximum data x:Over limit !:over margin



Site:	LAB	Antenna::	Horizontal	Temperature(C):	23.4(C)
Limit:	FCC Part 15 Class B 3m Radiation(QP)	Test Time:	2019/9/27	Humidity(%):	56.7%
EUT:	Embedded wireless charger	Power Rating:	AC 240V/50Hz	Test Engineer:	sunshine
M/N.:	WCP BL 02				
Mode:	Wireless Charging 5W				
Note:					

No.	Frequency (MHz)	Reading (dBuV)	Factor (dB/m)	Level (dBuV/m)	Limit (dBuV/m)	Margin (dB)	Det.	Height (cm)	Azimuth (deg)	Remark
1	45.6948	27.57	-12.50	15.07	40.00	-24.93	QP			
2	55.9026	27.17	-13.17	14.00	40.00	-26.00	QP			
3	157.2829	27.09	-14.81	12.28	43.50	-31.22	QP			
4	208.2148	27.48	-12.26	15.22	43.50	-28.28	QP			
5 *	256.9712	31.69	-9.84	21.85	46.00	-24.15	QP			
6	306.2164	27.60	-8.34	19.26	46.00	-26.74	QP			

*:Maximum data x:Over limit !:over margin



Report No.: EA1909290F 01001

28 of 39

Test mode: **Wireless Charging 10W use Samsung S9**

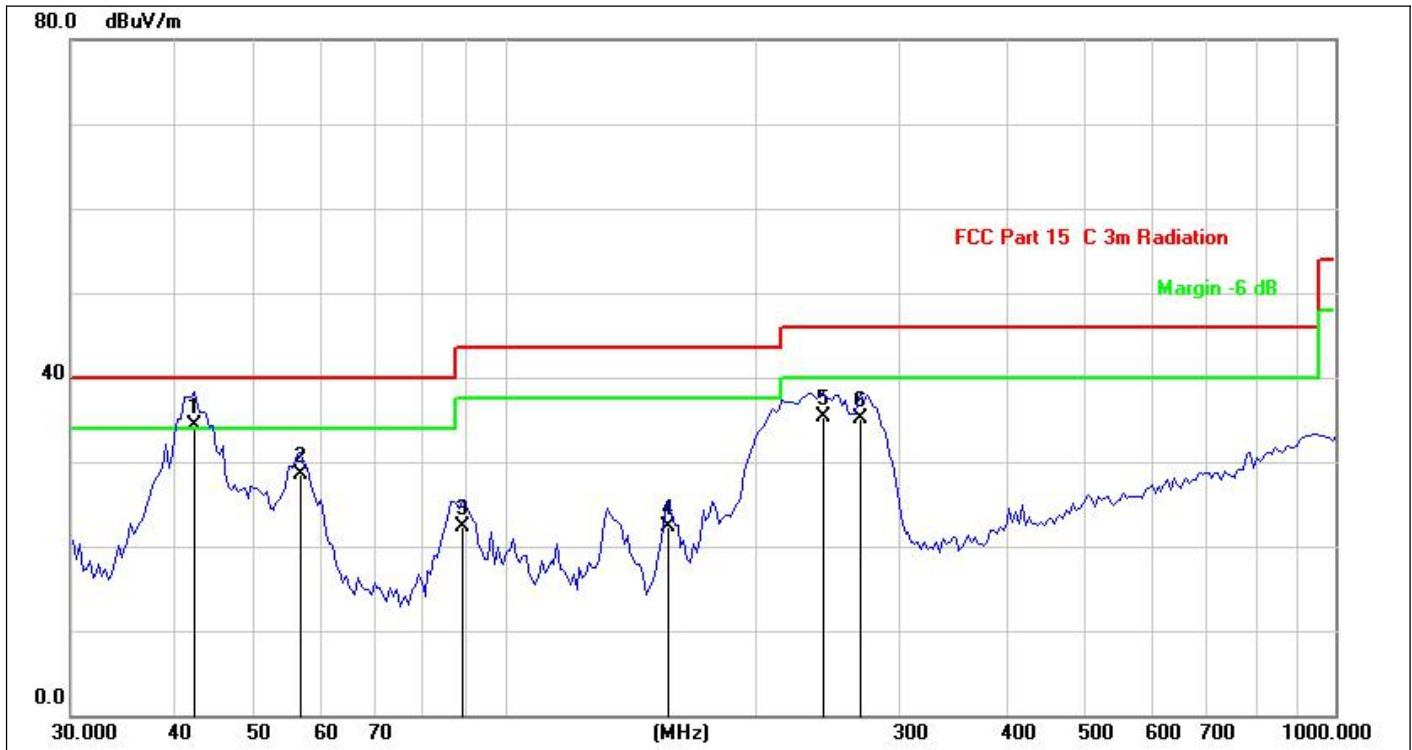

Site:	LAB	Antenna::	Vertical	Temperature(C):	23.4(C)
Limit:	FCC Part 15 Class B 3m Radiation(QP)	Test Time:	2019/9/27	Humidity(%):	56.7%
EUT:	Embedded wireless charger	Power Rating:	AC 120V/60Hz	Test Engineer:	sunshine
M/N.:	WCP BL 02				
Mode:	Wireless Charging 10W				
Note:					

No.	Frequency (MHz)	Reading (dBuV)	Factor (dB/m)	Level (dBuV/m)	Limit (dBuV/m)	Margin (dB)	Det.	Height (cm)	Azimuth (deg)	Remark
1 *	42.2280	46.93	-12.56	34.37	40.00	-5.63	QP			
2	56.8914	41.74	-13.18	28.56	40.00	-11.44	QP			
3	88.9639	36.81	-14.49	22.32	43.50	-21.18	QP			
4	157.2829	37.15	-14.81	22.34	43.50	-21.16	QP			
5	241.6763	45.70	-10.49	35.21	46.00	-10.79	QP			
6	268.4853	44.54	-9.48	35.06	46.00	-10.94	QP			

*:Maximum data x:Over limit !:over margin

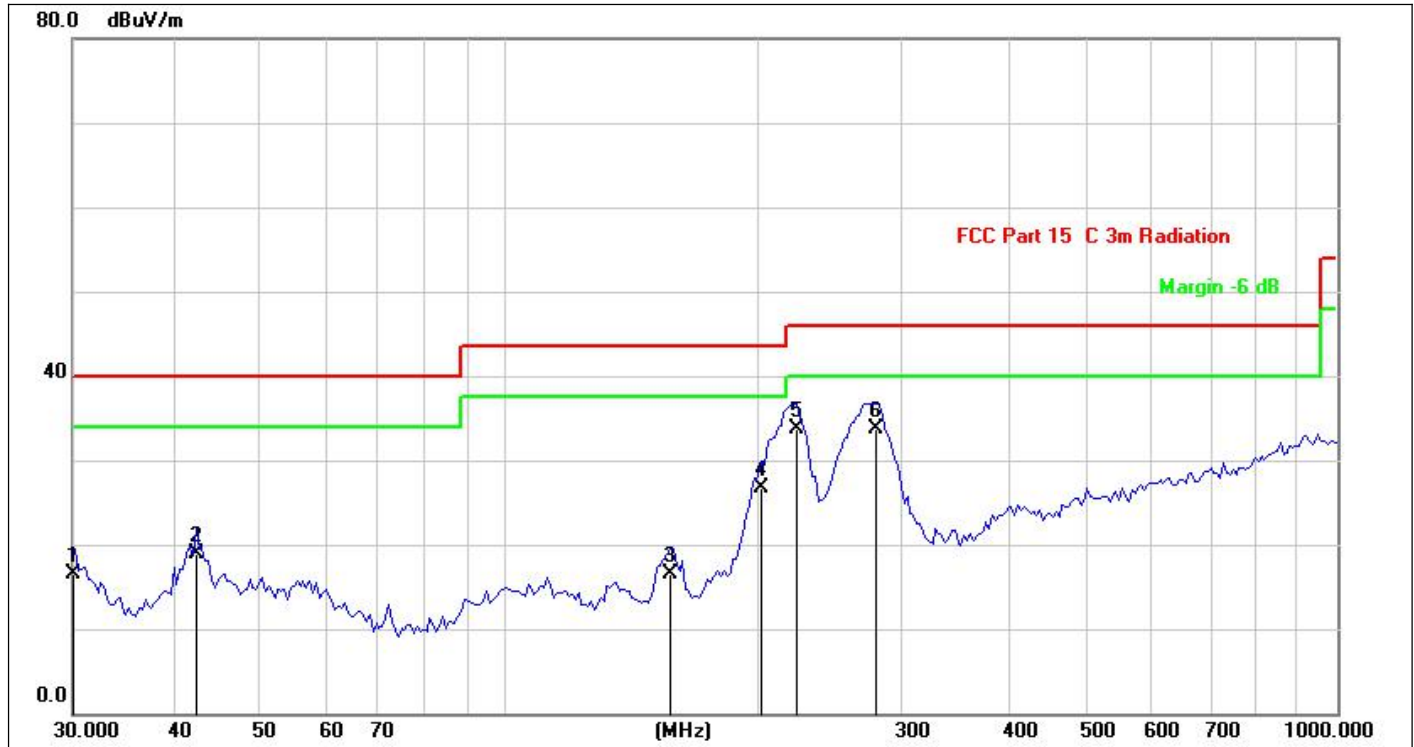

Site:	LAB	Antenna::	Horizontal	Temperature(C):	23.4(C)
Limit:	FCC Part 15 Class B 3m Radiation(QP)			Humidity(%):	56.7%
EUT:	Embedded wireless charger	Test Time:	2019/9/27		
M/N.:	WCP BL 02	Power Rating:	AC 120V/60Hz		
Mode:	Wireless Charging 10W	Test Engineer:	sunshine		
Note:					

No.	Frequency (MHz)	Reading (dBuV)	Factor (dB/m)	Level (dBuV/m)	Limit (dBuV/m)	Margin (dB)	Det.	Height (cm)	Azimuth (deg)	Remark
1	30.2641	23.80	-7.25	16.55	40.00	-23.45	QP			
2	42.2281	31.44	-12.56	18.88	40.00	-21.12	QP			
3	157.2829	31.39	-14.81	16.58	43.50	-26.92	QP			
4	202.8104	39.17	-12.55	26.62	43.50	-16.88	QP			
5 *	223.3415	45.23	-11.47	33.76	46.00	-12.24	QP			
6	278.0668	42.91	-9.19	33.72	46.00	-12.28	QP			

*:Maximum data x:Over limit !:over margin

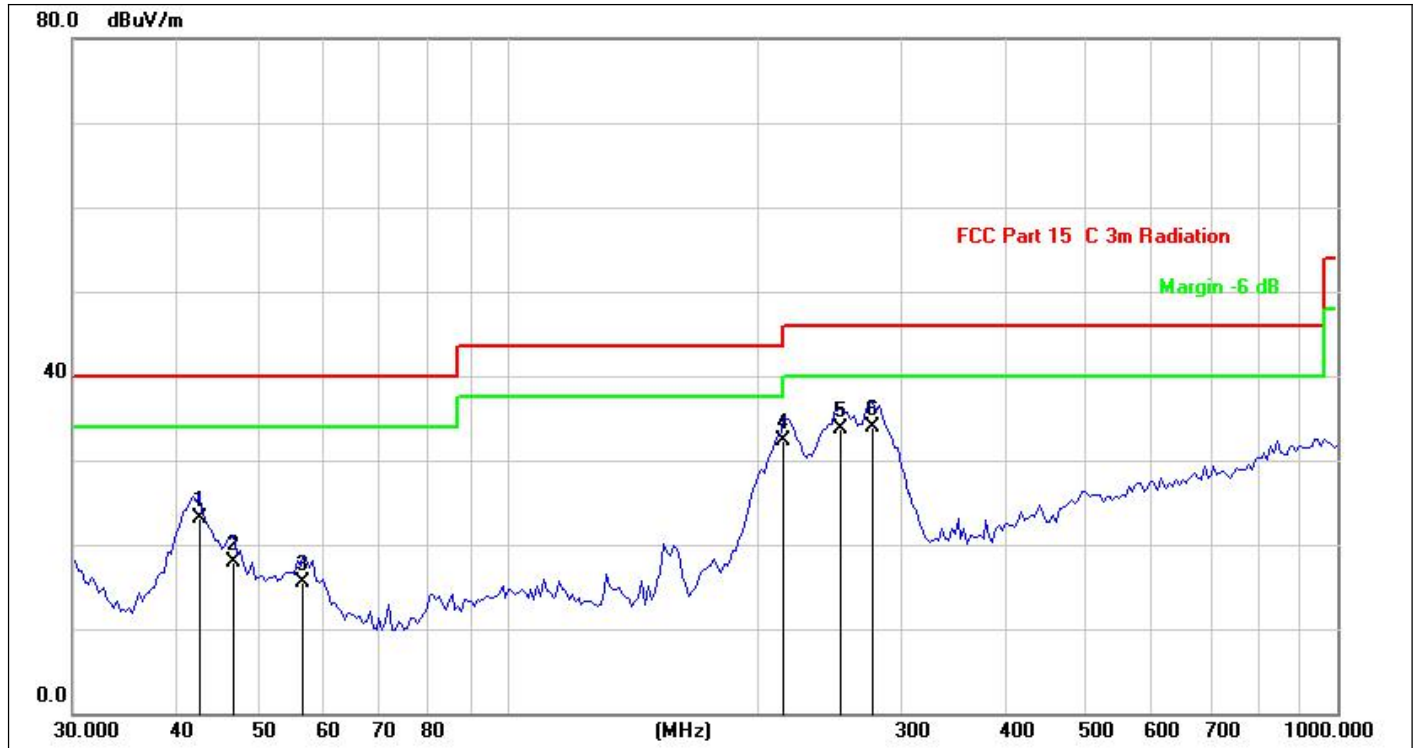

Site:	LAB	Antenna::Horizontal	Temperature(C):23.4(C)
Limit:	FCC Part 15 Class B 3m Radiation(QP)		Humidity(%):56.7%
EUT:	Embedded wireless charger	Test Time:	2019/9/27
M/N.:	WCP BL 02	Power Rating:	AC 240V/50Hz
Mode:	Wireless Charging 10W	Test Engineer:	sunshine
Note:			

No.	Frequency (MHz)	Reading (dBuV)	Factor (dB/m)	Level (dBuV/m)	Limit (dBuV/m)	Margin (dB)	Det.	Height (cm)	Azimuth (deg)	Remark
1	42.6000	35.59	-12.56	23.03	40.00	-16.97	QP			
2	46.9125	30.48	-12.48	18.00	40.00	-22.00	QP			
3	56.8914	28.78	-13.18	15.60	40.00	-24.40	QP			
4 *	215.6456	44.12	-11.87	32.25	43.50	-11.25	QP			
5	252.5051	43.63	-9.98	33.65	46.00	-12.35	QP			
6	275.6399	43.23	-9.27	33.96	46.00	-12.04	QP			

*:Maximum data x:Over limit !:over margin

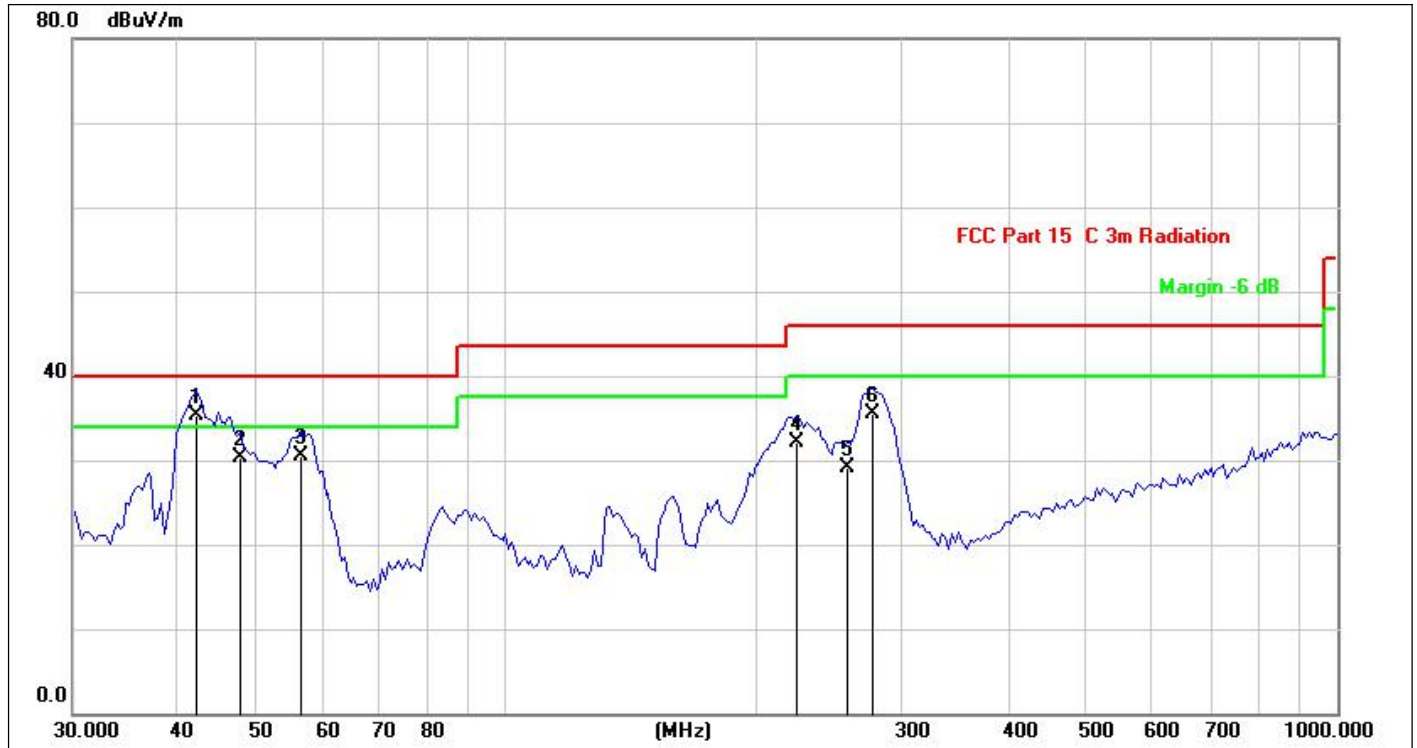

Site:	LAB	Antenna::Vertical	Temperature(C):23.4(C)
Limit:	FCC Part 15 Class B 3m Radiation(QP)	Test Time:	Humidity(%):56.7%
EUT:	Embedded wireless charger	Power Rating:	2019/9/27
M/N.:	WCP BL 02	Test Engineer:	AC 240V/50Hz
Mode:	Wireless Charging 10W		sunshine
Note:			

No.	Frequency (MHz)	Reading (dBuV)	Factor (dB/m)	Level (dBuV/m)	Limit (dBuV/m)	Margin (dB)	Det.	Height (cm)	Azimuth (deg)	Remark
1 *	42.2280	47.95	-12.56	35.39	40.00	-4.61	QP			
2	47.7422	42.80	-12.47	30.33	40.00	-9.67	QP			
3	56.3947	43.62	-13.18	30.44	40.00	-9.56	QP			
4	223.3415	43.63	-11.47	32.16	46.00	-13.84	QP			
5	256.9712	38.91	-9.84	29.07	46.00	-16.93	QP			
6	275.6399	44.86	-9.27	35.59	46.00	-10.41	QP			

*:Maximum data x:Over limit !:over margin

5.6 Radiated Measurement Photos

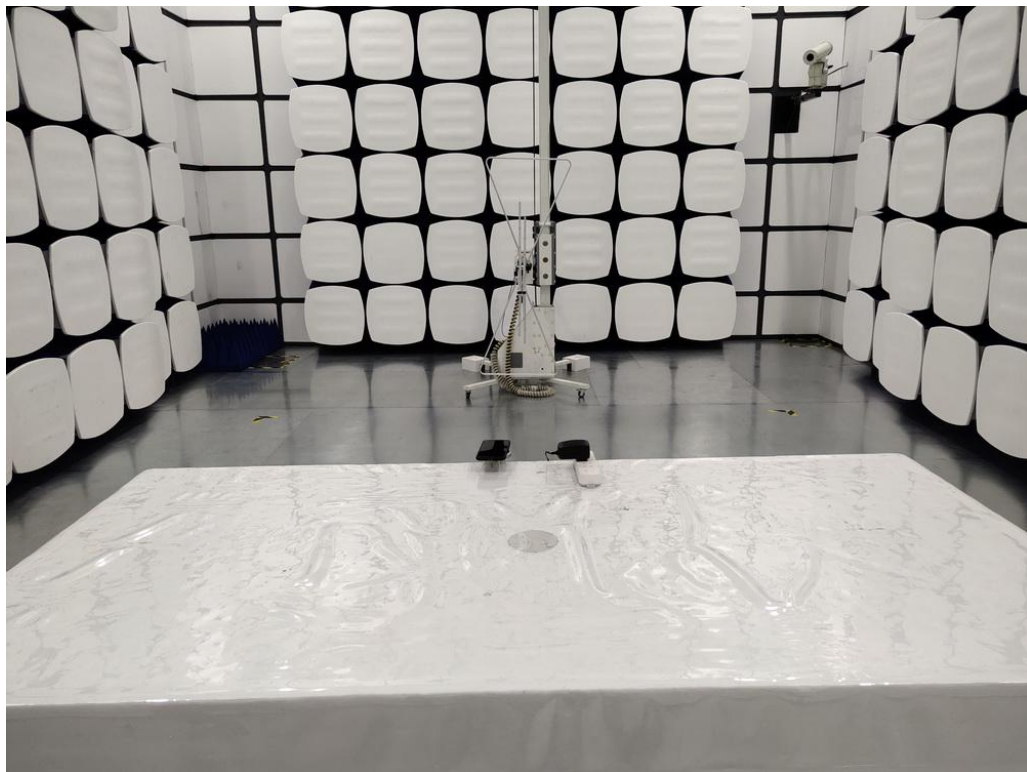
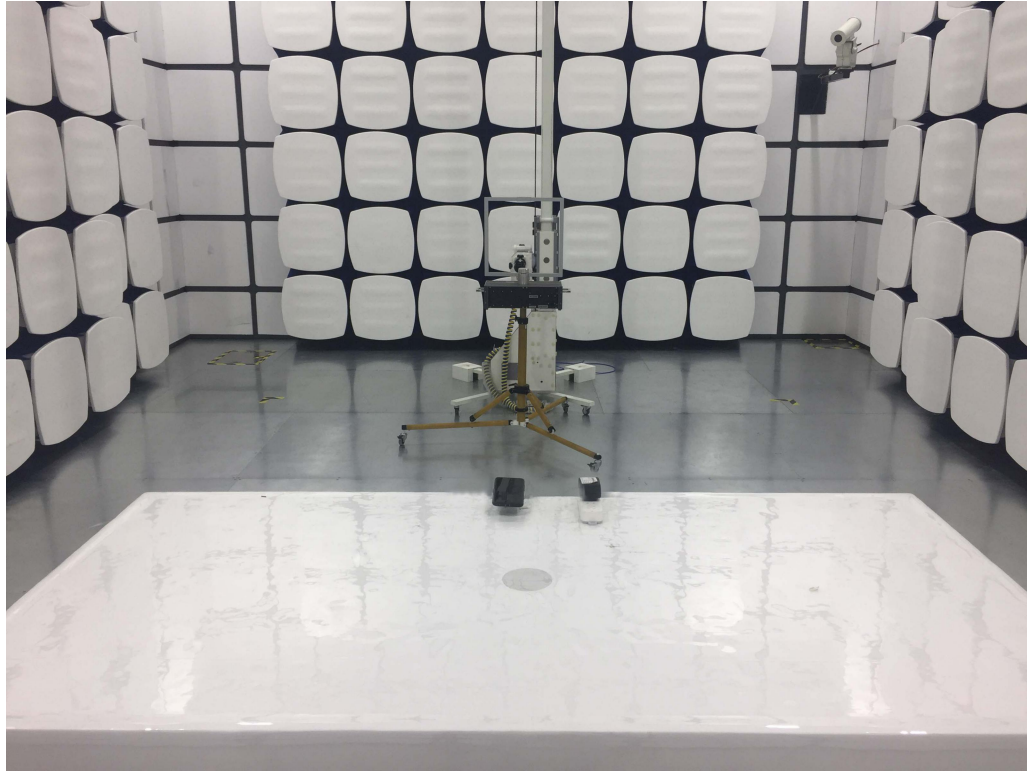

6 20db Bandwidth

6.1 20dB Bandwidth Limit

None: for reporting purposed only.

6.2 Test Instruments

Refer a test equipment and calibration data table in this test report.

6.3 Test Procedure

The bandwidth of the fundamental frequency was measured by spectrum analyzer with 300Hz RBW and 1KHz VBW. The 20dB bandwidth is defined as the total spectrum the power of which is higher than peak power minus 20dB.

6.4 Test Setup

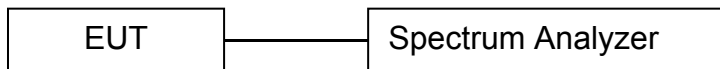

6.5 Test Result

Frequency (KHz)	20dB Bandwidth (Hz)	Results
179.978	336.5	PASS

20 dB Bandwidth Test plot

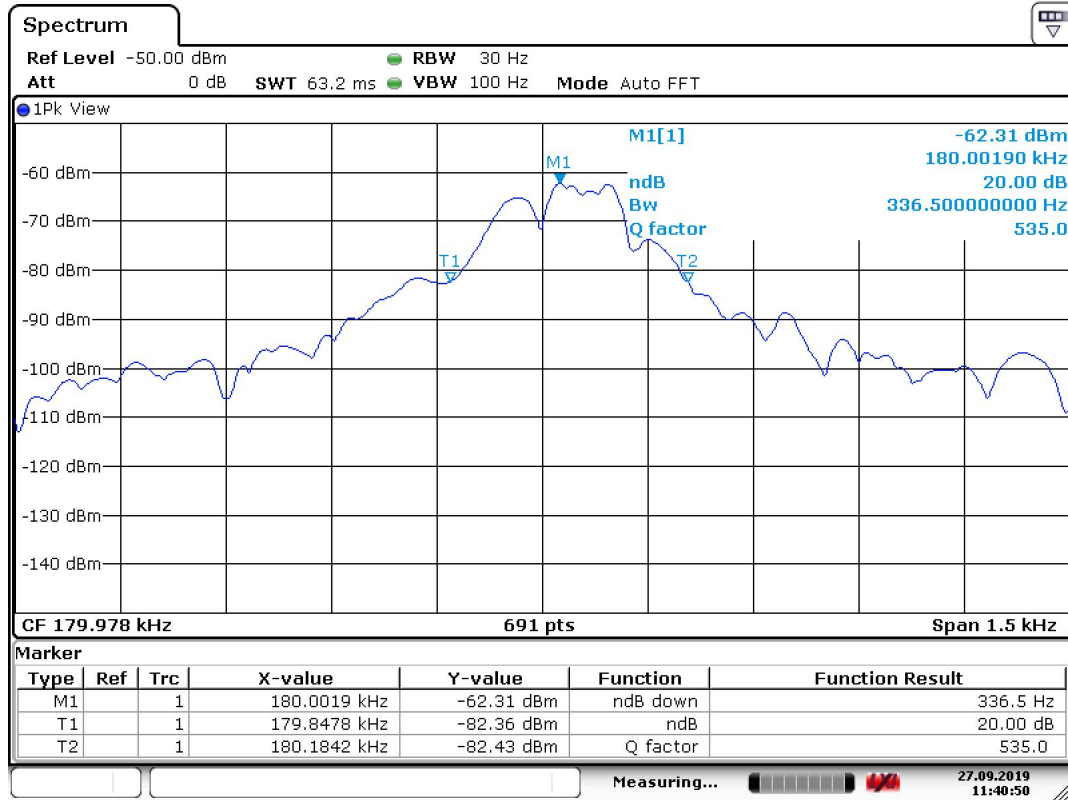

Date: 27.SEP.2019 11:40:50

7 Antenna Application

7.1 Antenna requirement

For intentional device, according to FCC 47 CFR Section 15.203, an intentional radiator shall be designed to ensure that no antenna other than that furnished by the responsible party shall be used with the device.

7.2 Result

The EUT's antenna, permanent attached antenna, used an Induction coil and integrated on PCB, The antenna's gain meets the requirement.



APPENDIX (Photos of EUT)



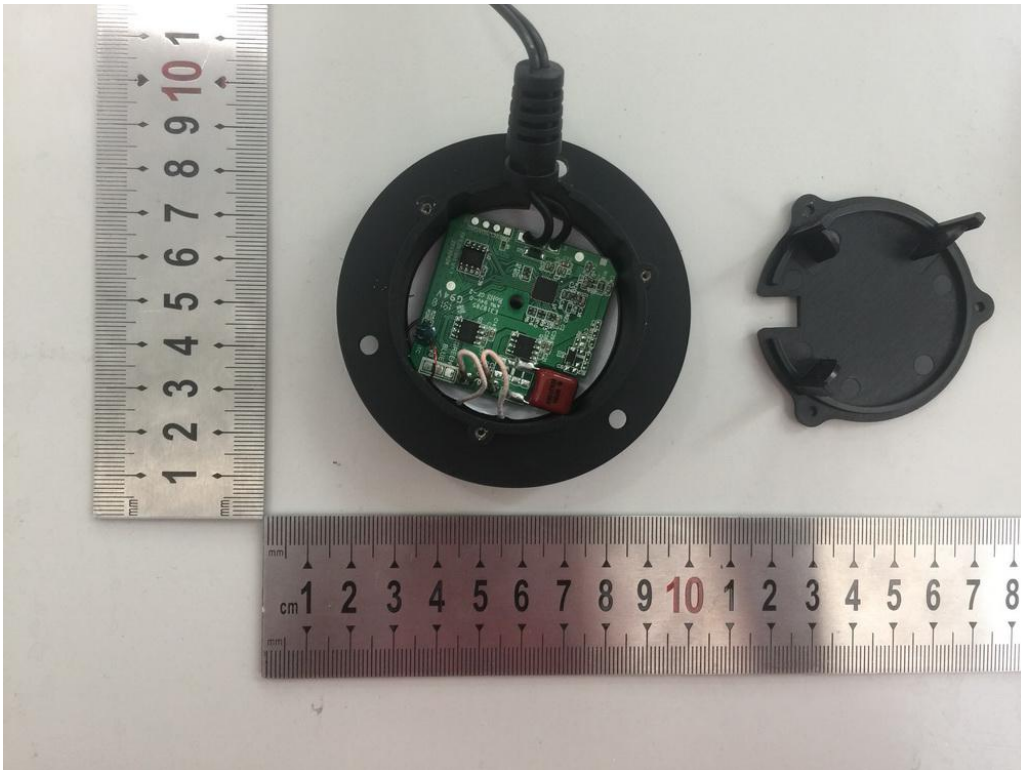

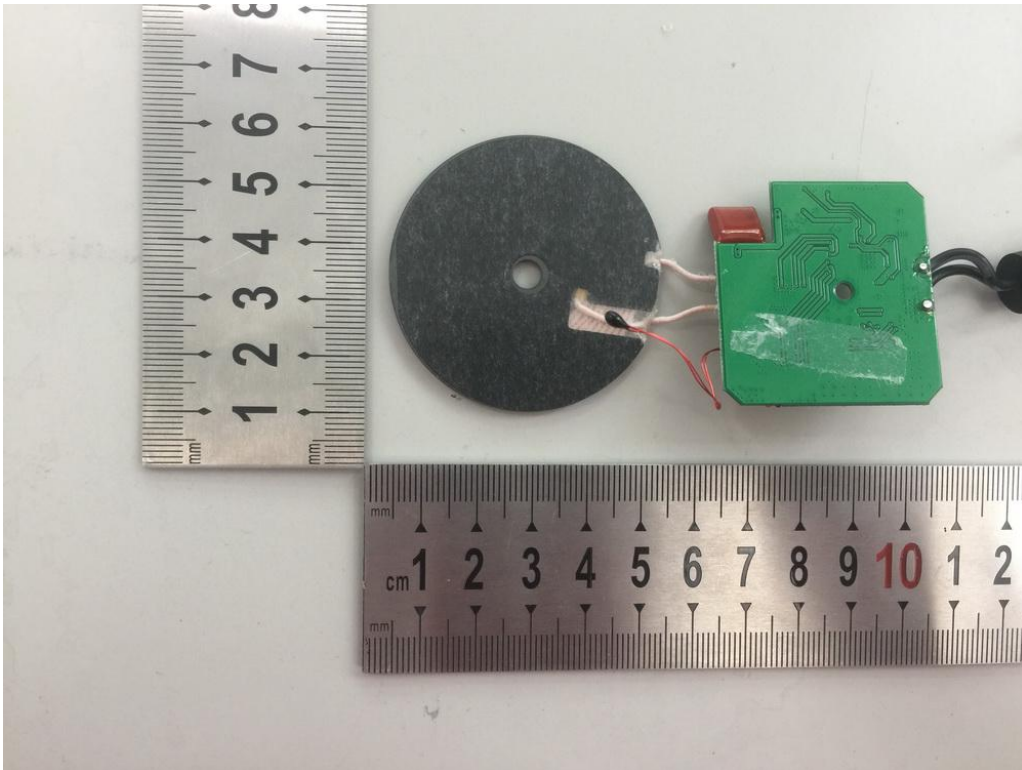
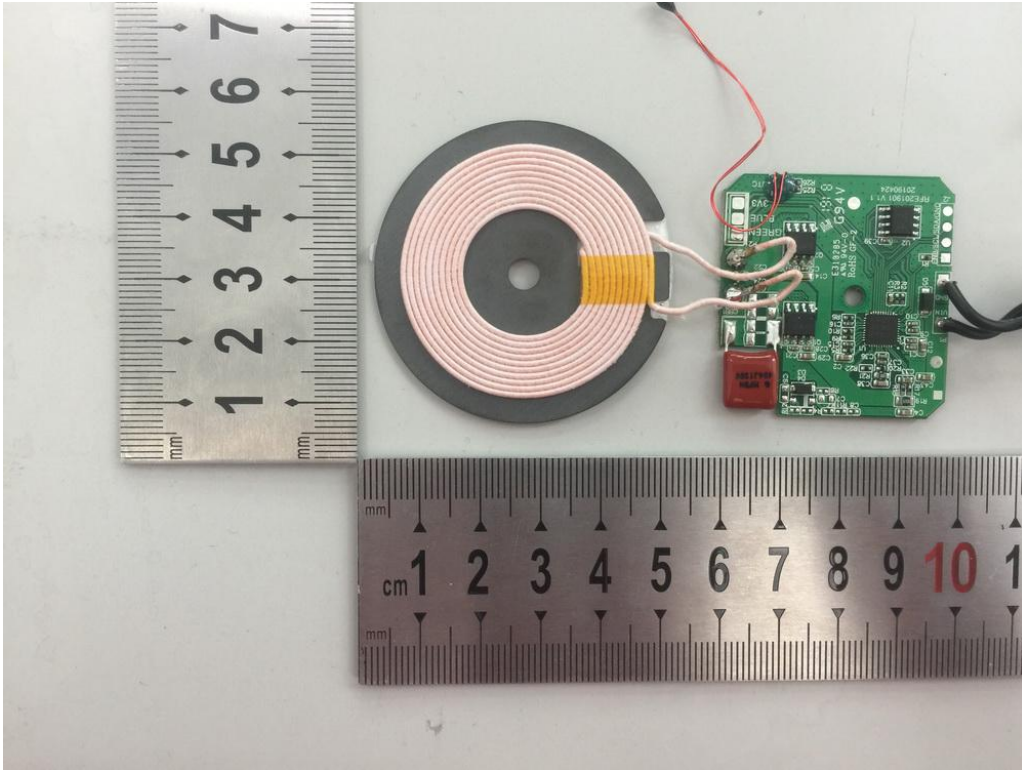

-----The end of report-----