

INVEALL

User Manual

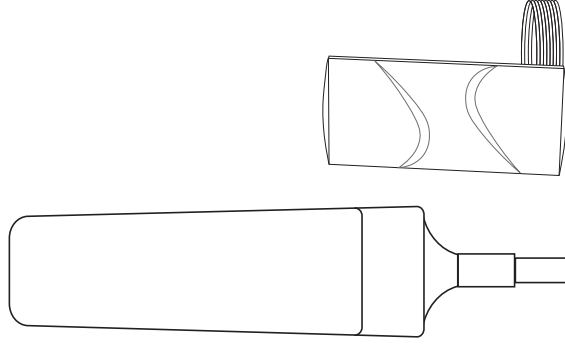

Internal No. V50IN-C-NA

Safety Guidelines

FCC Statement

Changes or modifications not expressly approved by the party responsible for compliance could void the user's authority to operate the equipment.

This equipment has been tested and found to comply with the limits for a Class B digital device, pursuant to Part 15 of the FCC Rules. These limits are designed to provide reasonable protection against harmful interference in a residential installation. This equipment generates uses and can radiate radio frequency energy and, if not installed and used in accordance with the instructions, may cause harmful interference to radio communications. However, there is no guarantee that interference will not occur in a particular installation. If this equipment does cause harmful interference to radio or television reception, which can be determined by turning the equipment off and on, the user is encouraged to try to correct the interference by one or more of the following measures:

- Reorient or relocate the receiving antenna.
- Increase the separation between the equipment and receiver.
- Connect the equipment into an outlet on a circuit different from that to which the receiver is connected.
- Consult the dealer or an experienced radio/TV technician for help

This device complies with part 15 of the FCC rules.

Operation is subject to the following two conditions:

- (1) this device may not cause harmful interference, and
- (2) this device must accept any interference received, including interference that may cause undesired operation.

This equipment complies with FCC radiation exposure limits set forth for an uncontrolled environment. This equipment should be installed and operated with minimum distance 20cm between the radiator & your body.

Consumer Signal Booster Warning Label:

If the booster has this label (all consumer boosters sold after March 1, 2014, and some sold prior will have this label):

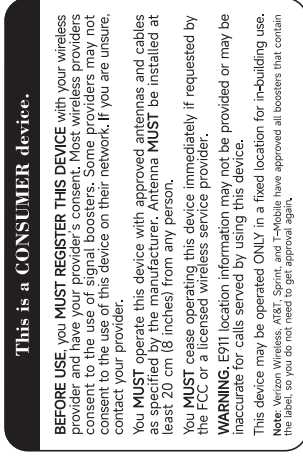

1. Verify that your provider has given permission (e.g., AT&T, Sprint, T-Mobile, Verizon) , or else get permission from your wireless provider to use it.
2. Register your booster with your wireless provider before turning it on. Each wireless provider that gives permission for boosters to be used must provide a free registration system.

Note: Verizon Wireless, AT&T, Sprint, and T-Mobile have approved all boosters that contain the label, so you do not need to get approval again.

You can learn more about the FCC's new rules by following the link:
<https://www.fcc.gov/wireless/bureau-divisions/mobility-division/signal-boosters/consumer-signal-boosters>

IC Statement

This device contains licence-exempt transmitter(s)/receiver(s) that comply with Innovation, Science and Economic Development Canada's licence-exempt RSS(s). Operation is subject to the following two conditions:

(1) This device may not cause interference; and (2) This device must accept any interference, including interference that may cause undesired operation of the device.

The term IC: before the certification/registration number only signifies that the Industry Canada technical specifications were met. This product meets the applicable Industry Canada technical specifications.

This equipment complies with ISSED radiation exposure limits set forth for an uncontrolled environment. This equipment should be installed and operated with minimum distance 20cm between the radiator & your body.



Cet appareil contient des émetteurs/récepteurs exemptés de licence conformes aux RSS (RSS) d'Innovation, Sciences et Développement économique Canada. L'exploitation est autorisée aux deux conditions suivantes:

(1) l'appareil ne doit pas produire de brouillage, et

(2) l'utilisateur de l'appareil doit accepter tout brouillage radioélectrique subi, même si le brouillage est susceptible d'en compromettre le fonctionnement.

Le terme IC : devant le numéro de certification/d'enregistrement signifie uniquement que les spécifications techniques d'Industrie Canada ont été respectées. Ce produit répond aux spécifications techniques applicables d'Industrie Canada.

Cet équipement est conforme aux limites d'exposition aux rayonnements ISSED établies pour un environnement non contrôlé. Cet équipement doit être installé et utilisé avec une distance minimale de 20 cm entre le radiateur et votre corps.

Name	Model	Gain/Loss	photo
Indoor Antenna	Patch Antenna AN601	3dbi @698-787MHz 3dbi @824-894MHz 3.5dbi @1710-1755MHz 3.5dbi @1850-1995MHz 3.5dbi @2110-2155MHz	
Indoor Antenna	Indoor Panel Antenna AN101	6dbi @698-787MHz 6dbi @824-894MHz 8dbi @1710-1755MHz 8dbi @1850-1995MHz 8dbi @2110-2155MHz	
Outdoor Antenna	Omi-directional Antenna PTE-GF-700-2500	2.7dbi @698-787MHz 3dbi @824-894MHz 3dbi @1710-1755MHz 3dbi @1850-1995MHz 3dbi @2110-2155MHz	
Indoor Cable	15feet (4.6 meters) RG58 Cable SMA male/SMA male M	1.5db @698-787MHz 1.7db @824-894MHz 2.4db @1710-1755MHz 2.65db @1850-1995MHz 2.9db @2110-2155MHz	
Outdoor Cable	15feet (4.6 meters) RG58 Cable SMA male/SMA male M	1.5db @698-787MHz 1.7db @824-894MHz 2.4db @1710-1755MHz 2.65db @1850-1995MHz 2.9db @2110-2155MHz	

Note: The above model antennas are suitable for AN-L65AV-01 booster.

Warning: Unauthorized antennas, cables and/or coupling devices are prohibited by FCC rules. Please contact FCC for details: 1-888-CALL-FCC

The antenna, cables, and other accessories of the booster kits shall not be modified without the approval of the ANNTLENT company, otherwise it shall be deemed invalid.

Electrical Specification:

Model	Frequency Band	Uplink	Downlink
V50IN-US59	B12,17	698 ~ 716MHz	728 ~ 746MHz
	B13	776 ~ 787MHz	746 ~ 757MHz
	B5	824 ~ 849MHz	869 ~ 894MHz
	B4	1710 ~ 1755MHz	2110 ~ 2155MHz
	B25,2	1850 ~ 1915MHz	1930 ~ 1995MHz
	B25,2	1850 ~ 1915MHz	1930 ~ 1995MHz
V50IN-CA60	B12,17	698 ~ 716MHz	728 ~ 746MHz
	B5	824 ~ 849MHz	869 ~ 894MHz
	B66,4	1710 ~ 1780MHz	2110 ~ 2200MHz
	B7	2500 ~ 2570MHz	2620 ~ 2690MHz
	Max. Gain	≤50dB	≤50dB
Max. Output Power	≤23dBm	≤10dBm	

Electrical Specification:

Automatic Gain Control	≤20dBm
Automatic Shut Down	The band channel is shut down automatically when self-oscillation happens, input signals are too strong or reduction value of the gain reaches the limit 20dB.
Noise Figure	≤8dB
VSWR	≤1.8
Group Delay	≤1.5μs
Power Supply	Car Charger Input DC12-24V, Output DC 12V 2A

APP Display & Control Function:







APP Page	Function
My Device - RF Control Parameters	Adjust the gain for each band channel (when self-oscillation happens or input signals are too strong).
	Monitor working status of the booster. Monitor the isolation status.
Find Cell Tower	See the frequency band of you phone and help you find the best installation location of outdoor antenna.
Installation Video	Watch guide videos to help you complete installation.
Help	Send messages to us if you have any queries or are experiencing any problems.

Mechanical Specifications:

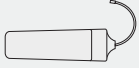
Mechanical Specifications	Standard
I / O Port	SMA Female
Impedance	50ohm
Operating Temperature	-25°C~+65°C
Environment Conditions	IP65
Dimensions(Length*Width*Height)	60mm*60mm*235mm
Weight	0.7Kg

Package Contents

Please confirm that your purchase includes the following items:

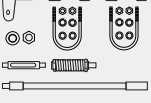
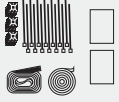
			
Tower Booster for Vehicle	Inside Patch Antenna with 9.85ft RG174 Cable	Power Feed Box	15ft Cable
			
DC/DC Power Supply	AC/DC Wall Power Supply	13.5 in. Mast Extension, Side-Exit Adapter, Spring & Mount Bracket	Installation Accessories

Introduction of the Tower Signal Booster

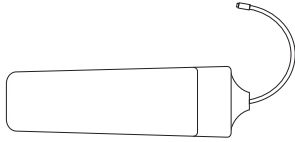

The tower signal booster is integrated with the outside antenna, so it can receive signals from the cell tower and amplify signals at the same time. Since input signals are now amplified before the loss happens (when transmitting through the cable), there is now greater effect of signal amplification.

Introduction of the Power Feed Box

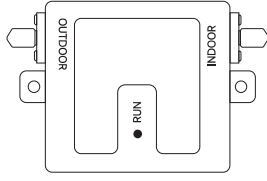

Since the tower signal booster is installed at a high location outside, the RF line feeding method is adopted and a power feed box is provided to help supply the power.

- If the power is correctly supplied, the indicator light of the power feed box shows green.
- If not, the indicator light shows red. In this case, please check if cables are connected correctly and all connectors are tightened.

Before Getting Started

Before starting your installation, please ensure that your cell phone operates on the same frequency band as the booster, and at least one bar of signal is present outside.

You can check your phone's frequency band by following the steps below:

• For iPhone:

- 1 Dial NO. *3001#12345#*
- 2 Tap 'Serving Cell Info'
- 3 Check 'Freq Band indicator' or 'Band info'

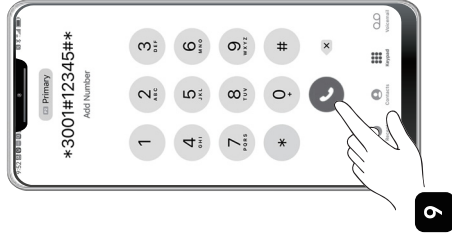

• **For Android:**

- 1 Download the "Signal Advisor" APP from Google Play



Signal Advisor

- 2 Tap "Find Cell Tower"



- 3 Check the band number

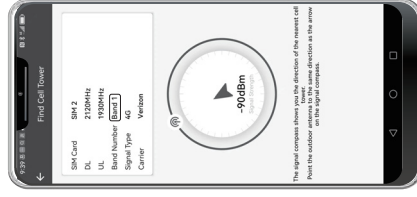

The frequency band number should be a one or two digit number. Verify if it matches with the band of the booster you ordered. If not, please contact us for assistance.

Installation Overview



Note: Do not power on the booster until system is fully installed.

Step 1 Mount Tower Booster & Route Cable

The tower booster should be mounted above the horizontal plane of the vehicle or above other gear on top of the vehicle.

Note: Keep in mind to stay below the maximum height limit allowed by law, which varies from region to region.

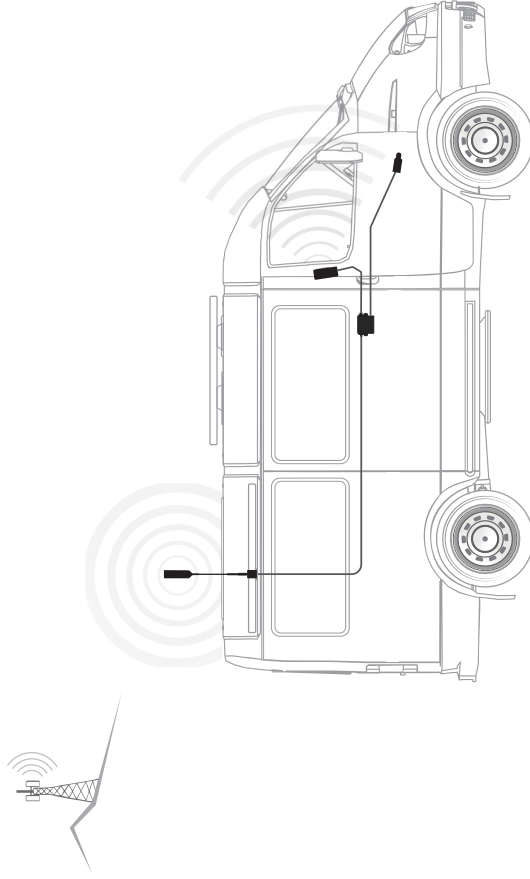

- 1 Once you have determined the best location for the tower booster, insert coax cable through mast extension, screw mast onto tower booster.

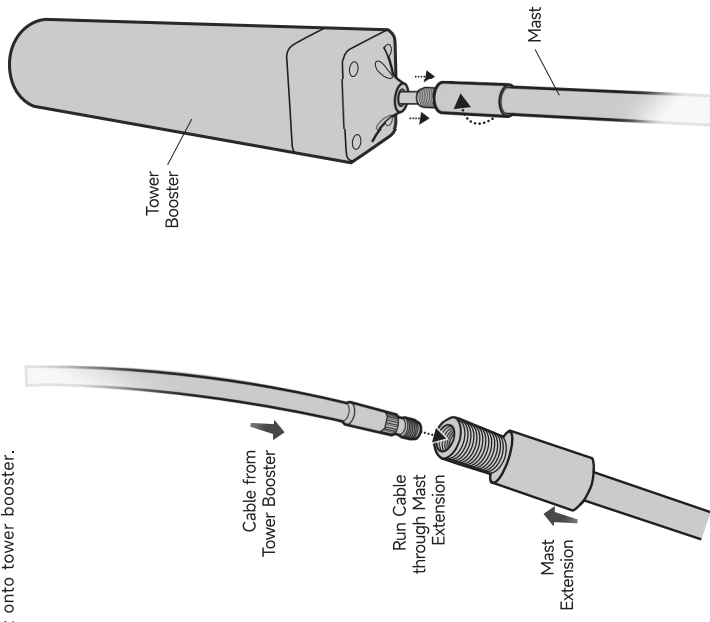

- 2 Insert coax cable through side-exit adapter, screw side-exit adapter onto mast.

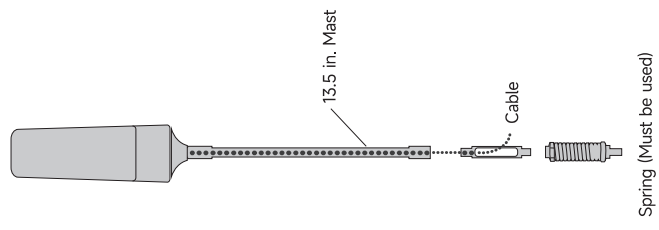

- 3 Connect 15ft cable to tower booster cable.

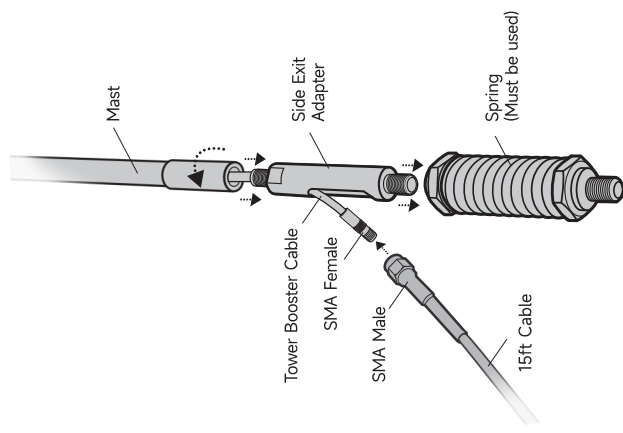

If the vehicle does not have built-in mounting points, the mount bracket is provided that will work on vehicles with mirror rails.

NOTE: The cable is strong enough that it may be shut in most vehicle doors without damaging the cable.

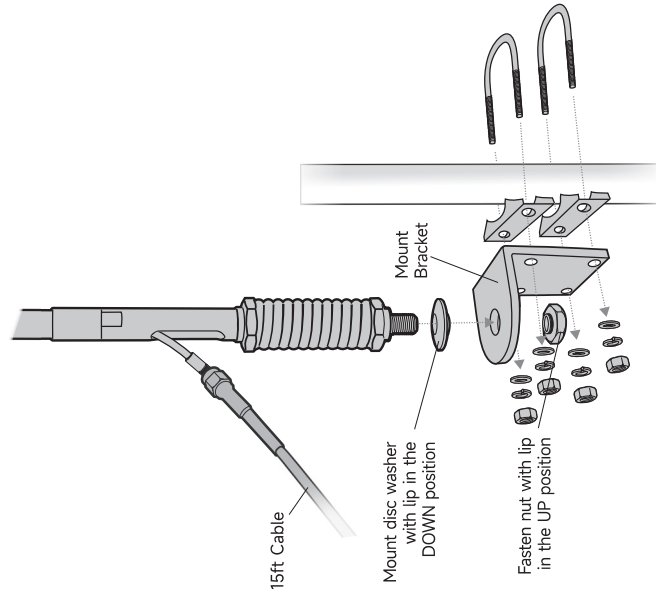

Determine where you want the cable to enter the vehicle.



Option 1: Using existing cable entry point.

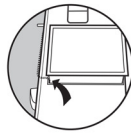

Option 2: Through the slider on your vehicle (using the slider gasket as a seal).



Option 3: Drill a hole.

⚠ WARNING: Be sure to stay clear of any power, pipes, etc. that may be damaged.

NOTE: It is recommended to do a 'soft install' before drilling the hole. Set up the system by routing the cable through an open door or window, completing the setup instructions, verifying the system works as desired, and then drilling the hole.

Step 2 Mount the Inside Antenna

Identify a place to mount the in-vehicle antenna, either on the side of the seat or on the dash. Mount the antenna within 18 to 36 inches of the cellular device.

The back of the inside antenna is sticky, remove the film and attach to your preferred location.

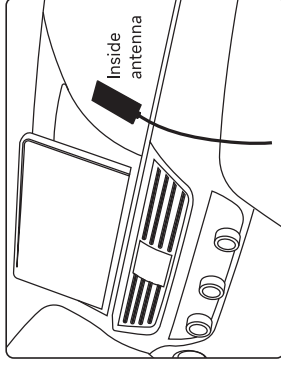
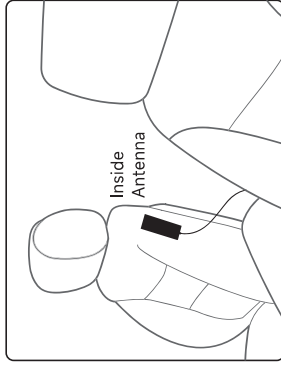

Step 3 Connect Cable to Power Feed Box

Connect the cable from the tower booster to the port labeled "OUTDOOR" on the power feed box.

NOTE: Velcro fastener can be used to fasten the power feed box in a specific location if desired.

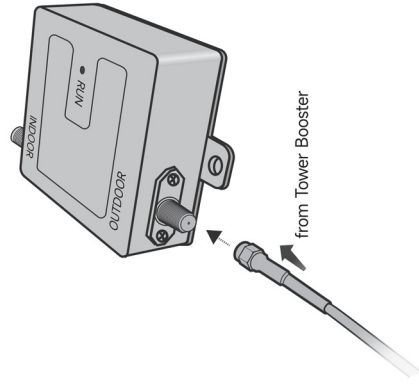
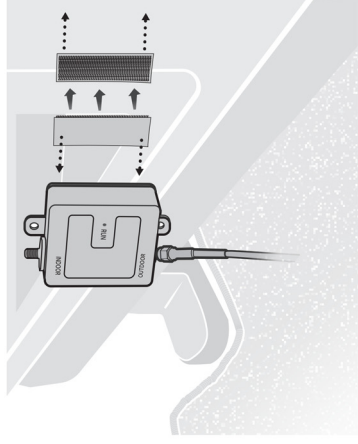

Connect the cable from the inside antenna to the port labeled "INDOOR" on the power feed box.

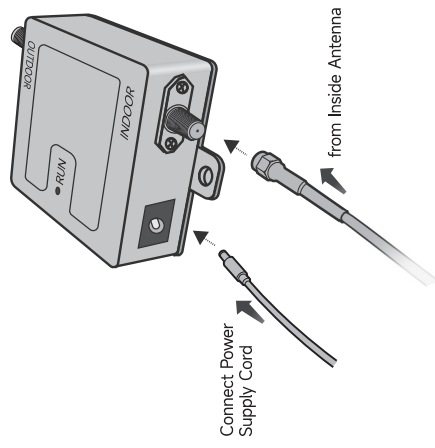

Step 4 Power Up & Check Performance

Connect the power supply cord to the end of the power feed box. Plug the power adapter into vehicle's 12V DC power supply.

Note:

Do NOT connect the power to the power feed box until you have fully installed the system.

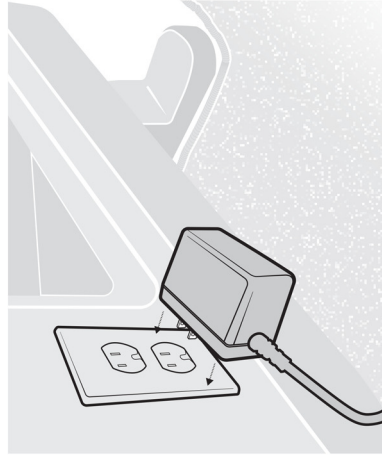

Step 5 Organise & Secure the Cable

After making sure installation is correct and performance is satisfactory, use the included cable mounts and ties to organise and secure cable to the vehicle.

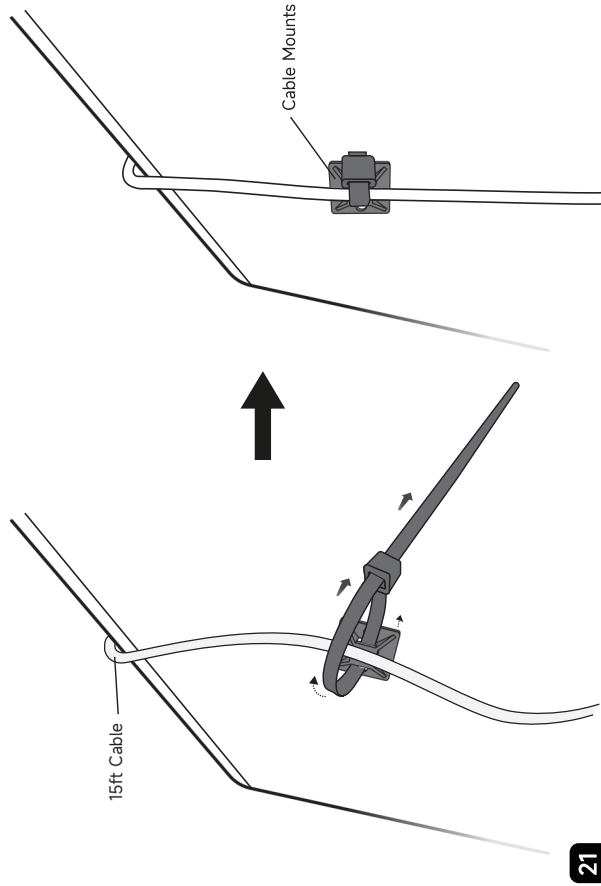

Troubleshooting

Problem	Resolution
Indicator Light of the Power Feed Box shows Red	<ol style="list-style-type: none">1. Check that the tower booster is connected to the connector of the power feed box labeled 'OUTDOOR' and the inside antenna is connected to the connector labeled 'INDOOR'.2. Make sure cables are connected correctly and all connectors are tightened.
Indoor signal strength has not improved	<ol style="list-style-type: none">1. Check if the installation is correct. If not sure, please contact us.2. Connect the booster to Signal Advisor APP and check the working status of the booster.3. Verify that the frequency band of your cell phone matches with the frequency band supported by booster. <p>For Android: Use our 'Signal Advisor' APP, see the APP instruction for detailed guide For iPhone: Dial No. *3001#12345#* → Tap 'Serving Cell Info' → Check 'Band Info'</p>

NOTE: The signal booster can be reset by disconnecting and reconnecting the power supply. After performing the above adjustment, please remember to reconnect the power supply to restart the signal booster.

Instructions of Signal Advisor APP:

• For Android:

Download from Google Play



1 Log in:

After launching the APP, for the first time use, you need to register your account, you will be prompted to enter your email address, your buying platform and create your password.

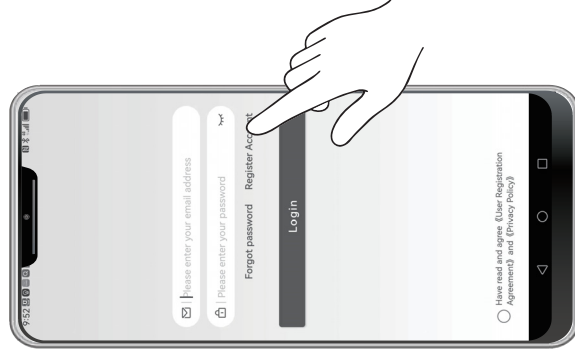

2 Connect your booster:

After powering on the booster and logging into the APP, you will see the page as shown on the left. Tap 'Connect Device' to search for your signal booster, then tap 'Connect'.

Note: Please get as close as possible to the booster when connecting.

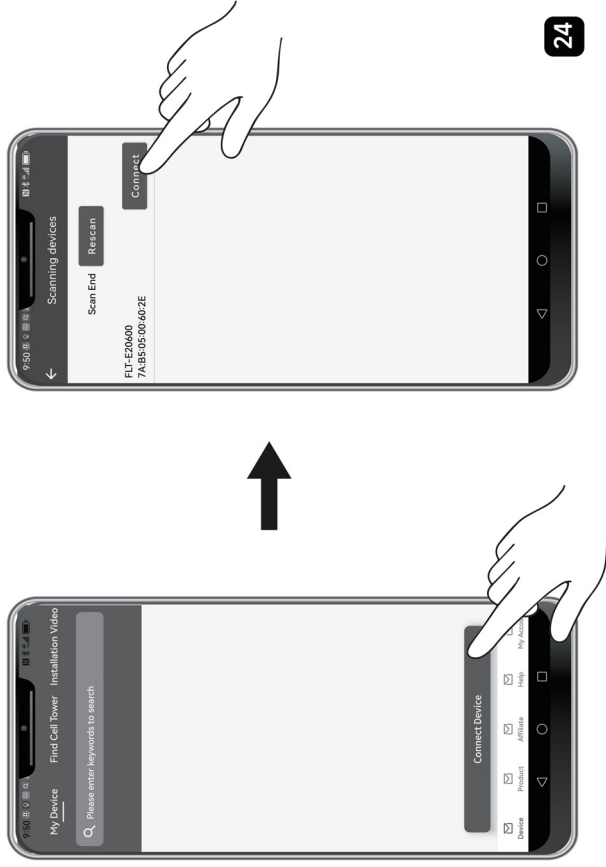

After successful connection, you can see that the booster is now shown on 'My Device' page, and you can enter the page as shown on the right. The output power for each frequency band of the booster is displayed here. You can see more detailed information for each band by tapping each band icon.

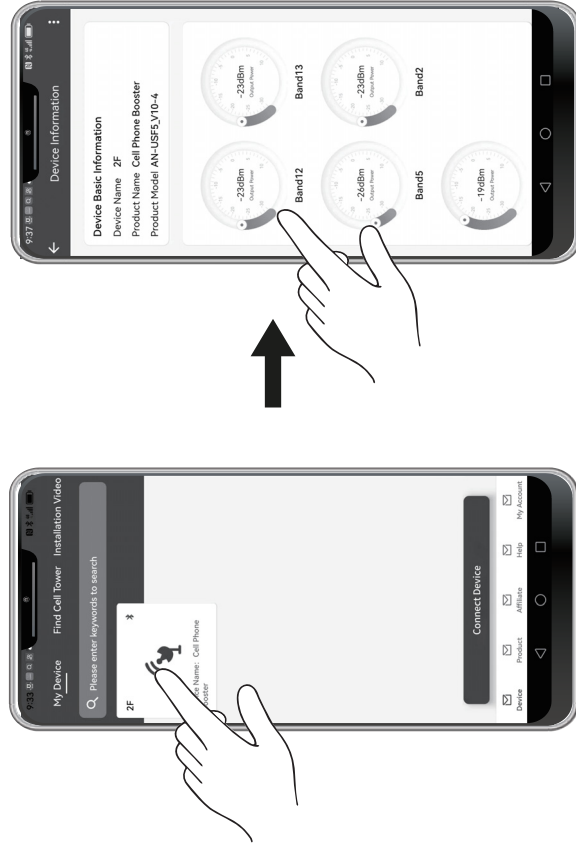

3 Monitor Working Status and Adjust the Gain:

After selecting one particular band, you can enter the page as shown. Here you can observe the **output power**, the **gain**, **channel status** and current **isolation status** of the booster for Band 12. You can adjust the gain by dragging the white circle along the blue bar. At the bottom of the screen, you can switch between different frequency bands.

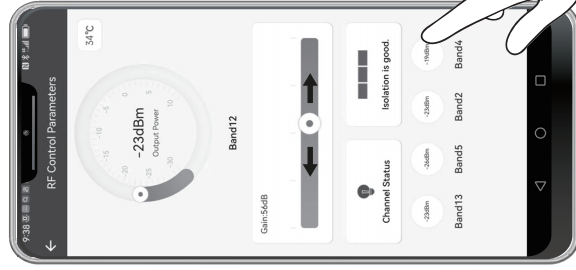

Just in case, if you observe the page as shown on the left (channel status shows red), it means that the booster is not boosting signals for Band 12. Please don't worry, you may adjust the gain or tap the red bulb icon to see solution guide.

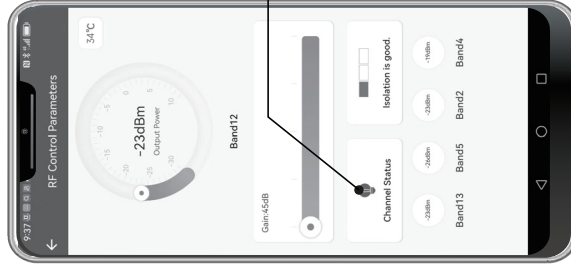
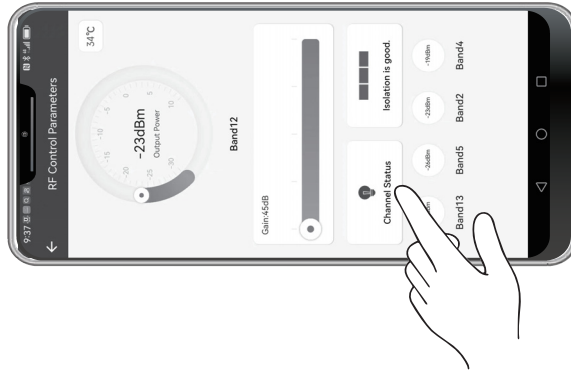

OSC Alarm:

1. Please increase the separation between the inside and outside antennas, additional vertical separation works best.
2. Please make sure there is a barrier between inside and outside antennas, such as a thick wall.
3. If your booster kit uses directional antennas, ensure that they are facing away from one another.

5 Watch Installation Video:

At the top of the screen, tap 'Installation Video':



6 Contact Us:

If you are experiencing any product installation problems, please do not hesitate to contact us.

You can send messages to us by tapping 'Help' at the bottom of the screen. You can also leave your email address here if we don't reply in time.

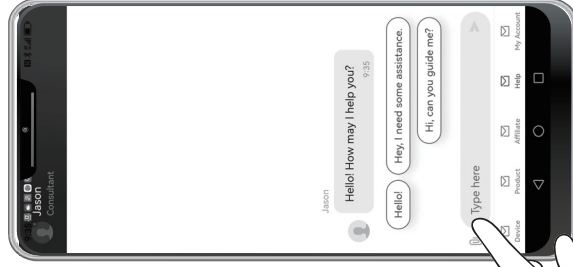

- For iPhone:

Download the APP from App Store



1 Test Frequency Band:

Dial No. *3001#12345#* → Tap 'Serving Cell Info'
→ Check 'Band Info'

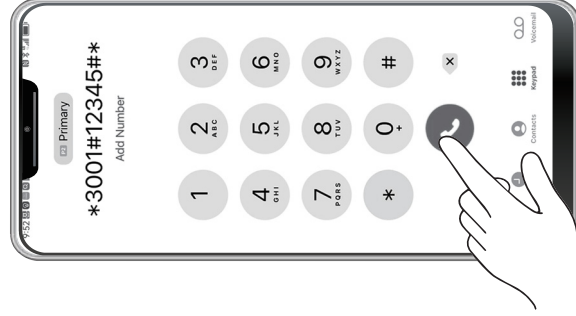

2 Find Cell Tower:

First, tap 'Find Cell Tower'. Then, tap the text 'Click to get the location' and you can enter the page as shown on the right. You can now follow instruction steps to fill in your 'Cell ID' and 'LAC' and then tap 'Find the cell tower'.

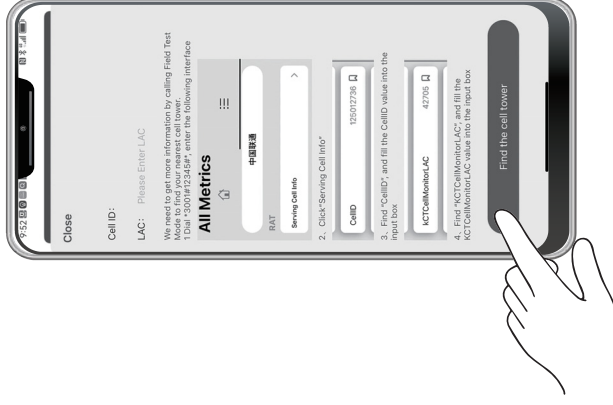
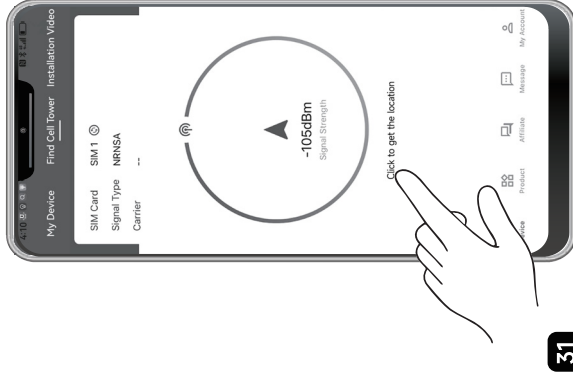



Follow the signal strength prompts shown in the blue circle to find a direction with strong and stable signals as the installation direction of your outdoor antenna. You can tap the text **'Try again to find the cell tower'** to go to the previous page.

Other functions of the APP for iPhone please refer to the instruction for Android, they are basically the same.

Warranty

30-day money-back guarantee
90-day free replacement
2-year manufacturer warranty

We provide a standard warranty period for each item from the date of purchase, some cases may have an extended warranty, please contact our service for more detail.

This limited warranty provided by the manufacturer in no way affects a potential statutory warranty provided by law.

You can enjoy an extra 1-year warranty and priority customer support after registering the booster on our website.

Note:

1. Only for customers that bought the product at FULL PRICE through our Official Seller on Amazon.com.
2. The 3-year Warranty is only for the MAIN BOOSTER, EXCLUDING antennas, cables and power supply.
3. To register, please go to our website to active your warranty: <https://www.invcall.com/pages/active-warranty>

Any questions, please contact us.



wecare@invcall.com



www.invcall.com