

RADIO TEST REPORT

For

Shenzhen Phonetone Technology Co., Ltd.

Cell phone signal booster

Model No.: PTE-C70

Prepared for : Shenzhen Phonetone Technology Co., Ltd.
Address : Room 404, Building 12, Qianlong Estate, Minzhi Sub-district,
Bao'an District, Shenzhen, China

Prepared by : Shenzhen LCS Compliance Testing Laboratory Ltd.
Address : 1F., Xingyuan Industrial Park, Tongda Road, Bao'an Blvd., Bao'an
District, Shenzhen, Guangdong, China

Date of receipt of test sample : September 07, 2012
Number of tested samples : 1
Serial number : Prototype
Date of Test : September 07, 2012 – October 15, 2012
Date of Report : October 15, 2012

RADIO TEST REPORT

FCC CFR 47 PART 22 SUBPART H

Report Reference No. : **LCS120907044TF**

Date of Issue : October 15, 2012

Testing Laboratory Name : **Shenzhen LCS Compliance Testing Laboratory Ltd.**Address : 1F., Xingyuan Industrial Park, Tongda Road, Bao'an Blvd.,
Bao'an District, Shenzhen, Guangdong, ChinaTesting Location/ Procedure : Full application of Harmonised standards
Partial application of Harmonised standards
Other standard testing method **Applicant's Name** : **Shenzhen Phonetone Technology Co., Ltd.**Address : Room 404, Building 12, Qianlong Estate, Minzhi Sub-district,
Bao'an District, Shenzhen, China**Test Specification**

Standard : FCC CFR 47 PART 22 SUBPART H

Test Report Form No. : LCSEMC-1.0

TRF Originator : Shenzhen LCS Compliance Testing Laboratory Ltd.

Master TRF : Dated 2011-03

SHENZHEN LCS COMPLIANCE TESTING LABORATORY LTD. All rights reserved.

This publication may be reproduced in whole or in part for non-commercial purposes as long as the Shenzhen LCS Compliance Testing Laboratory Ltd. is acknowledged as copyright owner and source of the material. Shenzhen LCS Compliance Testing Laboratory Ltd. takes no responsibility for and will not assume liability for damages resulting from the reader's interpretation of the reproduced material due to its placement and context.

Test Item Description. : **Cell phone signal booster**

Trade Mark :



Model/ Type reference : PTE-C70

Ratings : DC 6V, Rated current: 2.5A

Result : **Positive****Compiled by:**

Ada Liang

Supervised by:

Vito Cao

Approved by:

Gavin Liang

Ada Liang / File administrators

Vito Cao/ Technique principal

Gavin Liang/ Manager

RADIO -- TEST REPORT

Test Report No. : LCS120907044TF	<u>October 15, 2012</u> Date of issue
---	--

Type / Model.....	: Cell phone signal booster
EUT.....	: PTE-C70
Applicant.....	: Shenzhen Phonetone Technology Co., Ltd.
Address.....	: Room 404, Building 12, Qianlong Estate, Minzhi Sub-district, Bao'an District, Shenzhen, China
Telephone.....	: /
Fax.....	: /
Manufacturer.....	: Shenzhen Phonetone Technology Co., Ltd.
Address.....	: Room 404, Building 12, Qianlong Estate, Minzhi Sub-district, Bao'an District, Shenzhen, China
Telephone.....	: /
Fax.....	: /
Factory.....	: Shenzhen Phonetone Technology Co., Ltd.
Address.....	: Room 404, Building 12, Qianlong Estate, Minzhi Sub-district, Bao'an District, Shenzhen, China
Telephone.....	: /
Fax.....	: /

Test Result:	Positive
---------------------	-----------------

The test report merely corresponds to the test sample.
 It is not permitted to copy extracts of these test result without the written permission of the test laboratory.

TABLE OF CONTENTS

1. GENERAL INFORMATION	5
1.1. DESCRIPTION OF DEVICE (EUT)	5
1.2. POWER SUPPLY AND LINE FILTERS	5
1.3. DESCRIPTION OF TEST FACILITY	6
1.4. STATEMENT OF THE MEASUREMENT UNCERTAINTY	6
1.5. MEASUREMENT UNCERTAINTY	6
1.6. TEST ENVIRONMENT	6
2. TEST METHODOLOGY	7
2.1. EUT CONFIGURATION	7
2.2. OBJECTIVE	7
2.3. GENERAL TEST PROCEDURES	7
3. SYSTEM TEST CONFIGURATION	8
3.1. JUSTIFICATION	8
3.2. EUT EXERCISE SOFTWARE	8
3.3. SPECIAL ACCESSORIES	8
3.4. BLOCK DIAGRAM/SCHEMATICS	8
3.5. EQUIPMENT MODIFICATIONS	8
3.6. BLOCK DIAGRAM OF TEST SETUP	8
4. SUMMARY OF TEST RESULTS.....	9
5. TEST RESULT	10
5.1. RF OUTPUT POWER	10
5.2. OCCUPIED BANDWIDTH	12
5.3. SPURIOUS AND HARMONIC EMISSION AT ANTENNA TERMINAL	20
5.4. RADIATED EMISSIONS MEASUREMENT	34
5.5. POWER LINE CONDUCTED EMISSIONS.....	36
5.6. FREQUENCY STABILITY OVER TEMPERATURE AND VOLTAGE VARIATIONS	38
5.7. DEVIATION TO TEST SPECIFICATIONS	39
6. LIST OF MEASURING EQUIPMENTS.....	40
7. MANUFACTURER/ APPROVAL HOLDER DECLARATION	41

1. GENERAL INFORMATION

1.1. Description of Device (EUT)

EUT : Cell phone signal booster

Model Number : PTE-C70

Serial no.(SN) : 01

Type of modulation GSM (GXW)

and Designator GSM EDGE (G7W)

CDMA (F9W)

W-CDMA (F9W)

Power Supply : DC 6V, Rated current: 2.5A

Frequency Range : Uplink : 824 – 849 MHz
Downlink :869 – 894 MHz

Modulation Technology : GMSK

RF Output Power : Uplink 23dBm, Downlink 25dBm

Max Gain : Uplink 65dB, Downlink 70dB

Antenna Gain : Max 3.0dBi

1.2. Power Supply and Line Filters

Manufacturer	Description	Model	Serial Number
Shenzhen Phonetone Technology Co., Ltd.	Input AC 110-240V,50/60Hz Output DC 6V, 2.5A	QXP0600250	01

1.3. Description of Test Facility

Site Description

EMC Lab.

: Accredited by CNAS, June 04, 2010

The Certificate Registration Number. is L4595.

Accredited by FCC, July 14, 2011

The Certificate Registration Number. is 899208.

Accredited by Industry Canada, May. 02, 2011

The Certificate Registration Number. is 9642A-1

1.4. Statement of The Measurement Uncertainty

The data and results referenced in this document are true and accurate. The reader is cautioned that there may be errors within the calibration limits of the equipment and facilities. The measurement uncertainty was calculated for all measurements listed in this test report acc. To CISPR 16 – 4 “Specification for radio disturbance and immunity measuring apparatus and methods – Part 4: Uncertainty in EMC Measurements” and is documented in the LCS quality system acc. To DIN EN ISO/IEC 17025. Furthermore, component and process variability of devices similar to that tested may result in additional deviation. The manufacturer has the sole responsibility of continued compliance of the device.

1.5. Measurement Uncertainty

Test Item	Frequency Range	Uncertainty	Note
Radiation Uncertainty	30MHz~200MHz	$\pm 2.96\text{dB}$	(1)
	200MHz~1000MHz	$\pm 3.10\text{dB}$	(1)
	1GHz~26.5GHz	$\pm 3.80\text{dB}$	(1)
Conduction Uncertainty	150kHz~30MHz	$\pm 1.63\text{dB}$	(1)
Power disturbance	30MHz~300MHz	$\pm 1.60\text{dB}$	(1)

(1). This uncertainty represents an expanded uncertainty expressed at approximately the 95% confidence level using a coverage factor of $k=2$.

1.6. Test environment

All tests were performed under the following environmental conditions:

Condition	Minimum value	Maximum value
Barometric pressure	86kPa	106kPa
Temperature	15°C	30°C
Relative Humidity	20 %	75 %
Power supply range	$\pm 5\%$ of rated voltages	

2. TEST METHODOLOGY

All tests and measurements indicated in this document were performed in accordance with the Code of Federal Regulations Title 47 Part 2, Sub-part J as well as the following parts:

Part 22 Subpart H - Public Mobile Services

Applicable Standards: TIA/EIA603-C, ANSI C63.4-2003. The radiated testing was performed at an antenna-to-EUT distance of 3 meters. All radiated and conducted emissions measurement was performed at Shenzhen LCS Compliance Testing Laboratory Ltd..

2.1. EUT Configuration

The EUT configuration for testing is installed on RF field strength measurement to meet the Commissions requirement and operating in a manner that intends to maximize its emission characteristics in a continuous normal application.

2.2. Objective

This type approval report is prepared on behalf of Shenzhen Phonetone Technology Co., Ltd. in accordance with Part 2, Subpart J, Part 22 Subpart H of the Federal Communication Commissions rules.

The objective is to determine compliance with FCC rules for RF output power, modulation characteristics, occupied bandwidth, spurious emissions at antenna terminal, field strength of spurious radiation, frequency stability, band edge, and conducted and radiated margin.

2.3. General Test Procedures

2.3.1 Conducted Emissions

The EUT is placed on the turntable, which is 0.8 m above ground plane. According to the requirements in Section 13.1.4.1 of ANSI C63.4 Conducted emissions from the EUT measured in the frequency range between 0.15 MHz and 30MHz using Quasi-peak and average detector modes.

2.3.2 Radiated Emissions

The EUT is placed on a turn table, which is 0.8 m above ground plane. The turntable shall rotate 360 degrees to determine the position of maximum emission level. EUT is set 3m away from the receiving antenna, which varied from 1m to 4m to find out the highest emission. And also, each emission was to be maximized by changing the polarization of receiving antenna both horizontal and vertical. In order to find out the maximum emissions, exploratory radiated emission measurements were made according to the requirements in Section 13.1.4.1 of ANSI C63.4

3. SYSTEM TEST CONFIGURATION

3.1. Justification

The EUT was configured for testing according to TIA/EIA-603-C.

The final qualification test was performed with the EUT operating at normal mode.

3.2. EUT Exercise Software

N/A.

3.3. Special Accessories

N/A.

3.4. Block Diagram/Schematics

Please refer to the report.

3.5. Equipment Modifications

No modification on the EUT.

3.6. Block Diagram of Test Setup

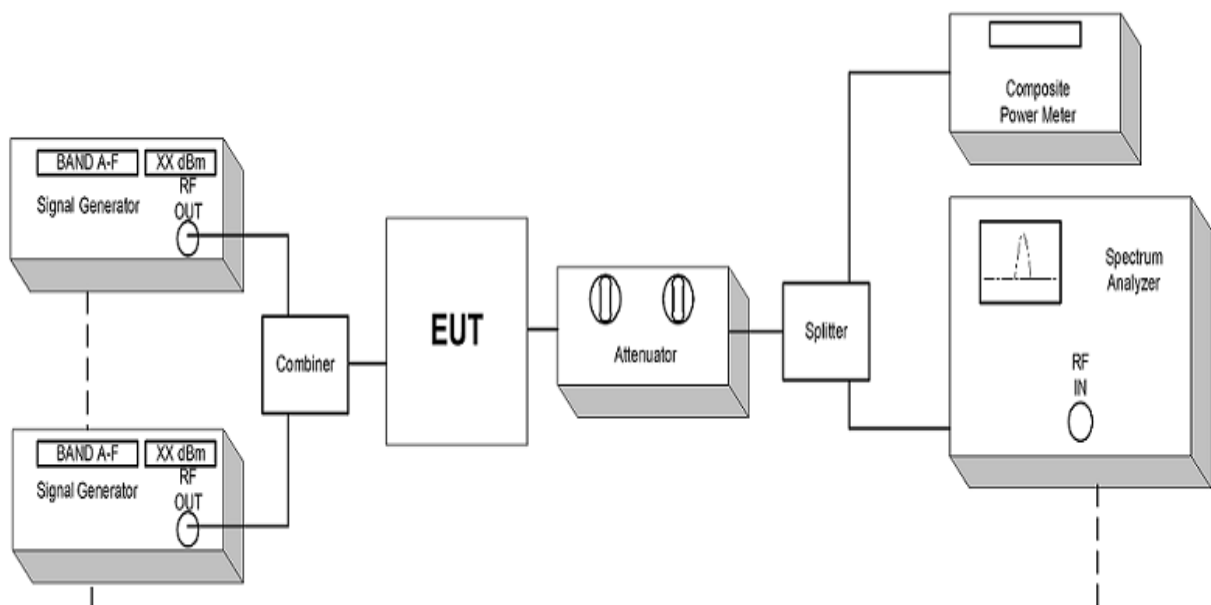

4. SUMMARY OF TEST RESULTS

Applied Standard: 47 CFR FCC Part 22 Subpart H, Part 24 Subpart E		
FCC Rules	Description of Test	Result
§2.1046, §22.913	RF Power Output	Compliant
§2.1047	Modulation Characteristics	N/A*
§2.1049, §22.917	Occupied Bandwidth	Compliant
§2.1053, §22.917	Radiated Spurious Emissions	Compliant
§2.1051, §22.917	Spurious Emissions at Antenna Terminals	Compliant
§22.917	Band Edge	Compliant
§2.1055; §22.355	Frequency Stability	N/A*
§15.107	AC power line conducted emissions	Compliant
§2.1091	RF Exposure Information	Compliant

N/A: According to FCC §2.1047(d), Part 22H, there is no specific requirement for digital modulation and no oscillator circuit, therefore modulation characteristic is not presented.*

5. TEST RESULT

5.1. RF OUTPUT POWER

5.1.1. Standard Applicable

§ 2.1046 Measurements required: RF power output:

§ 2.1046 (a) For transmitters other than single sideband, independent sideband and controlled carrier radiotelephone, power output shall be measured at the RF output terminals when the transmitter is adjusted in accordance with the tune-up procedure to give the values of current and voltage on the circuit elements specified in § 2.1033(c)(8). The electrical characteristics of the radio frequency load attached to the output terminals when this test is made shall be stated.

§ 2.1046 (b) For single sideband, independent sideband, and single channel, controlled carrier radiotelephone transmitters, the procedure specified in paragraph (a) of this section shall be employed and, in addition, the transmitter shall be modulated during the test as specified and as applicable in § 2.1046 (b) (1-5). In all tests, the input level of the modulating signal shall be such as to develop rated peak envelope power or carrier power, as appropriate, for the transmitter.

§ 2.1046 (c) For measurements conducted pursuant to paragraphs (a) and (b) of this section, all calculations and methods used by the applicant for determining carrier power or peak envelope power, as appropriate, on the basis of measured power in the radio frequency load attached to the transmitter output terminals shall be shown. Under the test conditions specified, no components of the emission spectrum shall exceed the limits specified in the applicable rule parts as necessary for meeting occupied bandwidth or emission limitations.

§ 22.913 Effective radiated power limits.

The effective radiated power (ERP) of transmitters in the Cellular Radiotelephone Service must not exceed the limits in this section.

(a) Maximum ERP. In general, the effective radiated power (ERP) of base transmitters and cellular repeaters must not exceed 500 Watts.

5.1.2. Measuring Instruments and Setting

Please refer to section 6 of equipments list in this report. The following table is the setting of the spectrum analyzer.

5.1.3. Test Procedures

As required by 47 CFR 2.1046, RF power output measurements were made at the RF output terminals using an attenuator and spectrum analyzer or power meter. This test was performed in all applicable modulations.

5.1.4. Test Results

Temperature	25°C	Humidity	60%
ATM Pressure:	101.4kPa	Test Engineer	Vito Cao

GSM 850

Carrier Channel	DOWNLINK		UPLINK	
	Frequency (MHz)	Measured Power (dBm)	Frequency (MHz)	Measured Power (dBm)
Low	869.2	24.53	824.2	22.73
Middle	881.6	24.99	836.6	22.98
High	893.8	24.08	848.8	22.54

INPUT SIGNAL	DOWNLINK	UPLINK
Source	GSM	GSM
Power Level	-45 dBm	-45 dBm
Amplitude offset	-30dB	-30dB

5.2. OCCUPIED BANDWIDTH

5.2.1. Standard Applicable

§2.1049 Measurements required: Occupied bandwidth: The occupied bandwidth, that is the frequency bandwidth such that, below its lower and above its upper frequency limits, the mean powers radiated are each equal to 0.5 percent of the total mean power radiated by a given emission shall be measured under the specified conditions of § 2.1049 (a) through (i) as applicable.

5.2.2. Measuring Instruments and Setting

Please refer to section 6 of equipments list in this report. The following table is the setting of Spectrum Analyzer.

5.2.3. Test Procedures

As required by 47 CFR 2.1049, occupied bandwidth measurements were made with a Spectrum Analyzer connected to the RF ports for both Uplink and Downlink. The modulation characteristics of signal generator's carrier was measured first at a maximum RF level prescribed by the OEM. The signal generator was then connected to either the Uplink or Downlink input at the appropriate RF level. The resulting modulated signal through the EUT was measured and compared against the original signal.

5.2.4. Test Setup Layout

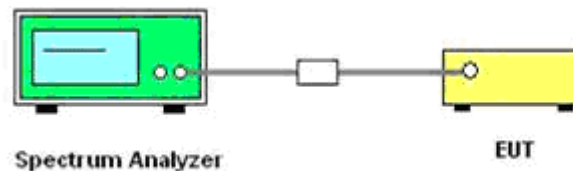

5.2.5. Test Results

Temperature	25°C	Humidity	60%
ATM Pressure:	101.4kPa	Test Engineer	Vito Cao

GSM 850

Carrier Channel	DOWNLINK		UPLINK	
	Frequency (MHz)	Occupied Bandwidth (KHz)	Frequency (MHz)	Occupied Bandwidth (KHz)
Low	869.2	249.2715	824.2	244.8264
Middle	881.6	243.9956	836.6	244.9444
High	893.8	248.4373	848.8	242.3194

INPUT SIGNAL	DOWNLINK	UPLINK
Source	GSM	GSM
Power Level	-45 dBm	-45 dBm
Amplitude offset	-30dB	-30dB

Plots of Occupied Bandwidth

Downlink GSM 850 Low CH Input Signal

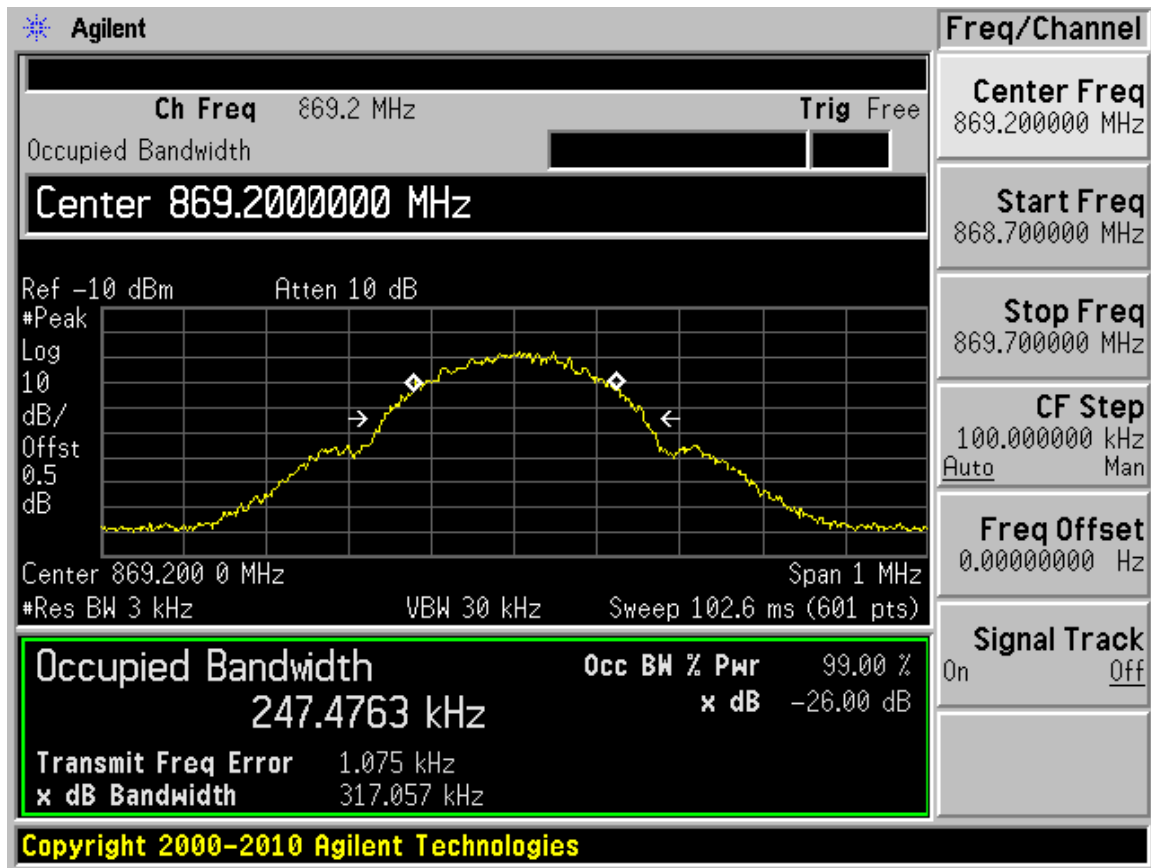

Downlink GSM 850 Low CH Output Signal

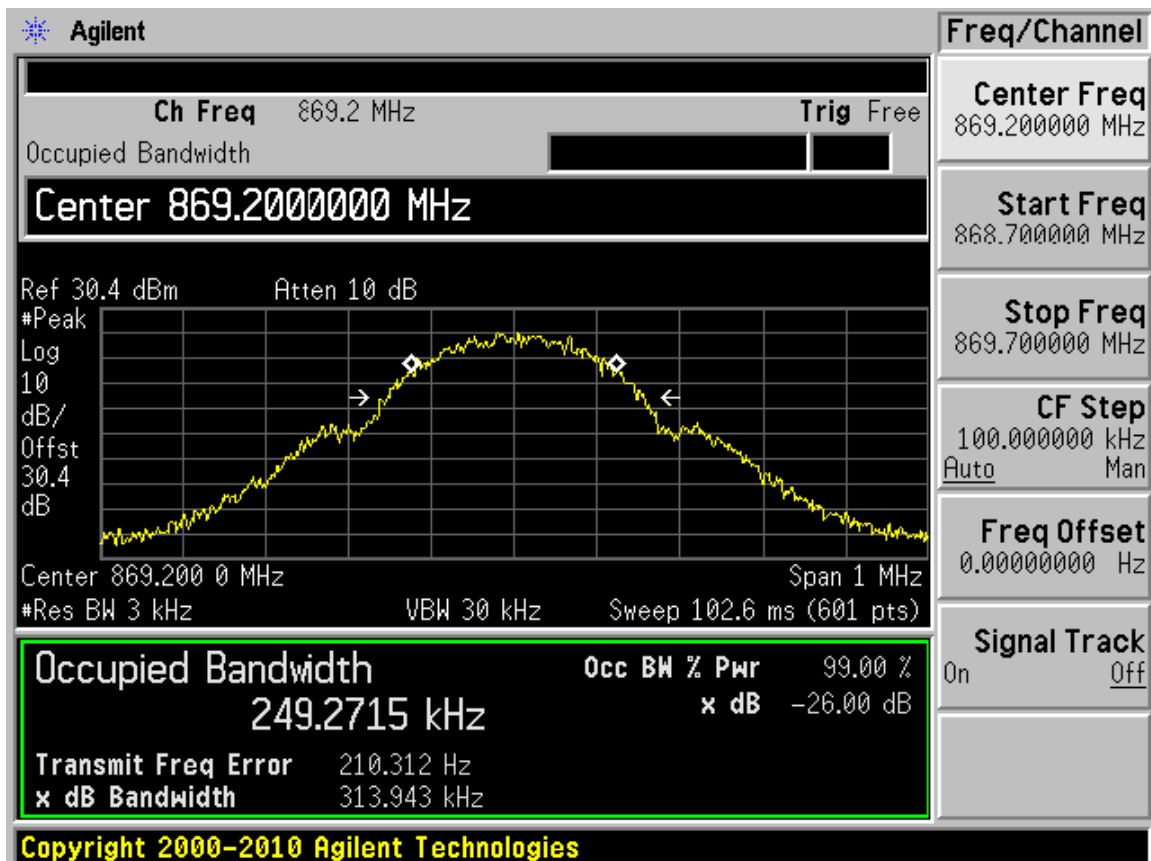

Downlink GSM 850 Middle CH Input Signal

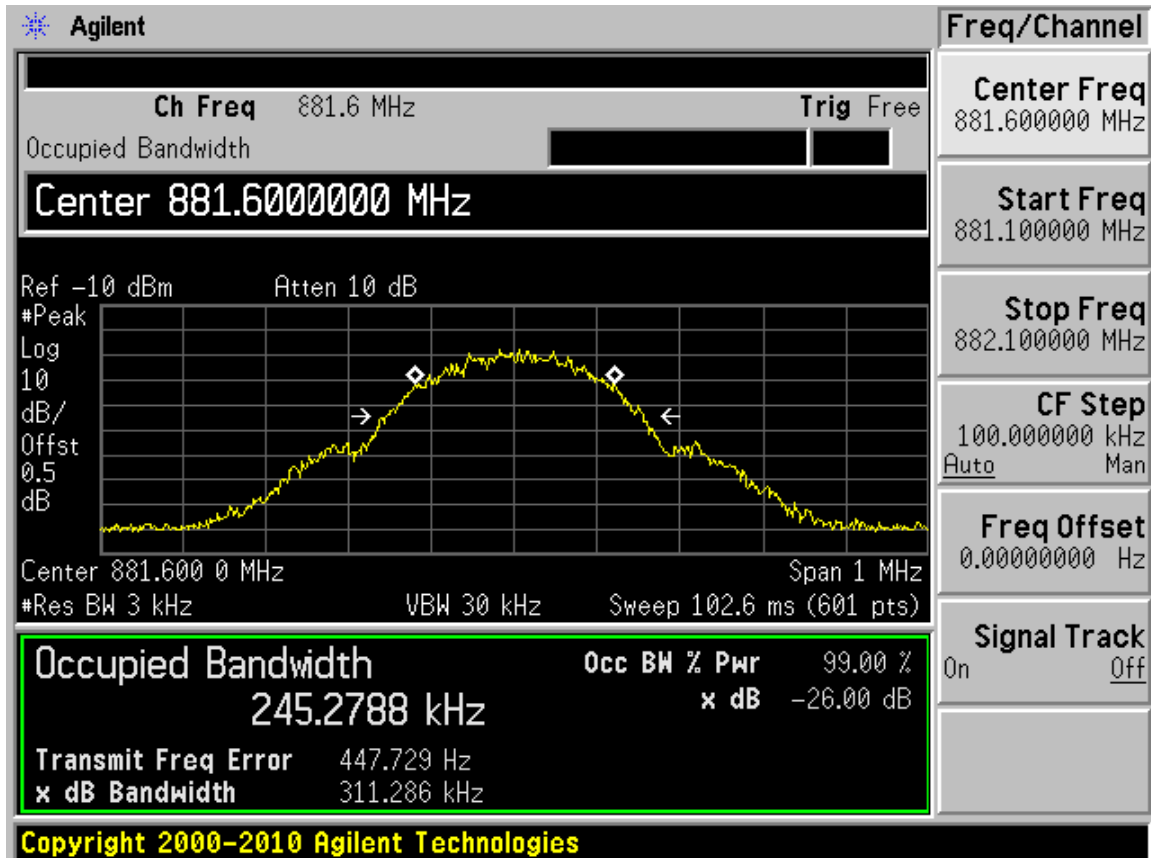

Downlink GSM 850 Middle CH Output Signal

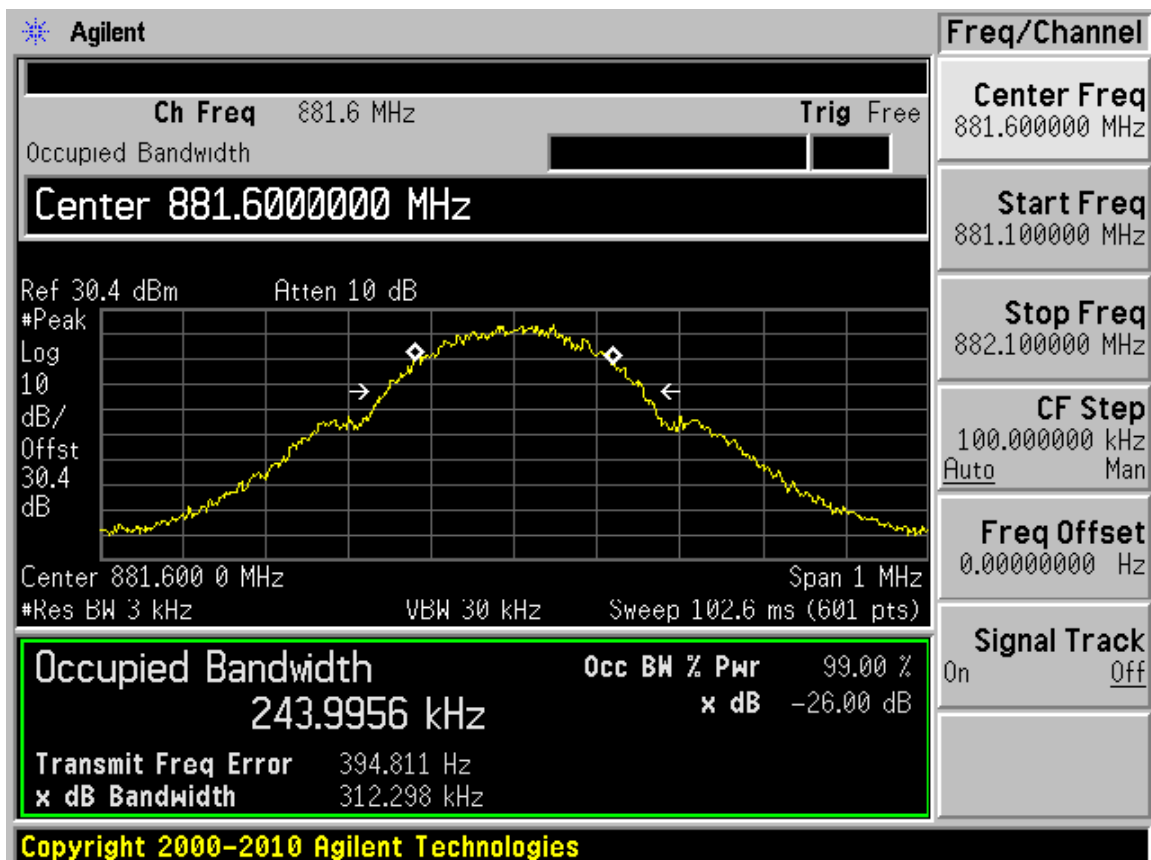

Downlink GSM 850 High CH Input Signal

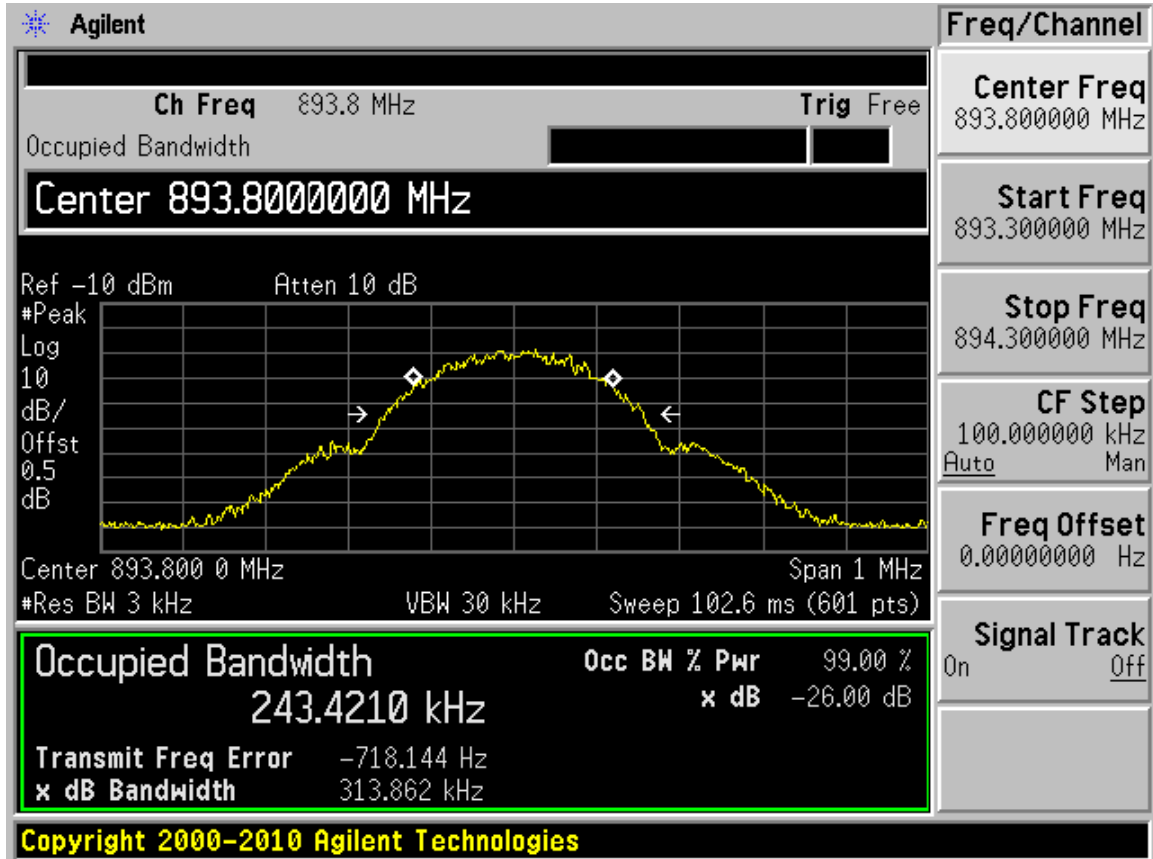

Downlink GSM 850 High CH Output Signal

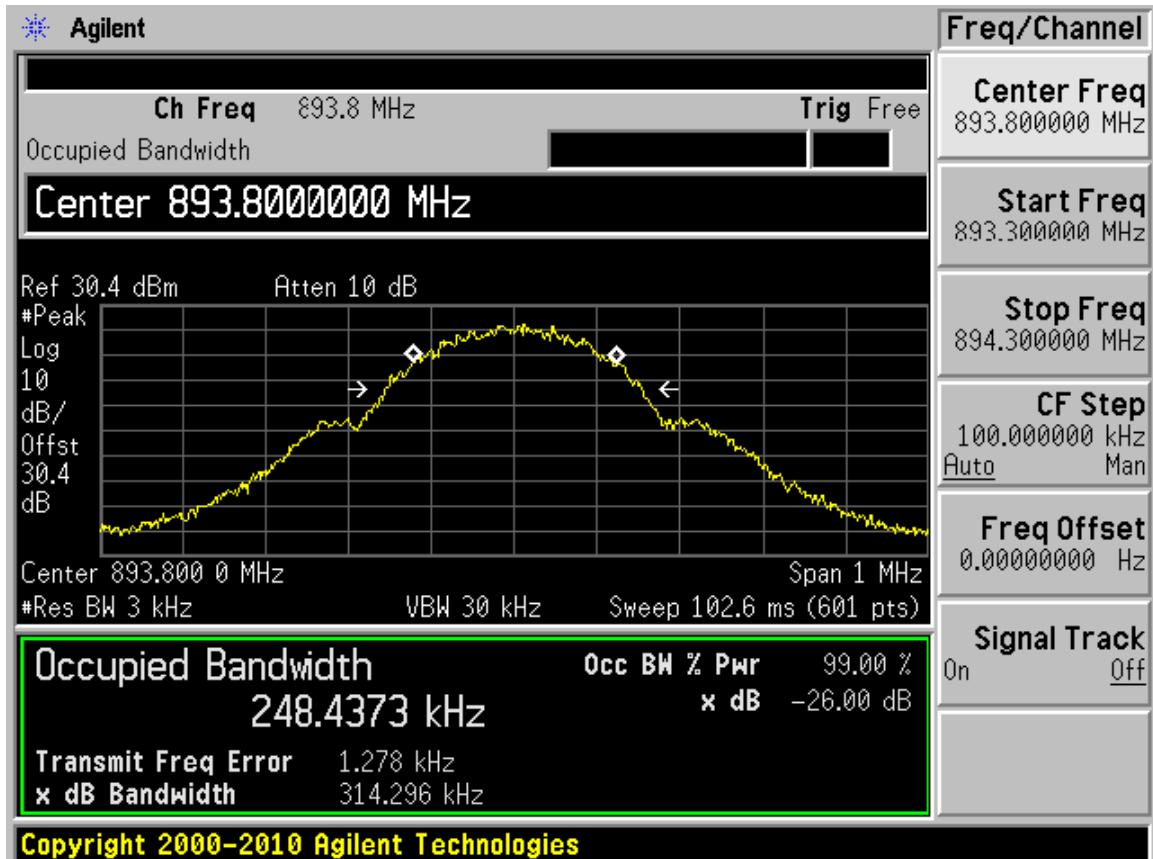

Uplink GSM 850 Low CH Input Signal

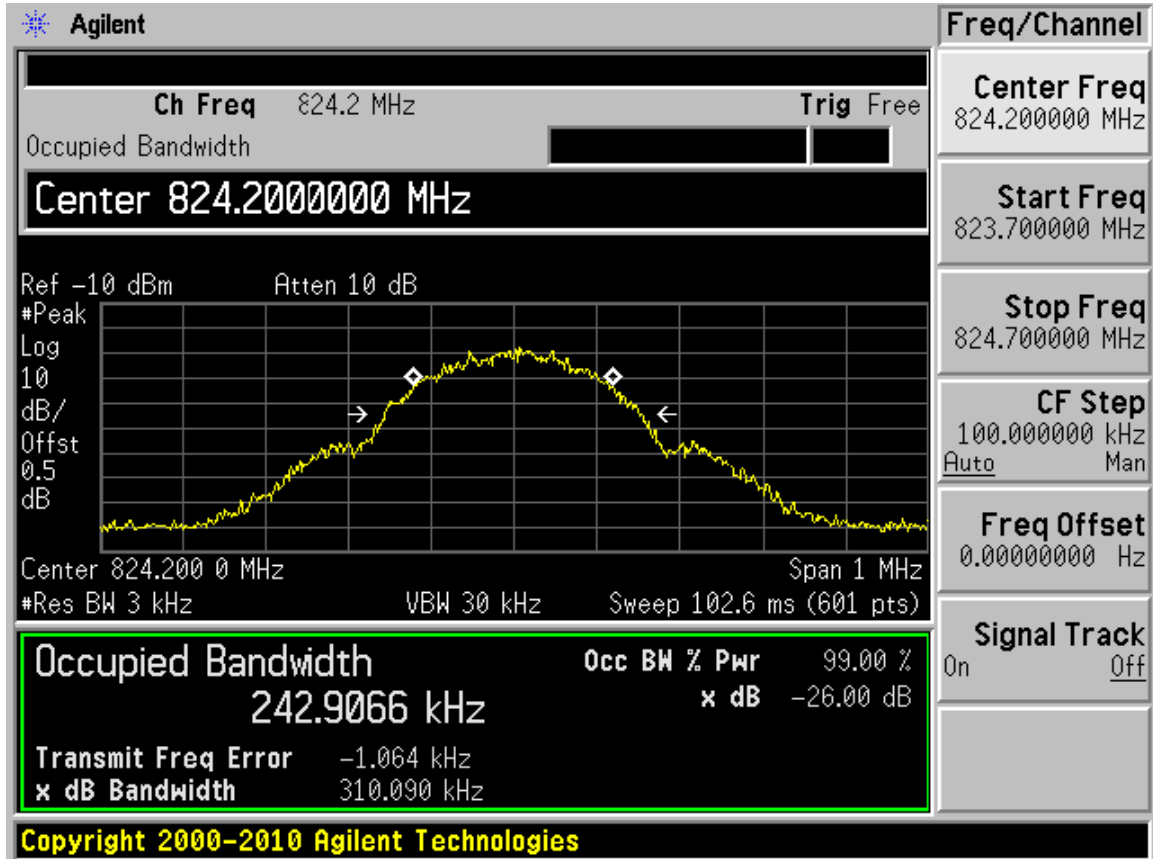

Uplink GSM 850 Low CH Output Signal

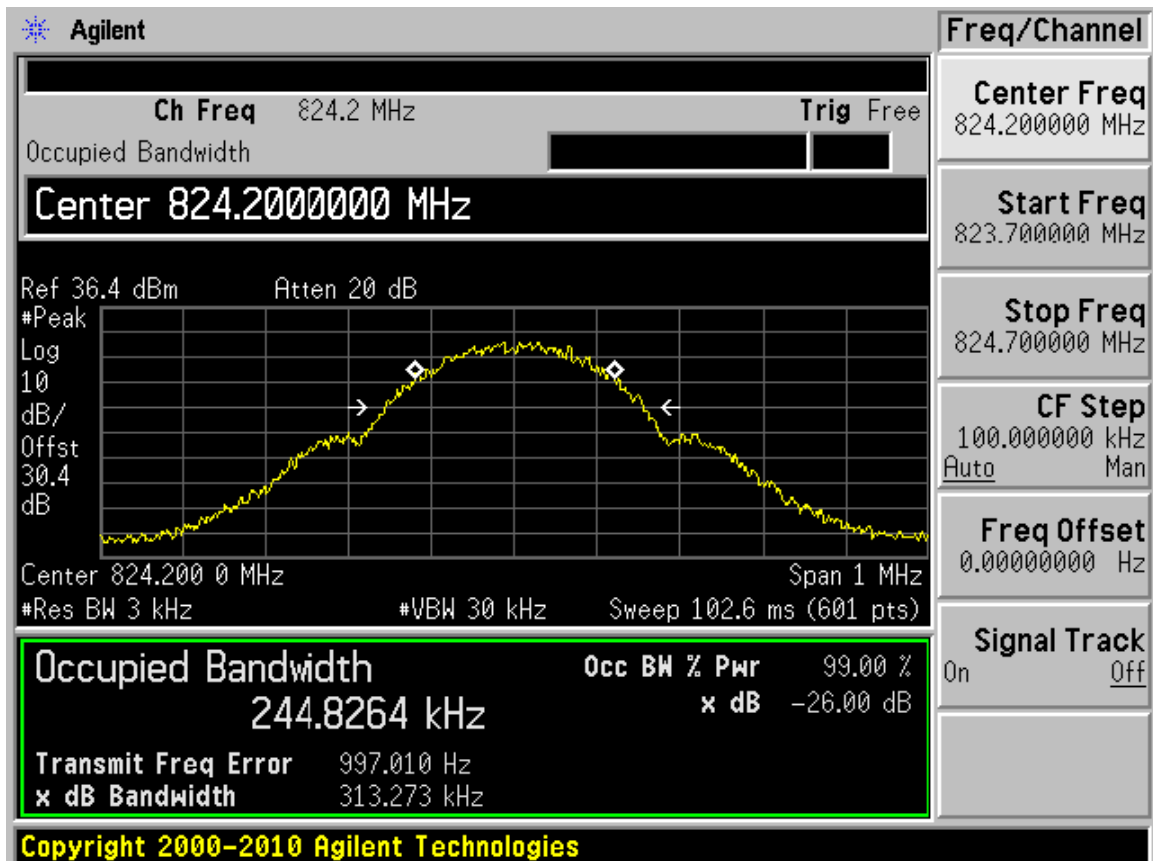

Uplink GSM 850 Middle CH Input Signal

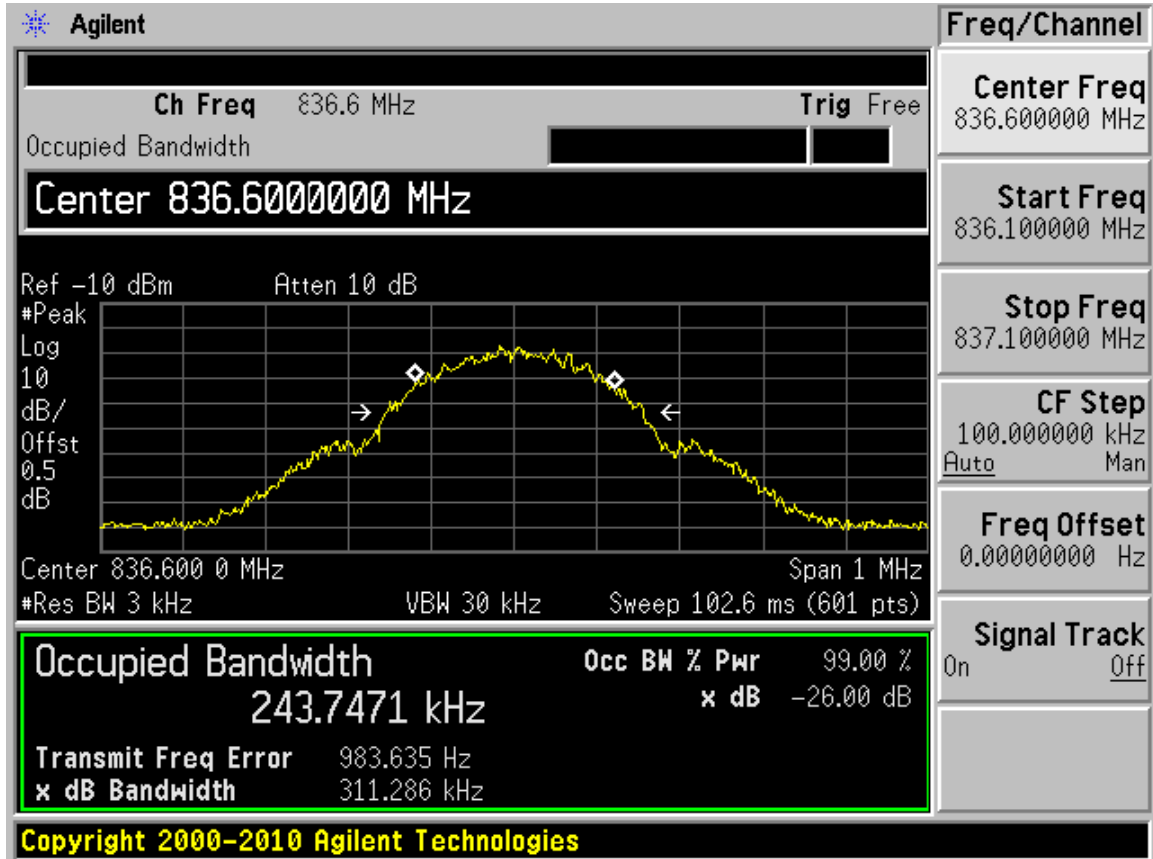

Uplink GSM 850 Middle CH Output Signal

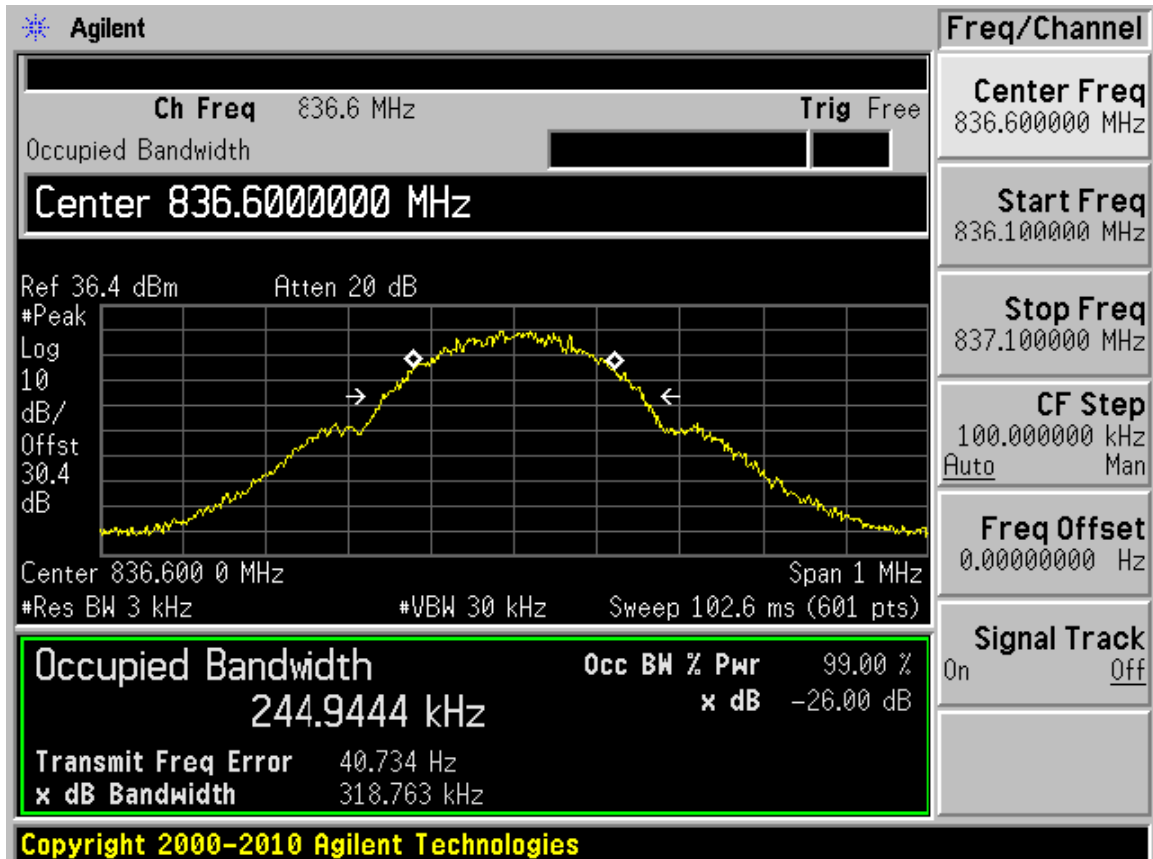

Uplink GSM 850 High CH Input Signal

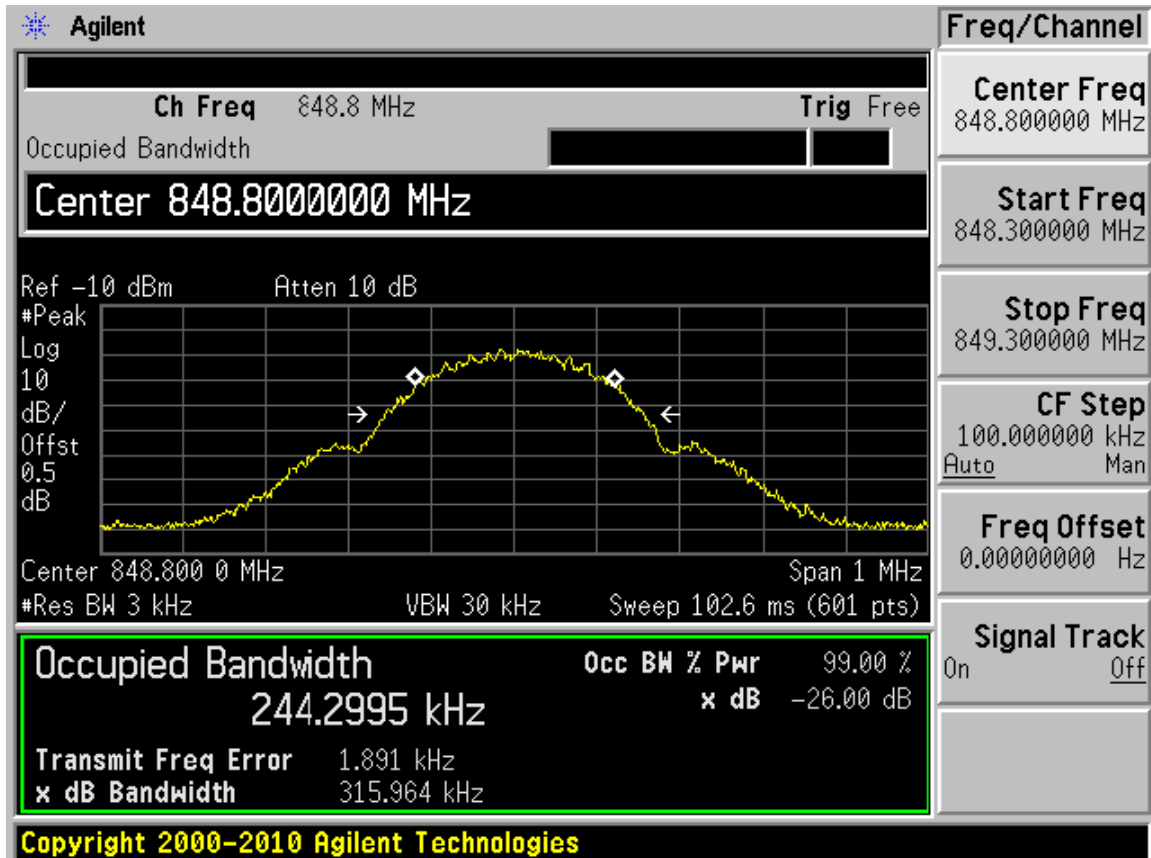

Uplink GSM 850 High CH Output Signal

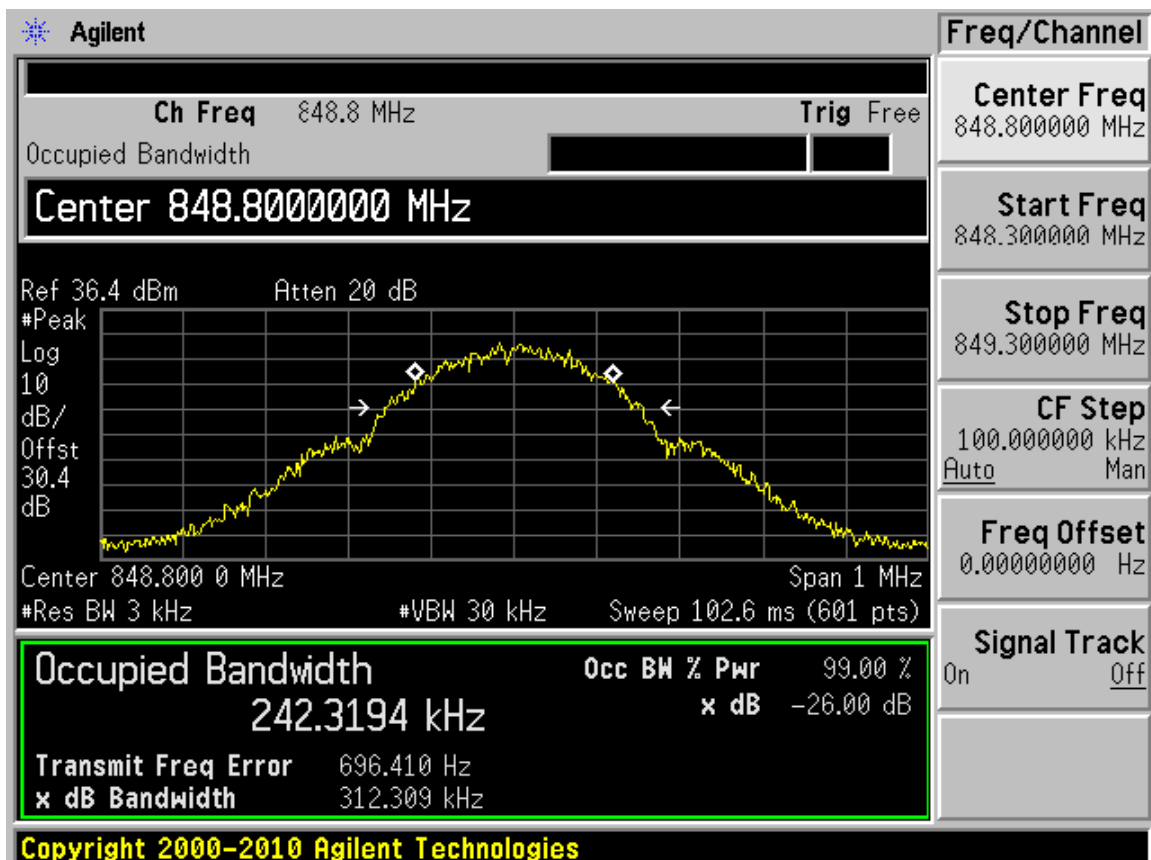

5.3. SPURIOUS AND HARMONIC EMISSION AT ANTENNA TERMINAL

5.3.1. Standard Applicable

§ 2.1051 Measurements required: Spurious emissions at antenna terminals:

The radio frequency voltage or powers generated within the equipment and appearing on a spurious frequency shall be checked at the equipment output terminals when properly loaded with a suitable artificial antenna. Curves or equivalent data shall show the magnitude of each harmonic and other spurious emission that can be detected when the equipment is operated under the conditions specified in § 2.1049 as appropriate. The magnitude of spurious emissions which are attenuated more than 20 dB below the permissible value need not be specified.

§ 22.917, § 24.238 Emission limitations for Broadband PCS equipment: The rules in this section govern the spectral characteristics of emissions in the Broadband Personal Communications Service. § 22.917 (a), § 24.238 (a) Out of band emissions. The power of any emission outside of the authorized operating frequency ranges must be attenuated below the transmitting power (P) by a factor of at least $43 + 10 \log(P)$ dB.

5.3.2. Measuring Instruments and Setting

Please refer to section 6 of equipments list in this report. The following table is the setting of the Spectrum Analyzer.

5.3.3. Test Procedures

A modulated carrier generated by the signal generator carrier was connected to either the Uplink or Downlink RF port at a maximum level as determined by the OEM A spectrum analyzer was connected to either the Uplink or Downlink port depending on the circuitry being measured. The spectrum was investigated from 30 MHz to the 26.5 GHz of the carrier.

5.3.4. Test Setup Layout

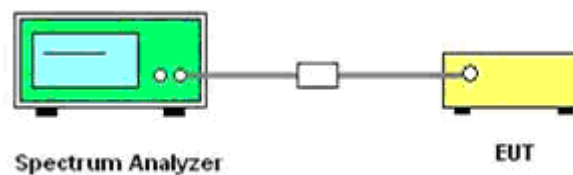

5.3.5. Test Results

The EUT complies with the requirements of this section. There were no detectable spurious emissions for this EUT.

Plots of Band Edge

(Downlink GSM 850 Low CH)

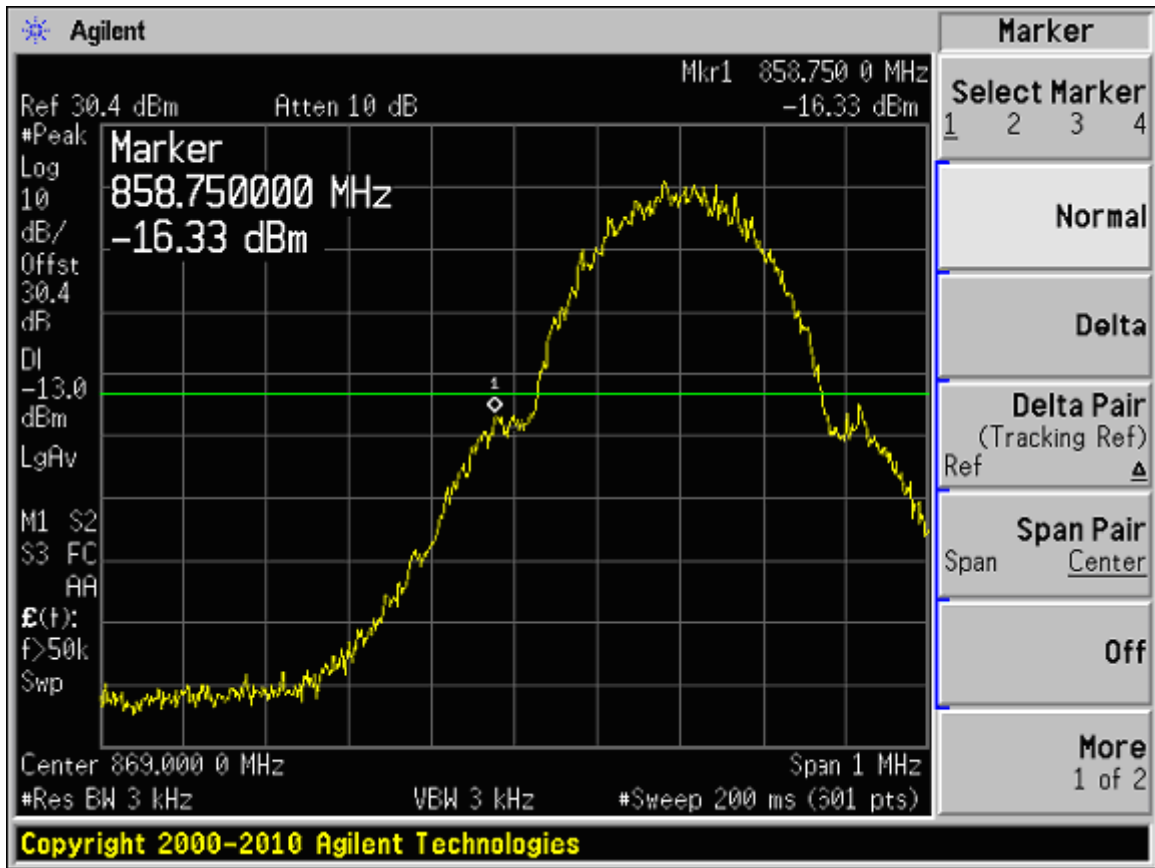

(Downlink GSM 850 High CH)

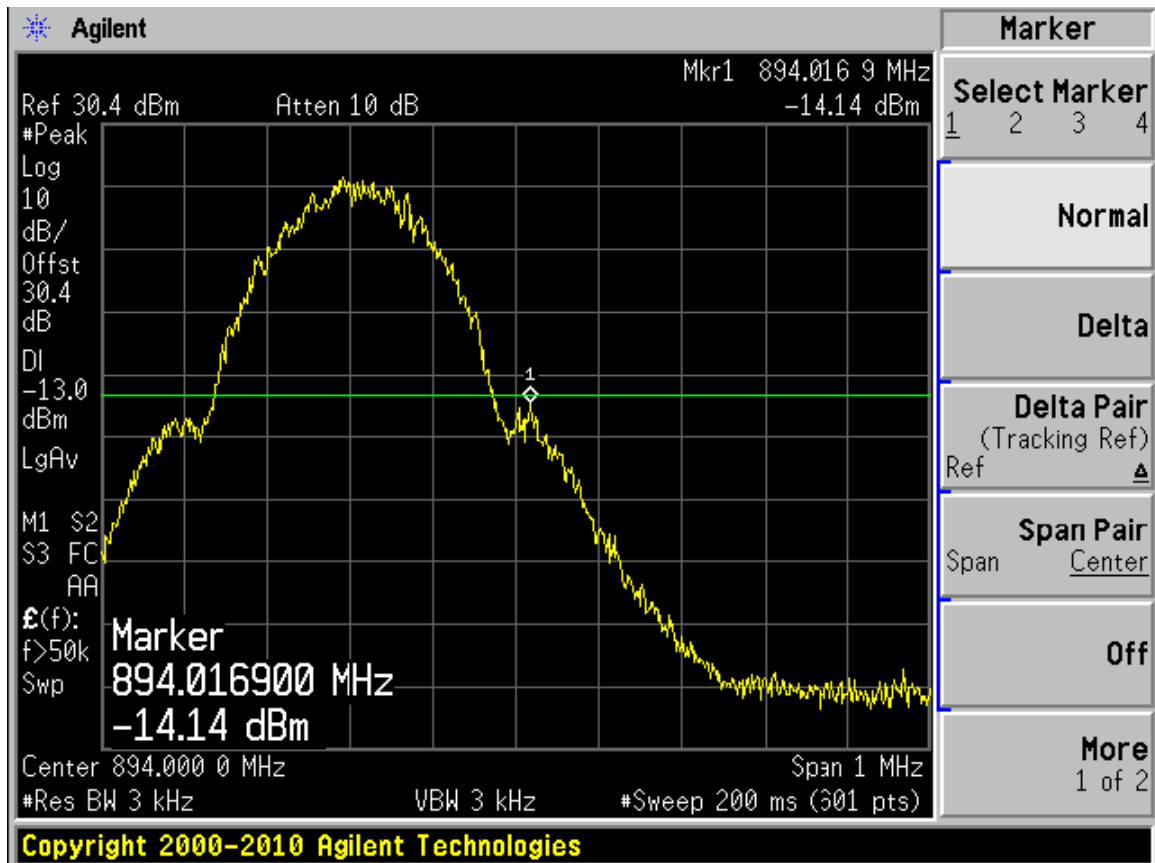

(Uplink GSM 850 Low CH)

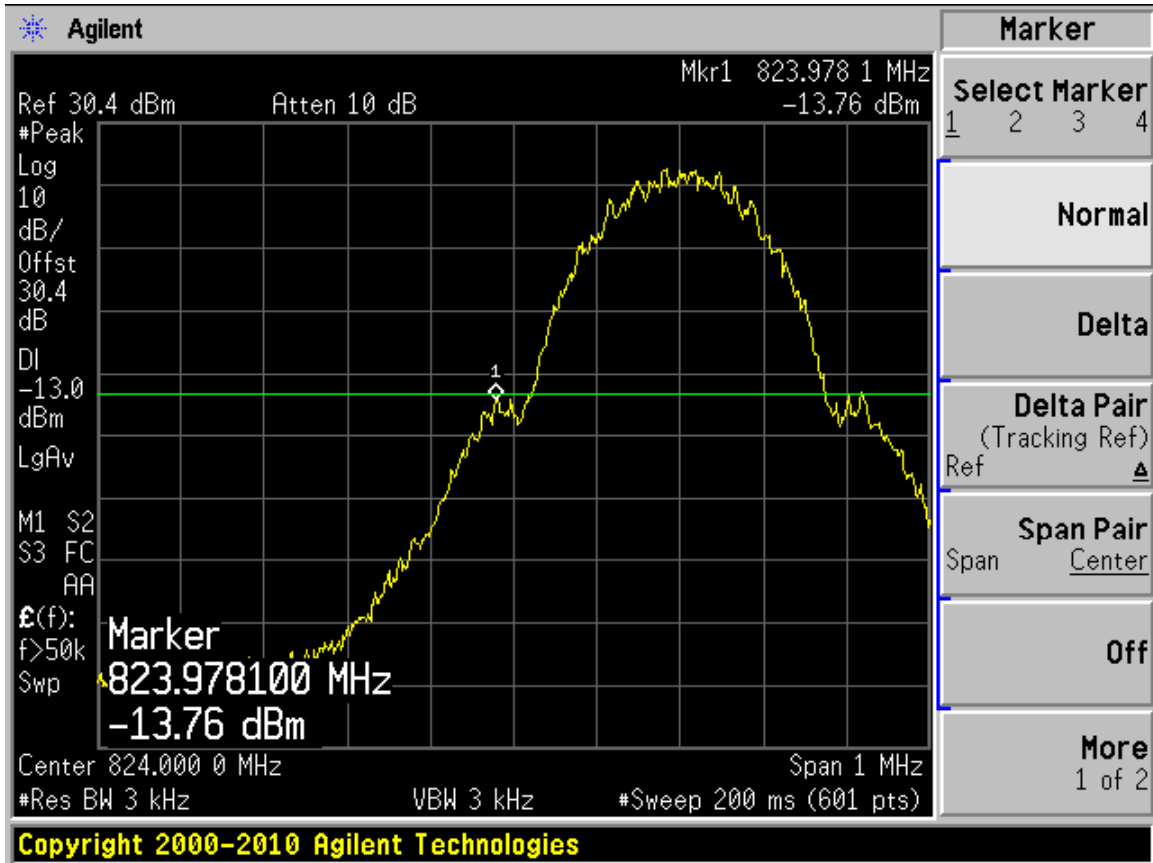

(Uplink GSM 850 High CH)

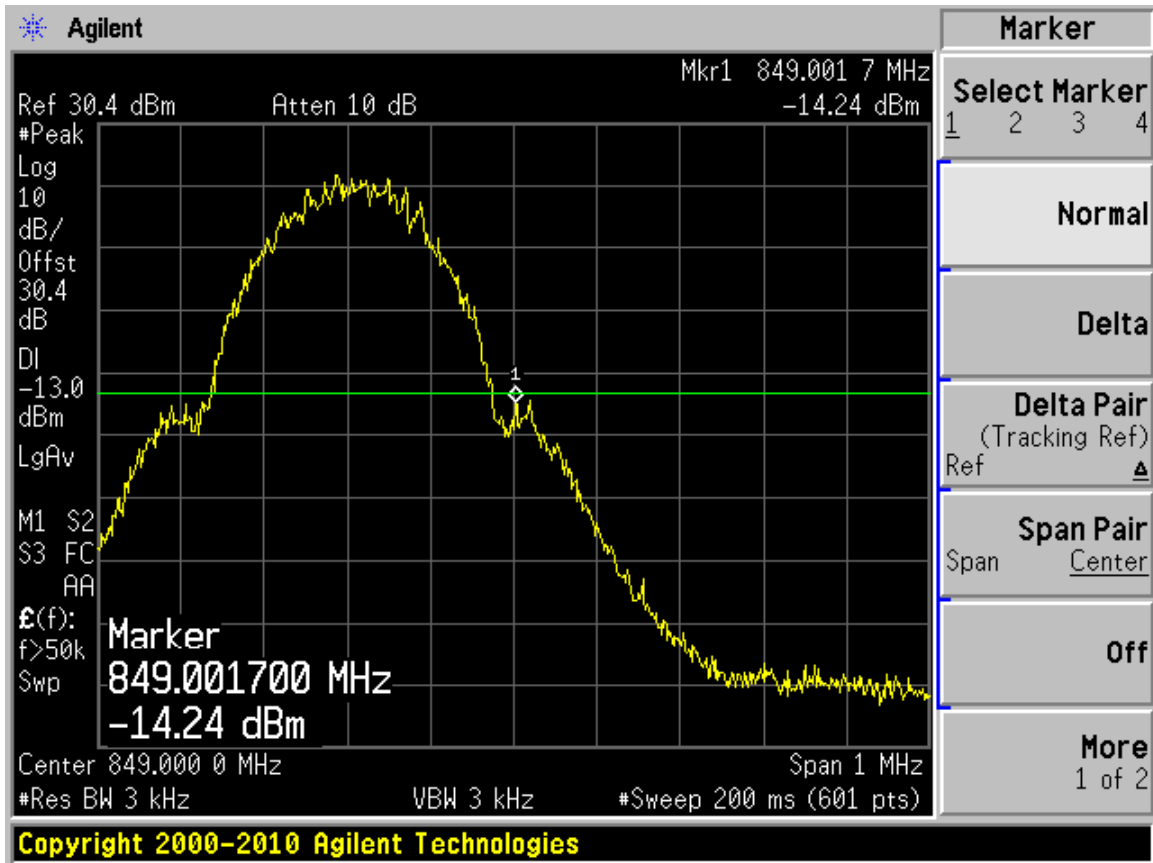

Plots of Spurious Emission

GSM 850 Conducted Spurious Emissions Downlink Low CH

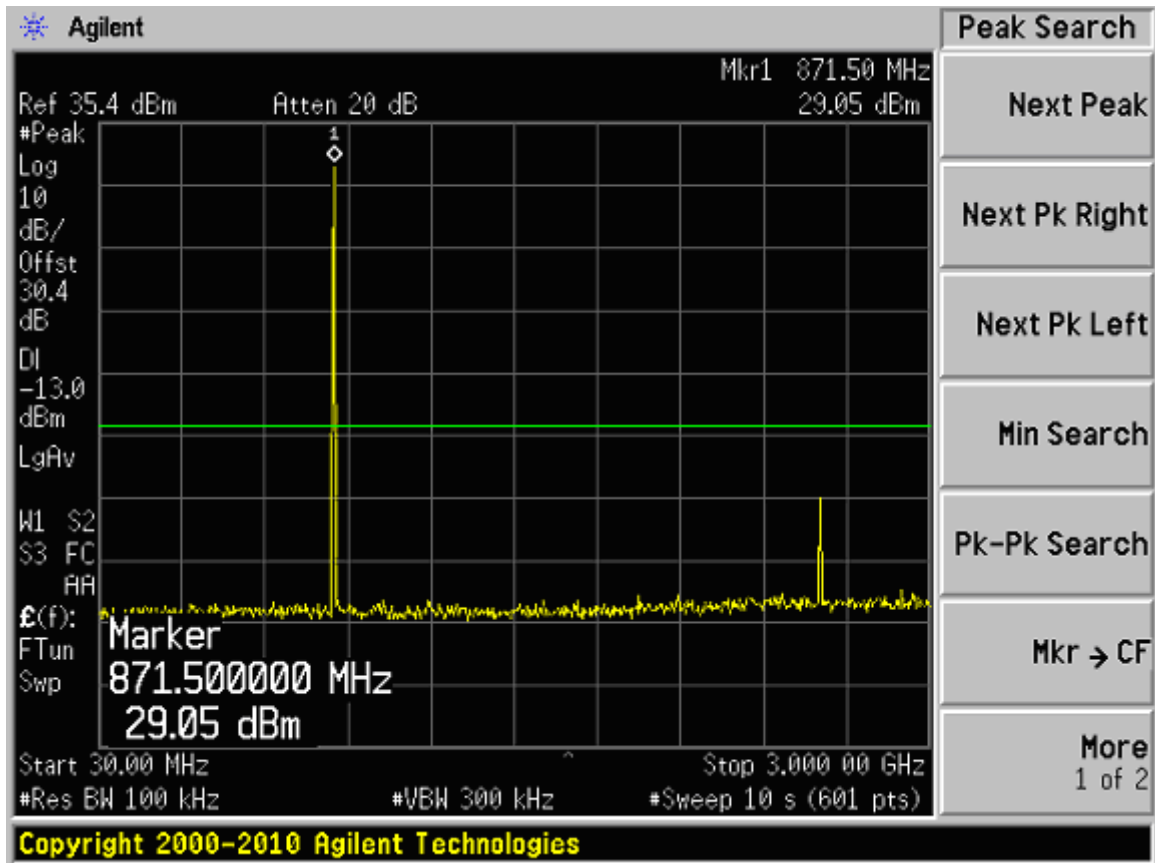

(30MHz – 3GHz)

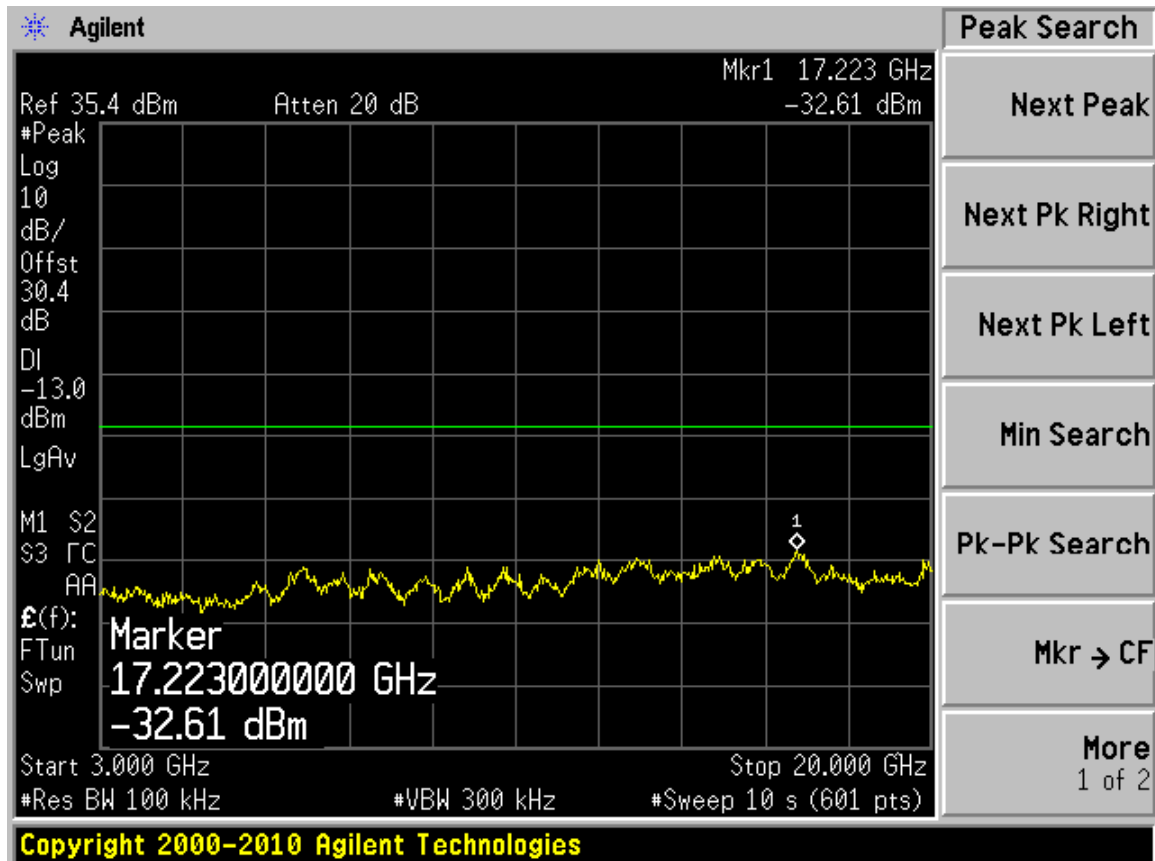

(3GHz – 20GHz)

GSM 850 Conducted Spurious Emissions Downlink Middle CH

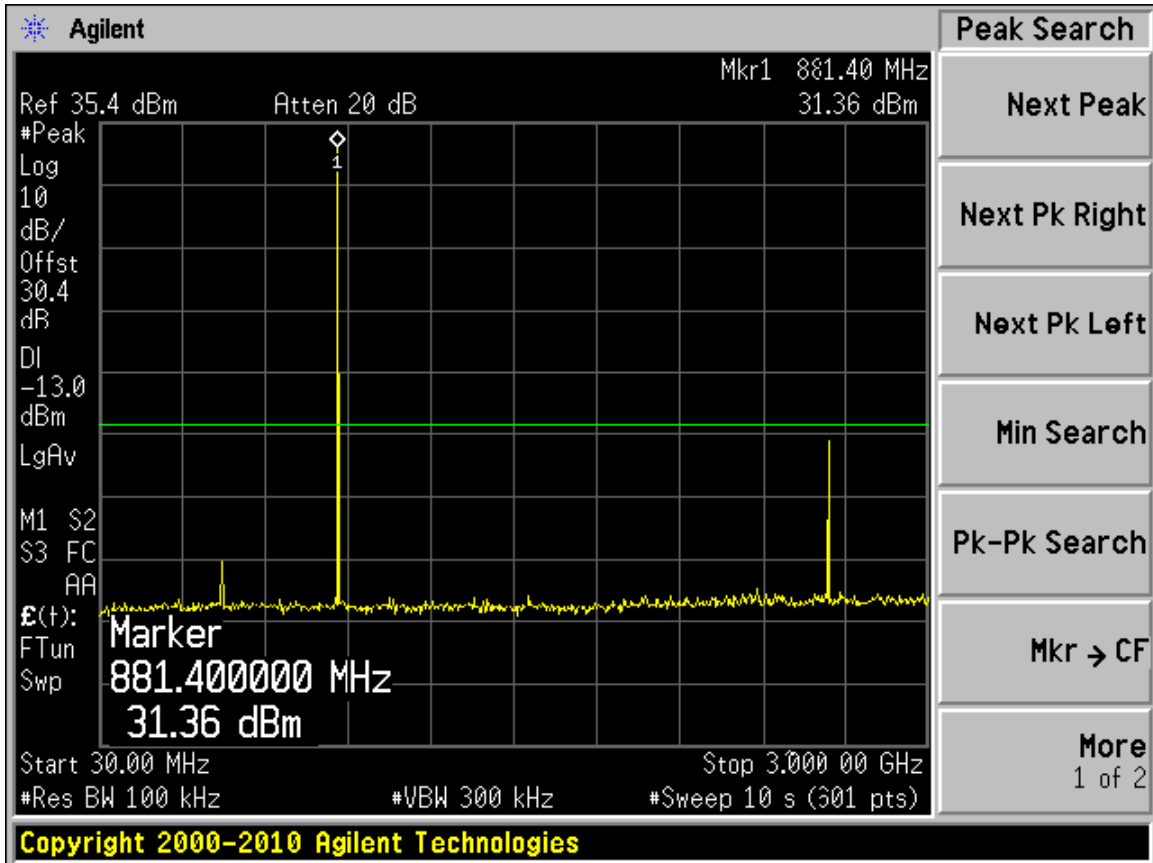

(30MHz – 3GHz)

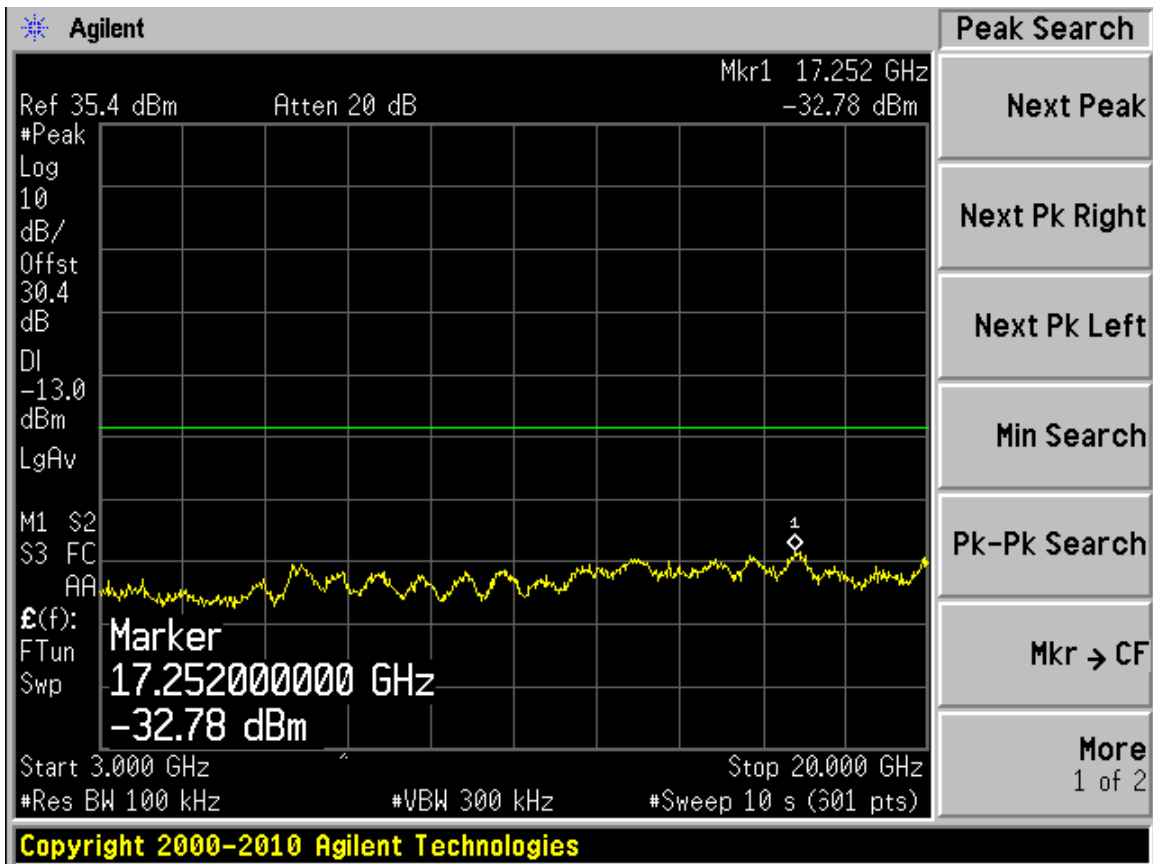

(3GHz – 20GHz)

GSM 850 Conducted Spurious Emissions Downlink High CH

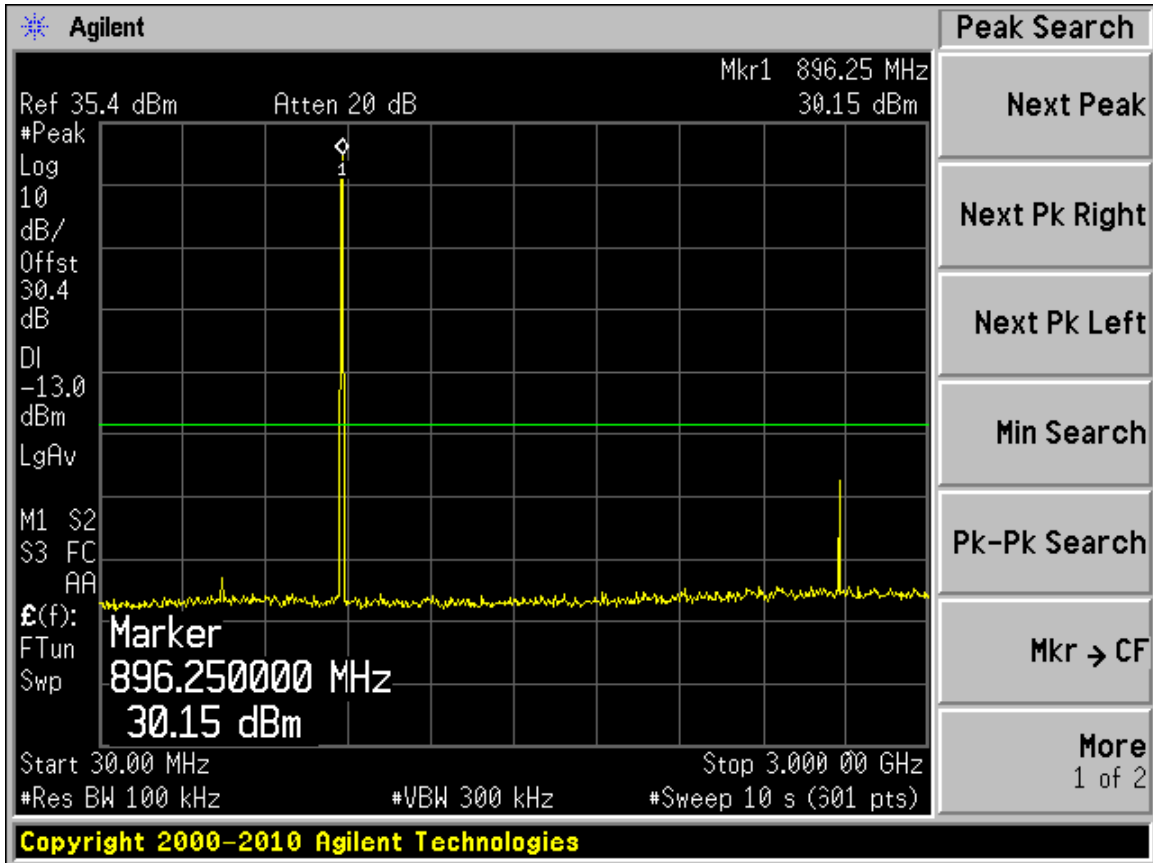

(30MHz – 3GHz)

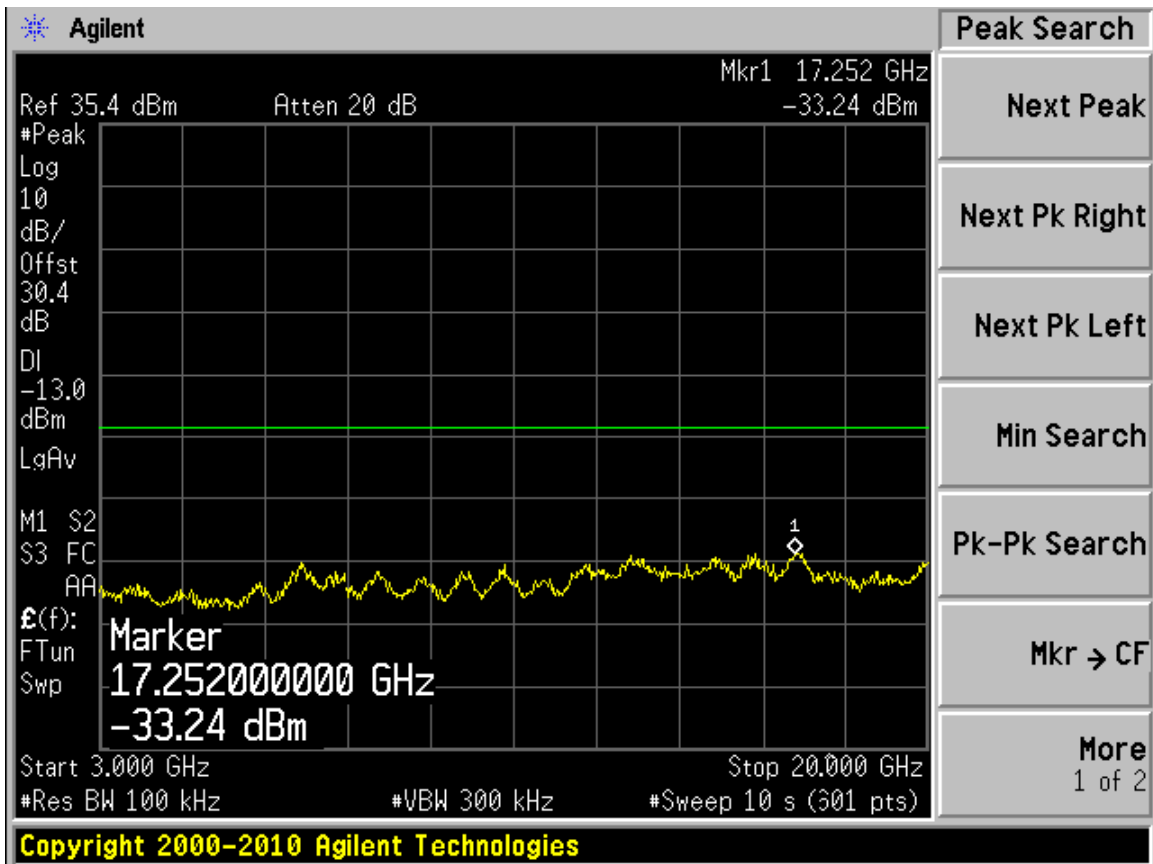

(3GHz – 20GHz)

GSM 850 Conducted Spurious Emissions Uplink Low CH

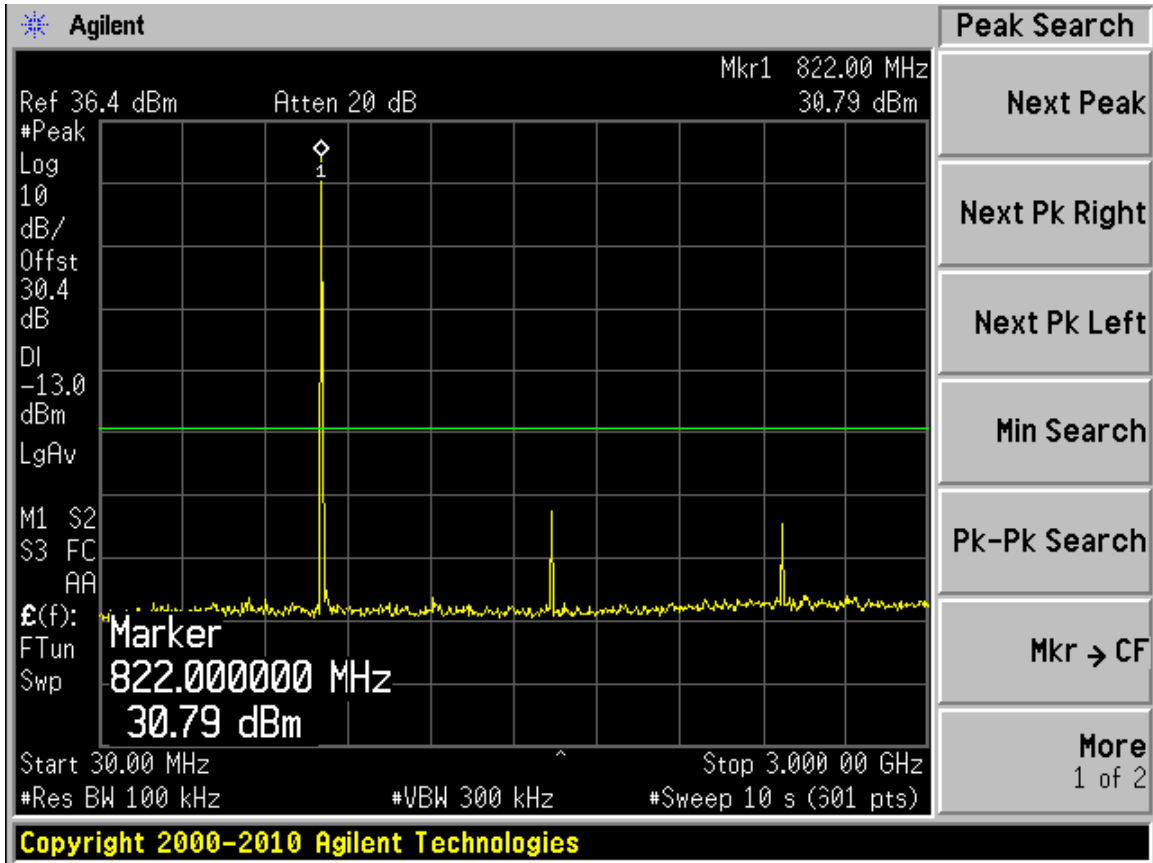

(30MHz – 3GHz)

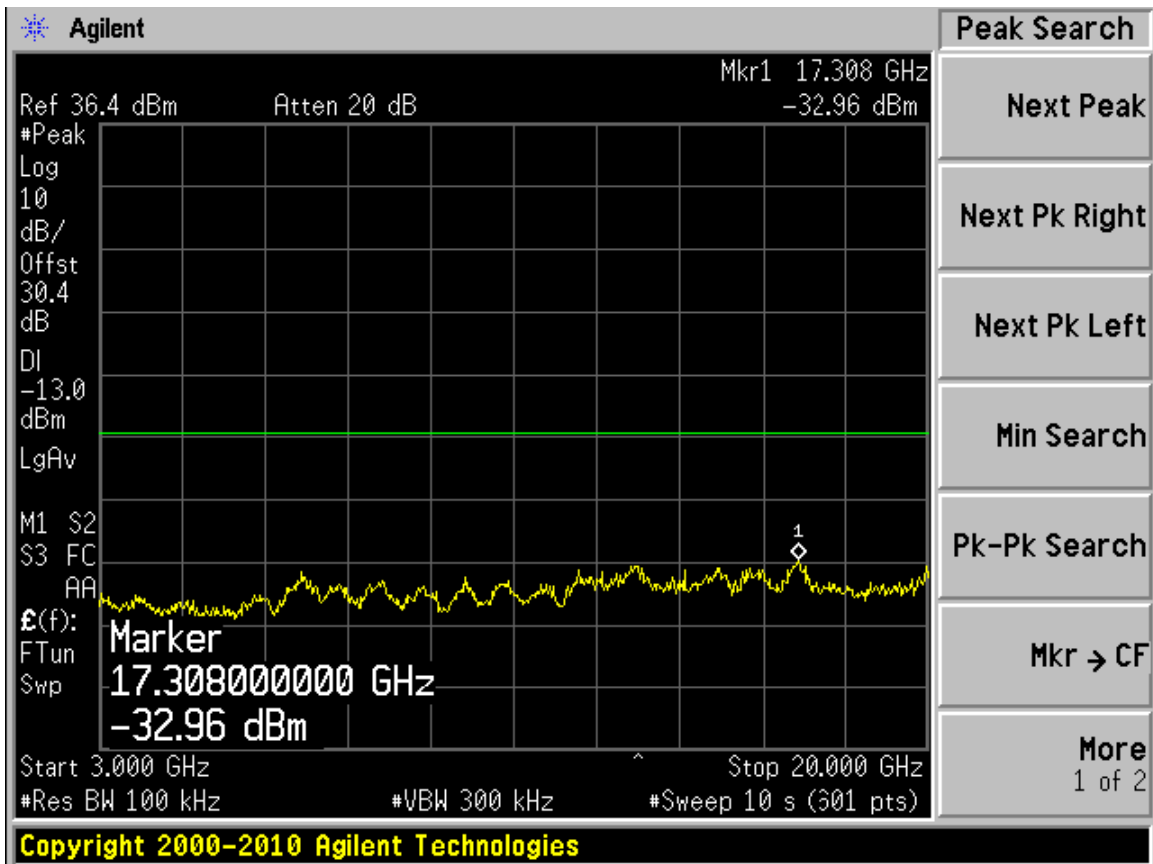

(3Hz – 20GHz)

GSM 850 Conducted Spurious Emissions Uplink Middle CH

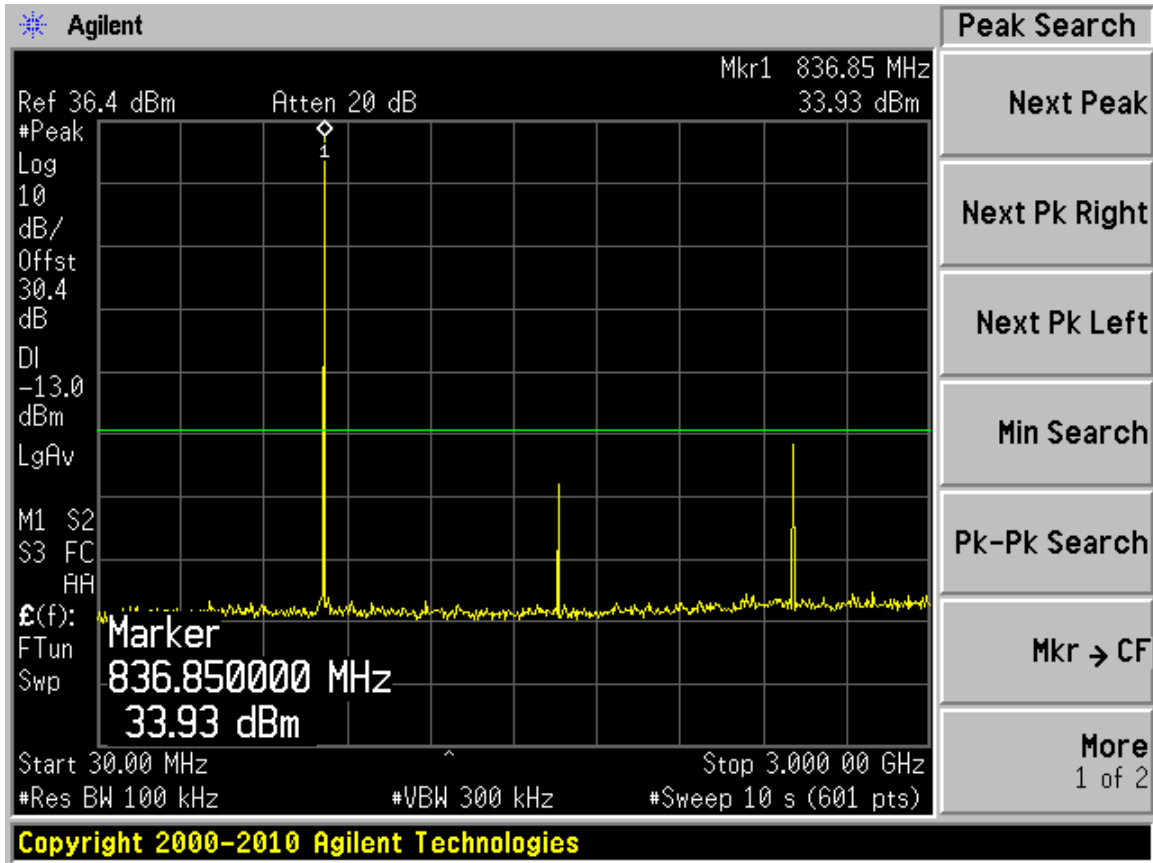

(30MHz – 3GHz)

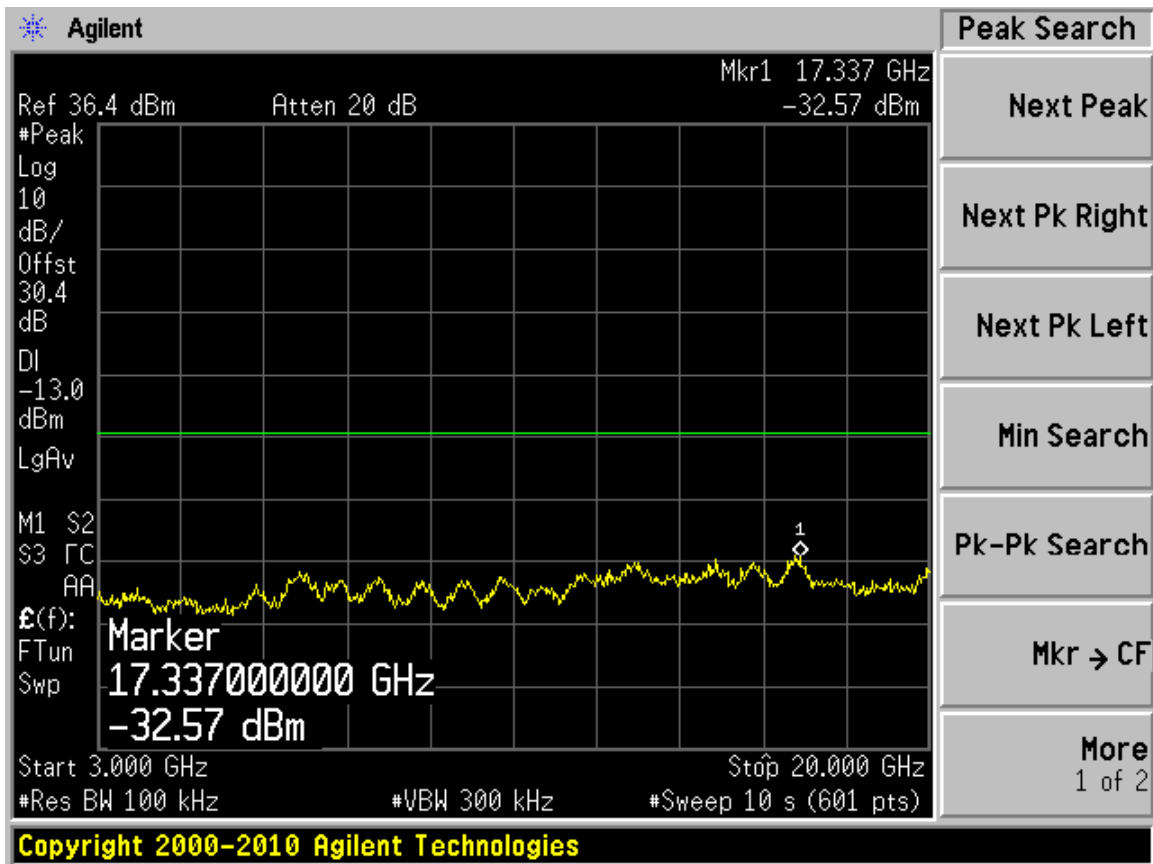

(3Hz – 20GHz)

GSM 850 Conducted Spurious Emissions Uplink High CH

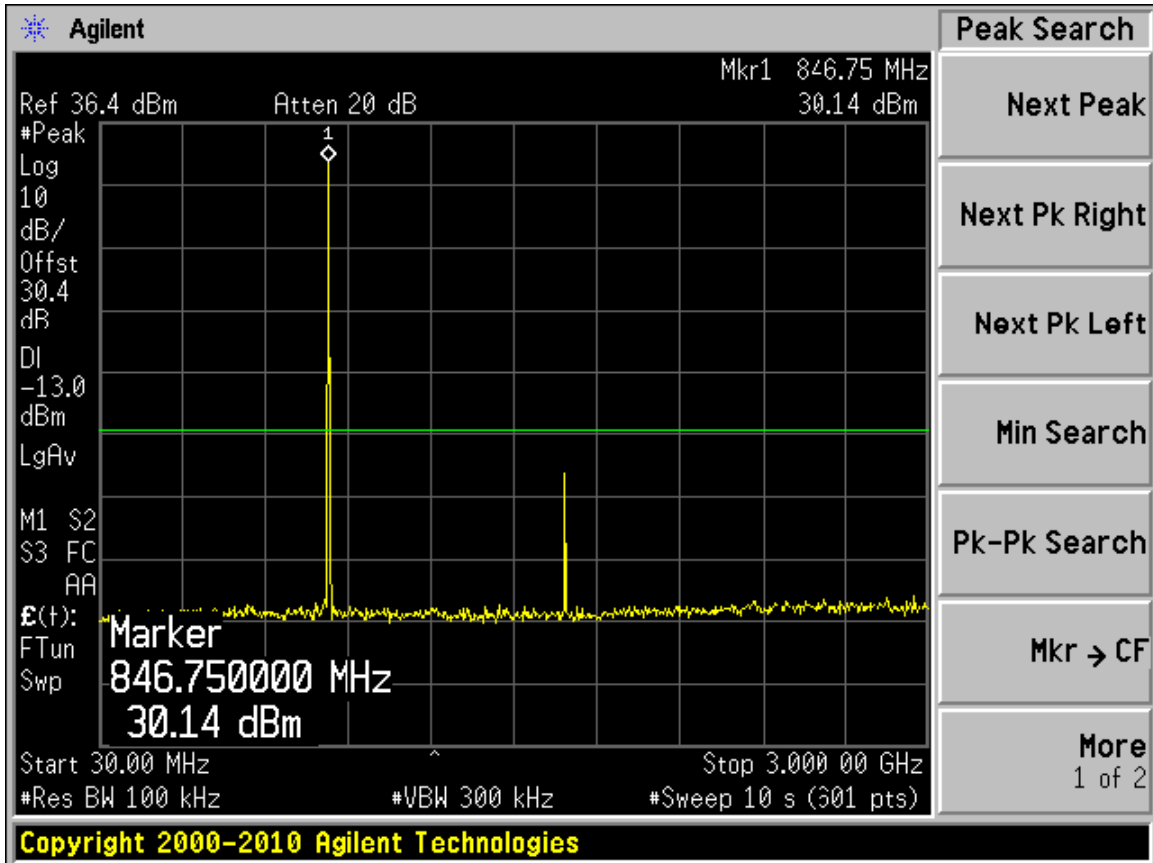

(30MHz – 3GHz)

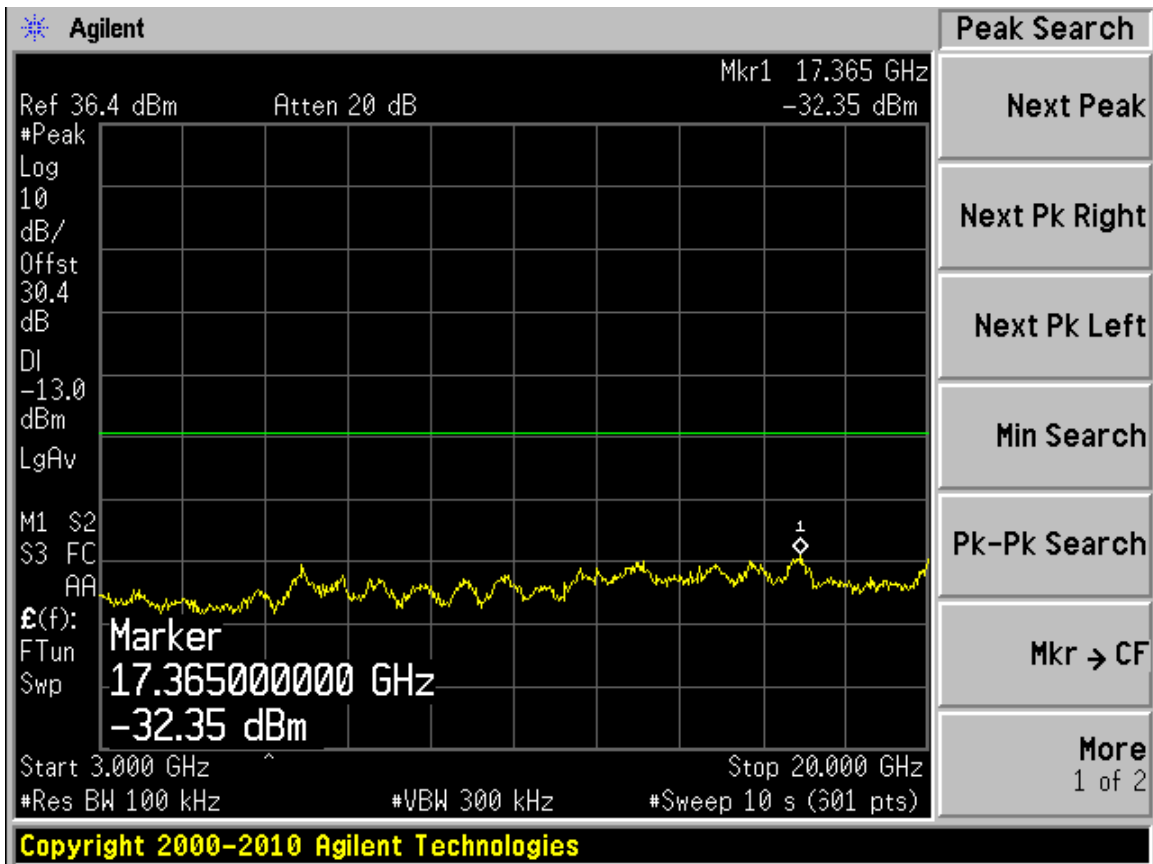

(3Hz – 20GHz)

Inter modulation Downlink GSM 850 Low CH

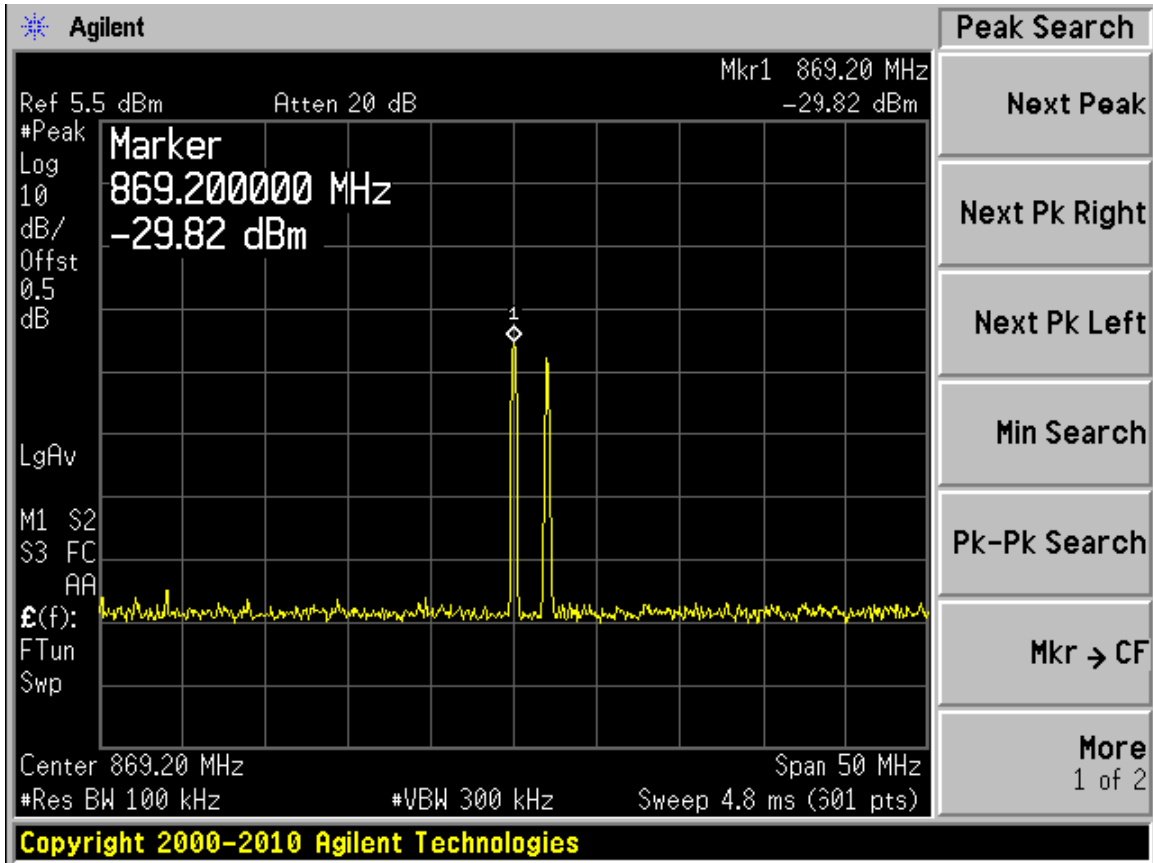

Input

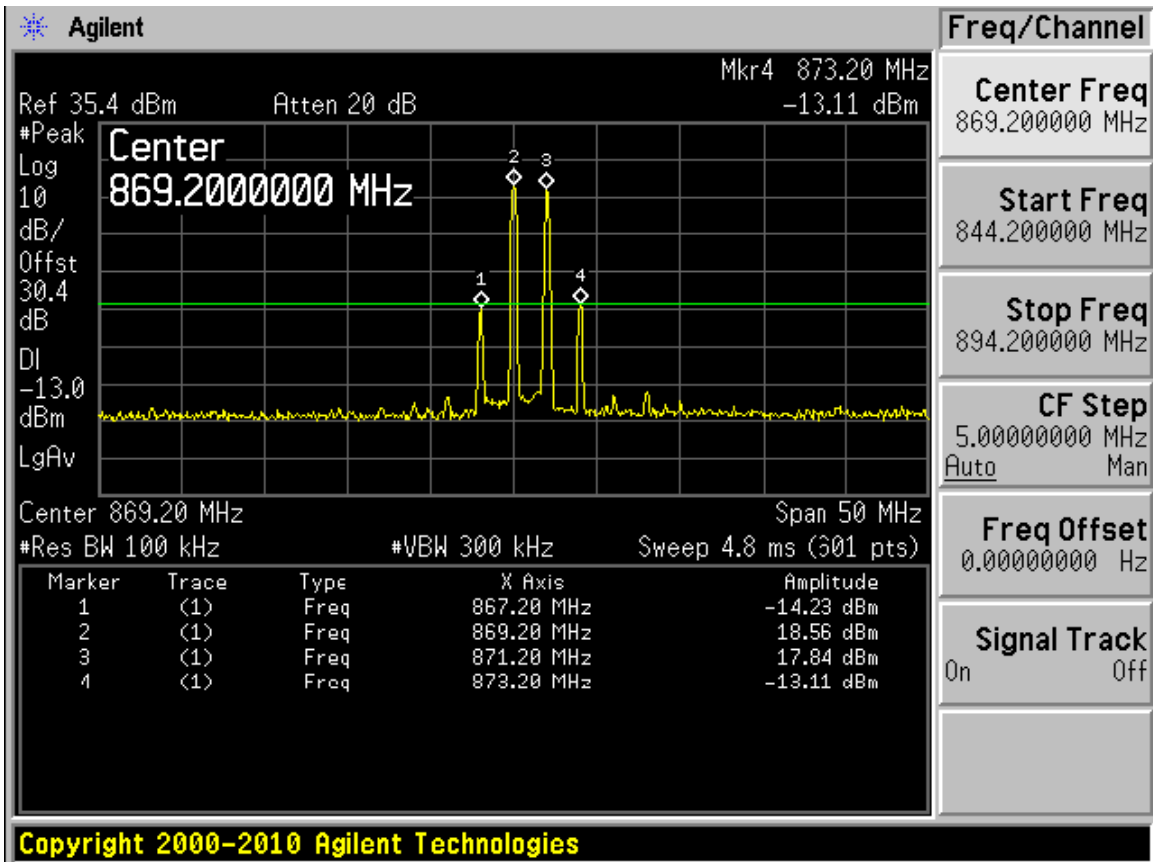

Output

Inter modulation Downlink GSM 850 High CH

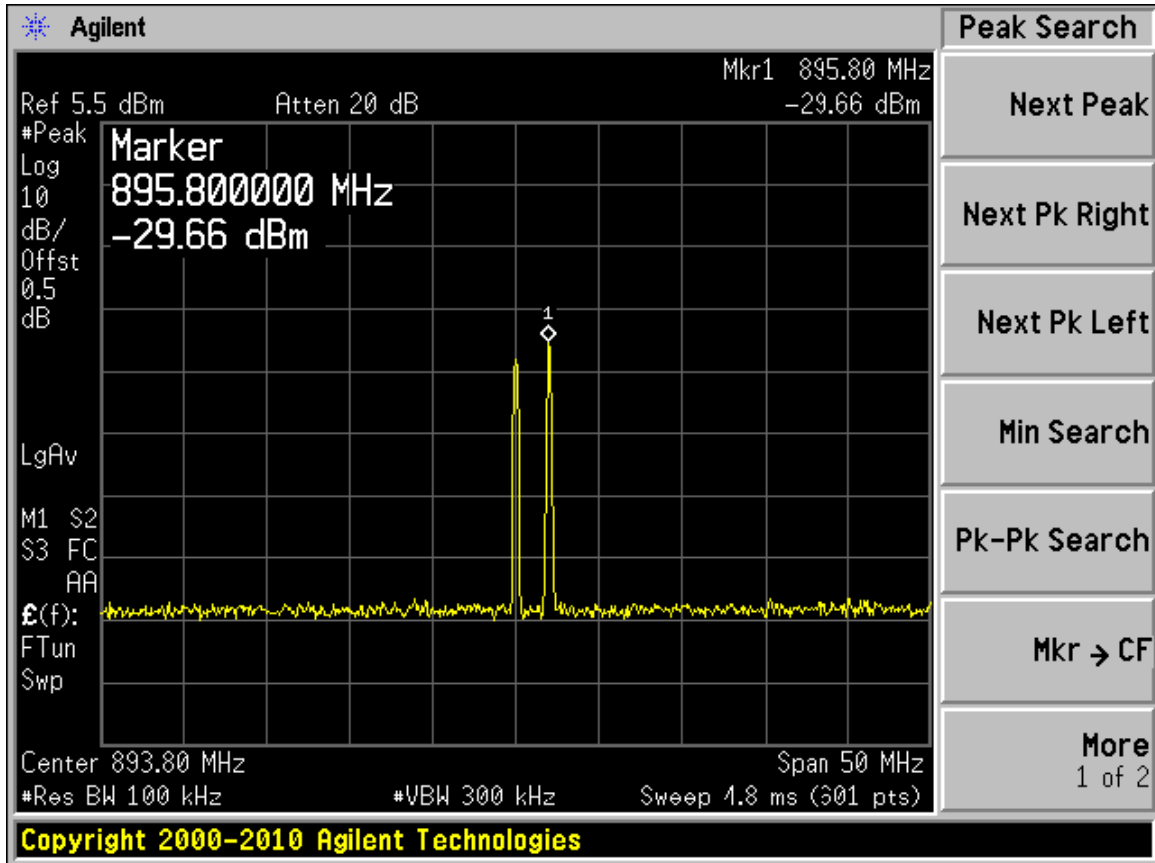

Input

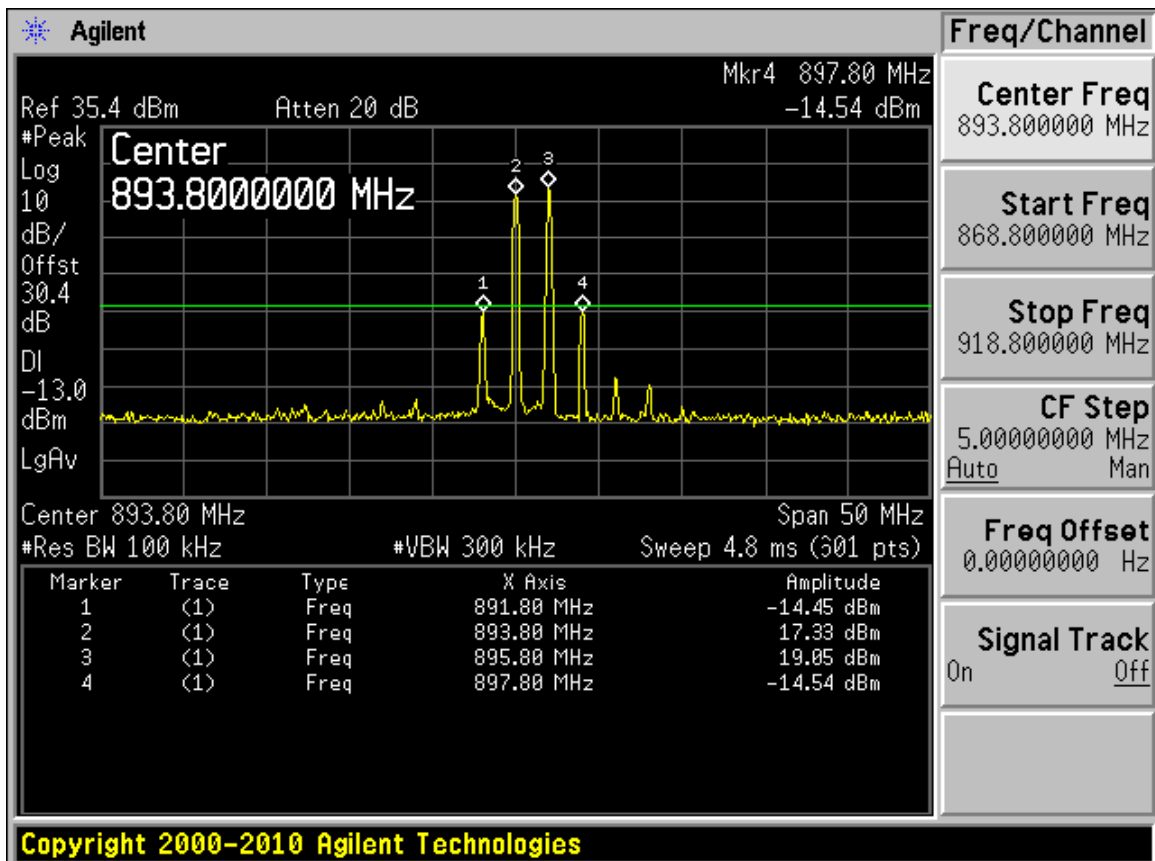

Output

Inter modulation Uplink GSM 850 Low CH

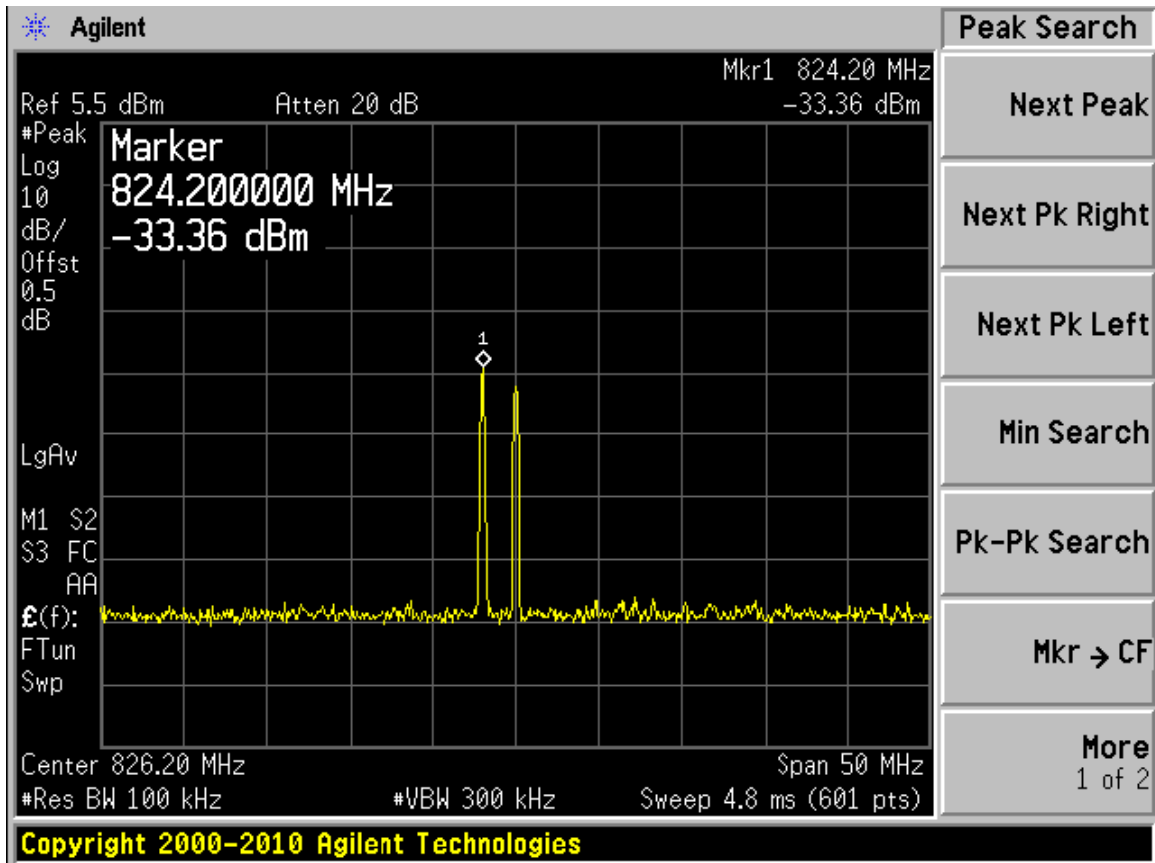

Input

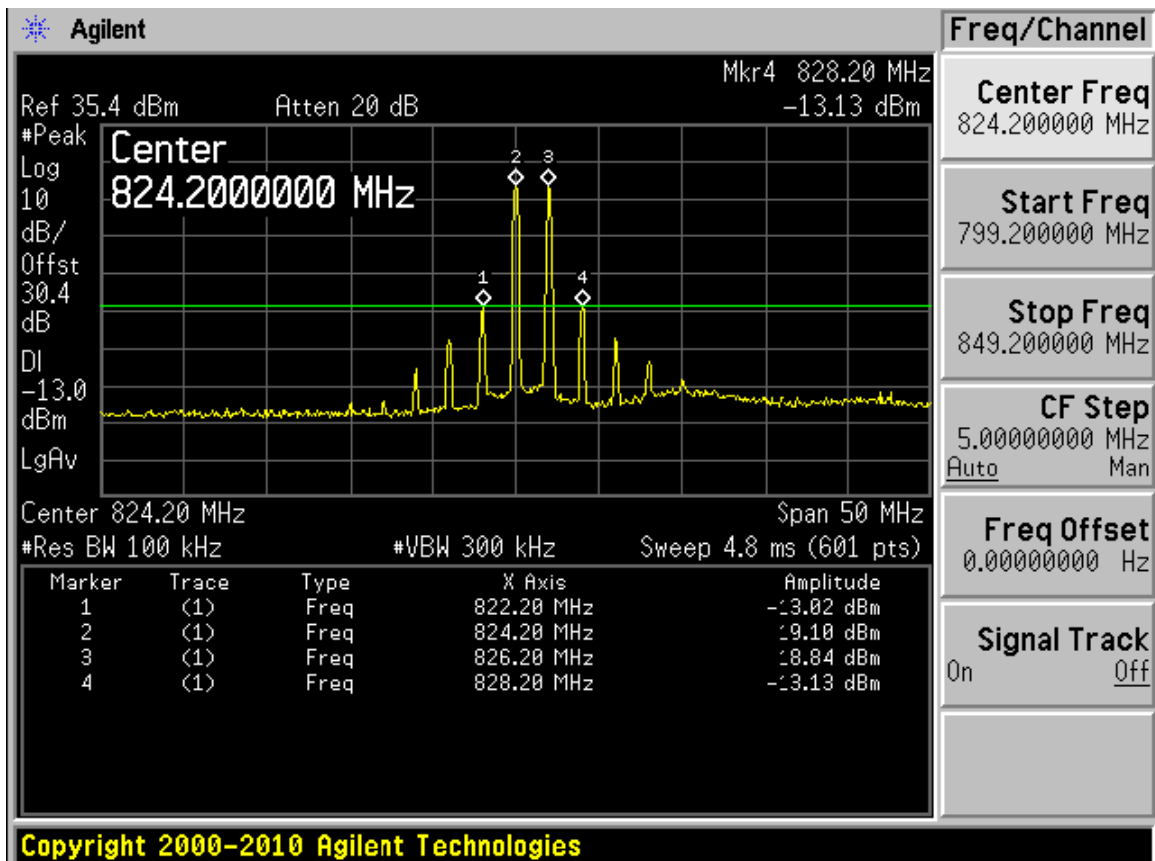

Output

Out of Band Rejection Uplink (GSM 850)

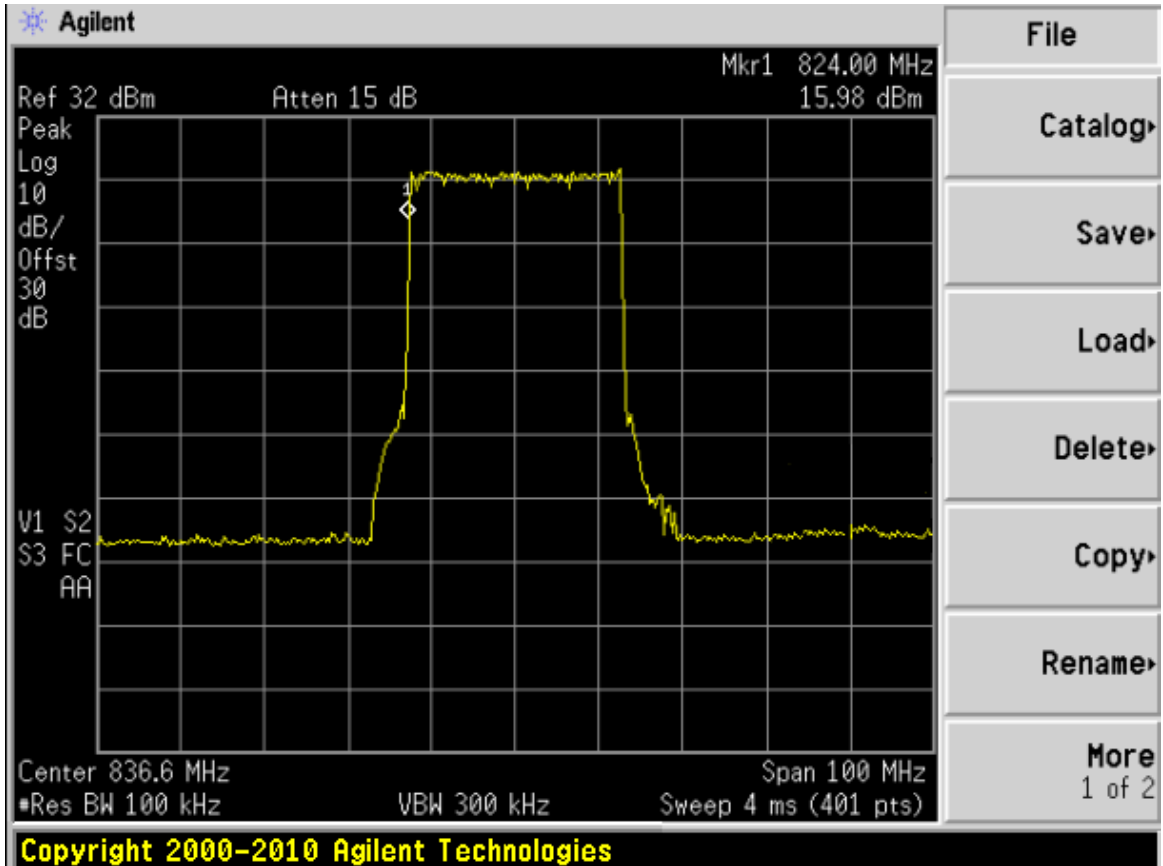

Out of Band Rejection Downlink (GSM 850)

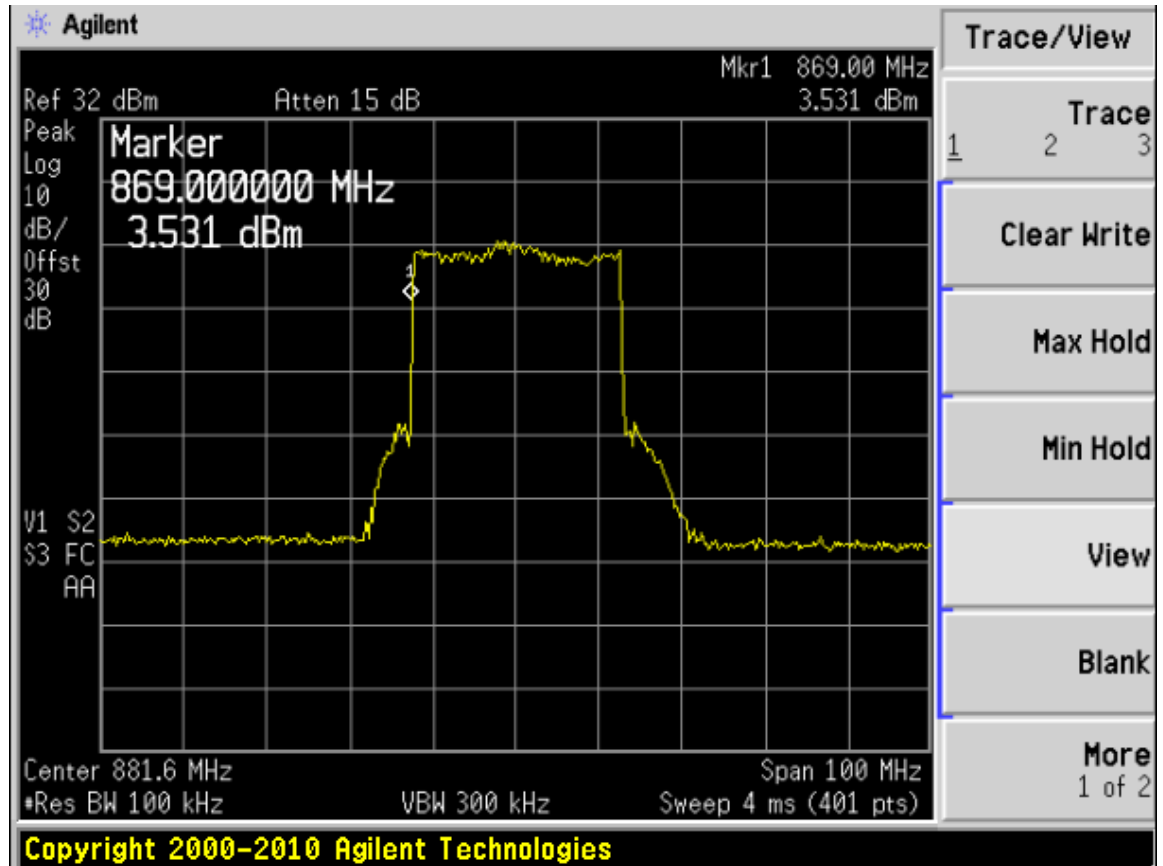

5.4. RADIATED EMISSIONS MEASUREMENT

5.4.1. Standard Applicable

§ 2.1053 Measurements required: Field strength of spurious radiation.

§ 2.1053 (a) Measurements shall be made to detect spurious emissions that may be radiated directly from the cabinet, control circuits, power leads, or intermediate circuit elements under normal conditions of installation and operation. Curves or equivalent data shall be supplied showing the magnitude of each harmonic and other spurious emission. For this test, single sideband, independent sideband, and controlled carrier transmitters shall be modulated under the conditions specified in paragraph (c) of § 2.1049, as appropriate. For equipment operating on frequencies below 890 MHz, an open field test is normally required with the measuring instrument antenna located in the far-field at all test frequencies. In the event it is either impractical or impossible to make open field measurements (e.g. a broadcast transmitter installed in a building) measurements will be accepted of the equipment as installed. Such measurements must be accompanied by a description of the site where the measurements were made showing the location of any possible source of reflections which might distort the field strength measurements. Information submitted shall include the relative radiated power of each spurious emission with reference to the rated power output of the transmitter, assuming all emissions are radiated from half-wave dipole antennas.

§ 2.1053 (b): The measurements specified in paragraph (a) of this section shall be made for the following equipment:

- (1) Those in which the spurious emissions are required to be 60 dB or more below the mean power of the transmitter.
- (2) All equipment operating on frequencies higher than 25 MHz.
- (3) All equipment where the antenna is an integral part of, and attached directly to the transmitter.
- (4) Other types of equipment as required, when deemed necessary by the Commission.

5.4.2. Measuring Instruments and Setting

Please refer to section 6 of equipments list in this report.

5.4.3. Test Procedures

As required by 47 CFR 2.1053, field strength of radiated spurious measurements were made in accordance with the procedures of TIA/EIA-603-C-2004 "Land Mobile FM or PM Communications Equipment Measurement and Performance Standards". Radiated emission measurements were performed inside a 3 meter semi-anechoic chamber. The EUT was set at a distance of 3m from the receiving antenna. The EUT's RF ports were terminated to 50ohm load. The EUT was set to transmit at the low, mid and high channels of the transmitter frequency range at its maximum power level. The EUT was rotated about 360 and the receiving antenna scanned from 1-3m in order to capture the maximum emission. A calibrated antenna source was positioned in place of the EUT and the previously recorded signal was duplicated. The maximum EIRP of the emission was calculated by adding the forward power to the calibrated source plus its appropriate gain value. These steps were carried out with the receiving antenna in both vertical and horizontal polarization. Harmonic emissions up to the 10th or 40GHz, whichever was the lesser, were investigated.

5.4.4. Test Setup Layout

For radiated emissions below 30MHz

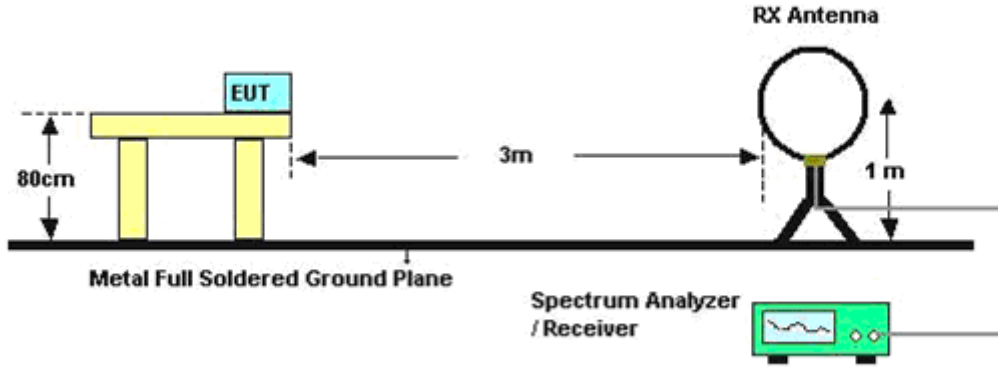

For radiated emissions above 30MHz

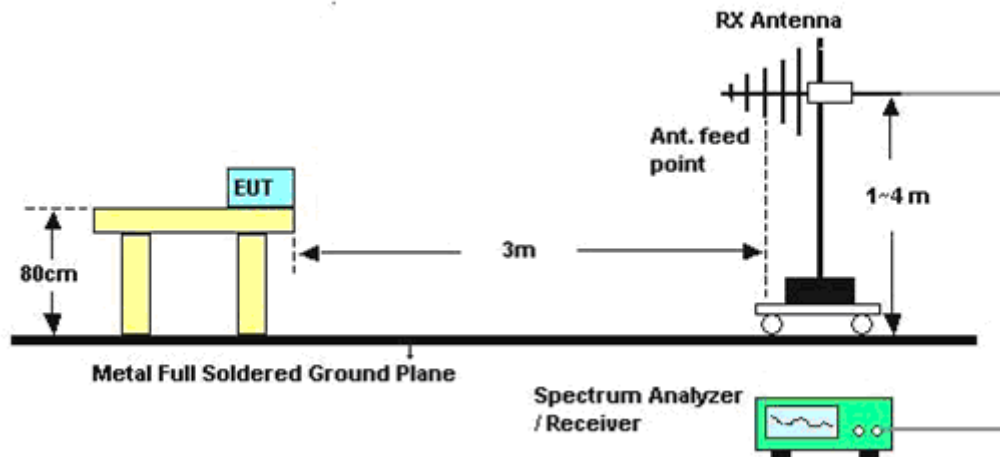

5.4.5. Test Results

Indicated		Table	Test Antenna		Substituted		Antenna Gain Correction	Cable Loss dB	Absolute Level dBm	Limit dBm	Margin dB
Frequency MHz	Reading dBuV/m		Angle Degree	Height Meter	Polar H/V	Frequency MHz					
850 MHz, Downlink, Input frequency = 881.6 MHz											
1673.2	50.27	60	1.1	V	1673.2	-52.41	9.4	1.3	-44.31	-13	-31.31
1673.2	53.98	0	1.5	H	1673.2	-48.70	9.4	1.3	-40.60	-13	-27.60
2509.8	45.33	60	1.1	V	2509.8	-50.56	9.5	1.66	-42.72	-13	-29.72
2509.8	37.13	0	1.5	H	2509.8	-58.76	9.5	1.66	-50.92	-13	-37.92
850 MHz, Uplink, Input frequency = 836.6 MHz											
1763.2	56.80	90	1.1	V	1763.2	-44.64	9.6	1.3	-36.34	-13	-23.34
1763.2	59.53	90	1.1	H	1763.2	-41.91	9.6	1.3	-33.61	-13	-20.61
3526.4	51.48	2.0	2.0	V	3526.4	-42.37	10.0	1.68	-34.05	-13	-21.05
3526.4	54.44	170	1.7	H	3526.4	-39.41	10.0	1.68	-31.09	-13	-18.09

5.5. POWER LINE CONDUCTED EMISSIONS

5.5.1 Standard Applicable

According to §15.107 (a): For an intentional radiator which is designed to be connected to the public utility (AC) power line, the radio frequency voltage that is conducted back onto the AC power line on any frequency or frequencies within the band 150 kHz to 30 MHz shall not exceed 250 microvolt (The limit decreases linearly with the logarithm of the frequency in the range 0.15 MHz to 0.50 MHz). The limits at specific frequency range is listed as follows:

Frequency Range (MHz)	Limits (dB μ V)	
	Quasi-peak	Average
0.15 to 0.50	66 to 56	56 to 46
0.50 to 5	56	46
5 to 30	60	50

5.5.2 Block Diagram of Test Setup

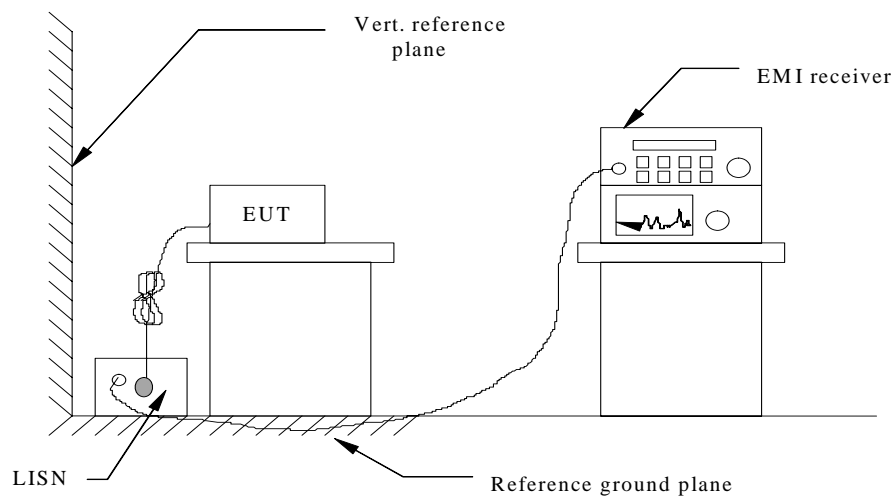

5.5.3 Test Results

PASS.

The test data please refer to following page.

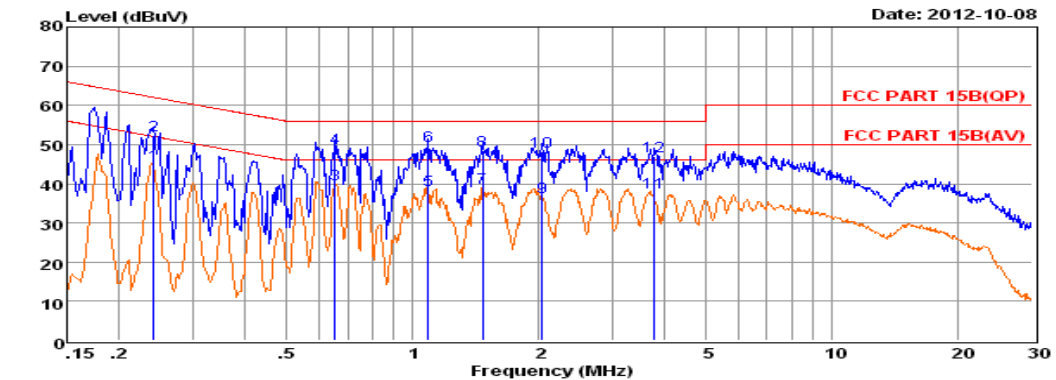

Env. Ins: 24*/56%
 EUT: Cell phone signal booster
 M/N: PTE-C70
 Power Rating: DC 6V From Adapter Input AC 120V/60Hz
 Test Mode: On
 Operator: FOX
 Memo:
 Pol: NEUTRAL

	Freq	Reading	LisnFac	CabLos	Measured	Limit	Over	Remark
	MHz	dBuV	dB	dB	dBuV	dBuV	dB	
1	0.24	35.14	9.60	0.03	44.77	52.04	-7.27	Average
2	0.24	42.65	9.60	0.03	52.28	62.04	-9.76	QP
3	0.65	30.18	9.63	0.04	39.85	46.00	-6.15	Average
4	0.65	39.46	9.63	0.04	49.13	56.00	-6.87	QP
5	1.09	28.71	9.63	0.05	38.39	46.00	-7.61	Average
6	1.09	39.89	9.63	0.05	49.57	56.00	-6.43	QP
7	1.47	29.29	9.63	0.05	38.97	46.00	-7.03	Average
8	1.47	38.89	9.63	0.05	48.57	56.00	-7.43	QP
9	2.03	26.90	9.63	0.05	36.58	46.00	-9.42	Average
10	2.03	38.59	9.63	0.05	48.27	56.00	-7.73	QP
11	3.76	28.13	9.65	0.06	37.84	46.00	-8.16	Average
12	3.76	37.34	9.65	0.06	47.05	56.00	-8.95	QP

Remarks: 1. Measured = Reading + Lisn Factor +Cable Loss.
 2. The emission levels that are 20dB below the official limit are not reported.

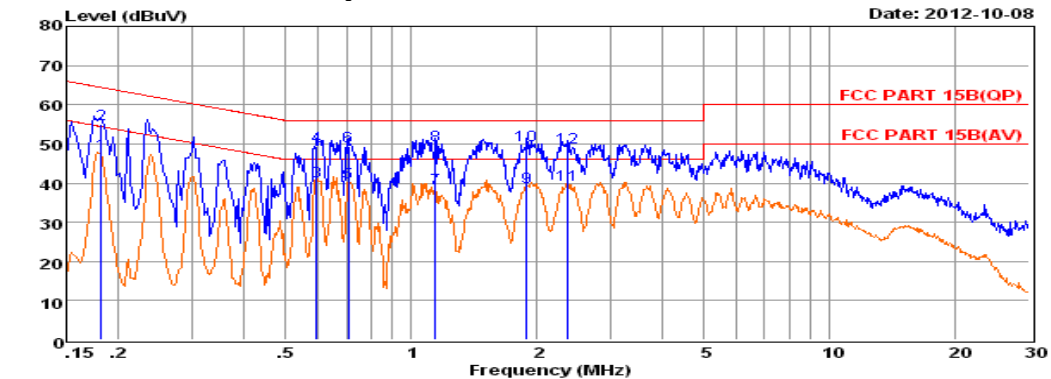

Env. Ins: 24*/56%
 EUT: Cell phone signal booster
 M/N: PTE-C70
 Power Rating: DC 6V From Adapter Input AC 120V/60Hz
 Test Mode: On
 Operator: FOX
 Memo:
 Pol: LINE

	Freq	Reading	LisnFac	CabLos	Measured	Limit	Over	Remark
	MHz	dBuV	dB	dB	dBuV	dBuV	dB	
1	0.18	38.00	9.61	0.02	47.63	54.42	-6.79	Average
2	0.18	45.31	9.61	0.02	54.94	64.42	-9.48	QP
3	0.59	30.72	9.63	0.04	40.39	46.00	-5.61	Average
4	0.59	39.68	9.63	0.04	49.35	56.00	-6.65	QP
5	0.71	30.47	9.64	0.04	40.15	46.00	-5.85	Average
6	0.71	39.79	9.64	0.04	49.47	56.00	-6.53	QP
7	1.14	29.07	9.63	0.05	38.75	46.00	-7.25	Average
8	1.14	39.91	9.63	0.05	49.59	56.00	-6.41	QP
9	1.89	29.37	9.64	0.05	39.06	46.00	-6.94	Average
10	1.89	39.89	9.64	0.05	49.58	56.00	-6.42	QP
11	2.37	29.76	9.64	0.05	39.45	46.00	-6.55	Average
12	2.37	39.24	9.64	0.05	48.93	56.00	-7.07	QP

Remarks: 1. Measured = Reading + Lisn Factor +Cable Loss.
 2. The emission levels that are 20dB below the official limit are not reported.

Note: Pre-scan all mode and recorded the worst case results in this report (TX mode)

5.6. FREQUENCY STABILITY OVER TEMPERATURE AND VOLTAGE VARIATIONS

5.6.1. Standard Applicable

According to FCC § 2.1055 the frequency stability shall be sufficient to ensure that the fundamental emissions

5.6.2. Test Procedures

As required by 47 CFR 2.1055, Frequency Stability measurements were made at the RF output terminals using a Spectrum Analyzer.

The EUT was placed in the Environmental Chamber.

A CW signal was injected into the EUT at the appropriate RF level. The frequency counter option on the Spectrum Analyzer was used to measure frequency deviations.

The frequency drift was investigated for every 10 °C increment until the unit is stabilized then recorded the reading in tabular format with the temperature range of -30 to 50 °C.

Voltage supplied to EUT is 120 Vac reference temperature was done at 20°C. The voltage was varied by $\pm 15\%$ of nominal

5.6.3. Test Setup

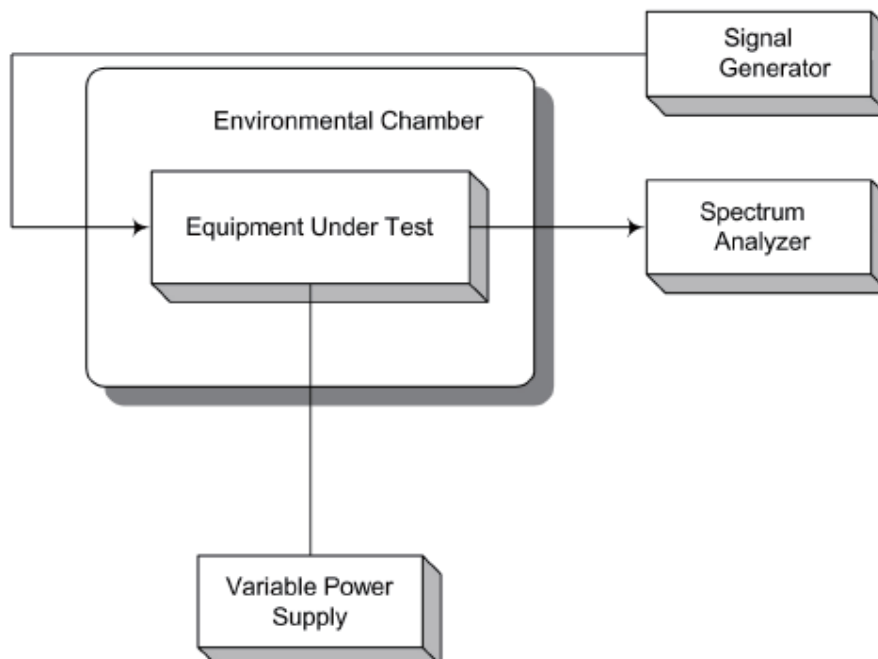

5.6.4. Test Results

This EUT is an amplifier, not a transmitter. There is no oscillator circuit in the EUT, therefore there is no frequency stability measurement required.

N/A.

5.7. DEVIATION TO TEST SPECIFICATIONS

[NONE]

6. LIST OF MEASURING EQUIPMENTS

Instrument	Manufacturer	Model No.	Serial No.	Cal Date	Due Date
Signal Generator	Agilent	E4438C	MY42082646	June 18,2012	June 17,2013
Power Meter	Agilent	E4416A	GB41291412	June 18,2012	June 17,2013
Attenuator	WEINSCHHEL	67-30-33	BR0530	June 18,2012	June 17,2013
Temperature and Humidity Chamber	Korea Eng	KR-1005L	KRAC05063-3C H	June 29,2012	June 28,2013
Signal Analyzer	Agilent	N9020A	US46220219	June 18,2012	June 17,2013
BI-LOG Antenna	Schwarzbeck	VULB 9168	9168-200	June 18,2012	June 17,2013
Antenna Position Tower	HD	MA240	556	N/A	N/A
Turn Table	EMCO	1050	114	N/A	N/A
Controller	HD GmbH	HD 100	13	N/A	N/A
SlideBar	HD GmbH	KMS 560	12	N/A	N/A
Horn Antenna	MITEQ	AFS44-00102650- 42-10P44-PS	1532439	June 18,2012	June 17,2013
Horn Antenna	Schwarzbeck	BBHA 9120D	147	July 07,2012	July 06,2013
Loop Antenna	Schwarzbeck	BBHA 9120D	296	July 07,2012	July 06,2013
Signal Generator	EMCO	6502	9009-2536	July 07,2012	July 06,2013
Wireless Communications Test Set	Agilent	8960 E5515C	GB47050534	June 18,2012	June 17,2013
Universal Radio Communication Tester	R&S	CMU200	112012	June 18,2012	June 17,2013
Spectrum	Agilent	E4407B	MY41440754	June 18,2012	June 17,2013

7. MANUFACTURER/ APPROVAL HOLDER DECLARATION

The following identical model(s):

PTE-C65	PTE-C55	PTE-C40	--
---------	---------	---------	----

All the models are similar except their model name.

Belong to the tested device:

Product description : Cell phone signal booster

Model name : PTE-C70

No additional models were tested.

-----THE END OF REPORT-----