

FCC 47 CFR PART 15 SUBPART E

Product Type : Rugged Tablet PC
Applicant : Handheld Group AB
Address : Kinnegatan 17, 53133 , Lidköping , Sweden
Trade Name : handheld
Model Number : ALGIZ 10XB, ALGIZ 10XBxxx (x=0~9, A~Z, a~z or blank or slash; for marketing purpose only and no impact safety related constructions and critical components)
Test Specification : FCC 47 CFR PART 15 SUBPART E: Oct., 2013
Canada RSS-210 ISSUE 8: Dec., 2010
ANSI C63.10-2009
ANSI C63.4:2014
Application Purpose : Original
Receive Date : Dec. 25, 2014
Test Period : Jan. 05, 2015
Issue Date : Jan. 27, 2015

Issue by

A Test Lab Techno Corp.
No. 140-1, Changan Street, Bade City,
Taoyuan County 334, Taiwan R.O.C.
Tel : +86-3-2710188 / Fax : +86-3-2710190



Taiwan Accreditation Foundation accreditation number: 1330

Note: This report shall not be reproduced except in full, without the written approval of A Test Lab Techno Corp. This document may be altered or revised by A Test Lab Techno Corp. personnel only, and shall be noted in the revision section of the document. The client should not use it to claim product endorsement by TAF, or any government agencies. The test results in the report only apply to the tested sample.

Revision History

Rev.	Issue Date	Revisions	Revised By
00	Jan. 27, 2015	Initial Issue	

Verification of Compliance

Issued Date: 01/27/2015

Product Type : Rugged Tablet PC
Applicant : Handheld Group AB
Address : Kinnegatan 17, 53133 , Lidköping , Sweden
Trade Name : handheld
Model Number : ALGIZ 10XB, ALGIZ 10XBxxx (x=0~9, A~Z, a~z or blank or slash; for marketing purpose only and no impact safety related constructions and critical components)
FCC ID : YY3-ALGIZ10XB
EUT Rated Voltage : DC 19V, 3.42A
Test Voltage : 120 Vac / 60 Hz
Applicable Standard : FCC 47 CFR PART 15 SUBPART E: Oct., 2013
Canada RSS-210 ISSUE 8: Dec., 2010
ANSI C63.10-2009
ANSI C63.4:2014

Test Result : Complied

Application Purpose : Original

Performing Lab. : A Test Lab Techno Corp.

No. 140-1, Changan Street, Bade City,
Taoyuan County 334, Taiwan R.O.C.

Tel : +86-3-2710188 / Fax : +86-3-2710190

Taiwan Accreditation Foundation accreditation number: 1330

<http://www.atl-lab.com.tw/e-index.htm>



A Test Lab Techno Corp. tested the above equipment in accordance with the requirements set forth in the above standards. All indications of Pass/Fail in this report are opinions expressed by A Test Lab Techno Corp. based on interpretations and/or observations of test results. Measurement Uncertainties were not taken into account and are published for informational purposes only. The test results show that the equipment tested is capable of demonstrating compliance with the requirements as documented in this report.

Approved By : Fly Lu
(Manager) (Fly Lu)

Reviewed By : Eric Ou Yang
(Testing Engineer) (Eric Ou Yang)

TABLE OF CONTENTS

1	EUT Description	5
2	Test Methodology	5
3	Dynamic Frequency Selection.....	6
	3.1. Limits	6
	3.2. Test and Measurement System	10
	3.3. Test Instruments	11
4	Test Methodology	12
	4.1. Mode of Operation	12
	4.2. EUT Exercise Software.....	13
	4.3. Test Site Environment.....	13
5	Results for 40 MHz Bandwidth	14
	5.1. Radar Waveforms and Traffic	14
	5.2. Channel Availability Check Time	24
	5.3. Overlapping Channel Tests.....	24
	5.4. Move and Closing Time	25
	5.5. Non-Occupancy Period	34
	5.6. Detection Bandwidth.....	36
	5.7. In-Service Monitoring.....	36

1 EUT Description

Product	Rugged Tablet PC			
Trade Name	handheld			
Model No.	ALGIZ 10XB, ALGIZ 10XBxxx (x=0~9, A~Z, a~z or blank or slash; for marketing purpose only and no impact safety related constructions and critical components)			
Applicant	Handheld Group AB Kinnegatan 17, 53133 , Lidköping , Sweden			
Manufacturer	Handheld Group AB Kinnegatan 17, 53133 , Lidköping , Sweden			
FCC ID	YY3-ALGIZ10XB			
Frequency Range	Band	Mode	Frequency Range (MHz)	Number of Channels
	UNII Band II-A	IEEE 802.11n (5GHz) 40 MHz	5270 - 5310	2 Channels
	UNII Band II-C	IEEE 802.11n (5GHz) 40 MHz	5510 - 5670	5 Channels
	*The 5600 – 5650MHz can not be used in Canada.			
Type of Modulation	OFDM			
Equipment Type	Client (without radar detection function)			

2 Test Methodology

The tests documented in this report were performed in accordance with ANSI C63.10-2009, FCC CFR 47 Part 2, FCC CFR 47 Part 15, FCC 06-96, KDB 905462 D02, KDB 905462 D03, and RSS-210 Issue 8.

3 Dynamic Frequency Selection

3.1. Limits

Industry Canada

IC RSS-210 is closely harmonized with FCC Part 15 DFS rules. The deviations are as follows:

RSS-210 Issue 8 A9.4 (b) (ii) Channel Availability Check Time:

Additional requirements for the band 5600-5650 MHz: Until further notice, devices subject to this Section shall not be capable of transmitting in the band 5600-5650 MHz, so that Environment Canada weather radars operating in this band are protected.

RSS-210 Issue 8 A9.4 (b) (iv) Channel closing time: the maximum channel closing time is 260 ms.

FCC

§ 15.407 (h) and KDB 905462 D02 "COMPLIANCE MEASUREMENT PROCEDURES FOR UNLICENSED-NATIONAL INFORMATION INFRASTRUCTURE DEVCIES OPERATING IN THE 5250-5350 MHz AND 5470-5725 MHz BANDS INCORPORATING DYNAMIC FREQUENCY SELECTION.

Table 1: Applicability of DFS Requirements Prior to Use of a Channel			
Requirement	Operational Mode		
	Master	Client (without DFS)	Client (with DFS)
Non-Occupancy Period	Yes	Not required	Yes
DFS Detection Threshold	Yes	Not required	Yes
Channel Availability Check Time	Yes	Not required	Not required
U-NII Detection Bandwidth	Yes	Not required	Yes

Table 2: Applicability of DFS requirements during normal operation		
Requirement	Operational Mode	
	Master Device or Client With Radar Detection	Client without Radar Detection
DFS Detection Threshold	Yes	Not required
Channel Closing Transmission Time	Yes	Yes
Channel Move Time	Yes	Yes
U-NII Detection Bandwidth	Yes	Not required

Additional requirements for devices with multiple bandwidth modes	Master Device or Client With Radar Detection	Client without Radar Detection
U-NII Detection Bandwidth and Statistical Performance Check	All BW modes must be tested	Not required
Channel Move Time and Channel Closing Transmission Time	Test using widest BW mode available	Test using the widest BW mode available for the link
All other tests	Any single BW mode	Not required

Note : Frequencies selected for statistical performance check (Section 7.8.4) should include several frequencies within the radar detection bandwidth and frequencies near the edge of the radar detection bandwidth. For 802.11 devices it is suggested to select frequencies in all 20 MHz channel blocks and a null frequencies between the bonded 20 MHz channel blocks

Table 3: DFS Detection Thresholds for Master Devices and Client Devices With Radar Detection	
Maximum Transmit Power	Value (See Notes 1,2 and 3)
EIRP \geq 200 milliwatt	-64 dBm
EIRP < 200 milliwatt and Power spectral density < 10 dBm/MHz	-62 dBm
EIRP < 200 milliwatt that do not meet the power spectral density requirement	-64 dBm
<p>Note 1: This is the level at the input of the receiver assuming a 0 dBi receive antenna.</p> <p>Note 2: Throughout these test procedures an additional 1 dB has been added to the amplitude of the test transmission waveforms to account for variations in measurement equipment. This will ensure that the test signal is at or above the detection threshold level to trigger a DFS response.</p> <p>Note 3: EIRP is based on the highest antenna gain. For MIMO devices refer to KDB Publication 662911 D01.</p>	

Table 4: DFS Response Requirement Values	
Parameter	Value
Non-occupancy period	Minimum 30 minutes
Channel Availability Check Time	60 seconds
Channel Move Time	10 seconds See Note 1.
Channel Closing Transmission Time	200 milliseconds + an aggregate of 60 milliseconds over remaining 10 second period. See Notes 1 and 2.
U-NII Detection Bandwidth	Minimum 100% of the U-NII 99% transmission power bandwidth. See Note 3.
<p>Note 1: Channel Move Time and the Channel Closing Transmission Time should be performed with Radar Type 0. The measurement timing begins at the end of the Radar Type 0 burst.</p> <p>Note 2: The Channel Closing Transmission Time is comprised of 200 milliseconds starting at the beginning of the Channel Move Time plus any additional intermittent control signals required to facilitate a Channel move (an aggregate of 60 milliseconds) during the remainder of the 10 second period. The aggregate duration of control signals will not count quiet periods in between transmissions.</p> <p>Note 3: During the U-NII Detection Bandwidth detection test, radar type 0 should be used. For each frequency step the minimum percentage of detection is 90 percent. Measurements are performed with no data traffic.</p>	

Table 5: Short Pulse Radar Test Waveforms					
Radar Type	Pulse Width (μsec)	PRI (μsec)	Number of Pulses	Minimum Percentage of Successful Detection	Minimum Number of Trials
0	1	1428	18	See Note 1	See Note 1
1	1	Test A: 15 unique PRI values randomly selected from the list of 23 PRI values in Table 5a <hr/> Test B: 15 unique PRI values randomly selected within the range of 518-3066 μsec, with a minimum increment of 1 μsec, excluding PRI values selected in Test A	$\text{Roundup} \left\{ \begin{array}{l} \left(\frac{1}{360} \right) \cdot \\ \left(\frac{19 \cdot 10^6}{\text{PRI}_{\mu\text{sec}}} \right) \end{array} \right\}$	60%	30
2	1-5	150-230	23-29	60%	30
3	6-10	200-500	16-18	60%	30
4	11-20	200-500	12-16	60%	30
Aggregate (Radar Types 1-4)				80%	120
Note 1: Short Pulse Radar Type 0 should be used for the detection bandwidth test, channel move time, and channel closing time tests.					

Table 5a: Pulse Repetition Intervals Values for Test A		
Pulse Repetition Frequency Number	Pulse Repetition Frequency (Pulses Per Second)	Pulse Repetition Interval (Microseconds)
1	1930.5	518
2	1858.7	538
3	1792.1	558
4	1730.1	578
5	1672.2	598
6	1618.1	618
7	1567.4	638
8	1519.8	658
9	1474.9	678
10	1432.7	698
11	1392.8	718
12	1355	738
13	1319.3	758
14	1285.3	778
15	1253.1	798
16	1222.5	818
17	1193.3	838
18	1165.6	858
19	1139	878
20	1113.6	898
21	1089.3	918
22	1066.1	938
23	326.2	3066

Table 6: Long Pulse Radar Test Waveform							
Type	Pulse Width (µsec)	Chirp Width (MHz)	PRI (µsec)	Number of Pulses per <i>Burst</i>	Number of <i>Bursts</i>	Minimum Percentage of Successful Detection	Minimum Number of Trials
5	50-100	5-20	1000-2000	1-3	8-20	80%	30

Table 7: Frequency Hopping Radar Test Waveform							
Type	Pulse Width (µsec)	PRI (µsec)	Pulses per Hop	Hopping Rate (kHz)	Hopping Sequence Length (msec)	Minimum Percentage of Successful Detection	Minimum Number of Trials
6	1	333	9	0.333	300	70%	30

3.2. Test and Measurement System

3.2.1. Setup for Client with injection at the Master

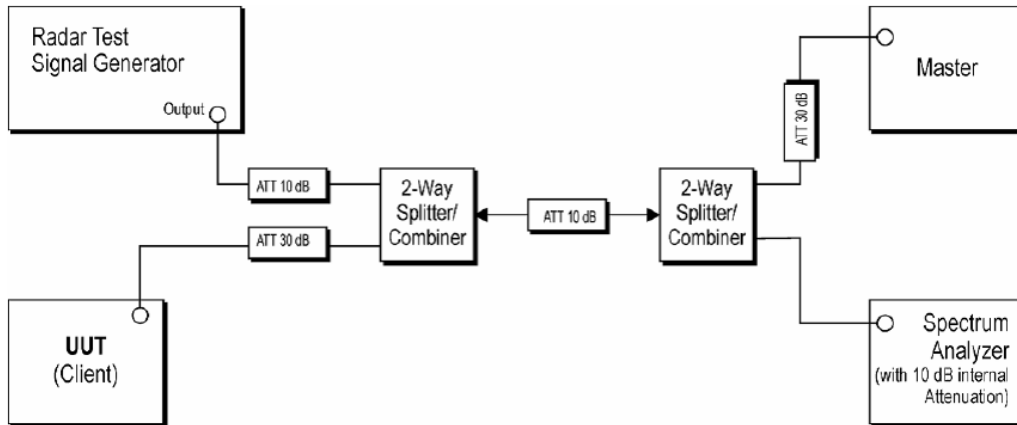

3.2.2. System Calibration

The short pulse and long pulse signal generating system utilizes the NTIA software. The Vector Signal Generator has been validated by the NTIA. The hopping signal generating system utilizes the A Test Lab Techno Corp. simulated hopping method and system, which has been validated by the DoD, FCC and NTIA. The software selects waveform parameters from within the bounds of the signal type on a random basis using uniform distribution.

The short pulse types 2, 3 and 4, and the long pulse type 5 parameters are randomized at run-time. The hopping type 6 pulse parameters are fixed while the hopping sequence is based on the August 2005 NTIA Hopping Frequency List. The initial starting point randomized at run-time and each subsequent starting point is incremented by 475. Each frequency in the 100-length segment is compared to the boundaries of the EUT Detection Bandwidth and the software creates a hopping burst pattern in accordance with Section 7.4.1.3 Method #2 Simulated Frequency Hopping Radar Waveform Generating Subsystem of FCC 06-96 APPENDIX. The frequency of the signal generator is incremented in 1 MHz steps from FL to FH for each successive trial. This incremental sequence is repeated as required to generate a minimum of 30 total trials and to maintain a uniform frequency distribution over the entire Detection Bandwidth.

The signal monitoring equipment consists of a spectrum analyzer. The aggregate ON time is calculated by multiplying the number of bins above a threshold during a particular observation period by the dwell time per bin, with the analyzer set to peak detection and max hold.

3.2.3. System Calibration

A 50-ohm load is connected in place of the spectrum analyzer, and the spectrum analyzer is connected to a horn antenna via a coaxial cable, with the reference level offset set to (horn antenna gain – coaxial cable loss). The signal generator is set to CW mode. The amplitude of the signal generator is adjusted to yield a level of -64 dBm as measured on the spectrum analyzer.

Without changing any of the instrument settings, the spectrum analyzer is reconnected to the Common port of the Spectrum Analyzer Combiner/Divider. The Reference Level Offset of the spectrum analyzer is adjusted so that the displayed amplitude of the signal is -64 dBm.

The spectrum analyzer displays the level of the signal generator as received at the antenna ports of the Master Device. The interference detection threshold may be varied from the calibrated value of -64 dBm and the spectrum analyzer will still indicate the level as received by the Master Device.

3.2.4. Adjustment of Displayed Traffic Level

A link is established between the Master and Slave and the distance between the units is adjusted as needed to provide a suitable received level at the Master and Slave devices. The video test file is streamed to generate WLAN traffic. The monitoring antenna is adjusted so that the WLAN traffic level, as displayed on the spectrum analyzer, is at lower amplitude than the radar detection threshold.

3.3. Test Instruments

Equipment	Manufacturer	Model Number	Serial Number	Cal. Date	Remark
Spectrum Analyzer	Agilent	E4408B	MY45107753	07/24/2014	(1)
Signal Generator	R&S	SMU200A	102598	04/24/2014	(1)
Test Site	ATL	TE02	TE02	N.C.R.	-----

Remark: ⁽¹⁾ Calibration period 1 year. ⁽²⁾ Calibration period 2 years.

Note: N.C.R. = No Calibration Request.

4 Test Methodology

4.1. Mode of Operation

Decision of Test ATL has verified the construction and function in typical operation. All the test modes were carried out with the EUT in normal operation, which was shown in this test report and defined as:

Test Mode
Mode 1: IEEE 802.11n 40MHz U-NII Band II-A Link Mode
Mode 2: IEEE 802.11n 40MHz U-NII Band II-C Link Mode

Software used to control the EUT for staying in continuous transmitting mode was programmed.

After verification, all tests were carried out with the worst case test modes as shown below except radiated spurious emission below 1GHz and power line conducted emissions below 30MHz, which worst case was in normal link mode only.

IEEE 802.11n 40MHz U-NII Band II-A mode:

Unless otherwise noted, all tests were performed with the radar burst at the channel center frequency of 5270 MHz and 5310MHz.

IEEE 802.11n 40MHz U-NII Band II-C mode:

Unless otherwise noted, all tests were performed with the radar burst at the channel center frequency of 5510 MHz and 5550MHz.

Tested System Details

The types for all equipments, plus descriptions of all cables used in the tested system (including inserted cards) are:

	Product	Manufacturer	Model No.	Serial No.	Power Cord
1.	Cisco Aironet IOS Access Point	Cisco	AIR-AP1252AG-A-K9	AIR-RM1252A-A-K9 FCC ID:LDK102061 IC:24618-102061	---

4.2. EUT Exercise Software

1.	Setup the EUT shown on 3.3.
2.	Turn on the power of all equipment.
3.	Turn on Wi-Fi function link to Notebook.
4.	EUT run test program.

4.3. Test Site Environment

Items	Required (IEC 68-1)	Actual
Temperature (°C)	15-35	26
Humidity (%RH)	25-75	60
Barometric pressure (mbar)	860-1060	950

5 Results for 40 MHz Bandwidth

5.1. Radar Waveforms and Traffic

5.1.1. Results

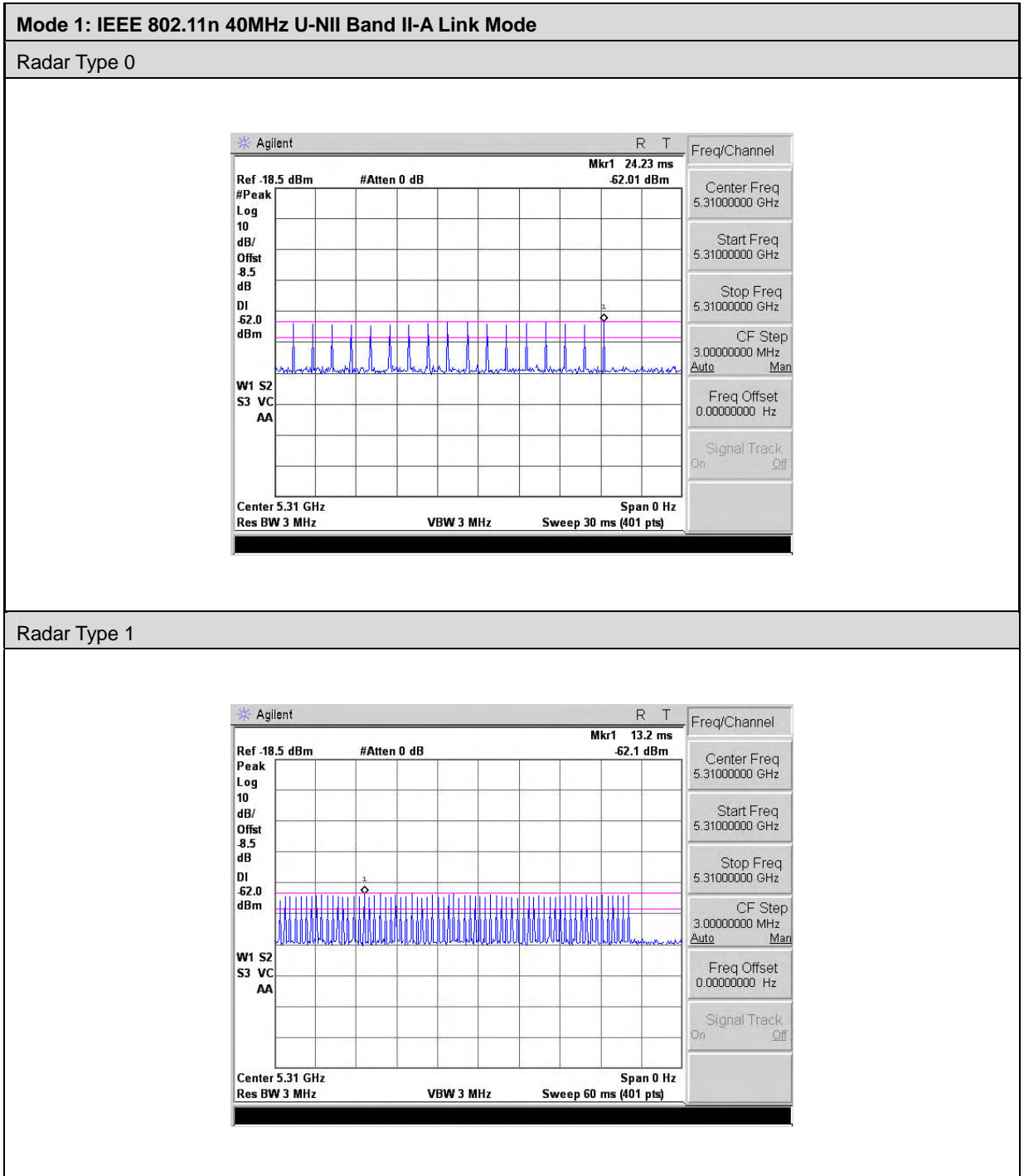

Mode 1: IEEE 802.11n 40MHz U-NII Band II-A Link Mode

Radar Type 2

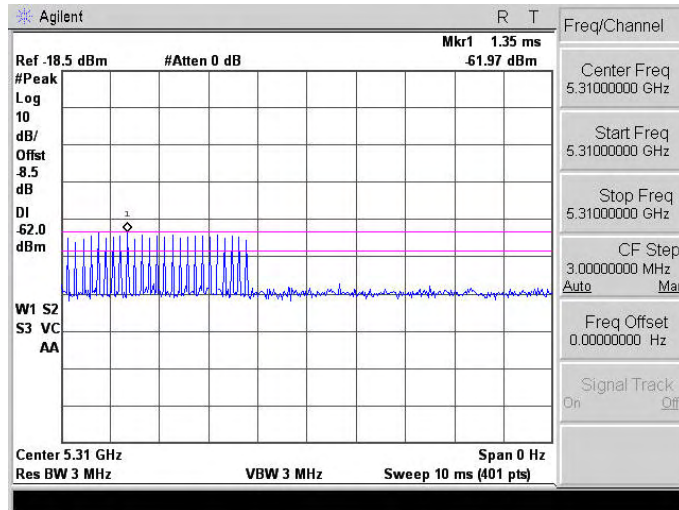

Radar Type 3

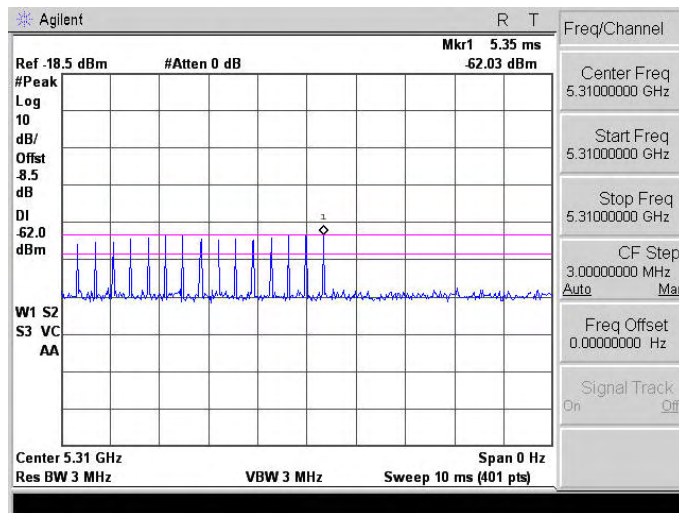

Mode 1: IEEE 802.11n 40MHz U-NII Band II-A Link Mode
Radar Type 4

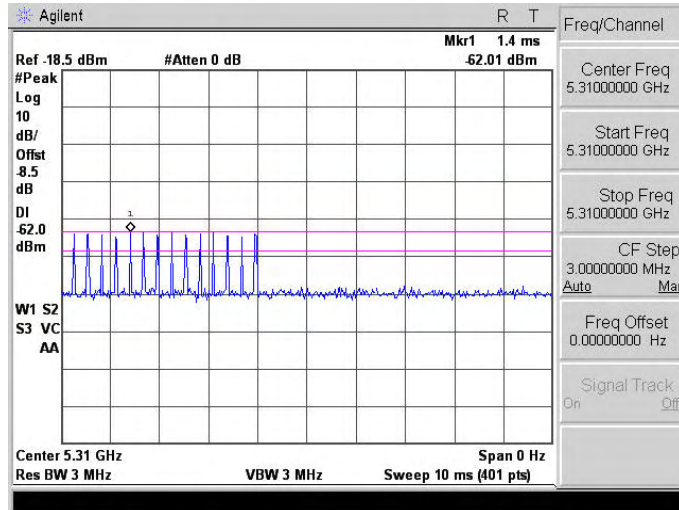

Radar Type 5

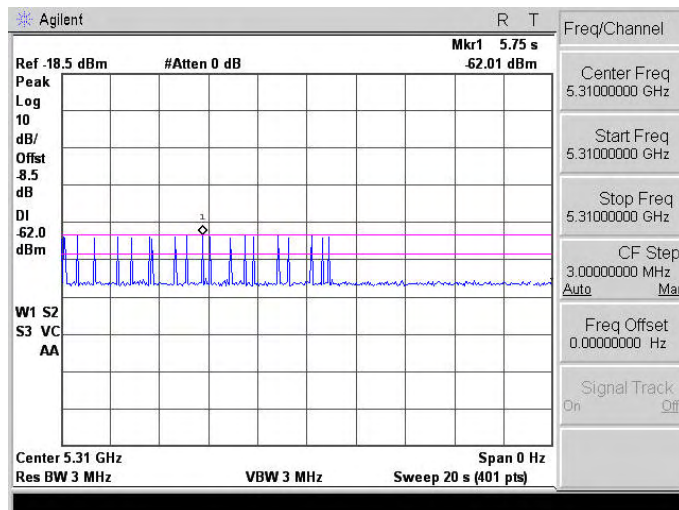

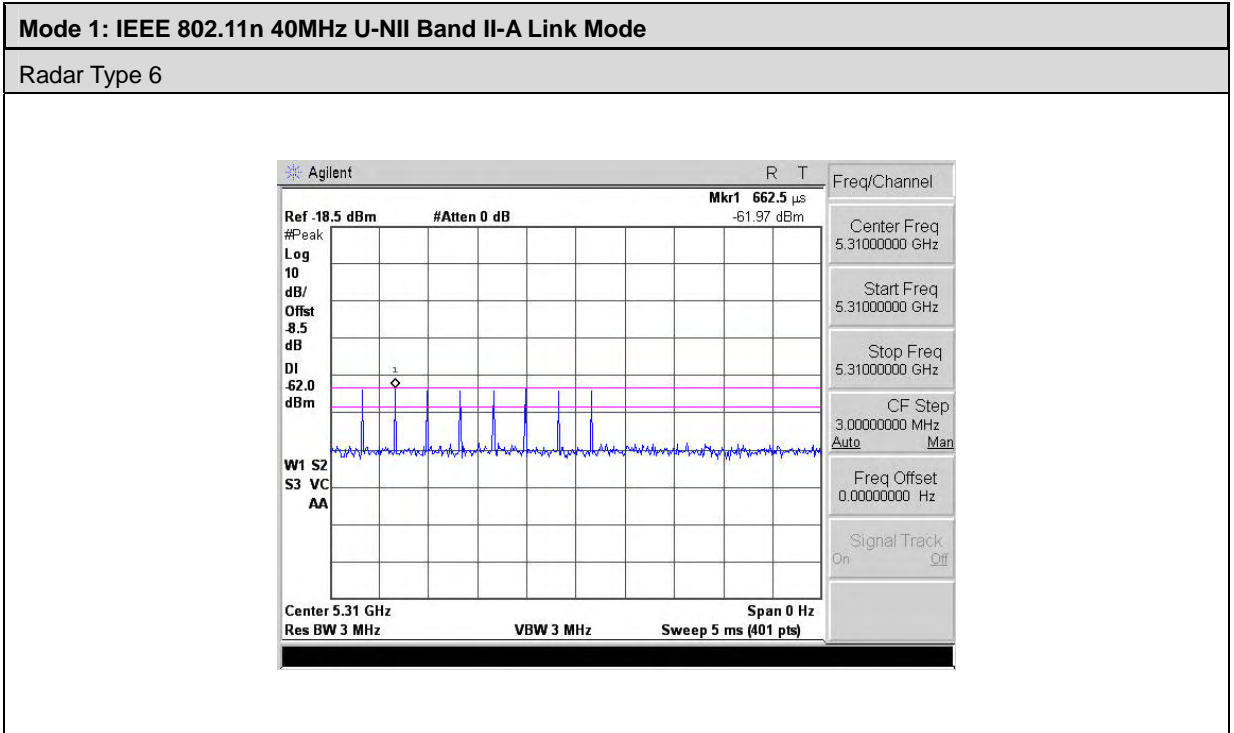

Mode 1: IEEE 802.11n 40MHz U-NII Band II-A Link Mode_5270MHz

Traffic

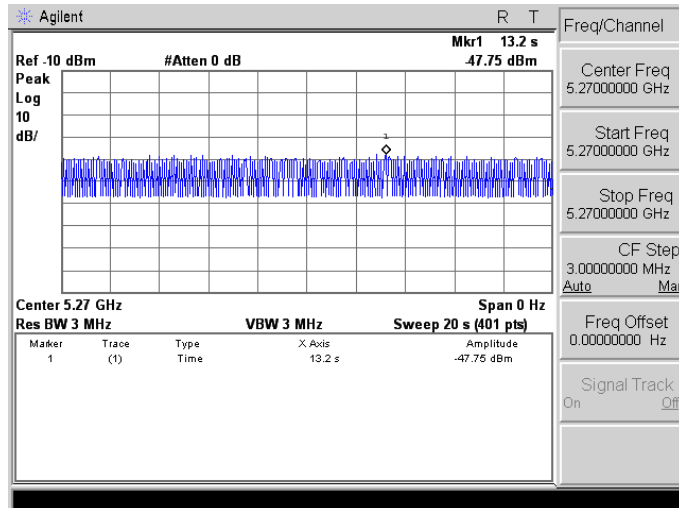

Mode 1: IEEE 802.11n 40MHz U-NII Band II-A Link Mode_5310MHz

Traffic

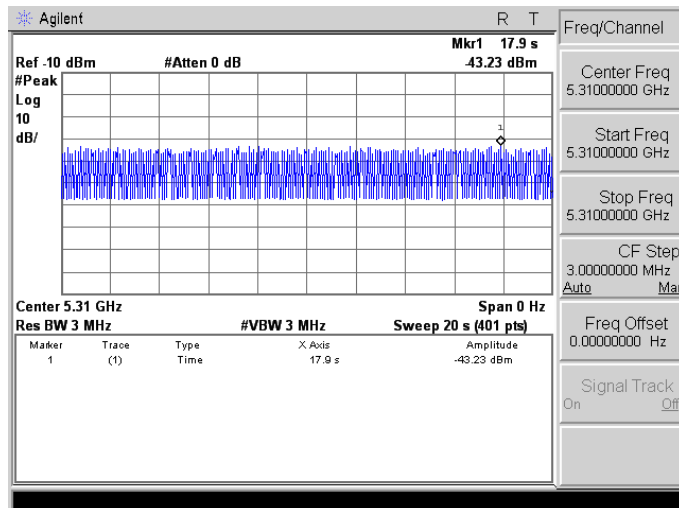

Mode 2: IEEE 802.11n 40MHz U-NII Band II-C Link Mode

Radar Type 0

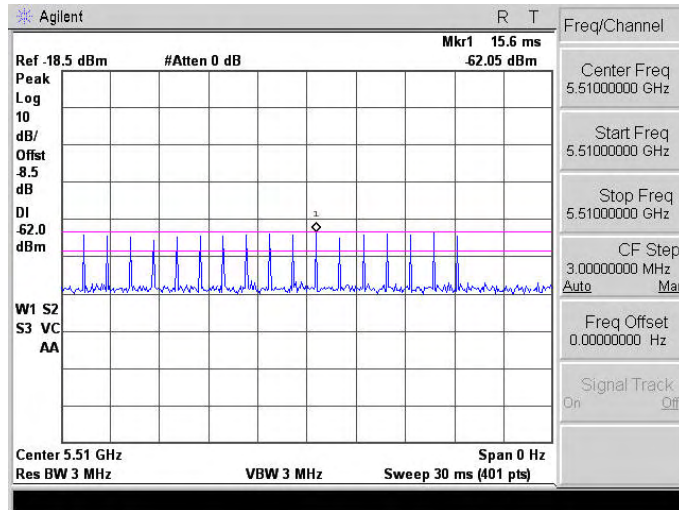

Radar Type 1

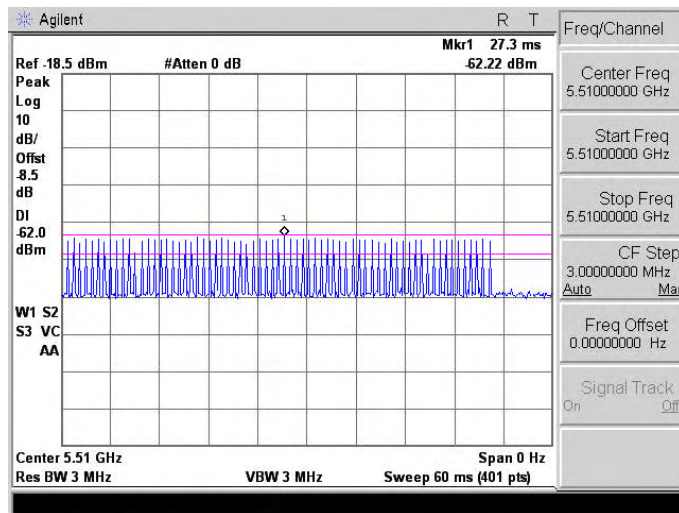

Mode 2: IEEE 802.11n 40MHz U-NII Band II-C Link Mode

Radar Type 2

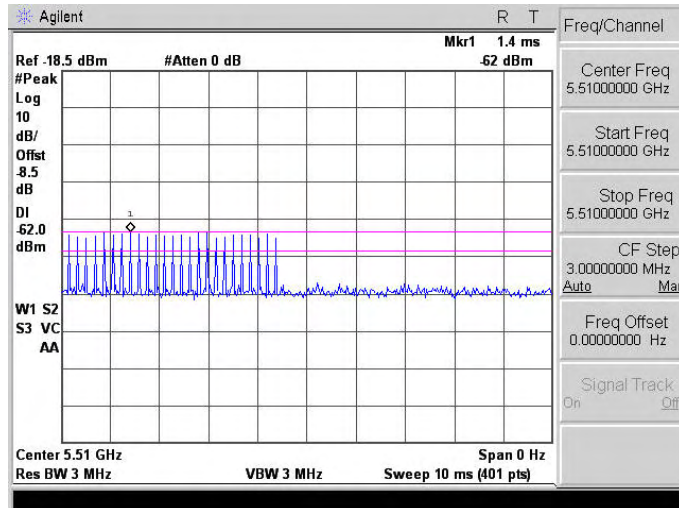

Radar Type 3

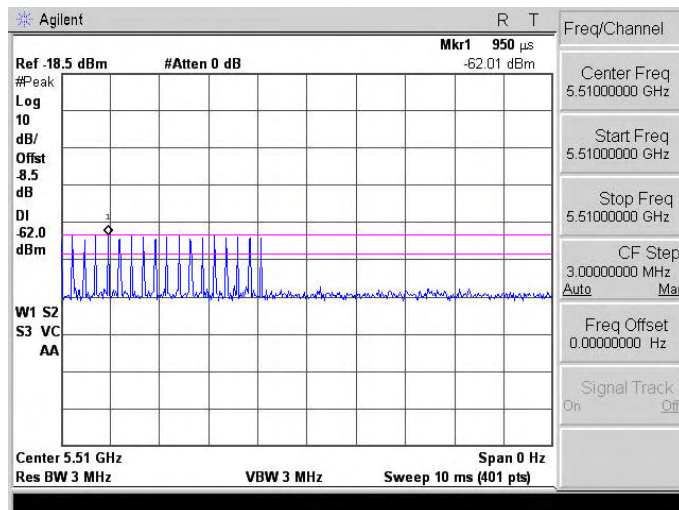

Mode 2: IEEE 802.11n 40MHz U-NII Band II-C Link Mode
Radar Type 4

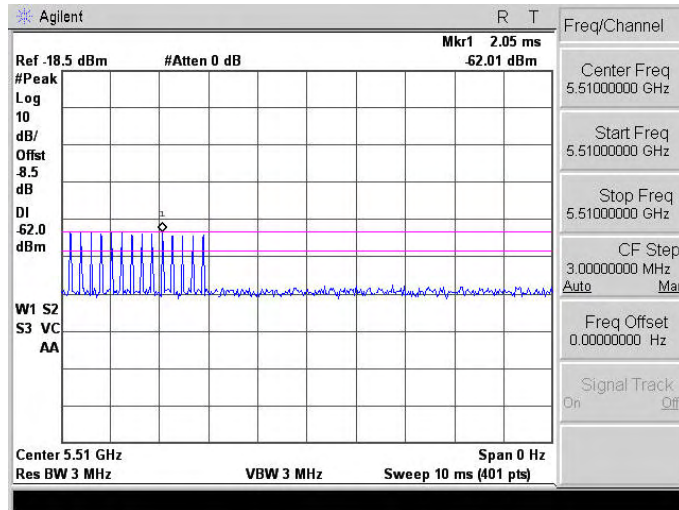

Radar Type 5

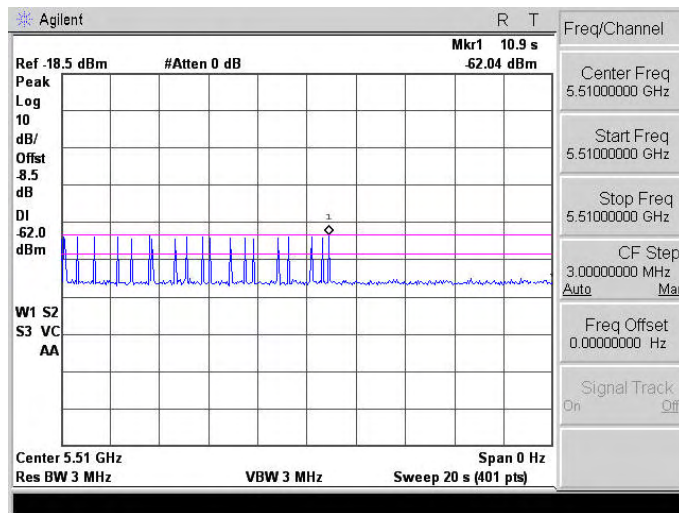

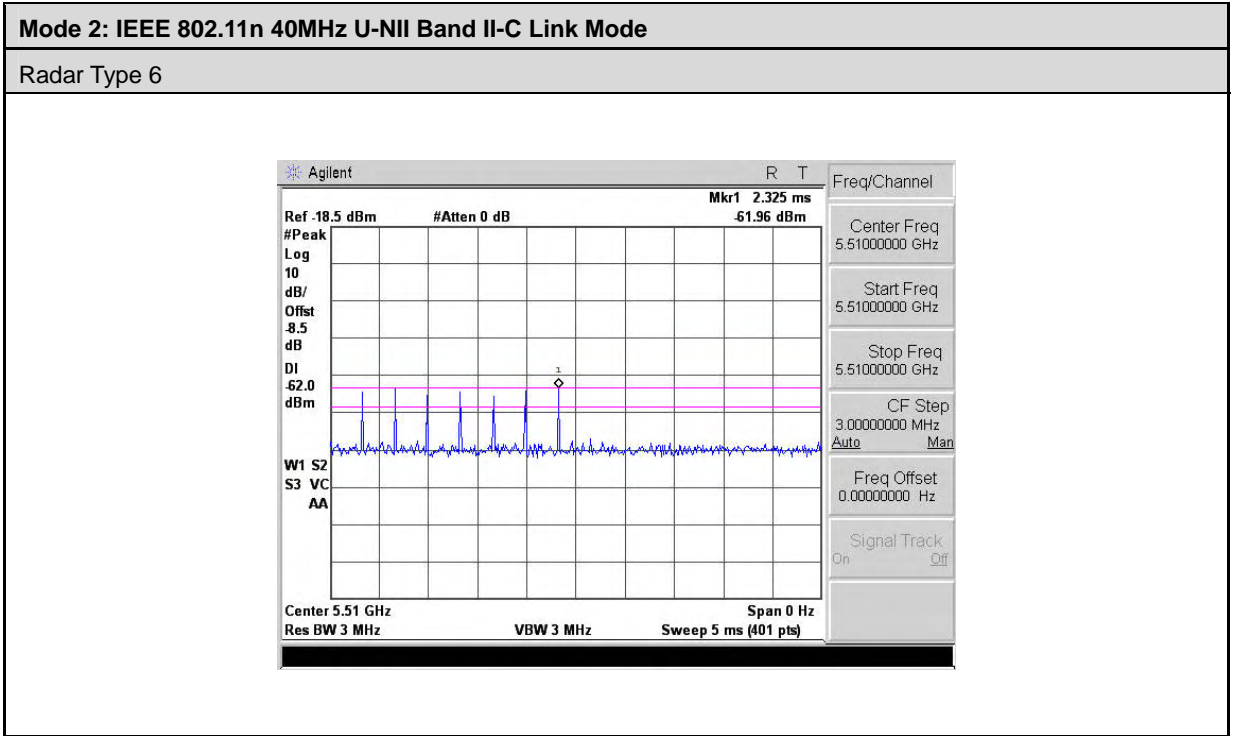

Mode 2: IEEE 802.11n 40MHz U-NII Band II-C Link Mode_5510MHz

Traffic

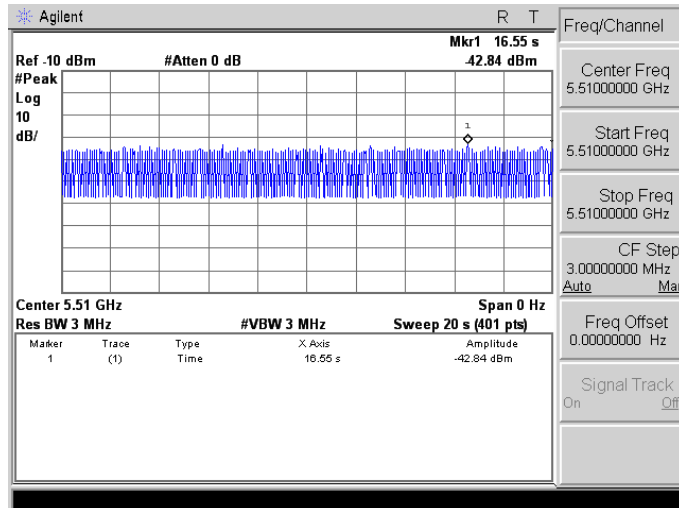

Mode 2: IEEE 802.11n 40MHz U-NII Band II-C Link Mode_5550MHz

Traffic

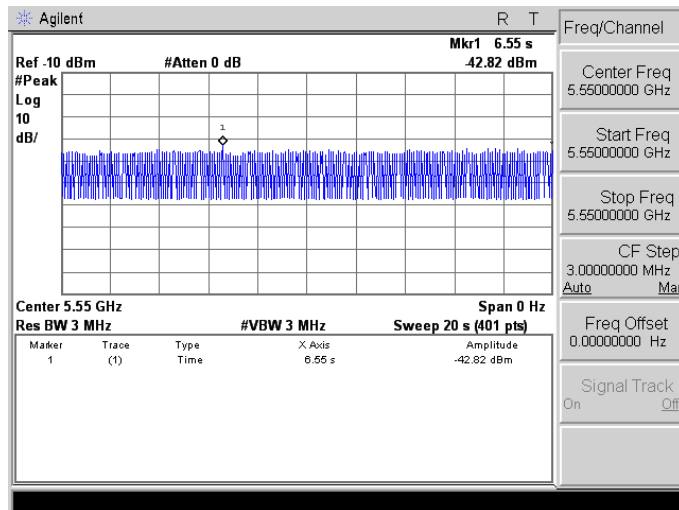

5.2. Channel Availability Check Time

5.2.1. Procedure to Determine Initial Power-Up Cycle Time

A link was established on channel then the EUT was rebooted. The time from the cessation of traffic to the re-initialization of traffic was measured as the time required for the EUT to complete the total power-up cycle. The time to complete the initial power-up period is 60 seconds less than this total power-up time.

5.2.2. Procedure for Timing Of Radar Burst

With a link established on channel, the EUT was rebooted. A radar signal was triggered within 0 to 6 seconds after the initial power-up period, and transmissions on the channel were monitored on the spectrum analyzer.

The Non-Occupancy list was cleared. With a link established on channel, the EUT was rebooted. A radar signal was triggered within 54 to 60 seconds after the initial power-up period, and transmissions on the channel were monitored on the spectrum analyzer.

5.2.3. Quantitative Results

These tests are not applicable.

5.3. Overlapping Channel Tests

These tests are not applicable.

5.4. Move and Closing Time

5.4.1. Reporting Notes

The reference marker is set at the end of last radar pulse.

The delta marker is set at the end of the last WLAN transmission following the radar pulse.

This delta is the channel move time.

The aggregate channel closing transmission time is calculated as follows:

Aggregate Transmission Time = (Number of analyzer bins showing transmission) * (dwell time per bin)

The observation period over which the FCC aggregate time is calculated begins at (Reference Marker + 200 msec) and ends no earlier than (Reference Marker + 10 sec).

The observation period over which the IC aggregate time is calculated begins at (Reference Marker) and ends no earlier than (Reference Marker + 10 sec).

5.4.2. Results

Mode 1: IEEE 802.11n 40MHz U-NII Band II-A Link Mode			
Agency	Frequency (MHz)	Channel Move Time (sec)	Limit (sec)
FCC / IC	5270	0.800	10
	5310	1.050	
Agency	Frequency (MHz)	Aggregate Channel Closing Transmission Time (msec)	Limit (msec)
FCC	5270	60.00	60
	5310	60.00	
IC	5270	60.00	260
	5310	60.00	

Mode 2: IEEE 802.11n 40MHz U-NII Band II-A Link Mode			
Agency	Frequency (MHz)	Channel Move Time (sec)	Limit (sec)
FCC / IC	5510	1.000	10
	5550	1.100	
Agency	Frequency (MHz)	Aggregate Channel Closing Transmission Time (msec)	Limit (msec)
FCC	5510	50.00	60
	5550	55.00	
IC	5510	50.00	260
	5550	55.00	

Mode 1: IEEE 802.11n 40MHz U-NII Band II-A Link Mode_5270MHz

Move Time

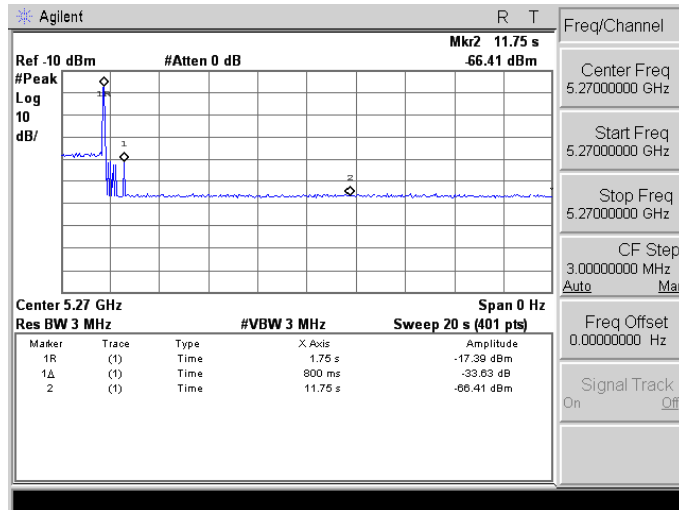

Channel Closing Time

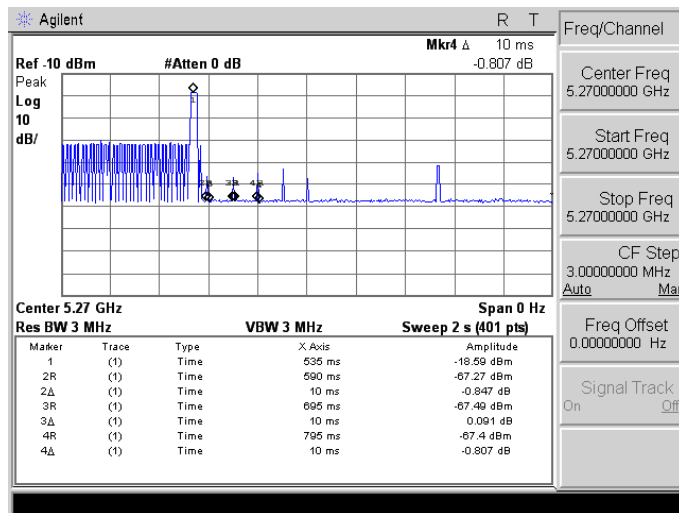

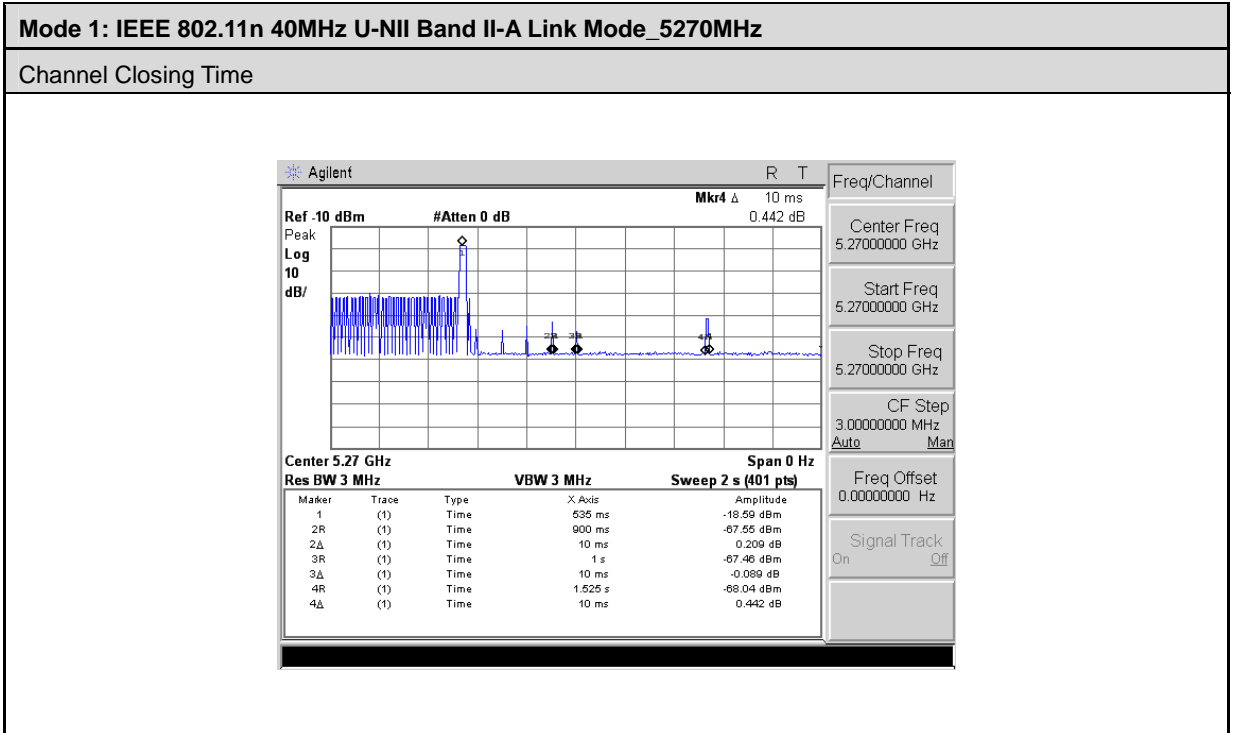

Mode 1: IEEE 802.11n 40MHz U-NII Band II-A Link Mode_5310MHz

Move Time

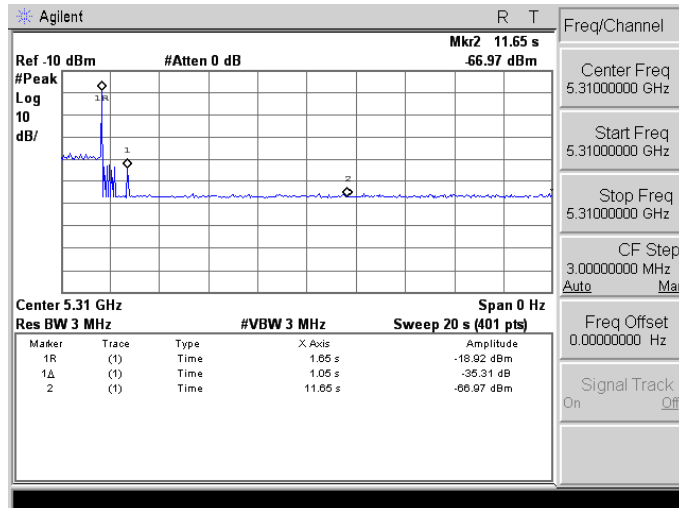

Channel Closing Time

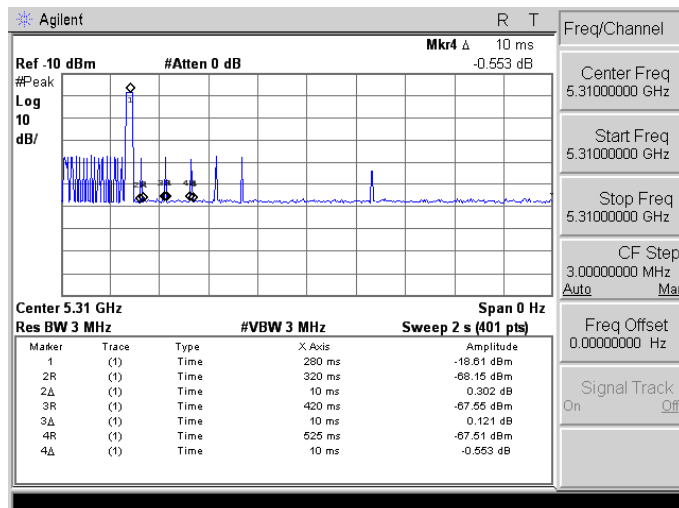

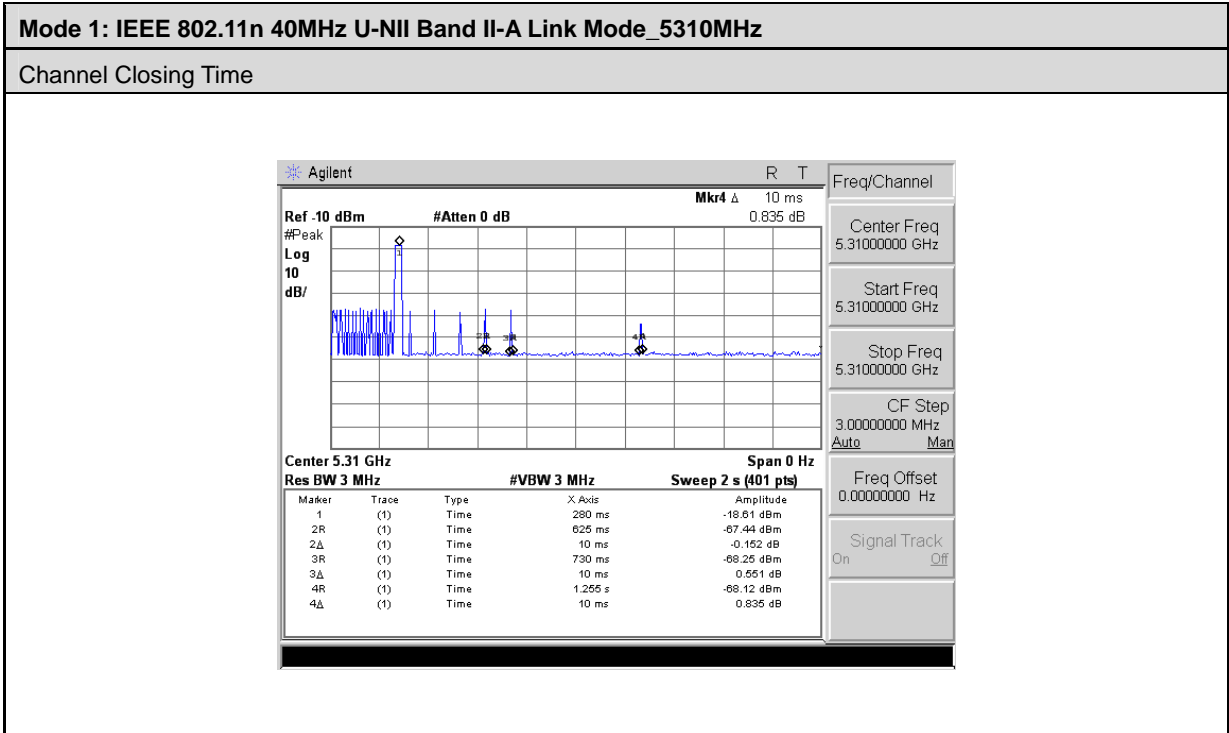

Mode 2: IEEE 802.11n 40MHz U-NII Band II-C Link Mode_5510MHz

Move Time

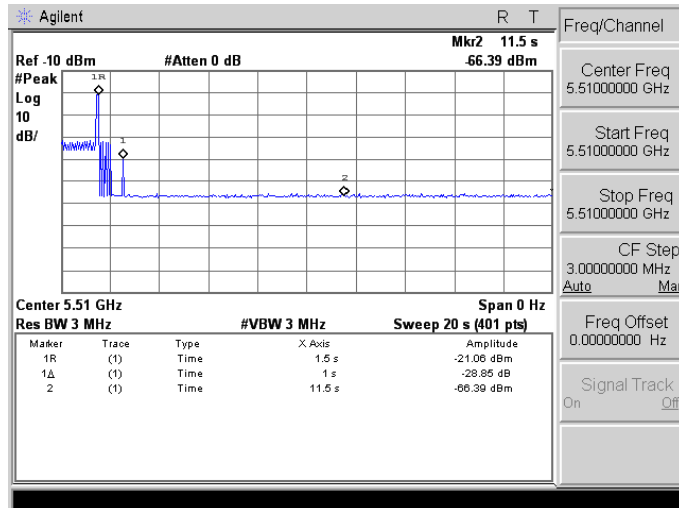

Channel Closing Time

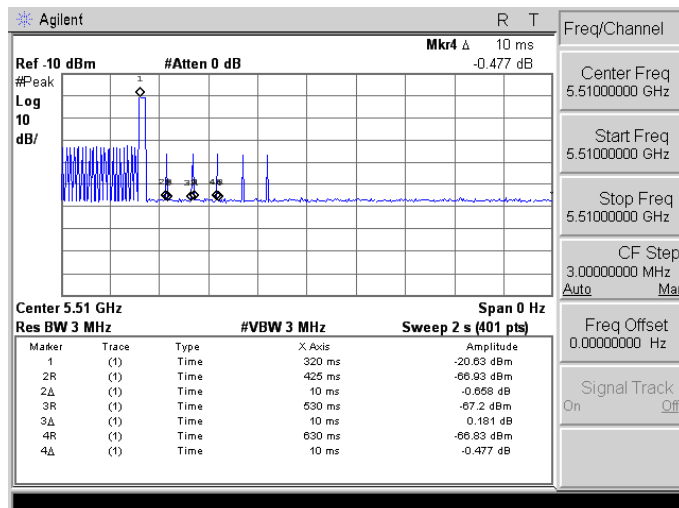

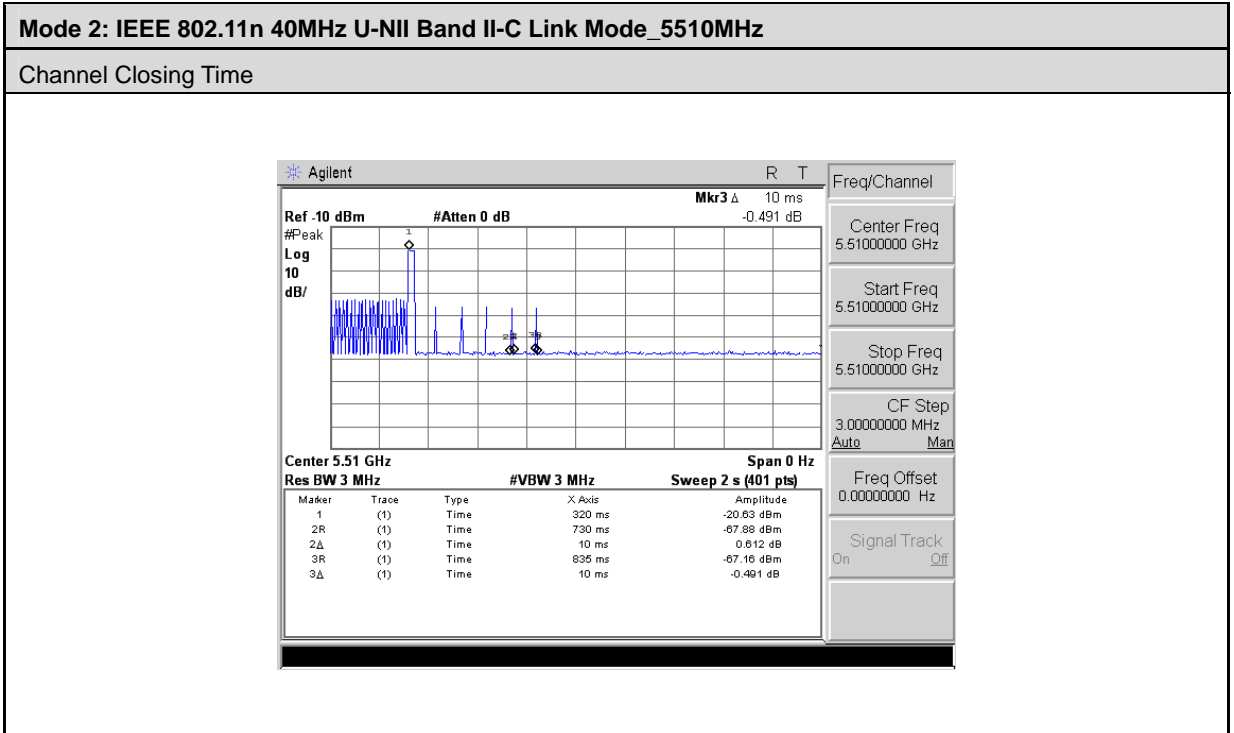

Mode 2: IEEE 802.11n 40MHz U-NII Band II-C Link Mode_5550MHz

Move Time

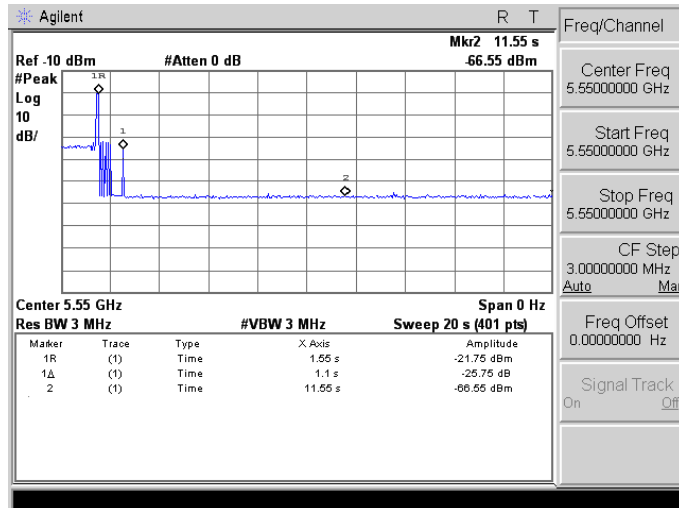

Channel Closing Time

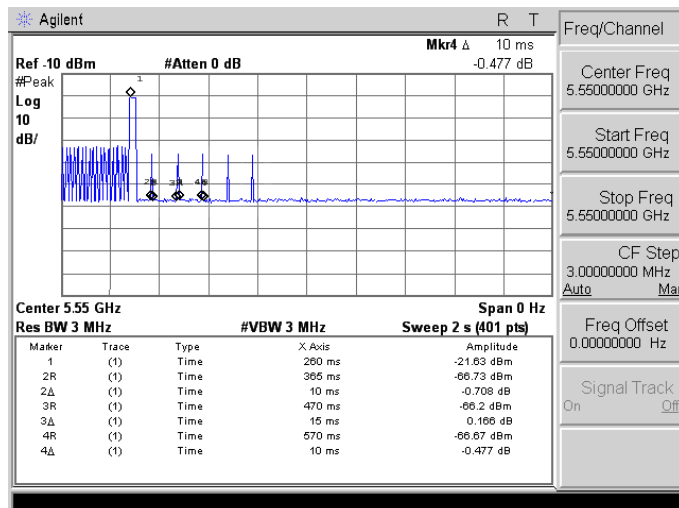

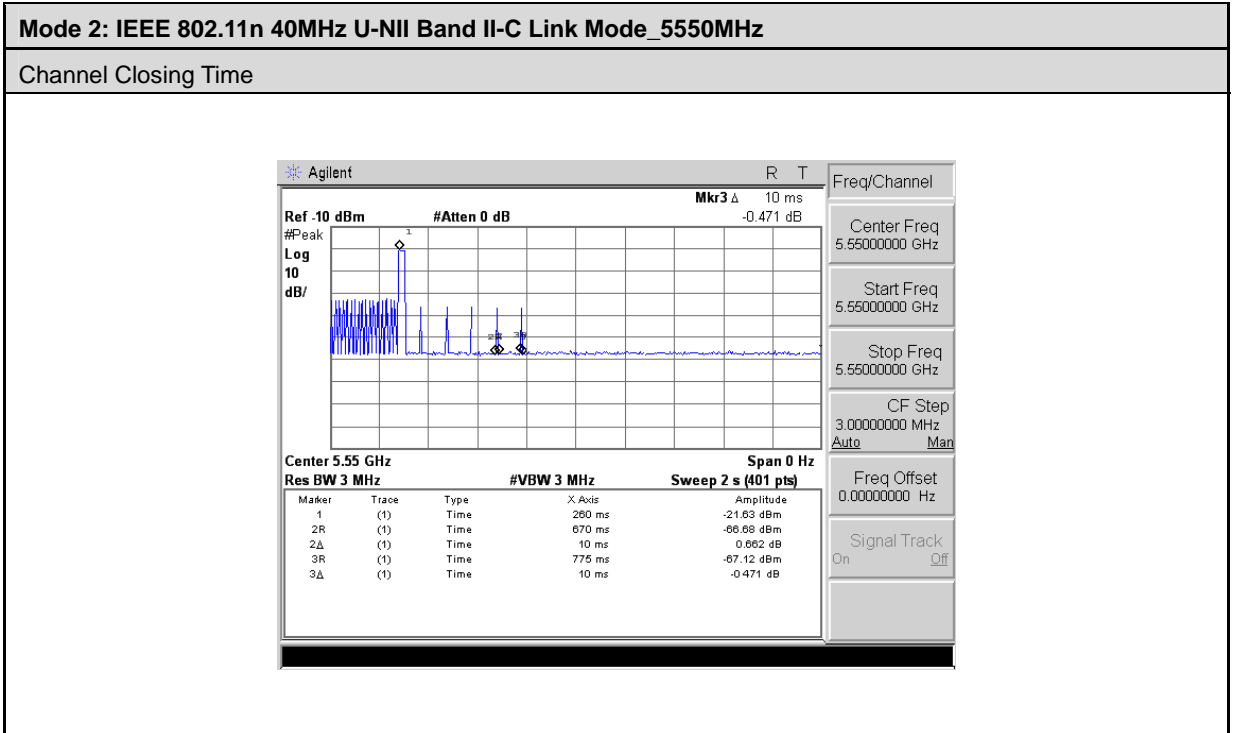

5.5. Non-Occupancy Period

5.5.1. Results

No EUT transmissions were observed on the test channel during the 30-minute observation time.

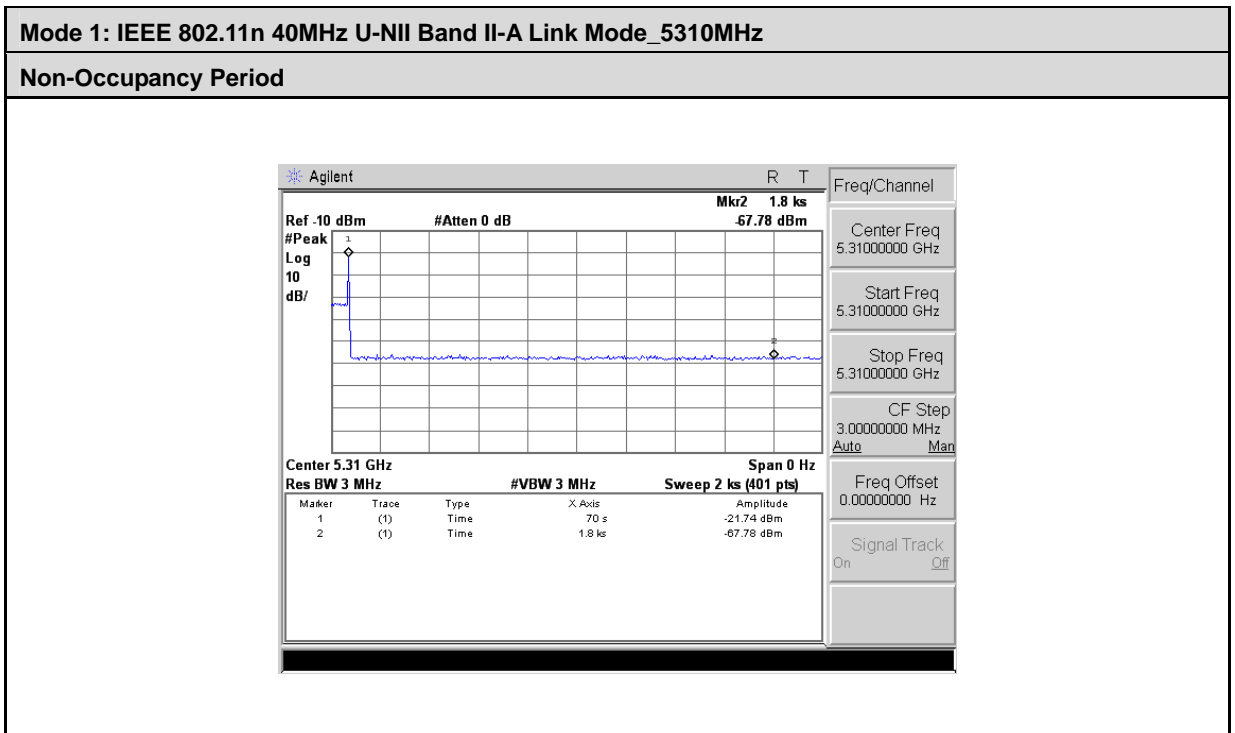
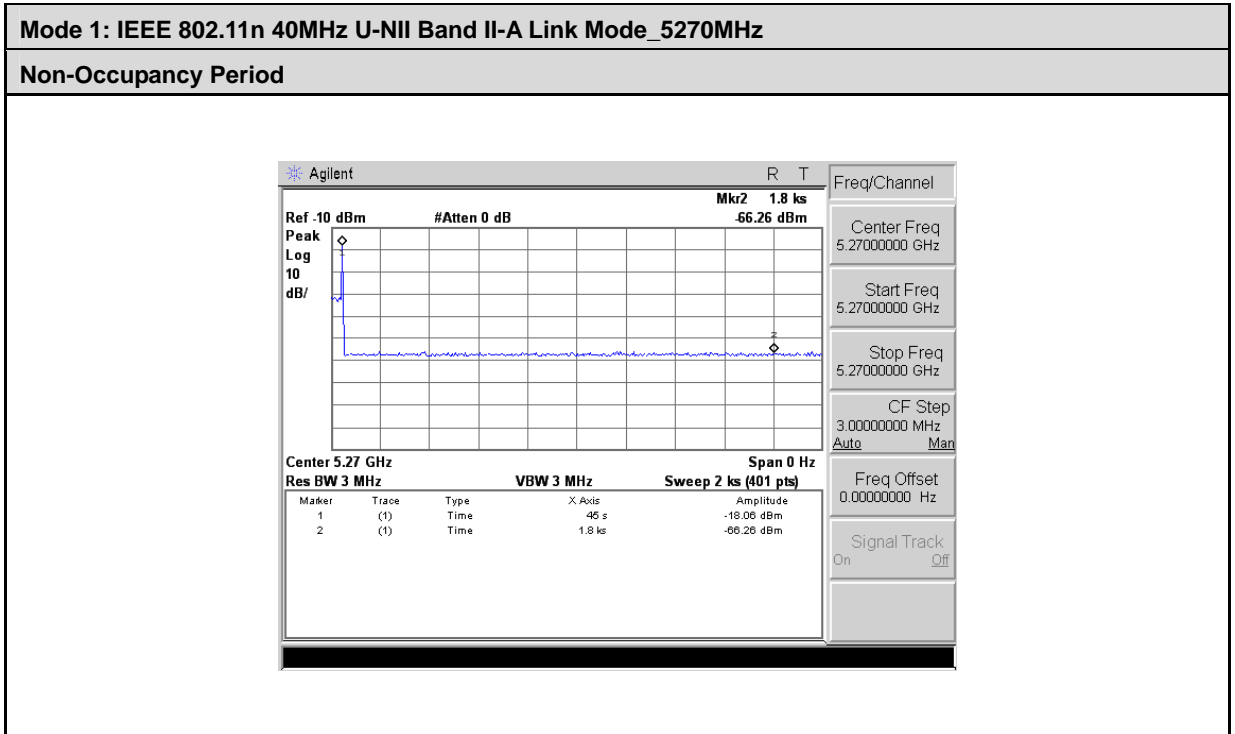

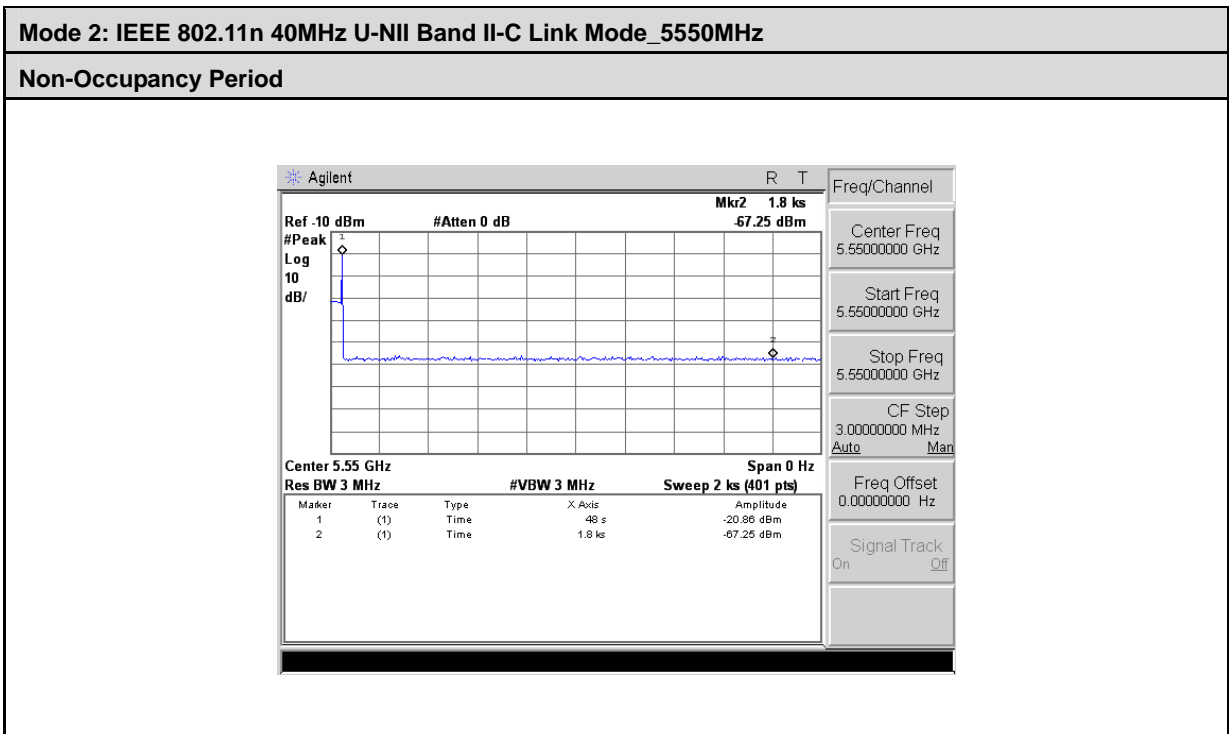
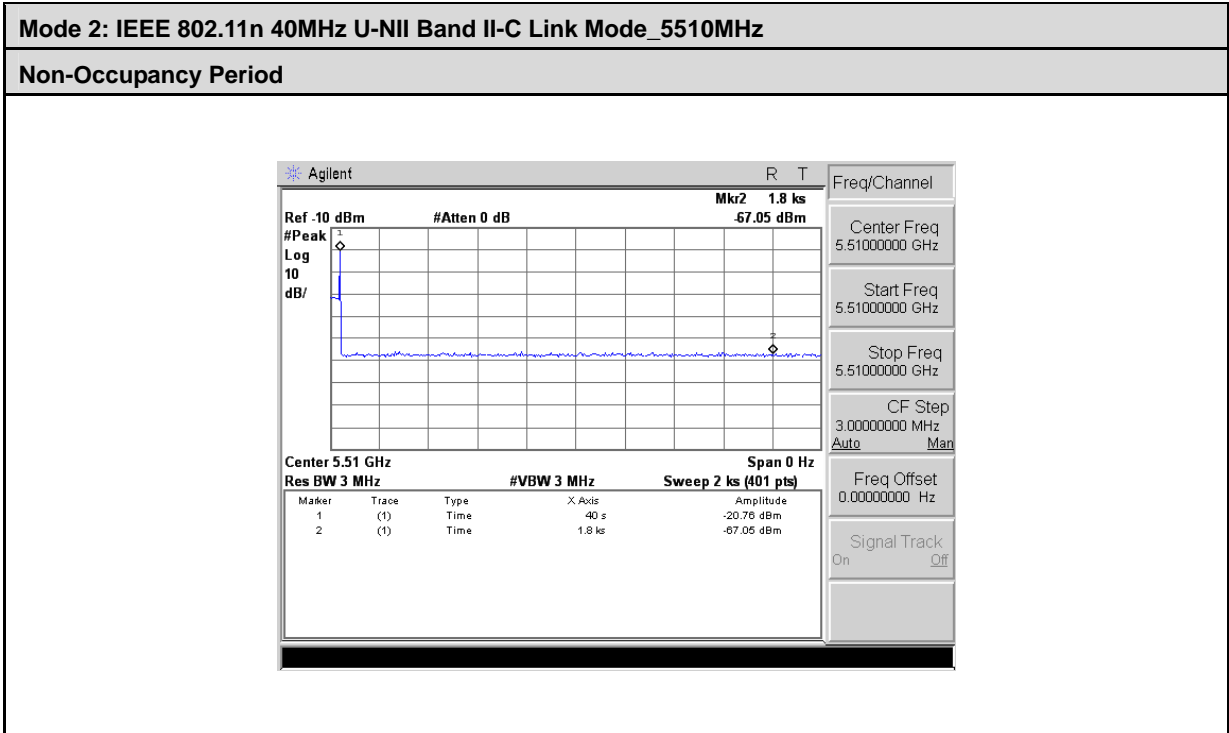

5.6. Detection Bandwidth

These tests are not applicable.

5.7. In-Service Monitoring

These tests are not applicable.