



MEASUREMENT REPORT

C2PC

FCC PART 15.407 WLAN 802.11a/n

FCC ID: YY3-14249-RF2
APPLICANT: HANDHELD GROUP AB
Application Type: Certification
Product: Nautiz X9
Model No.: 14249-RF2-N
Trade Mark **handheld**
FCC Classification: Unlicensed National Information Infrastructure (UNII)
FCC Rule Part(s): Part 15.407
Test Procedure(s): ANSI C63.10-2013, KDB 789033 D02v01r03
Test Date: January 24 ~ 30, 2018

Tested By : *Fran Chen*
(Fran Chen)
Reviewed By : *Paddy Chen*
(Paddy Chen)
Approved By : *Chenz Ker*
(Chenz Ker)



The test results relate only to the samples tested.

This equipment has been shown to be capable of compliance with the applicable technical standards as indicated in the measurement report and was tested in accordance with the measurement procedures specified in KDB 789033 D02v01r03. Test results reported herein relate only to the item(s) tested.

The test report shall not be reproduced except in full without the written approval of MRT Technology (Taiwan) Co., Ltd.

Revision History

Report No.	Version	Description	Issue Date	Note
1801TW1903-U6	1.0	Original Report	2018-02-06	

Note:

(1) This report is C2PC. The reason for variation is to remove the barcode scanner, other hardware is unchanged.

(2) The verification of this report is according to the worse case for Radiated spurious emission from the original report (Report No.: 1801TW1902-U6, Grant date: 2018/03/28).

CONTENTS

Description	Page
§2.1033 General Information	5
1. INTRODUCTION	6
1.1. Scope.....	6
1.2. MRT Test Location.....	6
2. PRODUCT INFORMATION	7
2.1. Equipment Description	7
2.2. Working Frequencies for this Report	8
2.3. Test Mode.....	8
2.4. Test Software.....	9
2.5. Test Configuration.....	9
2.6. EMI Suppression Device(s)/Modifications	9
2.7. Labeling Requirements	9
3. DESCRIPTION of TEST	10
3.1. Evaluation Procedure	10
3.2. AC Line Conducted Emissions	10
3.3. Radiated Emissions	11
4. ANTENNA REQUIREMENTS.....	12
5. TEST EQUIPMENT CALIBRATION DATE.....	13
6. MEASUREMENT UNCERTAINTY.....	14
7. TEST RESULT	15
7.1. Summary.....	15
7.2. 26dB Bandwidth Measurement	16
7.2.1. Test Limit.....	16
7.2.2. Test Procedure used	16
7.2.3. Test Setting	16
7.2.4. Test Setup.....	16
7.2.5. Test Result	17
7.3. 6dB Bandwidth Measurement	18
7.3.1. Test Limit.....	18
7.3.2. Test Procedure used	18
7.3.3. Test Setting	18
7.3.4. Test Setup.....	18
7.3.5. Test Result	19
7.4. Maximum Conducted Output Power Measurement	20
7.4.1. Test Limit.....	20
7.4.2. Test Procedure Used.....	20
7.4.3. Test Setting	20
7.4.4. Test Setup.....	20
7.4.5. Test Result of Output Power.....	21
7.5. Peak Power Spectral Density Measurement.....	22

7.5.1.	Test Limit	22
7.5.2.	Test Procedure Used	22
7.5.3.	Test Setting	22
7.5.4.	Test Setup	23
7.5.5.	Test Result	24
7.6.	Radiated Spurious Emission Measurement	25
7.6.1.	Test Limit	25
7.6.2.	Test Procedure Used	25
7.6.3.	Test Setting	25
7.6.4.	Test Setup	26
7.6.5.	Test Result	28
7.7.	Radiated Restricted Band Edge Measurement	34
7.7.1.	Test Limit	34
7.7.2.	Test Procedure Used	35
7.7.3.	Test Setting	35
7.7.4.	Test Setup	37
7.7.5.	Test Result	38
7.8.	AC Conducted Emissions Measurement	44
7.8.1.	Test Limit	44
7.8.2.	Test Setup	44
7.8.3.	Test Result	45
8.	CONCLUSION	46

§2.1033 General Information

Applicant	HANDHELD GROUP AB
Applicant Address	Kinnegatan 17 A ,531 33 Lidköping, Sweden
Manufacturer	HANDHELD GROUP AB
Manufacturer Address	Kinnegatan 17 A ,531 33 Lidköping, Sweden
Test Site	MRT Technology (Taiwan) Co., Ltd
Test Site Address	No. 38, Fuxing Second Rd., Guishan Dist., Taoyuan City 333, Taiwan (R.O.C)
MRT FCC Registration No.	291082
FCC Rule Part(s)	Part 15.407
Test Device Serial No.:	N/A <input type="checkbox"/> Production <input checked="" type="checkbox"/> Pre-Production <input type="checkbox"/> Engineering

Test Facility / Accreditations

1. MRT facility is a FCC registered (Reg. No. 291082) test facility with the site description report on file and is designated by the FCC as an Accredited Test Film.
2. MRT facility is an IC registered (MRT Reg. No. 21723-1) test laboratory with the site description on file at Industry Canada.
3. MRT Lab is accredited to ISO 17025 by the Taiwan Accreditation Foundation (TAF Cert. No. 3261) in EMC, Telecommunications and Radio testing for FCC (Designation Number: TW3261), Industry Taiwan, EU and TELEC Rules.

1. INTRODUCTION

1.1. Scope

Measurement and determination of electromagnetic emissions (EMC) of radio frequency devices including intentional and/or unintentional radiators for compliance with the technical rules and regulations of the Federal Communications Commission and the Industry Canada Certification and Engineering Bureau.

1.2. MRT Test Location

The map below shows the location of the MRT LABORATORY, its proximity to the Taoyuan City. These measurement tests were conducted at the MRT Technology (Taiwan) Co., Ltd. Facility located at No.38, Fuxing 2nd Rd., Guishan Dist., Taoyuan City 33377, Taiwan (R.O.C).

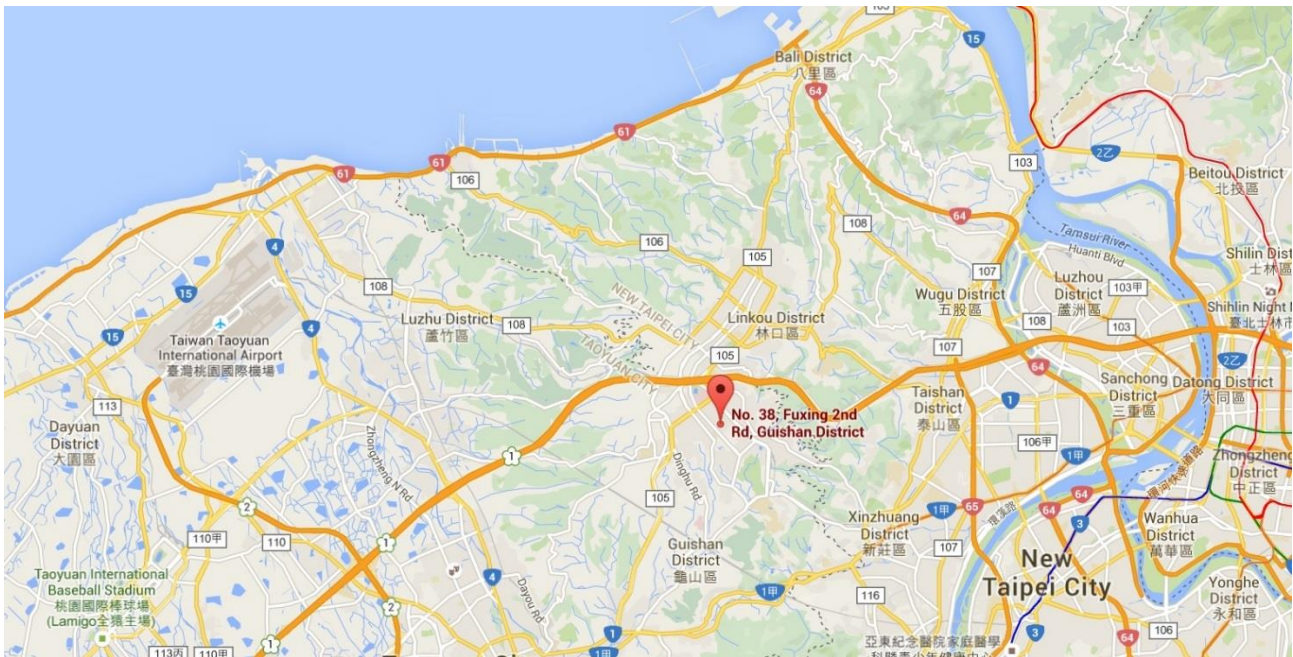

2. PRODUCT INFORMATION

2.1. Equipment Description

Product Name	Nautiz X9
Model No.	14249-RF2-N
Trade Mark	handheld
Supports Radios Spec.	WWAN: GSM/GPRS/EGPRS/WCDMA/HSPA/CDMA/EVDO/LTE WLAN: 2.4G: 802.11b/g/n-20/n-40; 5G: 802.11a/n-20/n-40 WPAN: Bluetooth/NFC
Wi-Fi Specification	802.11a/b/g/n
Frequency Range	<u>2.4GHz:</u> For 802.11b/g/n-20M: 2412 ~ 2462 MHz For 802.11n-40M: 2422 ~ 2452 MHz <u>5GHz:</u> For 802.11a/n-20M: 5180~5240MHz, 5745~5825MHz For 802.11n-40M: 5190~5230MHz, 5755~5795MHz
5GHz Maximum Output Power	802.11a: 10.32dBm 802.11n-20M: 10.31dBm 802.11n-40M: 8.95dBm
Type of Modulation	802.11a/n-20M/n-40M: OFDM, BPSK, QPSK, 16QAM, 64QAM

2.2. Working Frequencies for this Report

802.11a/n-20M

Channel	Frequency	Channel	Frequency	Channel	Frequency
36	5180 MHz	40	5200 MHz	44	5220 MHz
48	5240 MHz	--	--	--	--
149	5745 MHz	153	5765 MHz	157	5785 MHz
161	5805 MHz	165	5825 MHz	--	--

802.11n-40M

Channel	Frequency	Channel	Frequency	Channel	Frequency
38	5190 MHz	46	5230 MHz	--	--
151	5755 MHz	159	5795 MHz	--	--

2.3. Test Mode

Test Mode	Mode 1: Transmit by 802.11 n-40M
-----------	----------------------------------

Note: The test mode of worst case is Transmit by 802.11n-20M.

2.4. Test Software

The test utility software used during testing was “MTK Engineer Mode”.

2.5. Test Configuration

The **Nautiz X9, FCC ID: YY3-14249-RF2** was tested per the guidance of KDB 789033 D02v01r03. ANSI C63.10-2013 was used to reference the appropriate EUT setup for radiated spurious emissions testing and AC line conducted testing.

2.6. EMI Suppression Device(s)/Modifications

No EMI suppression device(s) were added and/or no modifications were made during testing.

2.7. Labeling Requirements

Per 2.1074 & 15.19; Docket 95-19

The label shall be permanently affixed at a conspicuous location on the device; instruction manual or pamphlet supplied to the user and be readily visible to the purchaser at the time of purchase. However, when the device is so small wherein placement of the label with specified statement is not practical, only the FCC ID must be displayed on the device per Section 15.19(a)(5). Please see attachment for FCC ID label and label location.

3. DESCRIPTION of TEST

3.1. Evaluation Procedure

The measurement procedures described in the American National Standard for Testing Unlicensed Wireless Devices (ANSI C63.10-2013), and the guidance provided in KDB 789033 D02v01r03 were used in the measurement of the **Nautiz X9, FCC ID: YY3-14249-RF2**.

Deviation from measurement procedure.....None

3.2. AC Line Conducted Emissions

The line-conducted facility is located inside an 9'x4'x3' shielded enclosure. A 1m x 2m wooden table 80cm high is placed 40cm away from the vertical wall and 80cm away from the sidewall of the shielded room. Two 10kHz-30MHz, 50Ω/50uH Line-Impedance Stabilization Networks (LISNs) are bonded to the shielded room floor. Power to the LISNs is filtered by external high-current high-insertion loss power line filters. These filters attenuate ambient signal noise from entering the measurement lines. These filters are also bonded to the shielded enclosure.

The EUT is powered from one LISN and the support equipment is powered from the second LISN. All interconnecting cables more than 1 meter were shortened to a 1 meter length by non-inductive bundling (serpentine fashion) and draped over the back edge of the test table. All cables were at least 40cm above the horizontal reference ground-plane. Power cables for support equipment were routed down to the second LISN while ensuring that that cables were not draped over the second LISN.

Sufficient time for the EUT, support equipment, and test equipment was allowed in order for them to warm up to their normal operating condition. The RF output of the LISN was connected to the receiver and exploratory measurements were made to determine the frequencies producing the maximum emission from the EUT. The receiver was scanned from 150kHz to 30MHz. The detector function was set to peak mode for exploratory measurements while the bandwidth of the analyzer was set to 9kHz. The EUT, support equipment, and interconnecting cables were arranged and manipulated to maximize each emission. Each emission was also maximized by varying: power lines, the mode of operation or data exchange speed, or support equipment which determined the worst-case emission. Once the worst case emissions have been identified, the one EUT cable configuration/arrangement and mode of operation that produced these emissions are used for final measurements on the same test site. The analyzer is set to CISPR quasi-peak and average detectors with a 9kHz resolution bandwidth for final measurements.

An extension cord was used to connect to a single LISN which powered by EUT. The extension cord was calibrated with LISN, the impedance and insertion loss are compliance with the requirements as stated in ANSI C63.10-2013.

Line conducted emissions test results are shown in Section 7.8.

3.3. Radiated Emissions

The radiated test facilities consisted of an indoor 3 meter semi-anechoic chamber used for final measurements and exploratory measurements, when necessary. The measurement area is contained within the semi-anechoic chamber which is shielded from any ambient interference. For measurements above 1GHz absorbers are arranged on the floor between the turn table and the antenna mast in such a way so as to maximize the reduction of reflections. For measurements below 1GHz, the absorbers are removed. A MF Model 210SS turntable is used for radiated measurement. It is a continuously rotatable, remote controlled, metallic turntable and 2 meters (6.56 ft.) in diameter. The turn table is flush with the raised floor of the chamber in order to maintain its function as a ground plane. An 80cm high PVC support structure is placed on top of the turntable.

For all measurements, the spectrum was scanned through all EUT azimuths and from 1 to 4 meter receive antenna height using a broadband antenna from 30MHz up to the upper frequency shown in 15.33(b)(1) depending on the highest frequency generated or used in the device or on which the device operates or tunes. For frequencies above 1GHz, linearly polarized double ridge horn antennas were used. For frequencies below 30MHz, a calibrated loop antenna was used. When exploratory measurements were necessary, they were performed at 1 meter test distance inside the semi-anechoic chamber using broadband antennas, broadband amplifiers, and spectrum analyzers to determine the frequencies and modes producing the maximum emissions. Sufficient time for the EUT, support equipment, and test equipment was allowed in order for them to warm up to their normal operating condition. The test set-up for frequencies below 1GHz was placed on top of the 0.8 meter high, 1 x 1.5 meter table; and test set-up for frequencies 1-40GHz was placed on top of the 1.5 meter high, 1 x 1.5 meter table. The EUT, support equipment, and interconnecting cables were arranged and manipulated to maximize each emission. Appropriate precaution was taken to ensure that all emissions from the EUT were maximized and investigated. The system configuration, clock speed, mode of operation or video resolution, if applicable, turntable azimuth, and receive antenna height was noted for each frequency found.

Final measurements were made in the semi-anechoic chamber using calibrated, linearly polarized broadband and horn antennas. The test setup was configured to the setup that produced the worst case emissions. The spectrum analyzer was set to investigate all frequencies required for testing to compare the highest radiated disturbances with respect to the specified limits. The turntable containing the EUT was rotated through 360 degrees and the height of the receive antenna was varied 1 to 4 meters and stopped at the azimuth and height producing the maximum emission. Each emission was maximized by changing the orientation of the EUT through three orthogonal planes and changing the polarity of the receive antenna, which produced the worst-case emissions. According to 3dB Beam-Width of horn antenna, the horn antenna should be always directed to the EUT when rising height.

Radiated emissions test results are shown in Section 7.6 & 7.7.

4. ANTENNA REQUIREMENTS

Excerpt from §15.203 of the FCC Rules/Regulations:

“An intentional radiator antenna shall be designed to ensure that no antenna other than that furnished by the responsible party can be used with the device. The use of a permanently attached antenna or of an antenna that uses a unique coupling to the intentional radiator shall be considered sufficient to comply with the provisions of this section.”

- The antenna of the **Nautiz X9**, is permanently attached.
- There are no provisions for connection to an external antenna.

Conclusion:

The **Nautiz X9, FCC ID: YY3-14249-RF2** unit complies with the requirement of §15.203.

Antenna List

No.	Manufacturer	Part No.	Antenna Type	Peak Gain
1	N/A	AP316-DB_V1	FPC	0.31dBi for 5150MHz~5250MHz 1.07dBi for 5725MHz~5850MHz

5. TEST EQUIPMENT CALIBRATION DATE

Conducted Emissions – SR2

Instrument	Manufacturer	Type No.	Asset No.	Cali. Interval	Cali. Due Date
Two-Line V-Network	R&S	ENV216	MRTTWA00019	1 year	2018.03.15
Cable	Rosnol	N1C50-RG400-B 1C50-500CM	MRTTWE00013	1 year	2018.05.19
EMI Test Receiver	R&S	ESR3	MRTTWA00009	1 year	2018.03.16

Radiated Emissions – AC1

Instrument	Manufacturer	Type No.	Asset No.	Cali. Interval	Cali. Due Date
Broadband TRILOG Antenna	SCHWARZBECK	VULB 9162	MRTTWA00001	1 year	2018.05.14
EMI Test Receiver	R&S	ESR3	MRTTWA00009	1 year	2018.03.16
Active Loop Antenna	Schwarzbeck	FMZB 1519B	MRTTWA00002	1 year	2018.04.13
Broadband Horn antenna	SCHWARZBECK	BBHA 9120D	MRTTWA00003	1 year	2018.04.17
Breitband Hornantenna	Schwarzbeck	BBHA 9170	MRTTWA00004	1 year	2018.04.24
Broadband Amplifier	Schwarzbeck	BBV 9721	MRTTWA00006	1 year	2018.04.24
Broadband Preampfier	SCHWARZBECK	BBV 9718	MRTTWA00005	1 year	2018.04.19
Cable	HUBERSUHNER	SF106	MRTTWA00010	1 year	2018.05.19
Cable	Rosnol	K1K50-UP0264- K1K50-4M	MRTTWA00012	1 year	2018.05.19

Conducted Test Equipment – SR2

Instrument	Manufacturer	Type No.	Asset No.	Cali. Interval	Cali. Due Date
Spectrum Analyzer	KEYSIGHT	N9010A	MRTTWA00012	1 year	2018.07.24
USB Wideband Power Sensor	KEYSIGHT	U2021XA	MRTTWA00015	1 year	2018.03.19

Test Software

Software	Version	Function
e3	9.160520a	EMI Test Software
EMI	V3	EMI Test Software

6. MEASUREMENT UNCERTAINTY

Where relevant, the following test uncertainty levels have been estimated for tests performed on the EUT as specified in CISPR 16-4-2. This uncertainty represents an expanded uncertainty expressed at approximately the 95% confidence level using a coverage factor of $k = 2$.

AC Conducted Emission Measurement – SR2
Measuring Uncertainty for a Level of Confidence of 95% ($U=2Uc(y)$): 150kHz~30MHz: 2.42dB
Conducted Measurement– SR1
Measuring Uncertainty for a Level of Confidence of 95% ($U=2Uc(y)$): 1.3dB
Radiated Emission Measurement – AC1
Measuring Uncertainty for a Level of Confidence of 95% ($U=2Uc(y)$): 4.22dB

7. TEST RESULT

7.1. Summary

Product Name: Nautiz X9

FCC Classification: Unlicensed National Information Infrastructure (UNII)

Data Rate(s) Tested: 6Mbps ~ 54Mbps (a);

6.5/7.2Mbps ~ 65/72.2Mbps (n-20M);

13.5/15Mbps ~ 135/150Mbps (n-40M);

FCC Section(s)	Test Description	Test Limit	Test Condition	Test Result	Reference
15.407(a)	26dB Bandwidth	N/A	Conducted	N/A	Original Report No.:1801TW1902-U6
15.407(e)	6dB Bandwidth	$\geq 500\text{kHz}$		N/A	Original Report No.:1801TW1902-U6
15.407 (a)(1)(2)(3)	Maximum Conducted Output Power	$\leq 24 \text{ dBm (U-NII-1)}$ $\leq 30 \text{ dBm (U-NII-3)}$		Pass	Section 7.4
15.407 (a)(1)(2)(3)(5)	Peak Power Spectral Density	$\leq 11 \text{ dBm/MHz (U-NII-1)}$ $\leq 30 \text{ dBm/500kHz (U-NII-3)}$		N/A	Original Report No.:1801TW1902-U6
15.407(b)(1),(4)	Undesirable Emissions	$\leq -27\text{dBm/MHz EIRP}$ $\leq -17\text{dBm/MHz EIRP}$	Radiated	Pass	Section 7.6 & 7.7
15.205, 15.209 15.407(b)(5), (6), (7)	General Field Strength Limits (Restricted Bands and Radiated Emission Limits)	Emissions in restricted bands must meet the radiated limits detailed in 15.209		Pass	
15.207	AC Conducted Emissions 150kHz - 30MHz	< FCC 15.207 limits	Line Conducted	N/A	Original Report No.:1801TW1902-U6

Notes:

- 1) All modes of operation and data rates were investigated. For radiated emission test, every axis (X, Y, Z) was also verified. The test results shown in the following sections represent the worst case emissions.
- 2) The analyzer plots shown in this section were all taken with a correction table loaded into the analyzer. The correction table was used to account for the losses of the cables and attenuators used as part of the system to connect the EUT to the analyzer at all frequencies of interest.
- 3) All antenna port conducted emissions testing was performed on a test bench with the antenna port of the EUT connected to the spectrum analyzer through calibrated cables and attenuators.

7.2. 26dB Bandwidth Measurement

7.2.1. Test Limit

N/A

7.2.2. Test Procedure used

KDB 789033 D02v01r03- Section C.1

7.2.3. Test Setting

1. The analyzers' automatic bandwidth measurement capability was used to perform the 26dB bandwidth measurement. The "X" dB bandwidth parameter was set to $X = 26$. The automatic bandwidth measurement function also has the capability of simultaneously measuring the 99% occupied bandwidth. The bandwidth measurement was not influenced by any intermediated power nulls in the fundamental emission.
2. RBW = approximately 1% of the emission bandwidth.
3. VBW $\geq 3 \times$ RBW.
4. Detector = Peak.
5. Trace mode = max hold.
6. Sweep = auto couple
7. Allow the trace was allowed to stabilize

7.2.4. Test Setup

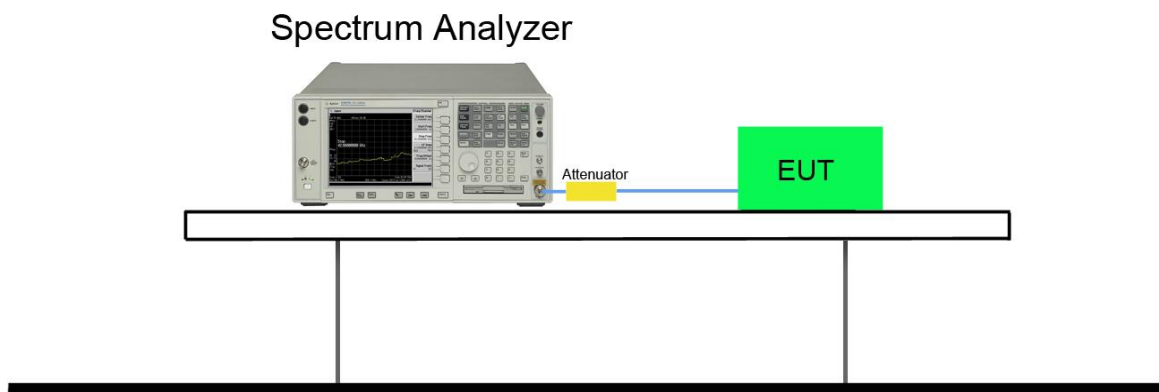

7.2.5. Test Result

Refer to the original report No.: 1801TW1902-U6.

7.3. 6dB Bandwidth Measurement

7.3.1. Test Limit

Within the 5.725-5.85 GHz band, the minimum 6 dB bandwidth of U-NII devices shall be at least 500 kHz.

7.3.2. Test Procedure used

KDB 789033 D02v01r03- Section C.2

7.3.3. Test Setting

1. Set center frequency to the nominal EUT channel center frequency.
2. RBW = 100 kHz.
3. VBW $\geq 3 \times$ RBW.
4. Detector = Peak.
5. Trace mode = max hold.
6. Sweep = auto couple
7. Allow the trace was allowed to stabilize
8. Measure the maximum width of the emission that is constrained by the frequencies associated with the two outermost amplitude points (upper and lower frequencies) that are attenuated by 6 dB relative to the maximum level measured in the fundamental emission.

7.3.4. Test Setup

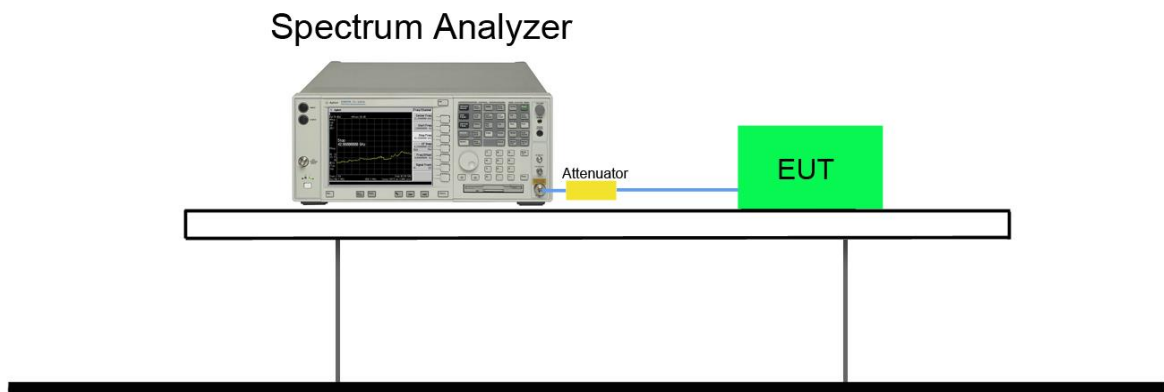

7.3.5. Test Result

Refer to the original report No.: 1801TW1902-U6.

7.4. Maximum Conducted Output Power Measurement

7.4.1. Test Limit

For client devices in the 5.15-5.25 GHz band, the maximum conducted output power over the frequency band of operation shall not exceed 250 mW (24dBm).

For the band 5.725-5.85 GHz, the maximum conducted output power over the frequency band of operation shall not exceed 1 W (30dBm).

7.4.2. Test Procedure Used

KDB 789033 D02v01r03 - Section E) 3) b) Method PM-G

7.4.3. Test Setting

Average Power Measurement

Average power measurements were performed only when the EUT was transmitting at its maximum power control level using a broadband power meter with a pulse sensor. The power meter implemented triggering and gating capabilities which were set up such that power measurements were recorded only during the ON time of the transmitter. The trace was averaged over 100 traces to obtain the final measured average power.

7.4.4. Test Setup



7.4.5. Test Result of Output Power

5GHz 802.11a RF Output Power (dBm)										
Channel No.	Frequency (MHz)	Average Power For different Data Rate (Mbps)								Required Limit
		6	9	12	18	24	36	48	54	
36	5180	--	--	--	--	--	--	--	9.92	24 dBm
44	5220	9.89	9.82	9.91	9.95	9.88	9.85	9.81	10.02	24 dBm
48	5240	--	--	--	--	--	--	--	9.94	24 dBm
149	5745	--	--	--	--	--	--	--	8.87	30 dBm
157	5785	8.79	8.85	8.78	8.88	8.72	8.87	8.92	8.98	30 dBm
165	5825	--	--	--	--	--	--	--	9.01	30 dBm

5GHz 802.11n-20M RF Output Power (dBm)										
Channel No.	Frequency (MHz)	Average Power For different Data Rate (Mbps)								Required Limit
		MCS0	MCS1	MCS2	MCS3	MCS4	MCS5	MCS6	MCS7	
36	5180	--	--	--	--	--	--	--	9.79	24 dBm
44	5220	9.75	9.81	9.77	9.94	9.88	9.96	10.05	10.15	24 dBm
48	5240	--	--	--	--	--	--	--	10.08	24 dBm
149	5745	--	--	--	--	--	--	--	7.79	30 dBm
157	5785	7.49	7.68	7.70	7.79	7.71	7.73	7.77	8.19	30 dBm
165	5825	--	--	--	--	--	--	--	8.14	30 dBm

5GHz 802.11n-40M RF Output Power (dBm)										
Channel No.	Frequency (MHz)	Average Power For different Data Rate (Mbps)								Required Limit
		MCS0	MCS1	MCS2	MCS3	MCS4	MCS5	MCS6	MCS7	
38	5190	8.94	--	--	--	--	--	--	--	24 dBm
46	5230	9.17	9.01	9.13	9.07	8.94	8.91	8.87	8.95	24 dBm
151	5755	8.19	8.02	7.96	7.93	7.99	7.87	7.79	7.83	30 dBm
159	5795	7.76	--	--	--	--	--	--	--	30 dBm

Note: Output power = Reading value on power meter + cable loss ◦

7.5. Peak Power Spectral Density Measurement

7.5.1. Test Limit

For the band 5.15-5.25 GHz, the maximum permissible power spectral density is 11dBm/MHz.

For the band 5.725-5.85 GHz, the maximum permissible power spectral density is 30dBm/500kHz.

7.5.2. Test Procedure Used

KDB 789033 D02v01r03 – Section F

7.5.3. Test Setting

1. Analyzer was set to the center frequency of the UNII channel under investigation
2. Span was set to encompass the entire 26dB EBW of the signal.
3. RBW = 1MHz, if measurement bandwidth of Maximum PSD is specified in 500 kHz,
RBW = 100 kHz
4. VBW = 3MHz
5. Number of sweep points $\geq 2 \times (\text{span} / \text{RBW})$
6. Detector = power averaging (Average)
7. Sweep time = auto
8. Trigger = free run/
9. Use the peak search function on the instrument to find the peak of the spectrum and record its value.
10. Add $10 \cdot \log(1/x)$, where x is the duty cycle, to the measured power in order to compute the average power during the actual transmission times (because the measurement represents an average over both the on and off times of the transmission). For example, add $10 \cdot \log(1/0.25) = 6$ dB if the duty cycle is 25 percent.
11. When the measurement bandwidth of Maximum PSD is specified in 500 kHz, add a constant factor $10 \cdot \log(500\text{kHz}/100\text{kHz}) = 7$ dB to the measured result

7.5.4. Test Setup

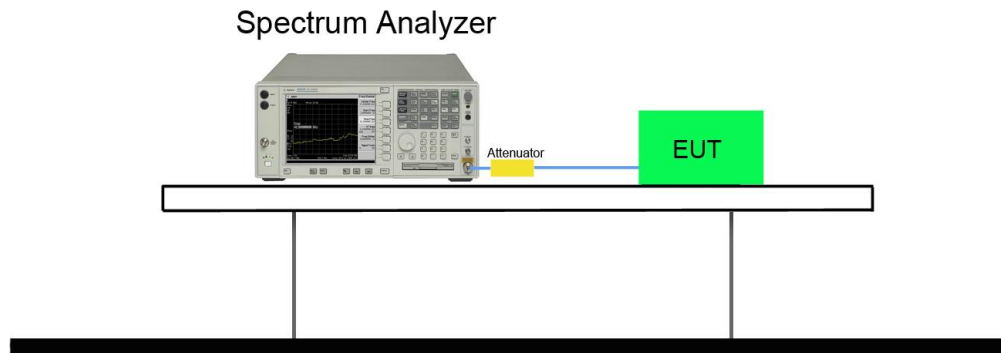

7.5.5. Test Result

Refer to the original report No.: 1801TW1902-U6.

7.6. Radiated Spurious Emission Measurement

7.6.1. Test Limit

All out of band emissions appearing in a restricted band as specified in Section 15.205 of the Title 47 CFR must not exceed the limits shown in Table per Section 15.209.

FCC Part 15 Subpart C Paragraph 15.209		
Frequency [MHz]	Field Strength [V/m]	Measured Distance [Meters]
0.009 - 0.490	2400/F (kHz)	300
0.490 - 1.705	24000/F (kHz)	30
1.705 - 30	30	30
30 - 88	100	3
88 - 216	150	3
216 - 960	200	3
Above 960	500	3

7.6.2. Test Procedure Used

KDB 789033 D02v01r03- Section G

7.6.3. Test Setting

Peak Measurements above 1GHz

1. Analyzer center frequency was set to the frequency of the radiated spurious emission of interest
2. RBW = 1MHz
3. VBW = 3MHz
4. Detector = peak
5. Sweep time = auto couple
6. Trace mode = max hold
7. Trace was allowed to stabilize

Quasi-Peak Measurements below 1GHz

1. Analyzer center frequency was set to the frequency of the radiated spurious emission of interest
2. Span was set greater than 1MHz
3. RBW = 120 kHz
4. Detector = CISPR quasi-peak
5. Sweep time = auto couple
6. Trace was allowed to stabilize

Average Measurements above 1GHz (Method AD)

1. Analyzer center frequency was set to the frequency of the radiated spurious emission of interest
2. RBW = 1MHz
3. VBW = 3MHz
4. Detector = power average (Average)
5. Number of measurement points = 1001 (Number of points must be $> 2 \times \text{span}/\text{RBW}$)
6. Sweep time = auto
7. Trace was averaged over at 100 sweeps

7.6.4. Test Setup

9kHz ~ 30MHz Test Setup:

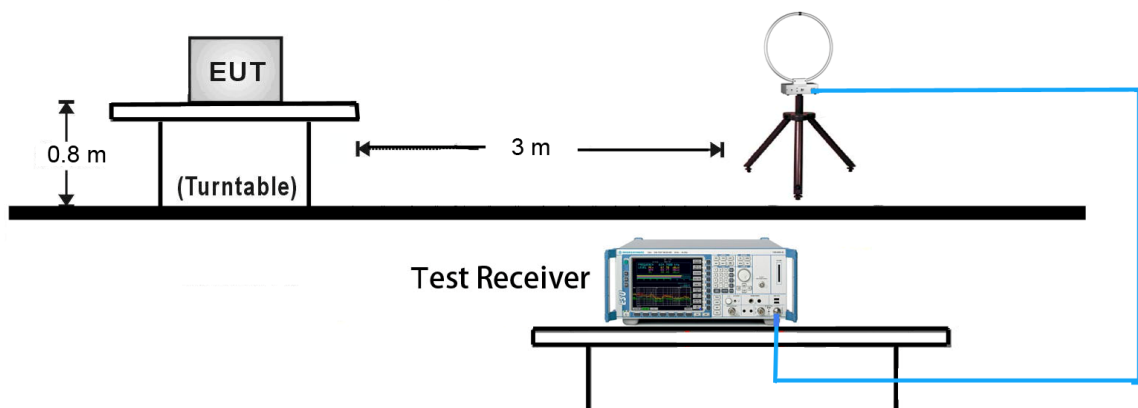

30MHz ~ 1GHz Test Setup:

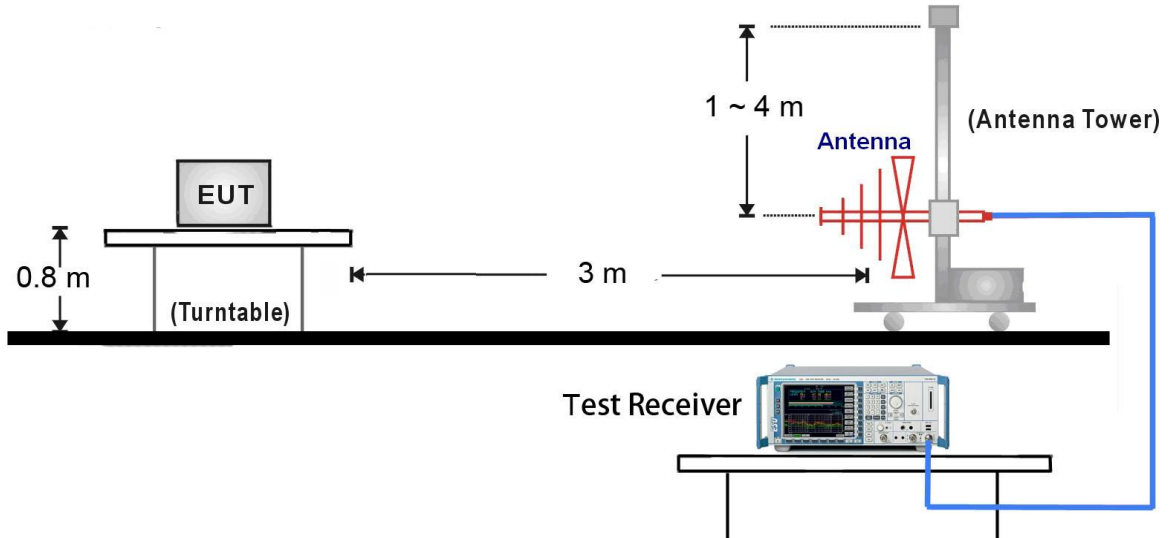

1GHz ~ 18GHz Test Setup:

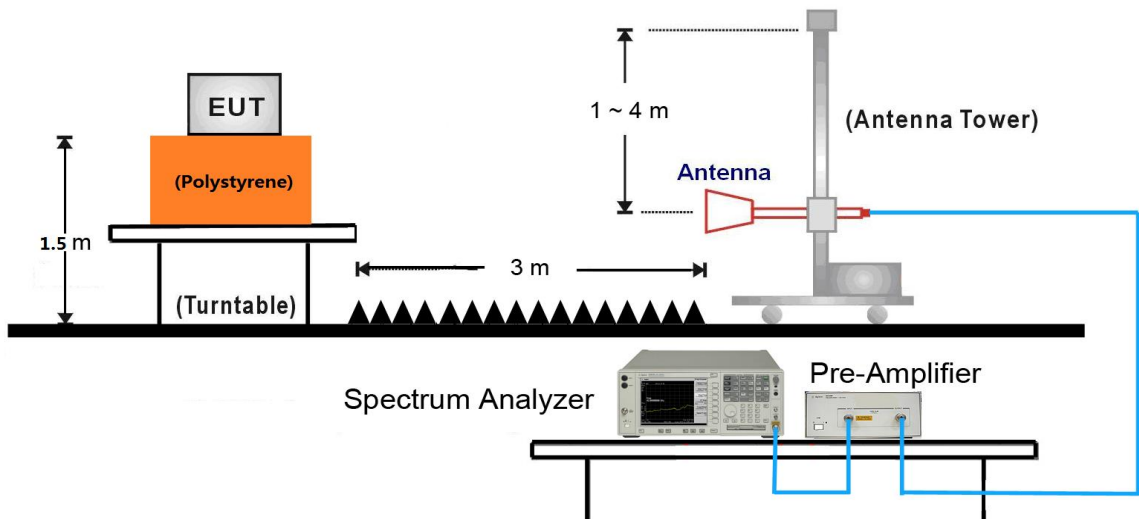

18GHz ~40GHz Test Setup:

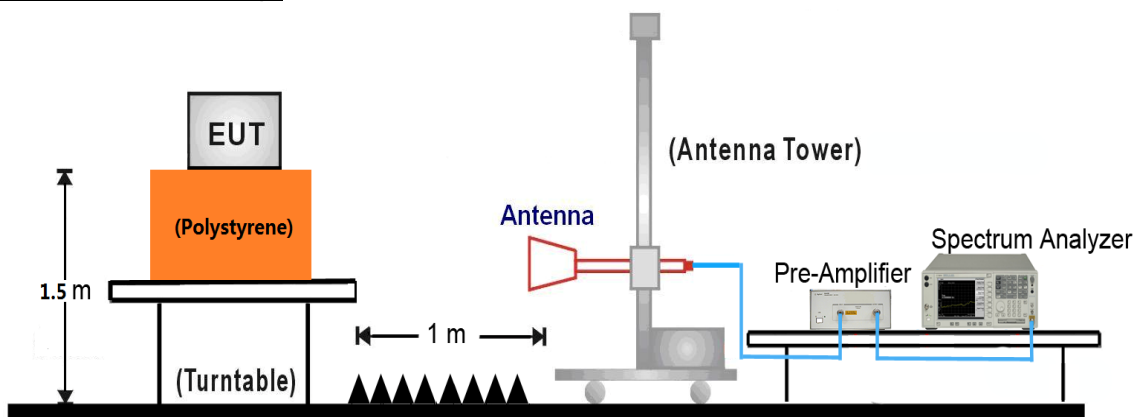

7.6.5. Test Result

EUT	14249-RF2-N	Date of Test	2018/01/24
Factor	VULB 9162 (30MHz~8GHz)	Temp. / Humidity	25°C / 60%
Polarity	Horizontal	Site / Test Engineer	AC1 / Fran
Test Mode	Mode1	Test Voltage	By Battery

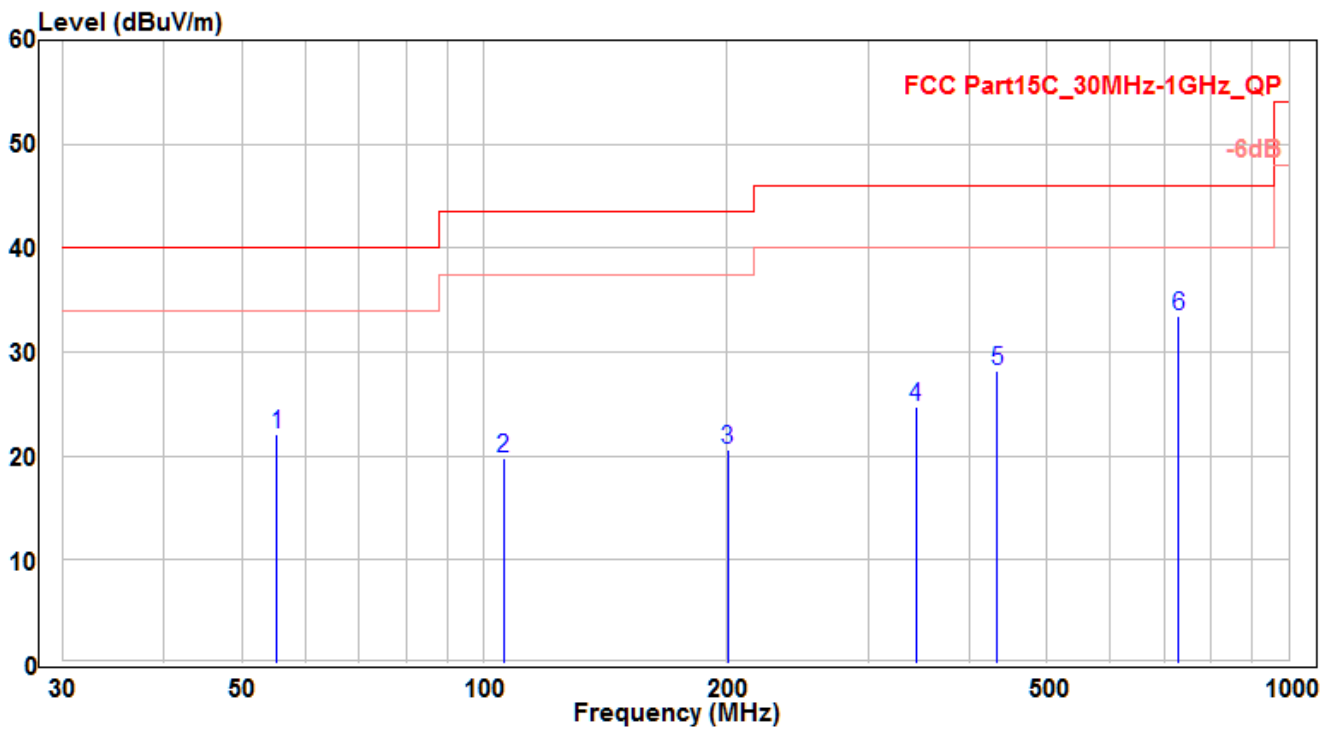

No	Frequency (MHz)	Reading (dBUV)	C.F (dB)	Measurement (dBUV/m)	Margin (dB)	Limit (dBUV)	Height (cm)	Angle (deg)	Remark (QP/PK/AV)
1	55.281	1.43	20.63	22.06	-17.94	40	100	400	QP
2	105.721	0.76	19.06	19.82	-23.68	43.5	160	320	QP
3	200.629	1.51	19.12	20.63	-22.87	43.5	115	20	QP
4	344.371	1.38	23.29	24.67	-21.33	46	175	125	QP
5	433.975	3.39	24.79	28.18	-17.82	46	100	-40	QP
6	* 728.612	3.48	29.93	33.41	-12.59	46	200	200	QP

Note :

1. " * " means the worst value in this measurement data ◦
2. Measure Level (dBUV/m) = Reading Level (dBUV) + Factor (dB) ◦
3. Factor (dB) = Cable Loss (dB) + Antenna Factor (dB/m) ◦
4. The emission levels of other frequencies are very lower than the limit and not show in test report ◦
5. Other channel/mode was also verified. The test results shown represent the worst case emissions ◦
6. No emission found between lowest internal used/generated frequency to 30MHz ◦

EUT	14249-RF2-N	Date of Test	2018/01/24
Factor	VULB 9162 (30MHz~8GHz)	Temp. / Humidity	25°C / 60%
Polarity	Vertical	Site / Test Engineer	AC1 / Fran
Test Mode	Mode1	Test Voltage	By Battery

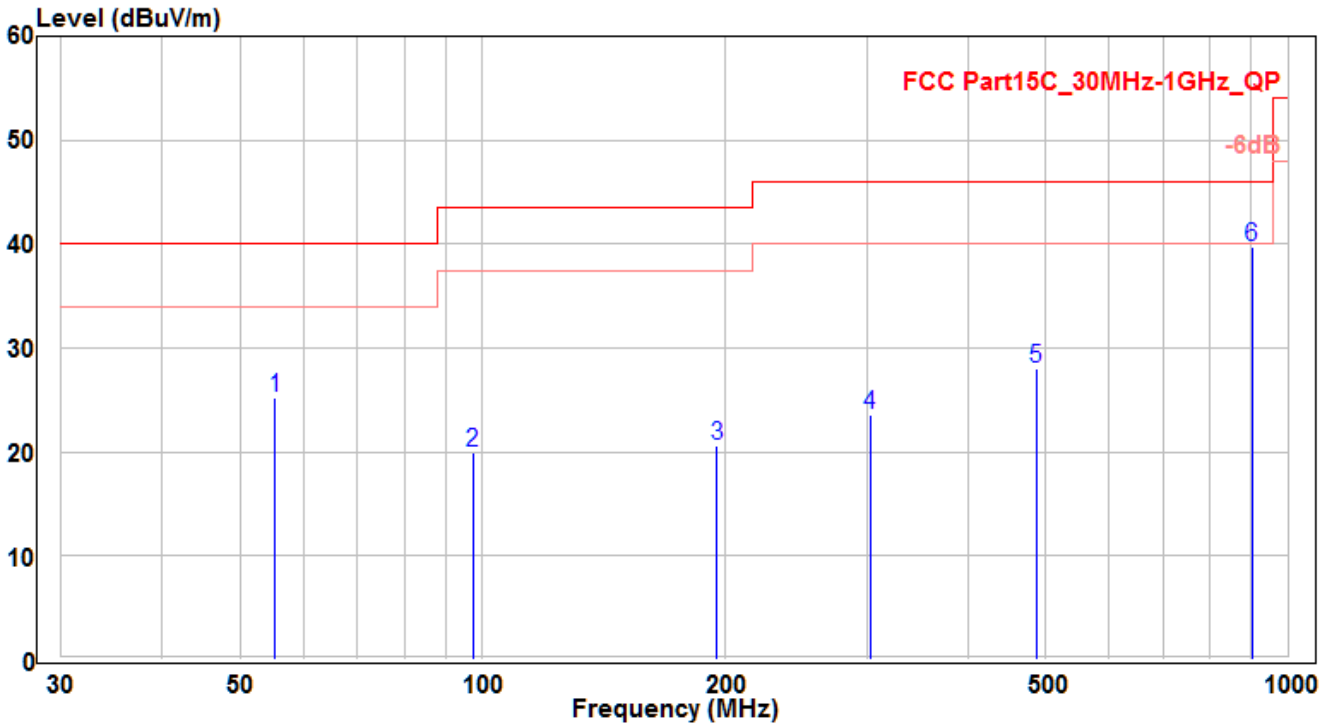

No	Frequency (MHz)	Reading (dBUV)	C.F (dB)	Measurement (dBUV/m)	Margin (dB)	Limit (dBUV)	Height (cm)	Angle (deg)	Remark (QP/PK/AV)
1	55.281	4.52	20.63	25.15	-14.85	40	100	400	QP
2	97.263	1.21	18.79	20	-23.5	43.5	120	50	QP
3	195.355	1.65	18.99	20.64	-22.86	43.5	150	360	QP
4	302.6	2.09	21.51	23.6	-22.4	46	175	175	QP
5	486.688	2.18	25.92	28.1	-17.9	46	190	250	QP
6	* 902.424	7.69	31.97	39.66	-6.34	46	145	125	QP

Note :

- " * " means the worst value in this measurement data °
- Measure Level (dBUV/m) = Reading Level (dBUV) + Factor (dB) °
- Factor (dB) = Cable Loss (dB) + Antenna Factor (dB/m) °
- The emission levels of other frequencies are very lower than the limit and not show in test report °
- Other channel/mode was also verified. The test results shown represent the worst case emissions °
- No emission found between lowest internal used/generated frequency to 30MHz °

EUT	14249-RF2-N	Test Date	2018/01/25
Factor	BBHA 9120D (1GHz~18GHz)	Temp. / Humidity	25°C / 60%
Polarity	Horizontal	Site / Engineer	AC1 / Fran
Test Mode	MODE1-CH38	Test Voltage	By Battery

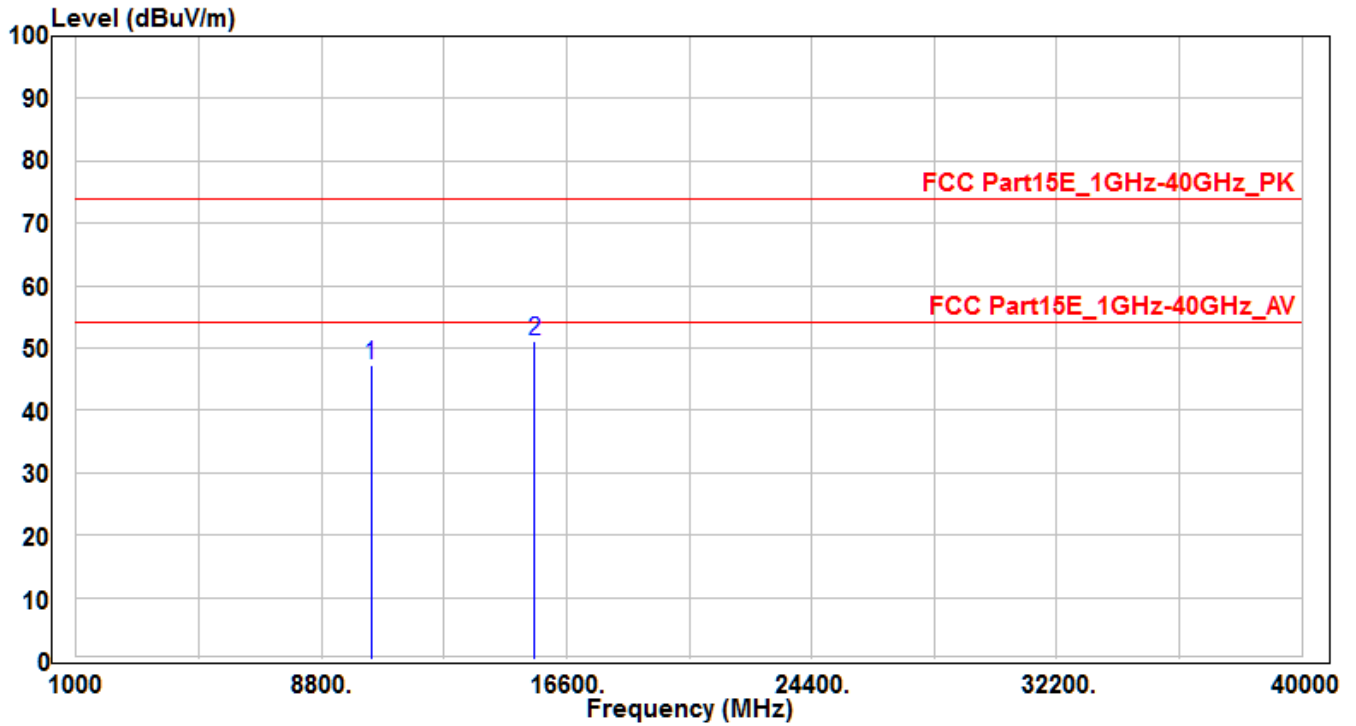

No	Frequency (MHz)	Reading (dBuV)	C.F (dB)	Measurement (dBuV/m)	Margin (dB)	Limit (dBuV)	Height (cm)	Angle (deg)	Remark (QP/PK/AV)
1	10380	30.4	16.82	47.22	-26.78	74	150	400	Peak
2	* 15570	30.13	20.96	51.09	-22.91	74	150	400	Peak

Note :

1. " * " means the worst value in this measurement data °
2. Measure Level (dBuV/m) = Reading Level (dBuV) + Factor (dB) °
3. Factor (dB) = Cable Loss (dB) + Antenna Factor (dB/m) °
4. The emission levels of other frequencies are very lower than the limit and not show in test report °

EUT	14249-RF2-N	Test Date	2018/01/25
Factor	BBHA 9120D (1GHz~18GHz)	Temp. / Humidity	25°C / 60%
Polarity	Vertical	Site / Engineer	AC1 / Fran
Test Mode	MODE1-CH38	Test Voltage	By Battery

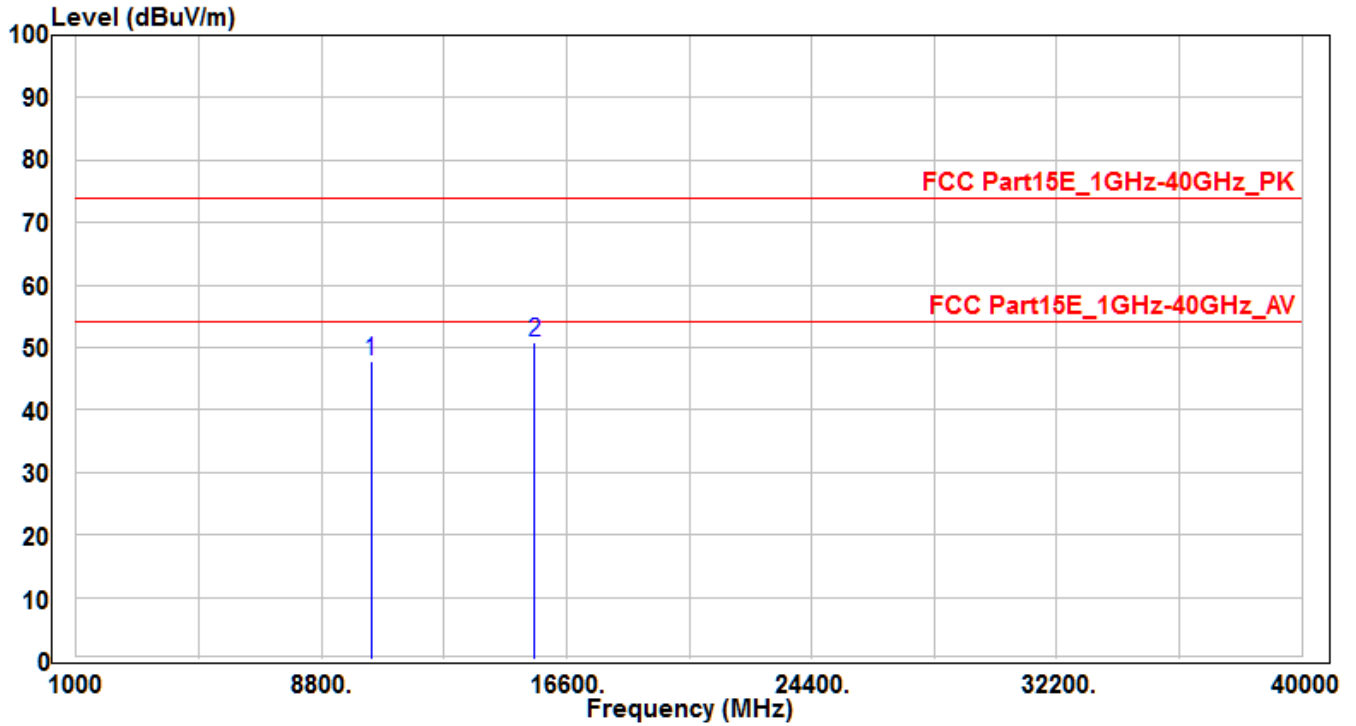

No	Frequency (MHz)	Reading (dBuV)	C.F (dB)	Measurement (dBuV/m)	Margin (dB)	Limit (dBuV)	Height (cm)	Angle (deg)	Remark (QP/PK/AV)
1	10380	30.94	16.82	47.76	-26.24	74	150	400	Peak
2	* 15570	29.9	20.96	50.86	-23.14	74	150	400	Peak

Note :

1. " * " means the worst value in this measurement data ◦
2. Measure Level (dBuV/m) = Reading Level (dBuV) + Factor (dB) ◦
3. Factor (dB) = Cable Loss (dB) + Antenna Factor (dB/m) ◦
4. The emission levels of other frequencies are very lower than the limit and not show in test report ◦

EUT	14249-RF2-N	Test Date	2018/01/25
Factor	BBHA 9120D (1GHz~18GHz)	Temp. / Humidity	25°C / 60%
Polarity	Horizontal	Site / Engineer	AC1 / Fran
Test Mode	MODE1-CH151	Test Voltage	By Battery

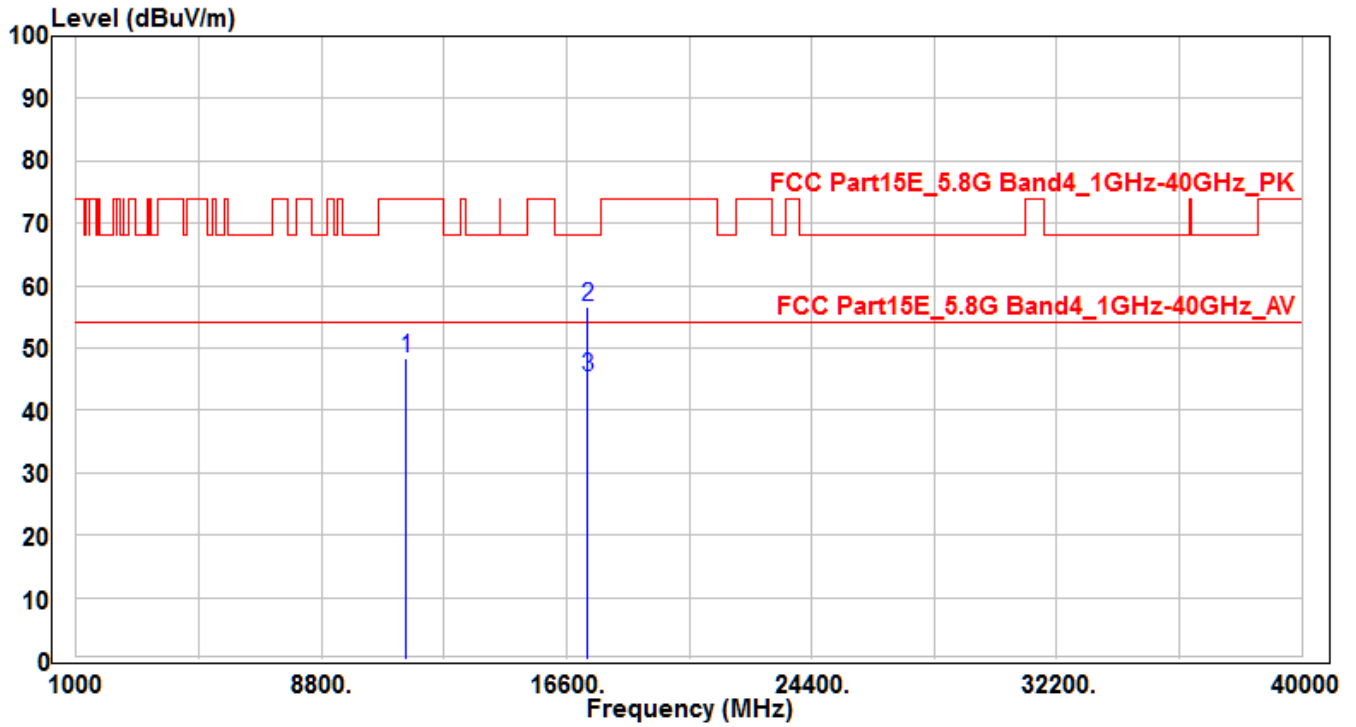

No	Frequency (MHz)	Reading (dBuV)	C.F (dB)	Measurement (dBuV/m)	Margin (dB)	Limit (dBuV)	Height (cm)	Angle (deg)	Remark (QP/PK/AV)
1	11510	30.03	18.34	48.37	-25.63	74	150	400	Peak
2	*	17265	27.19	56.7	-11.5	68.2	150	400	Peak
3	*	17265	27.19	45.29	-8.71	54	150	400	Average

Note :

- " * " means the worst value in this measurement data ◦
- Measure Level (dBuV/m) = Reading Level (dBuV) + Factor (dB) ◦
- Factor (dB) = Cable Loss (dB) + Antenna Factor (dB/m) ◦
- The emission levels of other frequencies are very lower than the limit and not show in test report ◦

EUT	14249-RF2-N	Test Date	2018/01/25
Factor	BBHA 9120D (1GHz~18GHz)	Temp. / Humidity	25°C / 60%
Polarity	Vertical	Site / Engineer	AC1 / Fran
Test Mode	MODE1-CH151	Test Voltage	By Battery

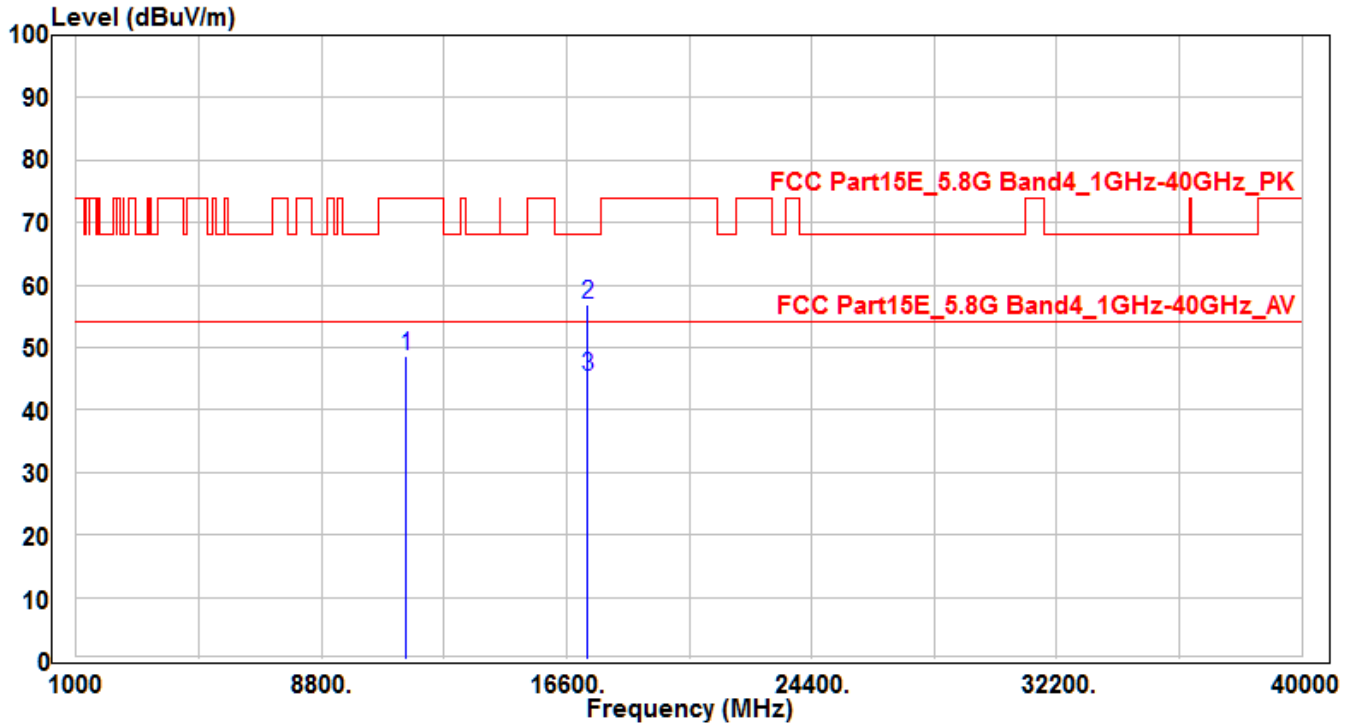

No	Frequency (MHz)	Reading (dBuV)	C.F (dB)	Measurement (dBuV/m)	Margin (dB)	Limit (dBuV)	Height (cm)	Angle (deg)	Remark (QP/PK/AV)
1	11510	30.42	18.34	48.76	-25.24	74	150	400	Peak
2	* 17265	29.8	27.19	56.99	-11.21	68.2	150	400	Peak
3	* 17265	18.15	27.19	45.34	-8.66	54	150	400	Average

Note :

1. " * " means the worst value in this measurement data °
2. Measure Level (dBuV/m) = Reading Level (dBuV) + Factor (dB) °
3. Factor (dB) = Cable Loss (dB) + Antenna Factor (dB/m) °
4. The emission levels of other frequencies are very lower than the limit and not show in test report °

7.7. Radiated Restricted Band Edge Measurement

7.7.1. Test Limit

For 15.205 requirement:

Radiated emissions which fall in the restricted bands, as defined in Section 15.205(a) of FCC part 15, must also comply with the radiated emission limits specified in Section 15.209(a).

Frequency (MHz)	Frequency (MHz)	Frequency (MHz)	Frequency (GHz)
0.090 - 0.110	16.42 - 16.423	399.9 - 410	4.5 - 5.15
¹ 0.495 - 0.505	16.69475 - 16.69525	608 - 614	5.35 - 5.46
2.1735 - 2.1905	16.80425 - 16.80475	960 - 1240	7.25 - 7.75
4.125 - 4.128	25.5 - 25.67	1300 - 1427	8.25 - 8.5
4.17725 - 4.17775	37.5 - 38.25	1435 - 1626.5	9.0 - 9.2
4.20725 - 4.20775	73 - 74.6	1645.5 - 1646.5	9.3 - 9.5
6.215 - 6.218	74.8 - 75.2	1660 - 1710	10.6 - 12.7
6.26775 - 6.26825	108 - 121.94	1718.8 - 1722.2	13.25 - 13.4
6.31175 - 6.31225	123 - 138	2200 - 2300	14.47 - 14.5
8.291 - 8.294	149.9 - 150.05	2310 - 2390	15.35 - 16.2
8.362 - 8.366	156.52475 - 156.525	2483.5 - 2500	17.7 - 21.4
8.37625 - 8.38675	156.7 - 156.9	2690 - 2900	22.01 - 23.12
8.41425 - 8.41475	162.0125 - 167.17	3260 - 3267	23.6 - 24.0
12.29 - 12.293	167.72 - 173.2	3332 - 3339	31.2 - 31.8
12.51975 - 12.52025	240 - 285	3345.8 - 3358	36.43 - 36.5
12.57675 - 12.57725	322 - 335.4	3600 - 4400	(²)
13.36 - 13.41	--	--	--

For 15.407(b) requirement:

For transmitters operating in the 5.725-5.85 GHz band: All emissions within the frequency range from the band edge to 10 MHz above or below the band edge shall not exceed an e.i.r.p. of -17 dBm/MHz; for frequencies 10 MHz or greater above or below the band edge, emissions shall not exceed an e.i.r.p. of -27 dBm/MHz.

Refer to KDB 789033 D02v01r03 G)2)c), as specified in § 15.407(b), emissions above 1000 MHz that are outside of the restricted bands are subject to a maximum emission limit of -27 dBm/MHz (or -17 dBm/MHz as specified in § 15.407(b)(4)). However, an out-of-band emission that complies with both the peak and average limits of § 15.209 is not required to satisfy the -27 dBm/MHz or -17 dBm/MHz maximum emission limit.

All out of band emissions appearing in a restricted band as specified in Section 15.205 of the Title 47 CFR must not exceed the limits shown in Table per Section 15.209.

FCC Part 15 Subpart C Paragraph 15.209		
Frequency [MHz]	Field Strength [V/m]	Measured Distance [Meters]
0.009 – 0.490	2400/F (kHz)	300
0.490 – 1.705	24000/F (kHz)	30
1.705 - 30	30	30
30 - 88	100	3
88 - 216	150	3
216 - 960	200	3
Above 960	500	3

7.7.2. Test Procedure Used

KDB 789033 D02v01r03 – Section G

7.7.3. Test Setting

Peak Field Strength Measurements

1. Analyzer center frequency was set to the frequency of the radiated spurious emission of interest

2. RBW = as specified in Table 1
3. VBW = 3 * RBW
4. Detector = peak
5. Sweep time = auto couple
6. Trace mode = max hold
7. Trace was allowed to stabilize

Table 1 - RBW as a function of frequency

Frequency	RBW
9 ~ 150 kHz	200 ~ 300 Hz
0.15 ~ 30 MHz	9 ~ 10 kHz
30 ~ 1000 MHz	100 ~ 120 kHz
> 1000 MHz	1 MHz

Average Field Strength Measurements

1. Analyzer center frequency was set to the frequency of the radiated spurious emission of interest
2. RBW = 1MHz
3. VBW $\geq 1/T$
4. De As an alternative, the instrument may be set to linear detector mode. Ensure that video filtering is applied in linear voltage domain (rather than in a log or dB domain). Some instruments require linear display mode in order to accomplish this. Others have a setting for Average-VBW Type, which can be set to "Voltage" regardless of the display mode
5. Detector = Peak
6. Sweep time = auto
7. Trace mode = max hold
8. Allow max hold to run for at least 50 times (1/duty cycle) traces

7.7.4. Test Setup

1GHz ~ 18GHz Test Setup:

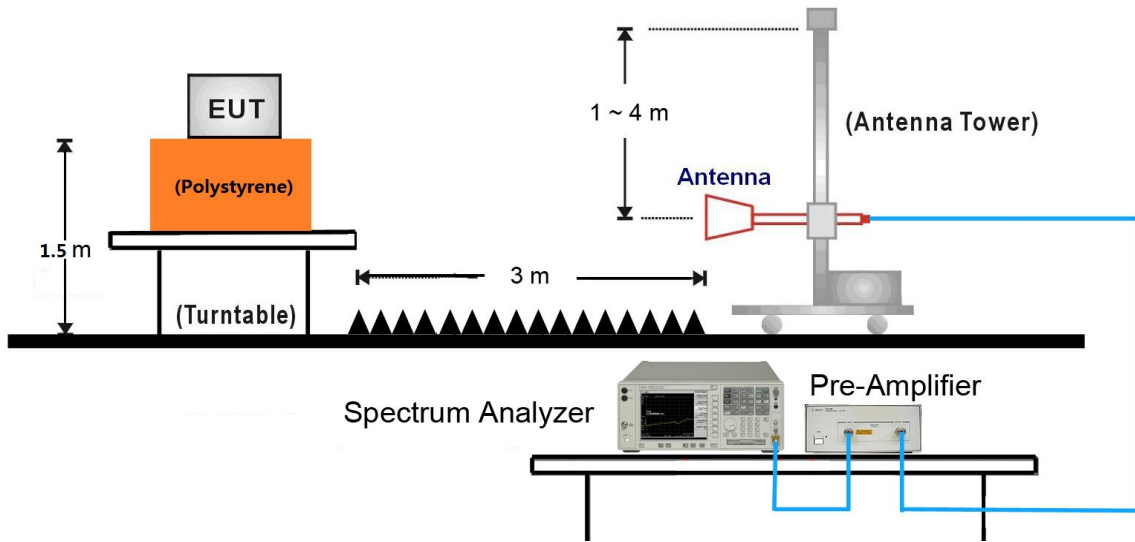

18GHz ~40GHz Test Setup:

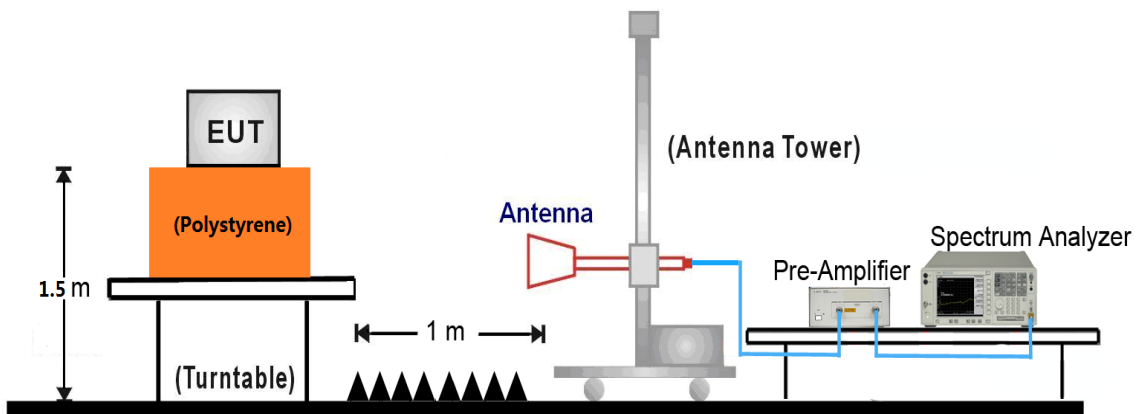

7.7.5. Test Result

EUT	14249-RF2-N	Test Date	2018/01/25
Factor	BBHA 9120D (1GHz~18GHz)	Temp. / Humidity	21°C / 57%
Polarity	Horizontal	Site / Engineer	AC1 / Fran
Test Mode	MODE1-CH36	Test Voltage	By Battery

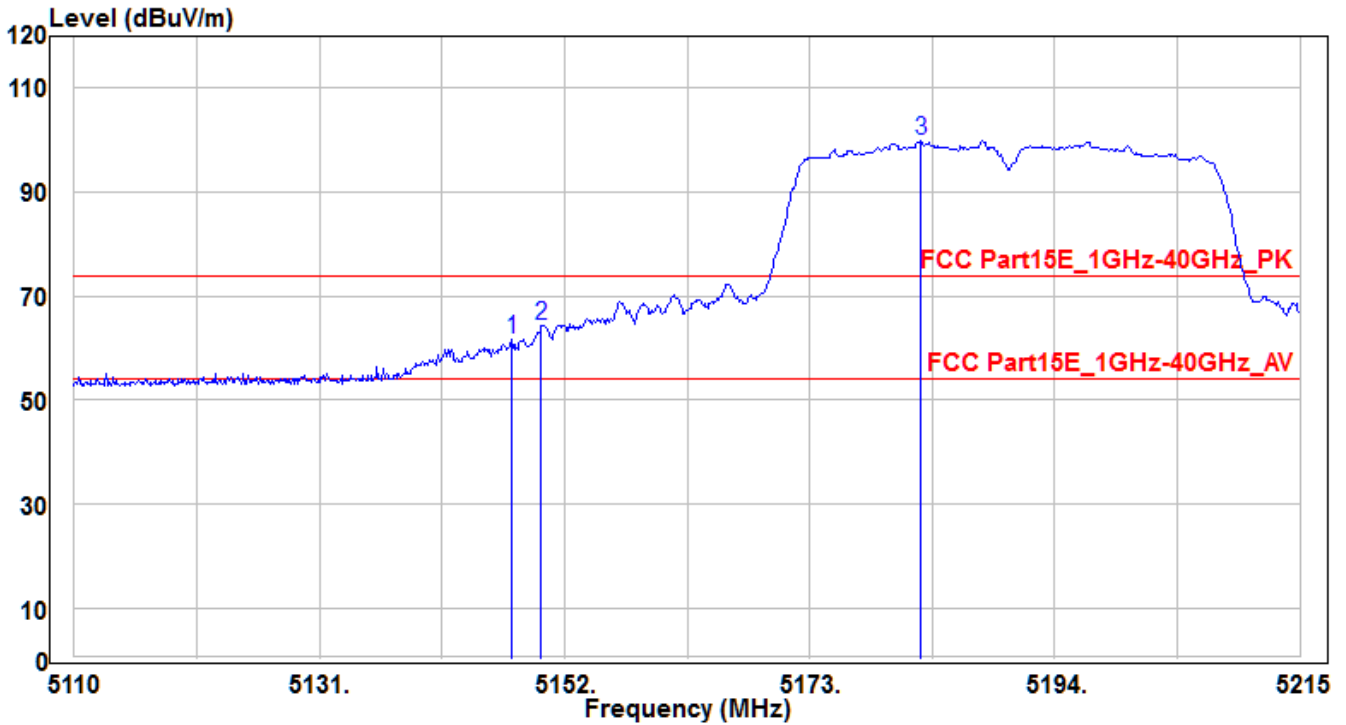

No	Frequency (MHz)	Reading (dBUV)	C.F (dB)	Measurement (dBUV/m)	Margin (dB)	Limit (dBUV)	Height (cm)	Angle (deg)	Remark (QP/PK/AV)
1	5147.485	58.28	3.35	61.63	-12.37	74	160	365	Peak
2	* 5150	61.07	3.36	64.43	-9.57	74	160	365	Peak
3	5182.555	96.39	3.42	99.81	25.81	74	160	365	Peak

Note :

- "*" means the worst value in this measurement data °
- C.F (Correction Factor) = Antenna Factor (dB)+ Cable Loss (dB) – Preamplifier(dB) °
- Measurement (dBUV/m) = Reading(dBUV) + C.F (Correction Factor) °

EUT	14249-RF2-N	Test Date	2018/01/25
Factor	BBHA 9120D (1GHz~18GHz)	Temp. / Humidity	21°C / 57%
Polarity	Horizontal	Site / Engineer	AC1 / Fran
Test Mode	MODE1-CH36	Test Voltage	By Battery

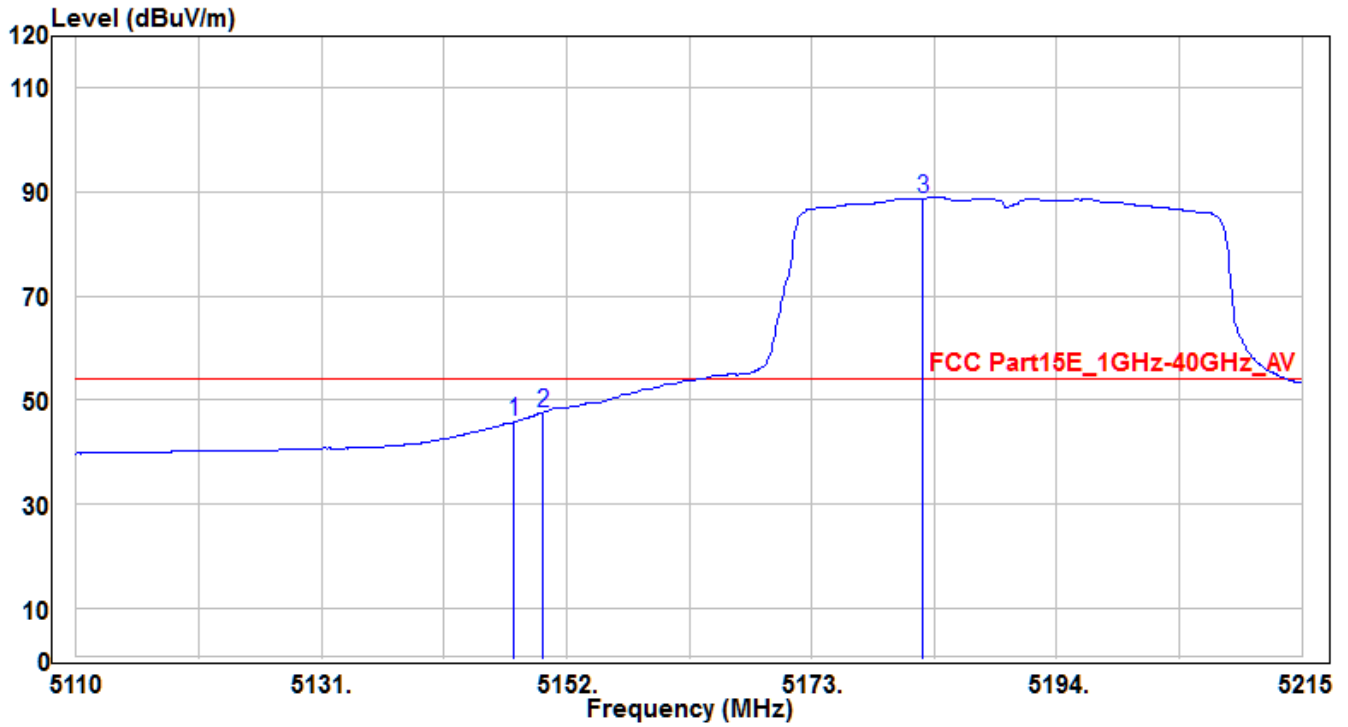

No	Frequency (MHz)	Reading (dBuV)	C.F (dB)	Measurement (dBuV/m)	Margin (dB)	Limit (dBuV)	Height (cm)	Angle (deg)	Remark (QP/PK/AV)
1	5147.485	42.39	3.35	45.74	-8.26	54	160	365	Average
2	* 5150	44.26	3.36	47.62	-6.38	54	160	365	Average
3	5182.555	85.34	3.42	88.76	34.76	54	160	365	Average

Note :

- "*" means the worst value in this measurement data.
- C.F (Correction Factor) = Antenna Factor (dB)+ Cable Loss (dB) – Preamplifier(dB)。
- Measurement (dBuV/m) = Reading(dBuV) + C.F (Correction Factor)。

EUT	14249-RF2-N	Test Date	2018/01/25
Factor	BBHA 9120D (1GHz~18GHz)	Temp. / Humidity	21°C / 57%
Polarity	Vertical	Site / Engineer	AC1 / Fran
Test Mode	MODE1-CH36	Test Voltage	By Battery

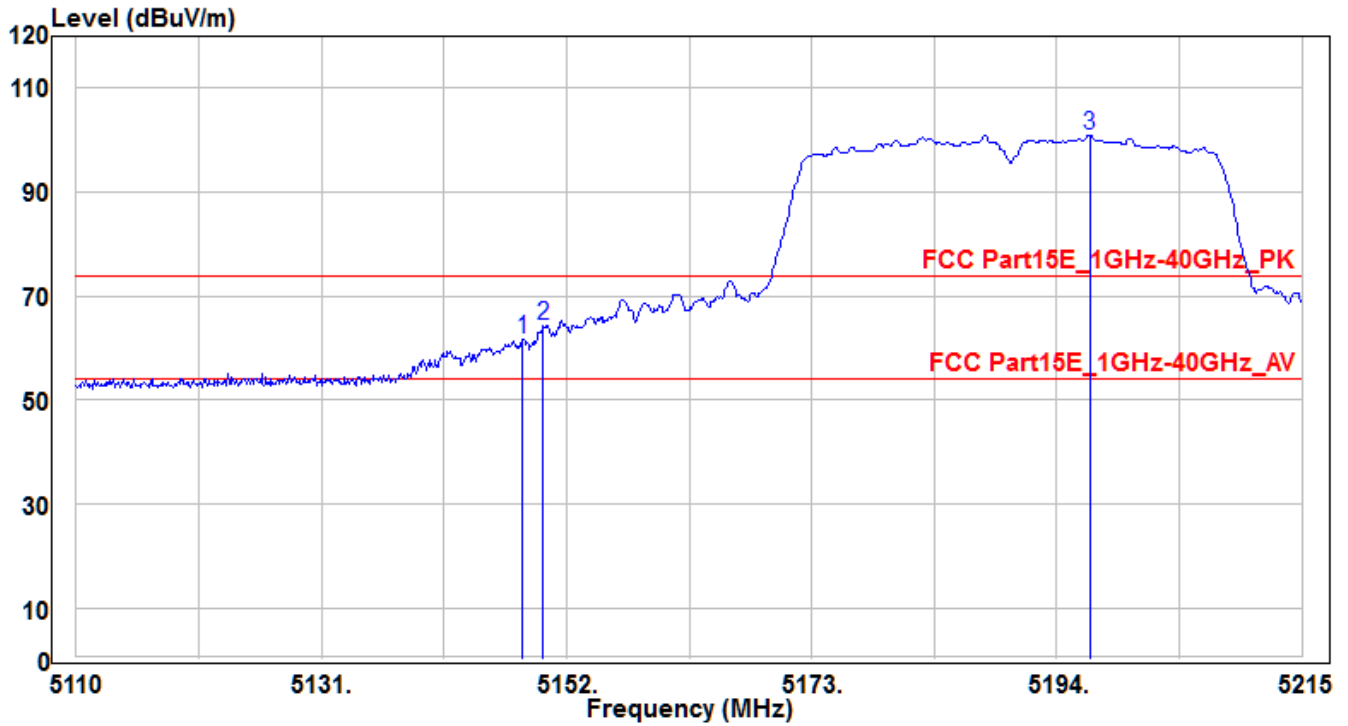

No	Frequency (MHz)	Reading (dBuV)	C.F (dB)	Measurement (dBuV/m)	Margin (dB)	Limit (dBuV)	Height (cm)	Angle (deg)	Remark (QP/PK/AV)
1	5148.22	58.16	3.35	61.51	-12.49	74	115	55	Peak
2	* 5150	60.94	3.36	64.3	-9.7	74	115	55	Peak
3	5196.835	97.51	3.45	100.96	26.96	74	115	55	Peak

Note :

- "*" means the worst value in this measurement data °
- C.F (Correction Factor) = Antenna Factor (dB)+ Cable Loss (dB) – Preamplifier(dB) °
- Measurement (dBuV/m) = Reading(dBuV) + C.F (Correction Factor) °

EUT	14249-RF2-N	Test Date	2018/01/25
Factor	BBHA 9120D (1GHz~18GHz)	Temp. / Humidity	21°C / 57%
Polarity	Vertical	Site / Engineer	AC1 / Fran
Test Mode	MODE1-CH36	Test Voltage	By Battery

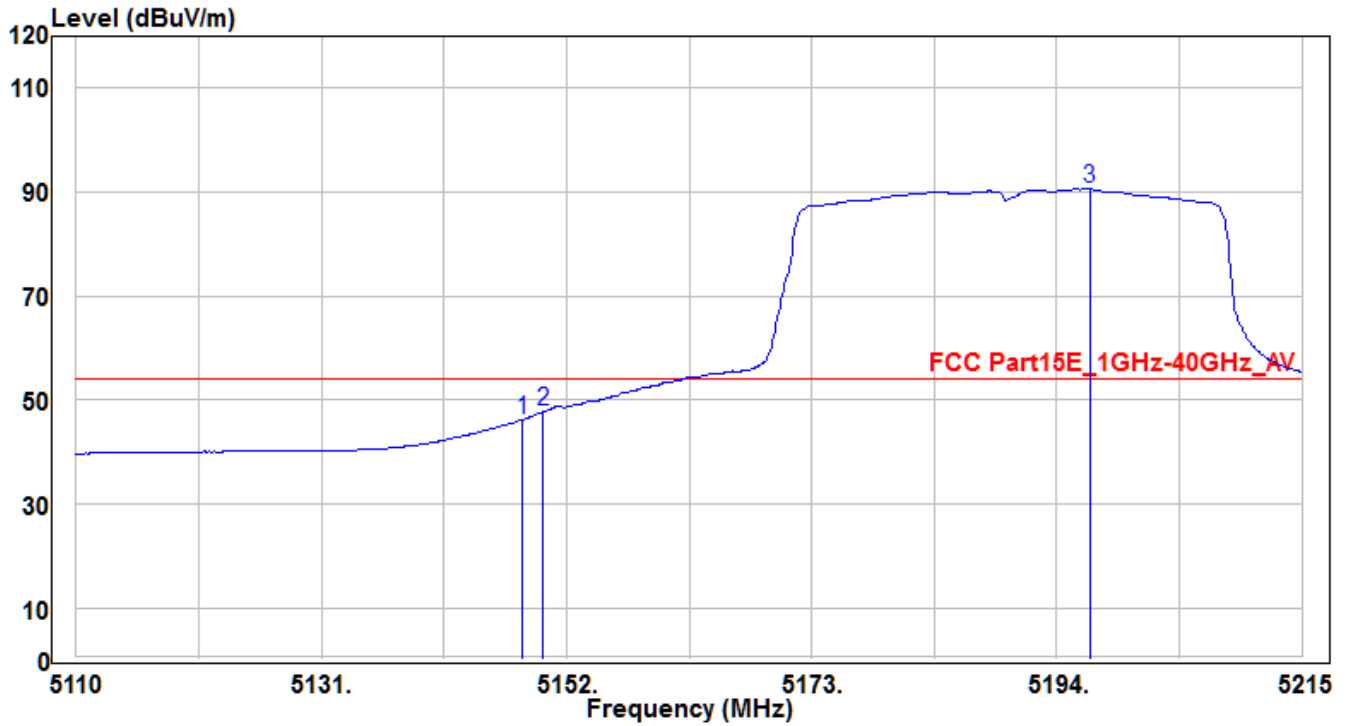

No	Frequency (MHz)	Reading (dBuV)	C.F (dB)	Measurement (dBuV/m)	Margin (dB)	Limit (dBuV)	Height (cm)	Angle (deg)	Remark (QP/PK/AV)
1	5148.22	42.86	3.35	46.21	-7.79	54	115	55	Average
2	* 5150	44.34	3.36	47.7	-6.3	54	115	55	Average
3	5196.835	87.13	3.45	90.58	36.58	54	115	55	Average

Note :

- " * " means the worst value in this measurement data ◦
- C.F (Correction Factor) = Antenna Factor (dB)+ Cable Loss (dB) – Preamplifier(dB) ◦
- Measurement (dBuV/m) = Reading(dBuV) + C.F (Correction Factor) ◦

EUT	14249-RF2-N	Test Date	2018/01/25
Factor	BBHA 9120D (1GHz~18GHz)	Temp. / Humidity	21°C / 57%
Polarity	Horizontal	Site / Engineer	AC1 / Fran
Test Mode	MODE1-CH151	Test Voltage	By Battery

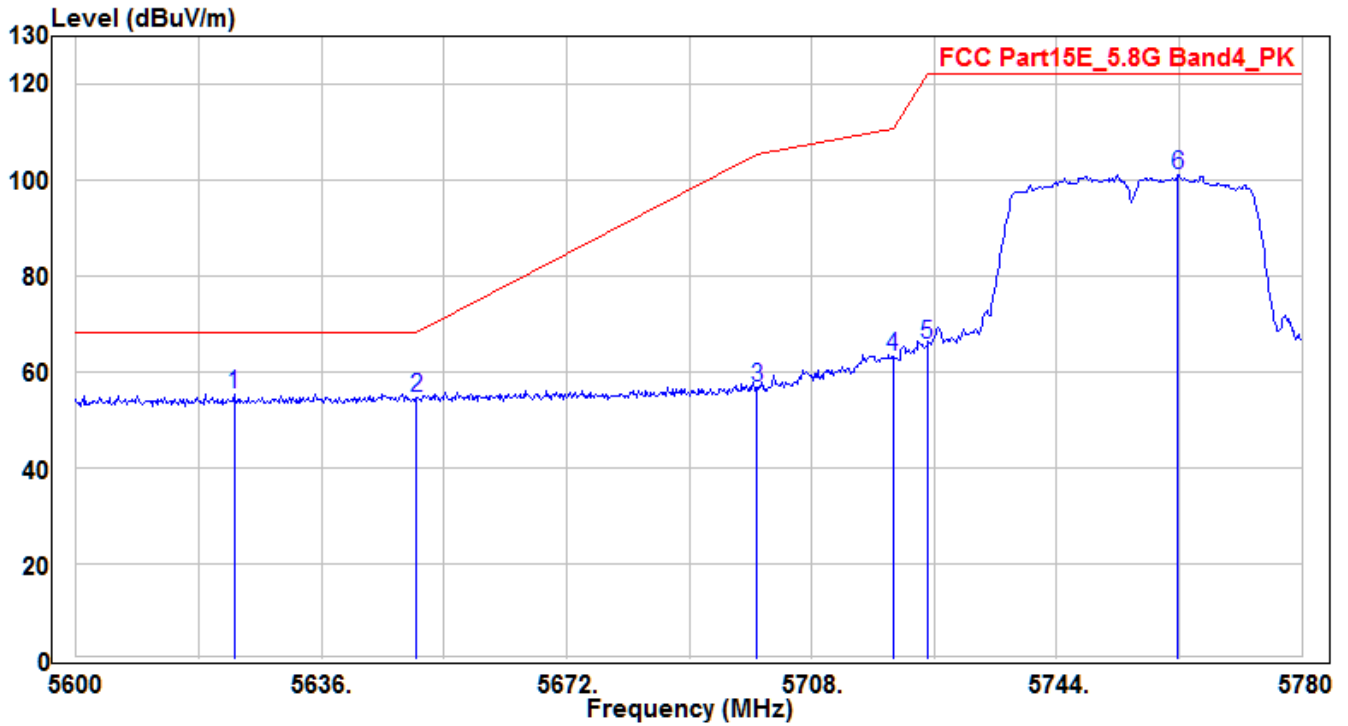

No	Frequency (MHz)	Reading (dBuV)	C.F (dB)	Measurement (dBuV/m)	Margin (dB)	Limit (dBuV)	Height (cm)	Angle (deg)	Remark (QP/PK/AV)
1	* 5623.22	50.9	4.54	55.44	-12.76	68.2	155	375	Peak
2	5650	49.91	4.65	54.56	-13.64	68.2	155	375	Peak
3	5700	52.06	4.84	56.9	-48.3	105.2	155	375	Peak
4	5720	58.41	4.91	63.32	-47.48	110.8	155	375	Peak
5	5725	60.94	4.93	65.87	-56.33	122.2	155	375	Peak
6	5761.82	96.07	5.08	101.15	-21.05	122.2	155	375	Peak

Note :

1. " * " means the worst value in this measurement data ◦
2. C.F (Correction Factor) = Antenna Factor (dB)+ Cable Loss (dB) – Preamplifier(dB) ◦
3. Measurement (dBuV/m) = Reading(dBuV) + C.F (Correction Factor) ◦

EUT	14249-RF2-N	Test Date	2018/01/25
Factor	BBHA 9120D (1GHz~18GHz)	Temp. / Humidity	21°C / 57%
Polarity	Horizontal	Site / Engineer	AC1 / Fran
Test Mode	MODE1-CH151	Test Voltage	By Battery

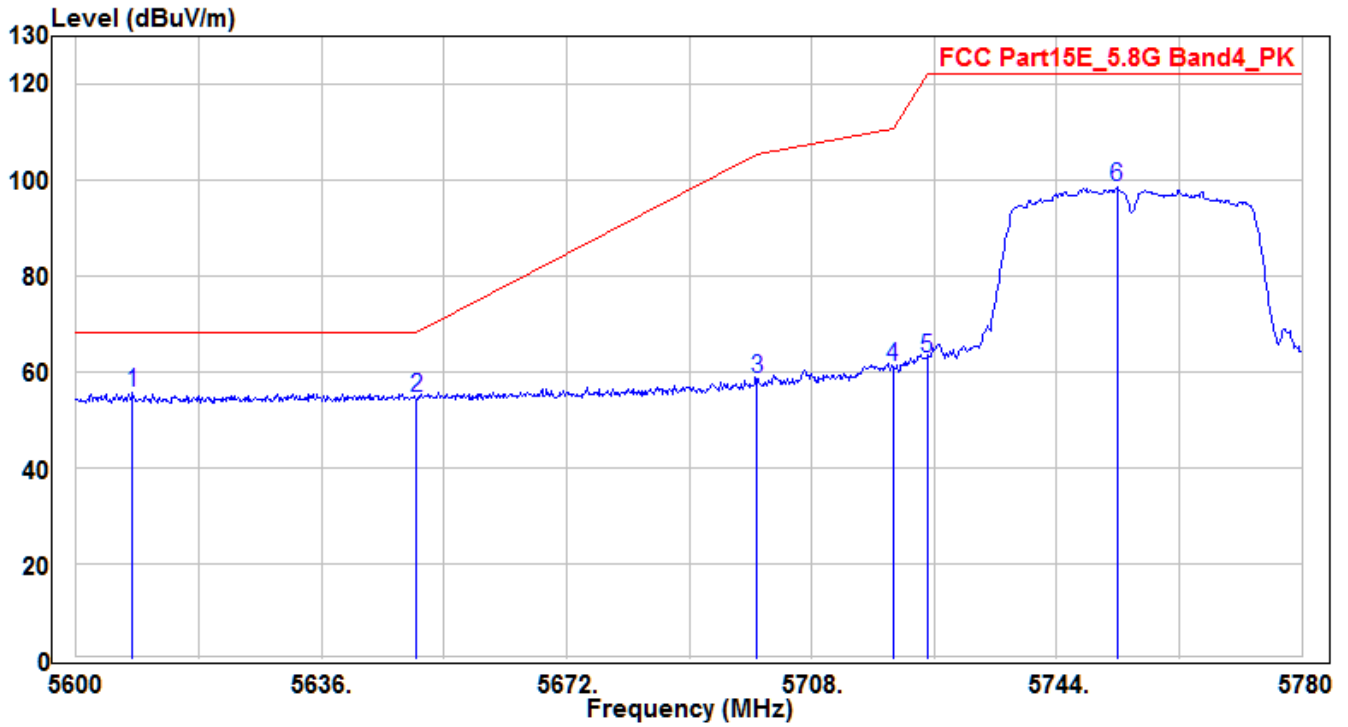

No		Frequency (MHz)	Reading (dBUV)	C.F (dB)	Measurement (dBUV/m)	Margin (dB)	Limit (dBUV)	Height (cm)	Angle (deg)	Remark (QP/PK/AV)
1	*	5608.28	51.12	4.48	55.6	-12.6	68.2	150	65	Peak
2		5650	49.92	4.65	54.57	-13.63	68.2	150	65	Peak
3		5700	53.89	4.84	58.73	-46.47	105.2	150	65	Peak
4		5720	56.04	4.91	60.95	-49.85	110.8	150	65	Peak
5		5725	57.94	4.93	62.87	-59.33	122.2	150	65	Peak
6		5752.82	93.66	5.03	98.69	-23.51	122.2	150	65	Peak

Note :

1. " * " means the worst value in this measurement data ◦
2. C.F (Correction Factor) = Antenna Factor (dB)+ Cable Loss (dB) – Preamplifier(dB) ◦
3. Measurement (dBUV/m) = Reading(dBUV) + C.F (Correction Factor) ◦

7.8. AC Conducted Emissions Measurement

7.8.1. Test Limit

FCC Part 15 Subpart C Paragraph 15.207 / RSS-Gen Limits		
Frequency (MHz)	QP (dB μ V)	Average (dB μ V)
0.15 - 0.50	66 - 56	56 - 46
0.50 - 5.0	56	46
5.0 - 30	60	50

Note 1: The lower limit shall apply at the transition frequencies.

Note 2: The limit decreases linearly with the logarithm of the frequency in the range 0.15MHz to 0.5MHz.

7.8.2. Test Setup

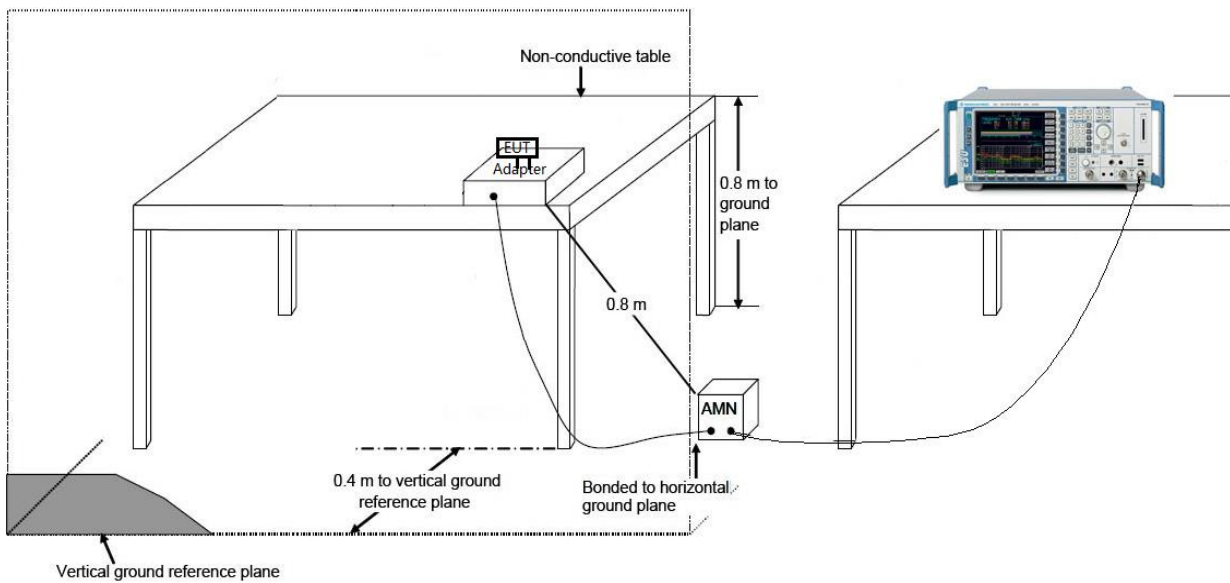

7.8.3. Test Result

Refer to the original report No.: 1801TW1902-U6.

8. CONCLUSION

The data collected relate only the item(s) tested and show that the **Nautiz X9, FCC ID:**

YY3-14249-RF2 is in compliance with Part 15E of the FCC Rules.

————— The End —————