



# MEASUREMENT REPORT

## FCC PART 15.407 WLAN 802.11a/n

---

**FCC ID:** YY3-14249-RF2  
**APPLICANT:** HANDHELD GROUP AB  
**Application Type:** Certification  
**Product:** Nautiz X9  
**Model No.:** 14249-RF2-B  
**Trade Mark:** **handheld**  
**FCC Classification:** Unlicensed National Information Infrastructure (UNII)  
**FCC Rule Part(s):** Part 15.407  
**Test Procedure(s):** ANSI C63.10-2013, KDB 789033 D02v01r03  
**Test Date:** October 09, 2016 ~ January 25, 2018

Tested By : *Kevin Ker*  
( Kevin Ker )  
Reviewed By : *Paddy Chen*  
( Paddy Chen )  
Approved By : *Chenz Ker*  
( Chenz Ker )



The test results relate only to the samples tested.

This equipment has been shown to be capable of compliance with the applicable technical standards as indicated in the measurement report and was tested in accordance with the measurement procedures specified in KDB 789033 D02v01r03. Test results reported herein relate only to the item(s) tested.

The test report shall not be reproduced except in full without the written approval of MRT Technology (Taiwan) Co., Ltd.

---

## Revision History

Report No.	Version	Description	Issue Date	Note
1801TW1902-U6	1.0	Original Report	2018-02-06	

# CONTENTS

Description	Page
<b>§2.1033 General Information .....</b>	<b>5</b>
<b>1. INTRODUCTION .....</b>	<b>6</b>
1.1. Scope.....	6
1.2. MRT Test Location.....	6
<b>2. PRODUCT INFORMATION .....</b>	<b>7</b>
2.1. Equipment Description .....	7
2.2. Working Frequencies for this Report .....	8
2.3. Test Mode.....	8
2.4. Test Software.....	9
2.5. Test Configuration.....	9
2.6. EMI Suppression Device(s)/Modifications .....	9
2.7. Labeling Requirements .....	9
<b>3. DESCRIPTION of TEST .....</b>	<b>10</b>
3.1. Evaluation Procedure .....	10
3.2. AC Line Conducted Emissions .....	10
3.3. Radiated Emissions .....	11
<b>4. ANTENNA REQUIREMENTS.....</b>	<b>12</b>
<b>5. TEST EQUIPMENT CALIBRATION DATE.....</b>	<b>13</b>
<b>6. MEASUREMENT UNCERTAINTY.....</b>	<b>14</b>
<b>7. TEST RESULT .....</b>	<b>15</b>
7.1. Summary.....	15
7.2. 26dB Bandwidth Measurement .....	16
7.2.1. Test Limit.....	16
7.2.2. Test Procedure used .....	16
7.2.3. Test Setting .....	16
7.2.4. Test Setup.....	16
7.2.5. Test Result .....	17
7.3. 6dB Bandwidth Measurement .....	21
7.3.1. Test Limit.....	21
7.3.2. Test Procedure used .....	21
7.3.3. Test Setting .....	21
7.3.4. Test Setup.....	21
7.3.5. Test Result .....	22
7.4. Maximum Conducted Output Power Measurement .....	25
7.4.1. Test Limit.....	25
7.4.2. Test Procedure Used.....	25
7.4.3. Test Setting .....	25
7.4.4. Test Setup.....	25
7.4.5. Test Result of Output Power.....	26
7.5. Peak Power Spectral Density Measurement.....	27

---

7.5.1.	Test Limit .....	27
7.5.2.	Test Procedure Used.....	27
7.5.3.	Test Setting .....	27
7.5.4.	Test Setup .....	28
7.5.5.	Test Result .....	29
7.6.	Radiated Spurious Emission Measurement.....	33
7.6.1.	Test Limit.....	33
7.6.2.	Test Procedure Used.....	33
7.6.3.	Test Setting .....	33
7.6.4.	Test Setup .....	34
7.6.5.	Test Result .....	36
7.7.	Radiated Restricted Band Edge Measurement.....	70
7.7.1.	Test Limit.....	70
7.7.2.	Test Procedure Used.....	71
7.7.3.	Test Setting .....	71
7.7.4.	Test Setup .....	73
7.7.5.	Test Result .....	74
7.8.	AC Conducted Emissions Measurement.....	110
7.8.1.	Test Limit.....	110
7.8.2.	Test Setup .....	110
7.8.3.	Test Result .....	111
<b>8.</b>	<b>CONCLUSION .....</b>	<b>113</b>

## §2.1033 General Information

<b>Applicant</b>	HANDHELD GROUP AB
<b>Applicant Address</b>	Kinnegatan 17 A ,531 33 Lidköping, Sweden
<b>Manufacturer</b>	HANDHELD GROUP AB
<b>Manufacturer Address</b>	Kinnegatan 17 A ,531 33 Lidköping, Sweden
<b>Test Site</b>	MRT Technology (Taiwan) Co., Ltd
<b>Test Site Address</b>	No. 38, Fuxing Second Rd., Guishan Dist., Taoyuan City 333, Taiwan (R.O.C)
<b>MRT FCC Registration No.</b>	291082
<b>FCC Rule Part(s)</b>	Part 15.407
<b>Test Device Serial No.</b>	N/A <input type="checkbox"/> Production <input checked="" type="checkbox"/> Pre-Production <input type="checkbox"/> Engineering

### Test Facility / Accreditations

1. MRT facility is a FCC registered ( Reg. No. 291082) test facility with the site description report on file and is designated by the FCC as an Accredited Test Film.
2. MRT facility is an IC registered (MRT Reg. No. 21723-1) test laboratory with the site description on file at Industry Canada.
3. MRT Lab is accredited to ISO 17025 by the Taiwan Accreditation Foundation (TAF Cert. No. 3261) in EMC, Telecommunications and Radio testing for FCC, Industry Taiwan, EU and TELEC Rules.

# 1. INTRODUCTION

## 1.1. Scope

Measurement and determination of electromagnetic emissions (EMC) of radio frequency devices including intentional and/or unintentional radiators for compliance with the technical rules and regulations of the Federal Communications Commission and the Industry Canada Certification and Engineering Bureau.

## 1.2. MRT Test Location

The map below shows the location of the MRT LABORATORY, its proximity to the Taoyuan City. These measurement tests were conducted at the MRT Technology (Taiwan) Co., Ltd. Facility located at No.38, Fuxing 2nd Rd., Guishan Dist., Taoyuan City 33377, Taiwan (R.O.C).

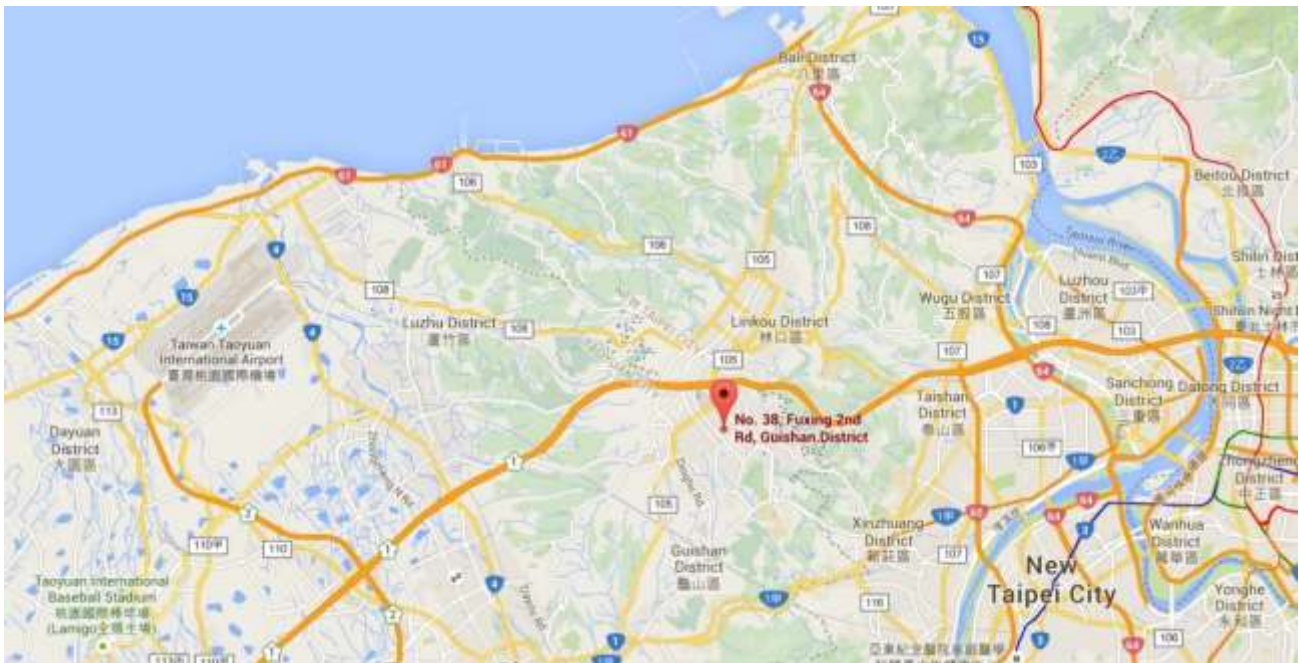

## 2. PRODUCT INFORMATION

### 2.1. Equipment Description

Product Name	Nautiz X9
Model No.	14249-RF2-B
Brand Name	<b>handheld</b>
Supports Radios Spec.	WWAN: GSM/GPRS/EGPRS/WCDMA/HSPA/CDMA/EVDO/LTE WLAN: 2.4G: 802.11b/g/n-20/n-40; 5G: 802.11a/n-20/n-40 WPAN: Bluetooth/NFC
Wi-Fi Specification	802.11a/b/g/n
Frequency Range	<b><u>2.4GHz:</u></b> For 802.11b/g/n-20M: 2412 ~ 2462 MHz For 802.11n-40M: 2422 ~ 2452 MHz <b><u>5GHz:</u></b> For 802.11a/n-20M: 5180~5240MHz, 5745~5825MHz For 802.11n-40M: 5190~5230MHz, 5755~5795MHz
5GHz Maximum Output Power	802.11a: 10.32dBm 802.11n-20M: 10.31dBm 802.11n-40M: 9.38dBm
Type of Modulation	802.11a/n-20M/n-40M: OFDM, BPSK, QPSK, 16QAM, 64QAM

## 2.2. Working Frequencies for this Report

### 802.11a/n-20M

Channel	Frequency	Channel	Frequency	Channel	Frequency
36	5180 MHz	40	5200 MHz	44	5220 MHz
48	5240 MHz	--	--	--	--
149	5745 MHz	153	5765 MHz	157	5785 MHz
161	5805 MHz	165	5825 MHz	--	--

### 802.11n-40M

Channel	Frequency	Channel	Frequency	Channel	Frequency
38	5190 MHz	46	5230 MHz	--	--
151	5755 MHz	159	5795 MHz	--	--

## 2.3. Test Mode

Test Mode	Mode 1: Transmit by 802.11a
	Mode 2: Transmit by 802.11n-20M
	Mode 3: Transmit by 802.11n-40M



## 2.4. Test Software

The test utility software used during testing was “MTK Engineer Mode”.

## 2.5. Test Configuration

The **Nautiz X9, FCC ID: YY3-14249-RF2** was tested per the guidance of KDB 789033 D02v01r03. ANSI C63.10-2013 was used to reference the appropriate EUT setup for radiated spurious emissions testing and AC line conducted testing.

## 2.6. EMI Suppression Device(s)/Modifications

No EMI suppression device(s) were added and/or no modifications were made during testing.

## 2.7. Labeling Requirements

Per 2.1074 & 15.19; Docket 95-19

The label shall be permanently affixed at a conspicuous location on the device; instruction manual or pamphlet supplied to the user and be readily visible to the purchaser at the time of purchase. However, when the device is so small wherein placement of the label with specified statement is not practical, only the FCC ID must be displayed on the device per Section 15.19(a)(5). Please see attachment for FCC ID label and label location.

### 3. DESCRIPTION of TEST

#### 3.1. Evaluation Procedure

The measurement procedures described in the American National Standard for Testing Unlicensed Wireless Devices (ANSI C63.10-2013), and the guidance provided in KDB 789033 D02v01r03 were used in the measurement of the **Nautiz X9, FCC ID: YY3-14249-RF2**.

**Deviation from measurement procedure.....None**

#### 3.2. AC Line Conducted Emissions

The line-conducted facility is located inside an 9'x4'x3' shielded enclosure. A 1m x 2m wooden table 80cm high is placed 40cm away from the vertical wall and 80cm away from the sidewall of the shielded room. Two 10kHz-30MHz, 50Ω/50uH Line-Impedance Stabilization Networks (LISNs) are bonded to the shielded room floor. Power to the LISNs is filtered by external high-current high-insertion loss power line filters. These filters attenuate ambient signal noise from entering the measurement lines. These filters are also bonded to the shielded enclosure.

The EUT is powered from one LISN and the support equipment is powered from the second LISN. All interconnecting cables more than 1 meter were shortened to a 1 meter length by non-inductive bundling (serpentine fashion) and draped over the back edge of the test table. All cables were at least 40cm above the horizontal reference ground-plane. Power cables for support equipment were routed down to the second LISN while ensuring that that cables were not draped over the second LISN.

Sufficient time for the EUT, support equipment, and test equipment was allowed in order for them to warm up to their normal operating condition. The RF output of the LISN was connected to the receiver and exploratory measurements were made to determine the frequencies producing the maximum emission from the EUT. The receiver was scanned from 150kHz to 30MHz. The detector function was set to peak mode for exploratory measurements while the bandwidth of the analyzer was set to 9kHz. The EUT, support equipment, and interconnecting cables were arranged and manipulated to maximize each emission. Each emission was also maximized by varying: power lines, the mode of operation or data exchange speed, or support equipment which determined the worst-case emission. Once the worst case emissions have been identified, the one EUT cable configuration/arrangement and mode of operation that produced these emissions are used for final measurements on the same test site. The analyzer is set to CISPR quasi-peak and average detectors with a 9kHz resolution bandwidth for final measurements.

An extension cord was used to connect to a single LISN which powered by EUT. The extension cord was calibrated with LISN, the impedance and insertion loss are compliance with the requirements as stated in ANSI C63.10-2013.

Line conducted emissions test results are shown in Section 7.8.

### 3.3. Radiated Emissions

The radiated test facilities consisted of an indoor 3 meter semi-anechoic chamber used for final measurements and exploratory measurements, when necessary. The measurement area is contained within the semi-anechoic chamber which is shielded from any ambient interference. For measurements above 1GHz absorbers are arranged on the floor between the turn table and the antenna mast in such a way so as to maximize the reduction of reflections. For measurements below 1GHz, the absorbers are removed. A MF Model 210SS turntable is used for radiated measurement. It is a continuously rotatable, remote controlled, metallic turntable and 2 meters (6.56 ft.) in diameter. The turn table is flush with the raised floor of the chamber in order to maintain its function as a ground plane. An 80cm high PVC support structure is placed on top of the turntable.

For all measurements, the spectrum was scanned through all EUT azimuths and from 1 to 4 meter receive antenna height using a broadband antenna from 30MHz up to the upper frequency shown in 15.33(b)(1) depending on the highest frequency generated or used in the device or on which the device operates or tunes. For frequencies above 1GHz, linearly polarized double ridge horn antennas were used. For frequencies below 30MHz, a calibrated loop antenna was used. When exploratory measurements were necessary, they were performed at 1 meter test distance inside the semi-anechoic chamber using broadband antennas, broadband amplifiers, and spectrum analyzers to determine the frequencies and modes producing the maximum emissions. Sufficient time for the EUT, support equipment, and test equipment was allowed in order for them to warm up to their normal operating condition. The test set-up for frequencies below 1GHz was placed on top of the 0.8 meter high, 1 x 1.5 meter table; and test set-up for frequencies 1-40GHz was placed on top of the 1.5 meter high, 1 x 1.5 meter table. The EUT, support equipment, and interconnecting cables were arranged and manipulated to maximize each emission. Appropriate precaution was taken to ensure that all emissions from the EUT were maximized and investigated. The system configuration, clock speed, mode of operation or video resolution, if applicable, turntable azimuth, and receive antenna height was noted for each frequency found.

Final measurements were made in the semi-anechoic chamber using calibrated, linearly polarized broadband and horn antennas. The test setup was configured to the setup that produced the worst case emissions. The spectrum analyzer was set to investigate all frequencies required for testing to compare the highest radiated disturbances with respect to the specified limits. The turntable containing the EUT was rotated through 360 degrees and the height of the receive antenna was varied 1 to 4 meters and stopped at the azimuth and height producing the maximum emission. Each emission was maximized by changing the orientation of the EUT through three orthogonal planes and changing the polarity of the receive antenna, which produced the worst-case emissions. According to 3dB Beam-Width of horn antenna, the horn antenna should be always directed to the EUT when rising height.

Radiated emissions test results are shown in Section 7.6 & 7.7.

## 4. ANTENNA REQUIREMENTS

### Excerpt from §15.203 of the FCC Rules/Regulations:

“An intentional radiator antenna shall be designed to ensure that no antenna other than that furnished by the responsible party can be used with the device. The use of a permanently attached antenna or of an antenna that uses a unique coupling to the intentional radiator shall be considered sufficient to comply with the provisions of this section.”

- The antenna of the **Nautiz X9**, is permanently attached.
- There are no provisions for connection to an external antenna.

### **Conclusion:**

The **Nautiz X9, FCC ID: YY3-14249-RF2** unit complies with the requirement of §15.203.

#### Antenna List

No.	Manufacturer	Part No.	Antenna Type	Peak Gain
1	N/A	AP316-DB_V1	FPC	0.31dBi for 5150MHz~5250MHz 1.07dBi for 5725MHz~5850MHz

## 5. TEST EQUIPMENT CALIBRATION DATE

### Conducted Emissions – SR2

Instrument	Manufacturer	Type No.	Asset No.	Cali. Interval	Cali. Due Date
Two-Line V-Network	R&S	ENV216	MRTTWA00019	1 year	2018.03.15
Cable	Rosnol	N1C50-RG400-B 1C50-500CM	MRTTWE00013	1 year	2018.05.19
EMI Test Receiver	R&S	ESR3	MRTTWA00009	1 year	2018.03.16

### Radiated Emissions – AC1

Instrument	Manufacturer	Type No.	Asset No.	Cali. Interval	Cali. Due Date
Broadband TRILOG Antenna	SCHWARZBECK	VULB 9162	MRTTWA00001	1 year	2018.05.14
EMI Test Receiver	R&S	ESR3	MRTTWA00009	1 year	2018.03.16
Active Loop Antenna	Schwarzbeck	FMZB 1519B	MRTTWA00002	1 year	2018.04.13
Broadband Horn antenna	SCHWARZBECK	BBHA 9120D	MRTTWA00003	1 year	2018.04.17
Breitband Hornantenna	Schwarzbeck	BBHA 9170	MRTTWA00004	1 year	2018.04.24
Broadband Amplifier	Schwarzbeck	BBV 9721	MRTTWA00006	1 year	2018.04.24
Broadband Preamplifier	SCHWARZBECK	BBV 9718	MRTTWA00005	1 year	2018.04.19
Cable	HUBERSUHNER	SF106	MRTTWA00010	1 year	2018.05.19
Cable	Rosnol	K1K50-UP0264- K1K50-4M	MRTTWA00012	1 year	2018.05.19

### Conducted Test Equipment – SR2

Instrument	Manufacturer	Type No.	Asset No.	Cali. Interval	Cali. Due Date
Spectrum Analyzer	KEYSIGHT	N9010A	MRTTWA00012	1 year	2018.07.24
USB Wideband Power Sensor	KEYSIGHT	U2021XA	MRTTWA00015	1 year	2018.03.19

### Test Software

Software	Version	Function
e3	9.160520a	EMI Test Software
EMI	V3	EMI Test Software

## 6. MEASUREMENT UNCERTAINTY

Where relevant, the following test uncertainty levels have been estimated for tests performed on the EUT as specified in CISPR 16-4-2. This uncertainty represents an expanded uncertainty expressed at approximately the 95% confidence level using a coverage factor of  $k = 2$ .

AC Conducted Emission Measurement – SR2
Measuring Uncertainty for a Level of Confidence of 95% ( $U=2Uc(y)$ ): 150kHz~30MHz: 2.42dB
Conducted Measurement– SR1
Measuring Uncertainty for a Level of Confidence of 95% ( $U=2Uc(y)$ ): 1.3dB
Radiated Emission Measurement – AC1
Measuring Uncertainty for a Level of Confidence of 95% ( $U=2Uc(y)$ ): 4.22dB

## 7. TEST RESULT

### 7.1. Summary

**Product Name:** Nautiz X9  
**FCC Classification:** Unlicensed National Information Infrastructure (UNII)  
**Data Rate(s) Tested:** 6Mbps ~ 54Mbps (a);  
 6.5/7.2Mbps ~ 65/72.2Mbps (n-20M);  
 13.5/15Mbps ~ 135/150Mbps (n-40M);

FCC Section(s)	Test Description	Test Limit	Test Condition	Test Result	Reference
15.407(a)	26dB Bandwidth	N/A	Conducted	Pass	Section 7.2
15.407(e)	6dB Bandwidth	$\geq 500\text{kHz}$		Pass	Section 7.3
15.407 (a)(1)(2)(3)	Maximum Conducted Output Power	$\leq 24\text{ dBm (U-NII-1)}$ $\leq 30\text{ dBm (U-NII-3)}$		Pass	Section 7.4
15.407 (a)(1)(2)(3)(5)	Peak Power Spectral Density	$\leq 11\text{ dBm/MHz (U-NII-1)}$ $\leq 30\text{ dBm/500kHz (U-NII-3)}$		Pass	Section 7.5
15.407(b)(1),(4)	Undesirable Emissions	$\leq -27\text{dBm/MHz EIRP}$ $\leq -17\text{dBm/MHz EIRP}$	Radiated	Pass	Section 7.6 & 7.7
15.205, 15.209 15.407(b)(5), (6), (7)	General Field Strength Limits (Restricted Bands and Radiated Emission Limits)	Emissions in restricted bands must meet the radiated limits detailed in 15.209		Pass	
15.207	AC Conducted Emissions 150kHz - 30MHz	< FCC 15.207 limits	Line Conducted	Pass	Section 7.8

#### Notes:

- 1) All modes of operation and data rates were investigated. For radiated emission test, every axis (X, Y, Z) was also verified. The test results shown in the following sections represent the worst case emissions.
- 2) The analyzer plots shown in this section were all taken with a correction table loaded into the analyzer. The correction table was used to account for the losses of the cables and attenuators used as part of the system to connect the EUT to the analyzer at all frequencies of interest.
- 3) All antenna port conducted emissions testing was performed on a test bench with the antenna port of the EUT connected to the spectrum analyzer through calibrated cables and attenuators.

## 7.2. 26dB Bandwidth Measurement

### 7.2.1. Test Limit

N/A

### 7.2.2. Test Procedure used

KDB 789033 D02v01r03- Section C.1

### 7.2.3. Test Setting

1. The analyzers' automatic bandwidth measurement capability was used to perform the 26dB bandwidth measurement. The "X" dB bandwidth parameter was set to  $X = 26$ . The automatic bandwidth measurement function also has the capability of simultaneously measuring the 99% occupied bandwidth. The bandwidth measurement was not influenced by any intermediated power nulls in the fundamental emission.
2. RBW = approximately 1% of the emission bandwidth.
3. VBW  $\geq 3 \times$  RBW.
4. Detector = Peak.
5. Trace mode = max hold.
6. Sweep = auto couple
7. Allow the trace was allowed to stabilize

### 7.2.4. Test Setup

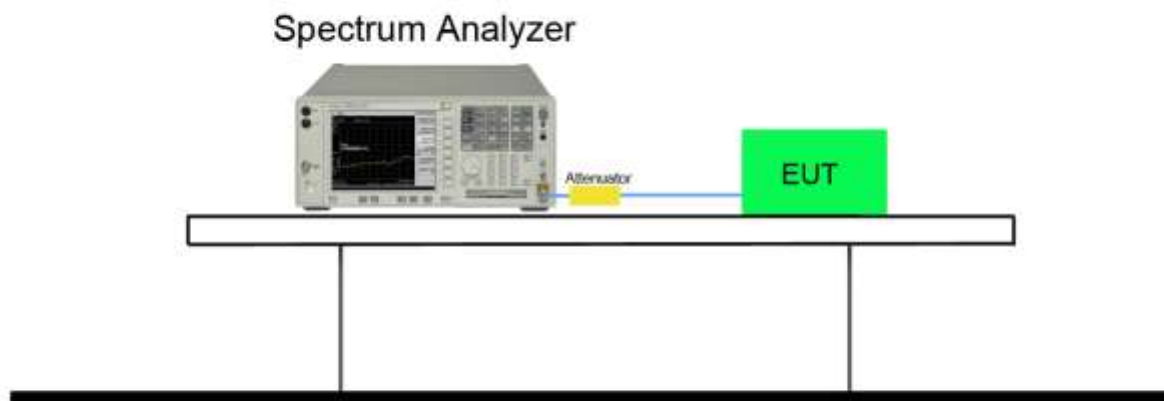



### 7.2.5. Test Result

Test Mode	Channel No.	Frequency (MHz)	26dB Bandwidth (MHz)	99% Bandwidth (MHz)	Result
802.11a	36	5180	19.79	16.573	Pass
802.11a	44	5220	20.17	17.651	Pass
802.11a	48	5240	19.91	16.525	Pass
802.11a	149	5745	19.44	16.470	Pass
802.11a	157	5785	19.40	17.592	Pass
802.11a	165	5825	19.24	16.466	Pass
802.11n-20M	36	5180	19.68	17.619	Pass
802.11n-20M	44	5220	19.70	16.509	Pass
802.11n-20M	48	5240	20.40	17.595	Pass
802.11n-20M	149	5745	19.19	16.465	Pass
802.11n-20M	157	5785	19.61	17.549	Pass
802.11n-20M	165	5825	19.70	17.600	Pass
802.11n-40M	38	5190	39.54	35.962	Pass
802.11n-40M	46	5230	39.45	36.002	Pass
802.11n-40M	151	5755	39.43	36.108	Pass
802.11n-40M	159	5795	39.80	36.076	Pass

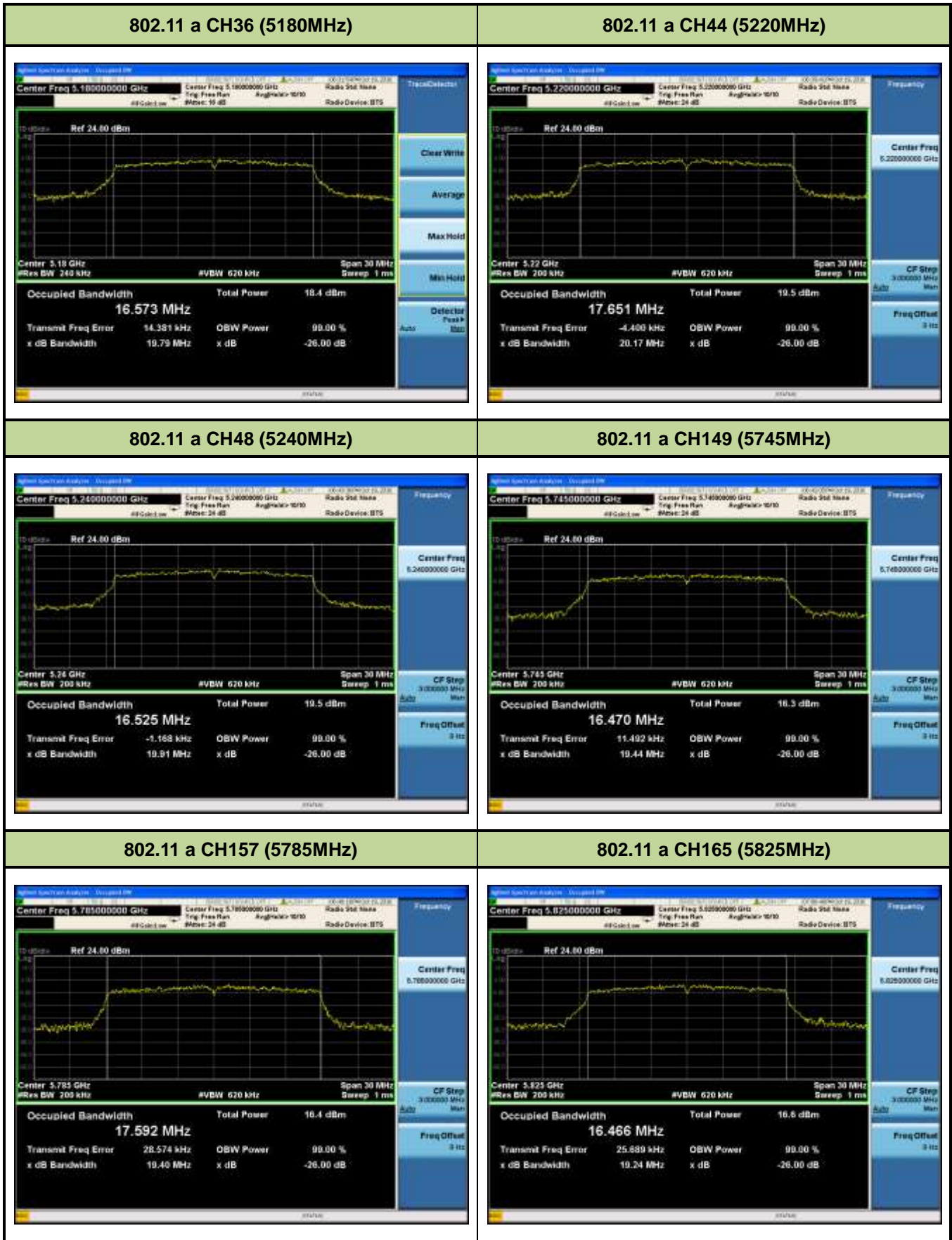

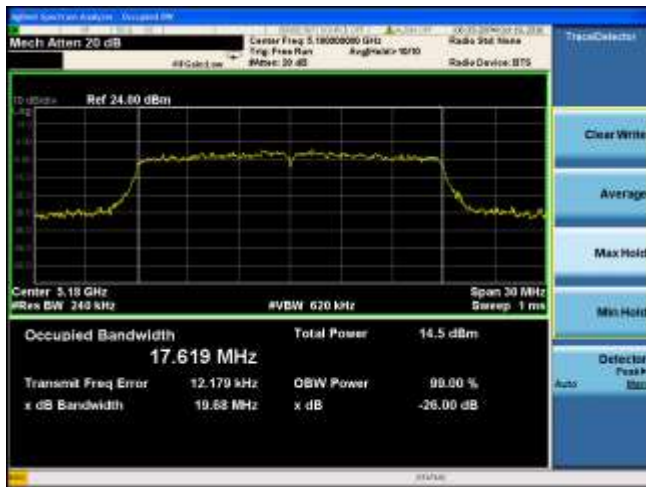
**802.11 n-20M CH36 (5180MHz)**

**802.11 n-20M CH44 (5220MHz)**

**802.11 n-20M CH48 (5240MHz)**

**802.11 n-20M CH149 (5745MHz)**

**802.11 n-20M CH157 (5785MHz)**

**802.11 n-20M CH165 (5825MHz)**

**802.11 n-40M CH38 (5190MHz)**

**802.11 n-40M CH46 (5230MHz)**

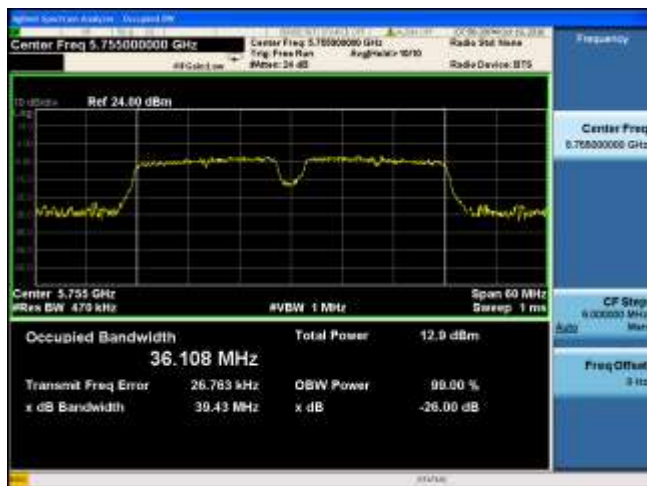
**802.11 n-40M CH151 (5755MHz)**

**802.11 n-40M CH159 (5795MHz)**

### 7.3. 6dB Bandwidth Measurement

#### 7.3.1. Test Limit

Within the 5.725-5.85 GHz band, the minimum 6 dB bandwidth of U-NII devices shall be at least 500 kHz.

#### 7.3.2. Test Procedure used

KDB 789033 D02v01r03- Section C.2

#### 7.3.3. Test Setting

1. Set center frequency to the nominal EUT channel center frequency.
2. RBW = 100 kHz.
3. VBW  $\geq 3 \times$  RBW.
4. Detector = Peak.
5. Trace mode = max hold.
6. Sweep = auto couple
7. Allow the trace was allowed to stabilize
8. Measure the maximum width of the emission that is constrained by the frequencies associated with the two outermost amplitude points (upper and lower frequencies) that are attenuated by 6 dB relative to the maximum level measured in the fundamental emission.

#### 7.3.4. Test Setup

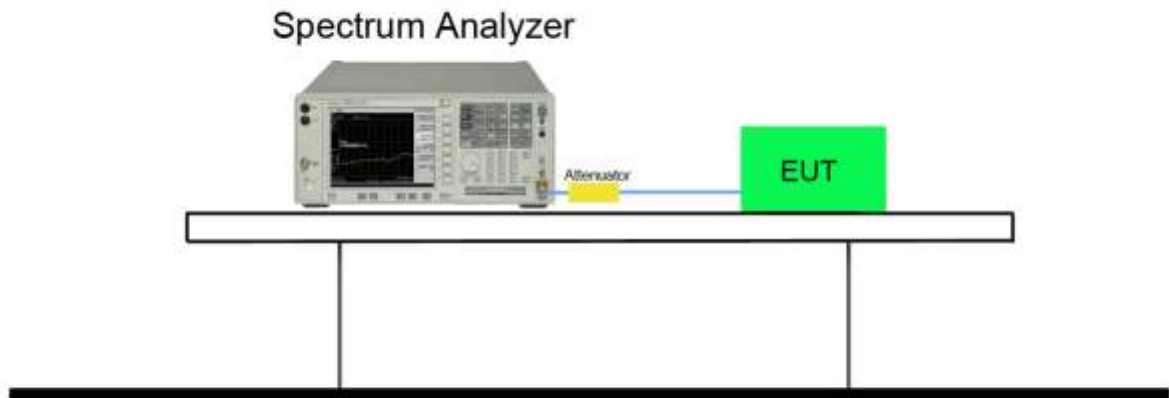

### 7.3.5. Test Result

Test Mode	Channel No.	Frequency (MHz)	6dB Bandwidth (MHz)	99% Bandwidth (MHz)	Limit (MHz)	Result
802.11a	149	5745	17.28	17.624	≥ 0.5	Pass
802.11a	157	5785	16.44	16.508	≥ 0.5	Pass
802.11a	165	5825	16.39	16.543	≥ 0.5	Pass
802.11n-20M	149	5745	16.08	16.429	≥ 0.5	Pass
802.11n-20M	157	5785	17.38	17.580	≥ 0.5	Pass
802.11n-20M	165	5825	17.29	17.628	≥ 0.5	Pass
802.11n-40M	151	5755	36.14	36.090	≥ 0.5	Pass
802.11n-40M	159	5795	35.97	36.109	≥ 0.5	Pass

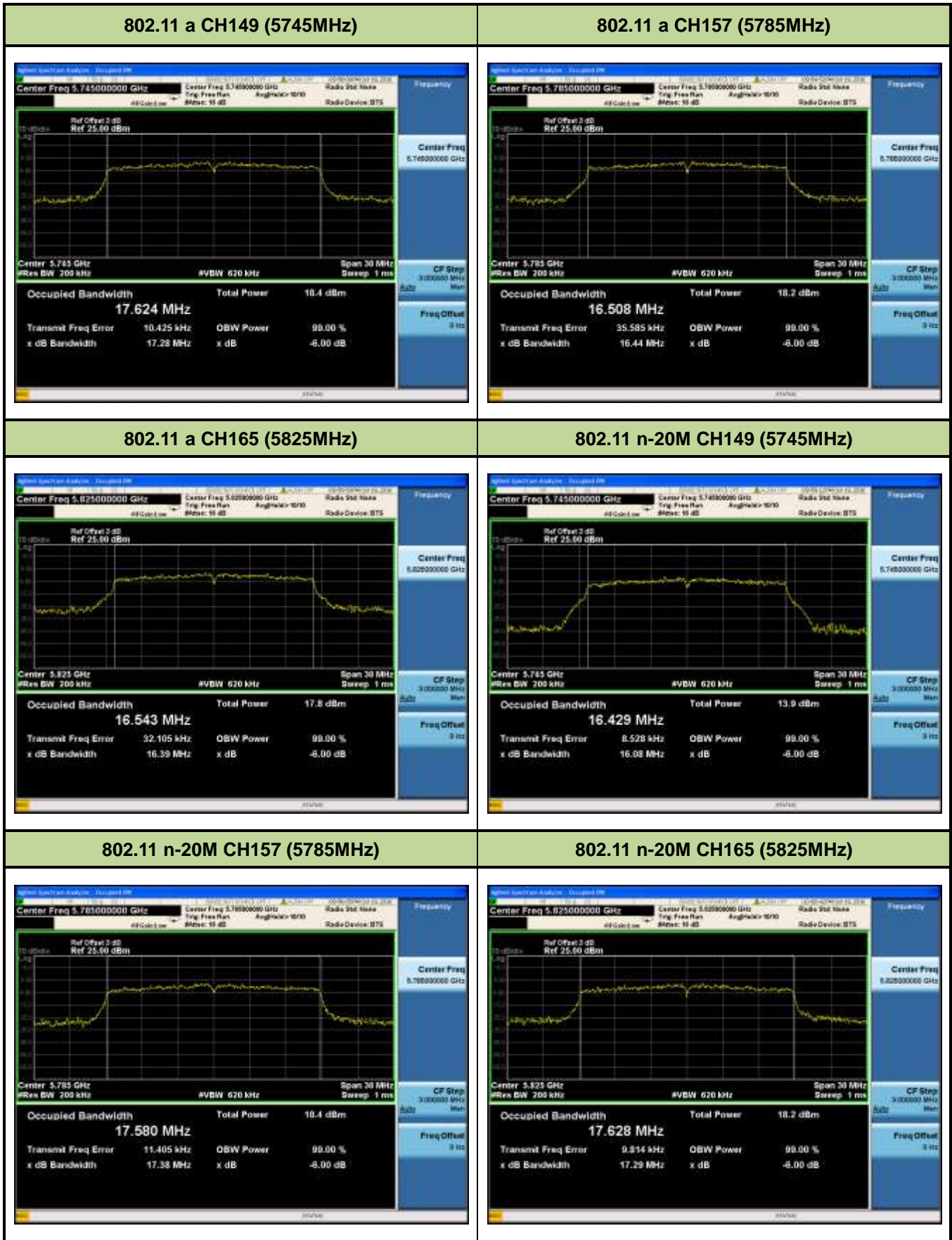





## 7.4. Maximum Conducted Output Power Measurement

### 7.4.1. Test Limit

For client devices in the 5.15-5.25 GHz band, the maximum conducted output power over the frequency band of operation shall not exceed 250 mW (24dBm).

For the band 5.725-5.85 GHz, the maximum conducted output power over the frequency band of operation shall not exceed 1 W (30dBm).

### 7.4.2. Test Procedure Used

KDB 789033 D02v01r03 - Section E) 3) b) Method PM-G

### 7.4.3. Test Setting

#### Average Power Measurement

Average power measurements were performed only when the EUT was transmitting at its maximum power control level using a broadband power meter with a pulse sensor. The power meter implemented triggering and gating capabilities which were set up such that power measurements were recorded only during the ON time of the transmitter. The trace was averaged over 100 traces to obtain the final measured average power.

### 7.4.4. Test Setup

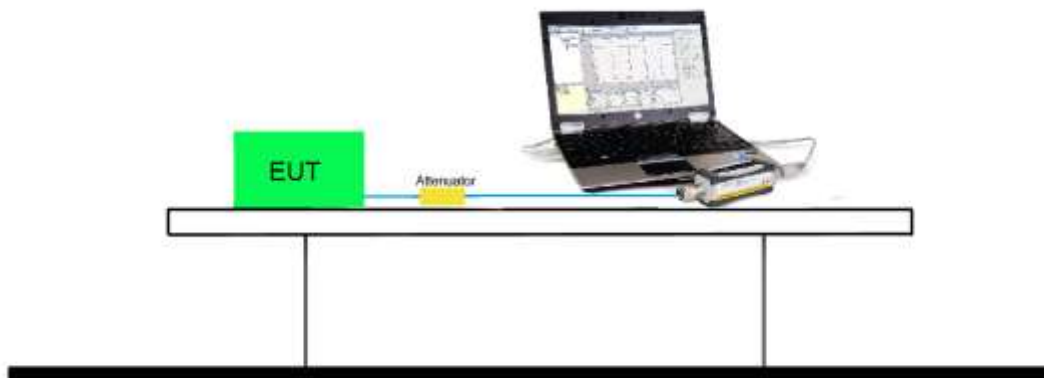

**7.4.5. Test Result of Output Power**

<b>Mode1: 5GHz 802.11a RF Output Power (dBm)</b>											
Channel No.	Frequency (MHz)	Average Power For different Data Rate (Mbps)								Required Limit	
		6	9	12	18	24	36	48	54		
36	5180	--	--	--	--	--	--	--	--	10.01	24 dBm
44	5220	10.01	10.06	10.21	10.24	10.15	10.28	10.19	10.32		24 dBm
48	5240	--	--	--	--	--	--	--	--	10.28	24 dBm
149	5745	--	--	--	--	--	--	--	--	9.04	30 dBm
157	5785	8.91	8.93	8.89	8.95	8.78	8.99	9.02	9.05		30 dBm
165	5825	--	--	--	--	--	--	--	--	9.13	30 dBm

<b>Mode2: 5GHz 802.11n-20M RF Output Power (dBm)</b>											
Channel No.	Frequency (MHz)	Average Power For different Data Rate (Mbps)								Required Limit	
		MCS0	MCS1	MCS2	MCS3	MCS4	MCS5	MCS6	MCS7		
36	5180	--	--	--	--	--	--	--	--	9.95	24 dBm
44	5220	9.6	9.94	9.81	10.01	10.15	10.03	10.28	10.31		24 dBm
48	5240	--	--	--	--	--	--	--	--	10.26	24 dBm
149	5745	--	--	--	--	--	--	--	--	7.85	30 dBm
157	5785	7.67	7.82	7.74	7.89	7.81	7.91	7.99	8.08		30 dBm
165	5825	--	--	--	--	--	--	--	--	8.21	30 dBm

<b>Mode3: 5GHz 802.11n-40M RF Output Power (dBm)</b>											
Channel No.	Frequency (MHz)	Average Power For different Data Rate (Mbps)								Required Limit	
		MCS0	MCS1	MCS2	MCS3	MCS4	MCS5	MCS6	MCS7		
38	5190	9.14	--	--	--	--	--	--	--		24 dBm
46	5230	9.38	9.09	9.32	9.33	9.2	9.28	9.34	9.28		24 dBm
151	5755	8.35	8.22	8.01	8.18	8.09	7.98	7.89	7.95		30 dBm
159	5795	7.92	--	--	--	--	--	--	--		30 dBm

Note: Output power = Reading value on power meter + cable loss

.

## 7.5. Peak Power Spectral Density Measurement

### 7.5.1. Test Limit

For the band 5.15-5.25 GHz, the maximum permissible power spectral density is 11dBm/MHz.

For the band 5.725-5.85 GHz, the maximum permissible power spectral density is 30dBm/500kHz.

### 7.5.2. Test Procedure Used

KDB 789033 D02v01r03 – Section F

### 7.5.3. Test Setting

1. Analyzer was set to the center frequency of the UNII channel under investigation
2. Span was set to encompass the entire 26dB EBW of the signal.
3. RBW = 1MHz, if measurement bandwidth of Maximum PSD is specified in 500 kHz,  
RBW = 100 kHz
4. VBW = 3MHz
5. Number of sweep points  $\geq 2 \times (\text{span} / \text{RBW})$
6. Detector = power averaging (Average)
7. Sweep time = auto
8. Trigger = free run/
9. Use the peak search function on the instrument to find the peak of the spectrum and record its value.
10. Add  $10 \cdot \log(1/x)$ , where x is the duty cycle, to the measured power in order to compute the average power during the actual transmission times (because the measurement represents an average over both the on and off times of the transmission). For example, add  $10 \cdot \log(1/0.25) = 6$  dB if the duty cycle is 25 percent.
11. When the measurement bandwidth of Maximum PSD is specified in 500 kHz, add a constant factor  $10 \cdot \log(500\text{kHz}/100\text{kHz}) = 7$  dB to the measured result

### 7.5.4. Test Setup

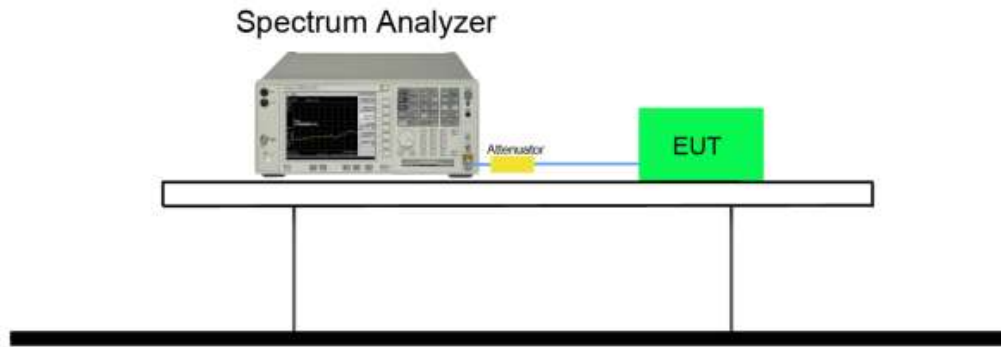

**7.5.5. Test Result**

Test Mode	Channel No.	Freq. (MHz)	PSD (dBm)	Limit (dBm/MHz)	Result
802.11a	36	5180	-0.006	≤ 11dBm/MHz	Pass
802.11a	44	5220	-1.036	≤ 11dBm/MHz	Pass
802.11a	48	5240	0.622	≤ 11dBm/MHz	Pass
802.11a	149	5745	-3.923	≤ 30dBm/500kHz	Pass
802.11a	157	5785	-3.919	≤ 30dBm/500kHz	Pass
802.11a	165	5825	-3.813	≤ 30dBm/500kHz	Pass
802.11n-20M	36	5180	0.085	≤ 11dBm/MHz	Pass
802.11n-20M	44	5220	0.329	≤ 11dBm/MHz	Pass
802.11n-20M	48	5240	0.699	≤ 11dBm/MHz	Pass
802.11n-20M	149	5745	-3.731	≤ 30dBm/500kHz	Pass
802.11n-20M	157	5785	-4.346	≤ 30dBm/500kHz	Pass
802.11n-20M	165	5825	-4.460	≤ 30dBm/500kHz	Pass
802.11n-40M	38	5190	-3.572	≤ 11dBm/MHz	Pass
802.11n-40M	46	5230	-3.713	≤ 11dBm/MHz	Pass
802.11n-40M	151	5755	-8.943	≤ 30dBm/500kHz	Pass
802.11n-40M	159	5795	-8.910	≤ 30dBm/500kHz	Pass

802.11 a CH36 (5180MHz)

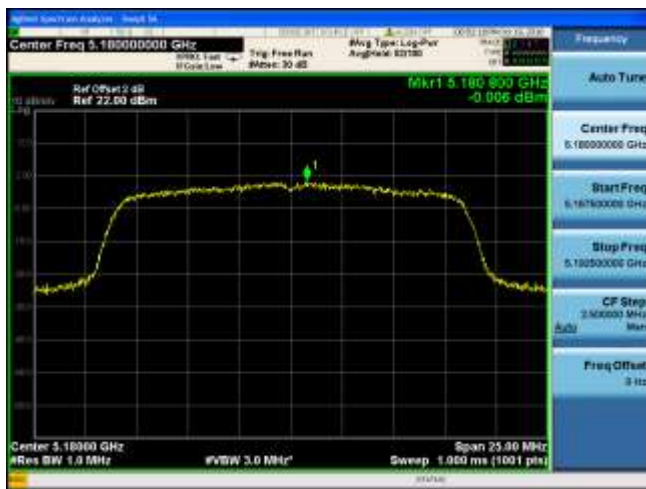

802.11 a CH44 (5220MHz)



802.11 a CH48 (5240MHz)



802.11 a CH149 (5745MHz)

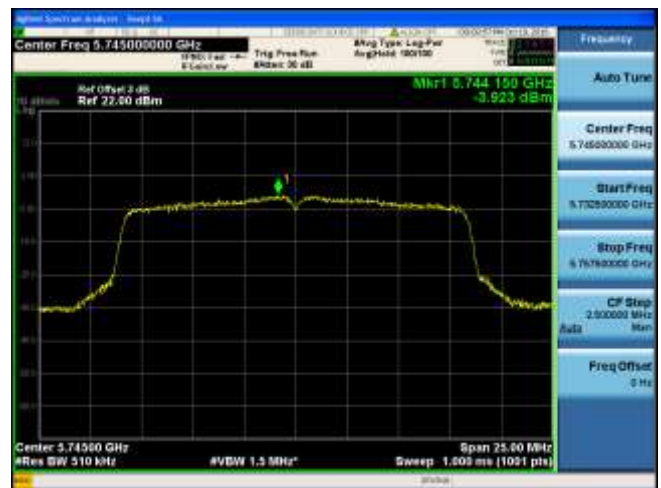

802.11 a CH157 (5785MHz)



802.11 a CH165 (5825MHz)



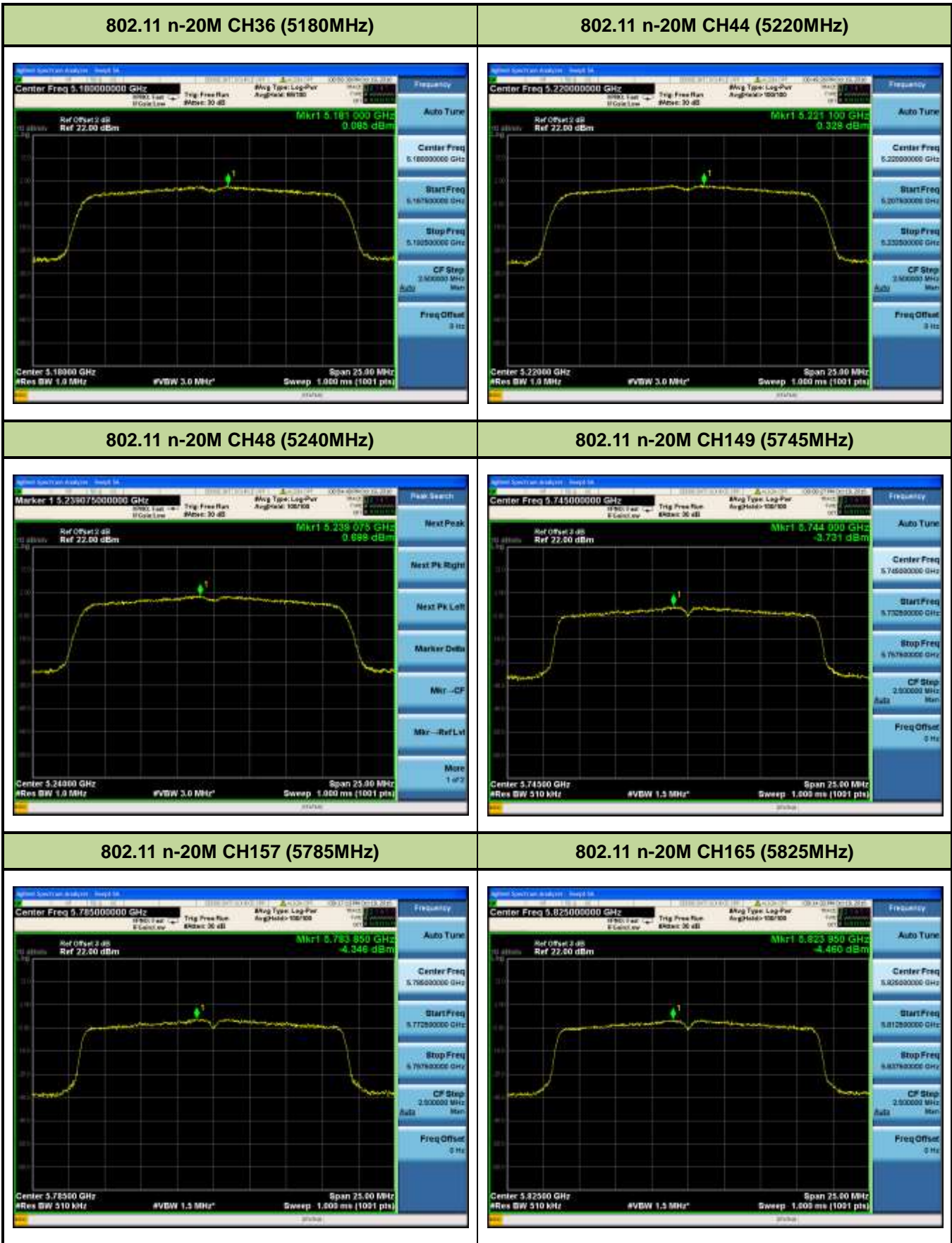

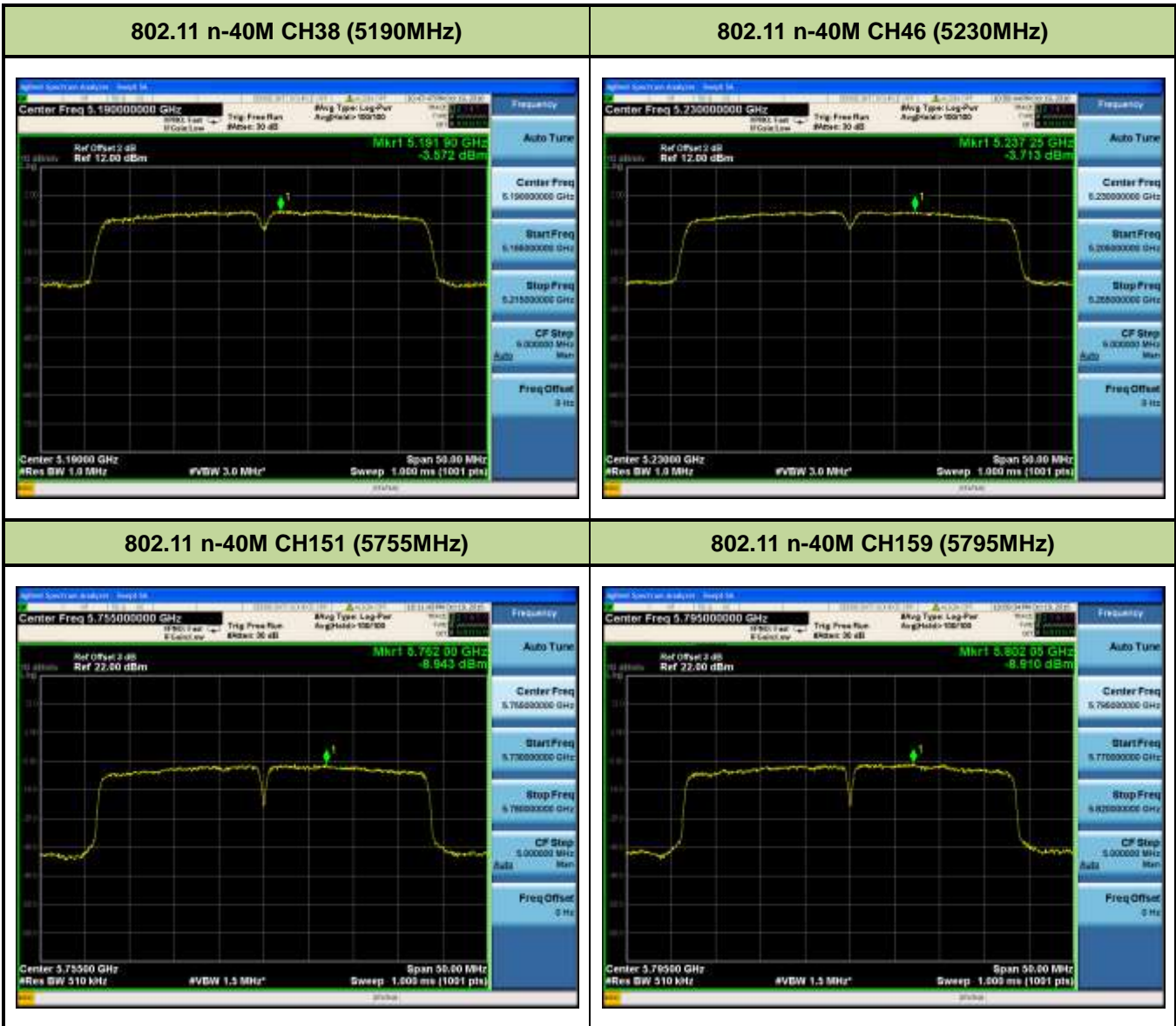



## 7.6. Radiated Spurious Emission Measurement

### 7.6.1. Test Limit

All out of band emissions appearing in a restricted band as specified in Section 15.205 of the Title 47 CFR must not exceed the limits shown in Table per Section 15.209.

FCC Part 15 Subpart C Paragraph 15.209		
Frequency [MHz]	Field Strength [V/m]	Measured Distance [Meters]
0.009 - 0.490	2400/F (kHz)	300
0.490 - 1.705	24000/F (kHz)	30
1.705 - 30	30	30
30 - 88	100	3
88 - 216	150	3
216 - 960	200	3
Above 960	500	3

### 7.6.2. Test Procedure Used

KDB 789033 D02v01r03- Section G

### 7.6.3. Test Setting

#### **Peak Measurements above 1GHz**

1. Analyzer center frequency was set to the frequency of the radiated spurious emission of interest
2. RBW = 1MHz
3. VBW = 3MHz
4. Detector = peak
5. Sweep time = auto couple
6. Trace mode = max hold
7. Trace was allowed to stabilize

### **Quasi-Peak Measurements below 1GHz**

1. Analyzer center frequency was set to the frequency of the radiated spurious emission of interest
2. Span was set greater than 1MHz
3. RBW = 120 kHz
4. Detector = CISPR quasi-peak
5. Sweep time = auto couple
6. Trace was allowed to stabilize

### **Average Measurements above 1GHz (Method AD)**

1. Analyzer center frequency was set to the frequency of the radiated spurious emission of interest
2. RBW = 1MHz
3. VBW = 3MHz
4. Detector = power average (Average)
5. Number of measurement points = 1001 (Number of points must be  $> 2 \times \text{span}/\text{RBW}$ )
6. Sweep time = auto
7. Trace was averaged over at 100 sweeps

#### **7.6.4. Test Setup**

##### 9kHz ~ 30MHz Test Setup:

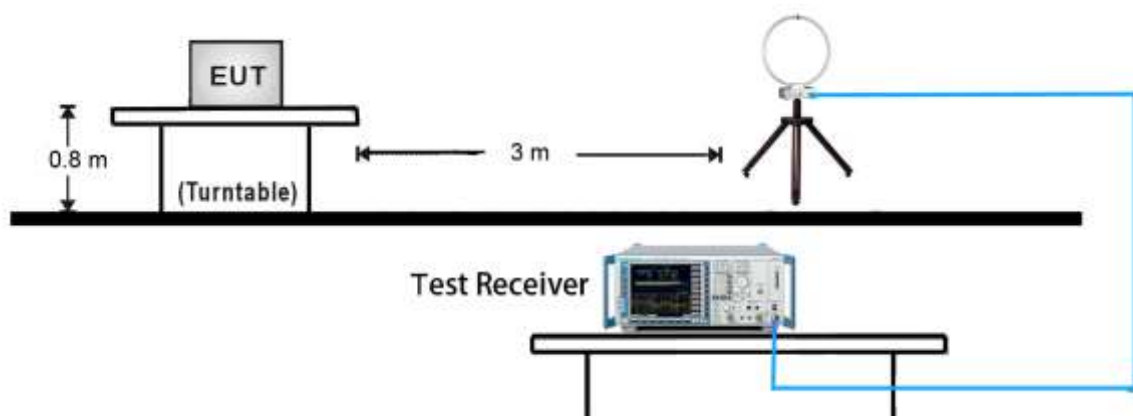

30MHz ~ 1GHz Test Setup:

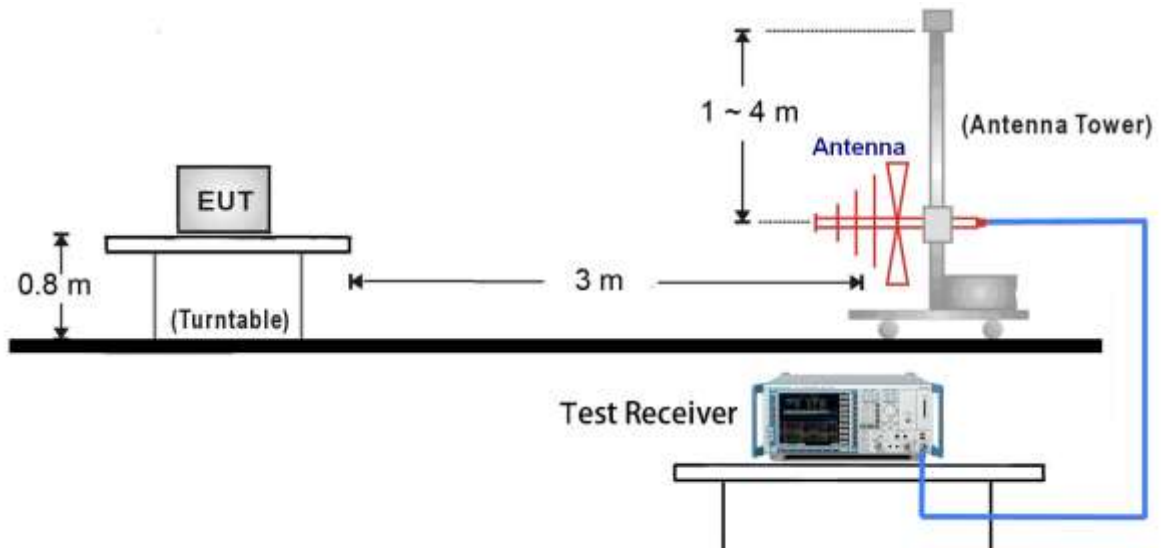

1GHz ~ 18GHz Test Setup:

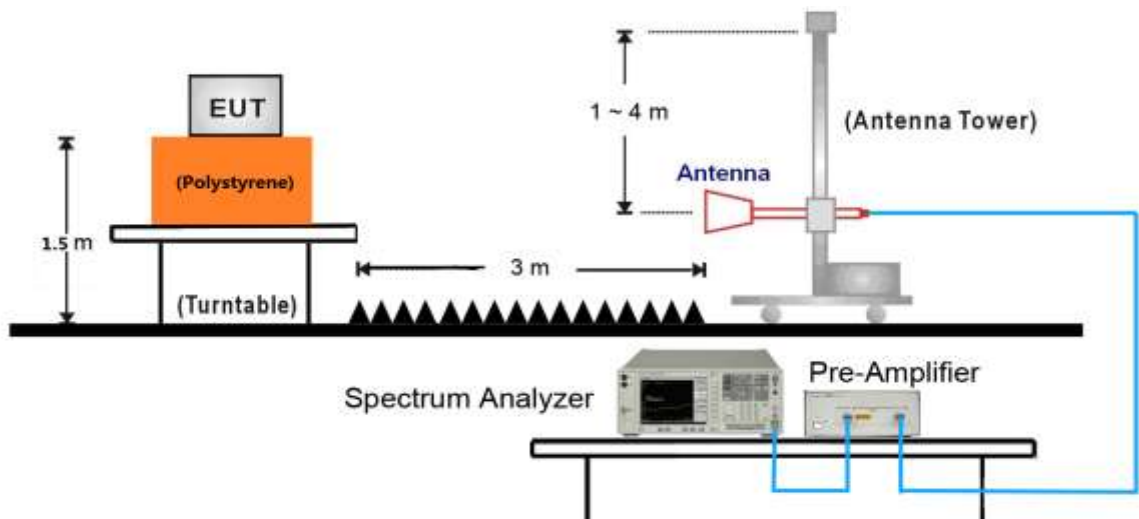

18GHz ~40GHz Test Setup:

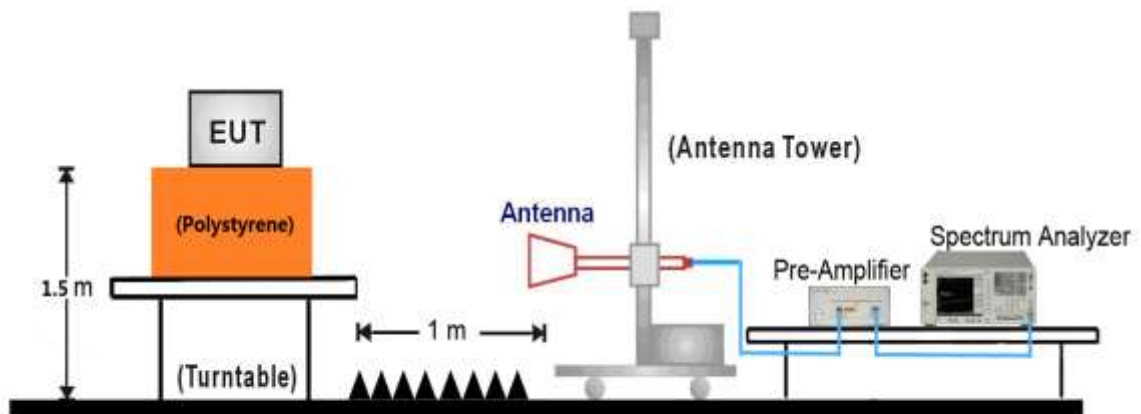

**7.6.5. Test Result**

EUT	14249-RF2-B	Date of Test	2016.10.24
Factor	VULB 9162 (30MHz~8GHz)	Temp. / Humidity	25°C / 60%
Polarity	Horizontal	Site / Test Engineer	AC1 / Kevin
Test Mode	Mode1	Test Voltage	By Battery

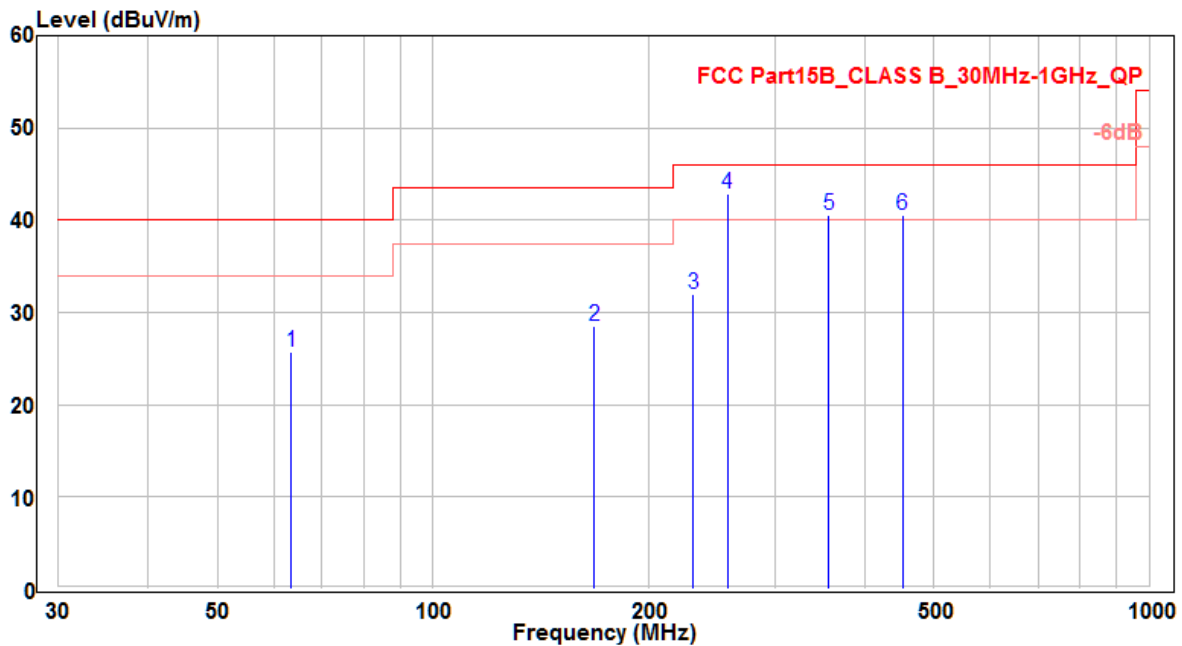

No	Frequency (MHz)	Reading (dBuV)	C.F (dB)	Measurement (dBuV/m)	Margin (dB)	Limit (dBuV)	Height (cm)	Angle (deg)	Remark (QP/PK/AV)
1	63.465	12.59	13.21	25.8	-14.2	40	100	385	QP
2	167.8	18.23	10.26	28.49	-15.01	43.5	150	320	QP
3	230.82	18.79	13.26	32.05	-13.95	46	100	345	QP
4	* 257.62	28.8	14.01	42.81	-3.19	46	100	340	QP
5	356.71	24.39	16.16	40.55	-5.45	46	100	10	QP
6	452.74	22.8	17.7	40.5	-5.5	46	100	179	QP

Note :

- " \* " means the worst value in this measurement data °
- Measure Level (dBμV/m) = Reading Level (dBμV) + Factor (dB) °
- Factor (dB) = Cable Loss (dB) + Antenna Factor (dB/m) °
- The emission levels of other frequencies are very lower than the limit and not show in test report °
- Other channel/mode was also verified. The test results shown represent the worst case emissions °
- No emission found between lowest internal used/generated frequency to 30MHz °

EUT	14249-RF2-B	Date of Test	2016.10.24
Factor	VULB 9162 (30MHz~8GHz)	Temp. / Humidity	25°C / 60%
Polarity	Vertical	Site / Test Engineer	AC1 / Kevin
Test Mode	Mode1	Test Voltage	By Battery

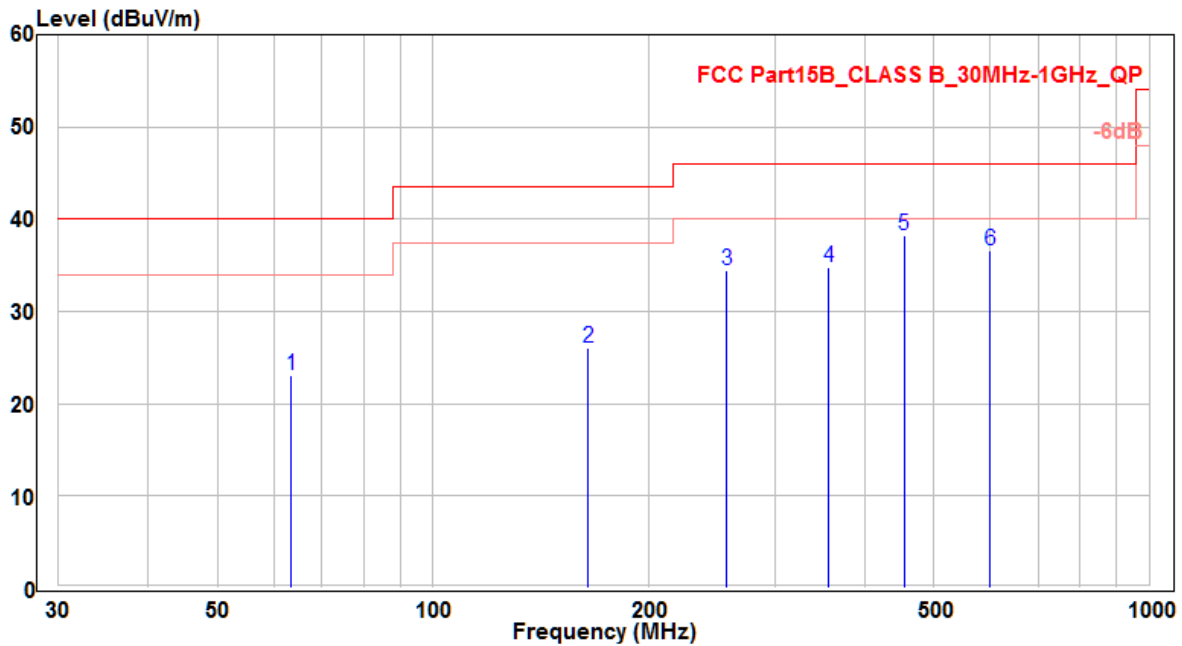

No	Frequency (MHz)	Reading (dBuV)	C.F (dB)	Measurement (dBuV/m)	Margin (dB)	Limit (dBuV)	Height (cm)	Angle (deg)	Remark (QP/PK/AV)
1	63.465	9.89	13.21	23.1	-16.9	40	100	380	QP
2	164.53	15.96	10.13	26.09	-17.41	43.5	150	210	QP
3	257.31	20.45	14	34.45	-11.55	46	100	390	QP
4	356.5	18.58	16.15	34.73	-11.27	46	100	-20	QP
5	* 454.86	20.51	17.74	38.25	-7.75	46	120	25	QP
6	598.97	16.2	20.32	36.52	-9.48	46	100	160	QP

Note :

- " \* " means the worst value in this measurement data °
- Measure Level (dBuV/m) = Reading Level (dBuV) + Factor (dB) °
- Factor (dB) = Cable Loss (dB) + Antenna Factor (dB/m) °
- The emission levels of other frequencies are very lower than the limit and not show in test report °
- Other channel/mode was also verified. The test results shown represent the worst case emissions °
- No emission found between lowest internal used/generated frequency to 30MHz °

EUT	14249-RF2-B	Test Date	2016.10.24
Factor	BBHA 9120D (1GHz~18GHz)	Temp. / Humidity	25°C / 60%
Polarity	Horizontal	Site / Engineer	AC1 / Kevin
Test Mode	MODE1-CH36	Test Voltage	By Battery

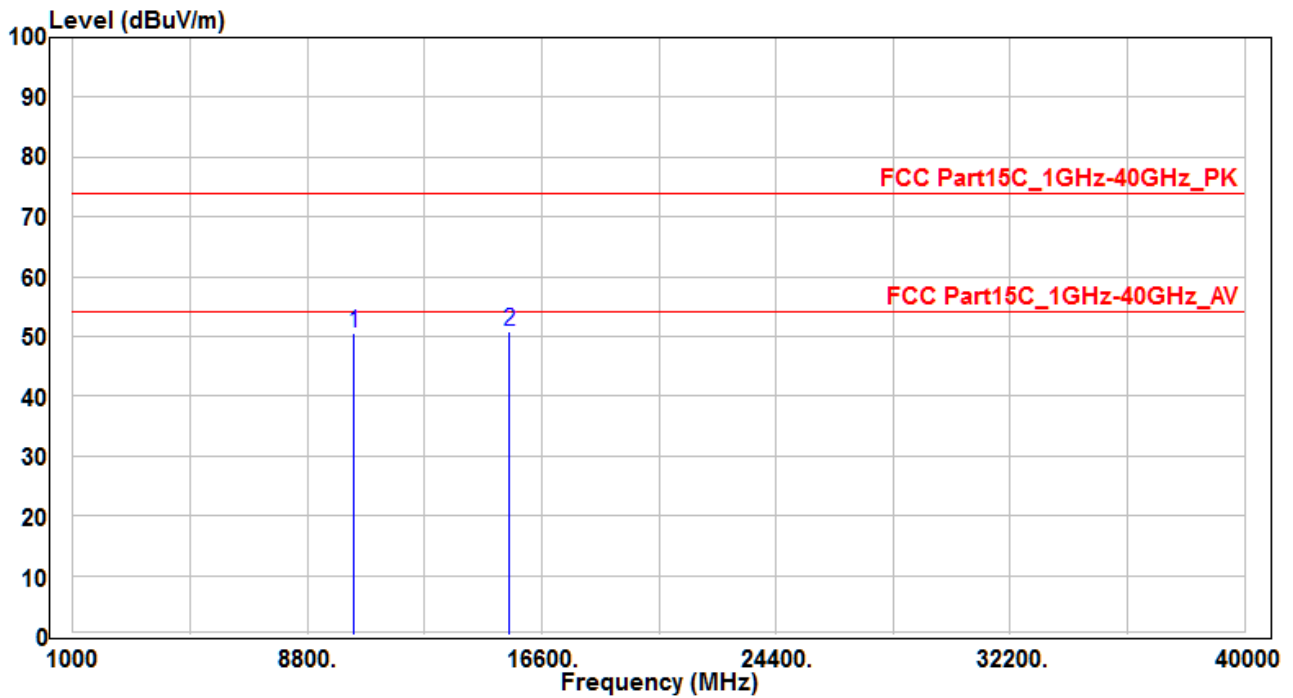

No	Frequency (MHz)	Reading (dBuV)	C.F (dB)	Measurement (dBuV/m)	Margin (dB)	Limit (dBuV)	Remark (QP/PK/AV)
1	10360	33.74	16.81	50.55	-23.45	74	Peak
2	* 15540	30.28	20.62	50.9	-23.1	74	Peak

Note :

- " \* " means the worst value in this measurement data °
- Measure Level (dBuV/m) = Reading Level (dBuV) + Factor (dB) °
- Factor (dB) = Cable Loss (dB) + Antenna Factor (dB/m) °
- The emission levels of other frequencies are very lower than the limit and not show in test report °

EUT	14249-RF2-B	Test Date	2016.10.24
Factor	BBHA 9120D (1GHz~18GHz)	Temp. / Humidity	25°C / 60%
Polarity	Vertical	Site / Engineer	AC1 / Kevin
Test Mode	MODE1-CH36	Test Voltage	By Battery

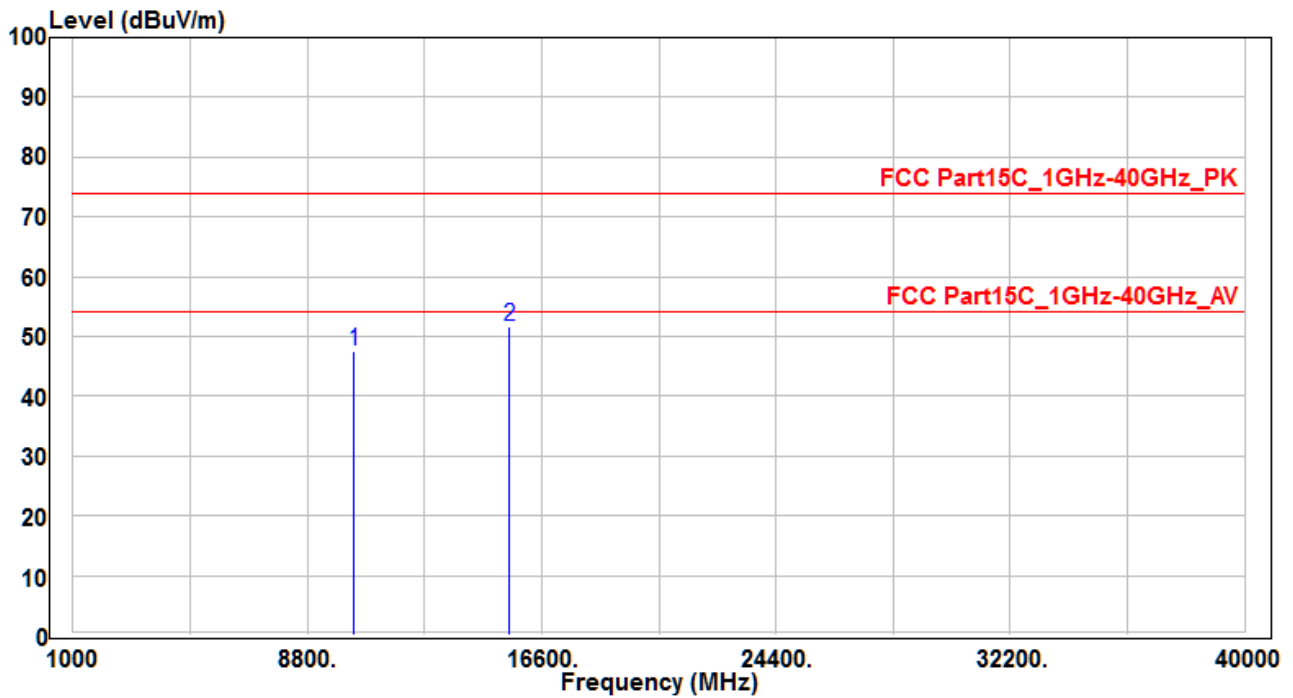

No	Frequency (MHz)	Reading (dBuV)	C.F (dB)	Measurement (dBuV/m)	Margin (dB)	Limit (dBuV)	Remark (QP/PK/AV)
1	10360	30.78	16.81	47.59	-26.41	74	Peak
2	* 15540	30.97	20.62	51.59	-22.41	74	Peak

Note :

- " \* " means the worst value in this measurement data °
- Measure Level (dBuV/m) = Reading Level (dBuV) + Factor (dB) °
- Factor (dB) = Cable Loss (dB) + Antenna Factor (dB/m) °
- The emission levels of other frequencies are very lower than the limit and not show in test report °

EUT	14249-RF2-B	Test Date	2016.10.24
Factor	BBHA 9120D (1GHz~18GHz)	Temp. / Humidity	25°C / 60%
Polarity	Horizontal	Site / Engineer	AC1 / Kevin
Test Mode	MODE1-CH44	Test Voltage	By Battery

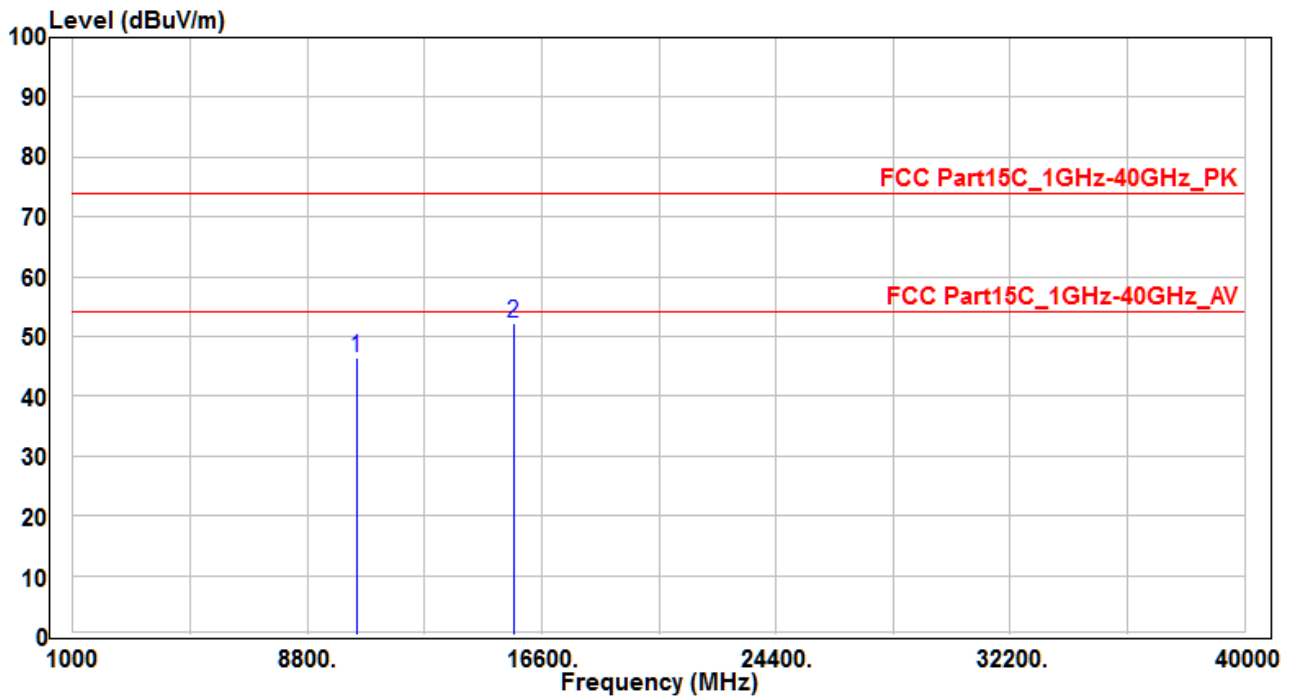

No	Frequency (MHz)	Reading (dBuV)	C.F (dB)	Measurement (dBuV/m)	Margin (dB)	Limit (dBuV)	Remark (QP/PK/AV)
1	10360	30.78	16.81	47.59	-26.41	74	Peak
2	* 15540	30.97	20.62	51.59	-22.41	74	Peak

Note :

1. " \* " means the worst value in this measurement data °
2. Measure Level (dBuV/m) = Reading Level (dBuV) + Factor (dB) °
3. Factor (dB) = Cable Loss (dB) + Antenna Factor (dB/m) °
4. The emission levels of other frequencies are very lower than the limit and not show in test report °



EUT	14249-RF2-B	Test Date	2016.10.24
Factor	BBHA 9120D (1GHz~18GHz)	Temp. / Humidity	25°C / 60%
Polarity	Vertical	Site / Engineer	AC1 / Kevin
Test Mode	MODE1-CH44	Test Voltage	By Battery

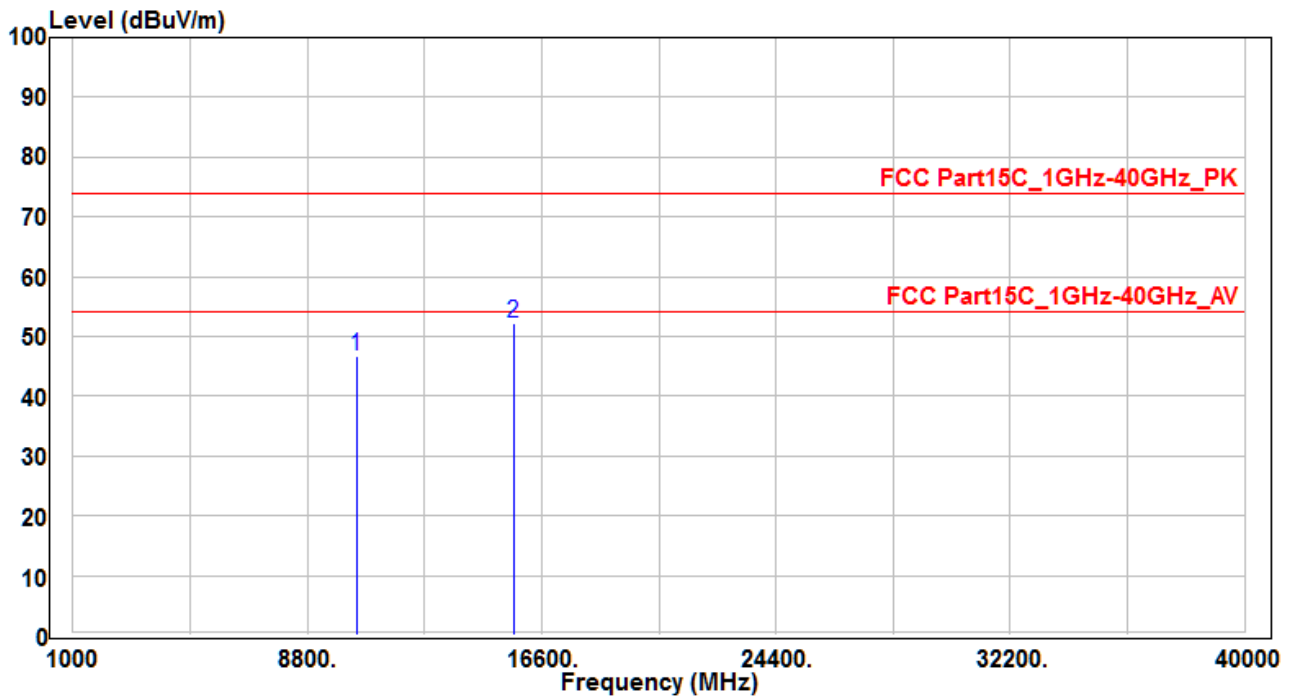

No	Frequency (MHz)	Reading (dBuV)	C.F (dB)	Measurement (dBuV/m)	Margin (dB)	Limit (dBuV)	Remark (QP/PK/AV)
1	10440	29.75	17.05	46.8	-27.2	74	Peak
2	* 15660	31.82	20.42	52.24	-21.76	74	Peak

Note :

1. " \* " means the worst value in this measurement data °
2. Measure Level (dBuV/m) = Reading Level (dBuV) + Factor (dB) °
3. Factor (dB) = Cable Loss (dB) + Antenna Factor (dB/m) °
4. The emission levels of other frequencies are very lower than the limit and not show in test report °

EUT	14249-RF2-B	Test Date	2016.10.24
Factor	BBHA 9120D (1GHz~18GHz)	Temp. / Humidity	25°C / 60%
Polarity	Horizontal	Site / Engineer	AC1 / Kevin
Test Mode	MODE1-CH48	Test Voltage	By Battery

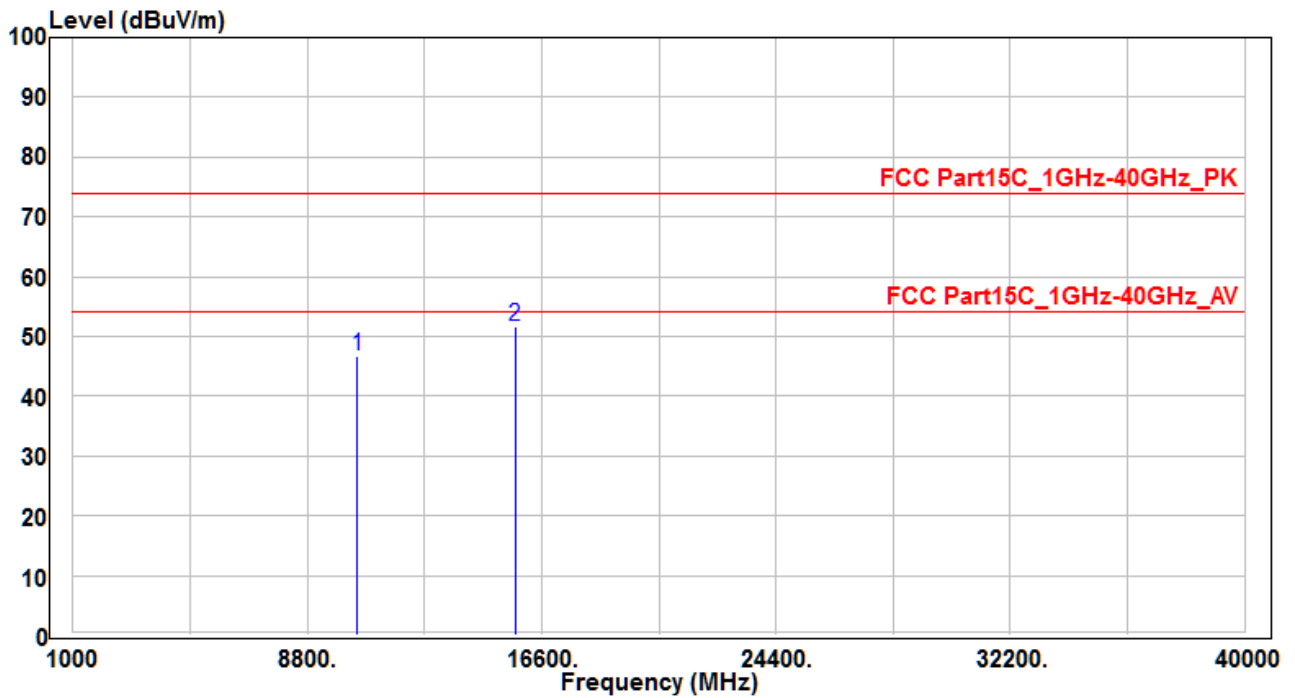

No	Frequency (MHz)	Reading (dBuV)	C.F (dB)	Measurement (dBuV/m)	Margin (dB)	Limit (dBuV)	Remark (QP/PK/AV)
1	10480	29.57	17.13	46.7	-27.3	74	Peak
2	* 15720	31.13	20.46	51.59	-22.41	74	Peak

Note :

1. " \* " means the worst value in this measurement data °
2. Measure Level (dBuV/m) = Reading Level (dBuV) + Factor (dB) °
3. Factor (dB) = Cable Loss (dB) + Antenna Factor (dB/m) °
4. The emission levels of other frequencies are very lower than the limit and not show in test report °

EUT	14249-RF2-B	Test Date	2016.10.24
Factor	BBHA 9120D (1GHz~18GHz)	Temp. / Humidity	25°C / 60%
Polarity	Vertical	Site / Engineer	AC1 / Kevin
Test Mode	MODE1-CH48	Test Voltage	By Battery

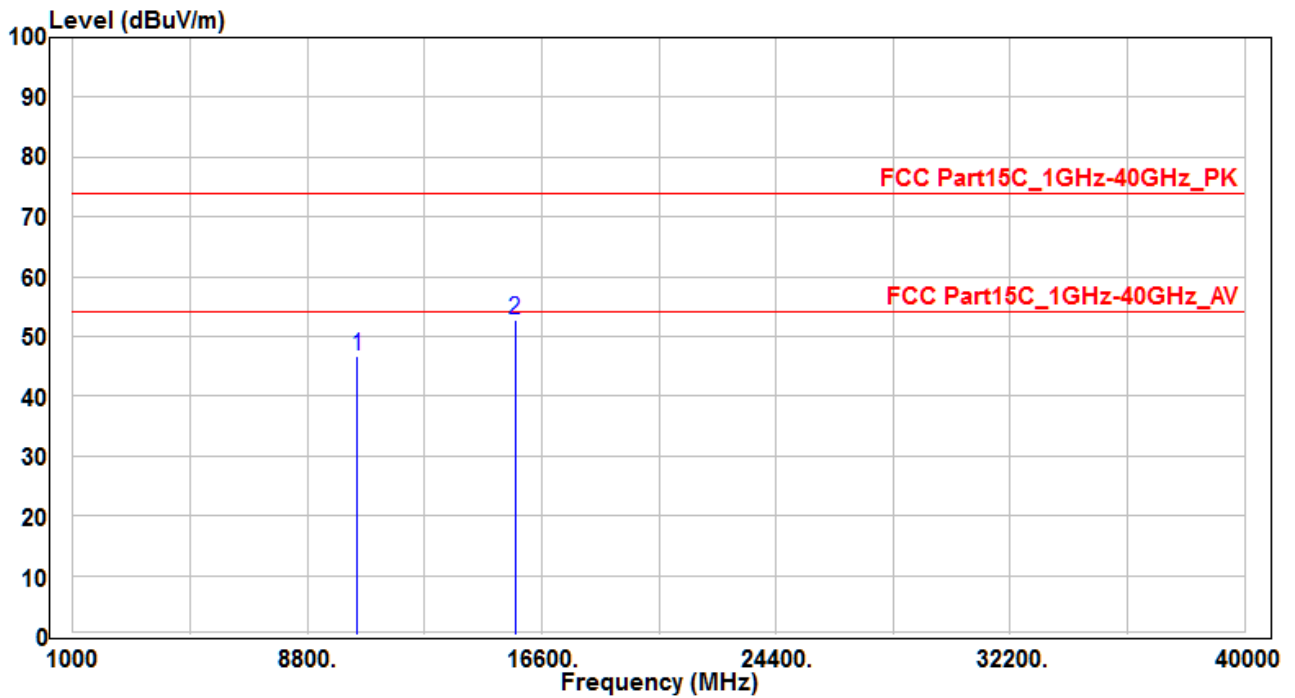

No	Frequency (MHz)	Reading (dBuV)	C.F (dB)	Measurement (dBuV/m)	Margin (dB)	Limit (dBuV)	Remark (QP/PK/AV)
1	10480	29.59	17.13	46.72	-27.28	74	Peak
2	* 15720	32.42	20.46	52.88	-21.12	74	Peak

Note :

- " \* " means the worst value in this measurement data °
- Measure Level (dBuV/m) = Reading Level (dBuV) + Factor (dB) °
- Factor (dB) = Cable Loss (dB) + Antenna Factor (dB/m) °
- The emission levels of other frequencies are very lower than the limit and not show in test report °

EUT	14249-RF2-B	Test Date	2016.10.24
Factor	BBHA 9120D (1GHz~18GHz)	Temp. / Humidity	25°C / 60%
Polarity	Horizontal	Site / Engineer	AC1 / Kevin
Test Mode	MODE1-CH149	Test Voltage	By Battery

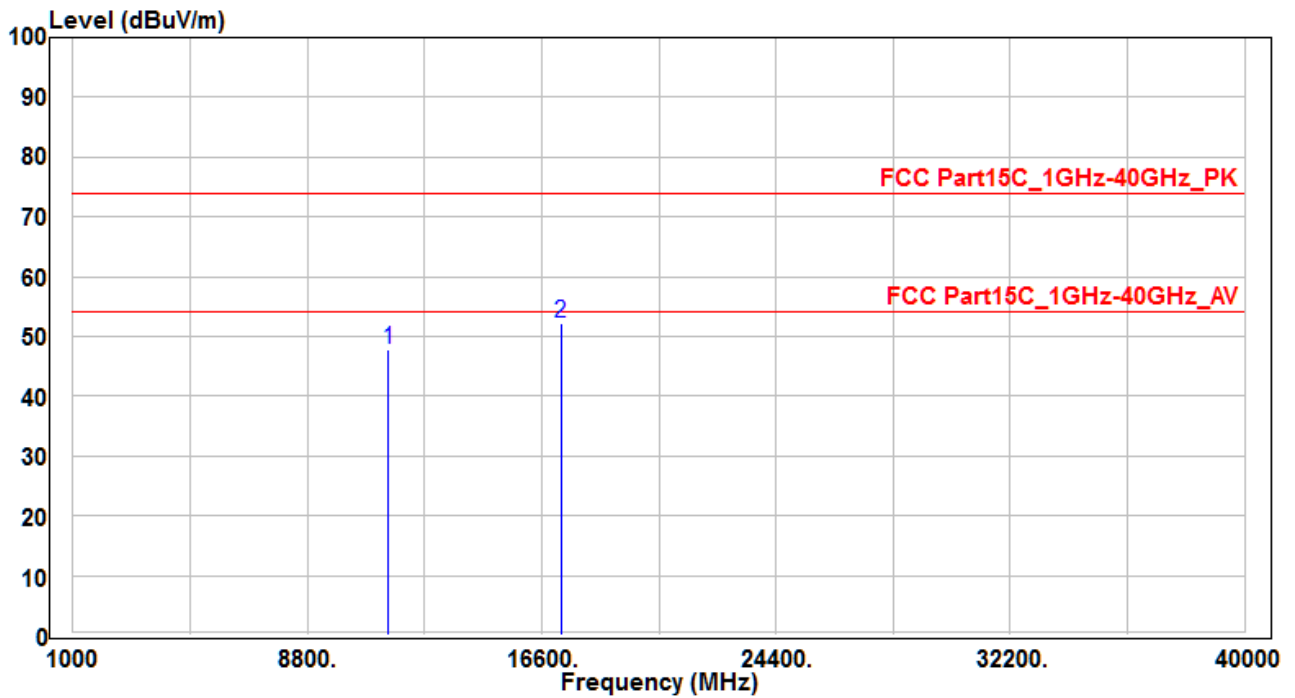

No	Frequency (MHz)	Reading (dBuV)	C.F (dB)	Measurement (dBuV/m)	Margin (dB)	Limit (dBuV)	Remark (QP/PK/AV)
1	11490	28.57	19.33	47.9	-26.1	74	Peak
2	* 17235	26.72	25.45	52.17	-21.83	74	Peak

Note :

- " \* " means the worst value in this measurement data °
- Measure Level (dBuV/m) = Reading Level (dBuV) + Factor (dB) °
- Factor (dB) = Cable Loss (dB) + Antenna Factor (dB/m) °
- The emission levels of other frequencies are very lower than the limit and not show in test report °

EUT	14249-RF2-B	Test Date	2016.10.24
Factor	BBHA 9120D (1GHz~18GHz)	Temp. / Humidity	25°C / 60%
Polarity	Vertical	Site / Engineer	AC1 / Kevin
Test Mode	MODE1-CH149	Test Voltage	By Battery

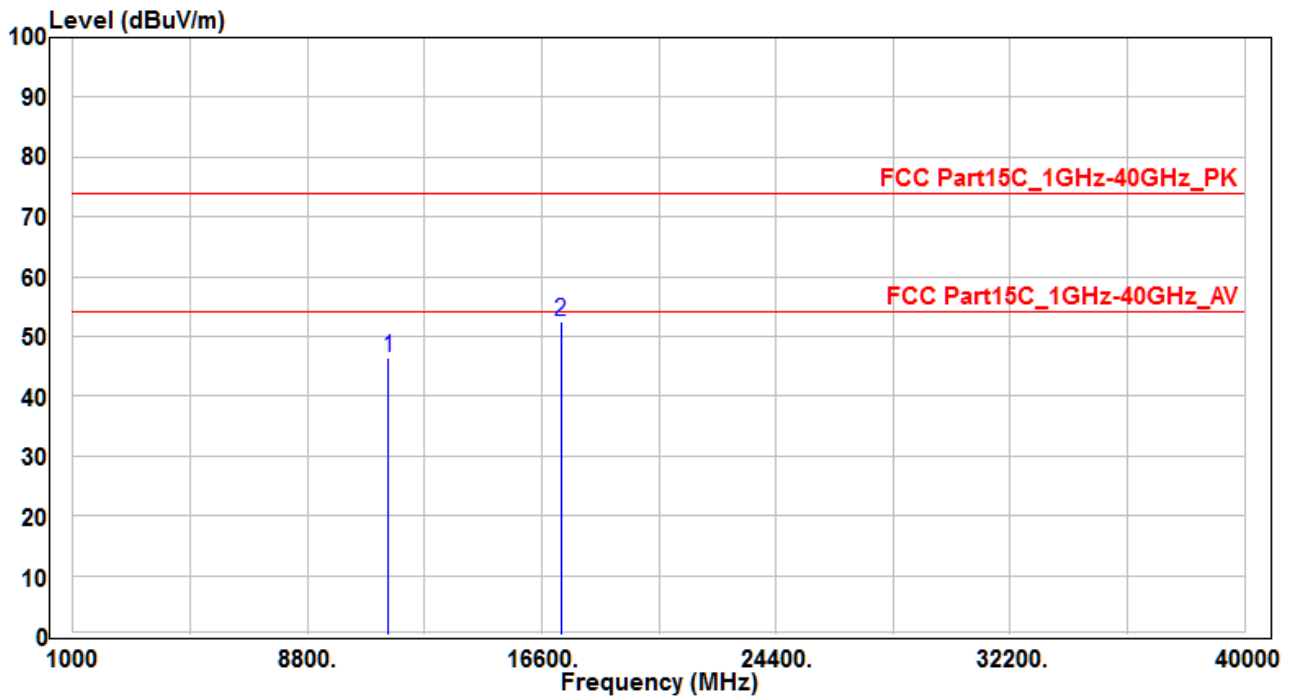

No	Frequency (MHz)	Reading (dBuV)	C.F (dB)	Measurement (dBuV/m)	Margin (dB)	Limit (dBuV)	Remark (QP/PK/AV)
1	11490	27.03	19.33	46.36	-27.64	74	Peak
2	* 17235	26.9	25.45	52.35	-21.65	74	Peak

Note :

1. " \* " means the worst value in this measurement data °
2. Measure Level (dBuV/m) = Reading Level (dBuV) + Factor (dB) °
3. Factor (dB) = Cable Loss (dB) + Antenna Factor (dB/m) °
4. The emission levels of other frequencies are very lower than the limit and not show in test report °

EUT	14249-RF2-B	Test Date	2016.10.24
Factor	BBHA 9120D (1GHz~18GHz)	Temp. / Humidity	25°C / 60%
Polarity	Horizontal	Site / Engineer	AC1 / Kevin
Test Mode	MODE1-CH157	Test Voltage	By Battery

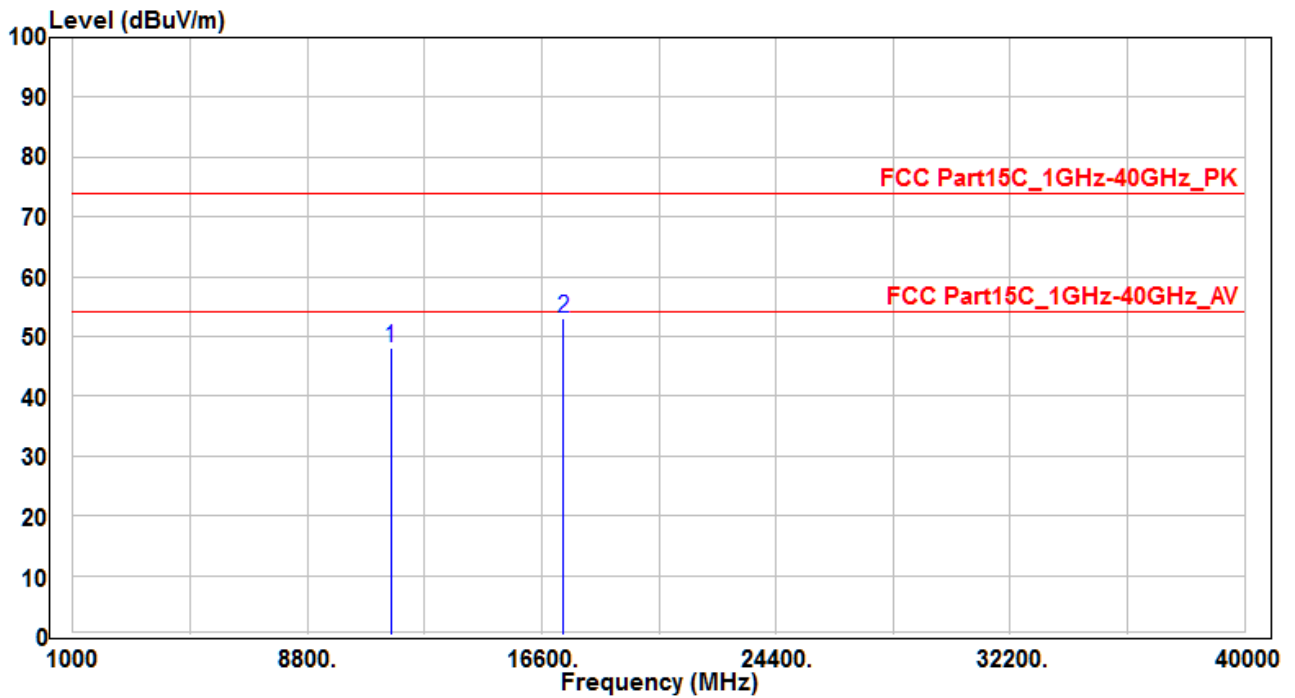

No	Frequency (MHz)	Reading (dBuV)	C.F (dB)	Measurement (dBuV/m)	Margin (dB)	Limit (dBuV)	Remark (QP/PK/AV)
1	11570	28.59	19.46	48.05	-25.95	74	Peak
2	* 17335	26.83	26.07	52.9	-21.1	74	Peak

Note :

- " \* " means the worst value in this measurement data °
- Measure Level (dBuV/m) = Reading Level (dBuV) + Factor (dB) °
- Factor (dB) = Cable Loss (dB) + Antenna Factor (dB/m) °
- The emission levels of other frequencies are very lower than the limit and not show in test report °

EUT	14249-RF2-B	Test Date	2016.10.24
Factor	BBHA 9120D (1GHz~18GHz)	Temp. / Humidity	25°C / 60%
Polarity	Vertical	Site / Engineer	AC1 / Kevin
Test Mode	MODE1-CH157	Test Voltage	By Battery

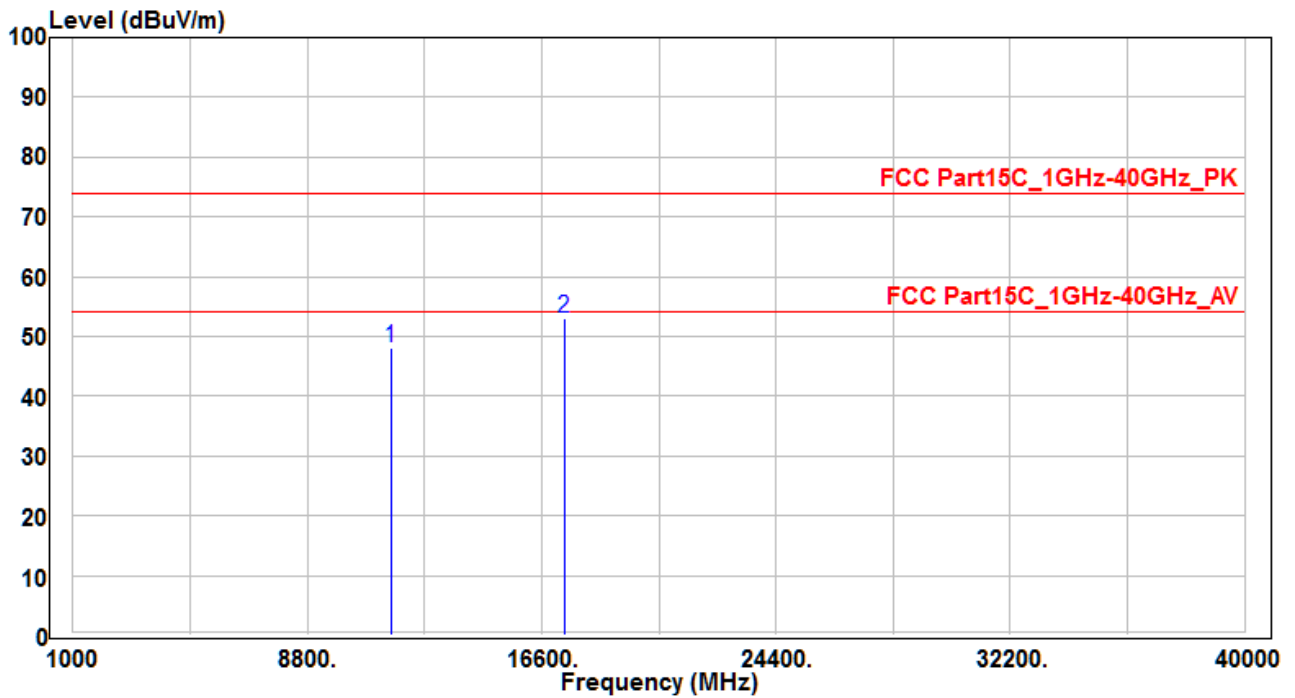

No	Frequency (MHz)	Reading (dBuV)	C.F (dB)	Measurement (dBuV/m)	Margin (dB)	Limit (dBuV)	Remark (QP/PK/AV)
1	11570	28.55	19.46	48.01	-25.99	74	Peak
2	* 17355	26.79	26.2	52.99	-21.01	74	Peak

Note :

- " \* " means the worst value in this measurement data °
- Measure Level (dBuV/m) = Reading Level (dBuV) + Factor (dB) °
- Factor (dB) = Cable Loss (dB) + Antenna Factor (dB/m) °
- The emission levels of other frequencies are very lower than the limit and not show in test report °

EUT	14249-RF2-B	Test Date	2016.10.24
Factor	BBHA 9120D (1GHz~18GHz)	Temp. / Humidity	25°C / 60%
Polarity	Horizontal	Site / Engineer	AC1 / Kevin
Test Mode	MODE1-CH165	Test Voltage	By Battery

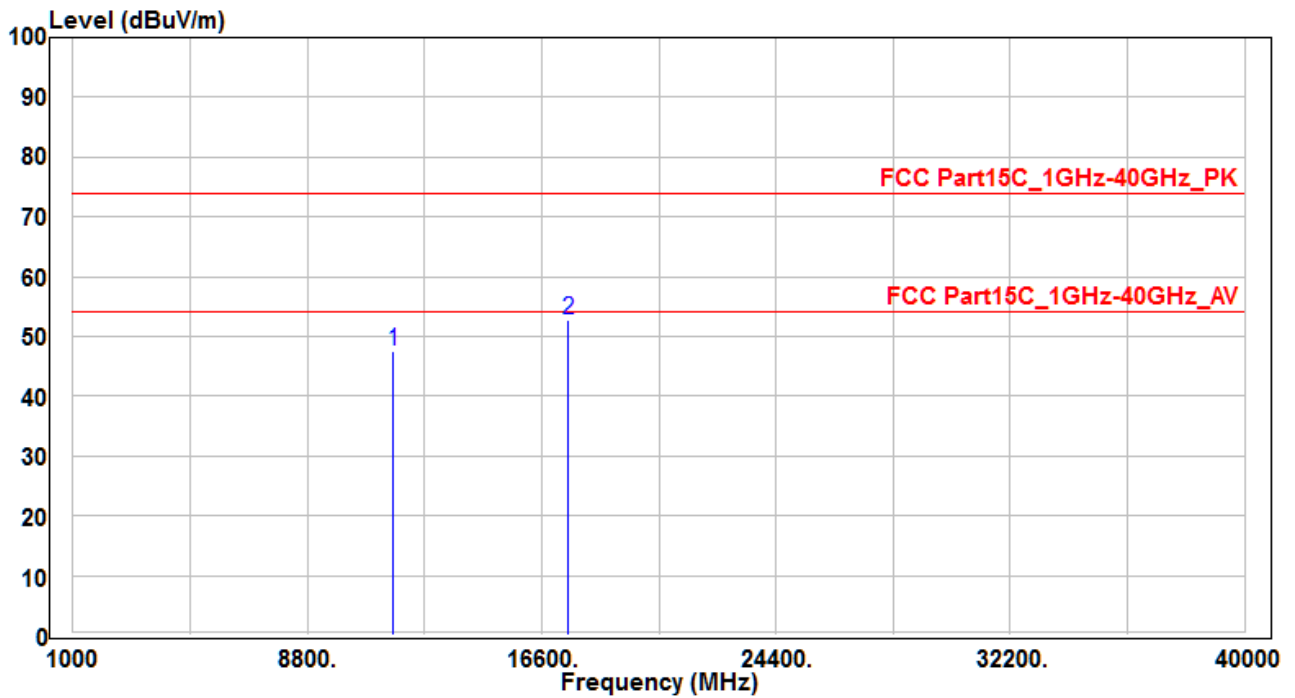

No	Frequency (MHz)	Reading (dBuV)	C.F (dB)	Measurement (dBuV/m)	Margin (dB)	Limit (dBuV)	Remark (QP/PK/AV)
1	11650	28.26	19.33	47.59	-26.41	74	Peak
2	* 17475	25.93	26.88	52.81	-21.19	74	Peak

Note :

- " \* " means the worst value in this measurement data °
- Measure Level (dBuV/m) = Reading Level (dBuV) + Factor (dB) °
- Factor (dB) = Cable Loss (dB) + Antenna Factor (dB/m) °
- The emission levels of other frequencies are very lower than the limit and not show in test report °



EUT	14249-RF2-B	Test Date	2016.10.24
Factor	BBHA 9120D (1GHz~18GHz)	Temp. / Humidity	25°C / 60%
Polarity	Vertical	Site / Engineer	AC1 / Kevin
Test Mode	MODE1-CH165	Test Voltage	By Battery

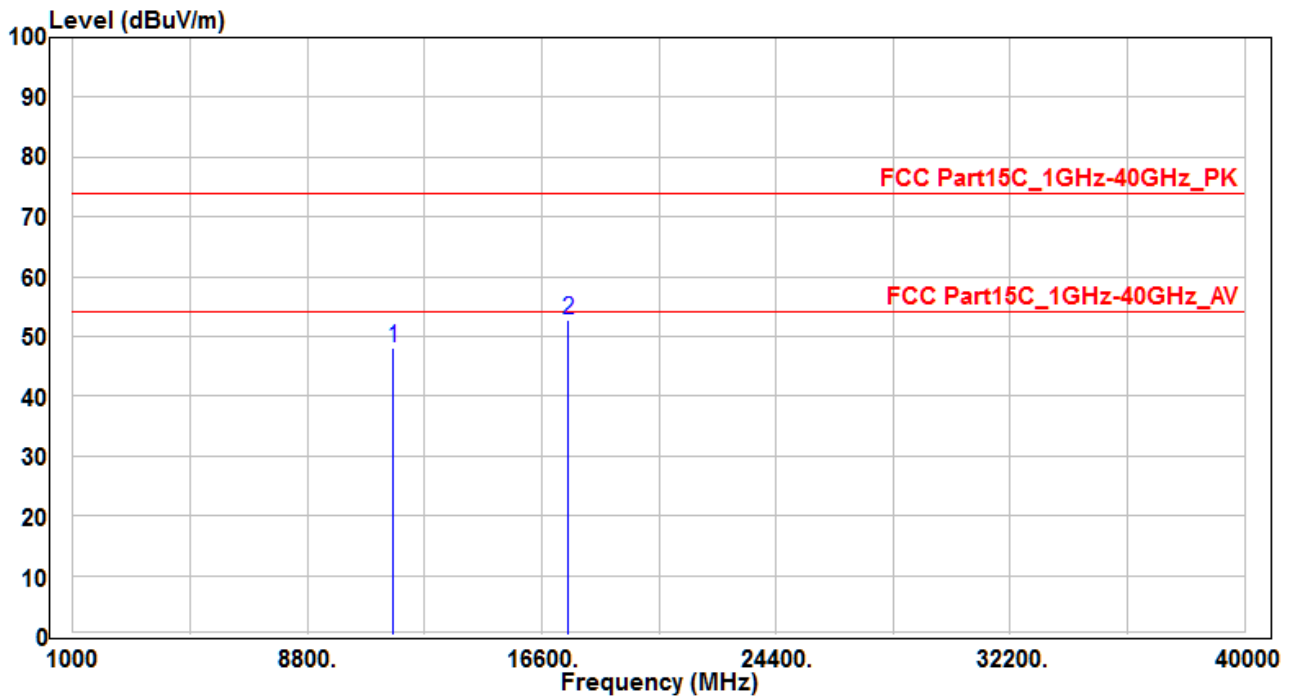

No	Frequency (MHz)	Reading (dBuV)	C.F (dB)	Measurement (dBuV/m)	Margin (dB)	Limit (dBuV)	Remark (QP/PK/AV)
1	11650	28.84	19.33	48.17	-25.83	74	Peak
2	* 17475	25.96	26.88	52.84	-21.16	74	Peak

Note :

1. " \* " means the worst value in this measurement data °
2. Measure Level (dBuV/m) = Reading Level (dBuV) + Factor (dB) °
3. Factor (dB) = Cable Loss (dB) + Antenna Factor (dB/m) °
4. The emission levels of other frequencies are very lower than the limit and not show in test report °

EUT	14249-RF2-B	Test Date	2016.10.24
Factor	BBHA 9120D (1GHz~18GHz)	Temp. / Humidity	25°C / 60%
Polarity	Horizontal	Site / Engineer	AC1 / Kevin
Test Mode	MODE2-CH36	Test Voltage	By Battery

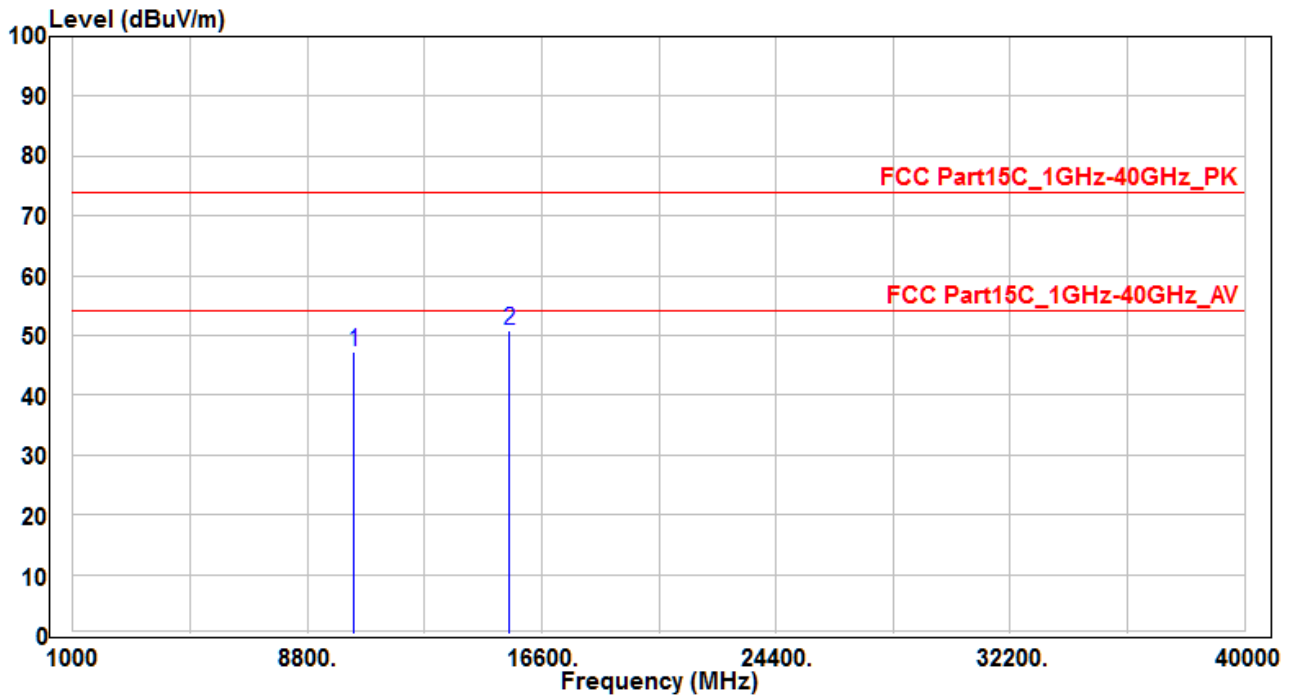

No	Frequency (MHz)	Reading (dBuV)	C.F (dB)	Measurement (dBuV/m)	Margin (dB)	Limit (dBuV)	Remark (QP/PK/AV)
1	10360	30.32	16.81	47.13	-26.87	74	Peak
2	* 15540	30.11	20.62	50.73	-23.27	74	Peak

Note :

1. " \* " means the worst value in this measurement data ◦
2. Measure Level (dBuV/m) = Reading Level (dBuV) + Factor (dB) ◦
3. Factor (dB) = Cable Loss (dB) + Antenna Factor (dB/m) ◦
4. The emission levels of other frequencies are very lower than the limit and not show in test report ◦

EUT	14249-RF2-B	Test Date	2016.10.24
Factor	BBHA 9120D (1GHz~18GHz)	Temp. / Humidity	25°C / 60%
Polarity	Vertical	Site / Engineer	AC1 / Kevin
Test Mode	MODE2-CH36	Test Voltage	By Battery

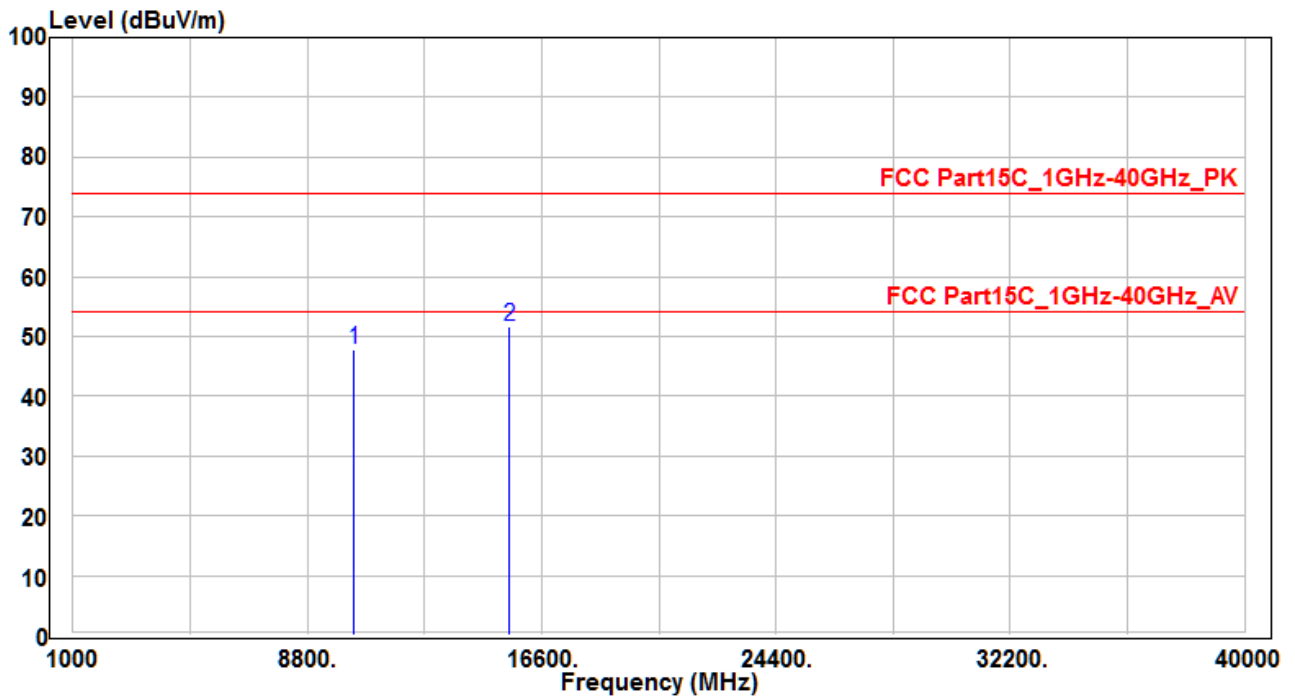

No	Frequency (MHz)	Reading (dBuV)	C.F (dB)	Measurement (dBuV/m)	Margin (dB)	Limit (dBuV)	Remark (QP/PK/AV)
1	10360	30.94	16.81	47.75	-26.25	74	Peak
2	* 15540	30.95	20.62	51.57	-22.43	74	Peak

Note :

- " \* " means the worst value in this measurement data °
- Measure Level (dBuV/m) = Reading Level (dBuV) + Factor (dB) °
- Factor (dB) = Cable Loss (dB) + Antenna Factor (dB/m) °
- The emission levels of other frequencies are very lower than the limit and not show in test report °

EUT	14249-RF2-B	Test Date	2016.10.24
Factor	BBHA 9120D (1GHz~18GHz)	Temp. / Humidity	25°C / 60%
Polarity	Horizontal	Site / Engineer	AC1 / Kevin
Test Mode	MODE2-CH44	Test Voltage	By Battery

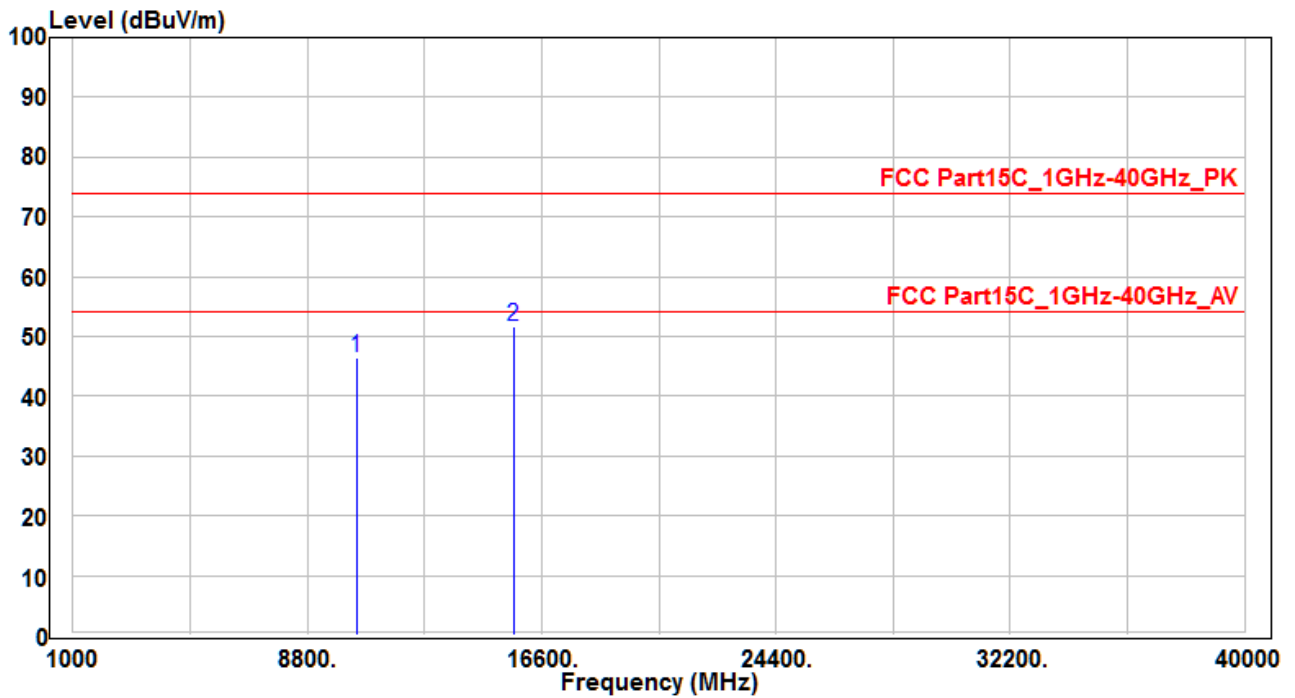

No	Frequency (MHz)	Reading (dBuV)	C.F (dB)	Measurement (dBuV/m)	Margin (dB)	Limit (dBuV)	Remark (QP/PK/AV)
1	10440	29.4	17.05	46.45	-27.55	74	Peak
2	* 15660	31.28	20.42	51.7	-22.3	74	Peak

Note :

- " \* " means the worst value in this measurement data °
- Measure Level (dBuV/m) = Reading Level (dBuV) + Factor (dB) °
- Factor (dB) = Cable Loss (dB) + Antenna Factor (dB/m) °
- The emission levels of other frequencies are very lower than the limit and not show in test report °

EUT	14249-RF2-B	Test Date	2016.10.24
Factor	BBHA 9120D (1GHz~18GHz)	Temp. / Humidity	25°C / 60%
Polarity	Vertical	Site / Engineer	AC1 / Kevin
Test Mode	MODE2-CH44	Test Voltage	By Battery

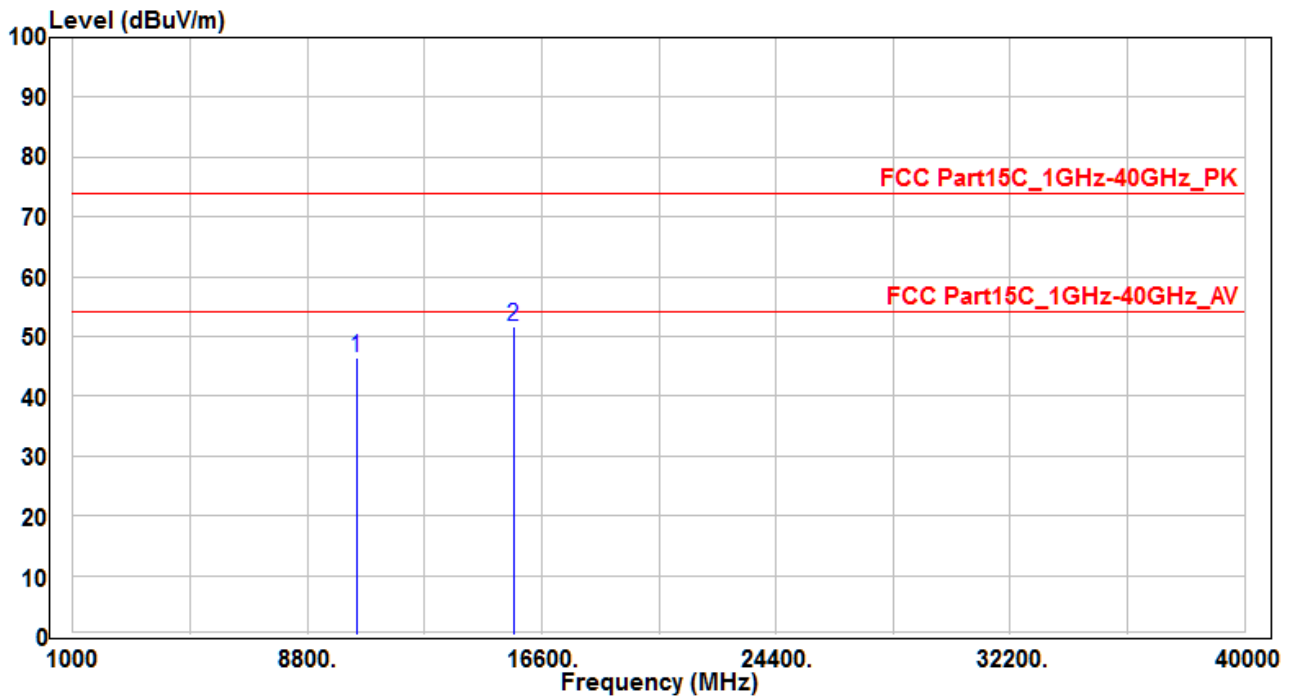

No	Frequency (MHz)	Reading (dBuV)	C.F (dB)	Measurement (dBuV/m)	Margin (dB)	Limit (dBuV)	Remark (QP/PK/AV)
1	10440	29.41	17.05	46.46	-27.54	74	Peak
2	* 15660	31.17	20.42	51.59	-22.41	74	Peak

Note :

1. " \* " means the worst value in this measurement data °
2. Measure Level (dBuV/m) = Reading Level (dBuV) + Factor (dB) °
3. Factor (dB) = Cable Loss (dB) + Antenna Factor (dB/m) °
4. The emission levels of other frequencies are very lower than the limit and not show in test report °

EUT	14249-RF2-B	Test Date	2016.10.24
Factor	BBHA 9120D (1GHz~18GHz)	Temp. / Humidity	25°C / 60%
Polarity	Horizontal	Site / Engineer	AC1 / Kevin
Test Mode	MODE2-CH48	Test Voltage	By Battery

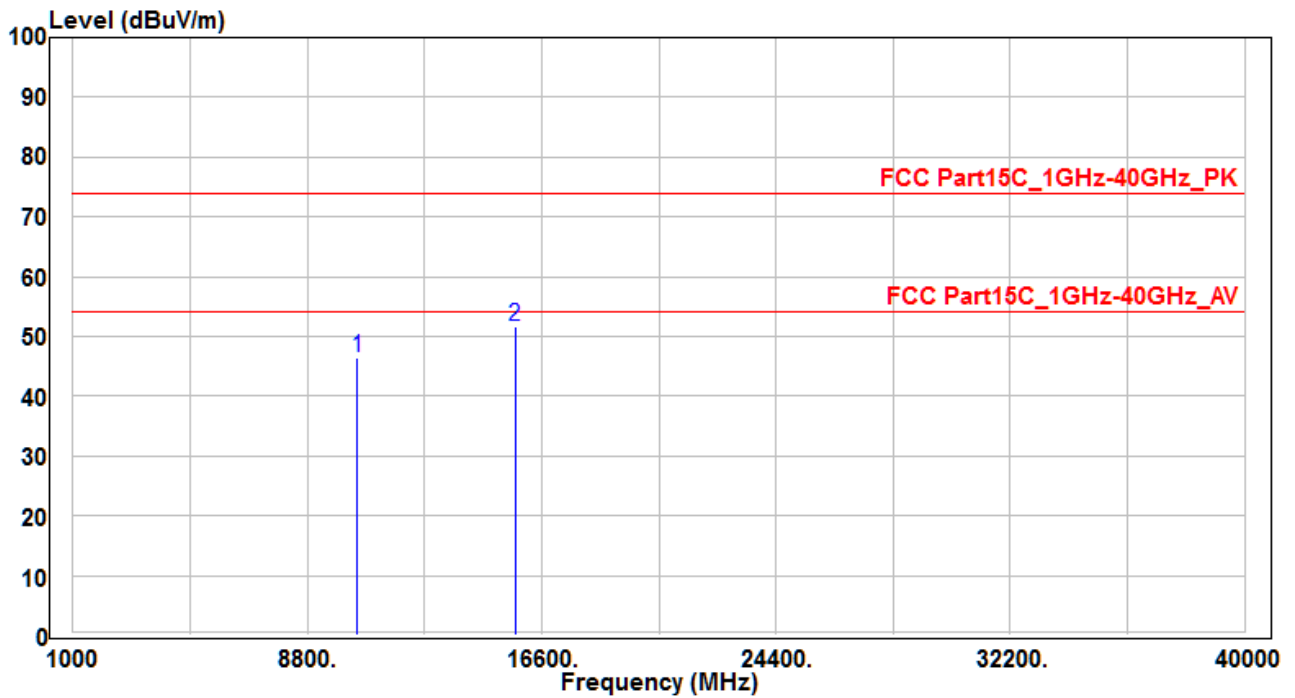

No	Frequency (MHz)	Reading (dBuV)	C.F (dB)	Measurement (dBuV/m)	Margin (dB)	Limit (dBuV)	Remark (QP/PK/AV)
1	10480	29.38	17.13	46.51	-27.49	74	Peak
2	* 15720	31.2	20.46	51.66	-22.34	74	Peak

Note :

- " \* " means the worst value in this measurement data °
- Measure Level (dBuV/m) = Reading Level (dBuV) + Factor (dB) °
- Factor (dB) = Cable Loss (dB) + Antenna Factor (dB/m) °
- The emission levels of other frequencies are very lower than the limit and not show in test report °

EUT	14249-RF2-B	Test Date	2016.10.24
Factor	BBHA 9120D (1GHz~18GHz)	Temp. / Humidity	25°C / 60%
Polarity	Vertical	Site / Engineer	AC1 / Kevin
Test Mode	MODE2-CH48	Test Voltage	By Battery

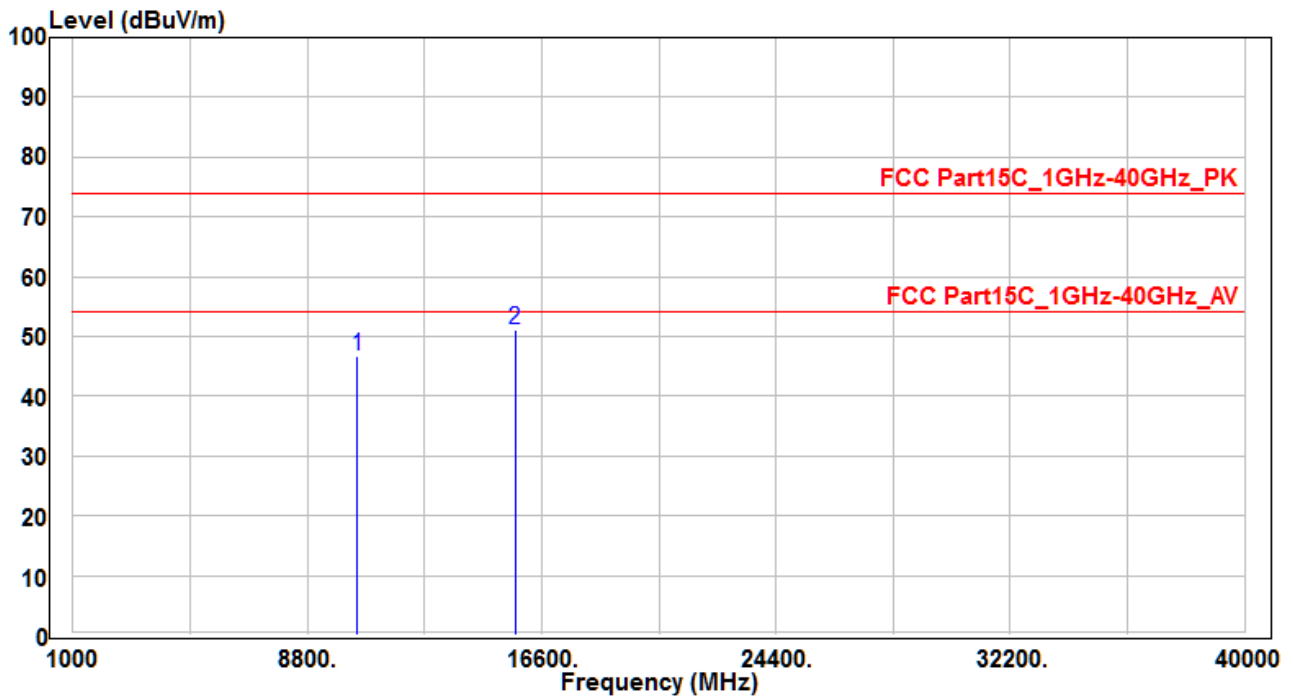

No	Frequency (MHz)	Reading (dBuV)	C.F (dB)	Measurement (dBuV/m)	Margin (dB)	Limit (dBuV)	Remark (QP/PK/AV)
1	10480	29.65	17.13	46.78	-27.22	74	Peak
2	* 15720	30.74	20.46	51.2	-22.8	74	Peak

Note :

- " \* " means the worst value in this measurement data °
- Measure Level (dBuV/m) = Reading Level (dBuV) + Factor (dB) °
- Factor (dB) = Cable Loss (dB) + Antenna Factor (dB/m) °
- The emission levels of other frequencies are very lower than the limit and not show in test report °

EUT	14249-RF2-B	Test Date	2016.10.24
Factor	BBHA 9120D (1GHz~18GHz)	Temp. / Humidity	25°C / 60%
Polarity	Horizontal	Site / Engineer	AC1 / Kevin
Test Mode	MODE2-CH149	Test Voltage	By Battery

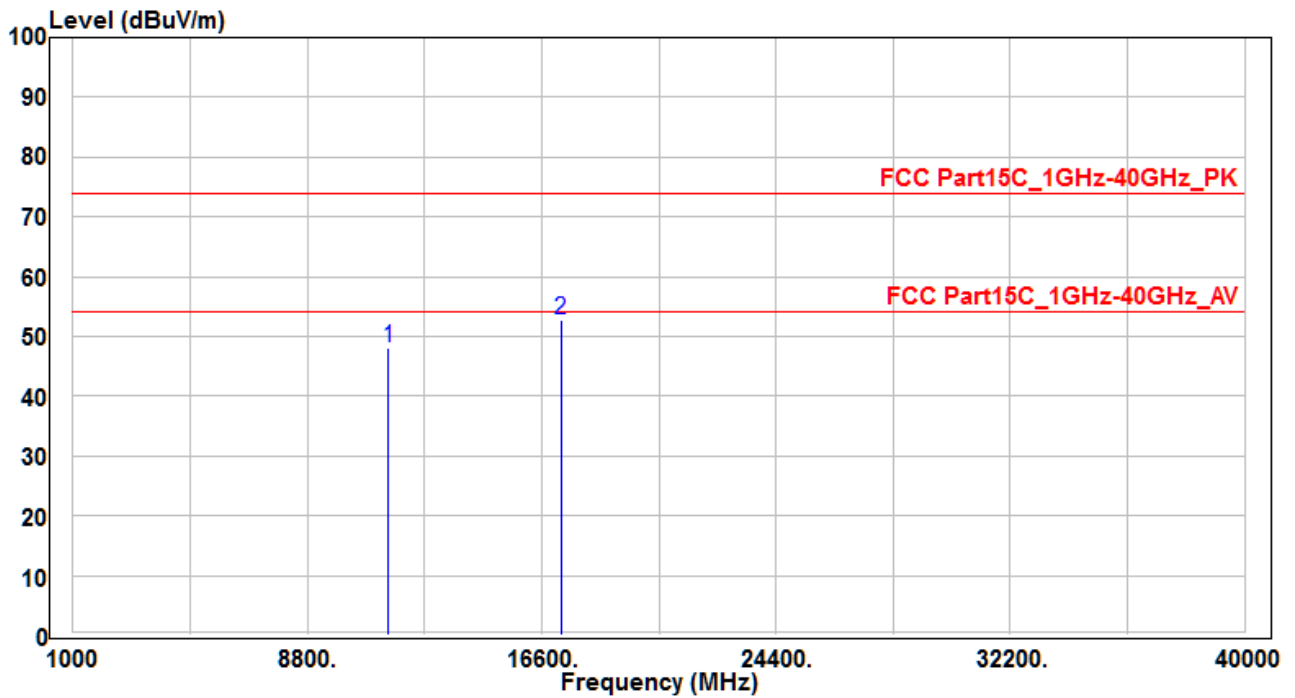

No	Frequency (MHz)	Reading (dBuV)	C.F (dB)	Measurement (dBuV/m)	Margin (dB)	Limit (dBuV)	Remark (QP/PK/AV)
1	11490	28.67	19.33	48	-26	74	Peak
2	* 17235	27.42	25.45	52.87	-21.13	74	Peak

Note :

- " \* " means the worst value in this measurement data °
- Measure Level (dBuV/m) = Reading Level (dBuV) + Factor (dB) °
- Factor (dB) = Cable Loss (dB) + Antenna Factor (dB/m) °
- The emission levels of other frequencies are very lower than the limit and not show in test report °



EUT	14249-RF2-B	Test Date	2016.10.24
Factor	BBHA 9120D (1GHz~18GHz)	Temp. / Humidity	25°C / 60%
Polarity	Vertical	Site / Engineer	AC1 / Kevin
Test Mode	MODE2-CH3149	Test Voltage	By Battery

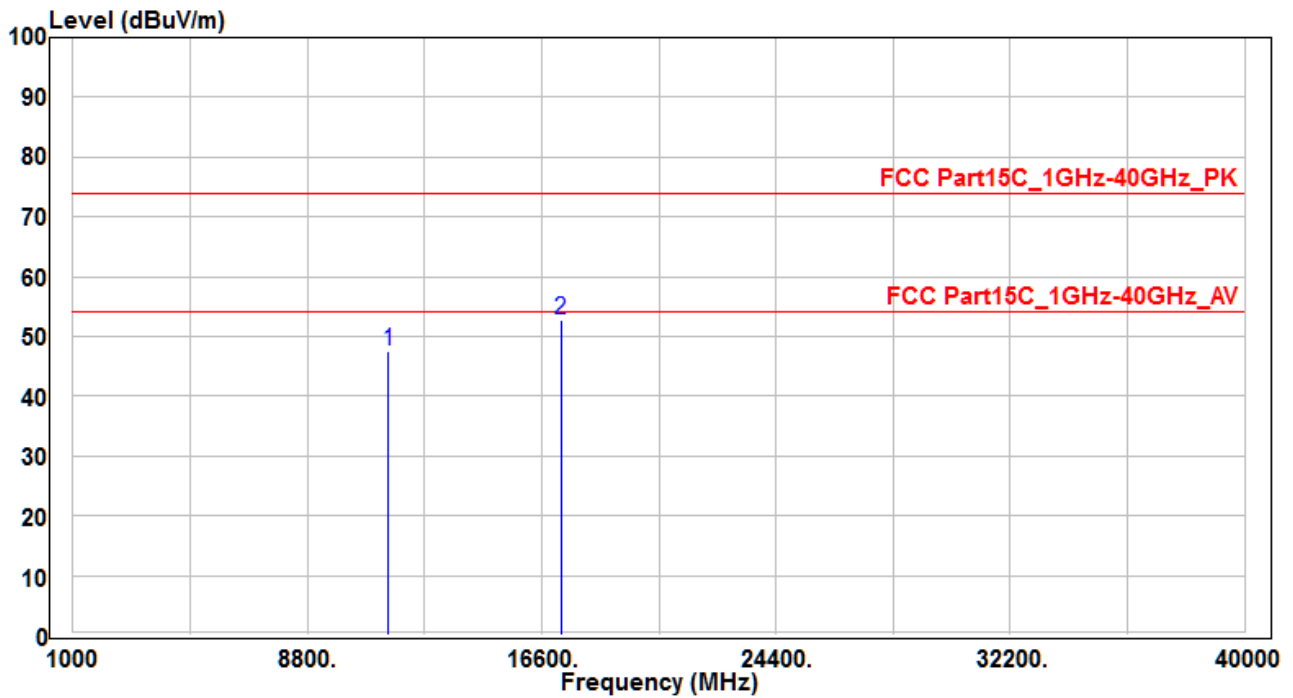

No	Frequency (MHz)	Reading (dBuV)	C.F (dB)	Measurement (dBuV/m)	Margin (dB)	Limit (dBuV)	Remark (QP/PK/AV)
1	11490	28.09	19.33	47.42	-26.58	74	Peak
2	* 17235	27.18	25.45	52.63	-21.37	74	Peak

Note :

- " \* " means the worst value in this measurement data °
- Measure Level (dBuV/m) = Reading Level (dBuV) + Factor (dB) °
- Factor (dB) = Cable Loss (dB) + Antenna Factor (dB/m) °
- The emission levels of other frequencies are very lower than the limit and not show in test report °

EUT	14249-RF2-B	Test Date	2016.10.24
Factor	BBHA 9120D (1GHz~18GHz)	Temp. / Humidity	25°C / 60%
Polarity	Horizontal	Site / Engineer	AC1 / Kevin
Test Mode	MODE2-CH157	Test Voltage	By Battery

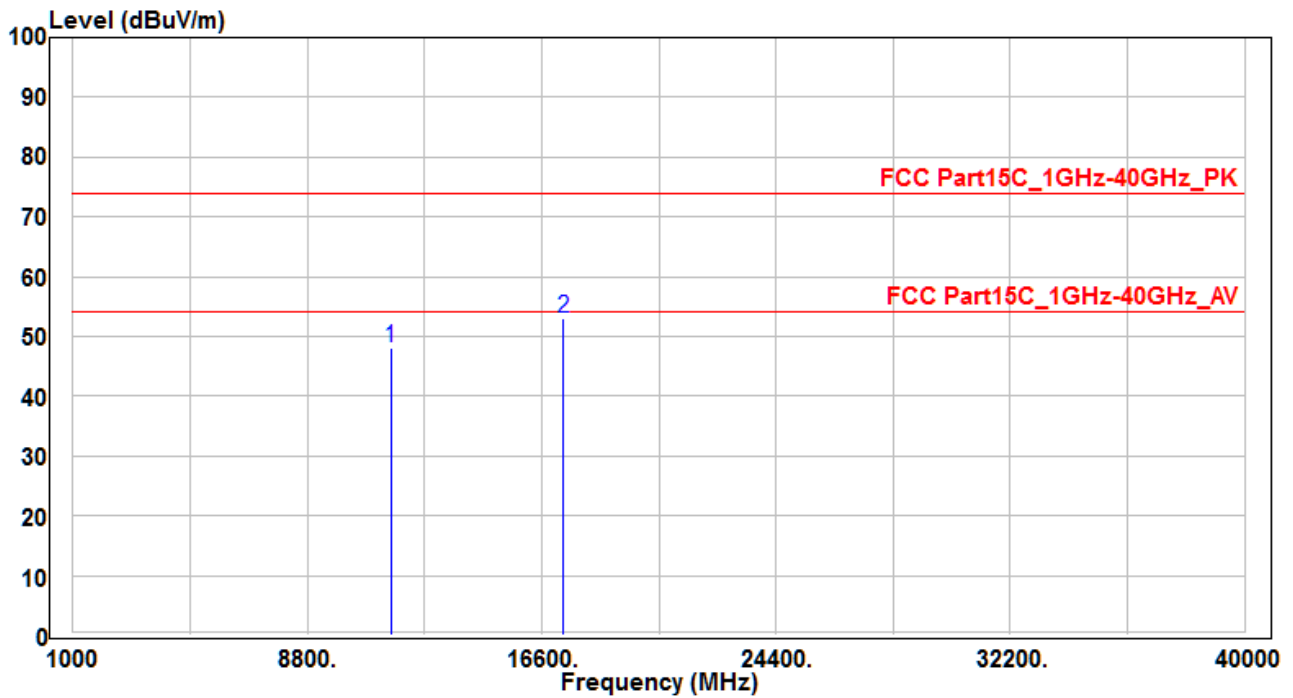

No	Frequency (MHz)	Reading (dBuV)	C.F (dB)	Measurement (dBuV/m)	Margin (dB)	Limit (dBuV)	Remark (QP/PK/AV)
1	11570	28.53	19.46	47.99	-26.01	74	Peak
2	* 17335	27.03	26.07	53.1	-20.9	74	Peak

Note :

1. " \* " means the worst value in this measurement data °
2. Measure Level (dBuV/m) = Reading Level (dBuV) + Factor (dB) °
3. Factor (dB) = Cable Loss (dB) + Antenna Factor (dB/m) °
4. The emission levels of other frequencies are very lower than the limit and not show in test report °

EUT	14249-RF2-B	Test Date	2016.10.24
Factor	BBHA 9120D (1GHz~18GHz)	Temp. / Humidity	25°C / 60%
Polarity	Vertical	Site / Engineer	AC1 / Kevin
Test Mode	MODE2-CH157	Test Voltage	By Battery

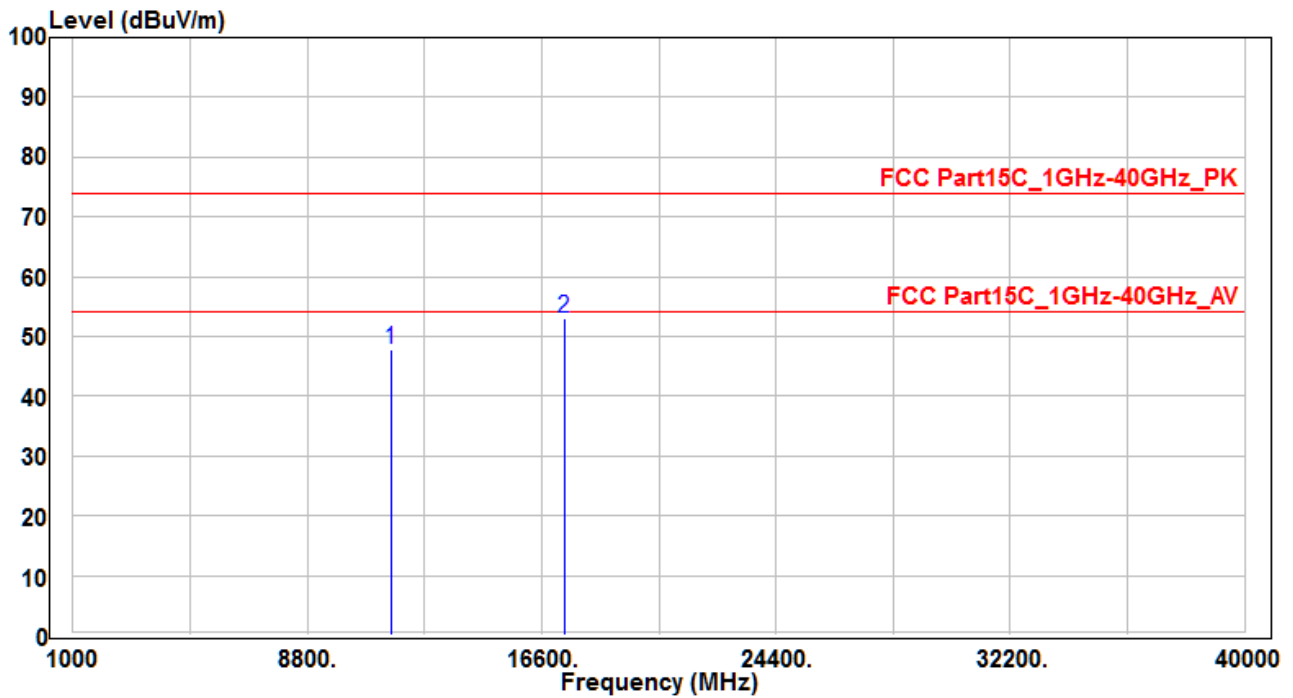

No	Frequency (MHz)	Reading (dBuV)	C.F (dB)	Measurement (dBuV/m)	Margin (dB)	Limit (dBuV)	Remark (QP/PK/AV)
1	11570	28.34	19.46	47.8	-26.2	74	Peak
2	* 17355	26.95	26.2	53.15	-20.85	74	Peak

Note :

- " \* " means the worst value in this measurement data °
- Measure Level (dBuV/m) = Reading Level (dBuV) + Factor (dB) °
- Factor (dB) = Cable Loss (dB) + Antenna Factor (dB/m) °
- The emission levels of other frequencies are very lower than the limit and not show in test report °

EUT	14249-RF2-B	Test Date	2016.10.24
Factor	BBHA 9120D (1GHz~18GHz)	Temp. / Humidity	25°C / 60%
Polarity	Horizontal	Site / Engineer	AC1 / Kevin
Test Mode	MODE2-CH165	Test Voltage	By Battery

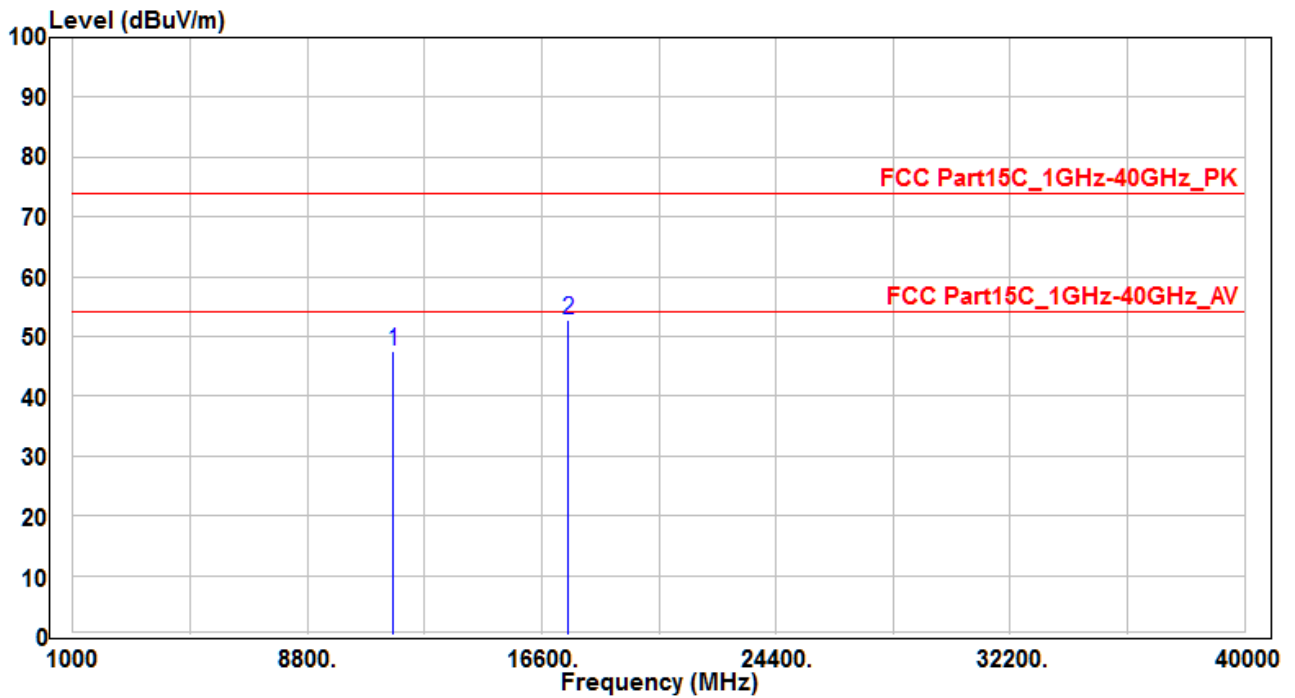

No	Frequency (MHz)	Reading (dBuV)	C.F (dB)	Measurement (dBuV/m)	Margin (dB)	Limit (dBuV)	Remark (QP/PK/AV)
1	11650	28.21	19.33	47.54	-26.46	74	Peak
2	* 17475	25.89	26.88	52.77	-21.23	74	Peak

Note :

- " \* " means the worst value in this measurement data °
- Measure Level (dBuV/m) = Reading Level (dBuV) + Factor (dB) °
- Factor (dB) = Cable Loss (dB) + Antenna Factor (dB/m) °
- The emission levels of other frequencies are very lower than the limit and not show in test report °

EUT	14249-RF2-B	Test Date	2016.10.24
Factor	BBHA 9120D (1GHz~18GHz)	Temp. / Humidity	25°C / 60%
Polarity	Vertical	Site / Engineer	AC1 / Kevin
Test Mode	MODE2-CH165	Test Voltage	By Battery

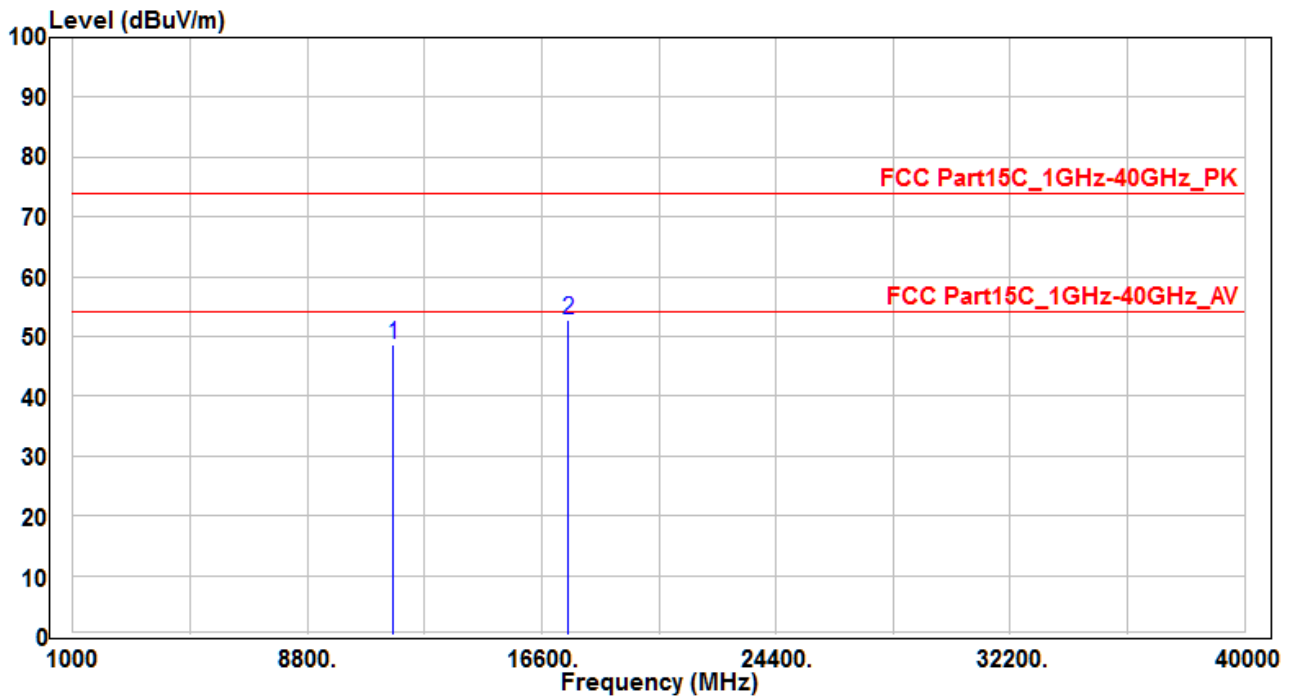

No	Frequency (MHz)	Reading (dBuV)	C.F (dB)	Measurement (dBuV/m)	Margin (dB)	Limit (dBuV)	Remark (QP/PK/AV)
1	11650	29.43	19.33	48.76	-25.24	74	Peak
2	* 17475	25.89	26.88	52.77	-21.23	74	Peak

Note :

1. " \* " means the worst value in this measurement data °
2. Measure Level (dBuV/m) = Reading Level (dBuV) + Factor (dB) °
3. Factor (dB) = Cable Loss (dB) + Antenna Factor (dB/m) °
4. The emission levels of other frequencies are very lower than the limit and not show in test report °

EUT	14249-RF2-B	Test Date	2016.10.24
Factor	BBHA 9120D (1GHz~18GHz)	Temp. / Humidity	25°C / 60%
Polarity	Horizontal	Site / Engineer	AC1 / Kevin
Test Mode	MODE3-CH38	Test Voltage	By Battery

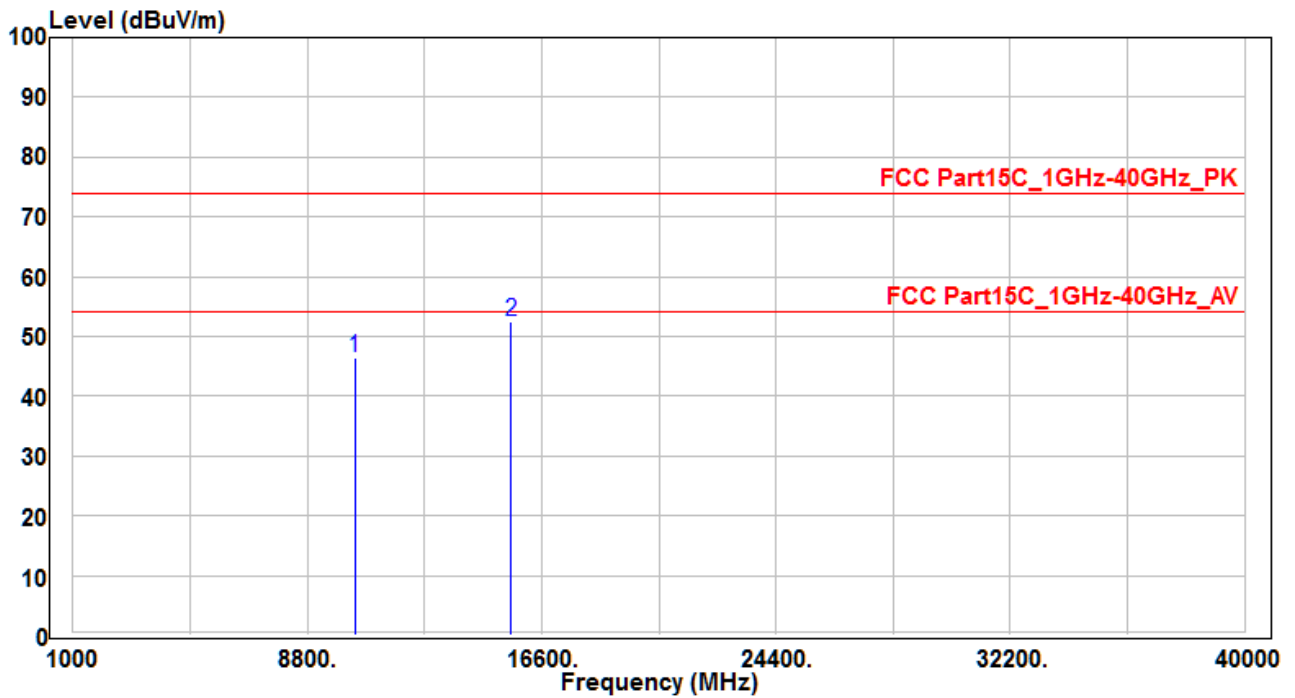

No	Frequency (MHz)	Reading (dBuV)	C.F (dB)	Measurement (dBuV/m)	Margin (dB)	Limit (dBuV)	Remark (QP/PK/AV)
1	10380	29.7	16.87	46.57	-27.43	74	Peak
2	* 15570	31.81	20.56	52.37	-21.63	74	Peak

Note :

- " \* " means the worst value in this measurement data °
- Measure Level (dBuV/m) = Reading Level (dBuV) + Factor (dB) °
- Factor (dB) = Cable Loss (dB) + Antenna Factor (dB/m) °
- The emission levels of other frequencies are very lower than the limit and not show in test report °

EUT	14249-RF2-B	Test Date	2016.10.24
Factor	BBHA 9120D (1GHz~18GHz)	Temp. / Humidity	25°C / 60%
Polarity	Vertical	Site / Engineer	AC1 / Kevin
Test Mode	MODE3-CH38	Test Voltage	By Battery

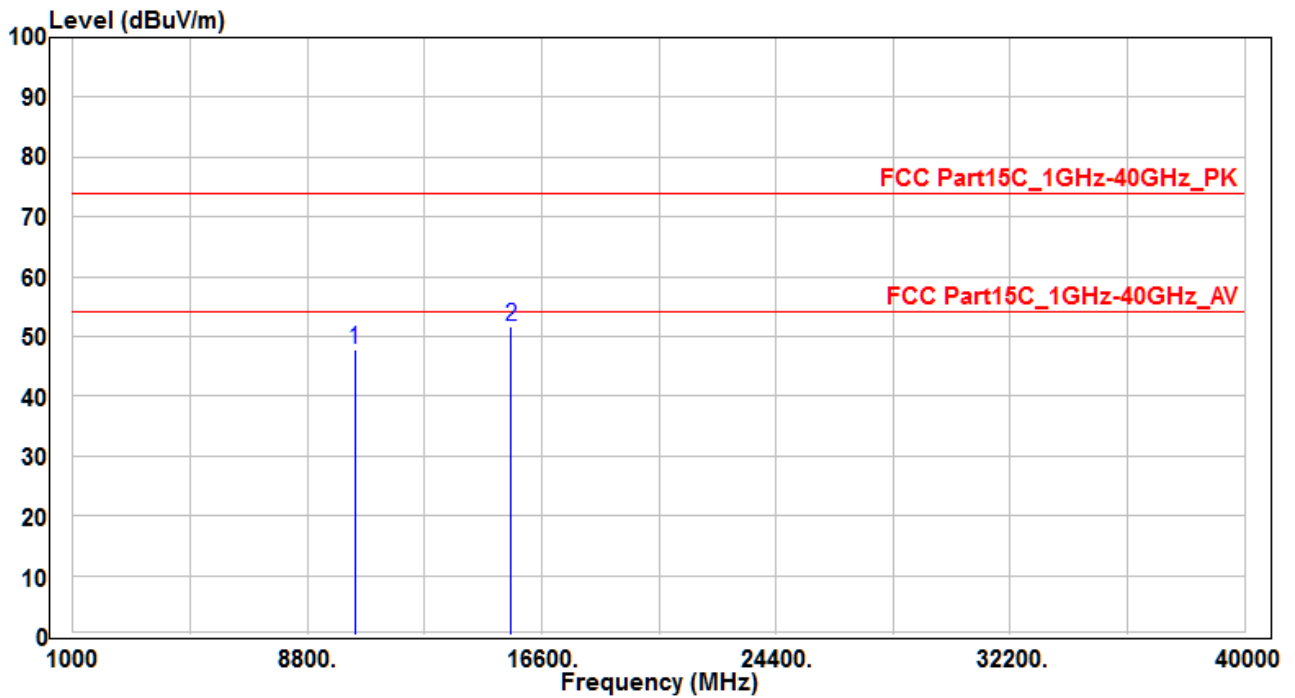

No	Frequency (MHz)	Reading (dBuV)	C.F (dB)	Measurement (dBuV/m)	Margin (dB)	Limit (dBuV)	Remark (QP/PK/AV)
1	10380	30.83	16.87	47.7	-26.3	74	Peak
2	* 15570	30.97	20.56	51.53	-22.47	74	Peak

Note :

- " \* " means the worst value in this measurement data °
- Measure Level (dBuV/m) = Reading Level (dBuV) + Factor (dB) °
- Factor (dB) = Cable Loss (dB) + Antenna Factor (dB/m) °
- The emission levels of other frequencies are very lower than the limit and not show in test report °

EUT	14249-RF2-B	Test Date	2016.10.24
Factor	BBHA 9120D (1GHz~18GHz)	Temp. / Humidity	25°C / 60%
Polarity	Horizontal	Site / Engineer	AC1 / Kevin
Test Mode	MODE3-CH46	Test Voltage	By Battery

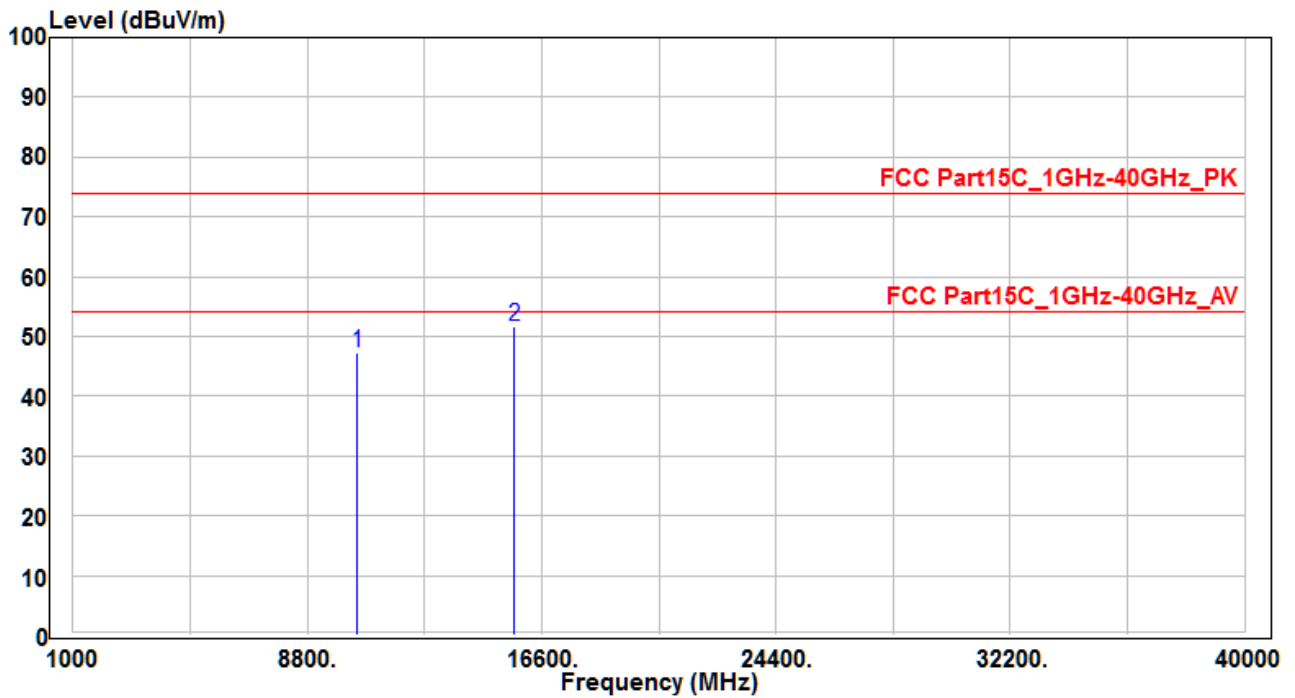

No	Frequency (MHz)	Reading (dBuV)	C.F (dB)	Measurement (dBuV/m)	Margin (dB)	Limit (dBuV)	Remark (QP/PK/AV)
1	10460	30.17	17.1	47.27	-26.73	74	Peak
2	* 15690	31.32	20.46	51.78	-22.22	74	Peak

Note :

1. " \* " means the worst value in this measurement data °
2. Measure Level (dBuV/m) = Reading Level (dBuV) + Factor (dB) °
3. Factor (dB) = Cable Loss (dB) + Antenna Factor (dB/m) °
4. The emission levels of other frequencies are very lower than the limit and not show in test report °



EUT	14249-RF2-B	Test Date	2016.10.24
Factor	BBHA 9120D (1GHz~18GHz)	Temp. / Humidity	25°C / 60%
Polarity	Vertical	Site / Engineer	AC1 / Kevin
Test Mode	MODE2-CH46	Test Voltage	By Battery

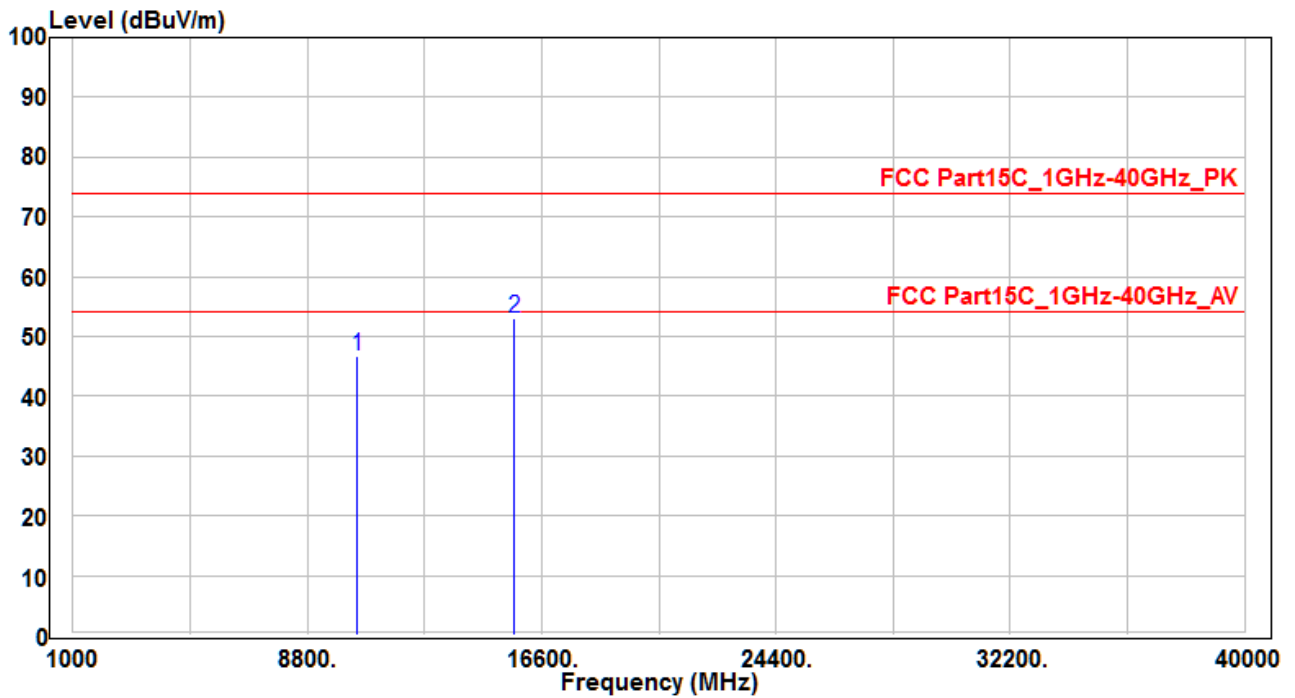

No	Frequency (MHz)	Reading (dBuV)	C.F (dB)	Measurement (dBuV/m)	Margin (dB)	Limit (dBuV)	Remark (QP/PK/AV)
1	10460	29.62	17.1	46.72	-27.28	74	Peak
2	* 15690	32.57	20.46	53.03	-20.97	74	Peak

Note :

- " \* " means the worst value in this measurement data °
- Measure Level (dBuV/m) = Reading Level (dBuV) + Factor (dB) °
- Factor (dB) = Cable Loss (dB) + Antenna Factor (dB/m) °
- The emission levels of other frequencies are very lower than the limit and not show in test report °

EUT	14249-RF2-B	Test Date	2016.10.24
Factor	BBHA 9120D (1GHz~18GHz)	Temp. / Humidity	25°C / 60%
Polarity	Horizontal	Site / Engineer	AC1 / Kevin
Test Mode	MODE3-CH151	Test Voltage	By Battery

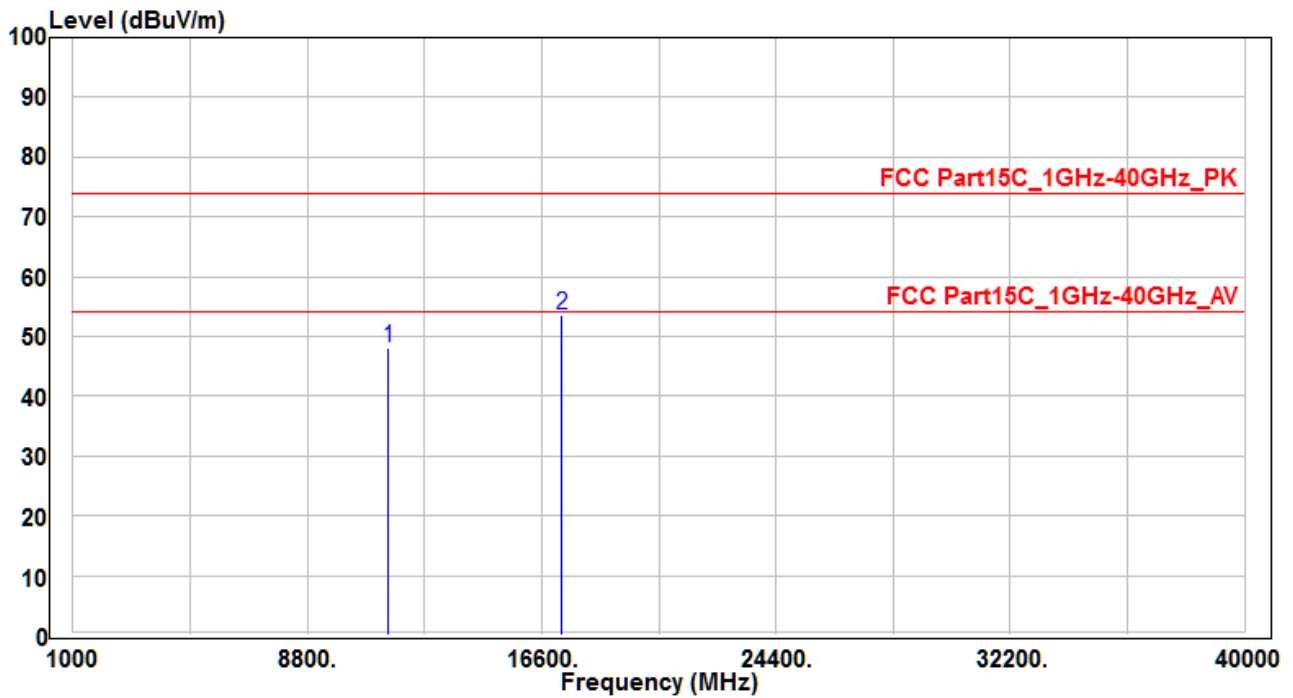

No	Frequency (MHz)	Reading (dBuV)	C.F (dB)	Measurement (dBuV/m)	Margin (dB)	Limit (dBuV)	Remark (QP/PK/AV)
1	11510	28.83	19.38	48.21	-25.79	74	Peak
2	* 17265	27.85	25.65	53.5	-20.5	74	Peak

Note :

- " \* " means the worst value in this measurement data °
- Measure Level (dBuV/m) = Reading Level (dBuV) + Factor (dB) °
- Factor (dB) = Cable Loss (dB) + Antenna Factor (dB/m) °
- The emission levels of other frequencies are very lower than the limit and not show in test report °

EUT	14249-RF2-B	Test Date	2016.10.24
Factor	BBHA 9120D (1GHz~18GHz)	Temp. / Humidity	25°C / 60%
Polarity	Vertical	Site / Engineer	AC1 / Kevin
Test Mode	MODE3-CH151	Test Voltage	By Battery

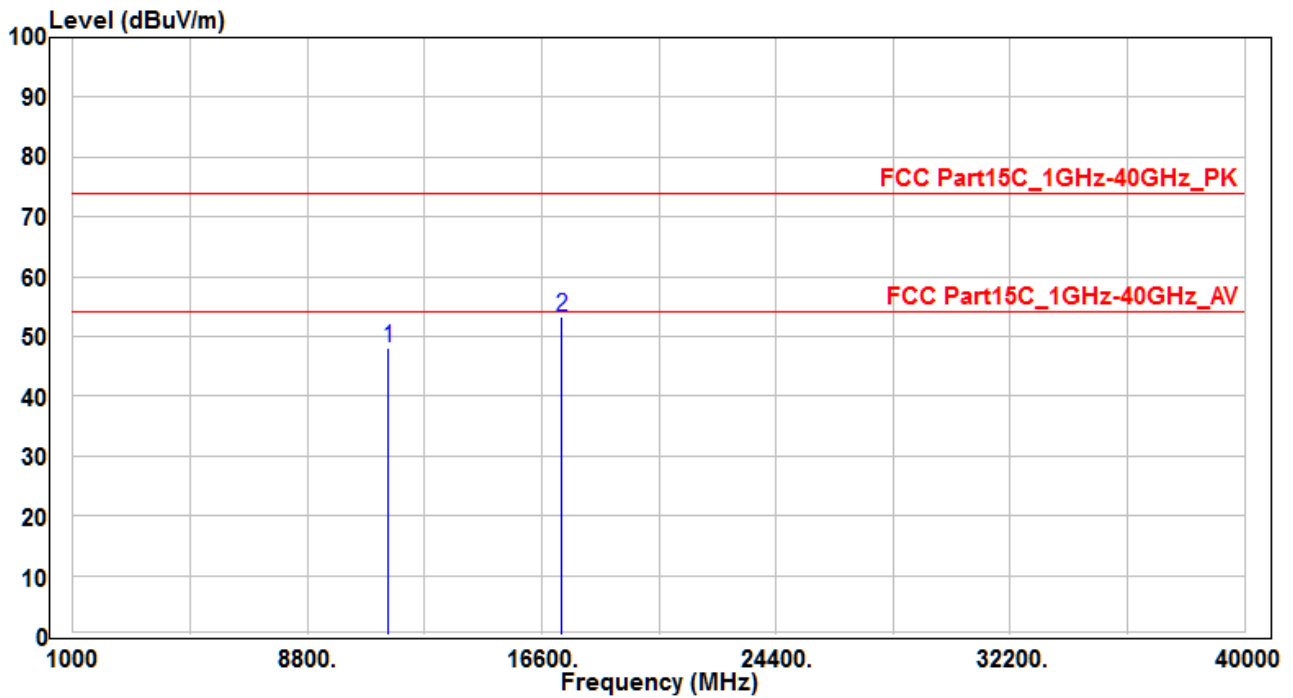

No	Frequency (MHz)	Reading (dBuV)	C.F (dB)	Measurement (dBuV/m)	Margin (dB)	Limit (dBuV)	Remark (QP/PK/AV)
1	11510	28.77	19.38	48.15	-25.85	74	Peak
2	* 17265	27.76	25.65	53.41	-20.59	74	Peak

Note :

1. " \* " means the worst value in this measurement data °
2. Measure Level (dBuV/m) = Reading Level (dBuV) + Factor (dB) °
3. Factor (dB) = Cable Loss (dB) + Antenna Factor (dB/m) °
4. The emission levels of other frequencies are very lower than the limit and not show in test report °

EUT	14249-RF2-B	Test Date	2016.10.24
Factor	BBHA 9120D (1GHz~18GHz)	Temp. / Humidity	25°C / 60%
Polarity	Horizontal	Site / Engineer	AC1 / Kevin
Test Mode	MODE3-CH159	Test Voltage	By Battery

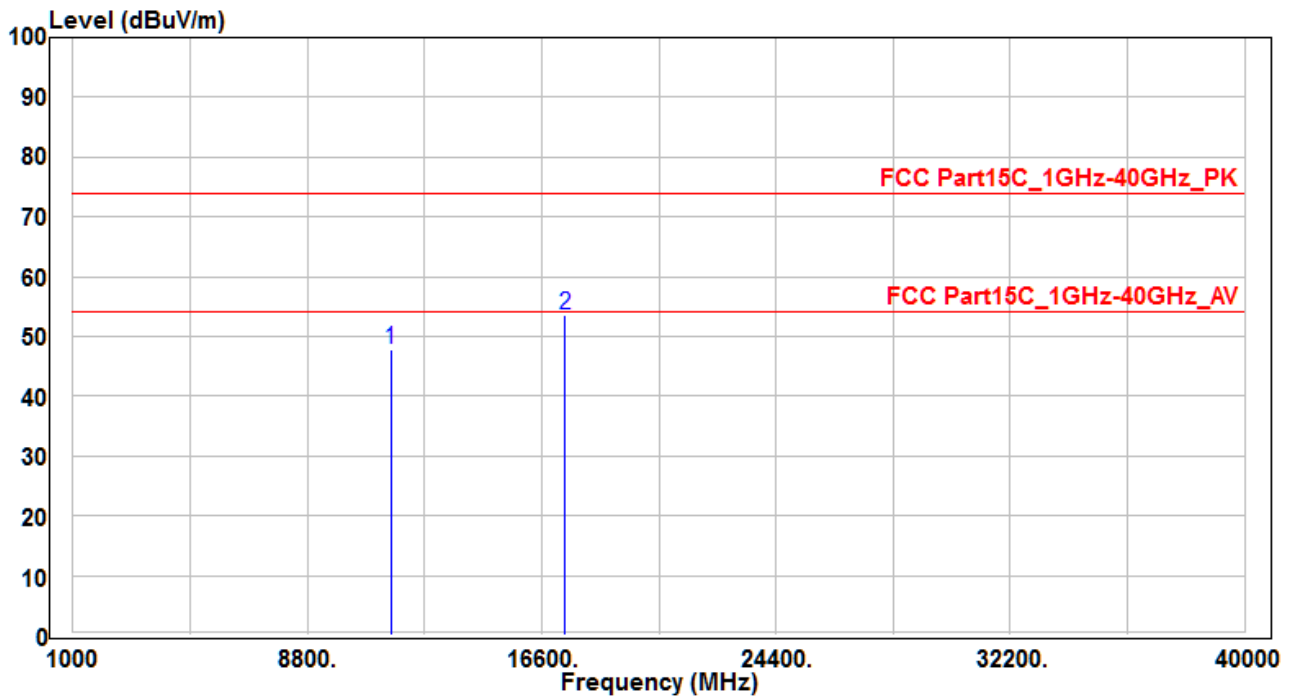

No	Frequency (MHz)	Reading (dBuV)	C.F (dB)	Measurement (dBuV/m)	Margin (dB)	Limit (dBuV)	Remark (QP/PK/AV)
1	11590	28.29	19.46	47.75	-26.25	74	Peak
2	* 17385	27.15	26.41	53.56	-20.44	74	Peak

Note :

- " \* " means the worst value in this measurement data °
- Measure Level (dBuV/m) = Reading Level (dBuV) + Factor (dB) °
- Factor (dB) = Cable Loss (dB) + Antenna Factor (dB/m) °
- The emission levels of other frequencies are very lower than the limit and not show in test report °

EUT	14249-RF2-B	Test Date	2016.10.24
Factor	BBHA 9120D (1GHz~18GHz)	Temp. / Humidity	25°C / 60%
Polarity	Vertical	Site / Engineer	AC1 / Kevin
Test Mode	MODE3-CH159	Test Voltage	By Battery

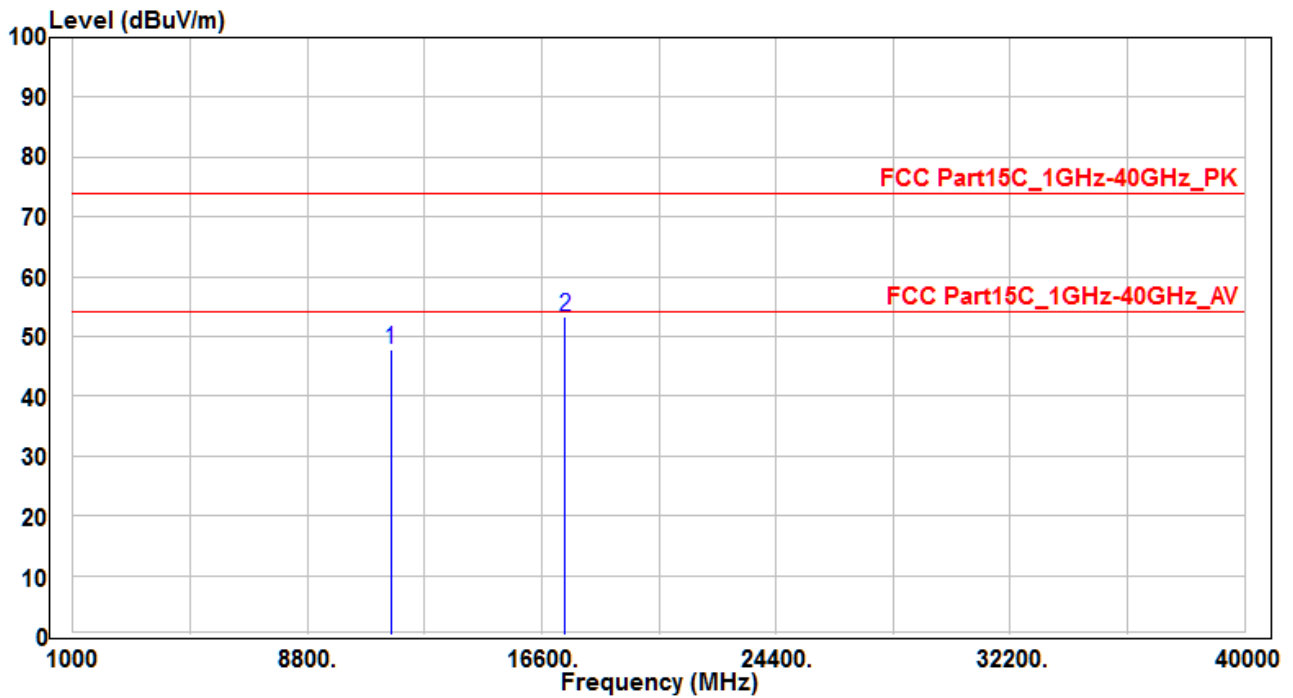

No	Frequency (MHz)	Reading (dBuV)	C.F (dB)	Measurement (dBuV/m)	Margin (dB)	Limit (dBuV)	Remark (QP/PK/AV)
1	11590	28.22	19.46	47.68	-26.32	74	Peak
2	* 17385	26.83	26.41	53.24	-20.76	74	Peak

Note :

1. " \* " means the worst value in this measurement data °
2. Measure Level (dBμV/m) = Reading Level (dBμV) + Factor (dB) °
3. Factor (dB) = Cable Loss (dB) + Antenna Factor (dB/m) °
4. The emission levels of other frequencies are very lower than the limit and not show in test report °

## 7.7. Radiated Restricted Band Edge Measurement

### 7.7.1. Test Limit

#### **For 15.205 requirement:**

Radiated emissions which fall in the restricted bands, as defined in Section 15.205(a) of FCC part 15, must also comply with the radiated emission limits specified in Section 15.209(a).

Frequency (MHz)	Frequency (MHz)	Frequency (MHz)	Frequency (GHz)
0.090 - 0.110	16.42 - 16.423	399.9 - 410	4.5 - 5.15
<sup>1</sup> 0.495 - 0.505	16.69475 - 16.69525	608 - 614	5.35 - 5.46
2.1735 - 2.1905	16.80425 - 16.80475	960 - 1240	7.25 - 7.75
4.125 - 4.128	25.5 - 25.67	1300 - 1427	8.25 - 8.5
4.17725 - 4.17775	37.5 - 38.25	1435 - 1626.5	9.0 - 9.2
4.20725 - 4.20775	73 - 74.6	1645.5 - 1646.5	9.3 - 9.5
6.215 - 6.218	74.8 - 75.2	1660 - 1710	10.6 - 12.7
6.26775 - 6.26825	108 - 121.94	1718.8 - 1722.2	13.25 - 13.4
6.31175 - 6.31225	123 - 138	2200 - 2300	14.47 - 14.5
8.291 - 8.294	149.9 - 150.05	2310 - 2390	15.35 - 16.2
8.362 - 8.366	156.52475 - 156.525	2483.5 - 2500	17.7 - 21.4
8.37625 - 8.38675	156.7 - 156.9	2690 - 2900	22.01 - 23.12
8.41425 - 8.41475	162.0125 - 167.17	3260 - 3267	23.6 - 24.0
12.29 - 12.293	167.72 - 173.2	3332 - 3339	31.2 - 31.8
12.51975 - 12.52025	240 - 285	3345.8 - 3358	36.43 - 36.5
12.57675 - 12.57725	322 - 335.4	3600 - 4400	( <sup>2</sup> )
13.36 - 13.41	--	--	--

**For 15.407(b) requirement:**

For transmitters operating in the 5.725-5.85 GHz band: All emissions within the frequency range from the band edge to 10 MHz above or below the band edge shall not exceed an e.i.r.p. of -17 dBm/MHz; for frequencies 10 MHz or greater above or below the band edge, emissions shall not exceed an e.i.r.p. of -27 dBm/MHz.

Refer to KDB 789033 D02v01r03 G)2)c), as specified in § 15.407(b), emissions above 1000 MHz that are outside of the restricted bands are subject to a maximum emission limit of -27 dBm/MHz (or -17 dBm/MHz as specified in § 15.407(b)(4)). However, an out-of-band emission that complies with both the peak and average limits of § 15.209 is not required to satisfy the -27 dBm/MHz or -17 dBm/MHz maximum emission limit.

All out of band emissions appearing in a restricted band as specified in Section 15.205 of the Title 47 CFR must not exceed the limits shown in Table per Section 15.209.

FCC Part 15 Subpart C Paragraph 15.209		
Frequency [MHz]	Field Strength [V/m]	Measured Distance [Meters]
0.009 – 0.490	2400/F (kHz)	300
0.490 – 1.705	24000/F (kHz)	30
1.705 - 30	30	30
30 - 88	100	3
88 - 216	150	3
216 - 960	200	3
Above 960	500	3

**7.7.2. Test Procedure Used**

KDB 789033 D02v01r03 – Section G

**7.7.3. Test Setting**

**Peak Field Strength Measurements**

1. Analyzer center frequency was set to the frequency of the radiated spurious emission of interest

2. RBW = as specified in Table 1
3. VBW = 3 \* RBW
4. Detector = peak
5. Sweep time = auto couple
6. Trace mode = max hold
7. Trace was allowed to stabilize

**Table 1 - RBW as a function of frequency**

Frequency	RBW
9 ~ 150 kHz	200 ~ 300 Hz
0.15 ~ 30 MHz	9 ~ 10 kHz
30 ~ 1000 MHz	100 ~ 120 kHz
> 1000 MHz	1 MHz

**Average Field Strength Measurements**

1. Analyzer center frequency was set to the frequency of the radiated spurious emission of interest
2. RBW = 1MHz
3. VBW  $\geq 1/T$
4. De As an alternative, the instrument may be set to linear detector mode. Ensure that video filtering is applied in linear voltage domain (rather than in a log or dB domain). Some instruments require linear display mode in order to accomplish this. Others have a setting for Average-VBW Type, which can be set to "Voltage" regardless of the display mode
5. Detector = Peak
6. Sweep time = auto
7. Trace mode = max hold
8. Allow max hold to run for at least 50 times (1/duty cycle) traces



### 7.7.4. Test Setup

#### 1GHz ~ 18GHz Test Setup:

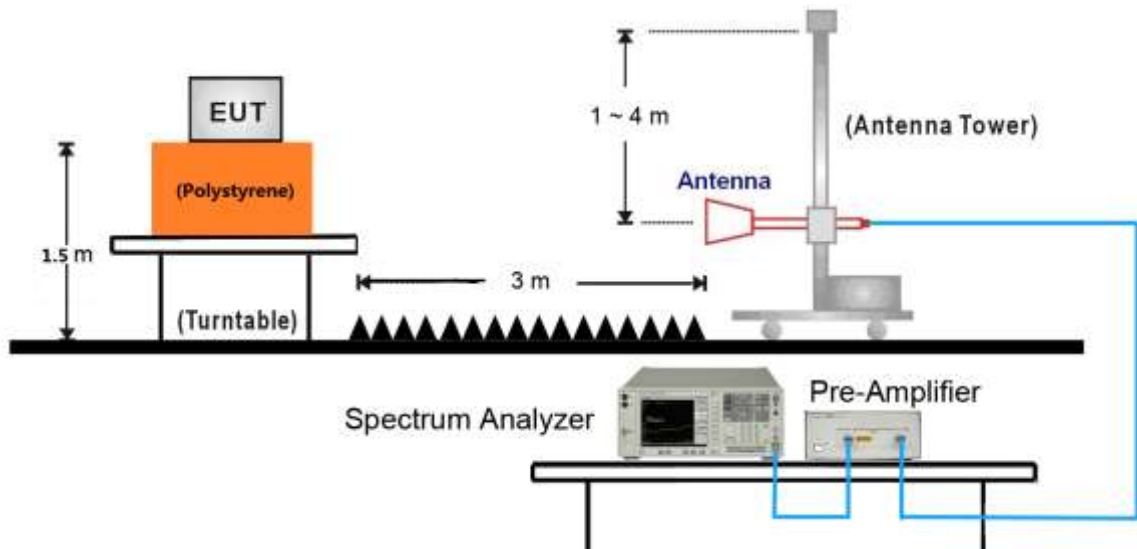

#### 18GHz ~40GHz Test Setup:

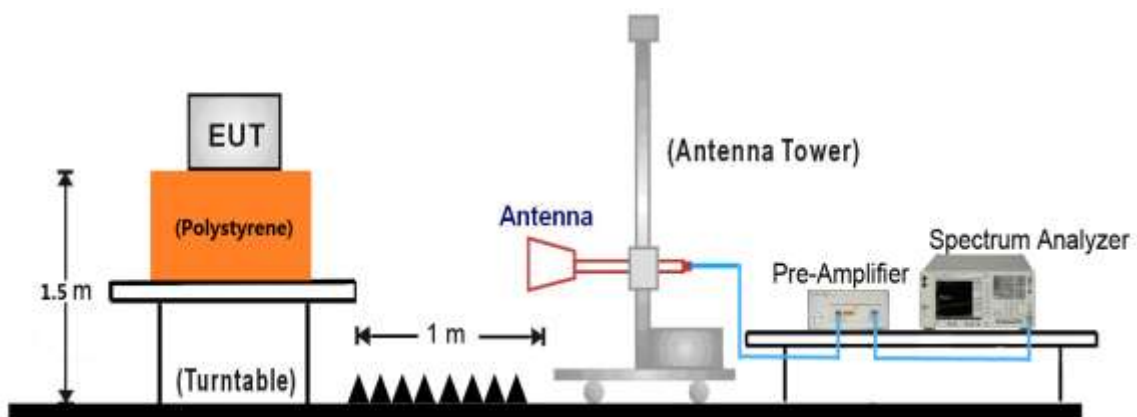

**7.7.5. Test Result**

EUT	14249-RF2-B	Test Date	2016.10.21
Factor	BBHA 9120D (1GHz~18GHz)	Temp. / Humidity	21°C / 57%
Polarity	Horizontal	Site / Engineer	AC1 / Kevin
Test Mode	MODE1-CH36	Test Voltage	By Battery

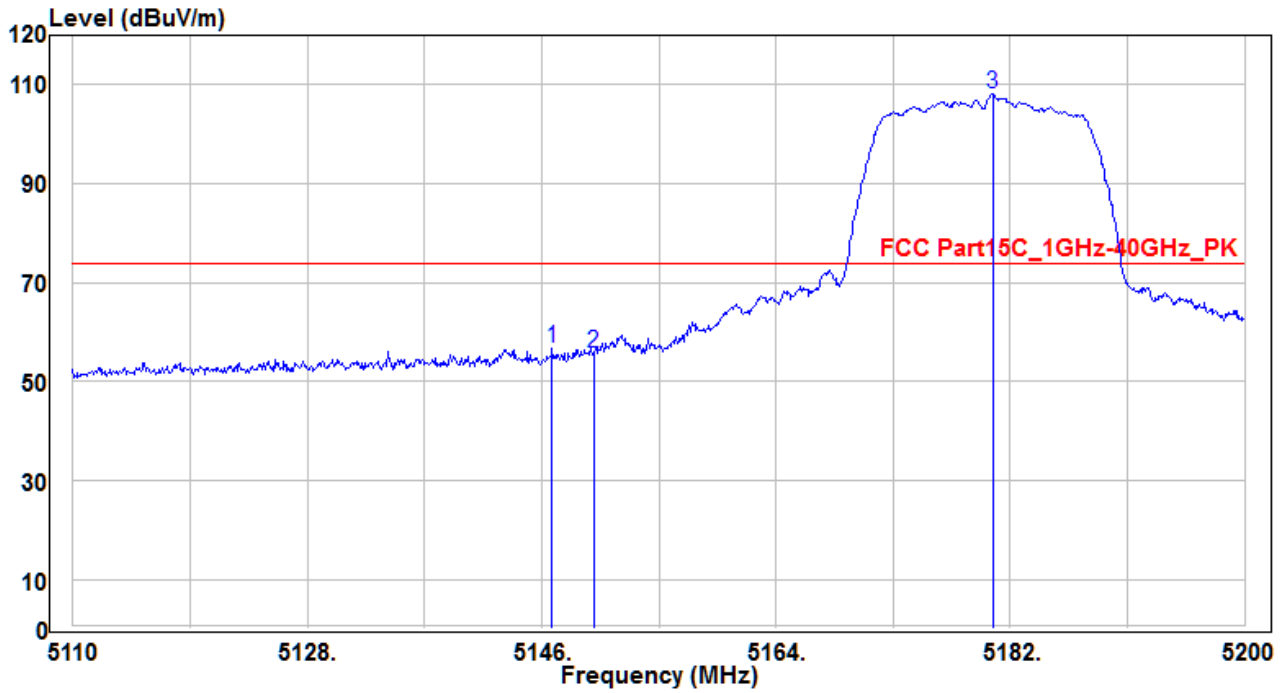

No		Frequency (MHz)	Reading (dBuV)	C.F (dB)	Measurement (dBuV/m)	Margin (dB)	Limit (dBuV)	Height (cm)	Angle (deg)	Remark (QP/PK/AV)
1	*	5146.81	52.53	4.17	56.7	-17.3	74	150	25	Peak
2		5150	51.6	4.18	55.78	-18.22	74	150	25	Peak
3		5180.65	104.08	4.07	108.15	34.15	74	150	25	Peak

**Note :**

1. " \* " means the worst value in this measurement data ◦
2. C.F ( Correction Factor ) = Antenna Factor (dB)+ Cable Loss (dB) – Preamplifier(dB) ◦
3. Measurement (dBuV/m) = Reading(dBuV) + C.F ( Correction Factor ) ◦

EUT	14249-RF2-B	Test Date	2016.10.21
Factor	BBHA 9120D (1GHz~18GHz)	Temp. / Humidity	21°C / 57%
Polarity	Horizontal	Site / Engineer	AC1 / Kevin
Test Mode	MODE1-CH36	Test Voltage	By Battery

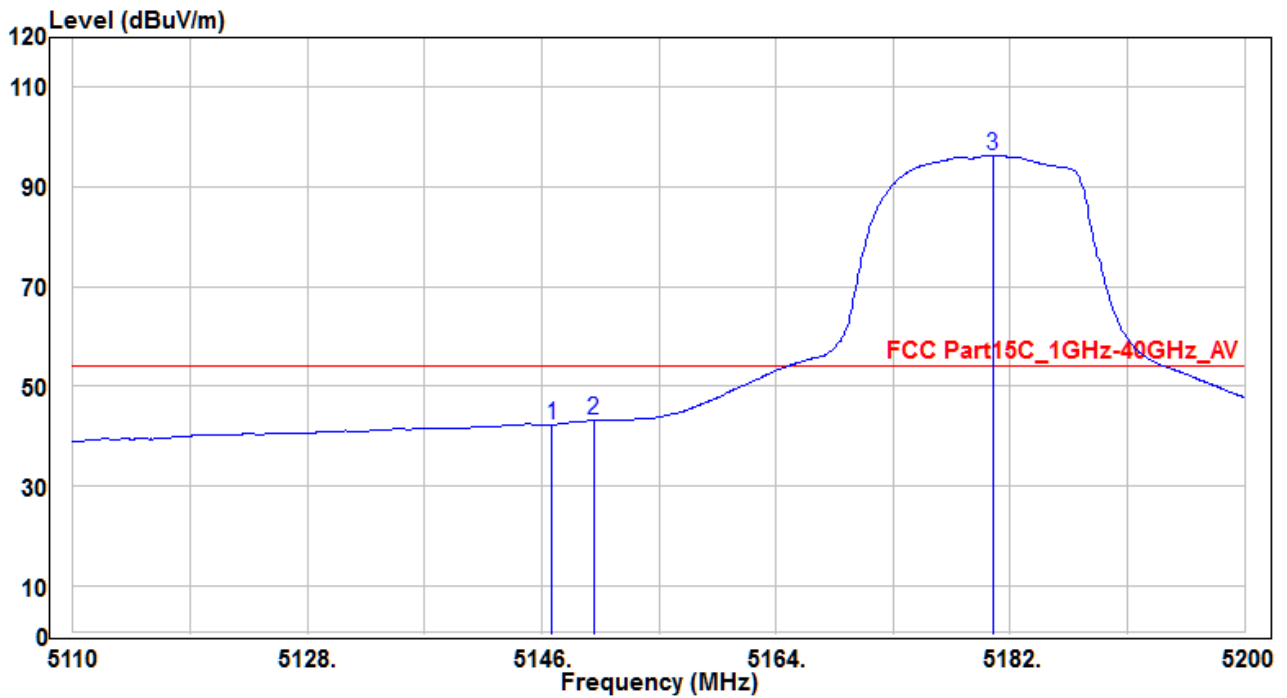

No	Frequency (MHz)	Reading (dBuV)	C.F (dB)	Measurement (dBuV/m)	Margin (dB)	Limit (dBuV)	Height (cm)	Angle (deg)	Remark (QP/PK/AV)
1	5146.81	38.17	4.17	42.34	-11.66	54	150	25	Average
2	* 5150	39.03	4.18	43.21	-10.79	54	150	25	Average
3	5180.65	92.19	4.07	96.26	42.26	54	150	25	Average

Note :

- "\*" means the worst value in this measurement data.
- C.F ( Correction Factor ) = Antenna Factor (dB)+ Cable Loss (dB) – Preamplifier(dB)。
- Measurement (dBuV/m) = Reading(dBuV) + C.F ( Correction Factor )。

EUT	14249-RF2-B	Test Date	2016.10.21
Factor	BBHA 9120D (1GHz~18GHz)	Temp. / Humidity	21°C / 57%
Polarity	Vertical	Site / Engineer	AC1 / Kevin
Test Mode	MODE1-CH36	Test Voltage	By Battery

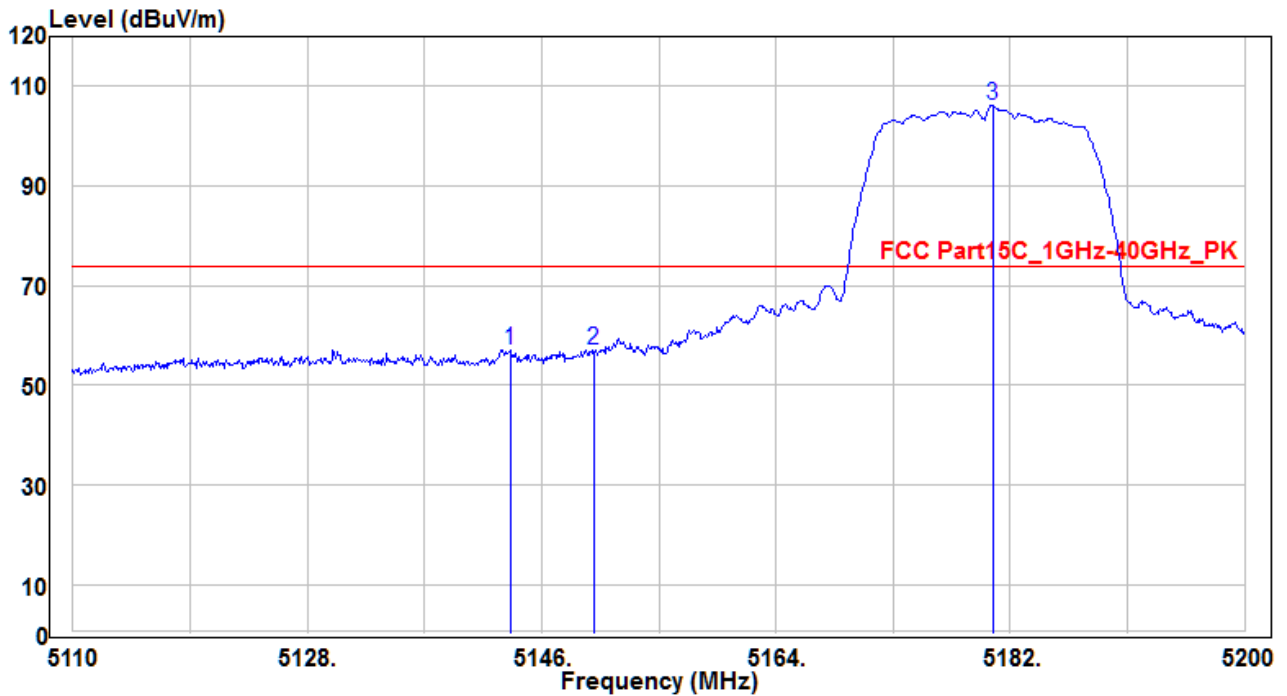

No	Frequency (MHz)	Reading (dBuV)	C.F (dB)	Measurement (dBuV/m)	Margin (dB)	Limit (dBuV)	Height (cm)	Angle (deg)	Remark (QP/PK/AV)	
1	*	5143.57	52.91	4.18	57.09	-16.91	74	150	350	Peak
2		5150	52.86	4.18	57.04	-16.96	74	150	350	Peak
3		5180.65	102.19	4.07	106.26	32.26	74	150	350	Peak

Note :

1. " \* " means the worst value in this measurement data °
2. C.F ( Correction Factor ) = Antenna Factor (dB)+ Cable Loss (dB) – Preamplifier(dB) °
3. Measurement (dBuV/m) = Reading(dBuV) + C.F ( Correction Factor ) °

EUT	14249-RF2-B	Test Date	2016.10.21
Factor	BBHA 9120D (1GHz~18GHz)	Temp. / Humidity	21°C / 57%
Polarity	Vertical	Site / Engineer	AC1 / Kevin
Test Mode	MODE1-CH36	Test Voltage	By Battery

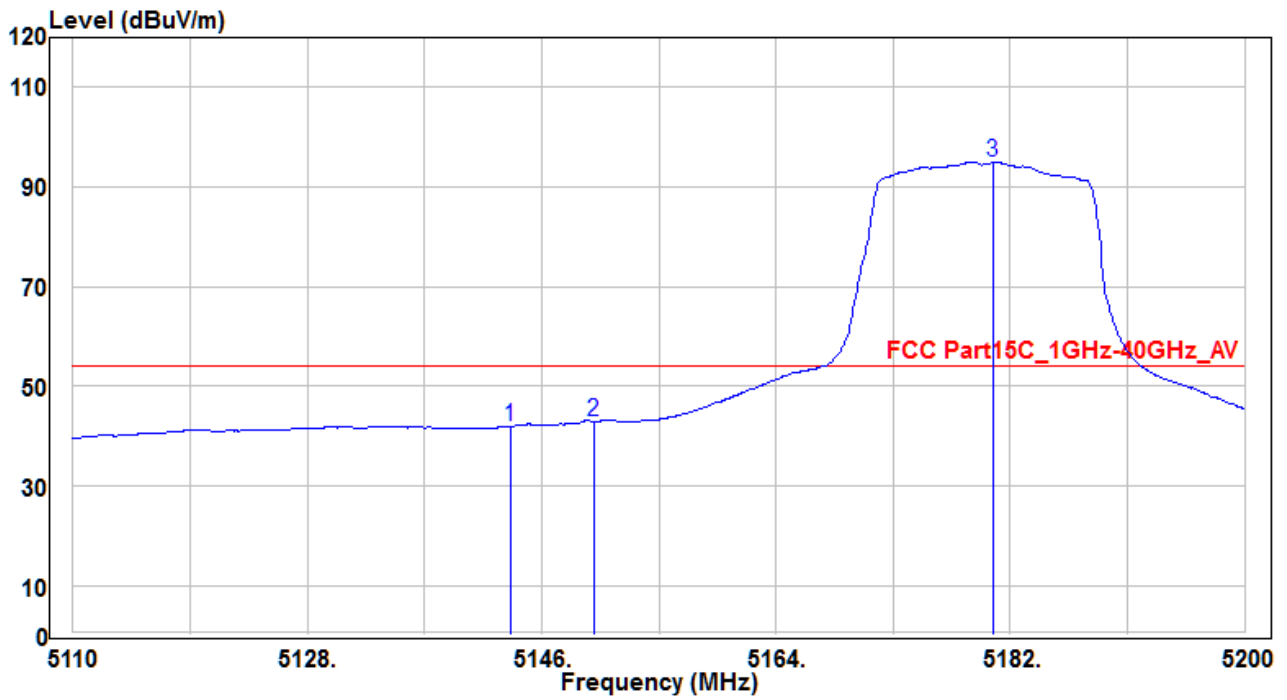

No	Frequency (MHz)	Reading (dBuV)	C.F (dB)	Measurement (dBuV/m)	Margin (dB)	Limit (dBuV)	Height (cm)	Angle (deg)	Remark (QP/PK/AV)
1	5143.57	37.76	4.18	41.94	-12.06	54	150	350	Average
2	* 5150	38.76	4.18	42.94	-11.06	54	150	350	Average
3	5180.65	90.87	4.07	94.94	40.94	54	150	350	Average

Note :

- "\*" means the worst value in this measurement data °
- C.F ( Correction Factor ) = Antenna Factor (dB)+ Cable Loss (dB) – Preamplifier(dB) °
- Measurement (dBuV/m) = Reading(dBuV) + C.F ( Correction Factor ) °

EUT	14249-RF2-B	Test Date	2016.10.21
Factor	BBHA 9120D (1GHz~18GHz)	Temp. / Humidity	21°C / 57%
Polarity	Horizontal	Site / Engineer	AC1 / Kevin
Test Mode	MODE1-CH149	Test Voltage	By Battery

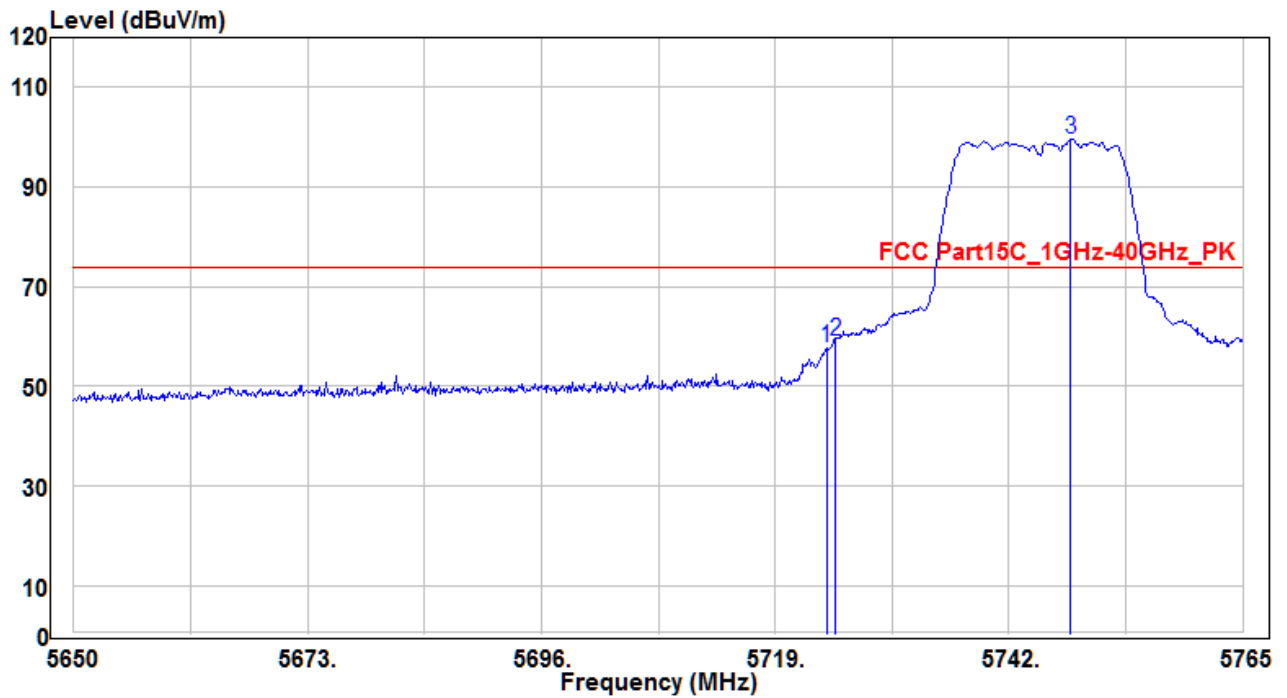

No	Frequency (MHz)	Reading (dBuV)	C.F (dB)	Measurement (dBuV/m)	Margin (dB)	Limit (dBuV)	Height (cm)	Angle (deg)	Remark (QP/PK/AV)
1	5724.06	52.7	5.02	57.72	-16.28	74	150	-30	Peak
2	* 5724.98	53.85	5.02	58.87	-15.13	74	150	-30	Peak
3	5748.095	94.4	5.18	99.58	25.58	74	150	-30	Peak

Note :

- "\*" means the worst value in this measurement data °
- C.F ( Correction Factor ) = Antenna Factor (dB)+ Cable Loss (dB) – Preamplifier(dB) °
- Measurement (dBuV/m) = Reading(dBuV) + C.F ( Correction Factor ) °

EUT	14249-RF2-B	Test Date	2016.10.21
Factor	BBHA 9120D (1GHz~18GHz)	Temp. / Humidity	21°C / 57%
Polarity	Horizontal	Site / Engineer	AC1 / Kevin
Test Mode	MODE1-CH149	Test Voltage	By Battery

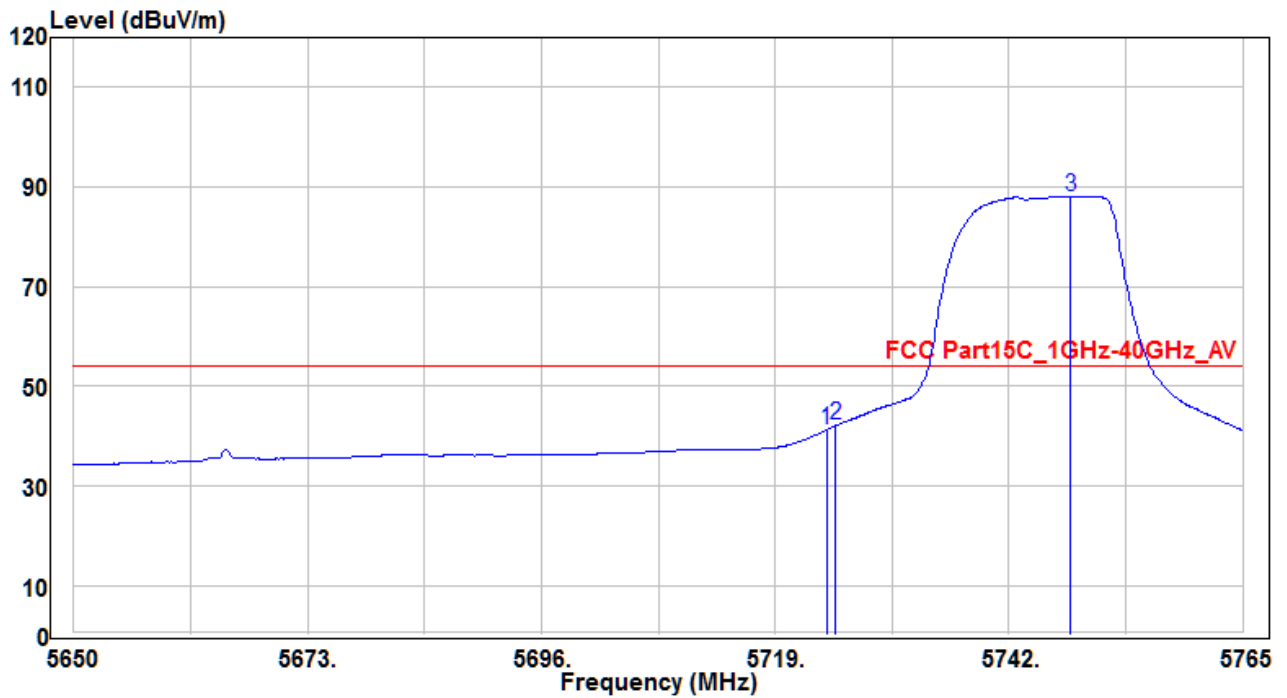

No	Frequency (MHz)	Reading (dBuV)	C.F (dB)	Measurement (dBuV/m)	Margin (dB)	Limit (dBuV)	Height (cm)	Angle (deg)	Remark (QP/PK/AV)
1	5724.06	36.22	5.02	41.24	-12.76	54	150	-30	Average
2	* 5724.98	37.14	5.02	42.16	-11.84	54	150	-30	Average
3	5748.095	82.88	5.18	88.06	34.06	54	150	-30	Average

Note :

4. " \* " means the worst value in this measurement data °
5. C.F ( Correction Factor ) = Antenna Factor (dB)+ Cable Loss (dB) – Preamplifier(dB) °
6. Measurement (dBuV/m) = Reading(dBuV) + C.F ( Correction Factor ) °

EUT	14249-RF2-B	Test Date	2016.10.21
Factor	BBHA 9120D (1GHz~18GHz)	Temp. / Humidity	21°C / 57%
Polarity	Vertical	Site / Engineer	AC1 / Kevin
Test Mode	MODE1-CH149	Test Voltage	By Battery

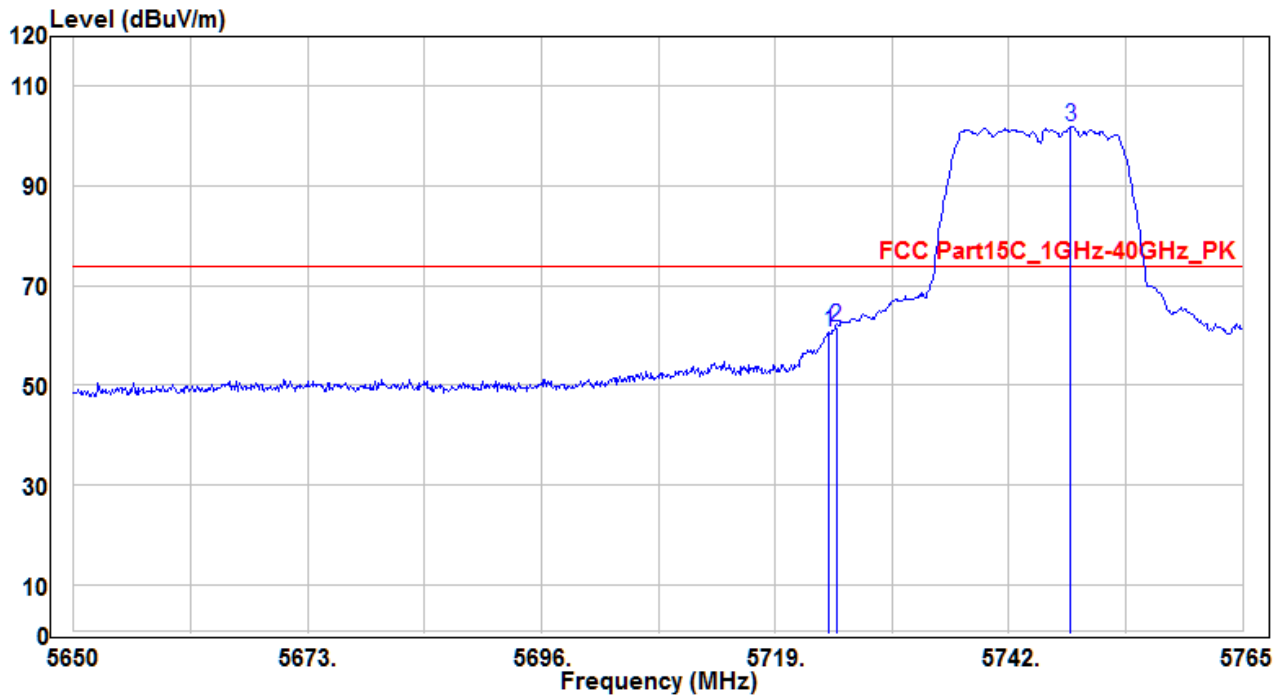

No	Frequency (MHz)	Reading (dBuV)	C.F (dB)	Measurement (dBuV/m)	Margin (dB)	Limit (dBuV)	Height (cm)	Angle (deg)	Remark (QP/PK/AV)
1	5724.29	55.51	5.02	60.53	-13.47	74	150	390	Peak
2	* 5725	56.52	5.03	61.55	-12.45	74	150	390	Peak
3	5748.095	96.78	5.18	101.96	27.96	74	150	390	Peak

Note :

1. " \* " means the worst value in this measurement data °
2. C.F ( Correction Factor ) = Antenna Factor (dB)+ Cable Loss (dB) – Preamplifier(dB) °
3. Measurement (dBuV/m) = Reading(dBuV) + C.F ( Correction Factor ) °



EUT	14249-RF2-B	Test Date	2016.10.21
Factor	BBHA 9120D (1GHz~18GHz)	Temp. / Humidity	21°C / 57%
Polarity	Vertical	Site / Engineer	AC1 / Kevin
Test Mode	MODE1-CH149	Test Voltage	By Battery

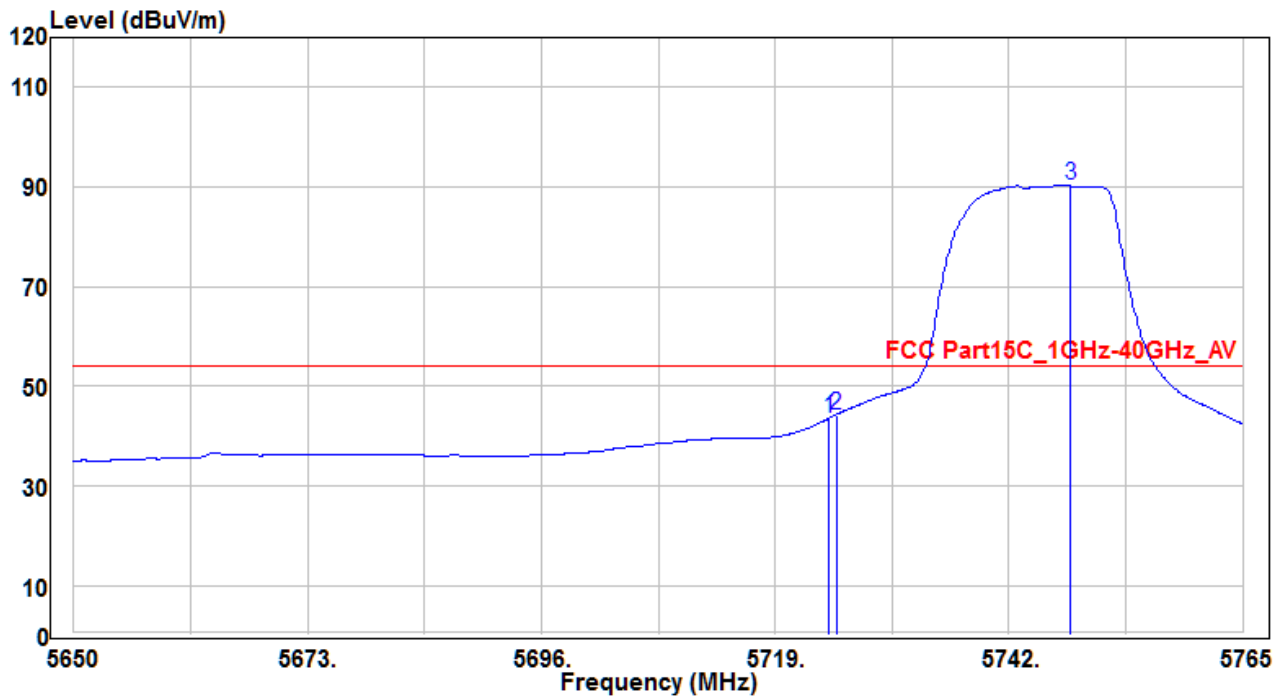

No	Frequency (MHz)	Reading (dBuV)	C.F (dB)	Measurement (dBuV/m)	Margin (dB)	Limit (dBuV)	Height (cm)	Angle (deg)	Remark (QP/PK/AV)
1	5724.29	38.59	5.02	43.61	-10.39	54	150	390	Average
2	* 5725	39.31	5.03	44.34	-9.66	54	150	390	Average
3	5748.095	85.02	5.18	90.2	36.2	54	150	390	Average

Note :

- "\*" means the worst value in this measurement data °
- C.F ( Correction Factor ) = Antenna Factor (dB)+ Cable Loss (dB) – Preamplifier(dB) °
- Measurement (dBuV/m) = Reading(dBuV) + C.F ( Correction Factor ) °

EUT	14249-RF2-B	Test Date	2016.10.21
Factor	BBHA 9120D (1GHz~18GHz)	Temp. / Humidity	21°C / 57%
Polarity	Horizontal	Site / Engineer	AC1 / Kevin
Test Mode	MODE1-CH165	Test Voltage	By Battery

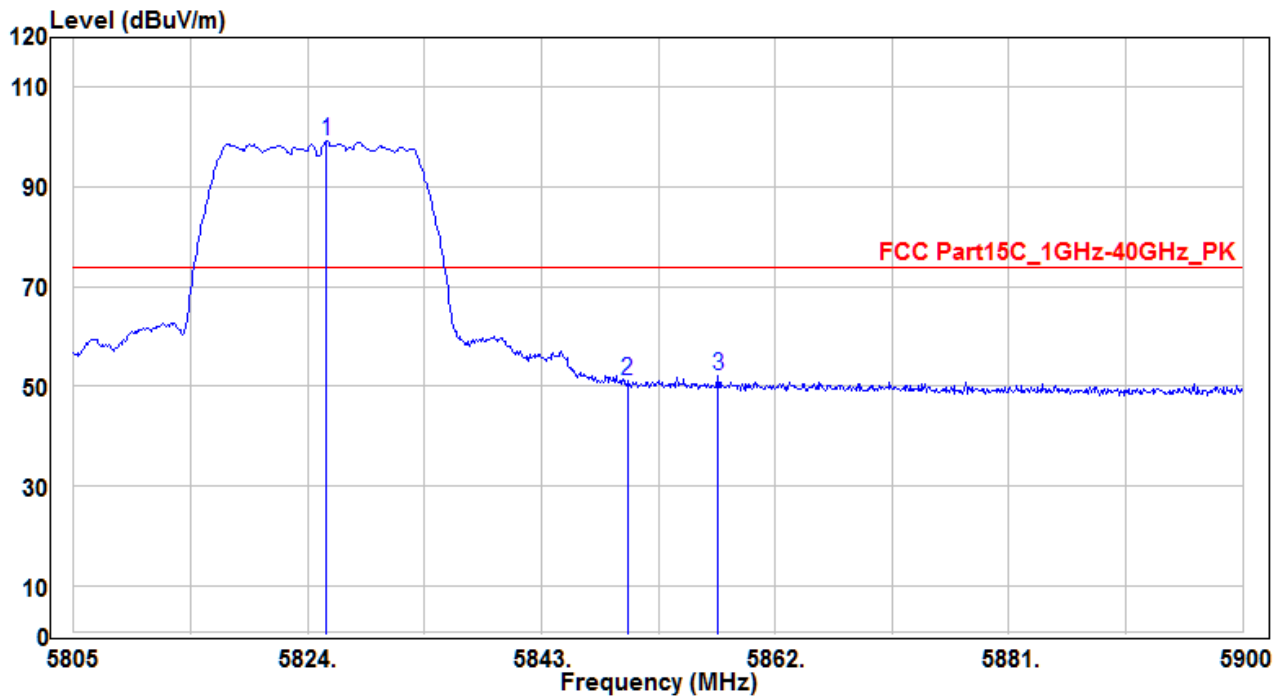

No	Frequency (MHz)	Reading (dBuV)	C.F (dB)	Measurement (dBuV/m)	Margin (dB)	Limit (dBuV)	Height (cm)	Angle (deg)	Remark (QP/PK/AV)
1	5825.52	93.56	5.59	99.15	25.15	74	150	338	Peak
2	5850	45.25	5.73	50.98	-23.02	74	150	338	Peak
3	* 5857.345	46.22	5.76	51.98	-22.02	74	150	338	Peak

Note :

- "\*" means the worst value in this measurement data °
- C.F ( Correction Factor ) = Antenna Factor (dB)+ Cable Loss (dB) – Preamplifier(dB) °
- Measurement (dBuV/m) = Reading(dBuV) + C.F ( Correction Factor ) °

EUT	14249-RF2-B	Test Date	2016.10.21
Factor	BBHA 9120D (1GHz~18GHz)	Temp. / Humidity	21°C / 57%
Polarity	Horizontal	Site / Engineer	AC1 / Kevin
Test Mode	MODE1-CH165	Test Voltage	By Battery

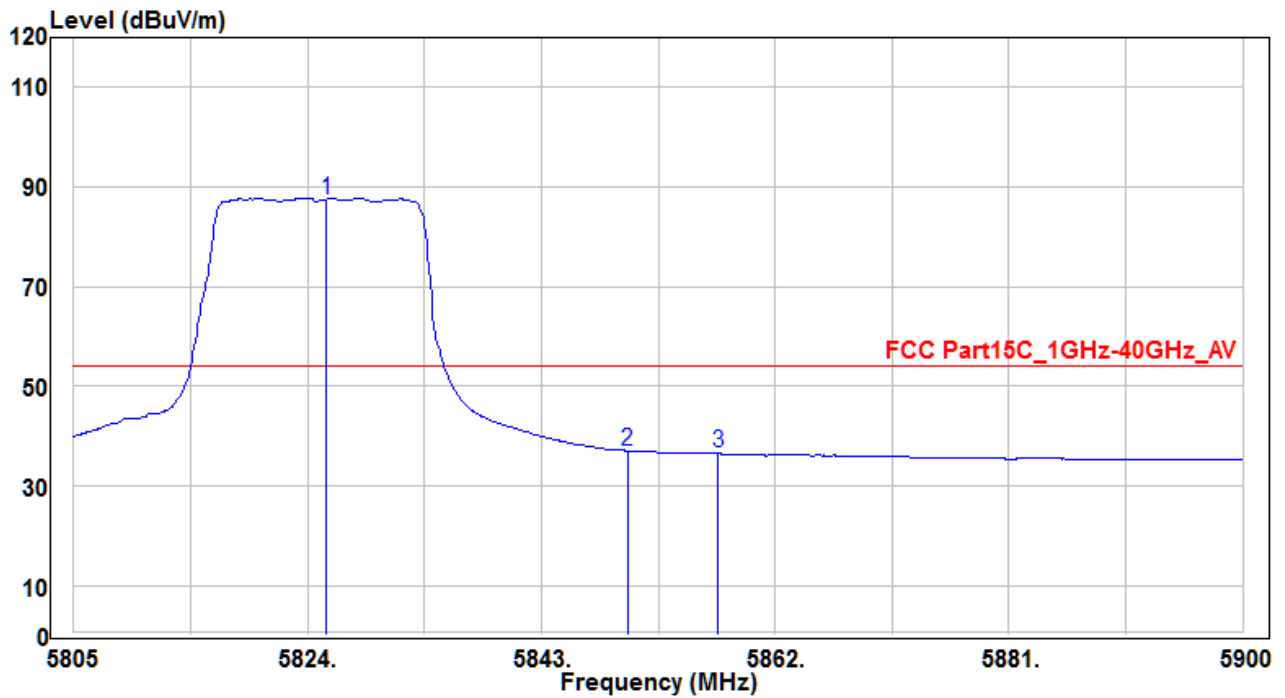

No	Frequency (MHz)	Reading (dBuV)	C.F (dB)	Measurement (dBuV/m)	Margin (dB)	Limit (dBuV)	Height (cm)	Angle (deg)	Remark (QP/PK/AV)
1	5825.52	81.85	5.59	87.44	33.44	54	150	338	Average
2	* 5850	31.34	5.73	37.07	-16.93	54	150	338	Average
3	5857.345	30.72	5.76	36.48	-17.52	54	150	338	Average

Note :

- " \* " means the worst value in this measurement data °
- C.F ( Correction Factor ) = Antenna Factor (dB)+ Cable Loss (dB) – Preamplifier(dB) °
- Measurement (dBuV/m) = Reading(dBuV) + C.F ( Correction Factor ) °

EUT	14249-RF2-B	Test Date	2016.10.21
Factor	BBHA 9120D (1GHz~18GHz)	Temp. / Humidity	21°C / 57%
Polarity	Vertical	Site / Engineer	AC1 / Kevin
Test Mode	MODE1-CH165	Test Voltage	By Battery

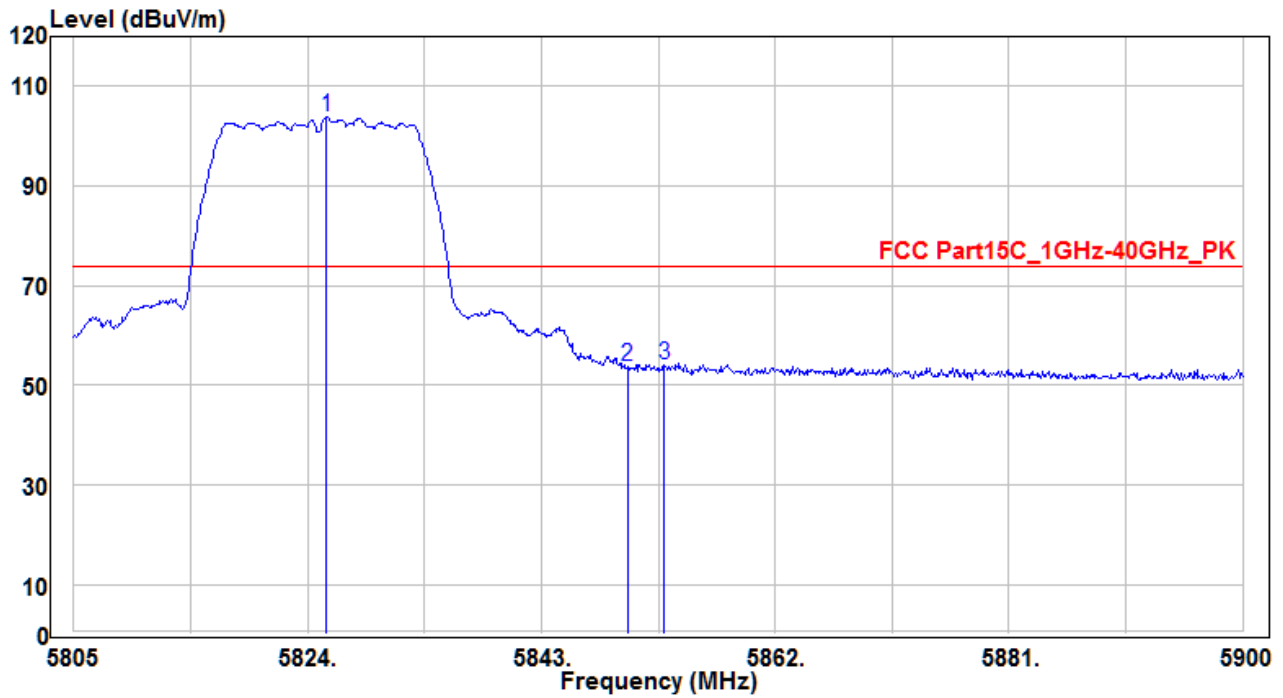

No	Frequency (MHz)	Reading (dBuV)	C.F (dB)	Measurement (dBuV/m)	Margin (dB)	Limit (dBuV)	Height (cm)	Angle (deg)	Remark (QP/PK/AV)
1	5825.52	98.16	5.59	103.75	29.75	74	150	335	Peak
2	5850	47.89	5.73	53.62	-20.38	74	150	335	Peak
3	* 5852.975	48.5	5.74	54.24	-19.76	74	150	335	Peak

Note :

1. " \* " means the worst value in this measurement data °
2. C.F ( Correction Factor ) = Antenna Factor (dB)+ Cable Loss (dB) – Preamplifier(dB) °
3. Measurement (dBuV/m) = Reading(dBuV) + C.F ( Correction Factor ) °

EUT	14249-RF2-B	Test Date	2016.10.21
Factor	BBHA 9120D (1GHz~18GHz)	Temp. / Humidity	21°C / 57%
Polarity	Vertical	Site / Engineer	AC1 / Kevin
Test Mode	MODE1-CH165	Test Voltage	By Battery

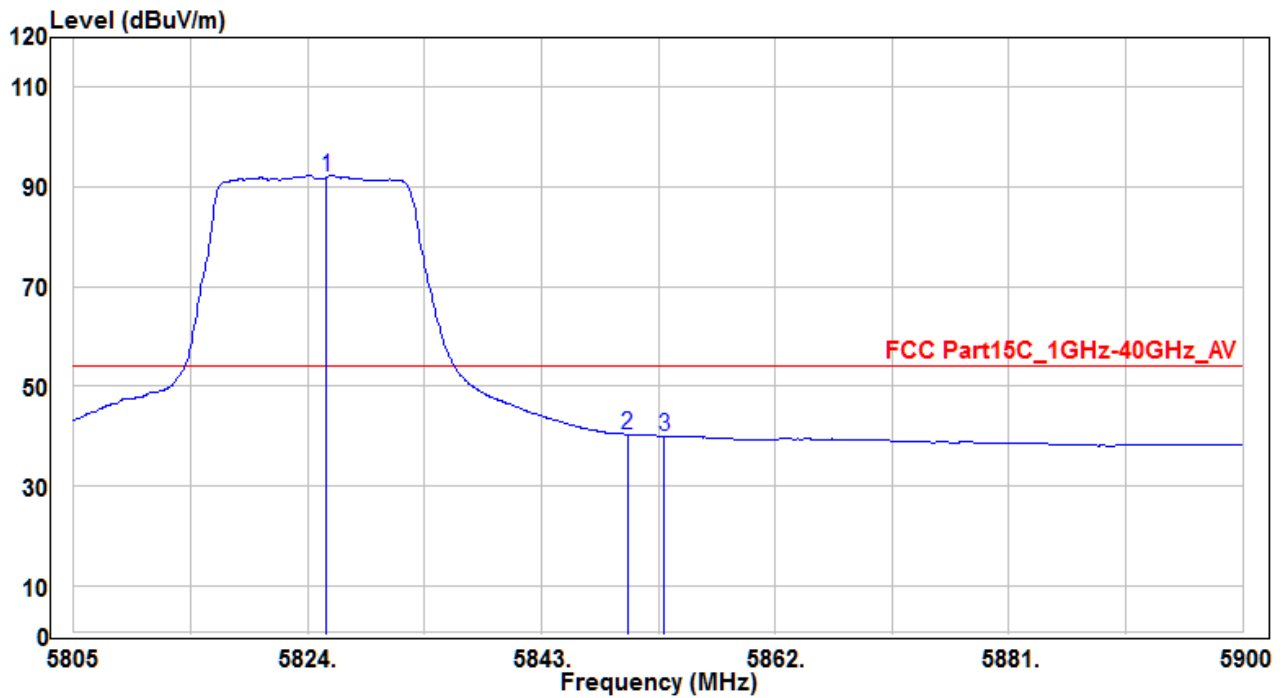

No	Frequency (MHz)	Reading (dBuV)	C.F (dB)	Measurement (dBuV/m)	Margin (dB)	Limit (dBuV)	Height (cm)	Angle (deg)	Remark (QP/PK/AV)
1	5825.52	86.33	5.59	91.92	37.92	54	150	335	Average
2	* 5850	34.64	5.73	40.37	-13.63	54	150	335	Average
3	5852.975	34.28	5.74	40.02	-13.98	54	150	335	Average

Note :

- " \* " means the worst value in this measurement data °
- C.F ( Correction Factor ) = Antenna Factor (dB)+ Cable Loss (dB) – Preamplifier(dB) °
- Measurement (dBuV/m) = Reading(dBuV) + C.F ( Correction Factor ) °

EUT	14249-RF2-B	Test Date	2016.10.21
Factor	BBHA 9120D (1GHz~18GHz)	Temp. / Humidity	21°C / 57%
Polarity	Horizontal	Site / Engineer	AC1 / Kevin
Test Mode	MODE2-CH36	Test Voltage	By Battery

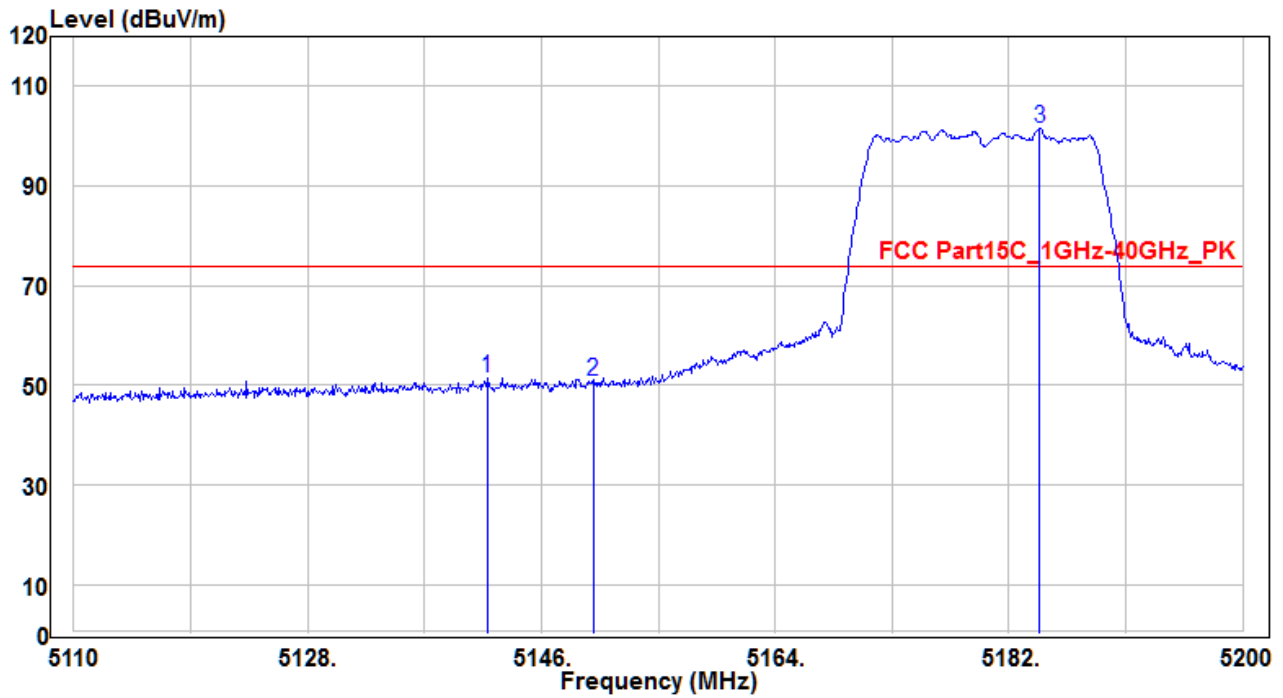

No	Frequency (MHz)	Reading (dBuV)	C.F (dB)	Measurement (dBuV/m)	Margin (dB)	Limit (dBuV)	Height (cm)	Angle (deg)	Remark (QP/PK/AV)	
1	*	5141.86	47.43	4.18	51.61	-22.39	74	150	385	Peak
2		5150	46.55	4.18	50.73	-23.27	74	150	385	Peak
3		5184.34	97.5	4.05	101.55	27.55	74	150	385	Peak

Note :

1. " \* " means the worst value in this measurement data °
2. C.F ( Correction Factor ) = Antenna Factor (dB)+ Cable Loss (dB) – Preamplifier(dB) °
3. Measurement (dBuV/m) = Reading(dBuV) + C.F ( Correction Factor ) °

EUT	14249-RF2-B	Test Date	2016.10.21
Factor	BBHA 9120D (1GHz~18GHz)	Temp. / Humidity	21°C / 57%
Polarity	Horizontal	Site / Engineer	AC1 / Kevin
Test Mode	MODE2-CH36	Test Voltage	By Battery

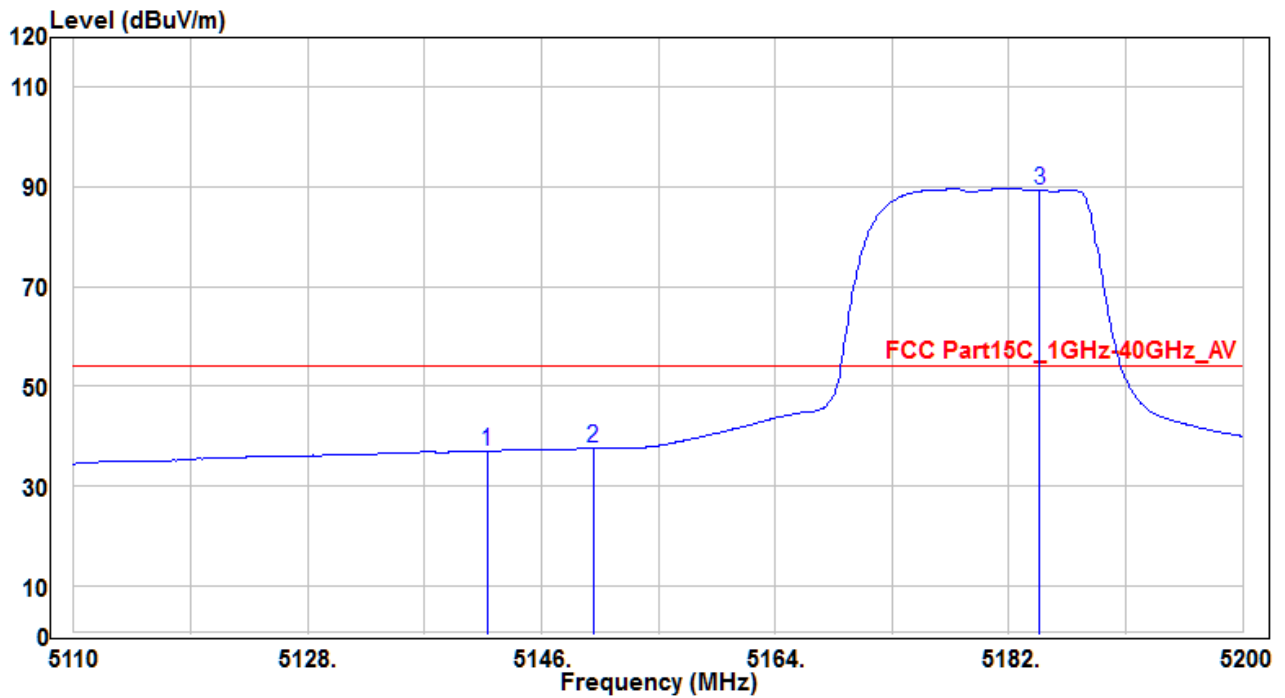

No	Frequency (MHz)	Reading (dBuV)	C.F (dB)	Measurement (dBuV/m)	Margin (dB)	Limit (dBuV)	Height (cm)	Angle (deg)	Remark (QP/PK/AV)
1	5141.86	32.82	4.18	37	-17	54	150	385	Average
2	* 5150	33.42	4.18	37.6	-16.4	54	150	385	Average
3	5184.34	85.25	4.05	89.3	35.3	54	150	385	Average

Note :

- "\*" means the worst value in this measurement data.
- C.F ( Correction Factor ) = Antenna Factor (dB)+ Cable Loss (dB) – Preamplifier(dB)。
- Measurement (dBuV/m) = Reading(dBuV) + C.F ( Correction Factor )。

EUT	14249-RF2-B	Test Date	2016.10.21
Factor	BBHA 9120D (1GHz~18GHz)	Temp. / Humidity	21°C / 57%
Polarity	Vertical	Site / Engineer	AC1 / Kevin
Test Mode	MODE2-CH36	Test Voltage	By Battery

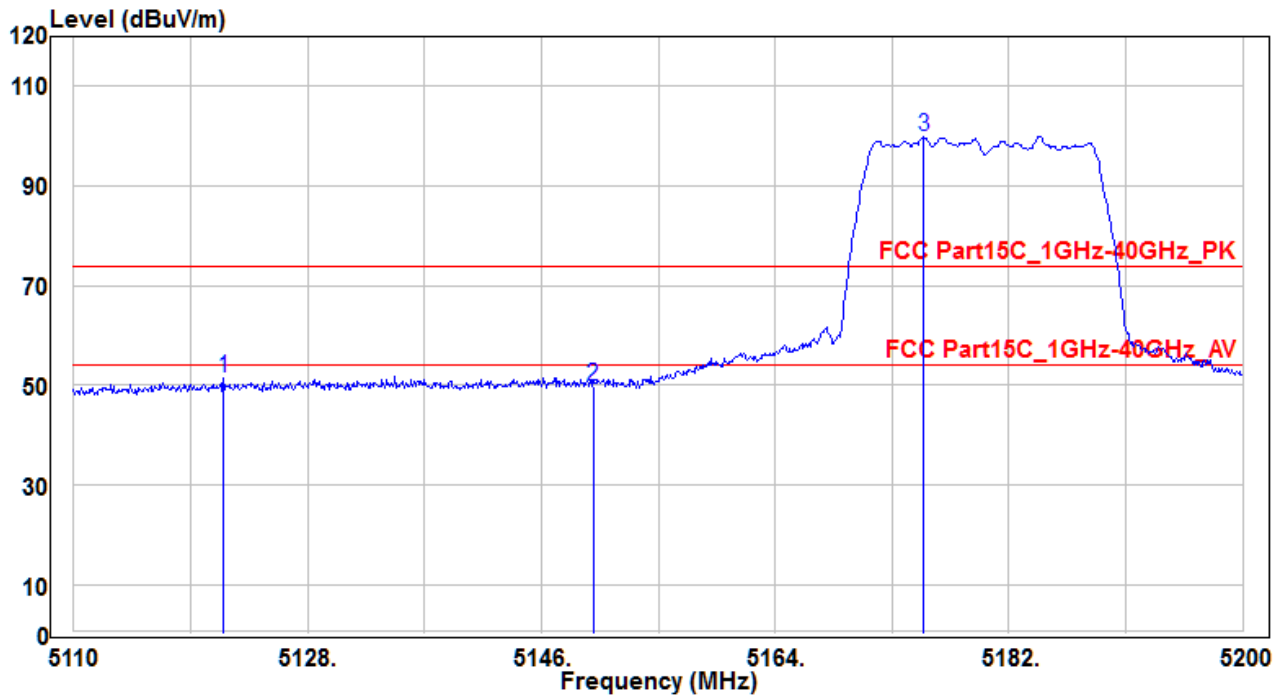

No	Frequency (MHz)	Reading (dBuV)	C.F (dB)	Measurement (dBuV/m)	Margin (dB)	Limit (dBuV)	Height (cm)	Angle (deg)	Remark (QP/PK/AV)	
1	*	5121.52	47.33	4.17	51.5	-22.5	74	150	-10	Peak
2		5150	45.62	4.18	49.8	-24.2	74	150	-10	Peak
3		5175.43	95.74	4.08	99.82	25.82	74	150	-10	Peak

Note :

- "\*" means the worst value in this measurement data °
- C.F ( Correction Factor ) = Antenna Factor (dB)+ Cable Loss (dB) – Preamplifier(dB) °
- Measurement (dBuV/m) = Reading(dBuV) + C.F ( Correction Factor ) °



EUT	14249-RF2-B	Test Date	2016.10.21
Factor	BBHA 9120D (1GHz~18GHz)	Temp. / Humidity	21°C / 57%
Polarity	Vertical	Site / Engineer	AC1 / Kevin
Test Mode	MODE2-CH36	Test Voltage	By Battery

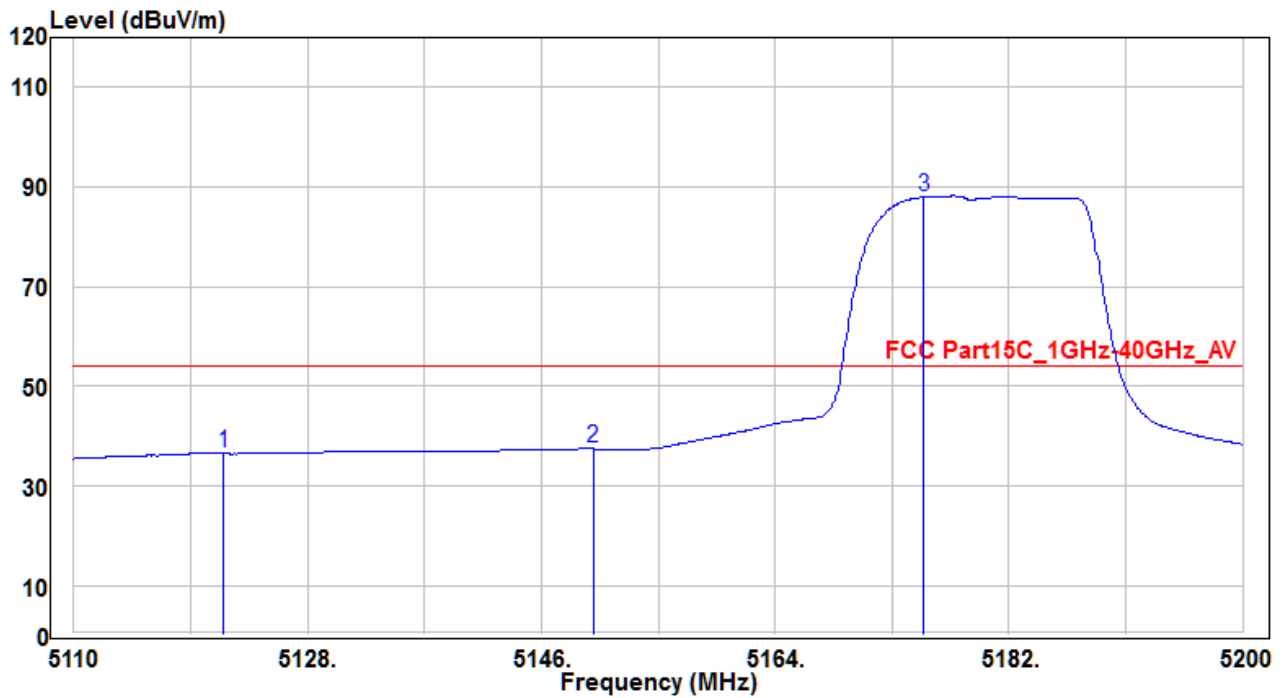

No	Frequency (MHz)	Reading (dBuV)	C.F (dB)	Measurement (dBuV/m)	Margin (dB)	Limit (dBuV)	Height (cm)	Angle (deg)	Remark (QP/PK/AV)
1	5121.52	32.35	4.17	36.52	-17.48	54	150	-10	Average
2	* 5150	33.26	4.18	37.44	-16.56	54	150	-10	Average
3	5175.43	83.9	4.08	87.98	33.98	54	150	-10	Average

Note :

- "\*" means the worst value in this measurement data °
- C.F ( Correction Factor ) = Antenna Factor (dB)+ Cable Loss (dB) – Preamplifier(dB) °
- Measurement (dBuV/m) = Reading(dBuV) + C.F ( Correction Factor ) °

EUT	14249-RF2-B	Test Date	2016.10.21
Factor	BBHA 9120D (1GHz~18GHz)	Temp. / Humidity	21°C / 57%
Polarity	Horizontal	Site / Engineer	AC1 / Kevin
Test Mode	MODE2-CH149	Test Voltage	By Battery

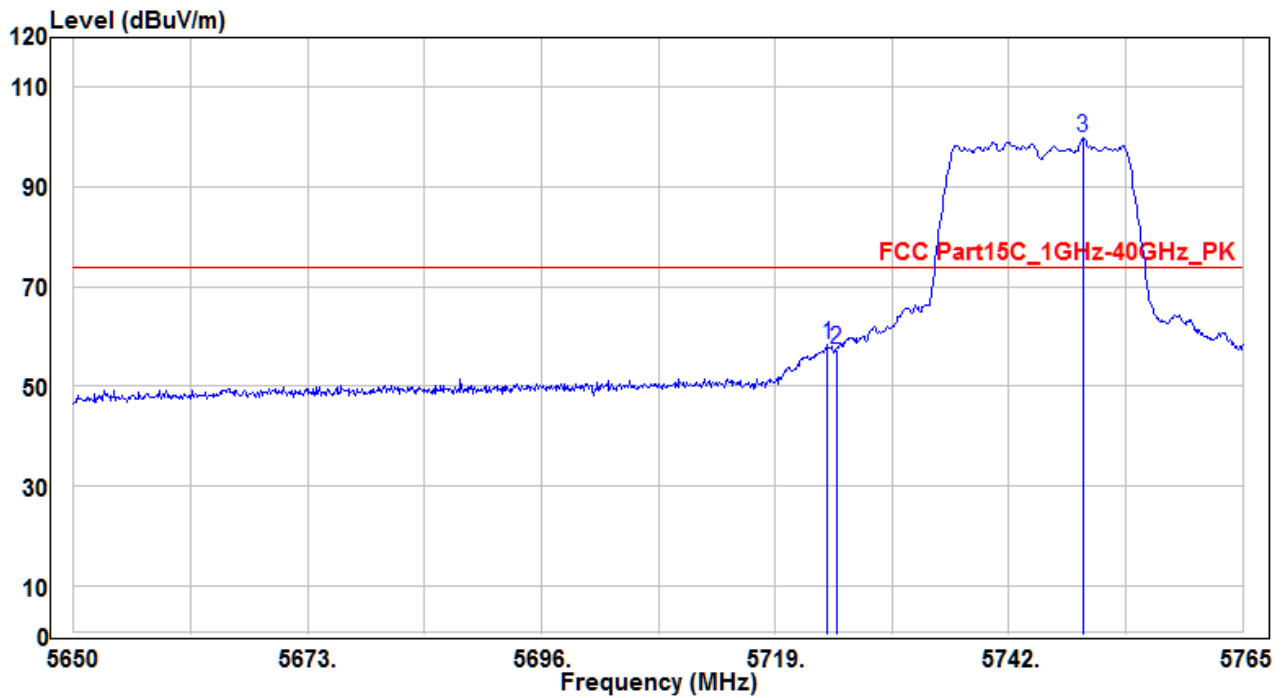

No		Frequency (MHz)	Reading (dBuV)	C.F (dB)	Measurement (dBuV/m)	Margin (dB)	Limit (dBuV)	Height (cm)	Angle (deg)	Remark (QP/PK/AV)
1	*	5724.175	53.21	5.02	58.23	-15.77	74	150	-25	Peak
2		5725	52.28	5.03	57.31	-16.69	74	150	-25	Peak
3		5749.245	94.56	5.19	99.75	25.75	74	150	-25	Peak

Note :

- "\*" means the worst value in this measurement data °
- C.F ( Correction Factor ) = Antenna Factor (dB)+ Cable Loss (dB) – Preamplifier(dB) °
- Measurement (dBuV/m) = Reading(dBuV) + C.F ( Correction Factor ) °

EUT	14249-RF2-B	Test Date	2016.10.21
Factor	BBHA 9120D (1GHz~18GHz)	Temp. / Humidity	21°C / 57%
Polarity	Horizontal	Site / Engineer	AC1 / Kevin
Test Mode	MODE2-CH149	Test Voltage	By Battery

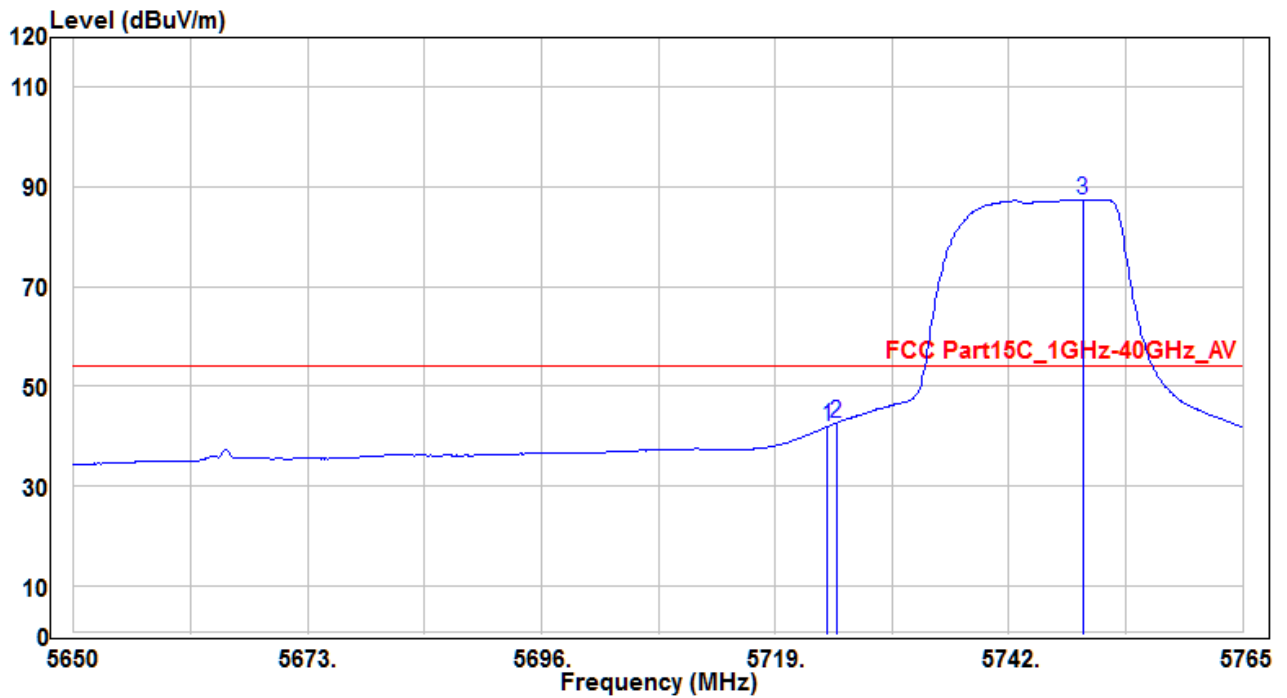

No	Frequency (MHz)	Reading (dBuV)	C.F (dB)	Measurement (dBuV/m)	Margin (dB)	Limit (dBuV)	Height (cm)	Angle (deg)	Remark (QP/PK/AV)
1	5724.175	36.9	5.02	41.92	-12.08	54	150	-25	Average
2	* 5725	37.57	5.03	42.6	-11.4	54	150	-25	Average
3	5749.245	82.18	5.19	87.37	33.37	54	150	-25	Average

Note :

- "\*" means the worst value in this measurement data °
- C.F ( Correction Factor ) = Antenna Factor (dB)+ Cable Loss (dB) – Preamplifier(dB) °
- Measurement (dBuV/m) = Reading(dBuV) + C.F ( Correction Factor ) °

EUT	14249-RF2-B	Test Date	2016.10.21
Factor	BBHA 9120D (1GHz~18GHz)	Temp. / Humidity	21°C / 57%
Polarity	Vertical	Site / Engineer	AC1 / Kevin
Test Mode	MODE2-CH149	Test Voltage	By Battery

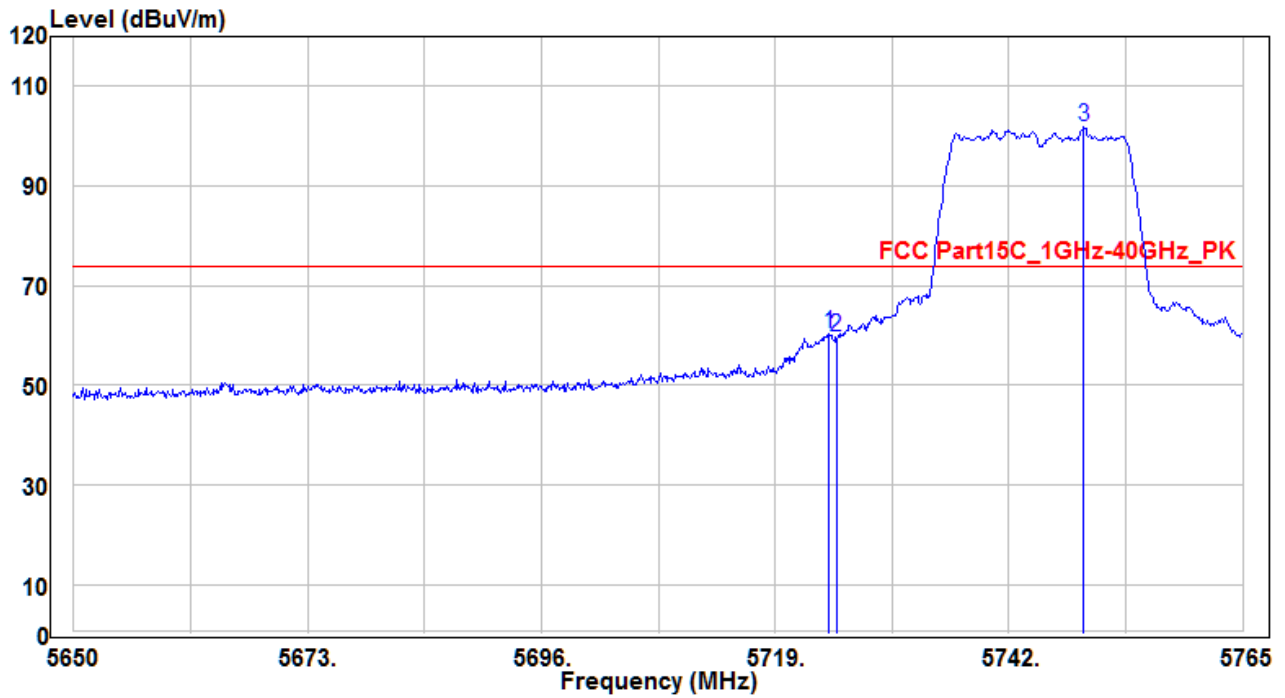

No	Frequency (MHz)	Reading (dBuV)	C.F (dB)	Measurement (dBuV/m)	Margin (dB)	Limit (dBuV)	Height (cm)	Angle (deg)	Remark (QP/PK/AV)	
1	*	5724.29	55.39	5.02	60.41	-13.59	74	150	390	Peak
2		5725	54.7	5.03	59.73	-14.27	74	150	390	Peak
3		5749.36	96.76	5.19	101.95	27.95	74	150	390	Peak

Note :

1. " \* " means the worst value in this measurement data ◦
2. C.F ( Correction Factor ) = Antenna Factor (dB)+ Cable Loss (dB) – Preamplifier(dB) ◦
3. Measurement (dBuV/m) = Reading(dBuV) + C.F ( Correction Factor ) ◦

EUT	14249-RF2-B	Test Date	2016.10.21
Factor	BBHA 9120D (1GHz~18GHz)	Temp. / Humidity	21°C / 57%
Polarity	Vertical	Site / Engineer	AC1 / Kevin
Test Mode	MODE2-CH149	Test Voltage	By Battery

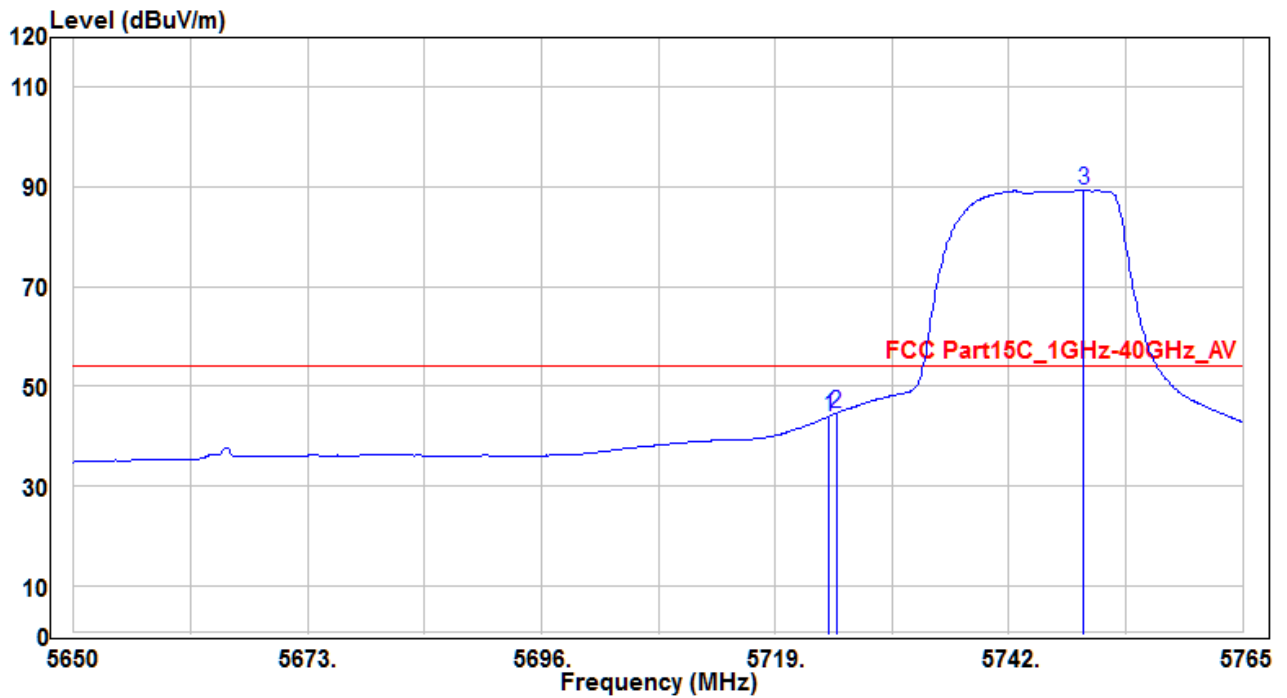

No	Frequency (MHz)	Reading (dBuV)	C.F (dB)	Measurement (dBuV/m)	Margin (dB)	Limit (dBuV)	Height (cm)	Angle (deg)	Remark (QP/PK/AV)
1	5724.29	38.97	5.02	43.99	-10.01	54	150	390	Average
2	* 5725	39.55	5.03	44.58	-9.42	54	150	390	Average
3	5749.36	84.01	5.19	89.2	35.2	54	150	390	Average

Note :

- "\*" means the worst value in this measurement data °
- C.F ( Correction Factor ) = Antenna Factor (dB)+ Cable Loss (dB) – Preamplifier(dB) °
- Measurement (dBuV/m) = Reading(dBuV) + C.F ( Correction Factor ) °

EUT	14249-RF2-B	Test Date	2016.10.21
Factor	BBHA 9120D (1GHz~18GHz)	Temp. / Humidity	21°C / 57%
Polarity	Horizontal	Site / Engineer	AC1 / Kevin
Test Mode	MODE2-CH165	Test Voltage	By Battery

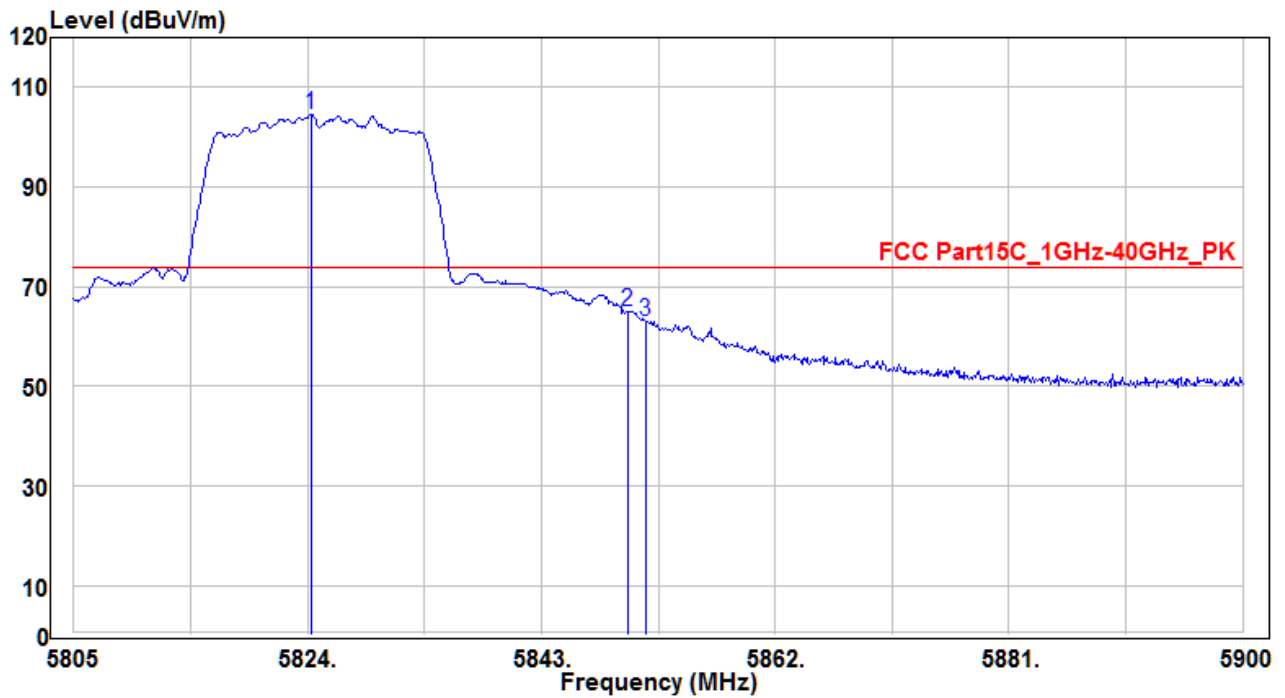

No	Frequency (MHz)	Reading (dBuV)	C.F (dB)	Measurement (dBuV/m)	Margin (dB)	Limit (dBuV)	Height (cm)	Angle (deg)	Remark (QP/PK/AV)
1	5824.285	99.02	5.58	104.6	30.6	74	150	335	Peak
2	* 5850.03	59.12	5.73	64.85	-9.15	74	150	335	Peak
3	5851.455	57.29	5.74	63.03	-10.97	74	150	335	Peak

Note :

- "\*" means the worst value in this measurement data °
- C.F ( Correction Factor ) = Antenna Factor (dB)+ Cable Loss (dB) – Preamplifier(dB) °
- Measurement (dBuV/m) = Reading(dBuV) + C.F ( Correction Factor ) °

EUT	14249-RF2-B	Test Date	2016.10.21
Factor	BBHA 9120D (1GHz~18GHz)	Temp. / Humidity	21°C / 57%
Polarity	Horizontal	Site / Engineer	AC1 / Kevin
Test Mode	MODE2-CH165	Test Voltage	By Battery

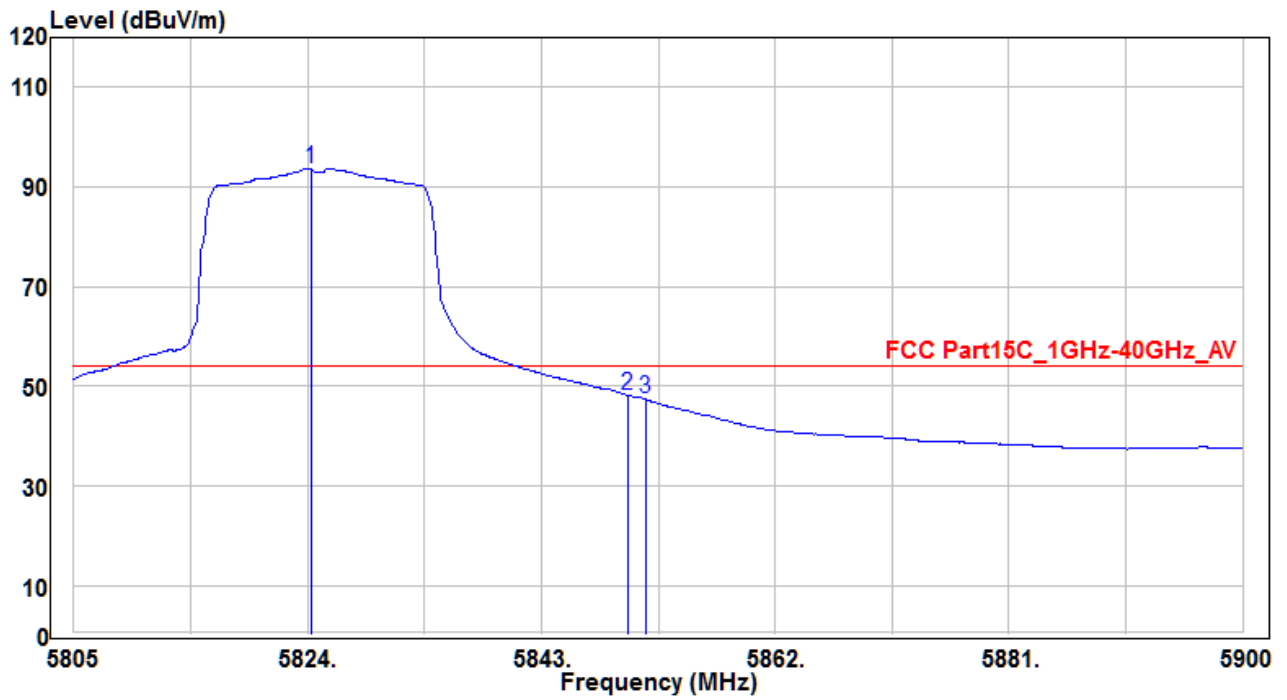

No	Frequency (MHz)	Reading (dBuV)	C.F (dB)	Measurement (dBuV/m)	Margin (dB)	Limit (dBuV)	Height (cm)	Angle (deg)	Remark (QP/PK/AV)
1	5824.285	87.9	5.58	93.48	39.48	54	150	335	Average
2	* 5850.03	42.49	5.73	48.22	-5.78	54	150	335	Average
3	5851.455	41.68	5.74	47.42	-6.58	54	150	335	Average

Note :

- " \* " means the worst value in this measurement data °
- C.F ( Correction Factor ) = Antenna Factor (dB)+ Cable Loss (dB) – Preamplifier(dB) °
- Measurement (dBuV/m) = Reading(dBuV) + C.F ( Correction Factor ) °

EUT	14249-RF2-B	Test Date	2016.10.21
Factor	BBHA 9120D (1GHz~18GHz)	Temp. / Humidity	21°C / 57%
Polarity	Vertical	Site / Engineer	AC1 / Kevin
Test Mode	MODE2-CH165	Test Voltage	By Battery

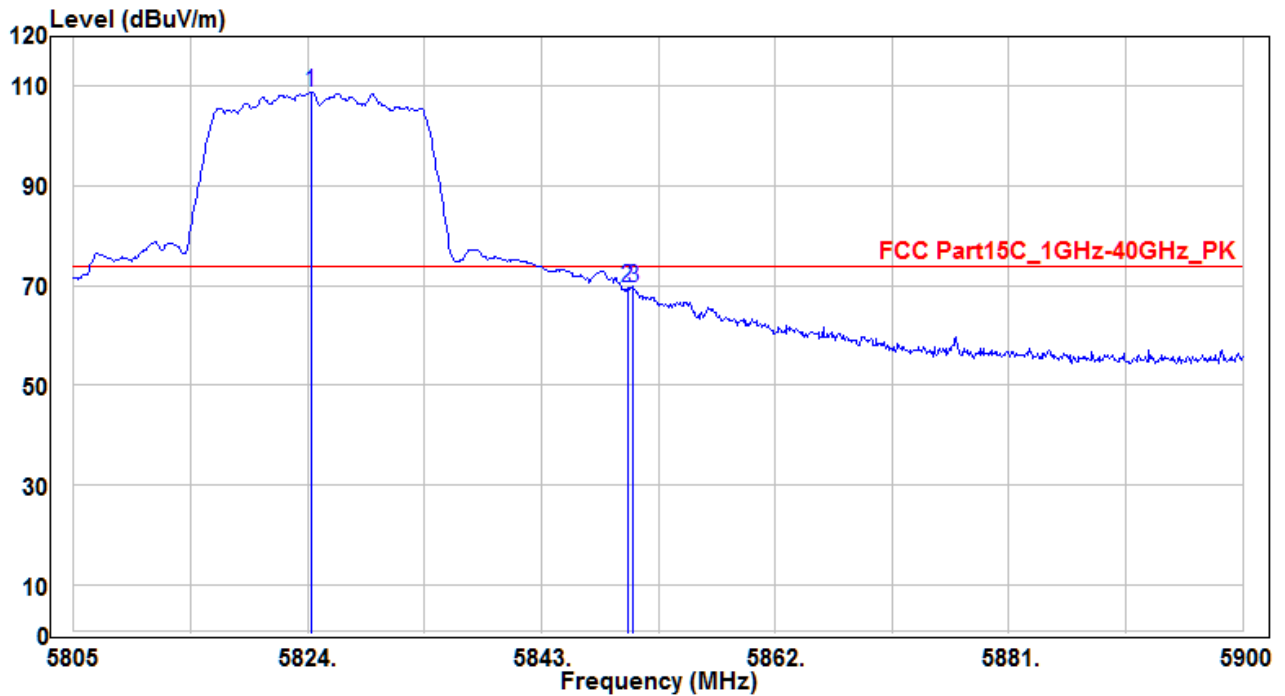

No	Frequency (MHz)	Reading (dBuV)	C.F (dB)	Measurement (dBuV/m)	Margin (dB)	Limit (dBuV)	Height (cm)	Angle (deg)	Remark (QP/PK/AV)
1	5824.285	103.38	5.58	108.96	34.96	74	150	-25	Peak
2	* 5850	63.87	5.73	69.6	-4.4	74	150	-25	Peak
3	5850.505	63.76	5.73	69.49	-4.51	74	150	-25	Peak

Note :

- "\*" means the worst value in this measurement data °
- C.F ( Correction Factor ) = Antenna Factor (dB)+ Cable Loss (dB) – Preamplifier(dB) °
- Measurement (dBuV/m) = Reading(dBuV) + C.F ( Correction Factor ) °



EUT	14249-RF2-B	Test Date	2016.10.21
Factor	BBHA 9120D (1GHz~18GHz)	Temp. / Humidity	21°C / 57%
Polarity	Vertical	Site / Engineer	AC1 / Kevin
Test Mode	MODE2-CH165	Test Voltage	By Battery

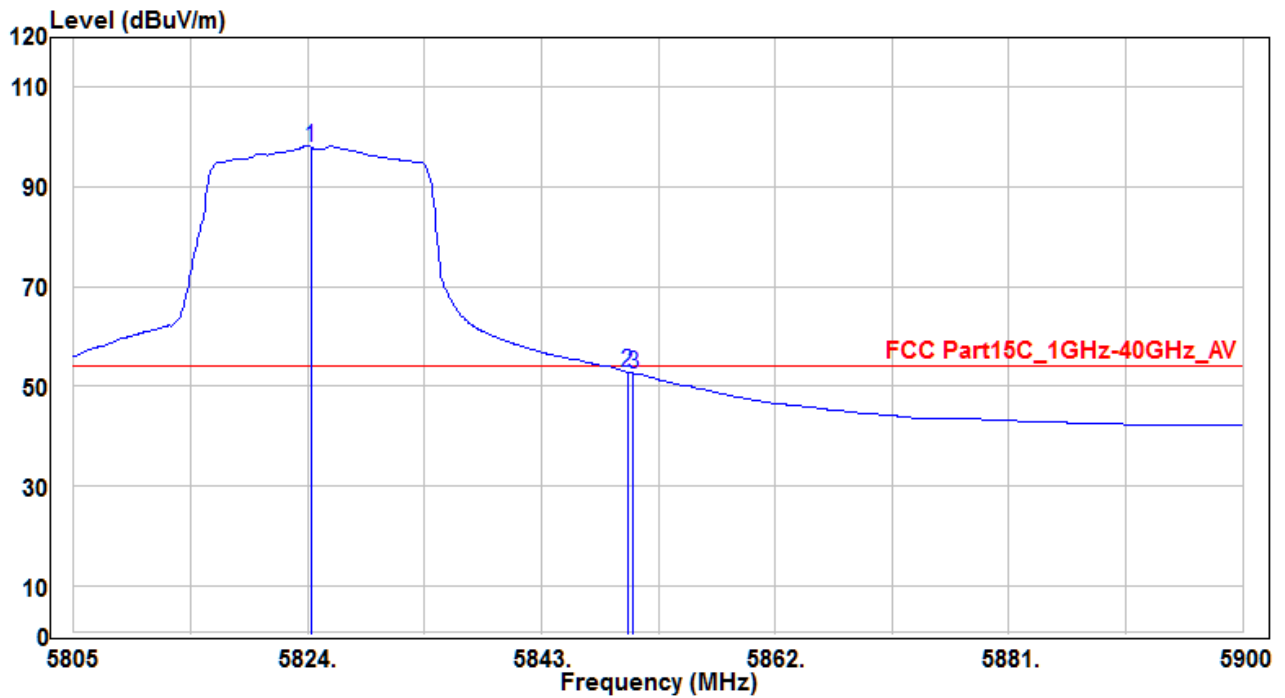

No	Frequency (MHz)	Reading (dBuV)	C.F (dB)	Measurement (dBuV/m)	Margin (dB)	Limit (dBuV)	Height (cm)	Angle (deg)	Remark (QP/PK/AV)
1	5824.285	92.41	5.58	97.99	43.99	54	150	-25	Average
2	* 5850	47.15	5.73	52.88	-1.12	54	150	-25	Average
3	5850.505	46.85	5.73	52.58	-1.42	54	150	-25	Average

Note :

- "\*" means the worst value in this measurement data °
- C.F ( Correction Factor ) = Antenna Factor (dB)+ Cable Loss (dB) – Preamplifier(dB) °
- Measurement (dBuV/m) = Reading(dBuV) + C.F ( Correction Factor ) °

EUT	14249-RF2-B	Test Date	2016.10.21
Factor	BBHA 9120D (1GHz~18GHz)	Temp. / Humidity	21°C / 57%
Polarity	Horizontal	Site / Engineer	AC1 / Kevin
Test Mode	MODE3-CH38	Test Voltage	By Battery

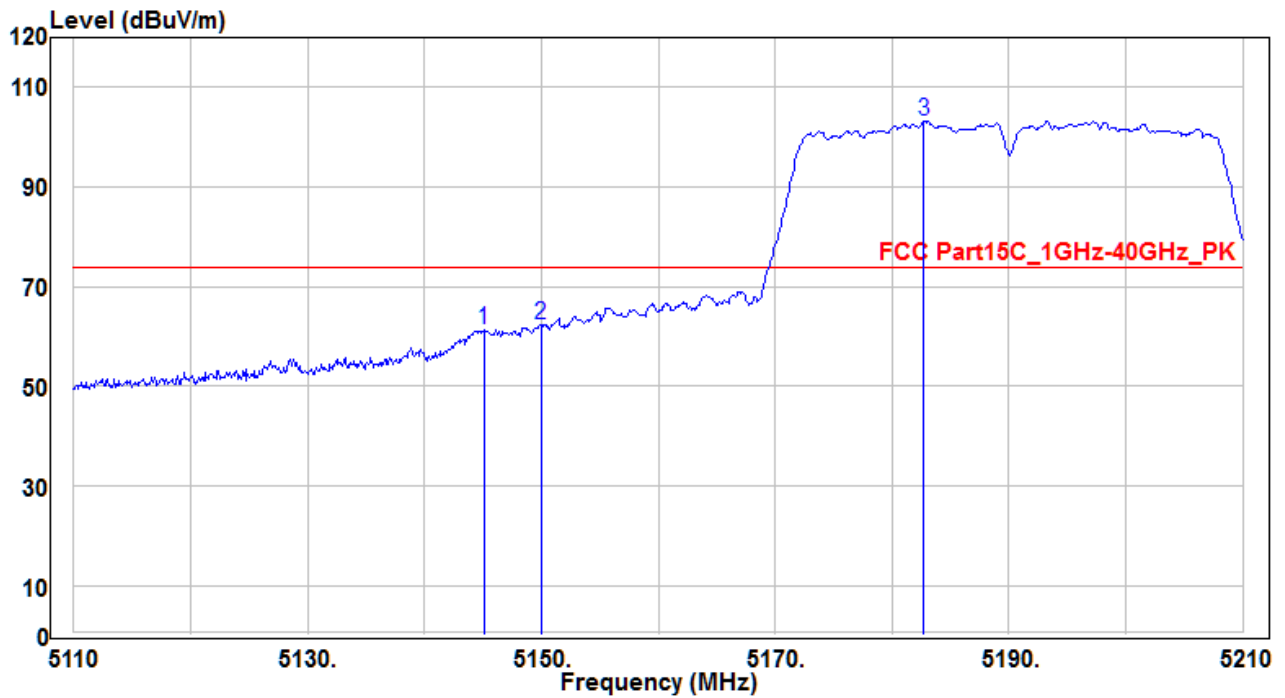

No	Frequency (MHz)	Reading (dBuV)	C.F (dB)	Measurement (dBuV/m)	Margin (dB)	Limit (dBuV)	Height (cm)	Angle (deg)	Remark (QP/PK/AV)
1	5145.1	57.13	4.17	61.3	-12.7	74	150	25	Peak
2	* 5150	58.18	4.18	62.36	-11.64	74	150	25	Peak
3	5182.7	99.07	4.06	103.13	29.13	74	150	25	Peak

Note :

- "\*" means the worst value in this measurement data °
- C.F ( Correction Factor ) = Antenna Factor (dB)+ Cable Loss (dB) – Preamplifier(dB) °
- Measurement (dBuV/m) = Reading(dBuV) + C.F ( Correction Factor ) °

EUT	14249-RF2-B	Test Date	2016.10.21
Factor	BBHA 9120D (1GHz~18GHz)	Temp. / Humidity	21°C / 57%
Polarity	Horizontal	Site / Engineer	AC1 / Kevin
Test Mode	MODE3-CH38	Test Voltage	By Battery

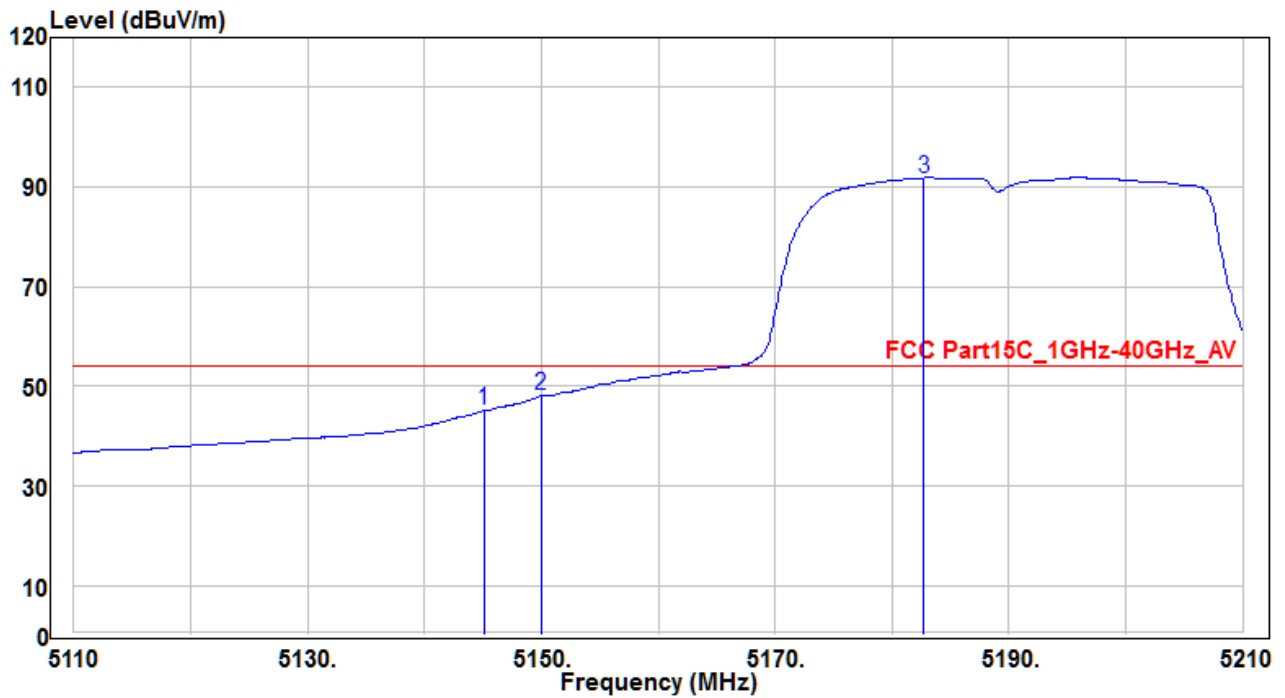

No	Frequency (MHz)	Reading (dBuV)	C.F (dB)	Measurement (dBuV/m)	Margin (dB)	Limit (dBuV)	Height (cm)	Angle (deg)	Remark (QP/PK/AV)
1	5145.1	40.92	4.17	45.09	-8.91	54	150	25	Average
2	* 5150	43.85	4.18	48.03	-5.97	54	150	25	Average
3	5182.7	87.76	4.06	91.82	37.82	54	150	25	Average

Note :

- "\*" means the worst value in this measurement data °
- C.F ( Correction Factor ) = Antenna Factor (dB)+ Cable Loss (dB) – Preamplifier(dB) °
- Measurement (dBuV/m) = Reading(dBuV) + C.F ( Correction Factor ) °

EUT	14249-RF2-B	Test Date	2016.10.21
Factor	BBHA 9120D (1GHz~18GHz)	Temp. / Humidity	21°C / 57%
Polarity	Vertical	Site / Engineer	AC1 / Kevin
Test Mode	MODE3-CH38	Test Voltage	By Battery

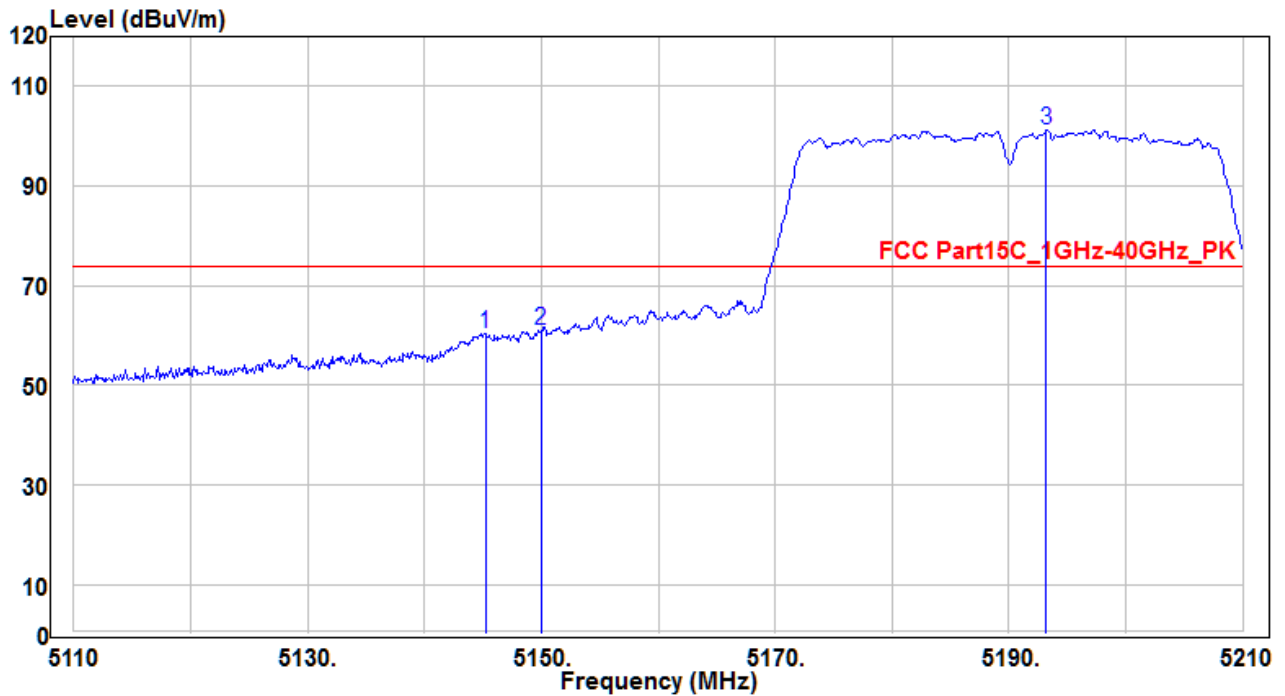

No	Frequency (MHz)	Reading (dBuV)	C.F (dB)	Measurement (dBuV/m)	Margin (dB)	Limit (dBuV)	Height (cm)	Angle (deg)	Remark (QP/PK/AV)
1	5145.2	56.14	4.17	60.31	-13.69	74	150	350	Peak
2	* 5150	56.68	4.18	60.86	-13.14	74	150	350	Peak
3	5193.2	97.13	4.02	101.15	27.15	74	150	350	Peak

Note :

1. " \* " means the worst value in this measurement data °
2. C.F ( Correction Factor ) = Antenna Factor (dB)+ Cable Loss (dB) – Preamplifier(dB) °
3. Measurement (dBuV/m) = Reading(dBuV) + C.F ( Correction Factor ) °

EUT	14249-RF2-B	Test Date	2016.10.21
Factor	BBHA 9120D (1GHz~18GHz)	Temp. / Humidity	21°C / 57%
Polarity	Vertical	Site / Engineer	AC1 / Kevin
Test Mode	MODE3-CH38	Test Voltage	By Battery

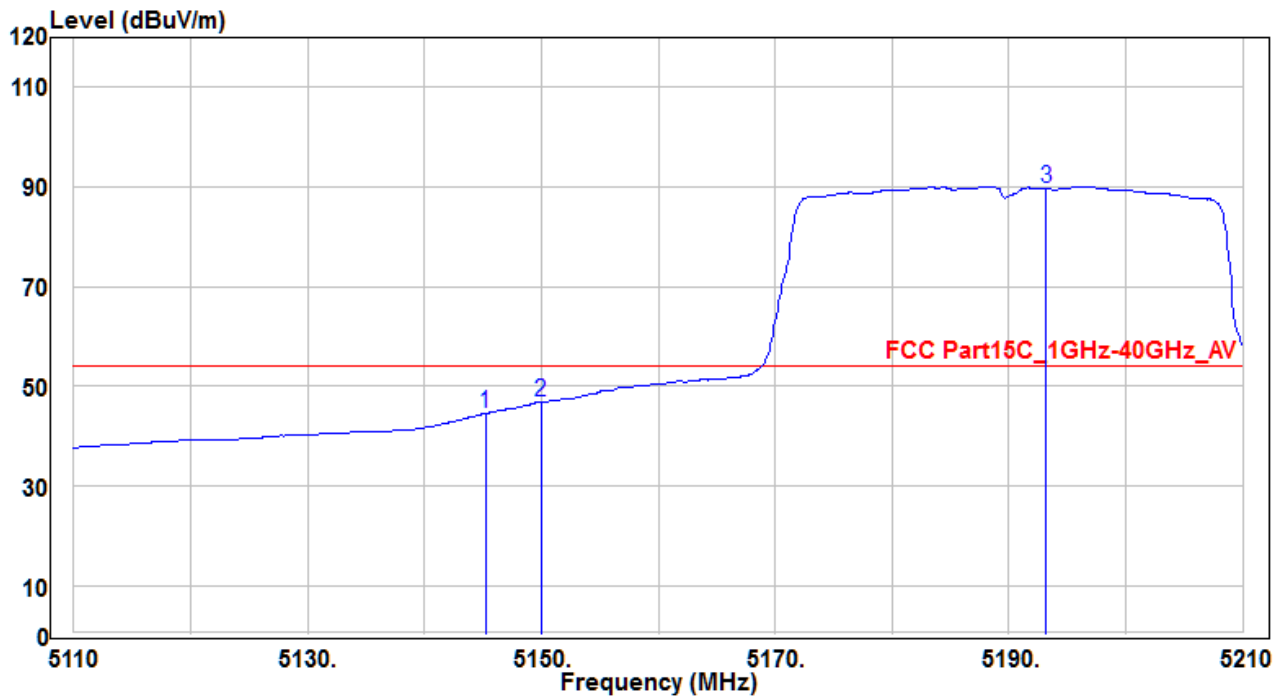

No	Frequency (MHz)	Reading (dBuV)	C.F (dB)	Measurement (dBuV/m)	Margin (dB)	Limit (dBuV)	Height (cm)	Angle (deg)	Remark (QP/PK/AV)
1	5145.2	40.38	4.17	44.55	-9.45	54	150	350	Average
2	* 5150	42.8	4.18	46.98	-7.02	54	150	350	Average
3	5193.2	85.6	4.02	89.62	35.62	54	150	350	Average

Note :

- "\*" means the worst value in this measurement data °
- C.F ( Correction Factor ) = Antenna Factor (dB)+ Cable Loss (dB) – Preamplifier(dB) °
- Measurement (dBuV/m) = Reading(dBuV) + C.F ( Correction Factor ) °

EUT	14249-RF2-B	Test Date	2016.10.21
Factor	BBHA 9120D (1GHz~18GHz)	Temp. / Humidity	21°C / 57%
Polarity	Horizontal	Site / Engineer	AC1 / Kevin
Test Mode	MODE3-CH151	Test Voltage	By Battery

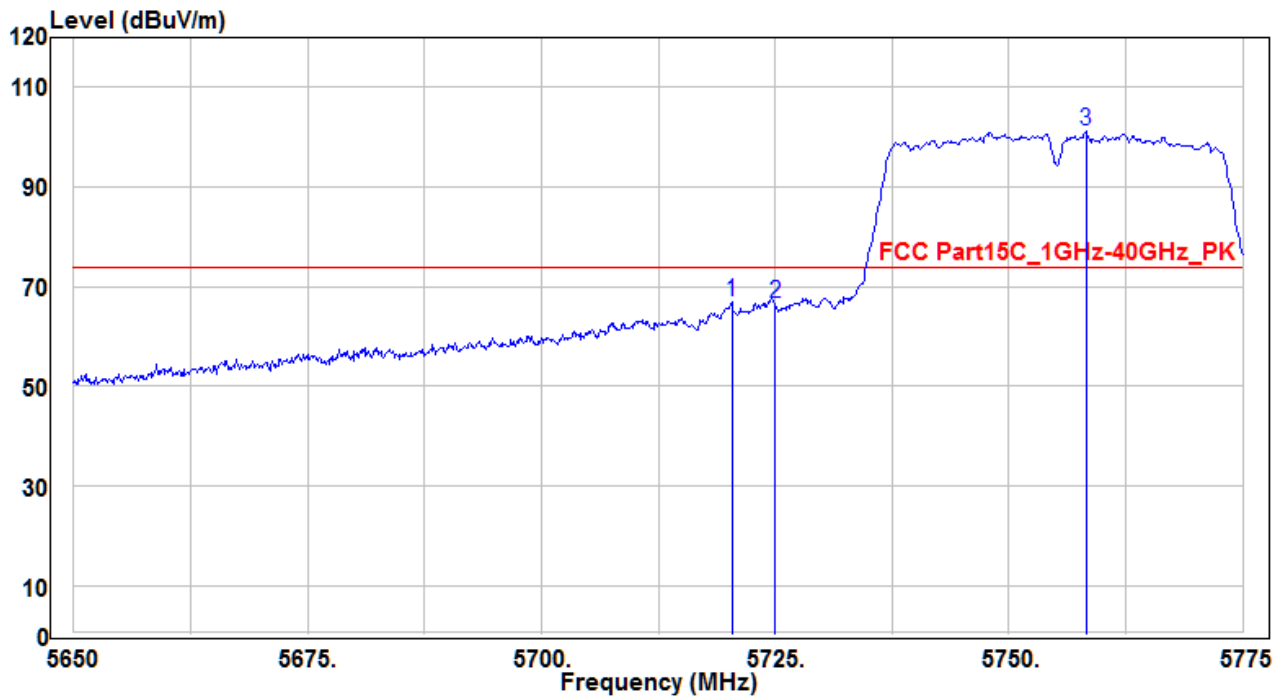

No		Frequency (MHz)	Reading (dBuV)	C.F (dB)	Measurement (dBuV/m)	Margin (dB)	Limit (dBuV)	Height (cm)	Angle (deg)	Remark (QP/PK/AV)
1	*	5720.375	61.79	5.01	66.8	-7.2	74	150	385	Peak
2		5725	61.69	5.03	66.72	-7.28	74	150	385	Peak
3		5758.25	95.83	5.23	101.06	27.06	74	150	385	Peak

Note :

- "\*" means the worst value in this measurement data °
- C.F ( Correction Factor ) = Antenna Factor (dB)+ Cable Loss (dB) – Preamplifier(dB) °
- Measurement (dBuV/m) = Reading(dBuV) + C.F ( Correction Factor ) °

EUT	14249-RF2-B	Test Date	2016.10.21
Factor	BBHA 9120D (1GHz~18GHz)	Temp. / Humidity	21°C / 57%
Polarity	Horizontal	Site / Engineer	AC1 / Kevin
Test Mode	MODE3-CH151	Test Voltage	By Battery

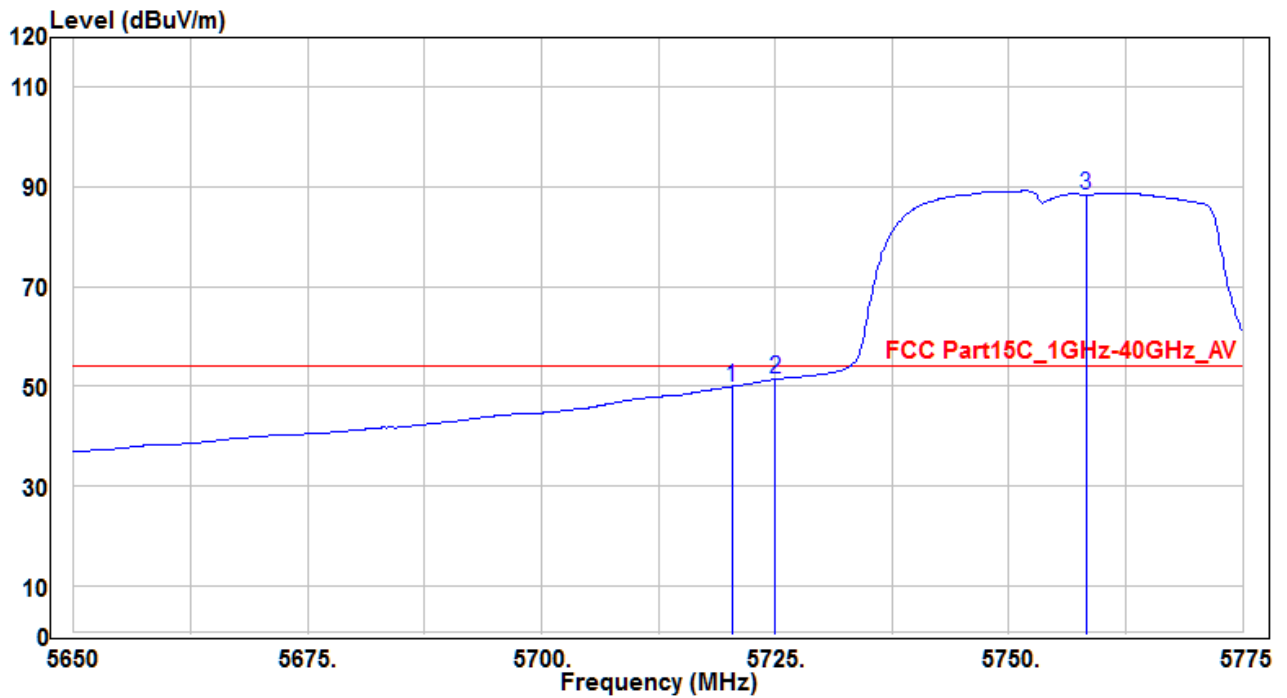

No	Frequency (MHz)	Reading (dBuV)	C.F (dB)	Measurement (dBuV/m)	Margin (dB)	Limit (dBuV)	Height (cm)	Angle (deg)	Remark (QP/PK/AV)
1	5720.375	44.92	5.01	49.93	-4.07	54	150	385	Average
2	* 5725	46.37	5.03	51.4	-2.6	54	150	385	Average
3	5758.25	83.24	5.23	88.47	34.47	54	150	385	Average

Note :

- "\*" means the worst value in this measurement data °
- C.F ( Correction Factor ) = Antenna Factor (dB)+ Cable Loss (dB) – Preamplifier(dB) °
- Measurement (dBuV/m) = Reading(dBuV) + C.F ( Correction Factor ) °

EUT	14249-RF2-B	Test Date	2016.10.21
Factor	BBHA 9120D (1GHz~18GHz)	Temp. / Humidity	21°C / 57%
Polarity	Vertical	Site / Engineer	AC1 / Kevin
Test Mode	MODE3-CH151	Test Voltage	By Battery

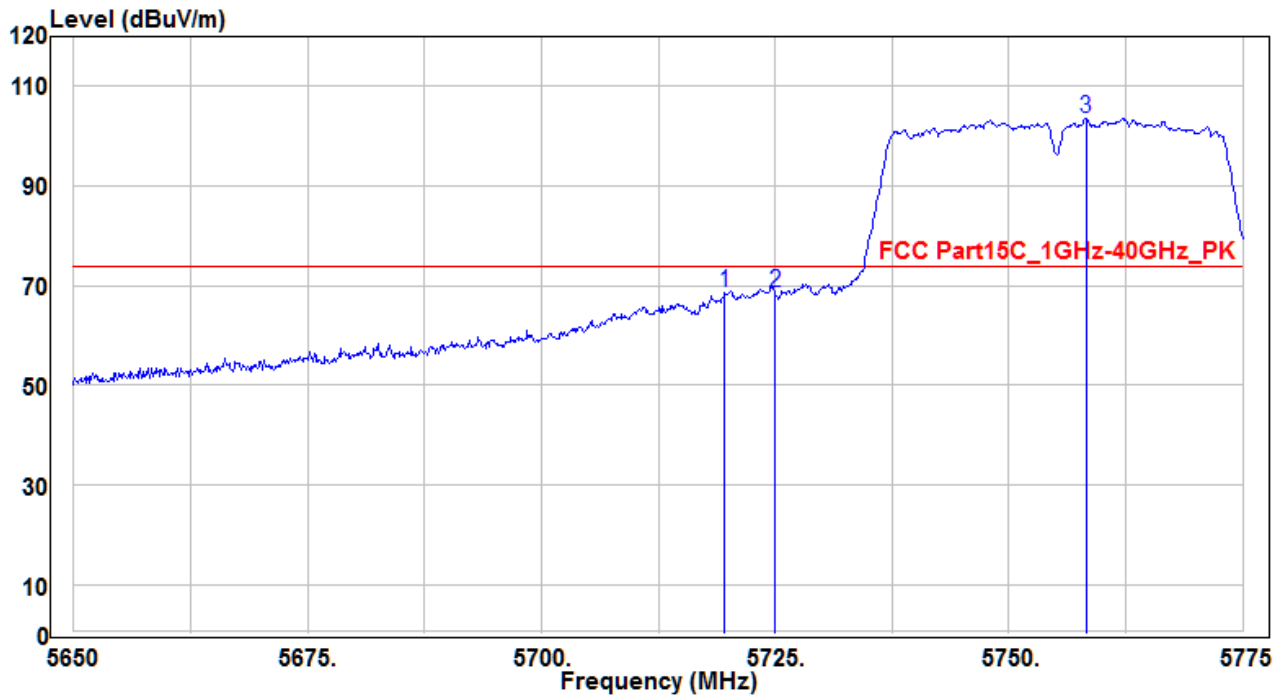

No	Frequency (MHz)	Reading (dBuV)	C.F (dB)	Measurement (dBuV/m)	Margin (dB)	Limit (dBuV)	Height (cm)	Angle (deg)	Remark (QP/PK/AV)	
1	*	5719.625	63.64	4.99	68.63	-5.37	74	150	-15	Peak
2		5725	63.52	5.03	68.55	-5.45	74	150	-15	Peak
3		5758.25	98.34	5.23	103.57	29.57	74	150	-15	Peak

Note :

1. " \* " means the worst value in this measurement data °
2. C.F ( Correction Factor ) = Antenna Factor (dB)+ Cable Loss (dB) – Preamplifier(dB) °
3. Measurement (dBuV/m) = Reading(dBuV) + C.F ( Correction Factor ) °



EUT	14249-RF2-B	Test Date	2016.10.21
Factor	BBHA 9120D (1GHz~18GHz)	Temp. / Humidity	21°C / 57%
Polarity	Vertical	Site / Engineer	AC1 / Kevin
Test Mode	MODE3-CH151	Test Voltage	By Battery

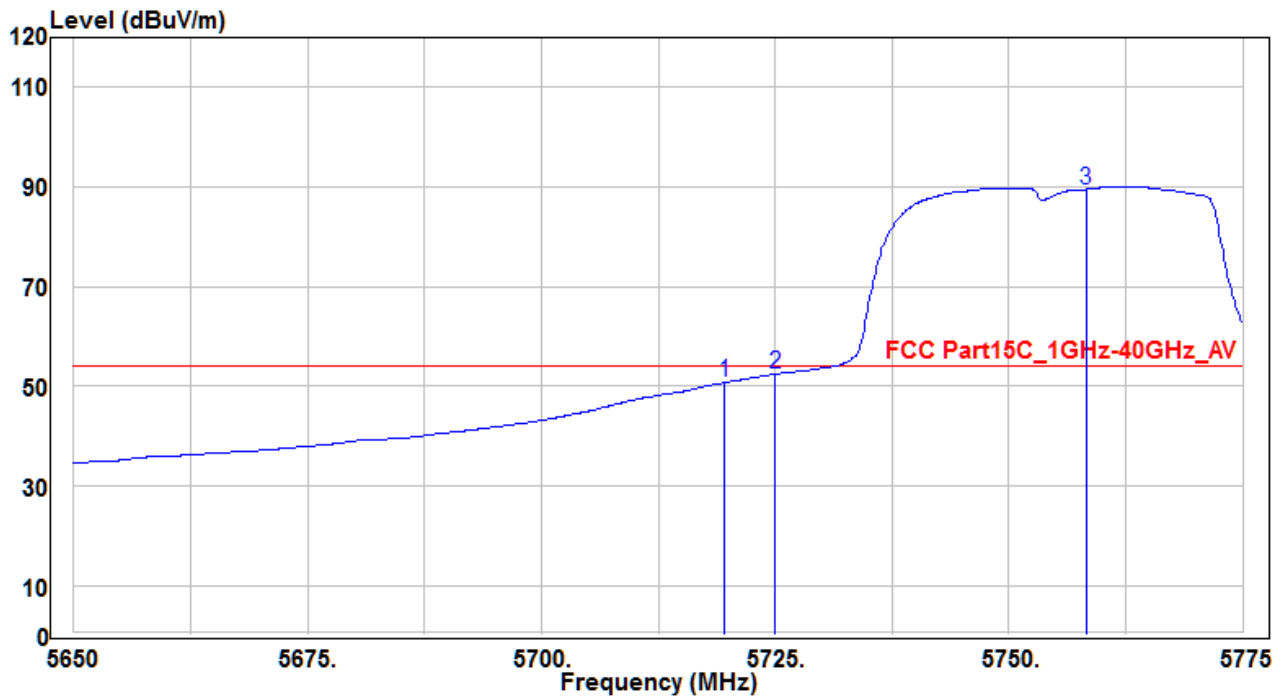

No	Frequency (MHz)	Reading (dBuV)	C.F (dB)	Measurement (dBuV/m)	Margin (dB)	Limit (dBuV)	Height (cm)	Angle (deg)	Remark (QP/PK/AV)
1	5719.625	45.75	4.99	50.74	-3.26	54	150	-15	Average
2	* 5725	47.43	5.03	52.46	-1.54	54	150	-15	Average
3	5758.25	84.27	5.23	89.5	35.5	54	150	-15	Average

Note :

- "\*" means the worst value in this measurement data °
- C.F ( Correction Factor ) = Antenna Factor (dB)+ Cable Loss (dB) – Preamplifier(dB) °
- Measurement (dBuV/m) = Reading(dBuV) + C.F ( Correction Factor ) °

EUT	14249-RF2-B	Test Date	2016.10.21
Factor	BBHA 9120D (1GHz~18GHz)	Temp. / Humidity	21°C / 57%
Polarity	Horizontal	Site / Engineer	AC1 / Kevin
Test Mode	MODE3-CH159	Test Voltage	By Battery

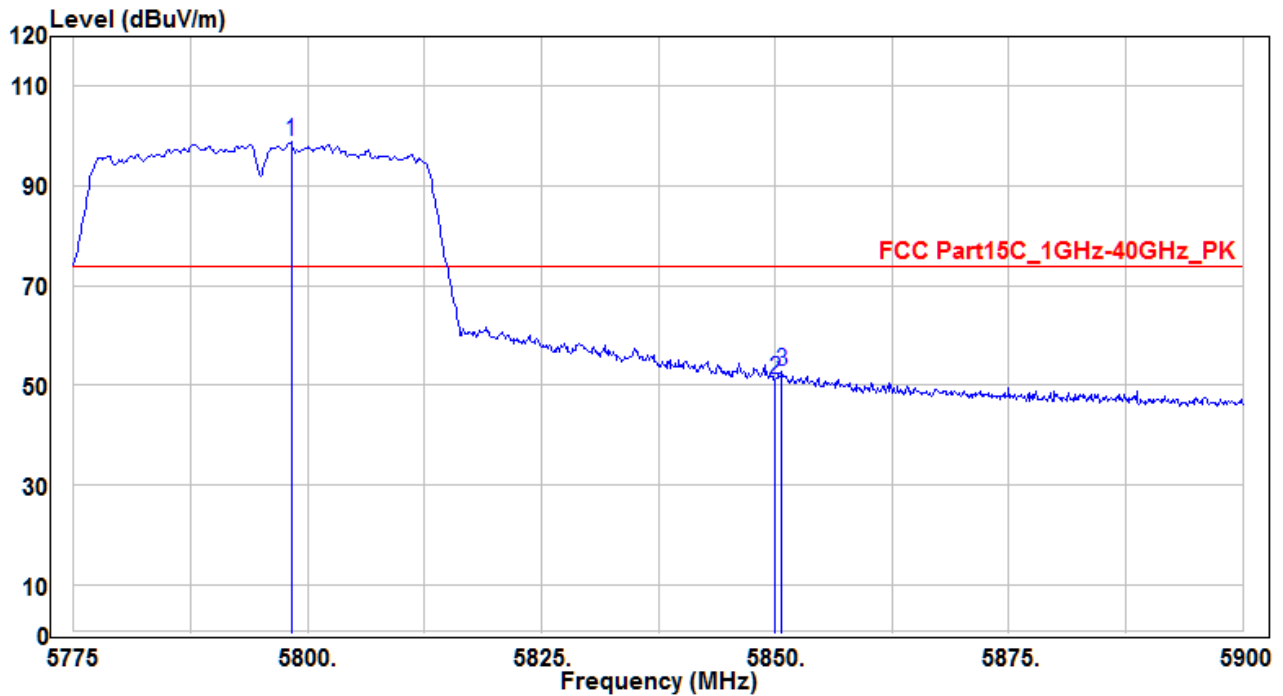

No	Frequency (MHz)	Reading (dBuV)	C.F (dB)	Measurement (dBuV/m)	Margin (dB)	Limit (dBuV)	Height (cm)	Angle (deg)	Remark (QP/PK/AV)
1	5798.25	93.31	5.44	98.75	24.75	74	150	-30	Peak
2	5850	45.55	5.73	51.28	-22.72	74	150	-30	Peak
3	* 5850.75	46.97	5.73	52.7	-21.3	74	150	-30	Peak

Note :

1. " \* " means the worst value in this measurement data °
2. C.F ( Correction Factor ) = Antenna Factor (dB)+ Cable Loss (dB) – Preamplifier(dB) °
3. Measurement (dBuV/m) = Reading(dBuV) + C.F ( Correction Factor ) °

EUT	14249-RF2-B	Test Date	2016.10.21
Factor	BBHA 9120D (1GHz~18GHz)	Temp. / Humidity	21°C / 57%
Polarity	Horizontal	Site / Engineer	AC1 / Kevin
Test Mode	MODE3-CH159	Test Voltage	By Battery

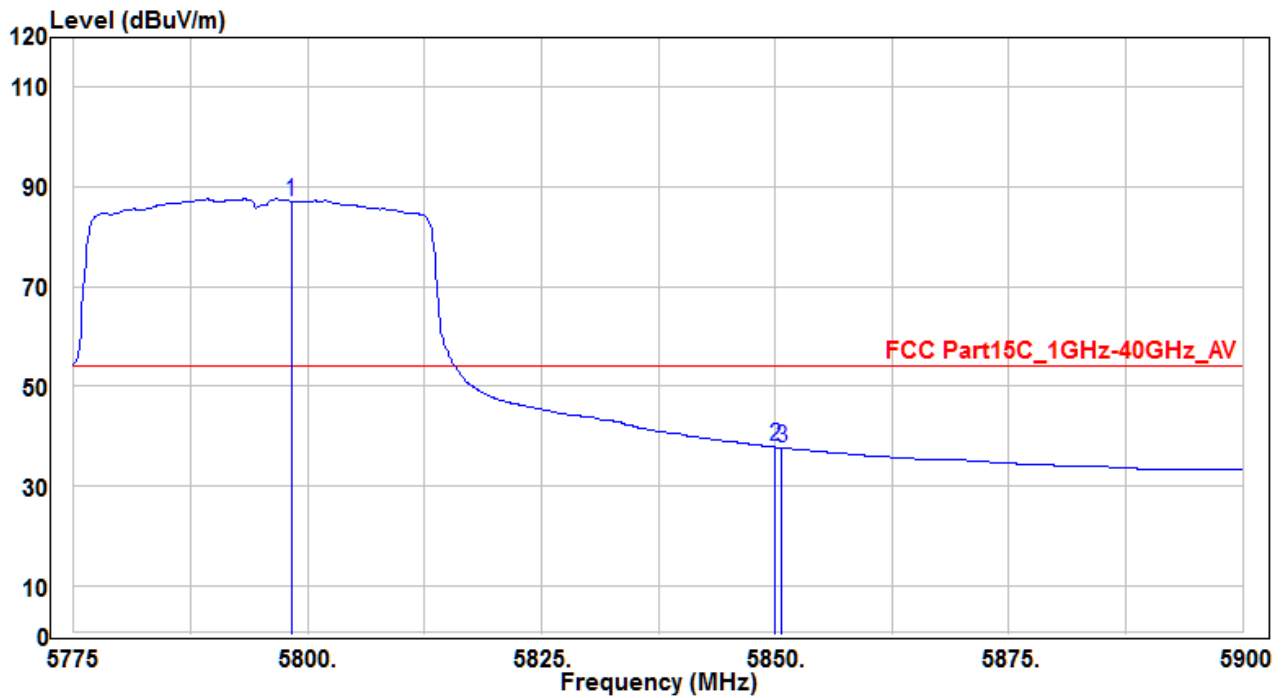

No	Frequency (MHz)	Reading (dBuV)	C.F (dB)	Measurement (dBuV/m)	Margin (dB)	Limit (dBuV)	Height (cm)	Angle (deg)	Remark (QP/PK/AV)
1	5798.25	81.73	5.44	87.17	33.17	54	150	-30	Average
2	* 5850	32.07	5.73	37.8	-16.2	54	150	-30	Average
3	5850.75	31.9	5.73	37.63	-16.37	54	150	-30	Average

Note :

- "\*" means the worst value in this measurement data °
- C.F ( Correction Factor ) = Antenna Factor (dB)+ Cable Loss (dB) – Preamplifier(dB) °
- Measurement (dBuV/m) = Reading(dBuV) + C.F ( Correction Factor ) °

EUT	14249-RF2-B	Test Date	2016.10.21
Factor	BBHA 9120D (1GHz~18GHz)	Temp. / Humidity	21°C / 57%
Polarity	Vertical	Site / Engineer	AC1 / Kevin
Test Mode	MODE3-CH159	Test Voltage	By Battery

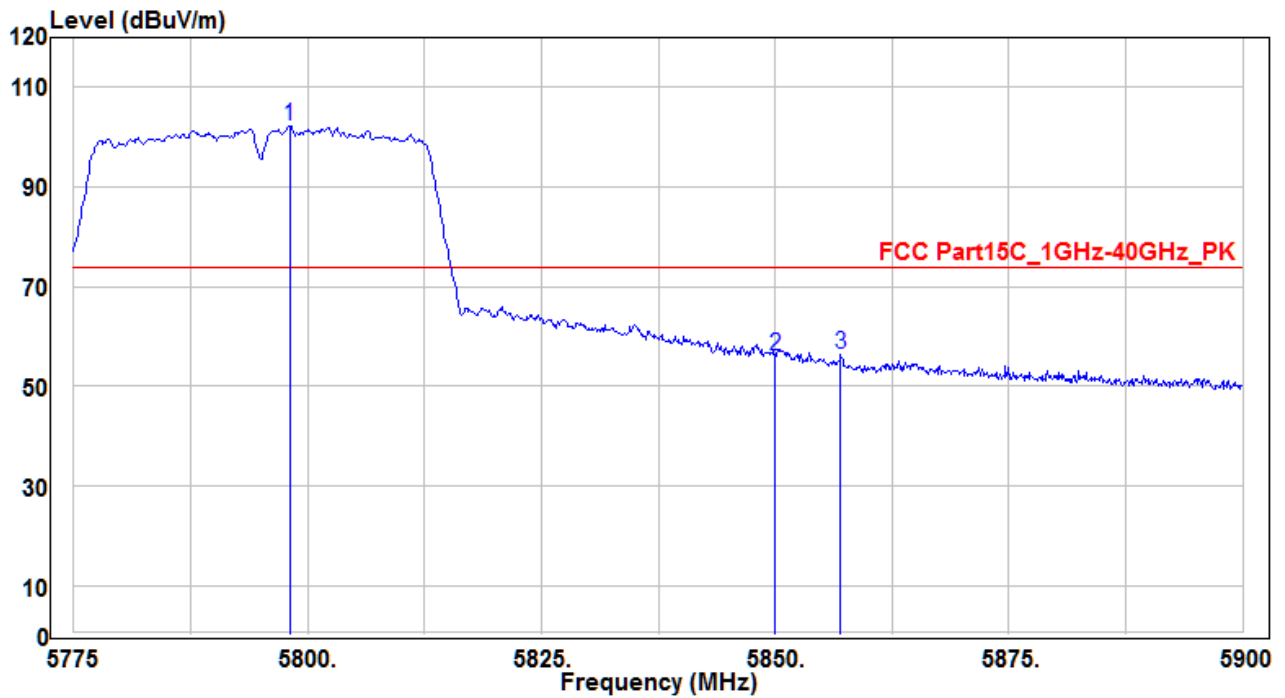

No	Frequency (MHz)	Reading (dBuV)	C.F (dB)	Measurement (dBuV/m)	Margin (dB)	Limit (dBuV)	Height (cm)	Angle (deg)	Remark (QP/PK/AV)
1	5798.125	96.92	5.43	102.35	28.35	74	150	330	Peak
2	5850	50.45	5.73	56.18	-17.82	74	150	330	Peak
3	* 5857	50.72	5.76	56.48	-17.52	74	150	330	Peak

Note :

- "\*" means the worst value in this measurement data °
- C.F ( Correction Factor ) = Antenna Factor (dB)+ Cable Loss (dB) – Preamplifier(dB) °
- Measurement (dBuV/m) = Reading(dBuV) + C.F ( Correction Factor ) °

EUT	14249-RF2-B	Test Date	2016.10.21
Factor	BBHA 9120D (1GHz~18GHz)	Temp. / Humidity	21°C / 57%
Polarity	Vertical	Site / Engineer	AC1 / Kevin
Test Mode	MODE3-CH159	Test Voltage	By Battery

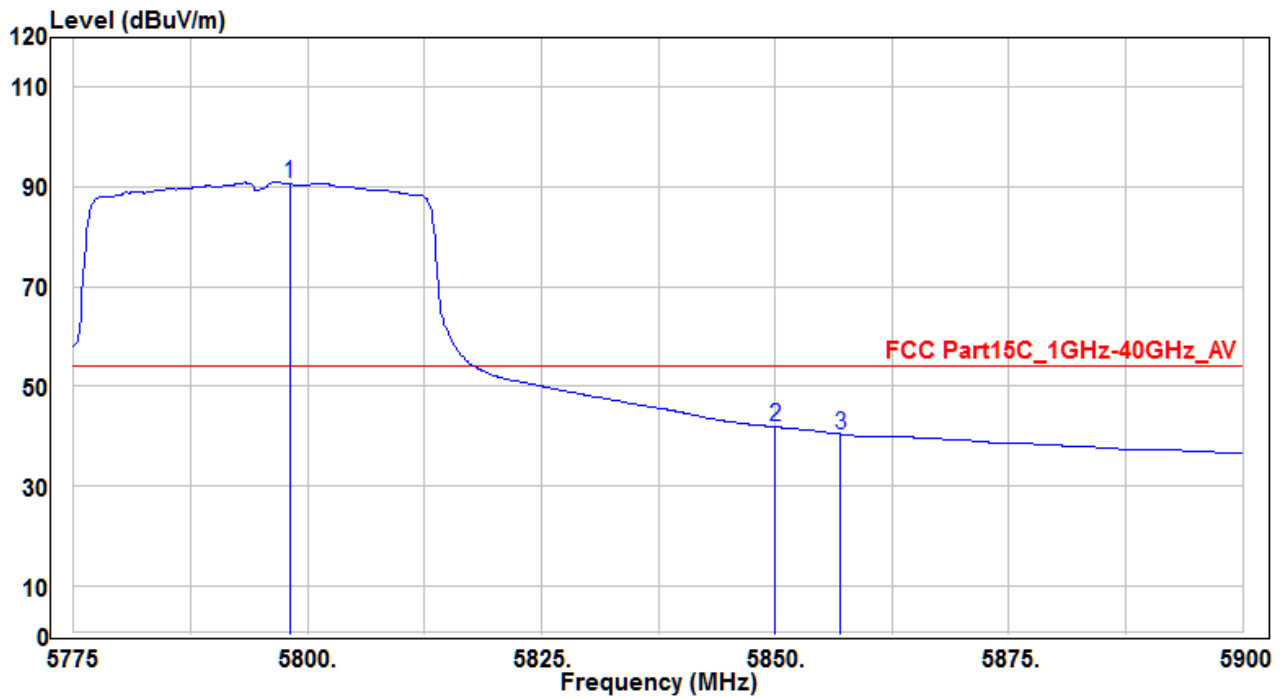

No	Frequency (MHz)	Reading (dBuV)	C.F (dB)	Measurement (dBuV/m)	Margin (dB)	Limit (dBuV)	Height (cm)	Angle (deg)	Remark (QP/PK/AV)
1	5798.125	85.19	5.43	90.62	36.62	54	150	330	Average
2	* 5850	36.14	5.73	41.87	-12.13	54	150	330	Average
3	5857	34.63	5.76	40.39	-13.61	54	150	330	Average

Note :

- "\*" means the worst value in this measurement data °
- C.F ( Correction Factor ) = Antenna Factor (dB)+ Cable Loss (dB) – Preamplifier(dB) °
- Measurement (dBuV/m) = Reading(dBuV) + C.F ( Correction Factor ) °

## 7.8. AC Conducted Emissions Measurement

### 7.8.1. Test Limit

FCC Part 15 Subpart C Paragraph 15.207 / RSS-Gen Limits		
Frequency (MHz)	QP (dB $\mu$ V)	Average (dB $\mu$ V)
0.15 - 0.50	66 - 56	56 - 46
0.50 - 5.0	56	46
5.0 - 30	60	50

Note 1: The lower limit shall apply at the transition frequencies.

Note 2: The limit decreases linearly with the logarithm of the frequency in the range 0.15MHz to 0.5MHz.

### 7.8.2. Test Setup

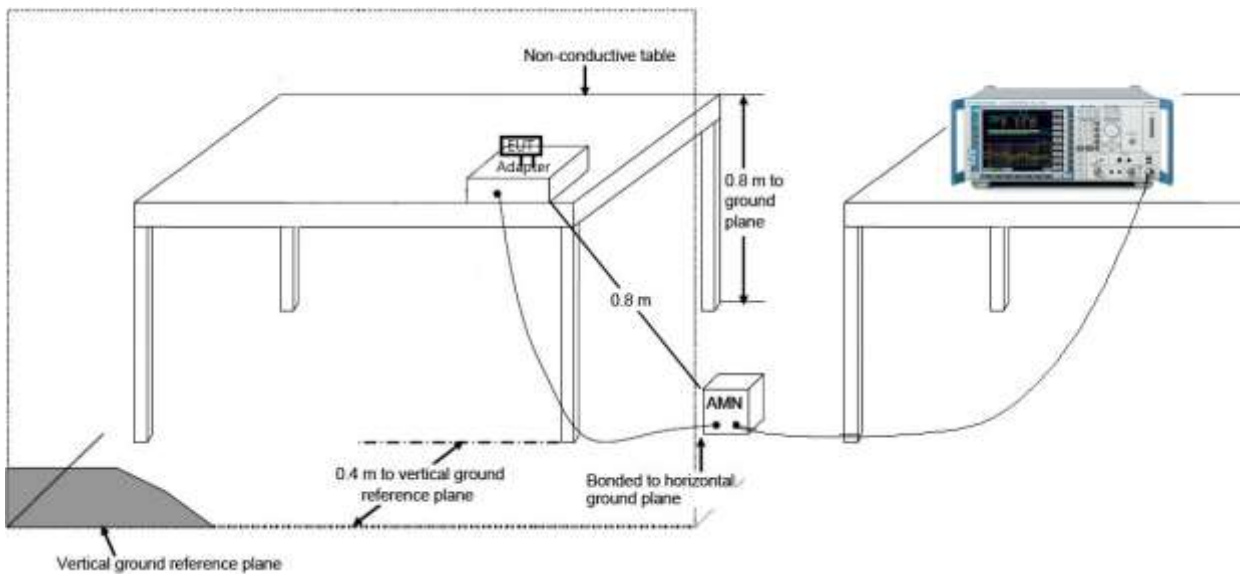

### 7.8.3. Test Result

EUT	14249-RF2-B	Test Date	2016.10.24
Factor	CE_ENV216-L1 (Filter ON)	Temp. / Humidity	24°C / 55%
Polarity	Line1	Site / Engineer	SR2 / Kevin
Test Mode	MODE1	Test Voltage	AC120V/60Hz(By NB)

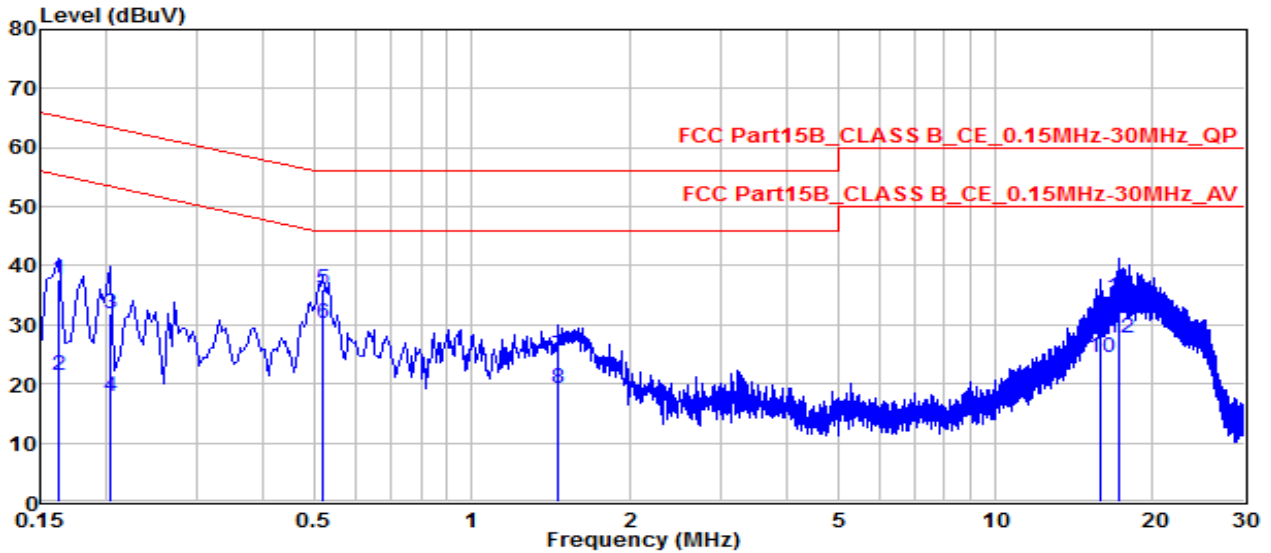

No	Frequency (MHz)	Reading (dBuV)	C.F (dB)	Measurement (dBuV)	Margin (dB)	Limit (dBuV)	Remark (QP/PK/AV)
1	0.1635	27.64	10.08	37.72	-27.56	65.28	QP
2	0.1635	11.34	10.08	21.42	-33.86	55.28	Average
3	0.20399	21.88	9.94	31.82	-31.63	63.45	QP
4	0.20399	8.03	9.94	17.97	-35.48	53.45	Average
5	* 0.51896	25.94	10.08	36.02	-19.98	56	QP
6	* 0.51896	20.26	10.08	30.34	-15.66	46	Average
7	1.459	14.74	9.88	24.62	-31.38	56	QP
8	1.459	9.34	9.88	19.22	-26.78	46	Average
9	15.871	20.23	9.98	30.21	-29.79	60	QP
10	15.871	14.39	9.98	24.37	-25.63	50	Average
11	17.271	24.79	9.98	34.77	-25.23	60	QP
12	17.271	17.81	9.98	27.79	-22.21	50	Average

Note :

1. "\*" means the worst value in this measurement data .
2. C.F ( Correction Factor ) = Factor (dB)+ Cable Loss (dB) .
3. Measurement (dBuV) = Reading(dBuV)+ C.F ( Correction Factor ) .
4. Other mode was also verified. The test results shown represent the worst case emissions .

EUT	14249-RF2-B	Test Date	2016.10.24
Factor	CE_ENV216-N (Filter ON)	Temp. / Humidity	24°C / 55%
Polarity	Neutral	Site / Engineer	SR2 / Kevin
Test Mode	MODE1	Test Voltage	AC120V/60Hz(By NB)

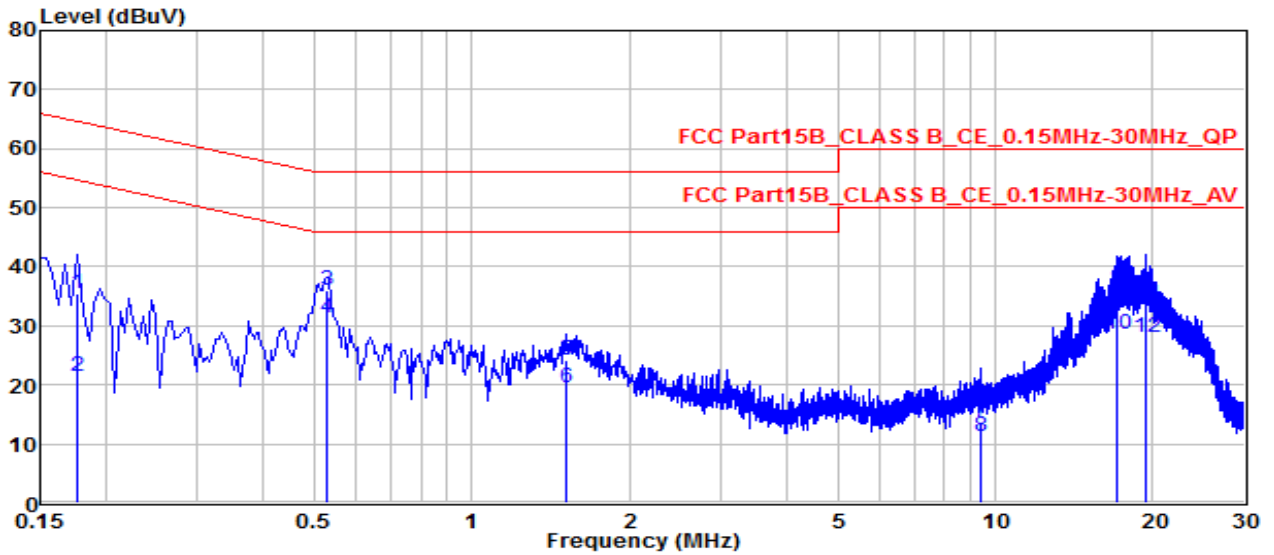

No	Frequency (MHz)	Reading (dBuV)	C.F (dB)	Measurement (dBuV)	Margin (dB)	Limit (dBuV)	Remark (QP/PK/AV)
1	0.177	25.29	10.11	35.4	-29.23	64.63	QP
2	0.177	11.29	10.11	21.4	-33.23	54.63	Average
3	* 0.52796	25.9	10.11	36.01	-19.99	56	QP
4	* 0.52796	21.1	10.11	31.21	-14.79	46	Average
5	1.518	14.3	9.87	24.17	-31.83	56	QP
6	1.518	9.52	9.87	19.39	-26.61	46	Average
7	9.41	3.92	9.85	13.77	-46.23	60	QP
8	9.41	1.38	9.85	11.23	-38.77	50	Average
9	17.14	26.27	10.03	36.3	-23.7	60	QP
10	17.14	18.63	10.03	28.66	-21.34	50	Average
11	19.44	23.38	10.07	33.45	-26.55	60	QP
12	19.44	18.04	10.07	28.11	-21.89	50	Average

Note :

- "\*" means the worst value in this measurement data .
- C.F ( Correction Factor ) = Factor (dB)+ Cable Loss (dB) .
- Measurement (dBuV) = Reading(dBuV)+ C.F ( Correction Factor ) .
- Other channel was also verified. The test results shown represent the worst case emissions .



## 8. CONCLUSION

The data collected relate only the item(s) tested and show that the **Nautiz X9, FCC ID:**

**YY3-14249-RF2** is in compliance with Part 15E of the FCC Rules.

————— The End —————