

MEASUREMENT REPORT

FCC PART 15.247 WLAN 802.11b/g/n

FCC ID: YY3-14249-RF2
APPLICANT: HANDHELD GROUP AB
Application Type: Certification
Product: Nautiz X9
Model No.: 14249-RF2-B
Trade Mark: **handheld**
FCC Classification: (DTS) Digital Transmission System
FCC Rule Part(s): Part 15.247
Test Procedure(s): ANSI C63.10-2013, KDB 558074 D01v04
Test Date: October 9, 2016 ~ January 25, 2018

Tested By : *Kevin Ker*
(Kevin Ker)
Reviewed By : *Paddy Chen*
(Paddy Chen)
Approved By : *Chenz Ker*
(Chenz Ker)



The test results relate only to the samples tested.

This equipment has been shown to be capable of compliance with the applicable technical standards as indicated in the measurement report and was tested in accordance with the measurement procedures specified in KDB 558074 D01v04. Test results reported herein relate only to the item(s) tested.

The test report shall not be reproduced except in full without the written approval of MRT Technology (Taiwan) Co., Ltd.

Revision History

Report No.	Version	Description	Issue Date	Note
1801TW1902-U4	1.0	Original Report	2018-02-06	

CONTENTS

Description	Page
§2.1033 General Information	5
1. INTRODUCTION	6
1.1. Scope.....	6
1.2. MRT Test Location.....	6
2. PRODUCT INFORMATION	7
2.1. Equipment Description	7
2.2. Working Frequencies for this Report	8
2.3. Test Mode	8
2.4. Test Software	8
2.5. Test Configuration.....	9
2.6. EMI Suppression Device(s)/Modifications	9
2.7. Labeling Requirements	9
3. DESCRIPTION of TEST	10
3.1. Evaluation Procedure	10
3.2. AC Line Conducted Emissions	10
3.3. Radiated Emissions	11
4. ANTENNA REQUIREMENTS.....	12
5. TEST EQUIPMENT CALIBRATION DATE.....	13
6. MEASUREMENT UNCERTAINTY.....	14
7. TEST RESULT	15
7.1. Summary.....	15
7.2. 6dB Bandwidth Measurement	16
7.2.1. Test Limit	16
7.2.2. Test Procedure used	16
7.2.3. Test Setting	16
7.2.4. Test Setup	16
7.2.5. Test Result	17
7.3. Output Power Measurement.....	20
7.3.1. Test Limit	20
7.3.2. Test Procedure Used.....	20
7.3.3. Test Setting	20
7.3.4. Test Setup	20
7.3.5. Test Result of Output Power	21
7.4. Power Spectral Density Measurement.....	22
7.4.1. Test Limit	22
7.4.2. Test Procedure Used.....	22
7.4.3. Test Setting	22
7.4.1. Test Setup	22
7.4.2. Test Result	23
7.5. Out-of-Band Spurious Emissions Emissions Measurement	26

7.5.1.	Test Limit	26
7.5.2.	Test Procedure Used.....	26
7.5.3.	Test Settintg	26
7.5.4.	Test Setup	27
7.5.5.	Test Result	28
7.6.	Radiated Spurious Emission Measurement.....	33
7.6.1.	Test Limit.....	33
7.6.2.	Test Procedure Used.....	33
7.6.3.	Test Setting	33
7.6.4.	Test Setup	35
7.6.5.	Test Result	37
7.7.	Radiated Restricted Band Edge Measurement.....	63
7.7.1.	Test Limit.....	63
7.7.2.	Test Procedure Used.....	63
7.7.3.	Test Setting	63
7.7.4.	Test Setup	65
7.7.5.	Test Result	66
7.8.	AC Conducted Emissions Measurement.....	88
7.8.1.	Test Limit.....	88
7.8.2.	Test Setup	88
7.8.3.	Test Result	89
8.	CONCLUSION	91

§2.1033 General Information

Applicant	HANDHELD GROUP AB
Applicant Address	Kinnegatan 17 A ,531 33 Lidköping, Sweden
Manufacturer	HANDHELD GROUP AB
Manufacturer Address	Kinnegatan 17 A ,531 33 Lidköping, Sweden
Test Site	MRT Technology (Taiwan) Co., Ltd
Test Site Address	No. 38, Fuxing Second Rd., Guishan Dist., Taoyuan City 333, Taiwan (R.O.C)
MRT FCC Registration No.	291082
FCC Rule Part(s):	Part 15.247
Test Device Serial No.:	N/A <input type="checkbox"/> Production <input checked="" type="checkbox"/> Pre-Production <input type="checkbox"/> Engineering

Test Facility / Accreditations

1. MRT facility is a FCC registered (Reg. No. 291082) test facility with the site description report on file and is designated by the FCC as an Accredited Test Film.
2. MRT facility is an IC registered (MRT Reg. No. 21723-1) test laboratory with the site description on file at Industry Canada.
3. MRT Lab is accredited to ISO 17025 by the Taiwan Accreditation Foundation (TAF Cert. No. 3261) in EMC, Telecommunications and Radio testing for FCC, Industry Taiwan, EU and TELEC Rules.

1. INTRODUCTION

1.1. Scope

Measurement and determination of electromagnetic emissions (EMC) of radio frequency devices including intentional and/or unintentional radiators for compliance with the technical rules and regulations of the Federal Communications Commission and the Industry Canada Certification and Engineering Bureau.

1.2. MRT Test Location

The map below shows the location of the MRT LABORATORY, its proximity to the Taoyuan City. These measurement tests were conducted at the MRT Technology (Taiwan) Co., Ltd. Facility located at No.38, Fuxing 2nd Rd., Guishan Dist., Taoyuan City 33377, Taiwan (R.O.C).

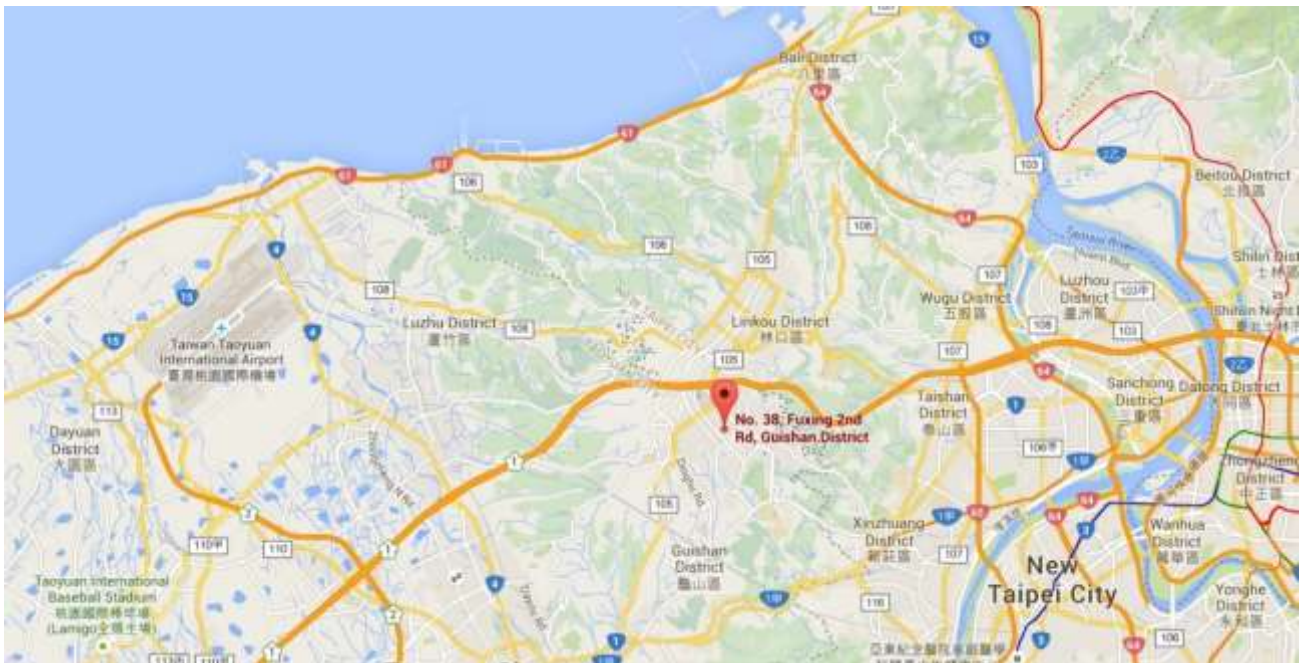

2. PRODUCT INFORMATION

2.1. Equipment Description

Product Name	Nautiz X9
Model No.	14249-RF2-B
Trade Mark	handheld
Supports Radios Spec.	WWAN : GSM/GPRS/EGPRS/WCDMA/HSPA/CDMA/EVDO/LTE WLAN : 2.4G : 802.11b/g/n-20/n-40; 5G : 802.11a/n-20/n-40 WPAN : Bluetooth/NFC
Wi-Fi Specification	802.11a/b/g/n
Frequency Range	<u>2.4GHz:</u> For 802.11b/g/n-20M: 2412 ~ 2462 MHz For 802.11n-40M: 2422 ~ 2452 MHz <u>5GHz:</u> For 802.11a/n-20M: 5180~5240MHz, 5745~5825MHz For 802.11n-40M: 5190~5230MHz, 5755~5795MHz
2.4GHz Maximum Output Power	802.11b: 16.68dBm 802.11g: 20.10dBm 802.11n-20M: 20.91dBm 802.11n-40M: 20.82dBm
Type of Modulation	802.11b: DSSS, DBPSK, DQPSK, CCK 802.11g/n-20M/n-40M: OFDM, BPSK, QPSK, 16QAM, 64QAM

2.2. Working Frequencies for this Report

802.11b/g/n-20M

Channel	Frequency	Channel	Frequency	Channel	Frequency
01	2412 MHz	02	2417 MHz	03	2422 MHz
04	2427 MHz	05	2432 MHz	06	2437 MHz
07	2442 MHz	08	2447 MHz	09	2452 MHz
10	2457 MHz	11	2462 MHz	--	--

802.11n-40M

Channel	Frequency	Channel	Frequency	Channel	Frequency
03	2422 MHz	04	2427 MHz	05	2432 MHz
06	2437 MHz	07	2442 MHz	08	2447 MHz
09	2452 MHz	--	--	--	--

2.3. Test Mode

Test Mode	Mode 1: Transmit by 802.11b
	Mode 2: Transmit by 802.11g
	Mode 3: Transmit by 802.11n-20M
	Mode 4: Transmit by 802.11n-40M

2.4. Test Software

The test utility software used during testing was “MTK Engineer Mode”.

2.5. Test Configuration

The **Nautiz X9, FCC ID: YY3-14249-RF2** was tested per the guidance of KDB 558074 D01v04. ANSI C63.10-2013 was used to reference the appropriate EUT setup for radiated spurious emissions testing and AC line conducted testing.

2.6. EMI Suppression Device(s)/Modifications

No EMI suppression device(s) were added and/or no modifications were made during testing.

2.7. Labeling Requirements

Per 2.1074 & 15.19; Docket 95-19

The label shall be permanently affixed at a conspicuous location on the device; instruction manual or pamphlet supplied to the user and be readily visible to the purchaser at the time of purchase. However, when the device is so small wherein placement of the label with specified statement is not practical, only the FCC ID must be displayed on the device per Section 15.19(a)(5). Please see attachment for FCC ID label and label location.

3. DESCRIPTION of TEST

3.1. Evaluation Procedure

The measurement procedures described in the American National Standard for Testing Unlicensed Wireless Devices (ANSI C63.10-2013), and the guidance provided in KDB 558074 D01v04 were used in the measurement of the **Nautiz X9, FCC ID: YY3-14249-RF2**.

Deviation from measurement procedure.....None

3.2. AC Line Conducted Emissions

The line-conducted facility is located inside an 9'x4'x3' shielded enclosure. A 1m x 2m wooden table 80cm high is placed 40cm away from the vertical wall and 80cm away from the sidewall of the shielded room. Two 10kHz-30MHz, 50Ω/50uH Line-Impedance Stabilization Networks (LISNs) are bonded to the shielded room floor. Power to the LISNs is filtered by external high-current high-insertion loss power line filters. These filters attenuate ambient signal noise from entering the measurement lines. These filters are also bonded to the shielded enclosure.

The EUT is powered from one LISN and the support equipment is powered from the second LISN. All interconnecting cables more than 1 meter were shortened to a 1 meter length by non-inductive bundling (serpentine fashion) and draped over the back edge of the test table. All cables were at least 40cm above the horizontal reference ground-plane. Power cables for support equipment were routed down to the second LISN while ensuring that that cables were not draped over the second LISN.

Sufficient time for the EUT, support equipment, and test equipment was allowed in order for them to warm up to their normal operating condition. The RF output of the LISN was connected to the receiver and exploratory measurements were made to determine the frequencies producing the maximum emission from the EUT. The receiver was scanned from 150kHz to 30MHz. The detector function was set to peak mode for exploratory measurements while the bandwidth of the analyzer was set to 9kHz. The EUT, support equipment, and interconnecting cables were arranged and manipulated to maximize each emission. Each emission was also maximized by varying: power lines, the mode of operation or data exchange speed, or support equipment which determined the worst-case emission. Once the worst case emissions have been identified, the one EUT cable configuration/arrangement and mode of operation that produced these emissions are used for final measurements on the same test site. The analyzer is set to CISPR quasi-peak and average detectors with a 9kHz resolution bandwidth for final measurements.

An extension cord was used to connect to a single LISN which powered by EUT. The extension cord was calibrated with LISN, the impedance and insertion loss are compliance with the requirements as stated in ANSI C63.10-2013.

Line conducted emissions test results are shown in Section 7.8.

3.3. Radiated Emissions

The radiated test facilities consisted of an indoor 3 meter semi-anechoic chamber used for final measurements and exploratory measurements, when necessary. The measurement area is contained within the semi-anechoic chamber which is shielded from any ambient interference. For measurements above 1GHz absorbers are arranged on the floor between the turn table and the antenna mast in such a way so as to maximize the reduction of reflections. For measurements below 1GHz, the absorbers are removed. A MF Model 210SS turntable is used for radiated measurement. It is a continuously rotatable, remote controlled, metallic turntable and 2 meters (6.56 ft.) in diameter. The turn table is flush with the raised floor of the chamber in order to maintain its function as a ground plane. An 80cm high PVC support structure is placed on top of the turntable.

For all measurements, the spectrum was scanned through all EUT azimuths and from 1 to 4 meter receive antenna height using a broadband antenna from 30MHz up to the upper frequency shown in 15.33(b)(1) depending on the highest frequency generated or used in the device or on which the device operates or tunes. For frequencies above 1GHz, linearly polarized double ridge horn antennas were used. For frequencies below 30MHz, a calibrated loop antenna was used. When exploratory measurements were necessary, they were performed at 1 meter test distance inside the semi-anechoic chamber using broadband antennas, broadband amplifiers, and spectrum analyzers to determine the frequencies and modes producing the maximum emissions. Sufficient time for the EUT, support equipment, and test equipment was allowed in order for them to warm up to their normal operating condition. The test set-up for frequencies below 1GHz was placed on top of the 0.8 meter high, 1 x 1.5 meter table; and test set-up for frequencies 1-40GHz was placed on top of the 1.5 meter high, 1 x 1.5 meter table. The EUT, support equipment, and interconnecting cables were arranged and manipulated to maximize each emission. Appropriate precaution was taken to ensure that all emissions from the EUT were maximized and investigated. The system configuration, clock speed, mode of operation or video resolution, if applicable, turntable azimuth, and receive antenna height was noted for each frequency found.

Final measurements were made in the semi-anechoic chamber using calibrated, linearly polarized broadband and horn antennas. The test setup was configured to the setup that produced the worst case emissions. The spectrum analyzer was set to investigate all frequencies required for testing to compare the highest radiated disturbances with respect to the specified limits. The turntable containing the EUT was rotated through 360 degrees and the height of the receive antenna was varied 1 to 4 meters and stopped at the azimuth and height producing the maximum emission. Each emission was maximized by changing the orientation of the EUT through three orthogonal planes and changing the polarity of the receive antenna, which produced the worst-case emissions. According to 3dB Beam-Width of horn antenna, the horn antenna should be always directed to the EUT when rising height.

Radiated emissions test results are shown in Section 7.6 & 7.7 .

4. ANTENNA REQUIREMENTS

Excerpt from §15.203 of the FCC Rules/Regulations:

“An intentional radiator antenna shall be designed to ensure that no antenna other than that furnished by the responsible party can be used with the device. The use of a permanently attached antenna or of an antenna that uses a unique coupling to the intentional radiator shall be considered sufficient to comply with the provisions of this section.”

- The antenna of the **Nautiz X9**, is permanently attached.
- There are no provisions for connection to an external antenna.

Conclusion:

The **Nautiz X9, FCC ID: YY3-14249-RF2** unit complies with the requirement of §15.203.

Antenna List

No.	Manufacturer	Part No.	Antenna Type	Peak Gain
1	N/A	AP316-DB_V1	FPC	0.73dBi for 2.4GHz

5. TEST EQUIPMENT CALIBRATION DATE

Conducted Emissions – SR2

Instrument	Manufacturer	Type No.	Asset No.	Cali. Interval	Cali. Due Date
Two-Line V-Network	R&S	ENV216	MRTTWA00019	1 year	2018.03.15
Cable	Rosnol	N1C50-RG400-B 1C50-500CM	MRTTWE00013	1 year	2018.05.19
EMI Test Receiver	R&S	ESR3	MRTTWA00009	1 year	2018.03.16

Radiated Emissions – AC1

Instrument	Manufacturer	Type No.	Asset No.	Cali. Interval	Cali. Due Date
Broadband TRILOG Antenna	SCHWARZBECK	VULB 9162	MRTTWA00001	1 year	2018.05.14
EMI Test Receiver	R&S	ESR3	MRTTWA00009	1 year	2018.03.16
Active Loop Antenna	Schwarzbeck	FMZB 1519B	MRTTWA00002	1 year	2018.04.13
Broadband Horn antenna	SCHWARZBECK	BBHA 9120D	MRTTWA00003	1 year	2018.04.17
Breitband Hornantenna	Schwarzbeck	BBHA 9170	MRTTWA00004	1 year	2018.04.24
Broadband Amplifier	Schwarzbeck	BBV 9721	MRTTWA00006	1 year	2018.04.24
Broadband Preampfier	SCHWARZBECK	BBV 9718	MRTTWA00005	1 year	2018.04.19
Cable	HUBERSUHNER	SF106	MRTTWA00010	1 year	2018.05.19
Cable	Rosnol	K1K50-UP0264- K1K50-4M	MRTTWA00012	1 year	2018.05.19

Conducted Test Equipment – SR2

Instrument	Manufacturer	Type No.	Asset No.	Cali. Interval	Cali. Due Date
Spectrum Analyzer	KEYSIGHT	N9010A	MRTTWA00012	1 year	2018.07.24
USB Wideband Power Sensor	KEYSIGHT	U2021XA	MRTTWA00015	1 year	2018.03.19

Test Software

Software	Version	Function
e3	9.160520a	EMI Test Software
EMI	V3	EMI Test Software

6. MEASUREMENT UNCERTAINTY

Where relevant, the following test uncertainty levels have been estimated for tests performed on the EUT as specified in CISPR 16-4-2. This uncertainty represents an expanded uncertainty expressed at approximately the 95% confidence level using a coverage factor of $k = 2$.

AC Conducted Emission Measurement – SR2	
Measuring Uncertainty for a Level of Confidence of 95% ($U=2Uc(y)$):	
150kHz~30MHz:	2.42dB
Conducted Measurement– SR1	
Measuring Uncertainty for a Level of Confidence of 95% ($U=2Uc(y)$): 1.3dB	
Radiated Emission Measurement – AC1	
Measuring Uncertainty for a Level of Confidence of 95% ($U=2Uc(y)$):	
Horizontal:	9K~30MHz: 4.14dB
	30MHz~1GHz: 4.22dB
	1GHz~40GHz: 4.05dB
Vertical:	9K~30MHz: 4.14dB
	30MHz~1GHz: 3.37dB
	1GHz~40GHz: 4.08dB

7. TEST RESULT

7.1. Summary

Product Name: Nautiz X9
FCC Classification: (DTS) Digital Transmission System
Data Rate(s) Tested: 1Mbps ~ 11Mbps (b); 6Mbps ~ 54Mbps (g);
6.5/7.2Mbps ~ 65/72.2Mbps (n-20M);
13.5/15.0Mbps ~ 135/150Mbps (n-40M)

FCC Part Section(s)	Test Description	Test Limit	Test Condition	Test Result	Reference
15.247(a)(2)	6dB Bandwidth	$\geq 500\text{kHz}$	Conducted	Pass	Section 7.2
15.247(b)(3)	Output Power	$\leq 30.00\text{dBm}$		Pass	Section 7.3
15.247(e)	Power Spectral Density	$\leq 8.00\text{dBm}/3\text{kHz}$		Pass	Section 7.4
15.247(d)	Out-of-Band Emissions	Conducted $\geq 20\text{dBc}$		Pass	Section 7.5
15.205 15.209	Spurious Emission	< FCC 15.209 limits	Radiated	Pass	Section 7.6
15.205 15.209	Band Edge Measurement	$\leq 74\text{dBuV/m(Peak)}$ $\leq 54\text{dBuV/m(Average)}$		Pass	Section 7.7
15.207	AC Conducted Emissions 150kHz - 30MHz	< FCC 15.207 limits	Line Conducted	Pass	Section 7.8

Notes:

- 1) All modes of operation and data rates were investigated. For radiated emission test, every axis (X, Y, Z) was also verified. The test results shown in the following sections represent the worst case emissions.
- 2) The analyzer plots shown in this section were all taken with a correction table loaded into the analyzer. The correction table was used to account for the losses of the cables and attenuators used as part of the system to connect the EUT to the analyzer at all frequencies of interest.
- 3) All antenna port conducted emissions testing was performed on a test bench with the antenna port of the EUT connected to the spectrum analyzer through calibrated cables and attenuators.

7.2. 6dB Bandwidth Measurement

7.2.1. Test Limit

The minimum 6dB bandwidth shall be at least 500 kHz.

7.2.2. Test Procedure used

KDB 558074 D01v04- Section 8.2 Option 2

7.2.3. Test Setting

1. The Spectrum's automatic bandwidth measurement capability was used to perform the 6dB bandwidth measurement. The "X" dB bandwidth parameter was set to $X = 6$. The bandwidth measurement was not influenced by any intermediate power nulls in the fundamental emission.
2. Set RBW = 100 kHz
3. VBW $\geq 3 \times$ RBW
4. Detector = Peak
5. Trace mode = max hold
6. Sweep = auto couple
7. Allow the trace was allowed to stabilize

7.2.4. Test Setup

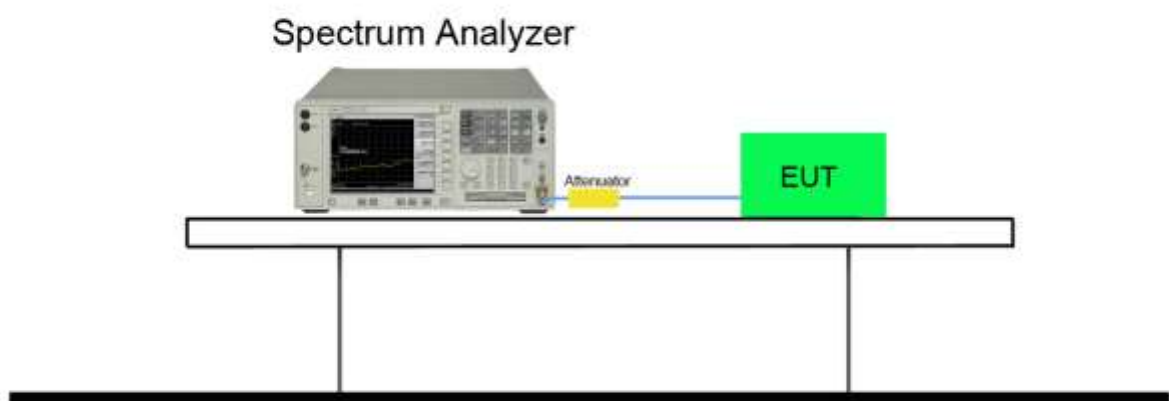

7.2.5. Test Result

Test Mode	Channel No.	Frequency (MHz)	6dB Bandwidth (MHz)	99% Bandwidth (MHz)	Limit (MHz)	Result
802.11b	01	2412	9.556	12.661	≥ 0.5	Pass
802.11b	06	2437	9.527	12.449	≥ 0.5	Pass
802.11b	11	2462	8.486	11.711	≥ 0.5	Pass
802.11g	01	2412	16.58	16.543	≥ 0.5	Pass
802.11g	06	2437	16.53	16.479	≥ 0.5	Pass
802.11g	11	2462	16.46	16.370	≥ 0.5	Pass
802.11n-20M	01	2412	17.83	17.719	≥ 0.5	Pass
802.11n-20M	06	2437	17.75	17.658	≥ 0.5	Pass
802.11n-20M	11	2462	17.27	17.525	≥ 0.5	Pass
802.11n-40M	03	2422	35.48	35.831	≥ 0.5	Pass
802.11n-40M	06	2437	35.72	35.835	≥ 0.5	Pass
802.11n-40M	09	2452	35.43	35.879	≥ 0.5	Pass

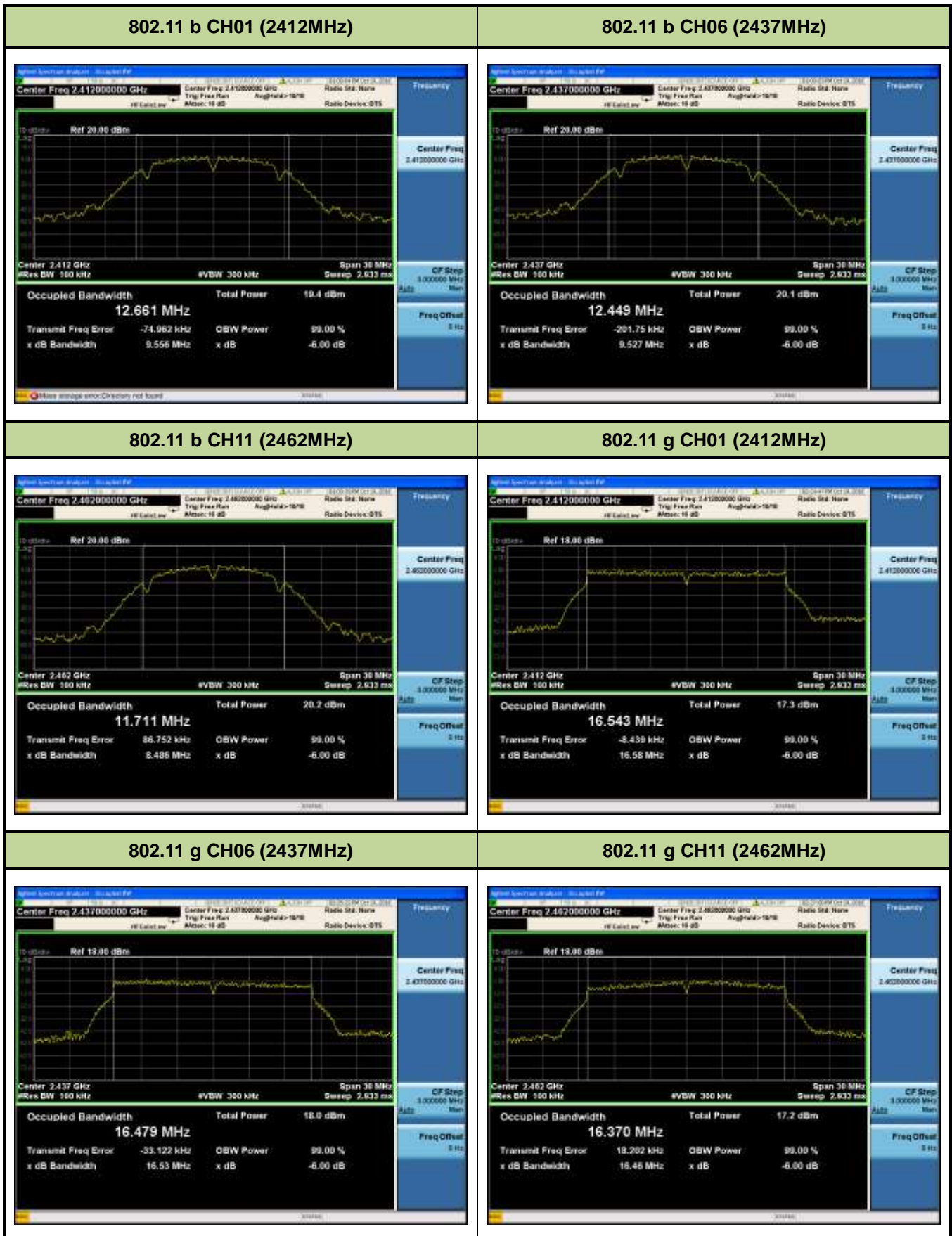

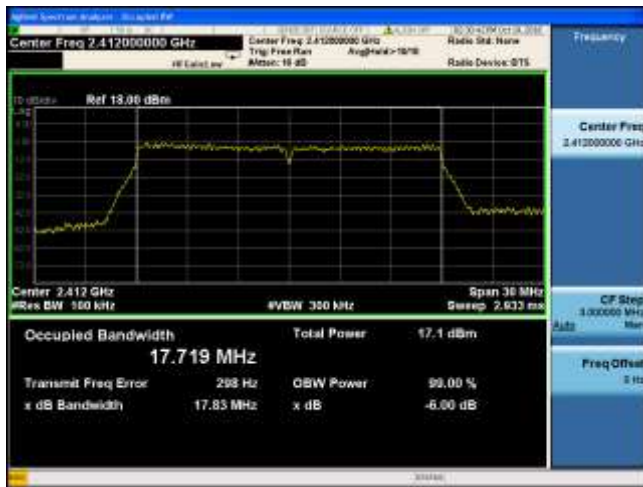
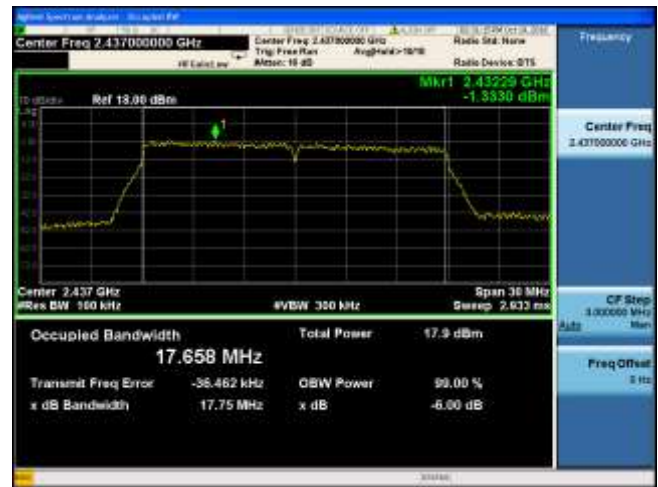
802.11 n-20M CH01 (2412MHz)

802.11 n-20M CH06 (2437MHz)

802.11 n-20M CH11 (2462MHz)

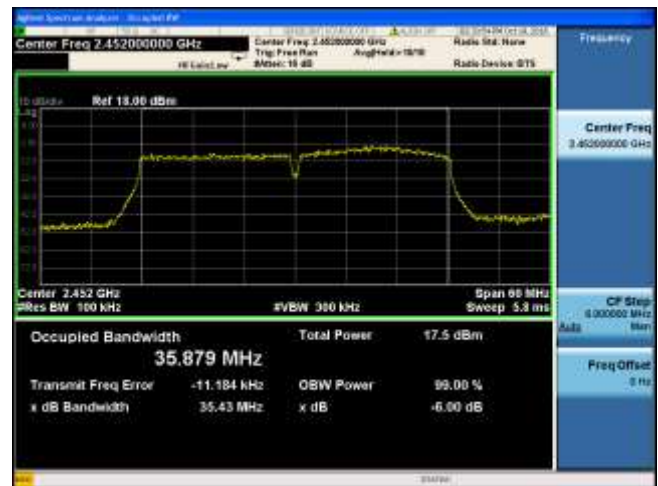
802.11 n-40M CH03 (2422MHz)

802.11 n-40M CH 06 (2437MHz)

802.11 n-40M CH 09 (2452MHz)

7.3. Output Power Measurement

7.3.1. Test Limit

The maximum out power shall be less 1 Watt (30dBm).

7.3.2. Test Procedure Used

KDB 558074 D01v04 - Section 9.1.2 & 9.2.3.2

7.3.3. Test Setting

Peak Power Measurement

The maximum peak conducted output power may be measured using a broadband peak RF power meter. The power meter shall have a video bandwidth that is greater than or equal to the DTS bandwidth and shall utilize a fast-responding diode detector.

Average Power Measurement

Average power measurements were performed only when the EUT was transmitting at its maximum power control level using a broadband power meter with a pulse sensor. The power meter implemented triggering and gating capabilities which were set up such that power measurements were recorded only during the ON time of the transmitter. The trace was averaged over 100 traces to obtain the final measured average power.

7.3.4. Test Setup

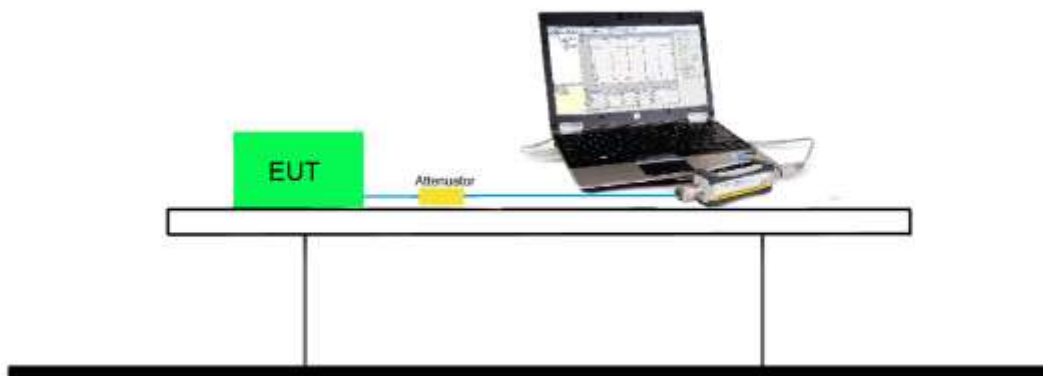

7.3.5. Test Result of Output Power

2.4GHz 802.11b RF Output Power (dBm)											
Channel No.	Frequency (MHz)	Average Power For different Data Rate (Mbps)				Peak Power	Required Limit				
		1	2	5.5	11						
01	2412	12.71		--	--	15.85	1Watt= 30 dBm				
06	2437	13.65	13.57	13.62	13.55	16.68	1Watt= 30 dBm				
11	2462	12.36	--	--	--	15.45	1Watt= 30 dBm				
2.4GHz 802.11g RF Output Power (dBm)											
Channel No.	Frequency (MHz)	Average Power For different Data Rate (Mbps)								Peak Power	Required Limit
		6	9	12	18	24	36	48	54		
01	2412	--	--	--	--	--	--	--	9.32	19.4	1Watt= 30 dBm
06	2437	9.86	8.3	10.4	10.42	8.3	8.15	10.38	10.54	20.1	1Watt= 30 dBm
11	2462	--	--	--	--	--	--	--	9	19.82	1Watt= 30 dBm
2.4GHz 802.11n-20M RF Output Power (dBm)											
Channel No.	Frequency (MHz)	Average Power For different Data Rate (Mbps)								Peak Power	Required Limit
		MCS0	MCS1	MCS2	MCS3	MCS4	MCS5	MCS6	MCS7		
01	2412								9.6	19.53	1Watt= 30 dBm
06	2437	10.31	10.25	10.15	10.11	10.07	10.44	10.65	10.73	20.91	1Watt= 30 dBm
11	2462								9.52	19.34	1Watt= 30 dBm
2.4GHz 802.11n-40M RF Output Power (dBm)											
Channel No.	Frequency (MHz)	Average Power For different Data Rate (Mbps)								Peak Power	Required Limit
		MCS0	MCS1	MCS2	MCS3	MCS4	MCS5	MCS6	MCS7		
03	2422		--	--	--	--	--	--	10.36	20.14	1Watt= 30 dBm
06	2437	10.18	10.51	10.14	10.22	10.25	10.4	10.43	10.65	20.82	1Watt= 30 dBm
09	2452		--	--	--	--	--	--	9.85	20.65	1Watt= 30 dBm

Note: Output power = Reading value on power meter + cable loss

o

7.4. Power Spectral Density Measurement

7.4.1. Test Limit

The maximum permissible power spectral density is 8dBm in any 3 kHz band.

7.4.2. Test Procedure Used

KDB 558074 D01v04 - Section 10.2 Method PKPSD

7.4.3. Test Setting

This procedure shall be used if maximum peak conducted output power was used to demonstrate compliance, and is optional if the maximum conducted (average) output power was used to demonstrate compliance.

- a) Set analyzer center frequency to DTS channel center frequency.
- b) Set the span to 1.5 times the DTS bandwidth.
- c) Set the RBW to: 3 kHz.
- d) Set the VBW $\geq 3 \times$ RBW.
- e) Detector = peak.
- f) Sweep time = auto couple.
- g) Trace mode = max hold.
- h) Allow trace to fully stabilize.
- i) Use the peak marker function to determine the maximum amplitude level within the RBW.

7.4.1. Test Setup

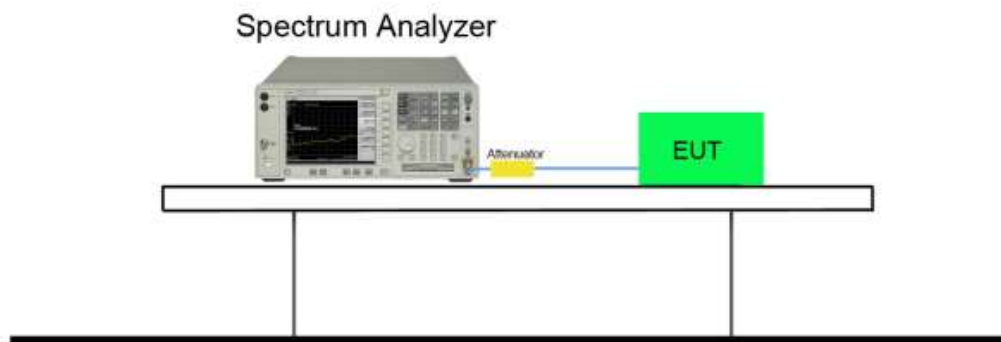

7.4.2. Test Result

Test Mode	Channel No.	Freq. (MHz)	PSD (dBm)	Limit (dBm)	Result
11b	1	2412	-16.320	≤ 8	Pass
11b	6	2437	-14.869	≤ 8	Pass
11b	11	2462	-13.238	≤ 8	Pass
11g	1	2412	-16.877	≤ 8	Pass
11g	6	2437	-17.158	≤ 8	Pass
11g	11	2462	-17.636	≤ 8	Pass
11n-20M	1	2412	-17.437	≤ 8	Pass
11n-20M	6	2437	-15.280	≤ 8	Pass
11n-20M	11	2462	-15.424	≤ 8	Pass
11n-40M	3	2422	-17.312	≤ 8	Pass
11n-40M	6	2437	-17.105	≤ 8	Pass
11n-40M	9	2452	-16.369	≤ 8	Pass

802.11 b CH01 (2412MHz)



802.11 b CH06 (2437MHz)



802.11 b CH11 (2462MHz)



802.11 g CH01 (2412MHz)

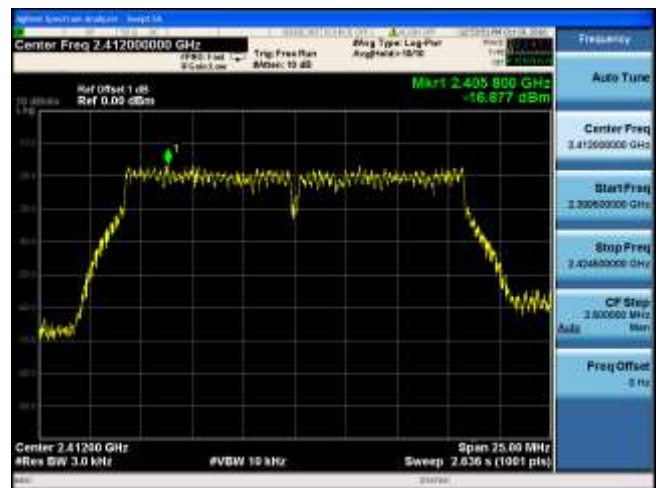

802.11 g CH06 (2437MHz)



802.11 g CH11 (2462MHz)



802.11 n-20M CH01 (2412MHz) **802.11 n-20M CH06 (2437MHz)**

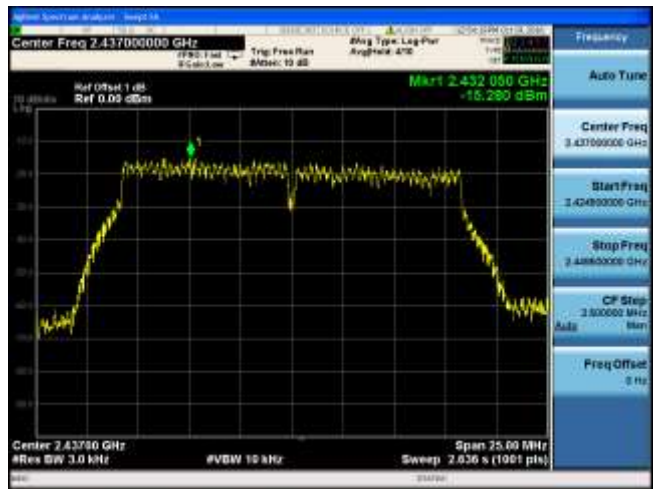
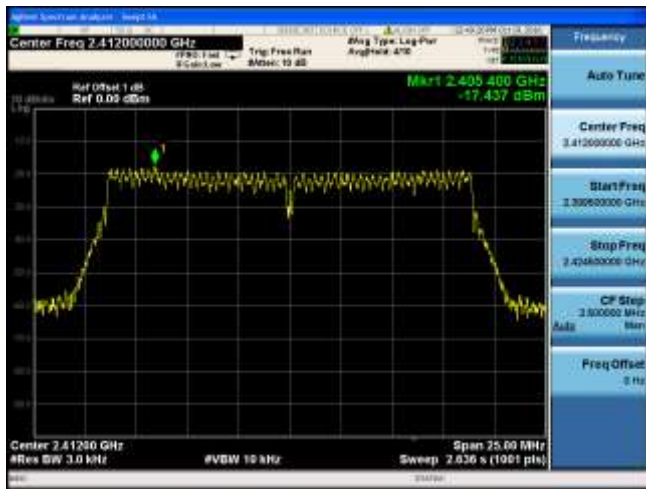

802.11 n-20M CH11 (2462MHz) **802.11 n-40M CH03 (2422MHz)**

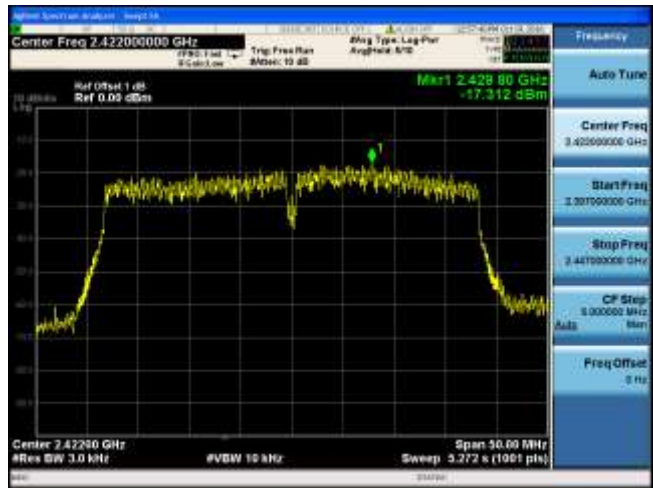
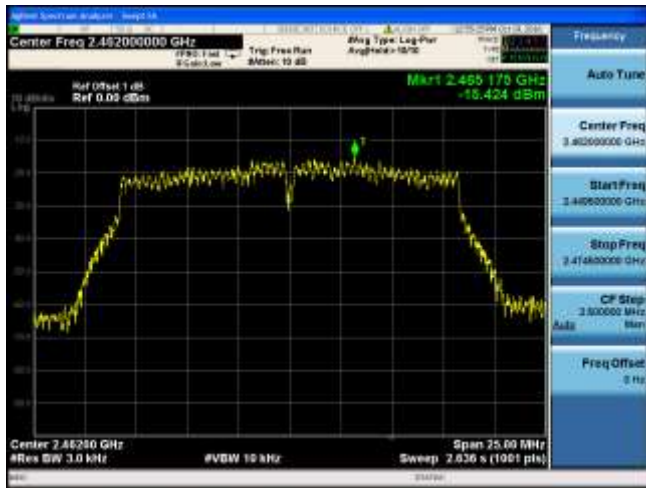

802.11 n-40M CH 06 (2437MHz) **802.11 n-40M CH 09 (2452MHz)**

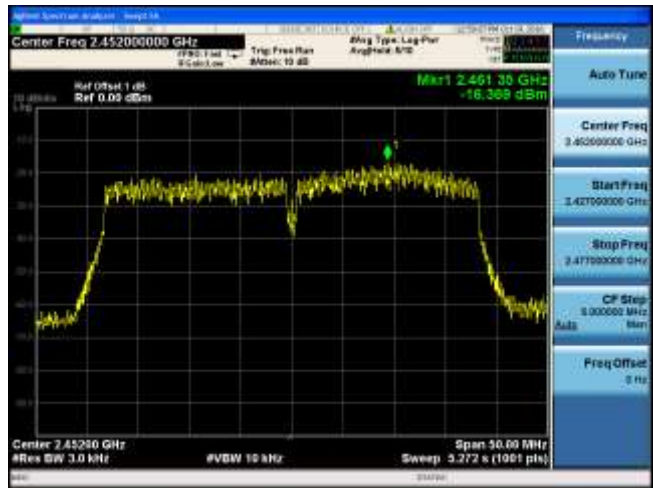
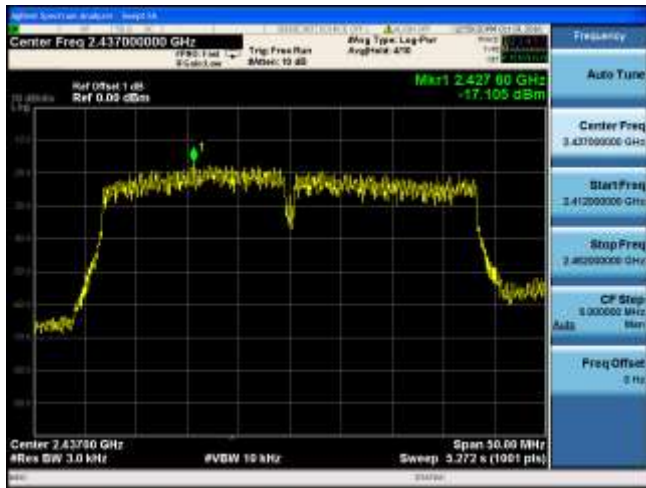

7.5. Out-of-Band Spurious Emissions Emissions Measurement

7.5.1. Test Limit

In any 100 kHz bandwidth outside the frequency band in which the spread spectrum or digitally modulated intentional radiator is operating, the radio frequency power that is produced by the intentional radiator shall be at least 20 dB below that in the 100 kHz bandwidth within the band that contains the highest level of the desired power, based on RF conducted measurement, provided the transmitter demonstrates compliance with the peak conducted power limits.

7.5.2. Test Procedure Used

KDB 558074 D01v04- Section 11.1 & 11.2

7.5.3. Test Setting

- (a) Set instrument center frequency to DTS channel center frequency
- (b) Set the span to ≥ 1.5 times the DTS bandwidth
- (c) Set the RBW = 100 kHz
- (d) Set the VBW $\geq 3 \times$ RBW
- (e) Detector = peak
- (f) Sweep time = auto couple
- (g) Trace mode = max hold
- (h) Allow trace to fully stabilize

7.5.4. Test Setup

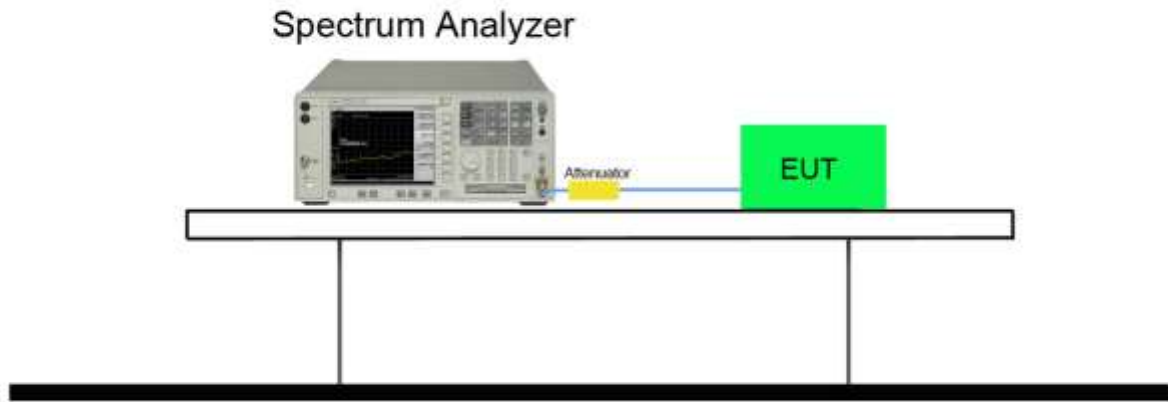

7.5.5. Test Result

Test Mode	Channel No.	Frequency (MHz)	Limit	Result
802.11b	01	2412	20dBc	Pass
802.11b	06	2437	20dBc	Pass
802.11b	11	2462	20dBc	Pass
802.11g	01	2412	20dBc	Pass
802.11g	06	2437	20dBc	Pass
802.11g	11	2462	20dBc	Pass
802.11n-20M	01	2412	20dBc	Pass
802.11n-20M	06	2437	20dBc	Pass
802.11n-20M	11	2462	20dBc	Pass
802.11n-40M	03	2422	20dBc	Pass
802.11n-40M	06	2437	20dBc	Pass
802.11n-40M	09	2452	20dBc	Pass

802.11 b CH01 (2412MHz)

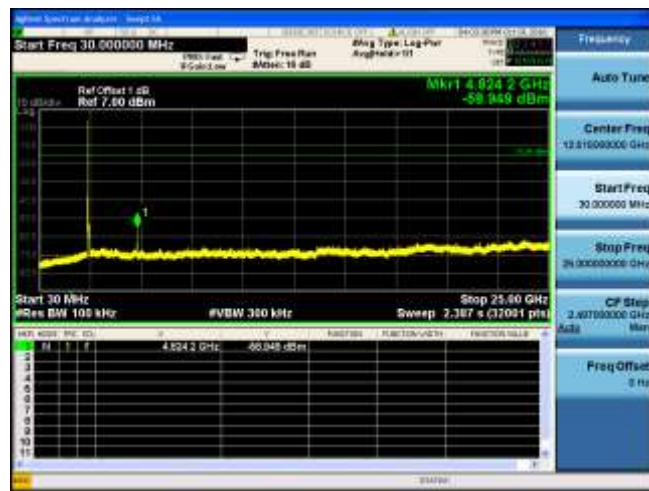

802.11 b CH01 (2412MHz)



802.11 b CH06 (2437MHz)

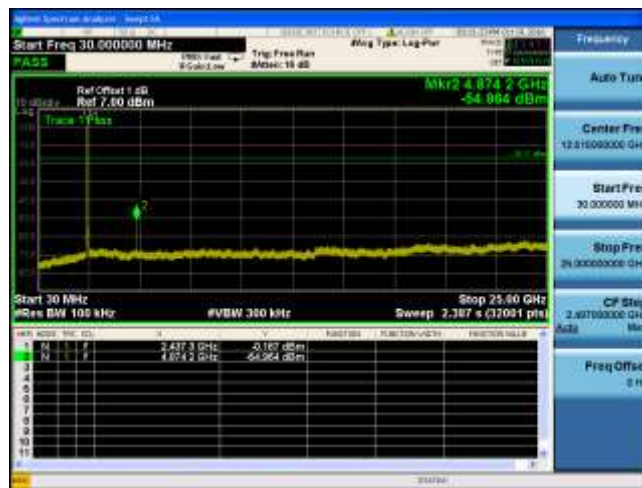

802.11 b CH11 (2462MHz)

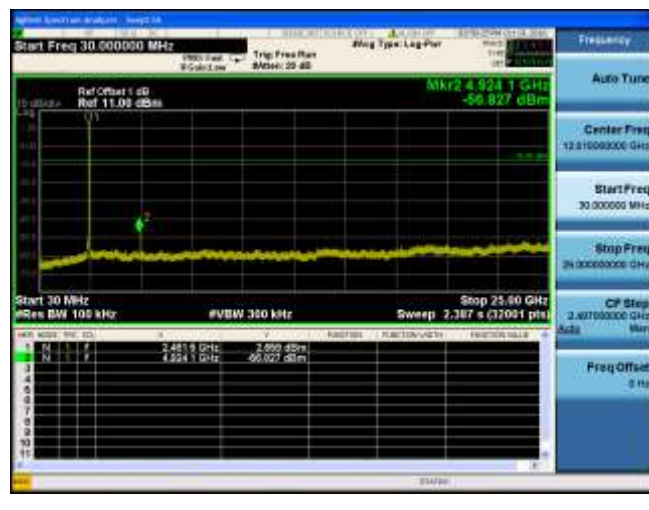

802.11 b CH11 (2462MHz)

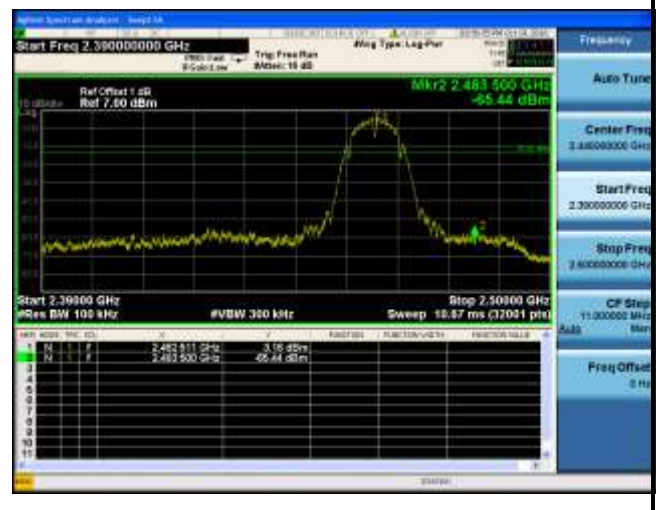

802.11 g CH01 (2412MHz)

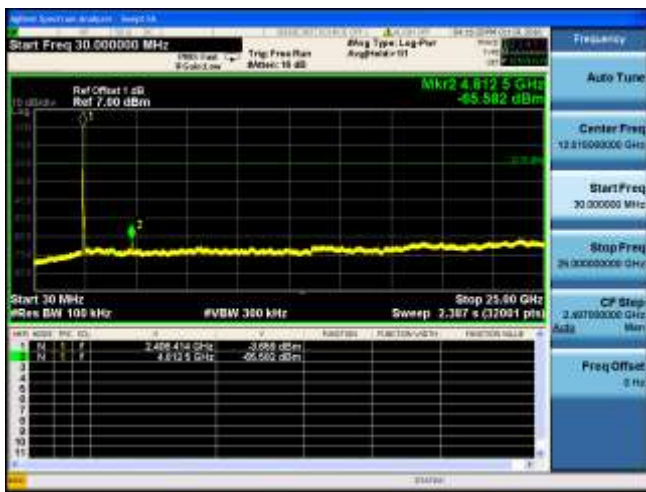

802.11 b CH01 (2412MHz)



802.11 g CH06 (2437MHz)

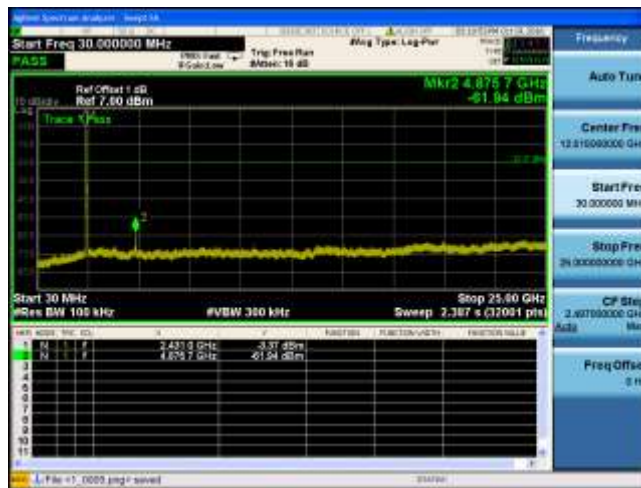

802.11 g CH11 (2462MHz)

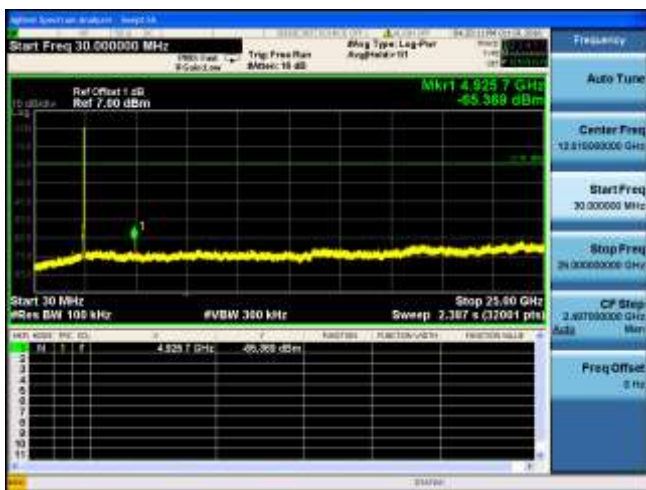

802.11 g CH11 (2462MHz)



802.11n-20M CH01 (2412MHz)

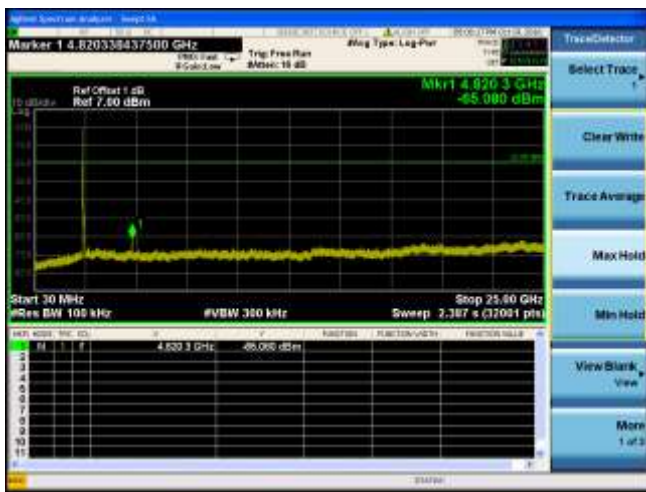

802.11n-20M CH01 (2412MHz)



802.11n-20M CH06 (2437MHz)

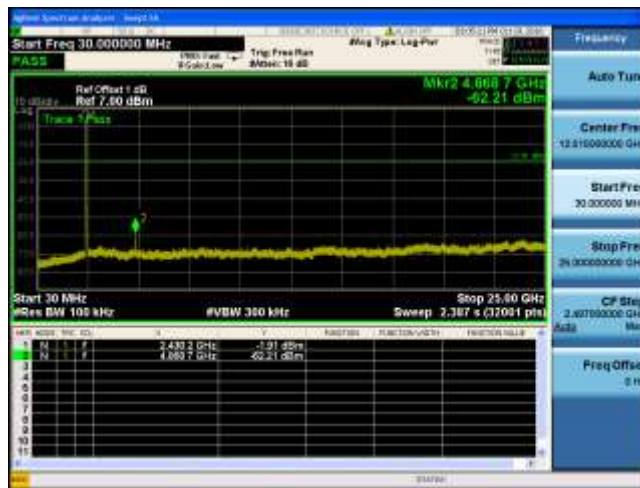

802.11n-20M CH11 (2462MHz)

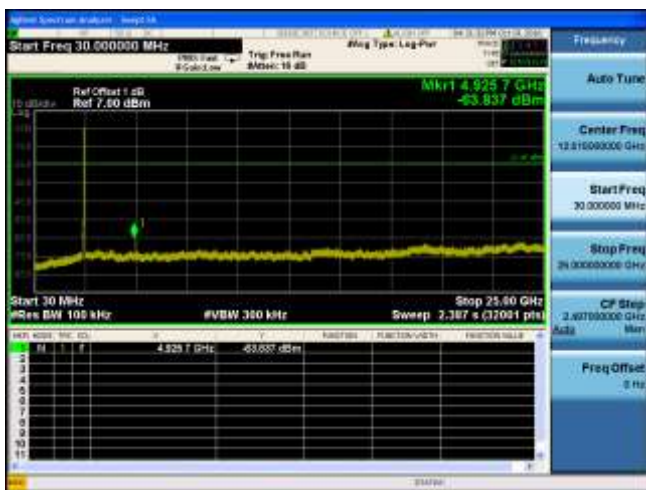

802.11n-20M CH11 (2462MHz)



802.11n-40M CH03 (2422MHz)

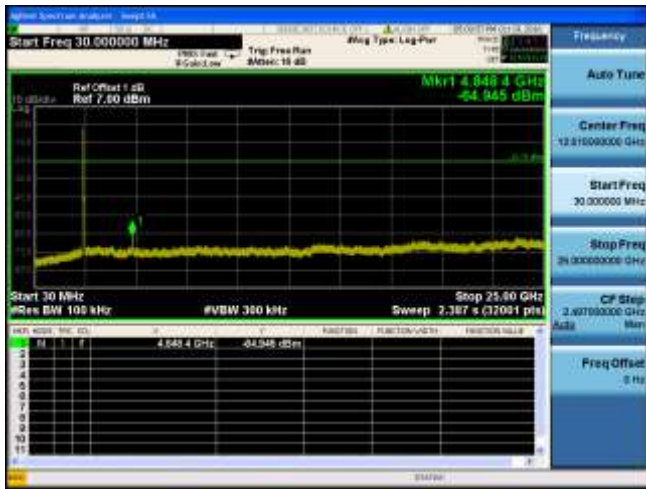

802.11n-40M CH03 (2422MHz)



802.11n-40M CH06 (2437MHz)

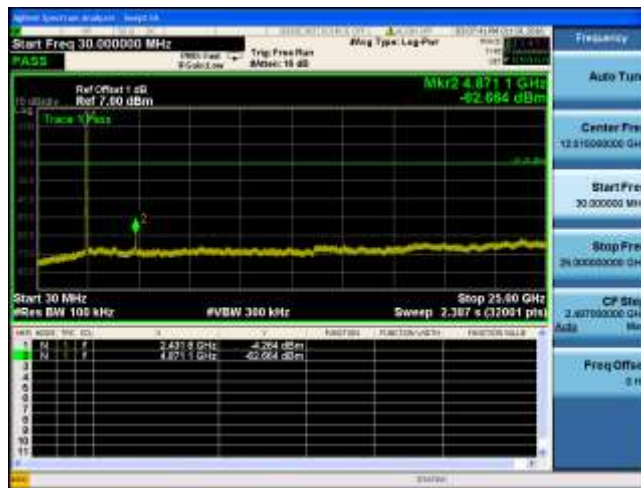

802.11n-40M CH09 (2452MHz)

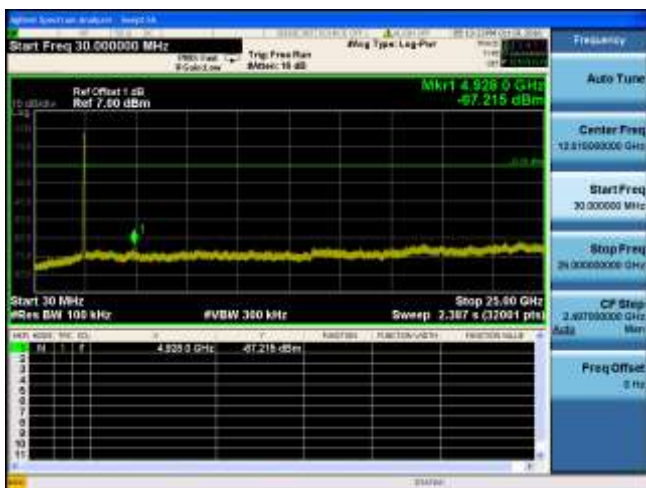

802.11n-40M CH09 (2452MHz)



7.6. Radiated Spurious Emission Measurement

7.6.1. Test Limit

All out of band emissions appearing in a restricted band as specified in Section 15.205 of the Title 47 CFR must not exceed the limits shown in Table per Section 15.209.

FCC Part 15 Subpart C Paragraph 15.209		
Frequency [MHz]	Field Strength [V/m]	Measured Distance [Meters]
0.009 - 0.490	2400/F (kHz)	300
0.490 - 1.705	24000/F (kHz)	30
1.705 - 30	30	30
30 - 88	100	3
88 - 216	150	3
216 - 960	200	3
Above 960	500	3

7.6.2. Test Procedure Used

KDB 558074 D01v04- Section 12.2.3 (quasi-peak measurements)

KDB 558074 D01v04- Section 12.2.4 (peak power measurements)

KDB 558074 D01v04- Section 12.2.5 (average power measurements)

7.6.3. Test Setting

Peak Field Strength Measurements

1. Analyzer center frequency was set to the frequency of the radiated spurious emission of interest
2. RBW = as specified in Table 1
3. VBW = 3MHz
4. Detector = peak
5. Sweep time = auto couple

6. Trace mode = max hold

7. Trace was allowed to stabilize

Table 1 - RBW as a function of frequency

Frequency	RBW
9 ~ 150 kHz	200 ~ 300 Hz
0.15 ~ 30 MHz	9 ~ 10 kHz
30 ~ 1000 MHz	100 ~ 120 kHz
> 1000 MHz	1 MHz

Average Field Strength Measurements

1. Analyzer center frequency was set to the frequency of the radiated spurious emission of interest

2. RBW = 1MHz

3. VBW \geq 1/T

4. De As an alternative, the instrument may be set to linear detector mode. Ensure that video filtering is applied in linear voltage domain (rather than in a log or dB domain). Some instruments require linear display mode in order to accomplish this. Others have a setting for Average-VBW Type, which can be set to "Voltage" regardless of the display mode

5. Detector = Peak

6. Sweep time = auto

7. Trace mode = max hold

8. Allow max hold to run for at least 50 times (1/duty cycle) traces

7.6.4. Test Setup

9kHz ~ 30MHz Test Setup:

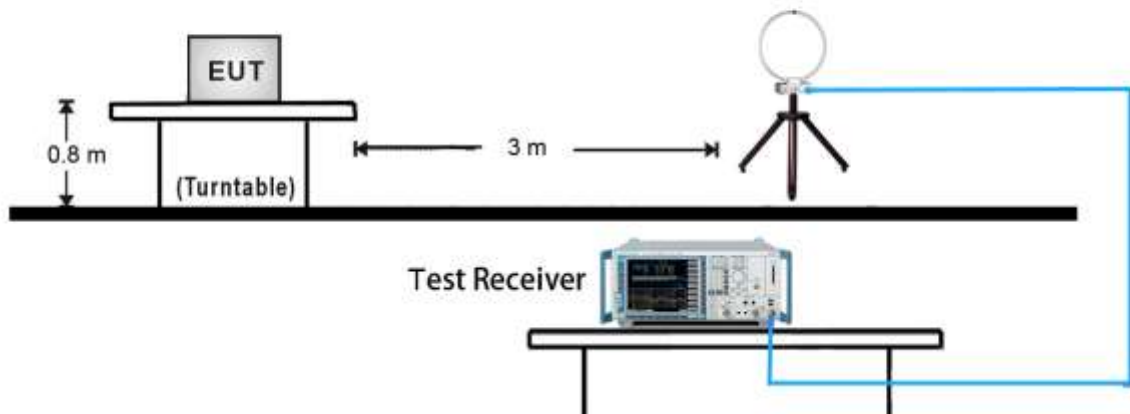

30MHz ~ 1GHz Test Setup:

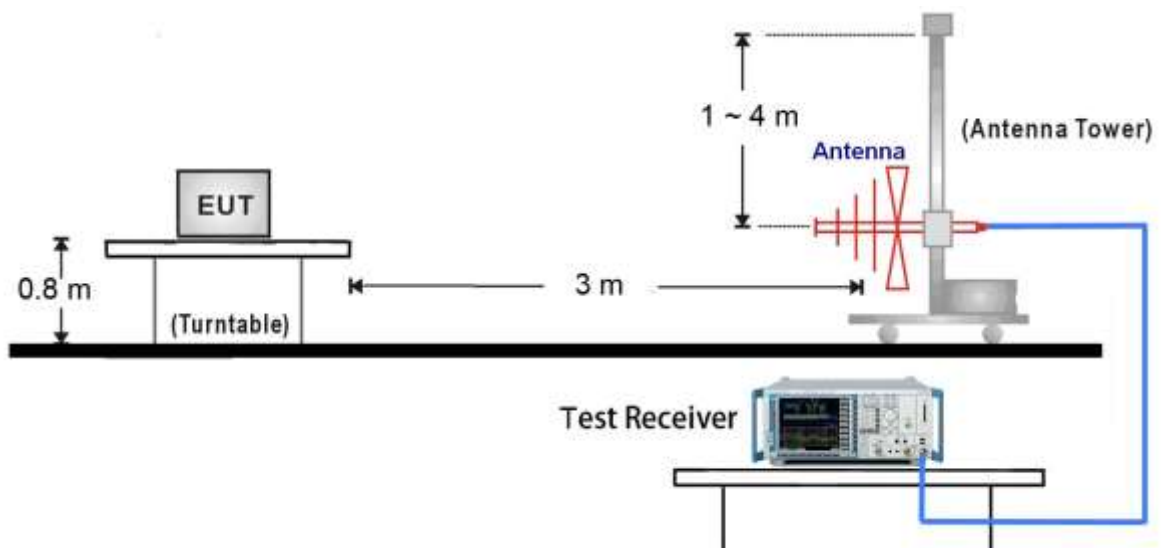

1GHz ~ 18GHz Test Setup:

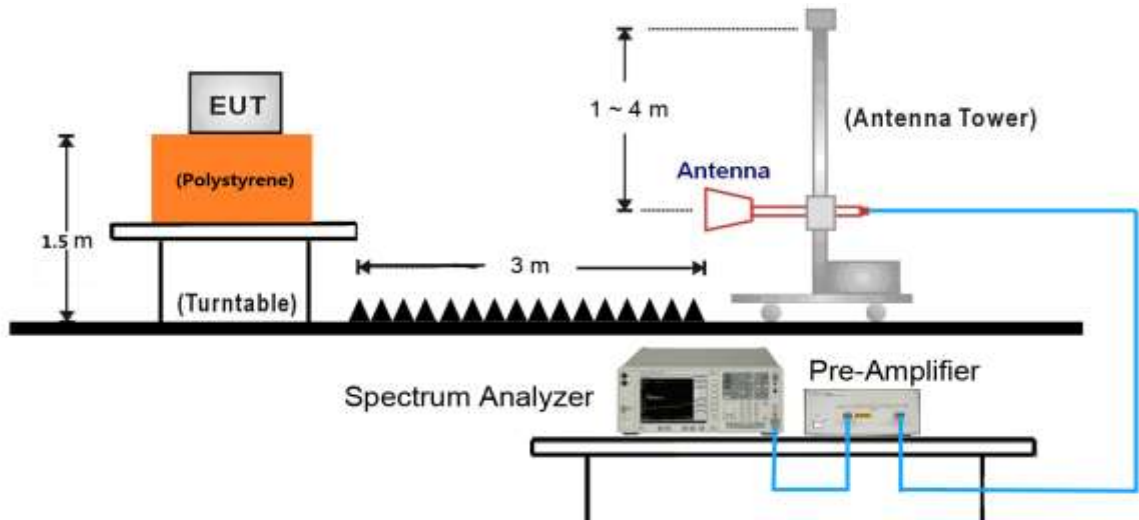

18GHz ~ 25GHz Test Setup:

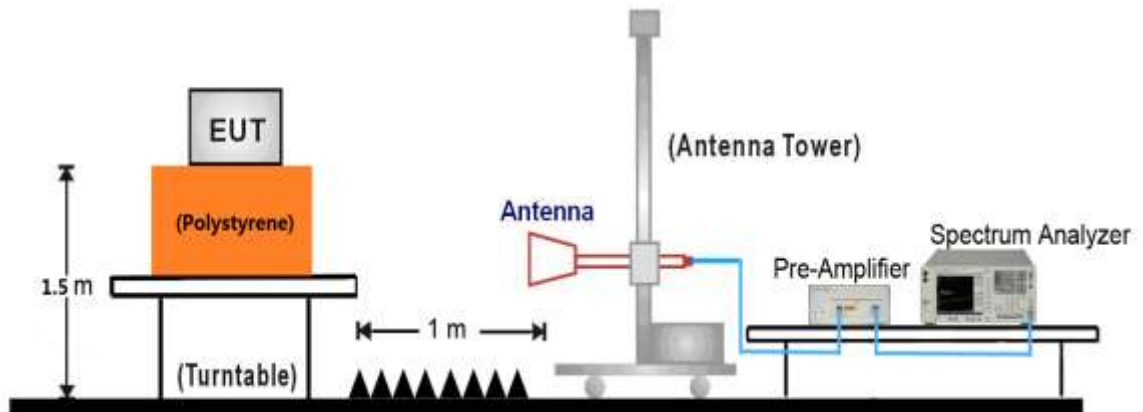

7.6.5. Test Result

EUT	14249-RF2-B	Test Date	2016.10.20
Factor	VULB 9162 (30MHz~8GHz)	Temp. / Humidity	25°C / 60%
Polarity	Horizontal	Site / Engineer	AC1 / Kevin
Test Mode	MODE1	Test Voltage	By Battery

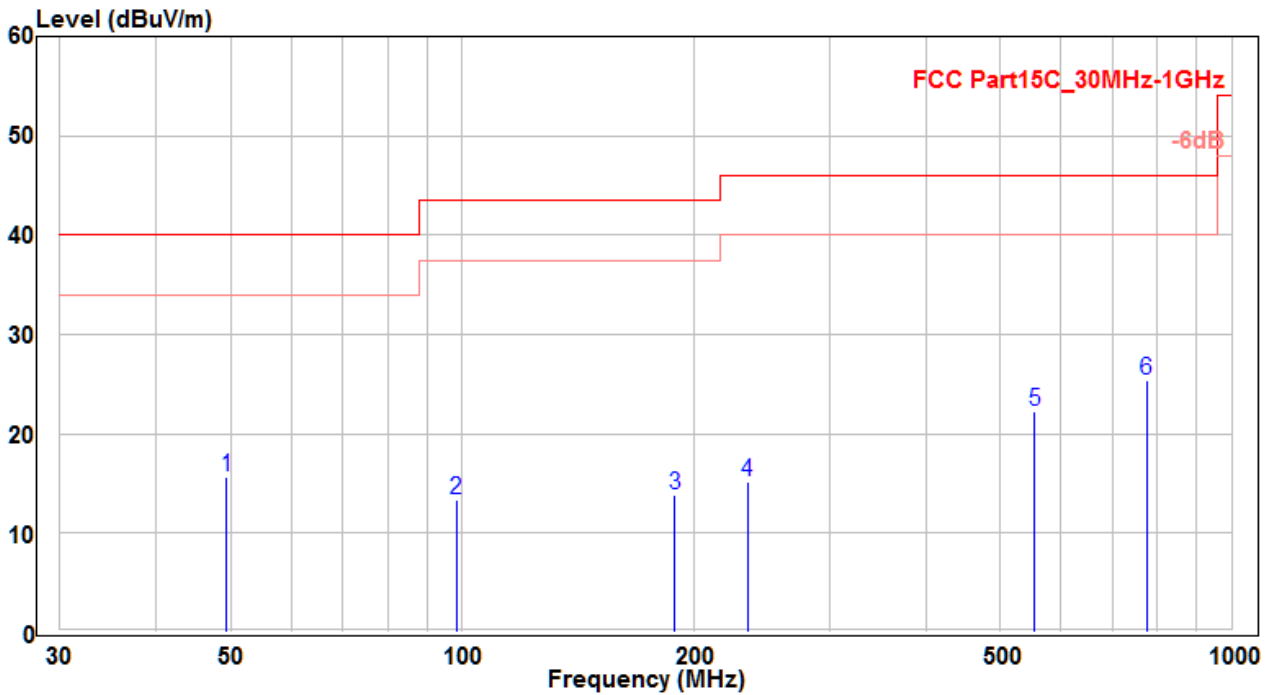

No	Frequency (MHz)	Reading (dBuV)	C.F (dB)	Measurement (dBuV/m)	Margin (dB)	Limit (dBuV)	Height (cm)	Angle (deg)	Remark (QP/PK/AV)
1	49.43	0.5	15.19	15.69	-24.31	40	200	370	QP
2	98.355	0.33	13.03	13.36	-30.14	43.5	100	-5	QP
3	189.019	1.98	11.85	13.83	-29.67	43.5	150	145	QP
4	234.7	1.71	13.39	15.1	-30.9	46	200	205	QP
5	554.588	2.8	19.49	22.29	-23.71	46	100	115	QP
6	* 775.263	2.56	22.84	25.4	-20.6	46	150	55	QP

Note :

1. " * " means the worst value in this measurement data ◦
2. Measure Level (dBuV/m) = Reading Level (dBuV) + Factor (dB) ◦
3. Factor (dB) = Cable Loss (dB) + Antenna Factor (dB/m) ◦
4. The emission levels of other frequencies are very lower than the limit and not show in test report ◦
5. Other channel/mode was also verified. The test results shown represent the worst case emissions ◦
6. No emission found between lowest internal used/generated frequency to 30MHz ◦

EUT	14249-RF2-B	Test Date	2016.10.11
Factor	VULB 9162 (30MHz~8GHz)	Temp. / Humidity	25°C / 60%
Polarity	Vertical	Site / Engineer	AC1 / Kevin
Test Mode	MODE1	Test Voltage	By Battery

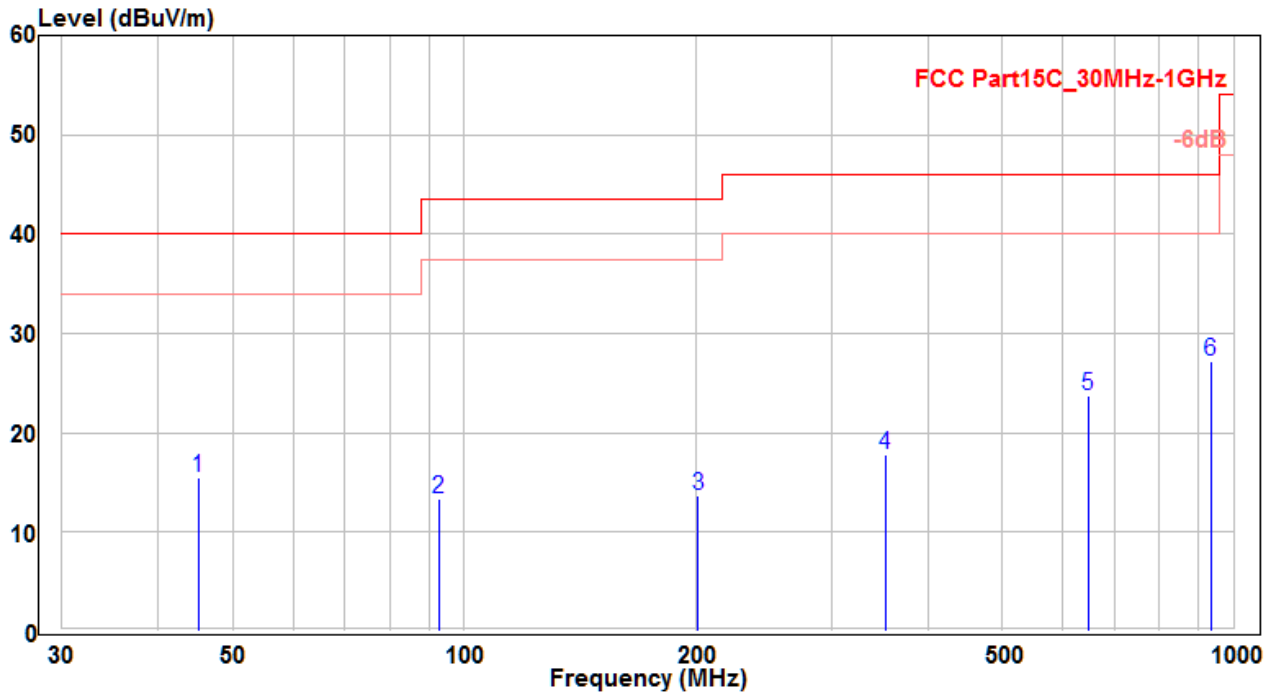

No	Frequency (MHz)	Reading (dBuV)	C.F (dB)	Measurement (dBuV/m)	Margin (dB)	Limit (dBuV)	Height (cm)	Angle (deg)	Remark (QP/PK/AV)
1	45.156	0.53	14.92	15.45	-24.55	40	150	325	QP
2	92.747	1.39	12.01	13.4	-30.1	43.5	100	-30	QP
3	201.266	1.32	12.44	13.76	-29.74	43.5	150	235	QP
4	352.798	1.73	16.09	17.82	-28.18	46	200	380	QP
5	646.193	2.85	20.89	23.74	-22.26	46	100	65	QP
6	* 933.373	2.61	24.66	27.27	-18.73	46	200	-15	QP

Note :

- "*" means the worst value in this measurement data °
- Measure Level (dBuV/m) = Reading Level (dBuV) + Factor (dB) °
- Factor (dB) = Cable Loss (dB) + Antenna Factor (dB/m) °
- The emission levels of other frequencies are very lower than the limit and not show in test report °
- Other channel/mode was also verified. The test results shown represent the worst case emissions °
- No emission found between lowest internal used/generated frequency to 30MHz °

EUT	14249-RF2-B	Test Date	2016.10.20
Factor	BBHA 9120D (1GHz~18GHz)	Temp. / Humidity	25°C / 60%
Polarity	Horizontal	Site / Engineer	AC1 / Kevin
Test Mode	MODE1-CH01	Test Voltage	By Battery

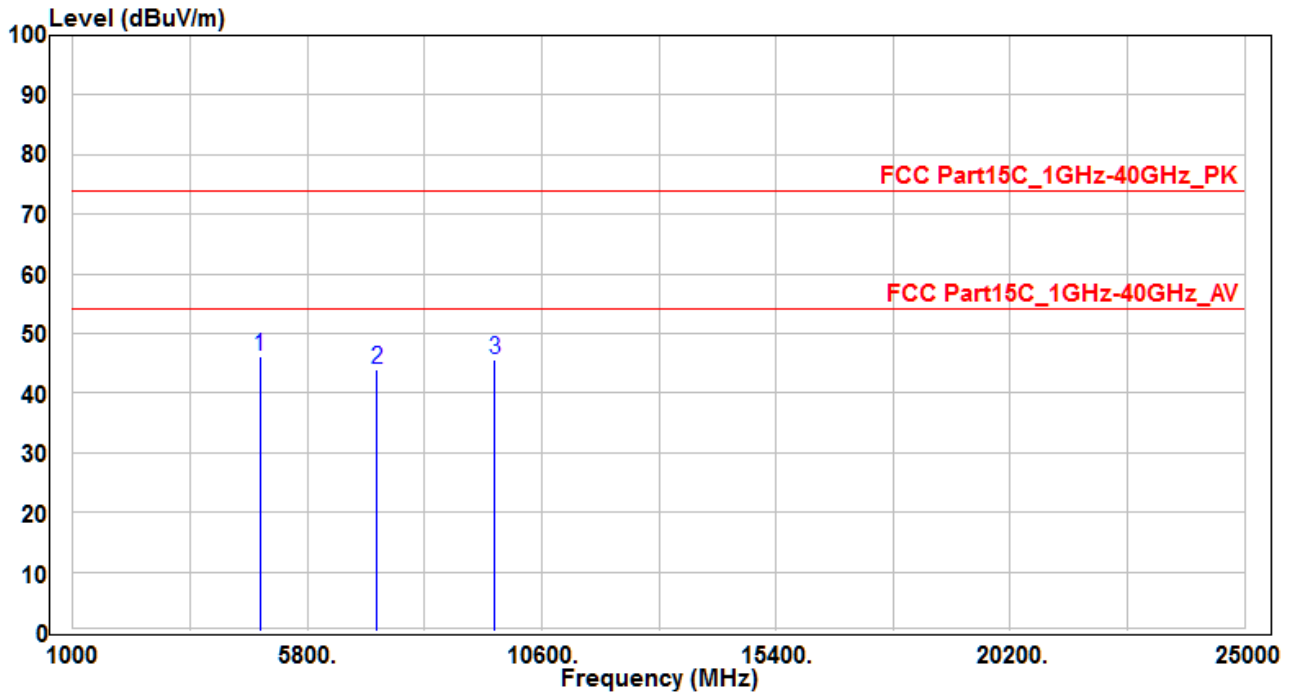

No		Frequency (MHz)	Reading (dBuV)	C.F (dB)	Measurement (dBuV/m)	Margin (dB)	Limit (dBuV)	Height (cm)	Angle (deg)	Remark (QP/PK/AV)
1	*	4824	42.47	3.67	46.14	-27.86	74	400	400	Peak
2		7236	31.87	12.19	44.06	-29.94	74	400	400	Peak
3		9648	29.98	15.67	45.65	-28.35	74	400	400	Peak

Note :

1. " * " means the worst value in this measurement data °
2. Measure Level (dBuV/m) = Reading Level (dBuV) + Factor (dB) °
3. Factor (dB) = Cable Loss (dB) + Antenna Factor (dB/m) °
4. The emission levels of other frequencies are very lower than the limit and not show in test report °

EUT	14249-RF2-B	Test Date	2016.10.20
Factor	BBHA 9120D (1GHz~18GHz)	Temp. / Humidity	25°C / 60%
Polarity	Vertical	Site / Engineer	AC1 / Kevin
Test Mode	MODE1-CH01	Test Voltage	By Battery

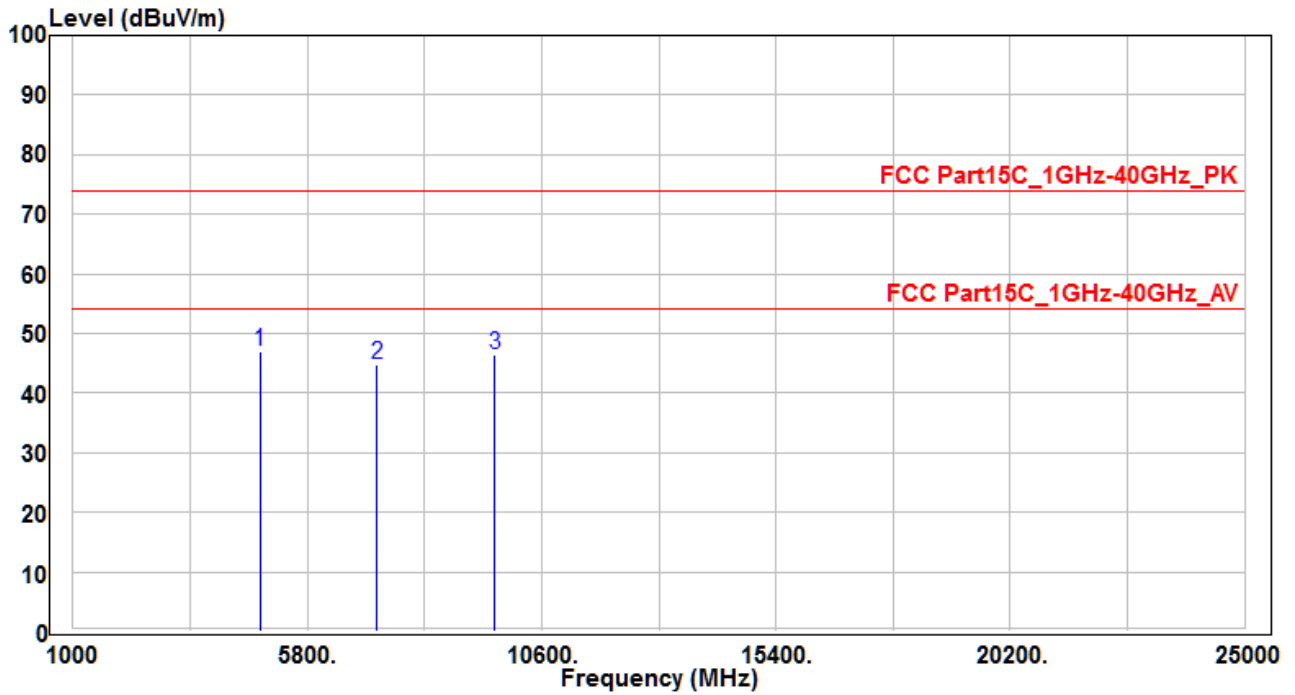

No		Frequency (MHz)	Reading (dBuV)	C.F (dB)	Measurement (dBuV/m)	Margin (dB)	Limit (dBuV)	Height (cm)	Angle (deg)	Remark (QP/PK/AV)
1	*	4824	43.33	3.67	47	-27	74	400	400	Peak
2		7236	32.64	12.19	44.83	-29.17	74	400	400	Peak
3		9648	30.75	15.67	46.42	-27.58	74	400	400	Peak

Note :

1. " * " means the worst value in this measurement data °
2. Measure Level (dBuV/m) = Reading Level (dBuV) + Factor (dB) °
3. Factor (dB) = Cable Loss (dB) + Antenna Factor (dB/m) °
4. The emission levels of other frequencies are very lower than the limit and not show in test report °

EUT	14249-RF2-B	Test Date	2016.10.20
Factor	BBHA 9120D (1GHz~18GHz)	Temp. / Humidity	25°C / 60%
Polarity	Horizontal	Site / Engineer	AC1 / Kevin
Test Mode	MODE1-CH06	Test Voltage	By Battery

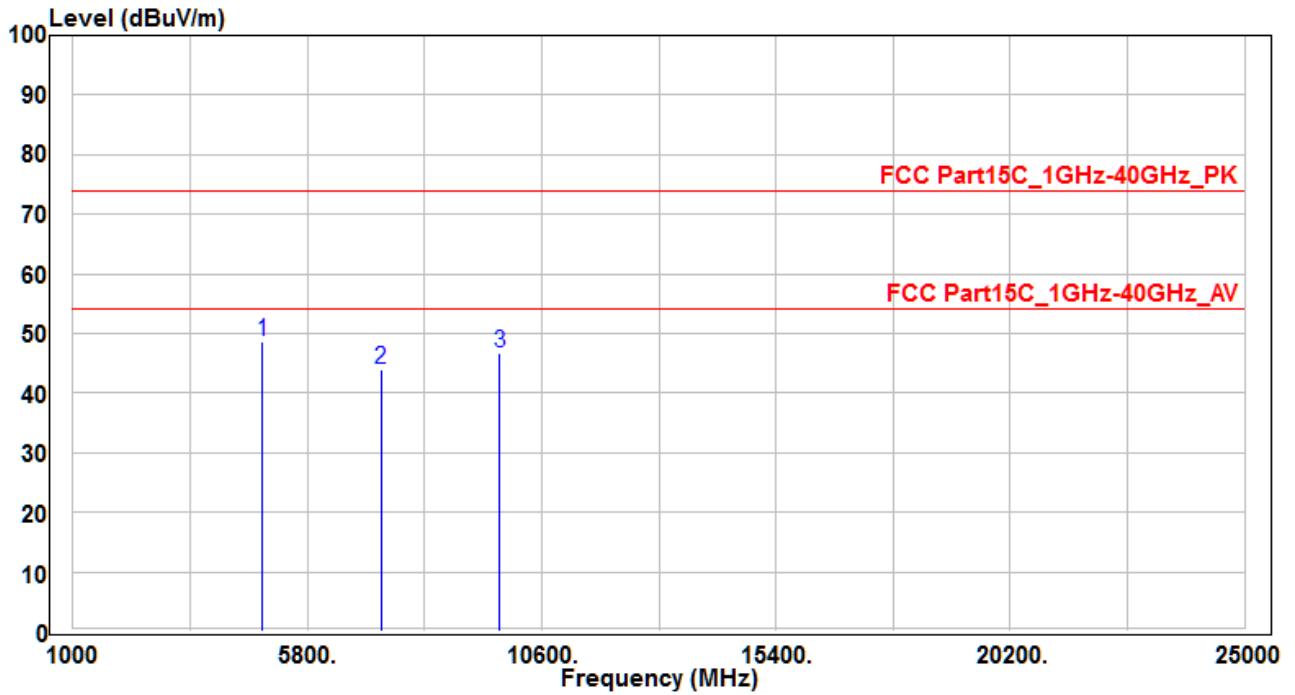

No		Frequency (MHz)	Reading (dBuV)	C.F (dB)	Measurement (dBuV/m)	Margin (dB)	Limit (dBuV)	Height (cm)	Angle (deg)	Remark (QP/PK/AV)
1	*	4874	44.95	3.65	48.6	-25.4	74	400	400	Peak
2		7311	31.66	12.34	44	-30	74	400	400	Peak
3		9748	30.6	16.02	46.62	-27.38	74	400	400	Peak

Note :

1. " * " means the worst value in this measurement data °
2. Measure Level (dBuV/m) = Reading Level (dBuV) + Factor (dB) °
3. Factor (dB) = Cable Loss (dB) + Antenna Factor (dB/m) °
4. The emission levels of other frequencies are very lower than the limit and not show in test report °

EUT	14249-RF2-B	Test Date	2016.10.20
Factor	BBHA 9120D (1GHz~18GHz)	Temp. / Humidity	25°C / 60%
Polarity	Vertical	Site / Engineer	AC1 / Kevin
Test Mode	MODE1-CH06	Test Voltage	By Battery

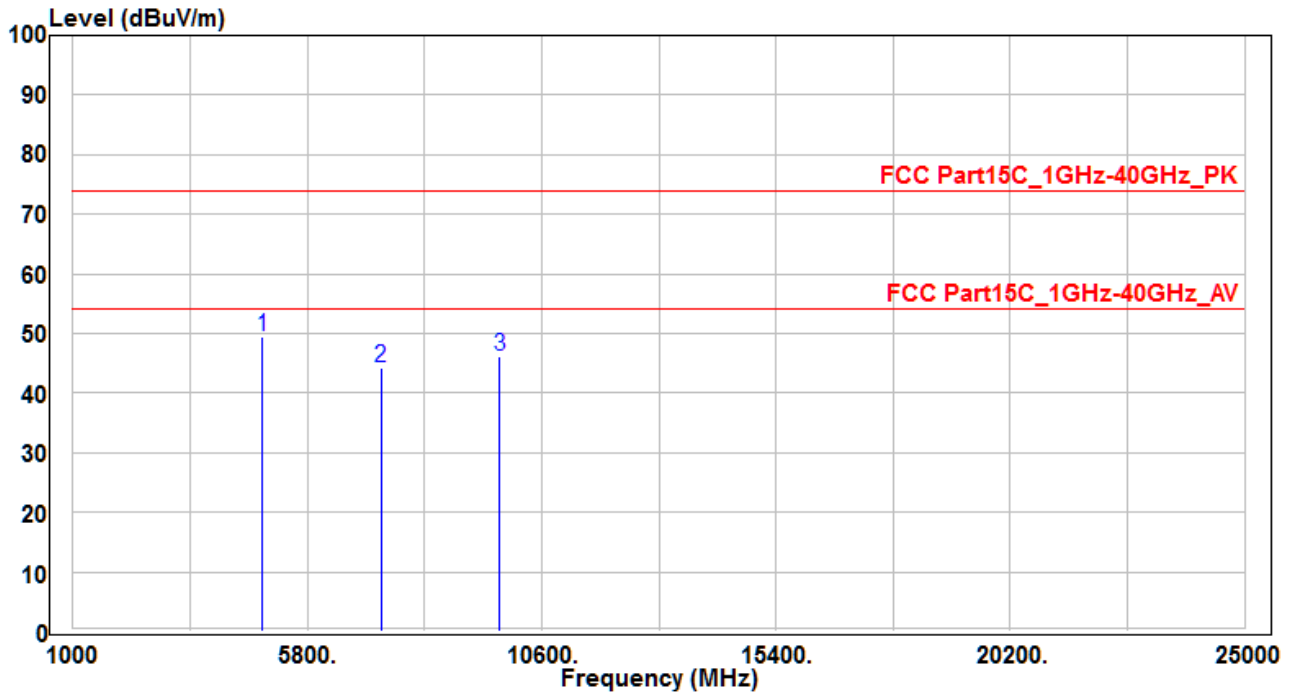

No		Frequency (MHz)	Reading (dBuV)	C.F (dB)	Measurement (dBuV/m)	Margin (dB)	Limit (dBuV)	Height (cm)	Angle (deg)	Remark (QP/PK/AV)
1	*	4874	45.9	3.65	49.55	-24.45	74	400	400	Peak
2		7311	31.98	12.34	44.32	-29.68	74	400	400	Peak
3		9748	30.14	16.02	46.16	-27.84	74	400	400	Peak

Note :

- "*" means the worst value in this measurement data °
- Measure Level (dBuV/m) = Reading Level (dBuV) + Factor (dB) °
- Factor (dB) = Cable Loss (dB) + Antenna Factor (dB/m) °
- The emission levels of other frequencies are very lower than the limit and not show in test report °

EUT	14249-RF2-B	Test Date	2016.10.20
Factor	BBHA 9120D (1GHz~18GHz)	Temp. / Humidity	25°C / 60%
Polarity	Horizontal	Site / Engineer	AC1 / Kevin
Test Mode	MODE1-CH11	Test Voltage	By Battery

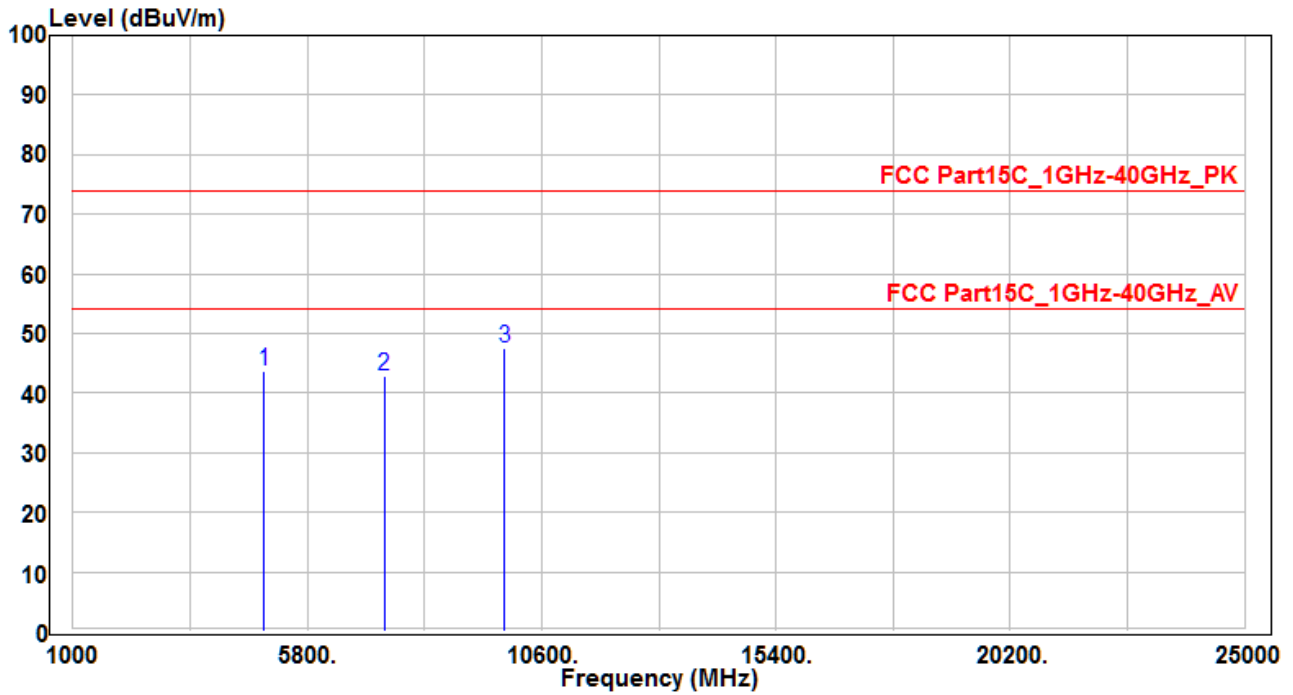

No	Frequency (MHz)	Reading (dBuV)	C.F (dB)	Measurement (dBuV/m)	Margin (dB)	Limit (dBuV)	Height (cm)	Angle (deg)	Remark (QP/PK/AV)
1	4924	40.11	3.65	43.76	-30.24	74	400	400	Peak
2	7386	30.3	12.53	42.83	-31.17	74	400	400	Peak
3	* 9848	31.06	16.34	47.4	-26.6	74	400	400	Peak

Note :

- "*" means the worst value in this measurement data °
- Measure Level (dBuV/m) = Reading Level (dBuV) + Factor (dB) °
- Factor (dB) = Cable Loss (dB) + Antenna Factor (dB/m) °
- The emission levels of other frequencies are very lower than the limit and not show in test report °

EUT	14249-RF2-B	Test Date	2016.10.20
Factor	BBHA 9120D (1GHz~18GHz)	Temp. / Humidity	25°C / 60%
Polarity	Vertical	Site / Engineer	AC1 / Kevin
Test Mode	MODE1-CH11	Test Voltage	By Battery

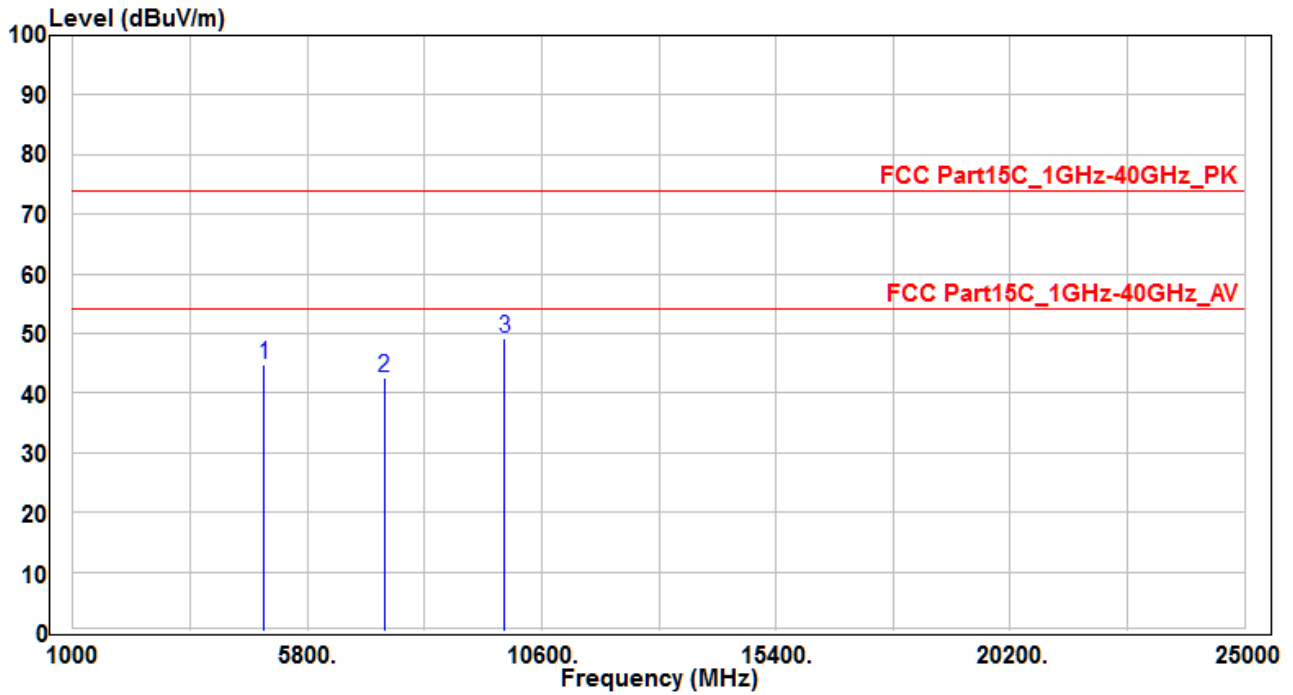

No	Frequency (MHz)	Reading (dBuV)	C.F (dB)	Measurement (dBuV/m)	Margin (dB)	Limit (dBuV)	Height (cm)	Angle (deg)	Remark (QP/PK/AV)
1	4924	41	3.65	44.65	-29.35	74	400	400	Peak
2	7386	30	12.53	42.53	-31.47	74	400	400	Peak
3	* 9848	32.9	16.34	49.24	-24.76	74	400	400	Peak

Note :

- "*" means the worst value in this measurement data °
- Measure Level (dBuV/m) = Reading Level (dBuV) + Factor (dB) °
- Factor (dB) = Cable Loss (dB) + Antenna Factor (dB/m) °
- The emission levels of other frequencies are very lower than the limit and not show in test report °

EUT	14249-RF2-B	Test Date	2016.10.20
Factor	BBHA 9120D (1GHz~18GHz)	Temp. / Humidity	25°C / 60%
Polarity	Horizontal	Site / Engineer	AC1 / Kevin
Test Mode	MODE2-CH01	Test Voltage	By Battery

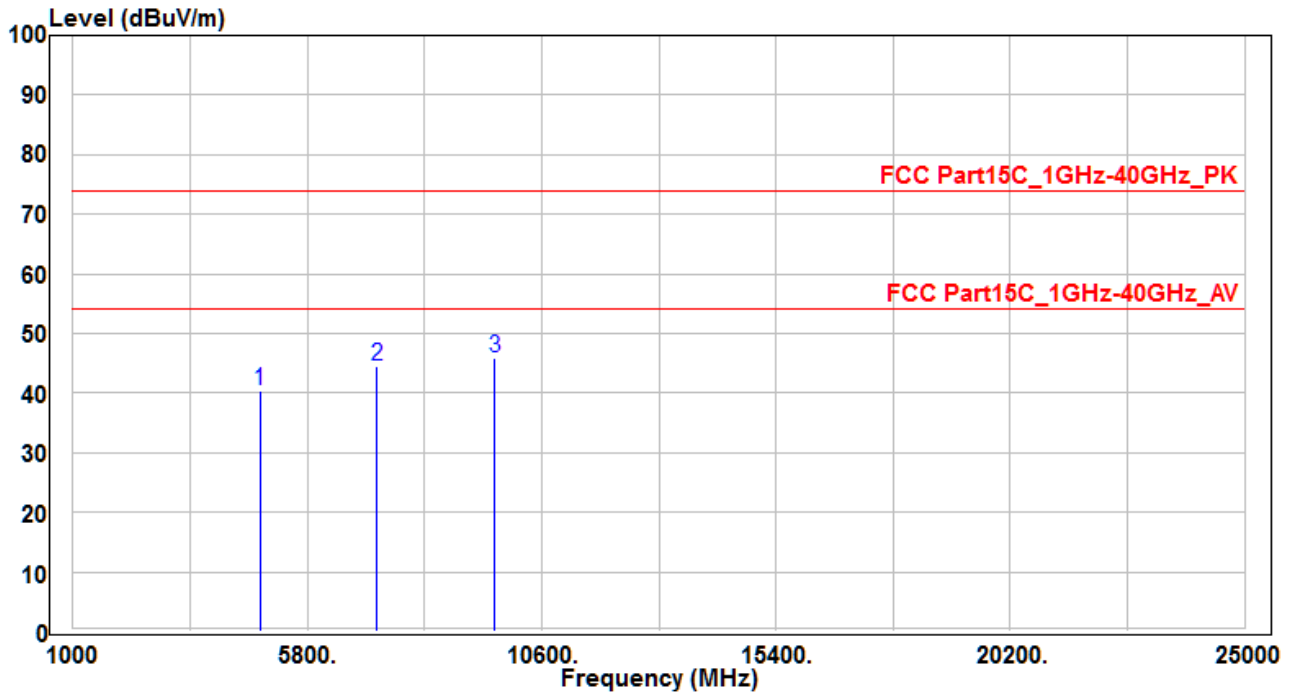

No	Frequency (MHz)	Reading (dBuV)	C.F (dB)	Measurement (dBuV/m)	Margin (dB)	Limit (dBuV)	Height (cm)	Angle (deg)	Remark (QP/PK/AV)
1	4824	36.7	3.67	40.37	-33.63	74	400	400	Peak
2	7236	32.36	12.19	44.55	-29.45	74	400	400	Peak
3	* 9648	30.15	15.67	45.82	-28.18	74	400	400	Peak

Note :

1. " * " means the worst value in this measurement data °
2. Measure Level (dBuV/m) = Reading Level (dBuV) + Factor (dB) °
3. Factor (dB) = Cable Loss (dB) + Antenna Factor (dB/m) °
4. The emission levels of other frequencies are very lower than the limit and not show in test report °

EUT	14249-RF2-B	Test Date	2016.10.20
Factor	BBHA 9120D (1GHz~18GHz)	Temp. / Humidity	25°C / 60%
Polarity	Vertical	Site / Engineer	AC1 / Kevin
Test Mode	MODE2-CH01	Test Voltage	By Battery

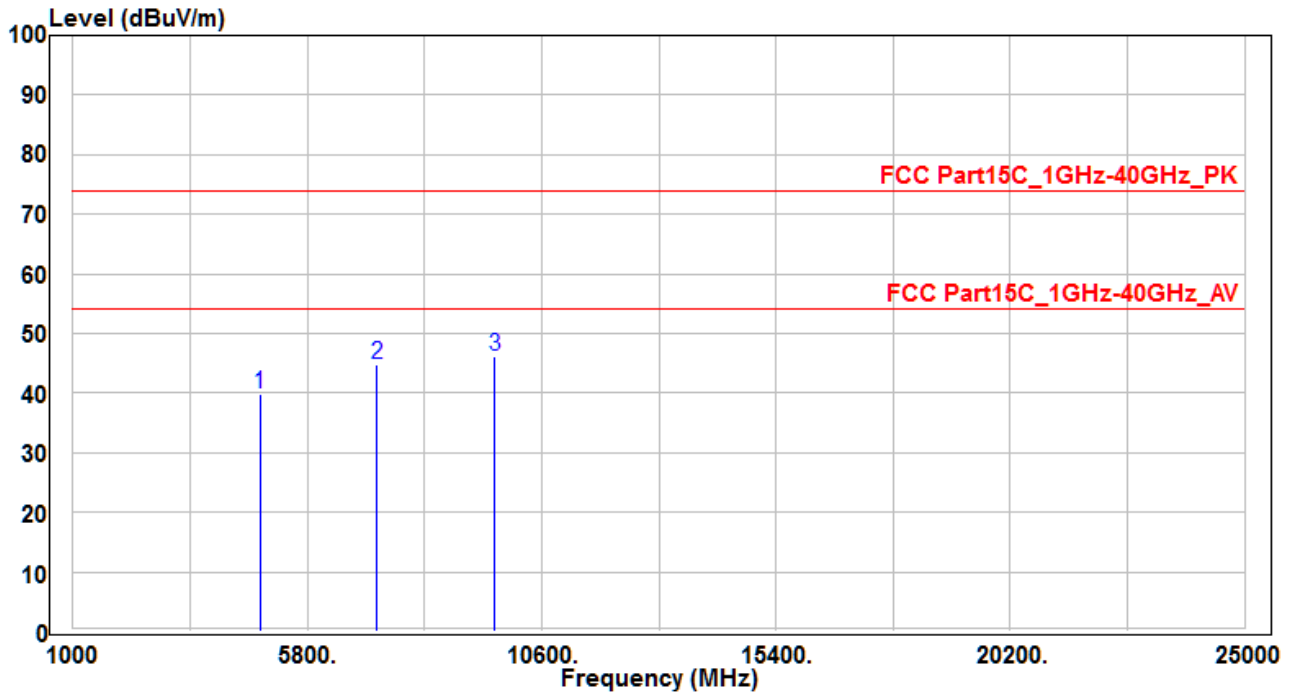

No	Frequency (MHz)	Reading (dBuV)	C.F (dB)	Measurement (dBuV/m)	Margin (dB)	Limit (dBuV)	Height (cm)	Angle (deg)	Remark (QP/PK/AV)
1	4824	36.2	3.67	39.87	-34.13	74	400	400	Peak
2	7236	32.58	12.19	44.77	-29.23	74	400	400	Peak
3	* 9648	30.43	15.67	46.1	-27.9	74	400	400	Peak

Note :

- " * " means the worst value in this measurement data °
- Measure Level (dBuV/m) = Reading Level (dBuV) + Factor (dB) °
- Factor (dB) = Cable Loss (dB) + Antenna Factor (dB/m) °
- The emission levels of other frequencies are very lower than the limit and not show in test report °

EUT	14249-RF2-B	Test Date	2016.10.20
Factor	BBHA 9120D (1GHz~18GHz)	Temp. / Humidity	25°C / 60%
Polarity	Horizontal	Site / Engineer	AC1 / Kevin
Test Mode	MODE2-CH06	Test Voltage	By Battery

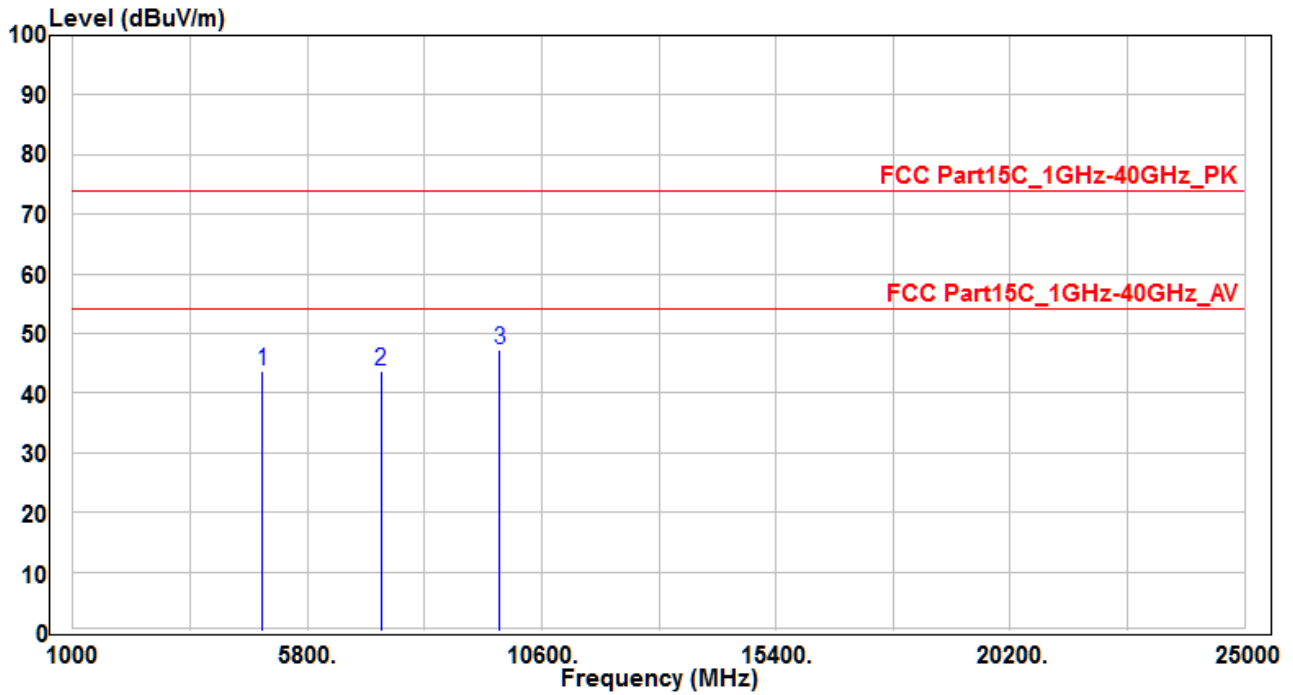

No	Frequency (MHz)	Reading (dBuV)	C.F (dB)	Measurement (dBuV/m)	Margin (dB)	Limit (dBuV)	Height (cm)	Angle (deg)	Remark (QP/PK/AV)
1	4874	40.02	3.65	43.67	-30.33	74	400	400	Peak
2	7311	31.22	12.34	43.56	-30.44	74	400	400	Peak
3	* 9748	31.26	16.02	47.28	-26.72	74	400	400	Peak

Note :

- "*" means the worst value in this measurement data °
- Measure Level (dBuV/m) = Reading Level (dBuV) + Factor (dB) °
- Factor (dB) = Cable Loss (dB) + Antenna Factor (dB/m) °
- The emission levels of other frequencies are very lower than the limit and not show in test report °

EUT	14249-RF2-B	Test Date	2016.10.20
Factor	BBHA 9120D (1GHz~18GHz)	Temp. / Humidity	25°C / 60%
Polarity	Vertical	Site / Engineer	AC1 / Kevin
Test Mode	MODE2-CH06	Test Voltage	By Battery

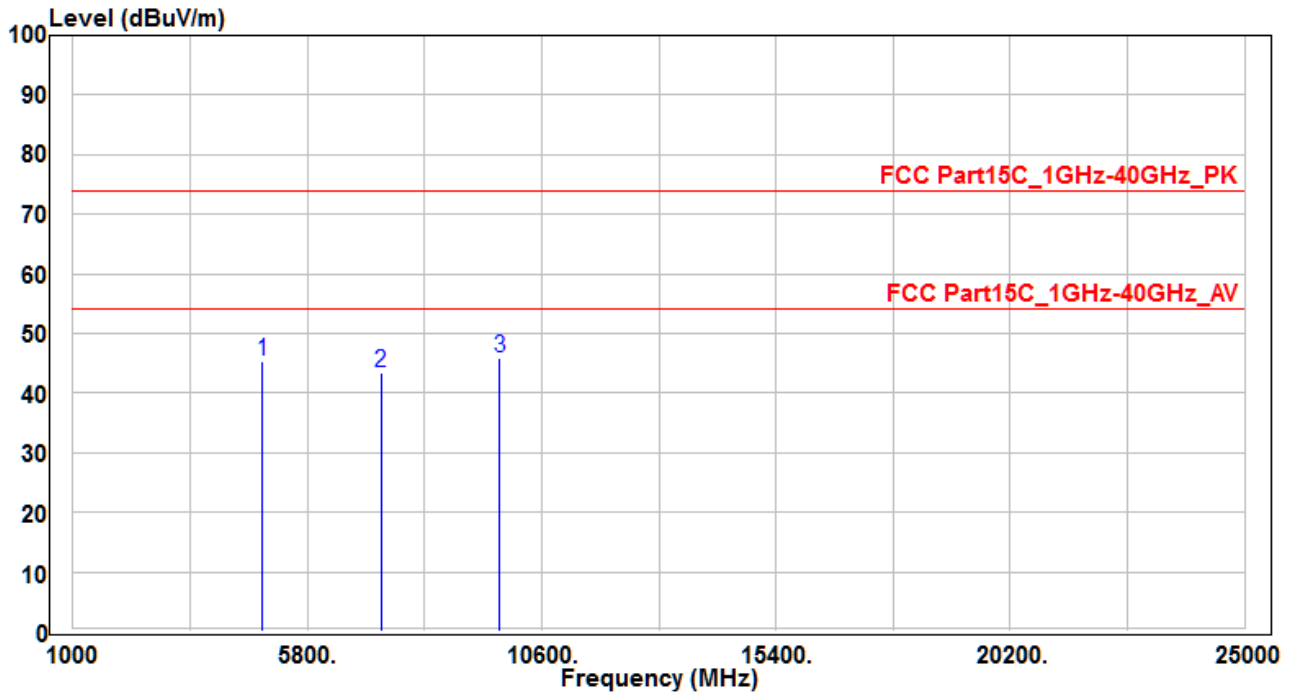

No	Frequency (MHz)	Reading (dBuV)	C.F (dB)	Measurement (dBuV/m)	Margin (dB)	Limit (dBuV)	Height (cm)	Angle (deg)	Remark (QP/PK/AV)
1	4874	41.64	3.65	45.29	-28.71	74	400	400	Peak
2	7311	31.17	12.34	43.51	-30.49	74	400	400	Peak
3	* 9748	29.74	16.02	45.76	-28.24	74	400	400	Peak

Note :

- "*" means the worst value in this measurement data °
- Measure Level (dBuV/m) = Reading Level (dBuV) + Factor (dB) °
- Factor (dB) = Cable Loss (dB) + Antenna Factor (dB/m) °
- The emission levels of other frequencies are very lower than the limit and not show in test report °

EUT	14249-RF2-B	Test Date	2016.10.20
Factor	BBHA 9120D (1GHz~18GHz)	Temp. / Humidity	25°C / 60%
Polarity	Horizontal	Site / Engineer	AC1 / Kevin
Test Mode	MODE2-CH11	Test Voltage	By Battery

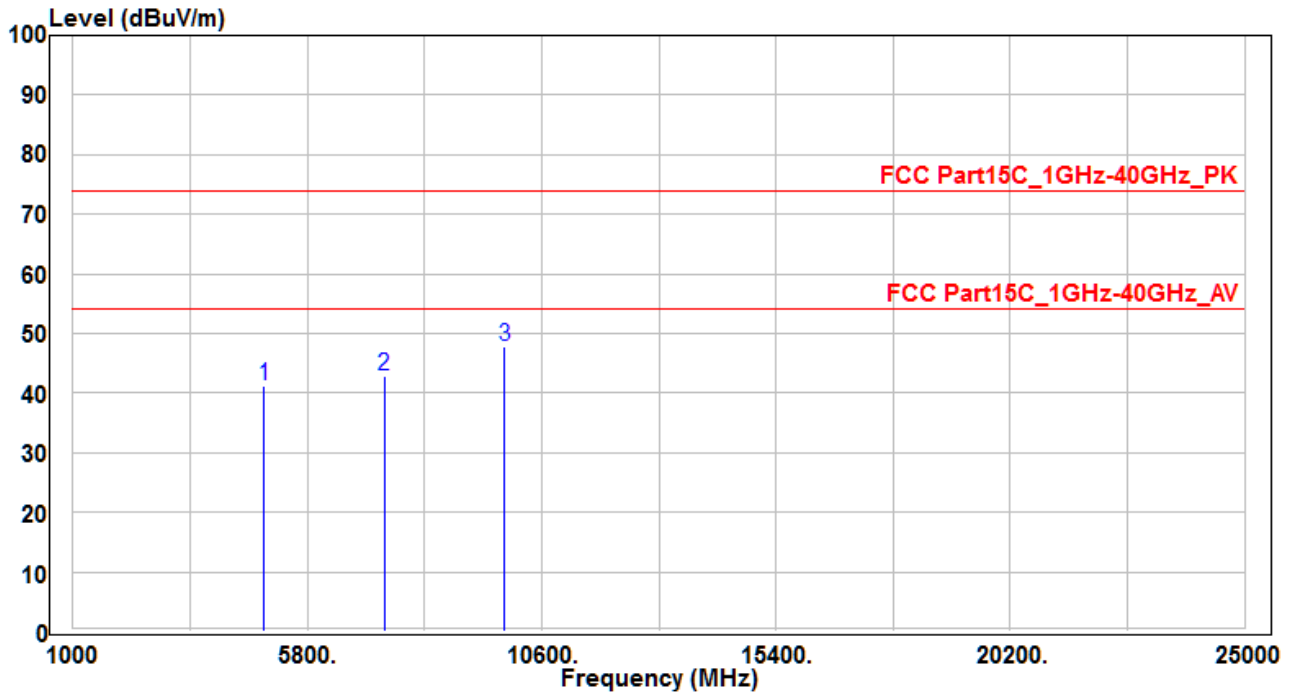

No	Frequency (MHz)	Reading (dBuV)	C.F (dB)	Measurement (dBuV/m)	Margin (dB)	Limit (dBuV)	Height (cm)	Angle (deg)	Remark (QP/PK/AV)
1	4924	37.7	3.65	41.35	-32.65	74	400	400	Peak
2	7386	30.34	12.53	42.87	-31.13	74	400	400	Peak
3	* 9848	31.48	16.34	47.82	-26.18	74	400	400	Peak

Note :

- "*" means the worst value in this measurement data °
- Measure Level (dBuV/m) = Reading Level (dBuV) + Factor (dB) °
- Factor (dB) = Cable Loss (dB) + Antenna Factor (dB/m) °
- The emission levels of other frequencies are very lower than the limit and not show in test report °

EUT	14249-RF2-B	Test Date	2016.10.20
Factor	BBHA 9120D (1GHz~18GHz)	Temp. / Humidity	25°C / 60%
Polarity	Vertical	Site / Engineer	AC1 / Kevin
Test Mode	MODE2-CH11	Test Voltage	By Battery

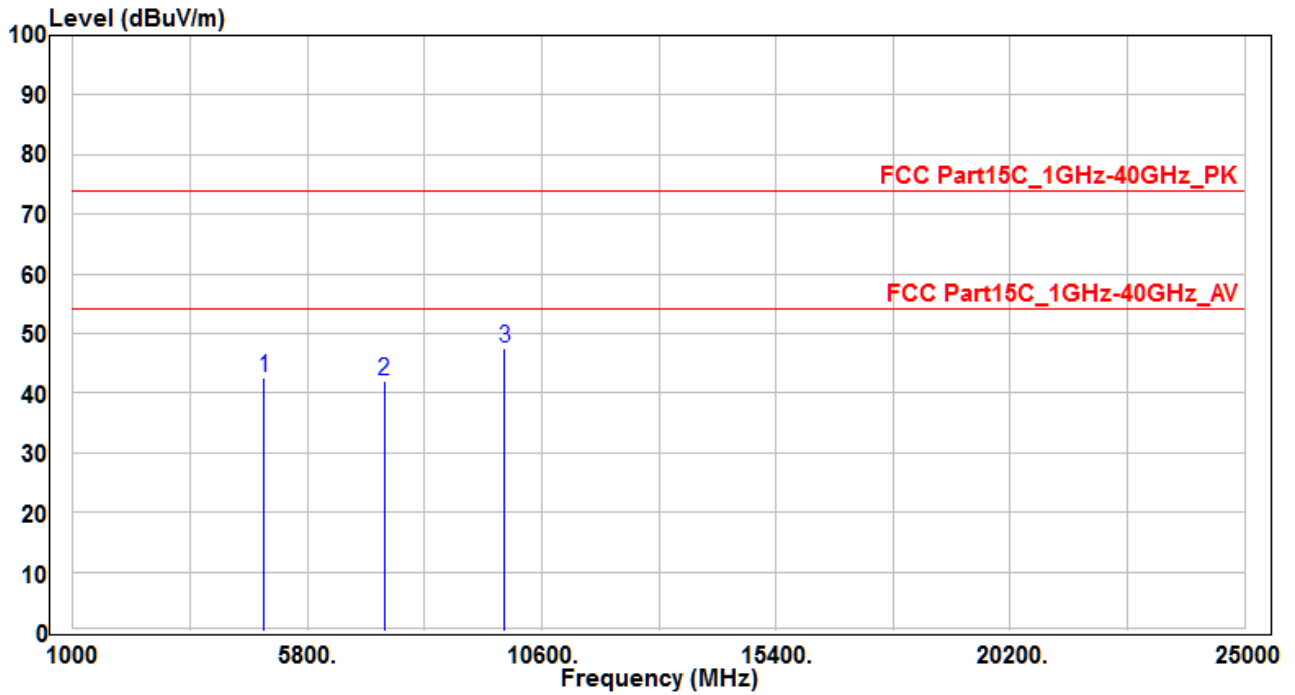

No	Frequency (MHz)	Reading (dBuV)	C.F (dB)	Measurement (dBuV/m)	Margin (dB)	Limit (dBuV)	Height (cm)	Angle (deg)	Remark (QP/PK/AV)
1	4924	39.07	3.65	42.72	-31.28	74	400	400	Peak
2	7386	29.6	12.53	42.13	-31.87	74	400	400	Peak
3	* 9848	31.1	16.34	47.44	-26.56	74	400	400	Peak

Note :

- "*" means the worst value in this measurement data °
- Measure Level (dBuV/m) = Reading Level (dBuV) + Factor (dB) °
- Factor (dB) = Cable Loss (dB) + Antenna Factor (dB/m) °
- The emission levels of other frequencies are very lower than the limit and not show in test report °

EUT	14249-RF2-B	Test Date	2016.10.20
Factor	BBHA 9120D (1GHz~18GHz)	Temp. / Humidity	25°C / 60%
Polarity	Horizontal	Site / Engineer	AC1 / Kevin
Test Mode	MODE3-CH01	Test Voltage	By Battery

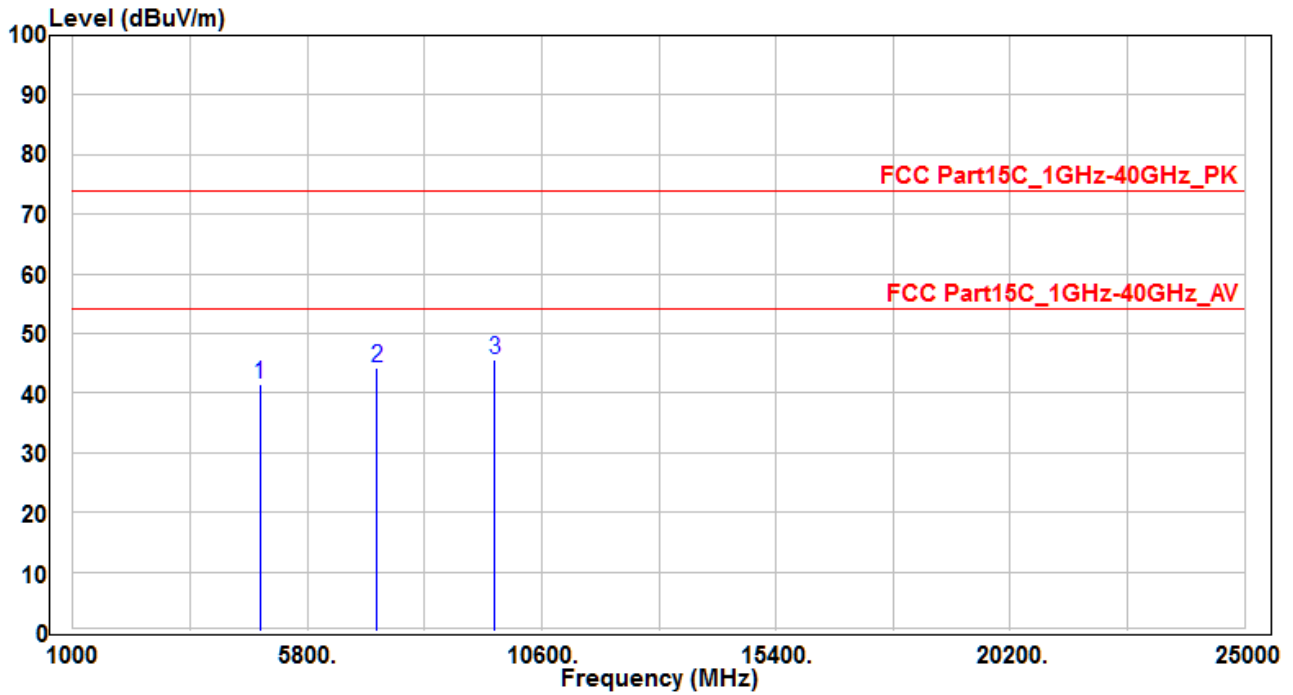

No	Frequency (MHz)	Reading (dBuV)	C.F (dB)	Measurement (dBuV/m)	Margin (dB)	Limit (dBuV)	Height (cm)	Angle (deg)	Remark (QP/PK/AV)
1	4824	37.8	3.67	41.47	-32.53	74	400	400	Peak
2	7236	31.95	12.19	44.14	-29.86	74	400	400	Peak
3	* 9648	29.88	15.67	45.55	-28.45	74	400	400	Peak

Note :

1. " * " means the worst value in this measurement data °
2. Measure Level (dBuV/m) = Reading Level (dBuV) + Factor (dB) °
3. Factor (dB) = Cable Loss (dB) + Antenna Factor (dB/m) °
4. The emission levels of other frequencies are very lower than the limit and not show in test report °

EUT	14249-RF2-B	Test Date	2016.10.20
Factor	BBHA 9120D (1GHz~18GHz)	Temp. / Humidity	25°C / 60%
Polarity	Vertical	Site / Engineer	AC1 / Kevin
Test Mode	MODE3-CH01	Test Voltage	By Battery

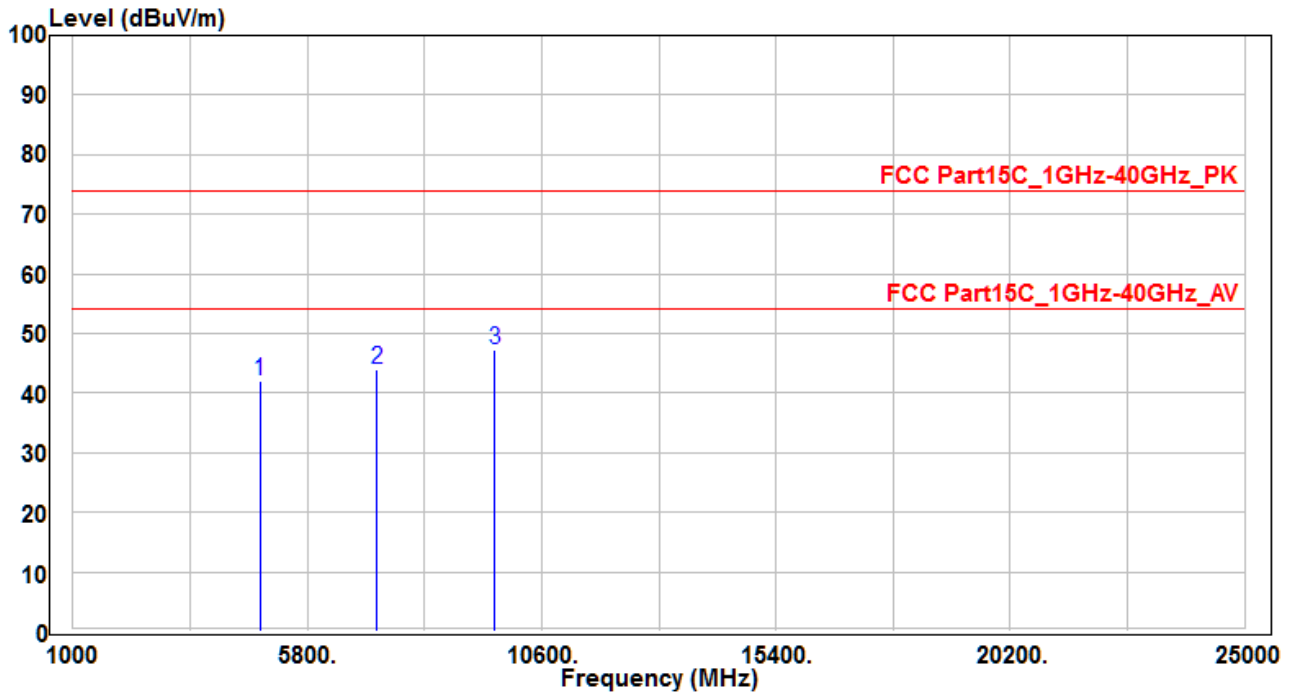

No	Frequency (MHz)	Reading (dBuV)	C.F (dB)	Measurement (dBuV/m)	Margin (dB)	Limit (dBuV)	Height (cm)	Angle (deg)	Remark (QP/PK/AV)
1	4824	38.42	3.67	42.09	-31.91	74	400	400	Peak
2	7236	31.91	12.19	44.1	-29.9	74	400	400	Peak
3	* 9648	31.73	15.67	47.4	-26.6	74	400	400	Peak

Note :

- " * " means the worst value in this measurement data °
- Measure Level (dBuV/m) = Reading Level (dBuV) + Factor (dB) °
- Factor (dB) = Cable Loss (dB) + Antenna Factor (dB/m) °
- The emission levels of other frequencies are very lower than the limit and not show in test report °

EUT	14249-RF2-B	Test Date	2016.10.20
Factor	BBHA 9120D (1GHz~18GHz)	Temp. / Humidity	25°C / 60%
Polarity	Horizontal	Site / Engineer	AC1 / Kevin
Test Mode	MODE3-CH06	Test Voltage	By Battery

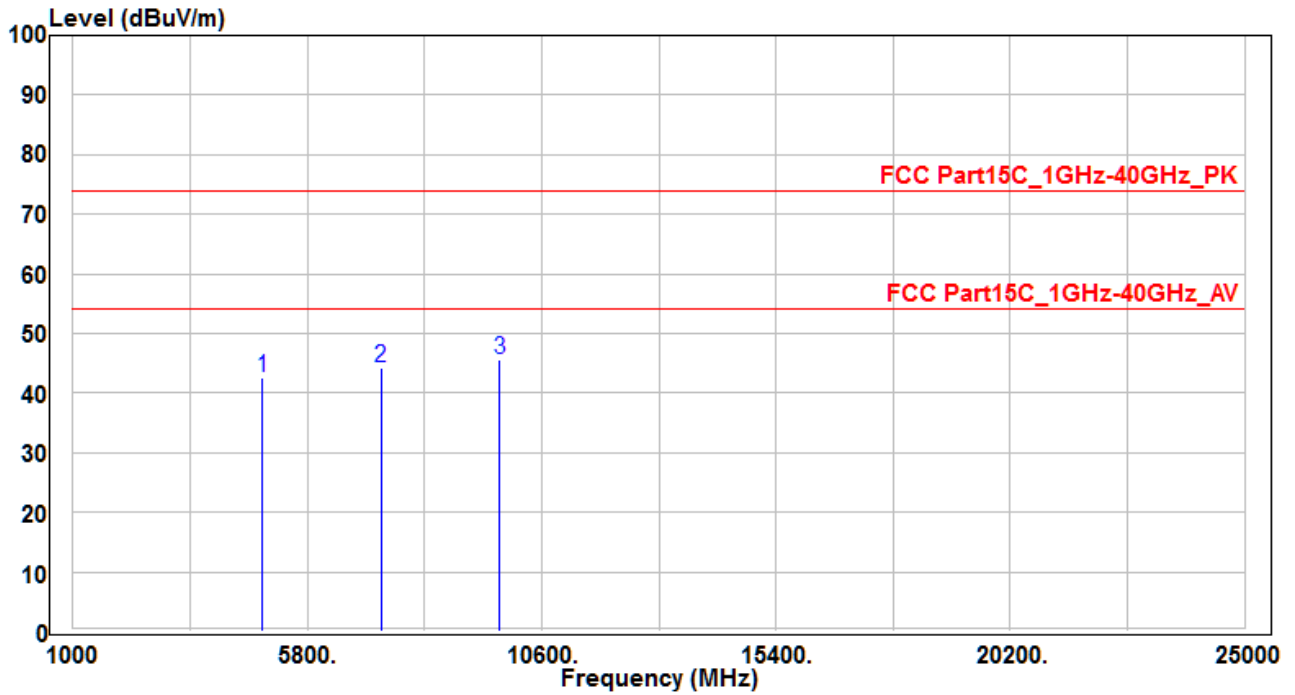

No	Frequency (MHz)	Reading (dBuV)	C.F (dB)	Measurement (dBuV/m)	Margin (dB)	Limit (dBuV)	Height (cm)	Angle (deg)	Remark (QP/PK/AV)
1	4874	39.04	3.65	42.69	-31.31	74	400	400	Peak
2	7311	32.01	12.34	44.35	-29.65	74	400	400	Peak
3	* 9748	29.72	16.02	45.74	-28.26	74	400	400	Peak

Note :

- "*" means the worst value in this measurement data °
- Measure Level (dBuV/m) = Reading Level (dBuV) + Factor (dB) °
- Factor (dB) = Cable Loss (dB) + Antenna Factor (dB/m) °
- The emission levels of other frequencies are very lower than the limit and not show in test report °

EUT	14249-RF2-B	Test Date	2016.10.20
Factor	BBHA 9120D (1GHz~18GHz)	Temp. / Humidity	25°C / 60%
Polarity	Vertical	Site / Engineer	AC1 / Kevin
Test Mode	MODE3-CH06	Test Voltage	By Battery

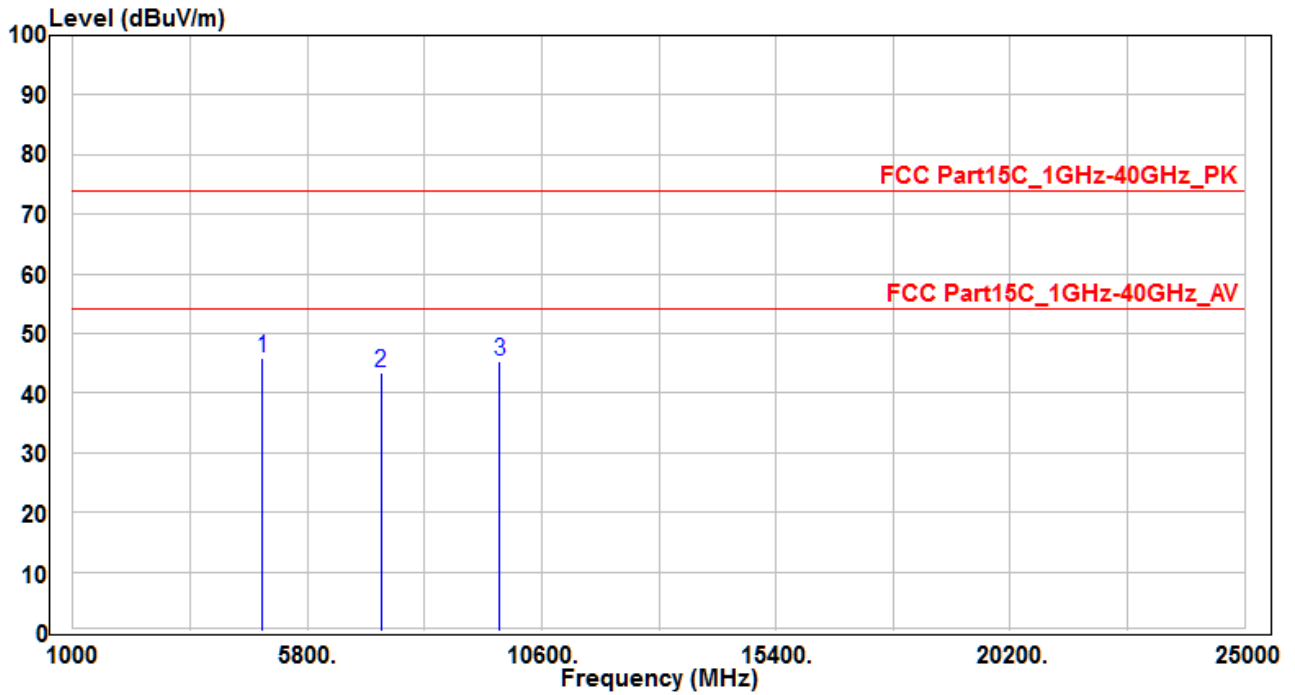

No		Frequency (MHz)	Reading (dBuV)	C.F (dB)	Measurement (dBuV/m)	Margin (dB)	Limit (dBuV)	Height (cm)	Angle (deg)	Remark (QP/PK/AV)
1	*	4874	42.14	3.65	45.79	-28.21	74	400	400	Peak
2		7311	31.03	12.34	43.37	-30.63	74	400	400	Peak
3		9748	29.45	16.02	45.47	-28.53	74	400	400	Peak

Note :

- "*" means the worst value in this measurement data °
- Measure Level (dBuV/m) = Reading Level (dBuV) + Factor (dB) °
- Factor (dB) = Cable Loss (dB) + Antenna Factor (dB/m) °
- The emission levels of other frequencies are very lower than the limit and not show in test report °

EUT	14249-RF2-B	Test Date	2016.10.20
Factor	BBHA 9120D (1GHz~18GHz)	Temp. / Humidity	25°C / 60%
Polarity	Horizontal	Site / Engineer	AC1 / Kevin
Test Mode	MODE3-CH11	Test Voltage	By Battery

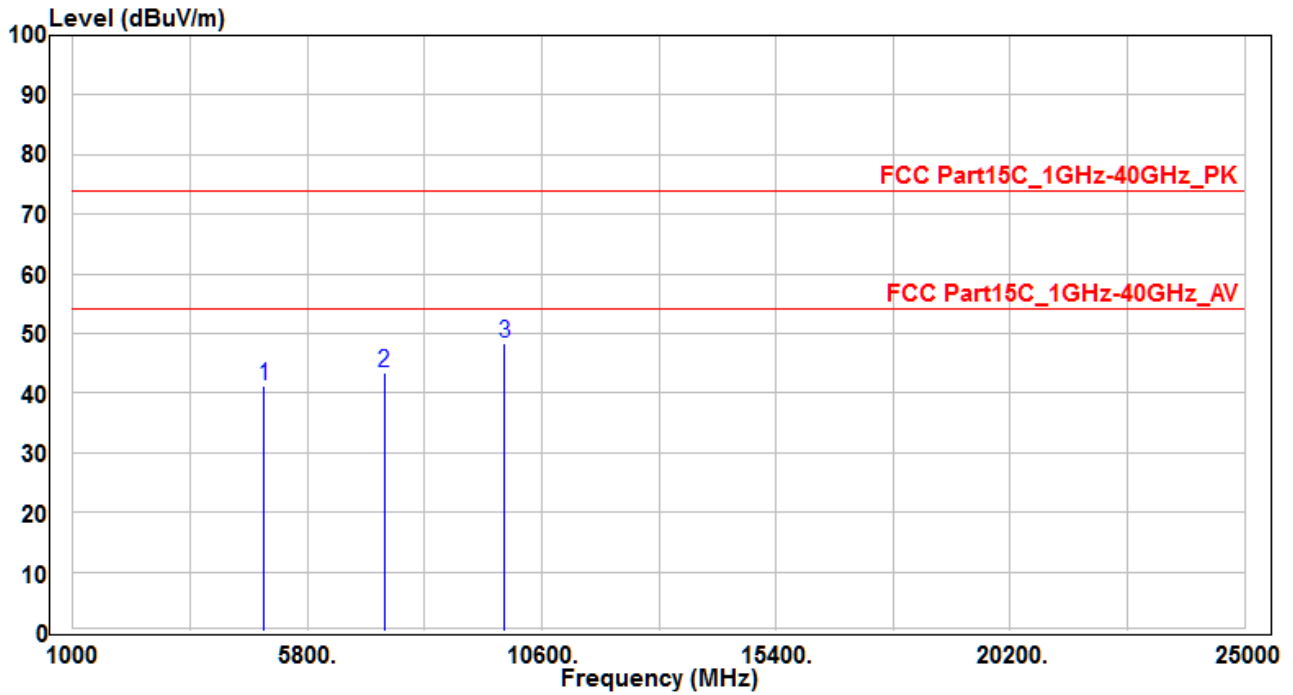

No	Frequency (MHz)	Reading (dBuV)	C.F (dB)	Measurement (dBuV/m)	Margin (dB)	Limit (dBuV)	Height (cm)	Angle (deg)	Remark (QP/PK/AV)
1	4924	37.61	3.65	41.26	-32.74	74	400	400	Peak
2	7386	30.76	12.53	43.29	-30.71	74	400	400	Peak
3	* 9848	31.9	16.34	48.24	-25.76	74	400	400	Peak

Note :

- "*" means the worst value in this measurement data °
- Measure Level (dBuV/m) = Reading Level (dBuV) + Factor (dB) °
- Factor (dB) = Cable Loss (dB) + Antenna Factor (dB/m) °
- The emission levels of other frequencies are very lower than the limit and not show in test report °

EUT	14249-RF2-B	Test Date	2016.10.20
Factor	BBHA 9120D (1GHz~18GHz)	Temp. / Humidity	25°C / 60%
Polarity	Vertical	Site / Engineer	AC1 / Kevin
Test Mode	MODE3-CH11	Test Voltage	By Battery

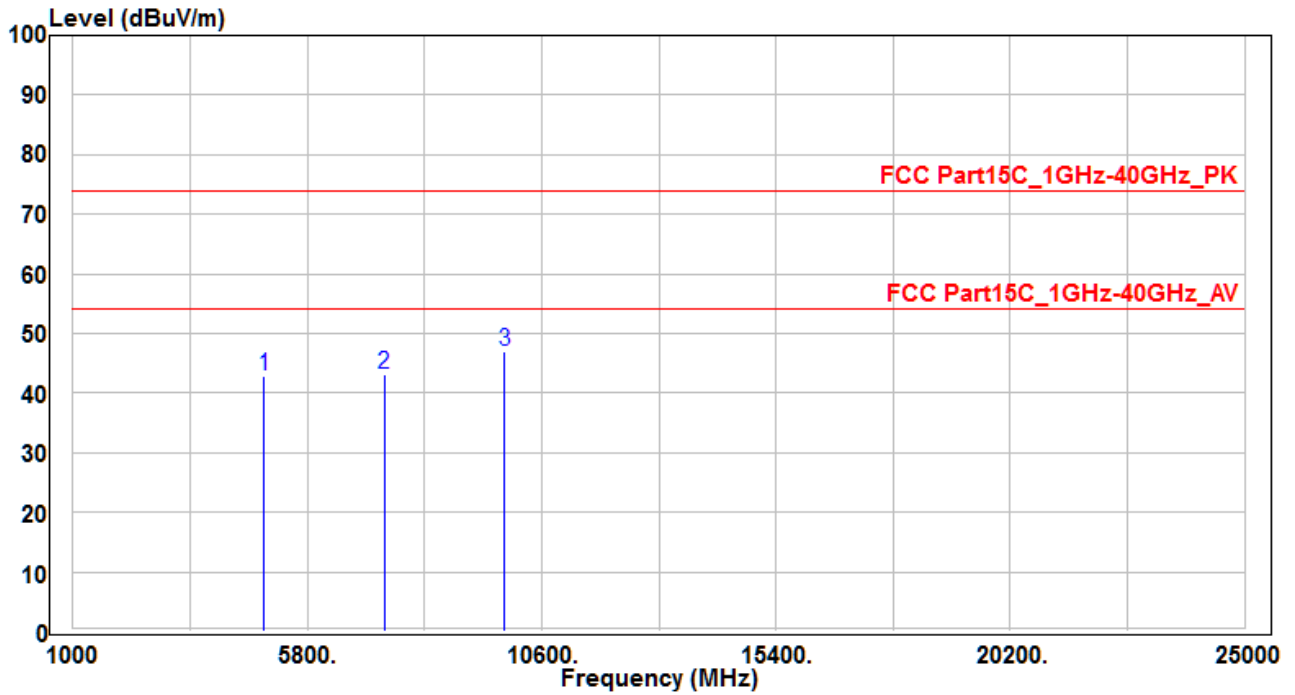

No	Frequency (MHz)	Reading (dBuV)	C.F (dB)	Measurement (dBuV/m)	Margin (dB)	Limit (dBuV)	Height (cm)	Angle (deg)	Remark (QP/PK/AV)
1	4924	39.1	3.65	42.75	-31.25	74	400	400	Peak
2	7386	30.67	12.53	43.2	-30.8	74	400	400	Peak
3	* 9848	30.75	16.34	47.09	-26.91	74	400	400	Peak

Note :

- "*" means the worst value in this measurement data °
- Measure Level (dBuV/m) = Reading Level (dBuV) + Factor (dB) °
- Factor (dB) = Cable Loss (dB) + Antenna Factor (dB/m) °
- The emission levels of other frequencies are very lower than the limit and not show in test report °

EUT	14249-RF2-B	Test Date	2016.10.20
Factor	BBHA 9120D (1GHz~18GHz)	Temp. / Humidity	25°C / 60%
Polarity	Horizontal	Site / Engineer	AC1 / Kevin
Test Mode	MODE4-CH03	Test Voltage	By Battery

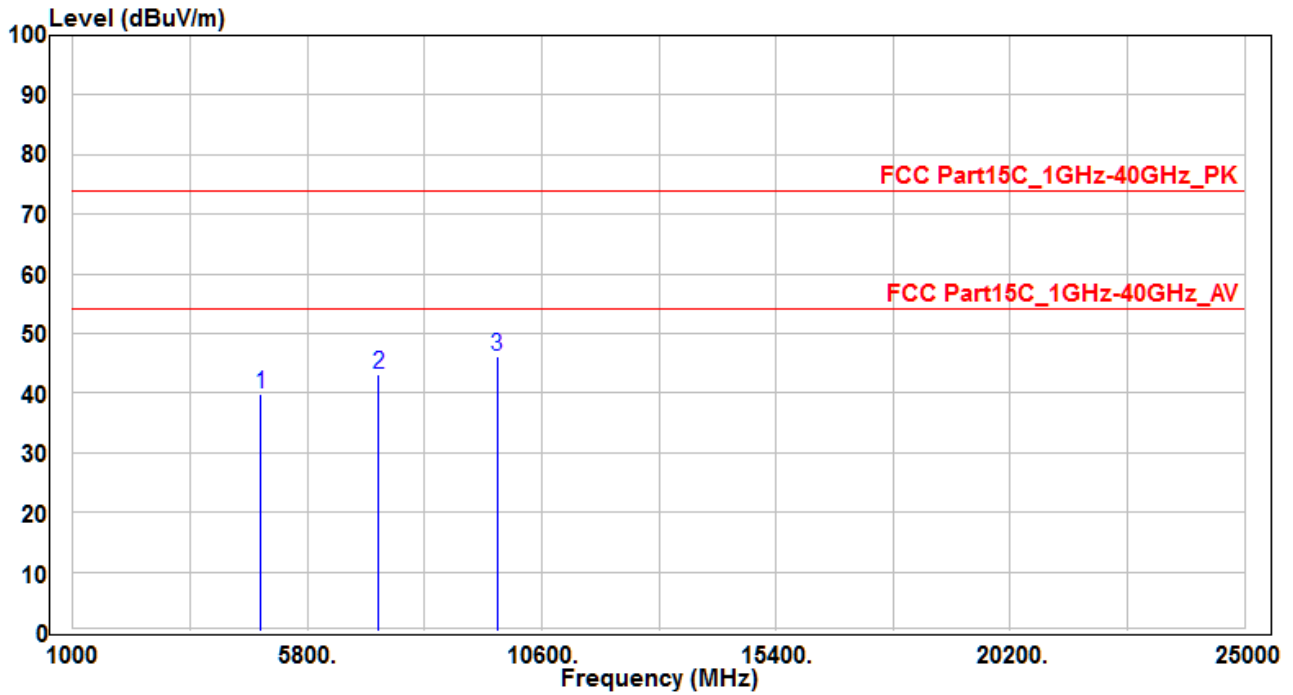

No	Frequency (MHz)	Reading (dBuV)	C.F (dB)	Measurement (dBuV/m)	Margin (dB)	Limit (dBuV)	Height (cm)	Angle (deg)	Remark (QP/PK/AV)
1	4844	36.28	3.68	39.96	-34.04	74	400	400	Peak
2	7266	30.83	12.25	43.08	-30.92	74	400	400	Peak
3	* 9688	30.35	15.81	46.16	-27.84	74	400	400	Peak

Note :

- "*" means the worst value in this measurement data °
- Measure Level (dBuV/m) = Reading Level (dBuV) + Factor (dB) °
- Factor (dB) = Cable Loss (dB) + Antenna Factor (dB/m) °
- The emission levels of other frequencies are very lower than the limit and not show in test report °

EUT	14249-RF2-B	Test Date	2016.10.20
Factor	BBHA 9120D (1GHz~18GHz)	Temp. / Humidity	25°C / 60%
Polarity	Vertical	Site / Engineer	AC1 / Kevin
Test Mode	MODE4-CH03	Test Voltage	By Battery

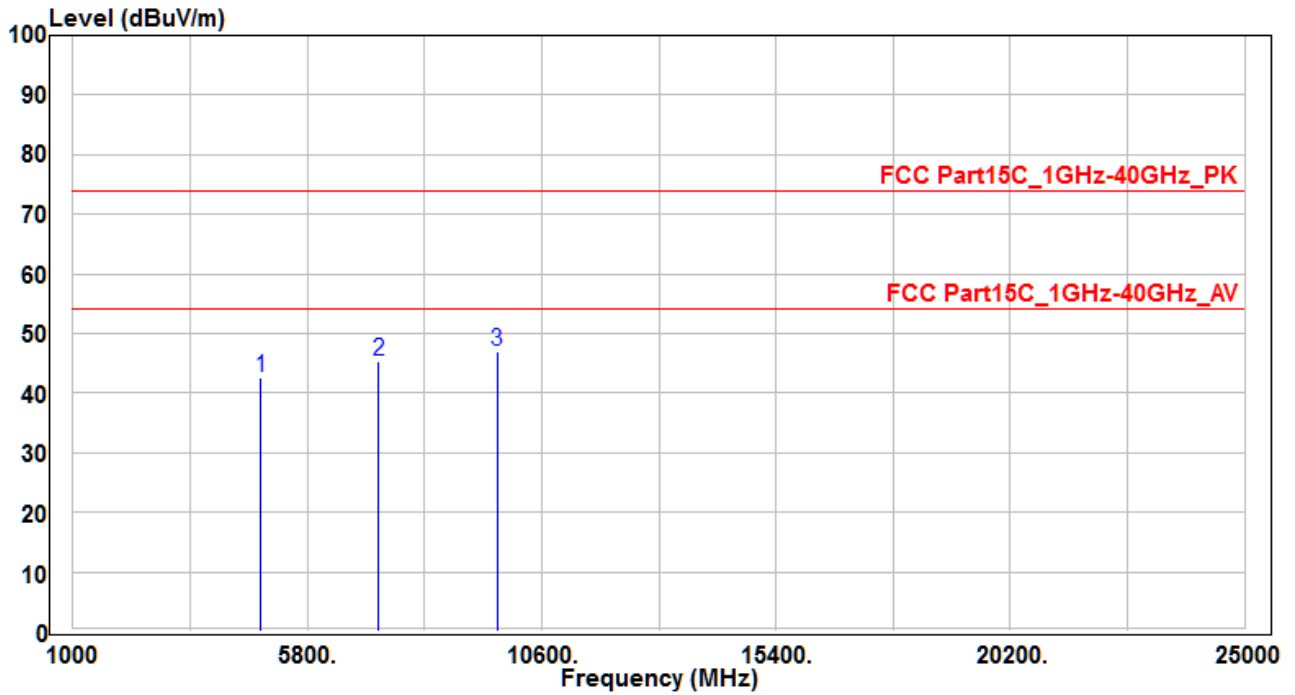

No	Frequency (MHz)	Reading (dBuV)	C.F (dB)	Measurement (dBuV/m)	Margin (dB)	Limit (dBuV)	Height (cm)	Angle (deg)	Remark (QP/PK/AV)
1	4844	38.84	3.68	42.52	-31.48	74	400	400	Peak
2	7266	33.04	12.25	45.29	-28.71	74	400	400	Peak
3	* 9688	31.25	15.81	47.06	-26.94	74	400	400	Peak

Note :

- "*" means the worst value in this measurement data °
- Measure Level (dBuV/m) = Reading Level (dBuV) + Factor (dB) °
- Factor (dB) = Cable Loss (dB) + Antenna Factor (dB/m) °
- The emission levels of other frequencies are very lower than the limit and not show in test report °

EUT	14249-RF2-B	Test Date	2016.10.20
Factor	BBHA 9120D (1GHz~18GHz)	Temp. / Humidity	25°C / 60%
Polarity	Horizontal	Site / Engineer	AC1 / Kevin
Test Mode	MODE2-CH06	Test Voltage	By Battery

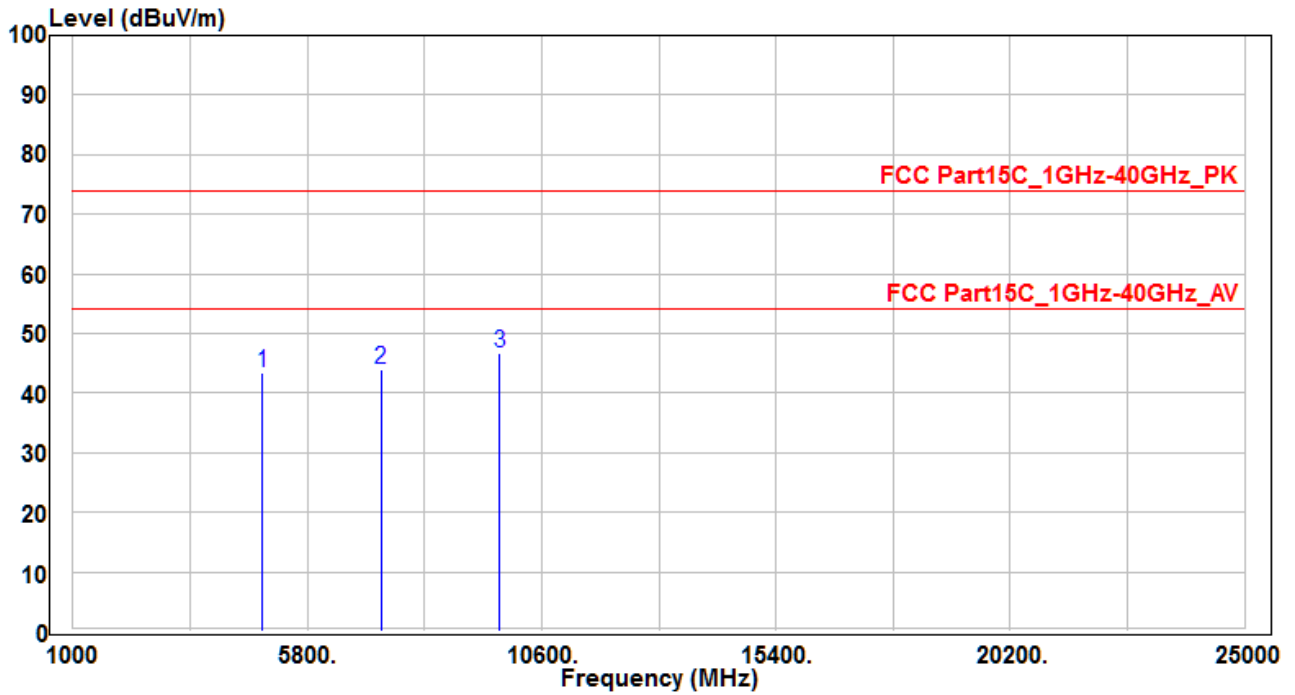

No	Frequency (MHz)	Reading (dBuV)	C.F (dB)	Measurement (dBuV/m)	Margin (dB)	Limit (dBuV)	Height (cm)	Angle (deg)	Remark (QP/PK/AV)
1	4874	39.87	3.65	43.52	-30.48	74	400	400	Peak
2	7311	31.55	12.34	43.89	-30.11	74	400	400	Peak
3	* 9748	30.79	16.02	46.81	-27.19	74	400	400	Peak

Note :

- "*" means the worst value in this measurement data °
- Measure Level (dBuV/m) = Reading Level (dBuV) + Factor (dB) °
- Factor (dB) = Cable Loss (dB) + Antenna Factor (dB/m) °
- The emission levels of other frequencies are very lower than the limit and not show in test report °

EUT	14249-RF2-B	Test Date	2016.10.20
Factor	BBHA 9120D (1GHz~18GHz)	Temp. / Humidity	25°C / 60%
Polarity	Vertical	Site / Engineer	AC1 / Kevin
Test Mode	MODE2-CH06	Test Voltage	By Battery

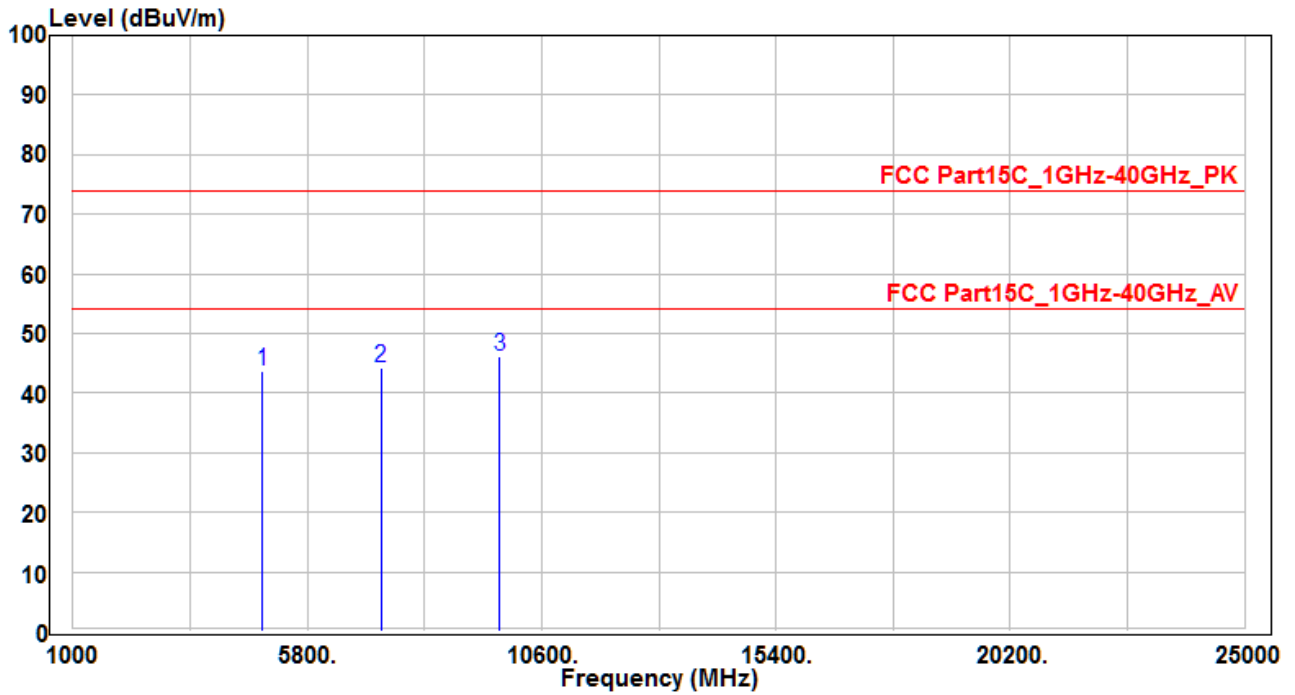

No	Frequency (MHz)	Reading (dBuV)	C.F (dB)	Measurement (dBuV/m)	Margin (dB)	Limit (dBuV)	Height (cm)	Angle (deg)	Remark (QP/PK/AV)
1	4874	40.11	3.65	43.76	-30.24	74	400	400	Peak
2	7311	31.77	12.34	44.11	-29.89	74	400	400	Peak
3	* 9748	30.11	16.02	46.13	-27.87	74	400	400	Peak

Note :

- "*" means the worst value in this measurement data °
- Measure Level (dBuV/m) = Reading Level (dBuV) + Factor (dB) °
- Factor (dB) = Cable Loss (dB) + Antenna Factor (dB/m) °
- The emission levels of other frequencies are very lower than the limit and not show in test report °

EUT	14249-RF2-B	Test Date	2016.10.20
Factor	BBHA 9120D (1GHz~18GHz)	Temp. / Humidity	25°C / 60%
Polarity	Horizontal	Site / Engineer	AC1 / Kevin
Test Mode	MODE2-CH09	Test Voltage	By Battery

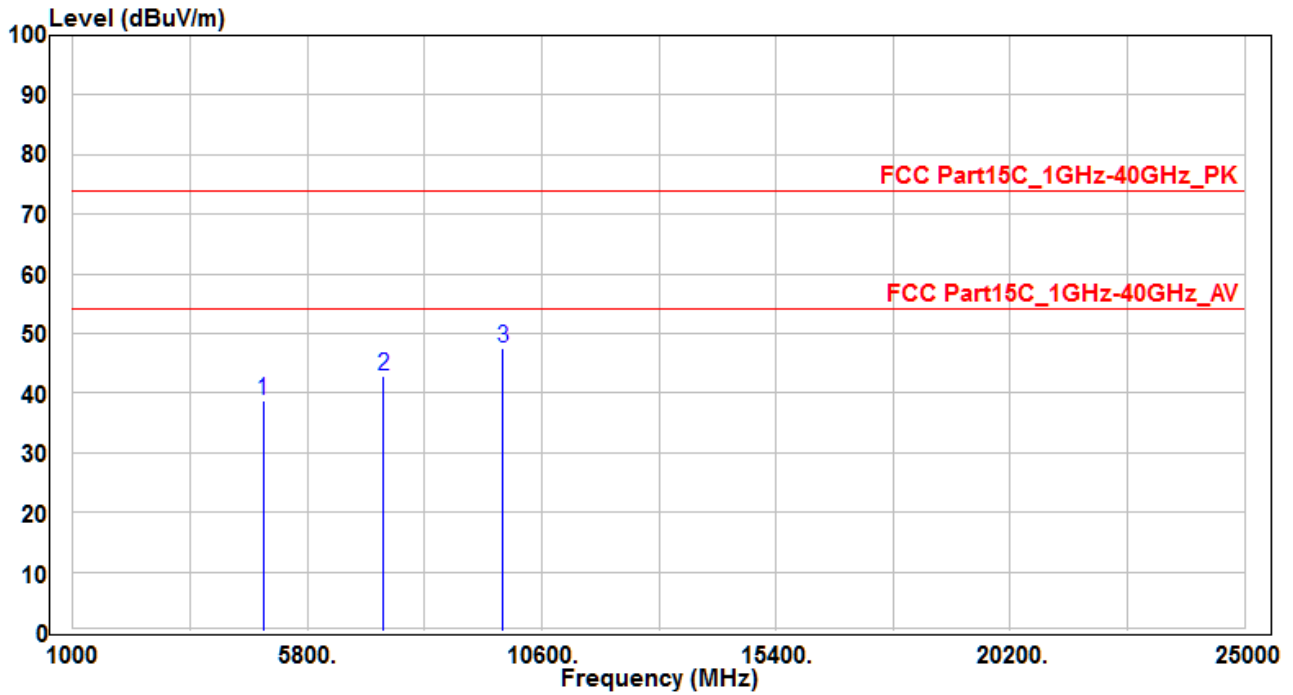

No	Frequency (MHz)	Reading (dBuV)	C.F (dB)	Measurement (dBuV/m)	Margin (dB)	Limit (dBuV)	Height (cm)	Angle (deg)	Remark (QP/PK/AV)
1	4904	34.99	3.64	38.63	-35.37	74	400	400	Peak
2	7356	30.47	12.44	42.91	-31.09	74	400	400	Peak
3	* 9808	31.27	16.24	47.51	-26.49	74	400	400	Peak

Note :

- "*" means the worst value in this measurement data °
- Measure Level (dBuV/m) = Reading Level (dBuV) + Factor (dB) °
- Factor (dB) = Cable Loss (dB) + Antenna Factor (dB/m) °
- The emission levels of other frequencies are very lower than the limit and not show in test report °

EUT	14249-RF2-B	Test Date	2016.10.20
Factor	BBHA 9120D (1GHz~18GHz)	Temp. / Humidity	25°C / 60%
Polarity	Vertical	Site / Engineer	AC1 / Kevin
Test Mode	MODE4-CH09	Test Voltage	By Battery

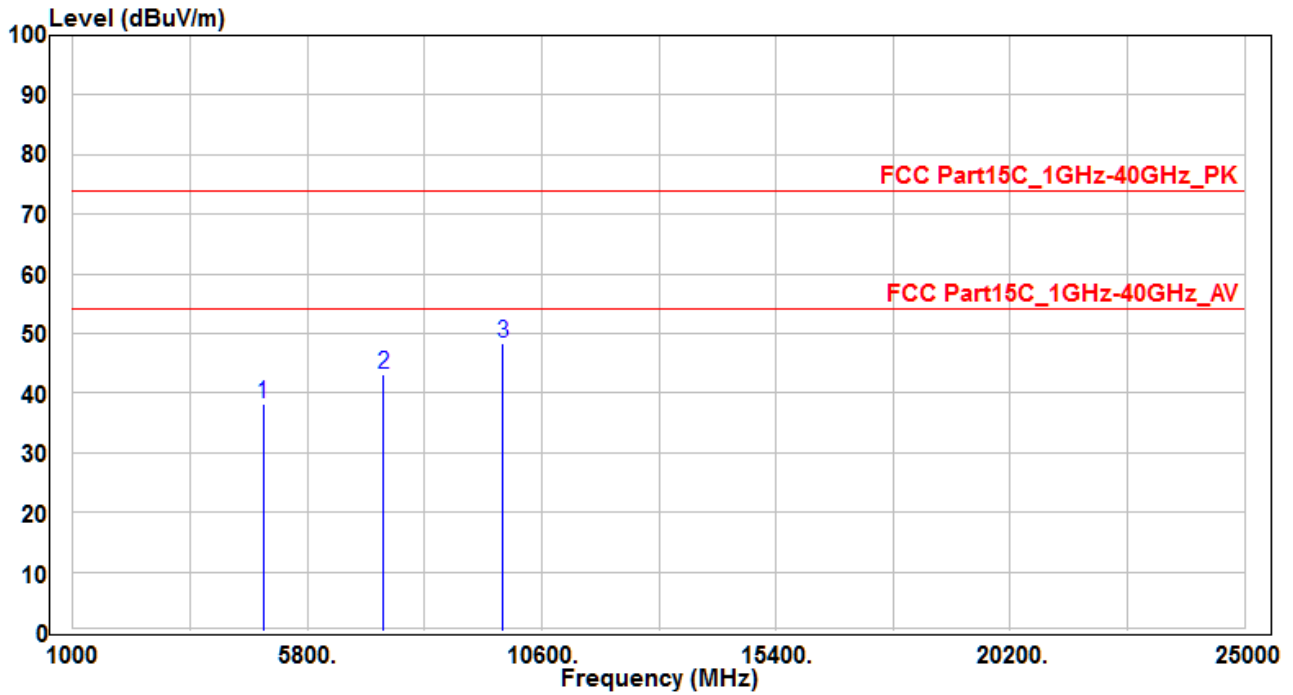

No	Frequency (MHz)	Reading (dBuV)	C.F (dB)	Measurement (dBuV/m)	Margin (dB)	Limit (dBuV)	Height (cm)	Angle (deg)	Remark (QP/PK/AV)
1	4904	34.6	3.64	38.24	-35.76	74	400	400	Peak
2	7356	30.7	12.44	43.14	-30.86	74	400	400	Peak
3	* 9808	32.03	16.24	48.27	-25.73	74	400	400	Peak

Note :

- "*" means the worst value in this measurement data °
- Measure Level (dBuV/m) = Reading Level (dBuV) + Factor (dB) °
- Factor (dB) = Cable Loss (dB) + Antenna Factor (dB/m) °
- The emission levels of other frequencies are very lower than the limit and not show in test report °

7.7. Radiated Restricted Band Edge Measurement

7.7.1. Test Limit

All out of band emissions appearing in a restricted band as specified in Section 15.205 of the Title 47 CFR must not exceed the limits shown in Table per Section 15.209.

FCC Part 15 Subpart C Paragraph 15.209		
Frequency [MHz]	Field Strength [V/m]	Measured Distance [Meters]
0.009 - 0.490	2400/F (kHz)	300
0.490 - 1.705	24000/F (kHz)	30
1.705 – 30	30	30
30 – 88	100	3
88 – 216	150	3
216 – 960	200	3
Above 960	500	3

7.7.2. Test Procedure Used

ANSI C63.10-2013 - Section 11.12.1

7.7.3. Test Setting

Peak Field Strength Measurements

1. Analyzer center frequency was set to the frequency of the radiated spurious emission of interest
2. RBW = as specified in Table 1
3. VBW = 3 * RBW
4. Detector = peak
5. Sweep time = auto couple
6. Trace mode = max hold
7. Trace was allowed to stabilize

Table 1 - RBW as a function of frequency

Frequency	RBW
9 ~ 150 kHz	200 ~ 300 Hz
0.15 ~ 30 MHz	9 ~ 10 kHz
30 ~ 1000 MHz	100 ~ 120 kHz
> 1000 MHz	1 MHz

Average Field Strength Measurements

1. Analyzer center frequency was set to the frequency of the radiated spurious emission of interest
2. RBW = 1MHz
3. VBW $\geq 1/T$
4. De As an alternative, the instrument may be set to linear detector mode. Ensure that video filtering is applied in linear voltage domain (rather than in a log or dB domain). Some instruments require linear display mode in order to accomplish this. Others have a setting for Average-VBW Type, which can be set to "Voltage" regardless of the display mode
5. Detector = Peak
6. Sweep time = auto
7. Trace mode = max hold
8. Allow max hold to run for at least 50 times (1/duty cycle) traces

7.7.4. Test Setup

1GHz ~ 18GHz Test Setup:

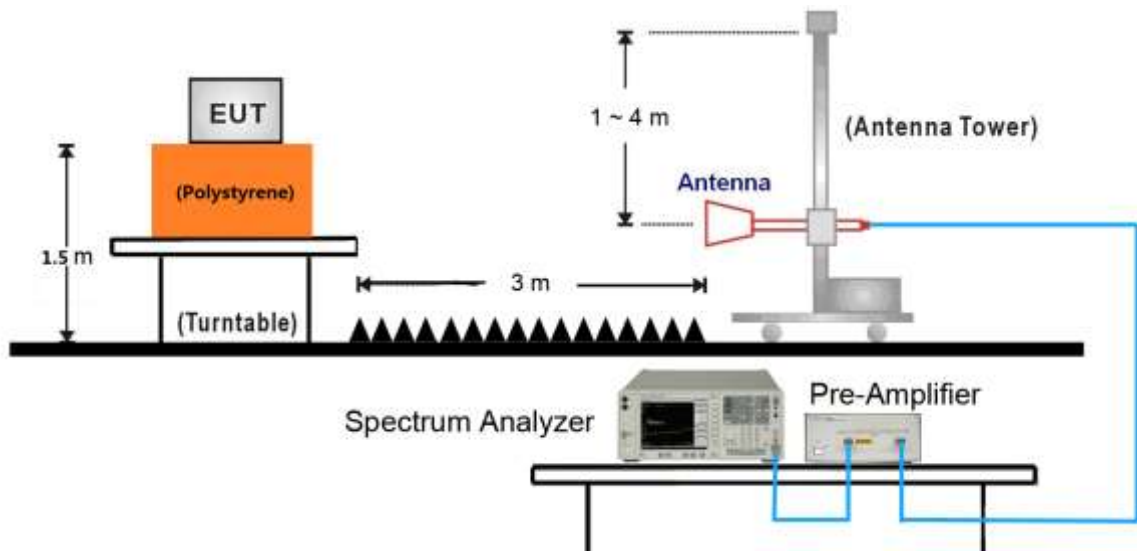

18GHz ~40GHz Test Setup:

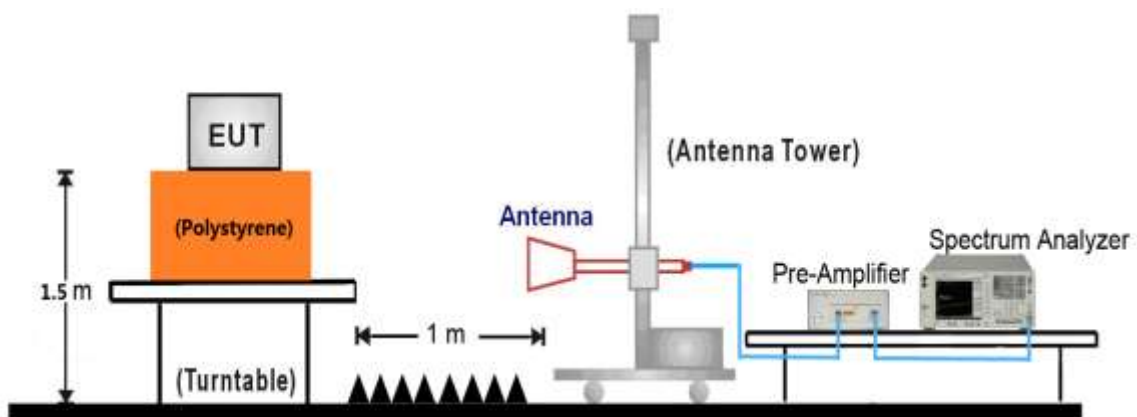

7.7.5. Test Result

EUT	14249-RF2-B	Test Date	2016.10.20
Factor	BBHA 9120D (1GHz~18GHz)	Temp. / Humidity	21°C / 57%
Polarity	Horizontal	Site / Engineer	AC1 / Kevin
Test Mode	MODE1-CH01	Test Voltage	By Battery

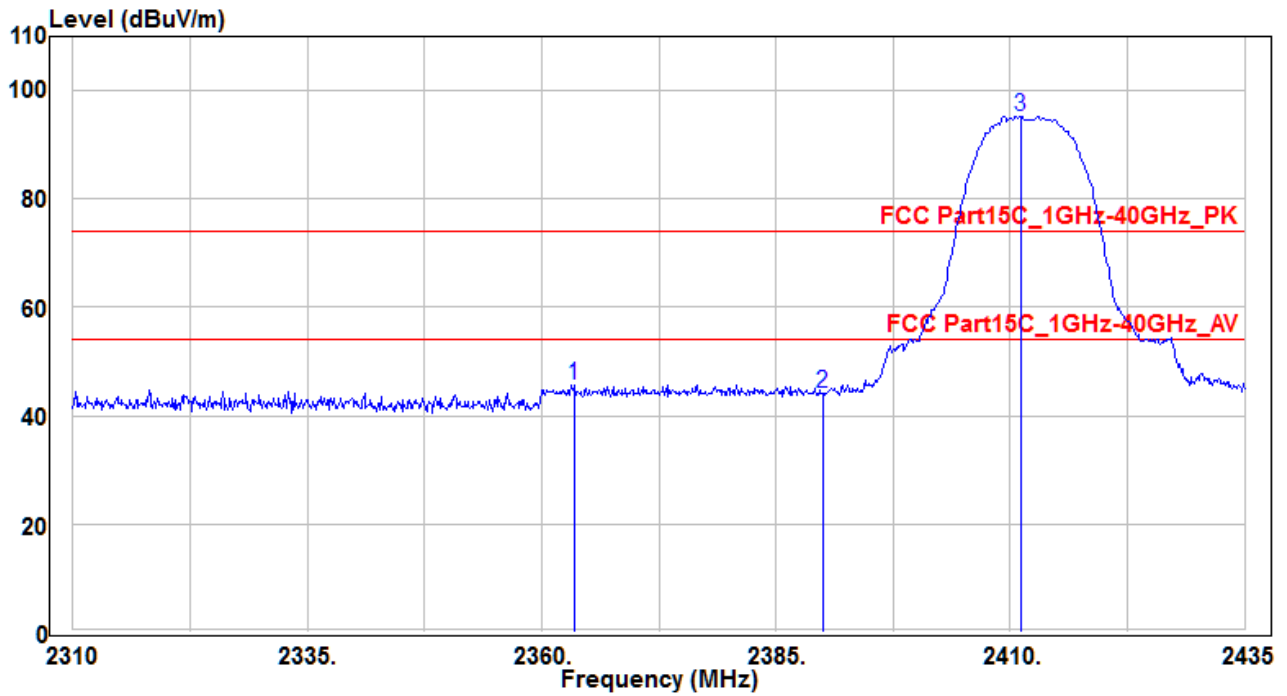

No	Frequency (MHz)	Reading (dBuV)	C.F (dB)	Measurement (dBuV/m)	Margin (dB)	Limit (dBuV)	Height (cm)	Angle (deg)	Remark (QP/PK/AV)	
1	*	2363.5	47.44	-1.77	45.67	-28.33	74	150	-30	Peak
2		2390	45.9	-1.84	44.06	-29.94	74	150	-30	Peak
3		2411.125	97.2	-1.92	95.28	21.28	74	150	-30	Peak

Note :

1. " * " means the worst value in this measurement data ◦
2. C.F (Correction Factor) = Antenna Factor (dB)+ Cable Loss (dB) – Preamplifier(dB) ◦
3. Measurement (dBuV/m) = Reading(dBuV) + C.F (Correction Factor) ◦

EUT	14249-RF2-B	Test Date	2016.10.20
Factor	BBHA 9120D (1GHz~18GHz)	Temp. / Humidity	21°C / 57%
Polarity	Vertical	Site / Engineer	AC1 / Kevin
Test Mode	MODE1-CH01	Test Voltage	By Battery

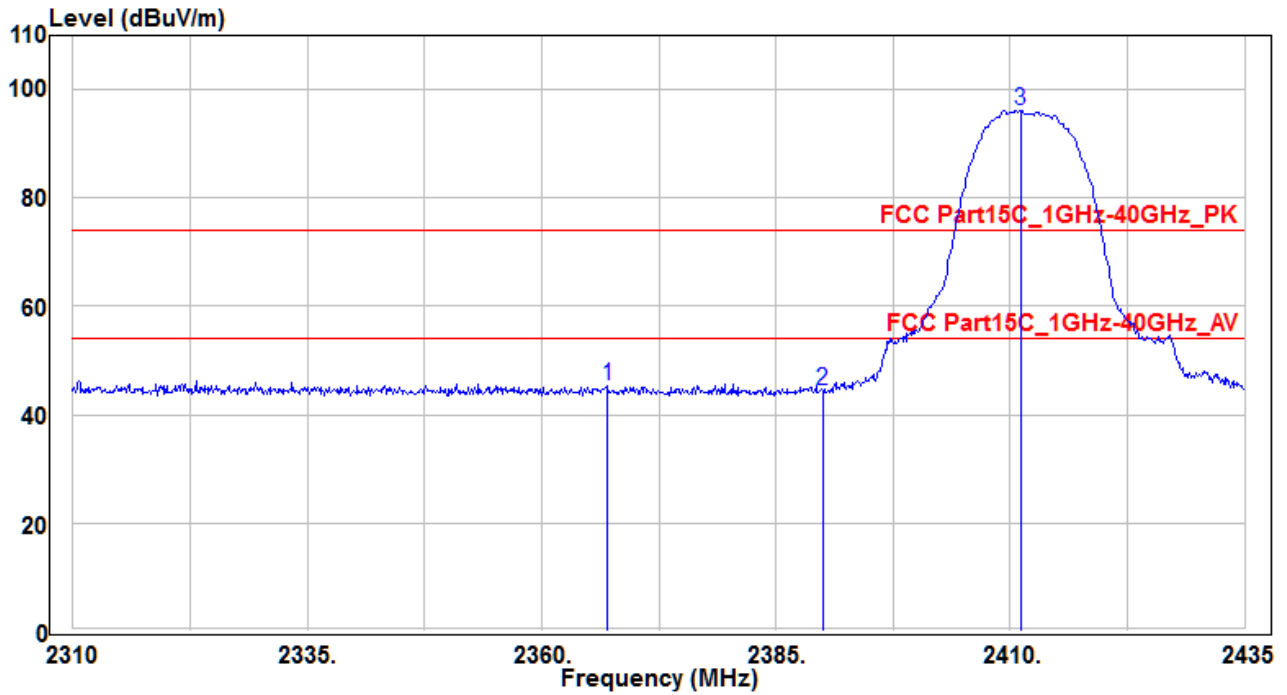

No	Frequency (MHz)	Reading (dBuV)	C.F (dB)	Measurement (dBuV/m)	Margin (dB)	Limit (dBuV)	Height (cm)	Angle (deg)	Remark (QP/PK/AV)
1	*	47.24	-1.77	45.47	-28.53	74	150	330	Peak
2		46.39	-1.84	44.55	-29.45	74	150	330	Peak
3		98.06	-1.92	96.14	22.14	74	150	330	Peak

Note :

- "*" means the worst value in this measurement data °
- C.F (Correction Factor) = Antenna Factor (dB)+ Cable Loss (dB) – Preamplifier(dB) °
- Measurement (dBuV/m) = Reading(dBuV) + C.F (Correction Factor) °

EUT	14249-RF2-B	Test Date	2016.10.20
Factor	BBHA 9120D (1GHz~18GHz)	Temp. / Humidity	21°C / 57%
Polarity	Horizontal	Site / Engineer	AC1 / Kevin
Test Mode	MODE1-CH11	Test Voltage	By Battery

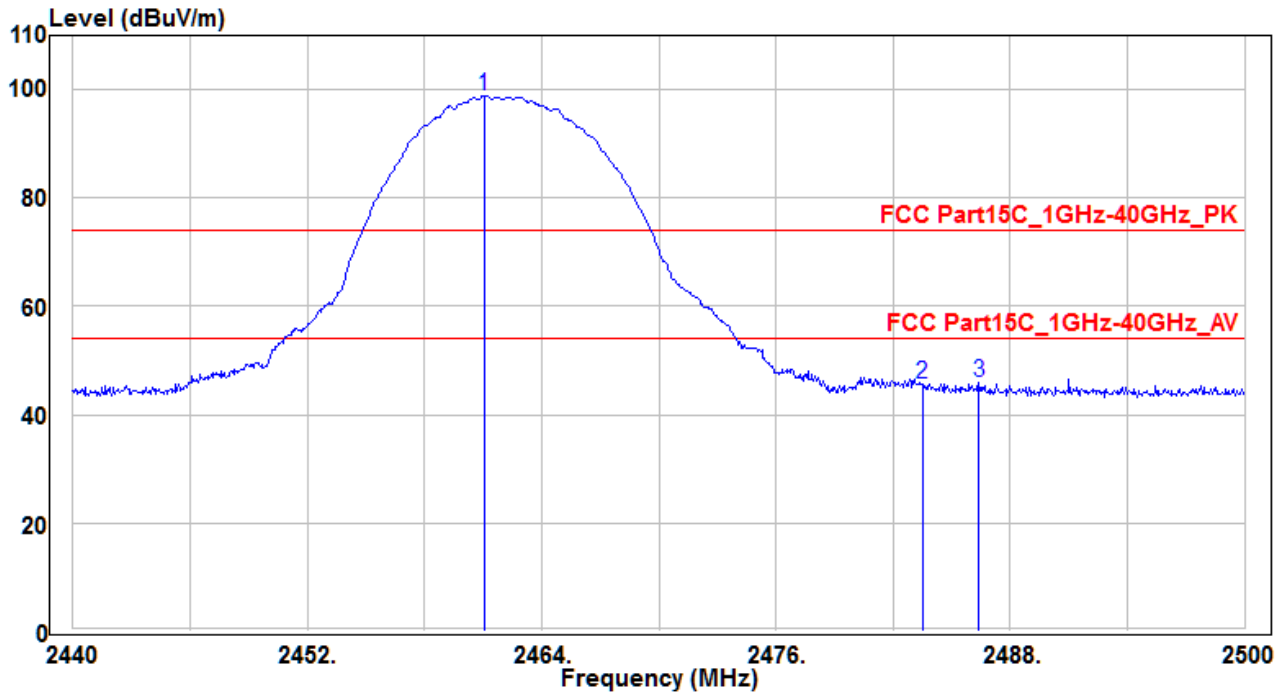

No	Frequency (MHz)	Reading (dBuV)	C.F (dB)	Measurement (dBuV/m)	Margin (dB)	Limit (dBuV)	Height (cm)	Angle (deg)	Remark (QP/PK/AV)
1	2461.06	101.01	-2.08	98.93	24.93	74	150	-15	Peak
2	2483.5	47.64	-2.08	45.56	-28.44	74	150	-15	Peak
3	* 2486.38	48.03	-2.08	45.95	-28.05	74	150	-15	Peak

Note :

- "*" means the worst value in this measurement data °
- C.F (Correction Factor) = Antenna Factor (dB)+ Cable Loss (dB) – Preamplifier(dB) °
- Measurement (dBuV/m) = Reading(dBuV) + C.F (Correction Factor) °

EUT	14249-RF2-B	Test Date	2016.10.20
Factor	BBHA 9120D (1GHz~18GHz)	Temp. / Humidity	21°C / 57%
Polarity	Vertical	Site / Engineer	AC1 / Kevin
Test Mode	MODE1-CH11	Test Voltage	By Battery

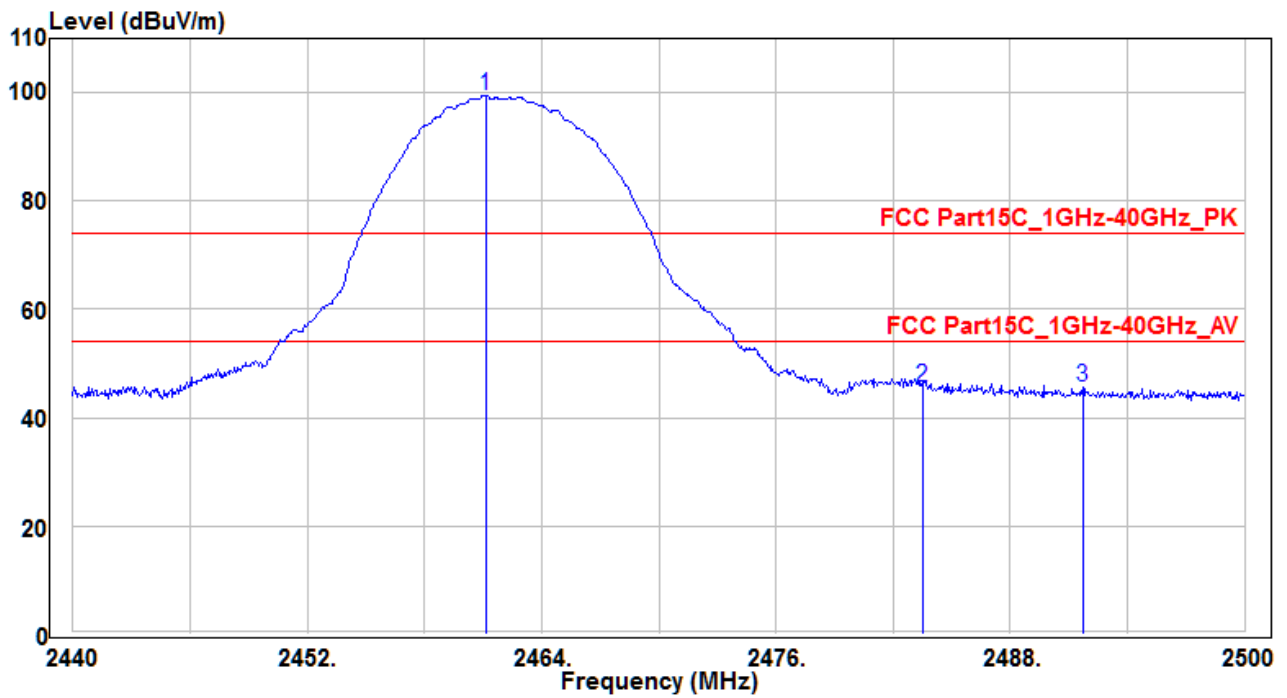

No	Frequency (MHz)	Reading (dBuV)	C.F (dB)	Measurement (dBuV/m)	Margin (dB)	Limit (dBuV)	Height (cm)	Angle (deg)	Remark (QP/PK/AV)
1	2461.12	101.6	-2.08	99.52	25.52	74	150	350	Peak
2	* 2483.5	47.73	-2.08	45.65	-28.35	74	150	350	Peak
3	2491.72	47.57	-2.07	45.5	-28.5	74	150	350	Peak

Note :

- "*" means the worst value in this measurement data °
- C.F (Correction Factor) = Antenna Factor (dB)+ Cable Loss (dB) – Preamplifier(dB) °
- Measurement (dBuV/m) = Reading(dBuV) + C.F (Correction Factor) °

EUT	14249-RF2-B	Test Date	2016.10.20
Factor	BBHA 9120D (1GHz~18GHz)	Temp. / Humidity	21°C / 57%
Polarity	Horizontal	Site / Engineer	AC1 / Kevin
Test Mode	MODE2-CH01	Test Voltage	By Battery

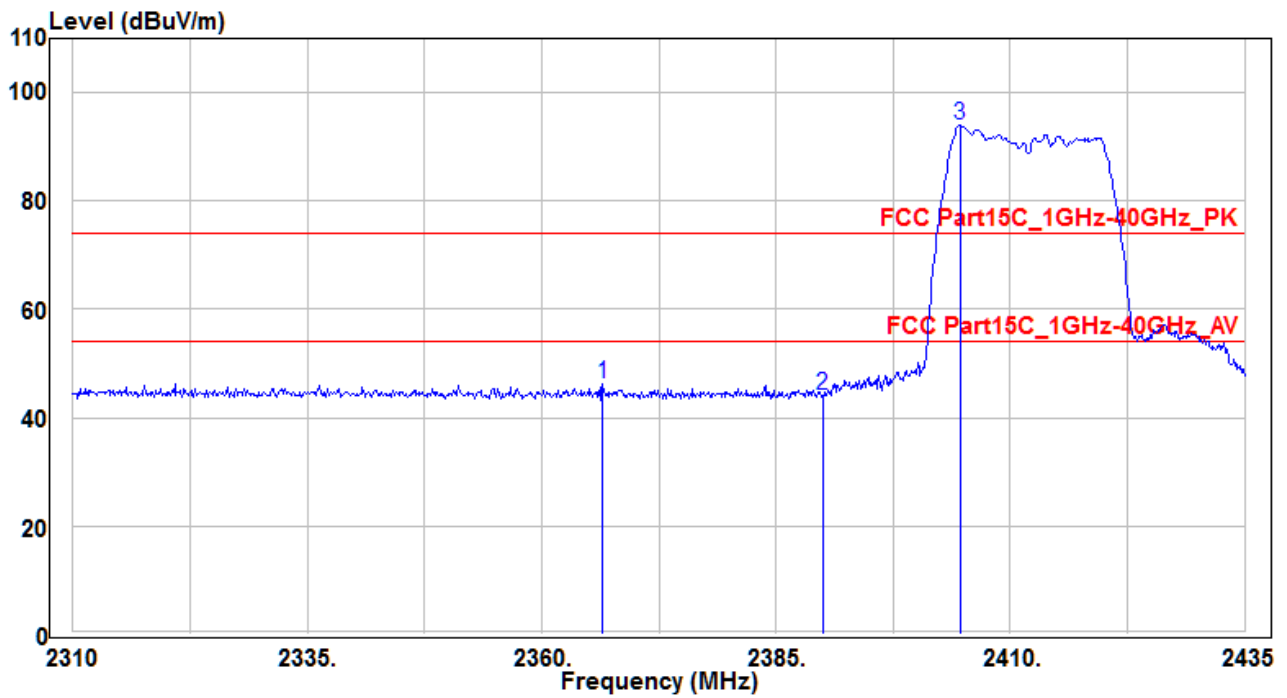

No	Frequency (MHz)	Reading (dBuV)	C.F (dB)	Measurement (dBuV/m)	Margin (dB)	Limit (dBuV)	Height (cm)	Angle (deg)	Remark (QP/PK/AV)	
1	*	2366.5	47.88	-1.77	46.11	-27.89	74	150	25	Peak
2		2390	45.96	-1.84	44.12	-29.88	74	150	25	Peak
3		2404.625	95.79	-1.88	93.91	19.91	74	150	25	Peak

Note :

- "*" means the worst value in this measurement data °
- C.F (Correction Factor) = Antenna Factor (dB)+ Cable Loss (dB) – Preamplifier(dB) °
- Measurement (dBuV/m) = Reading(dBuV) + C.F (Correction Factor) °

EUT	14249-RF2-B	Test Date	2016.10.20
Factor	BBHA 9120D (1GHz~18GHz)	Temp. / Humidity	21°C / 57%
Polarity	Vertical	Site / Engineer	AC1 / Kevin
Test Mode	MODE2-CH01	Test Voltage	By Battery

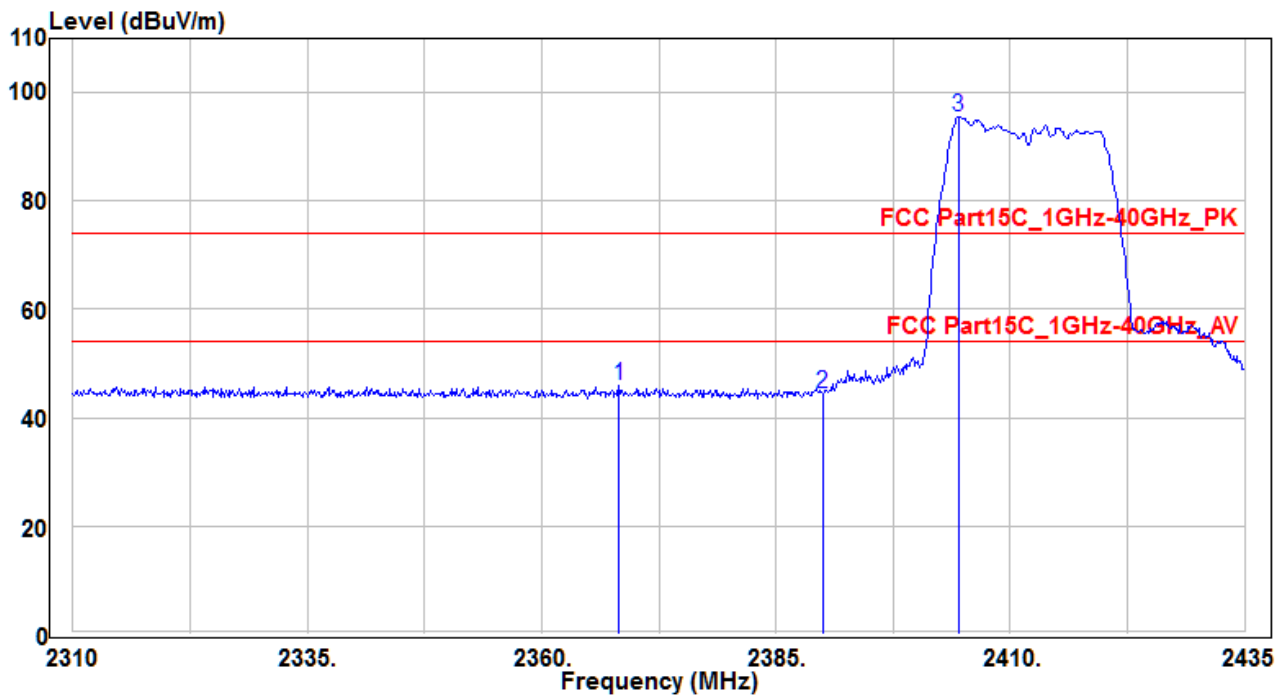

No	Frequency (MHz)	Reading (dBuV)	C.F (dB)	Measurement (dBuV/m)	Margin (dB)	Limit (dBuV)	Height (cm)	Angle (deg)	Remark (QP/PK/AV)	
1	*	2368.25	47.61	-1.79	45.82	-28.18	74	150	350	Peak
2		2390	46.25	-1.84	44.41	-29.59	74	150	350	Peak
3		2404.5	97.46	-1.88	95.58	21.58	74	150	350	Peak

Note :

- "*" means the worst value in this measurement data °
- C.F (Correction Factor) = Antenna Factor (dB)+ Cable Loss (dB) – Preamplifier(dB) °
- Measurement (dBuV/m) = Reading(dBuV) + C.F (Correction Factor) °

EUT	14249-RF2-B	Test Date	2016.10.20
Factor	BBHA 9120D (1GHz~18GHz)	Temp. / Humidity	21°C / 57%
Polarity	Horizontal	Site / Engineer	AC1 / Kevin
Test Mode	MODE2-CH11	Test Voltage	By Battery

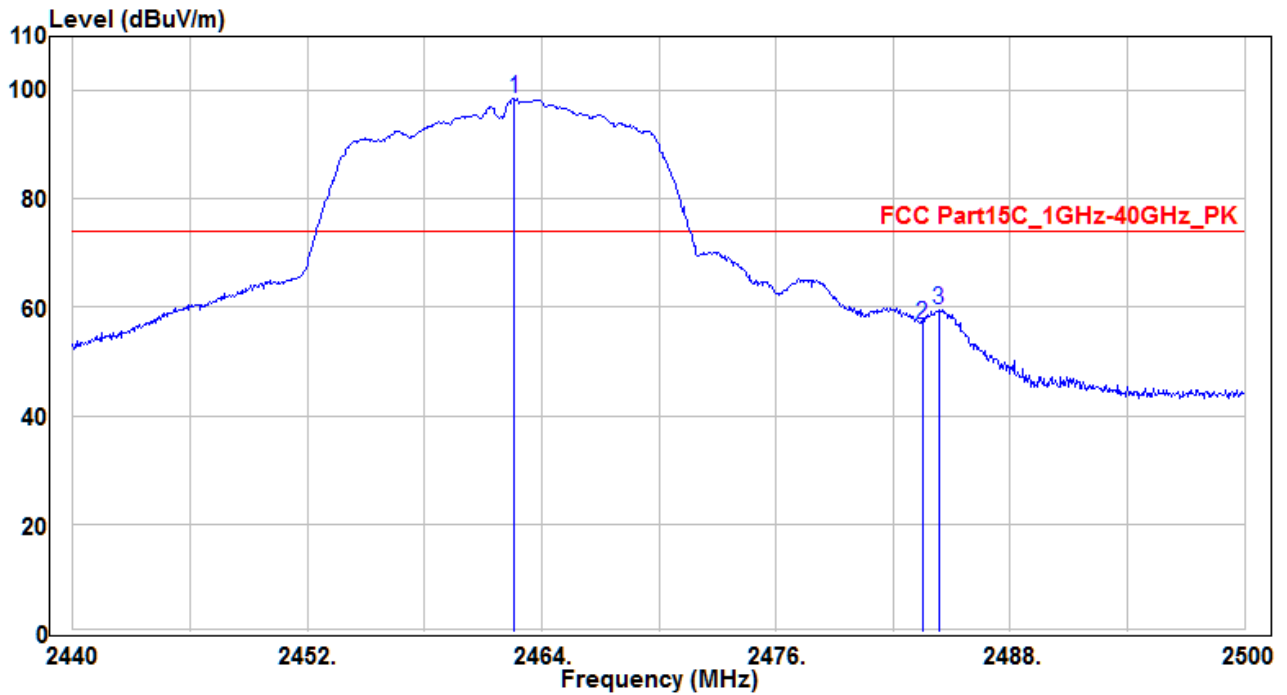

No	Frequency (MHz)	Reading (dBuV)	C.F (dB)	Measurement (dBuV/m)	Margin (dB)	Limit (dBuV)	Height (cm)	Angle (deg)	Remark (QP/PK/AV)
1	2462.62	100.61	-2.07	98.54	24.54	74	150	-30	Peak
2	2483.5	58.87	-2.08	56.79	-17.21	74	150	-30	Peak
3	* 2484.34	61.71	-2.08	59.63	-14.37	74	150	-30	Peak

Note :

1. " * " means the worst value in this measurement data °
2. C.F (Correction Factor) = Antenna Factor (dB)+ Cable Loss (dB) – Preamplifier(dB) °
3. Measurement (dBuV/m) = Reading(dBuV) + C.F (Correction Factor) °

EUT	14249-RF2-B	Test Date	2016.10.20
Factor	BBHA 9120D (1GHz~18GHz)	Temp. / Humidity	21°C / 57%
Polarity	Vertical	Site / Engineer	AC1 / Kevin
Test Mode	MODE2-CH11	Test Voltage	By Battery

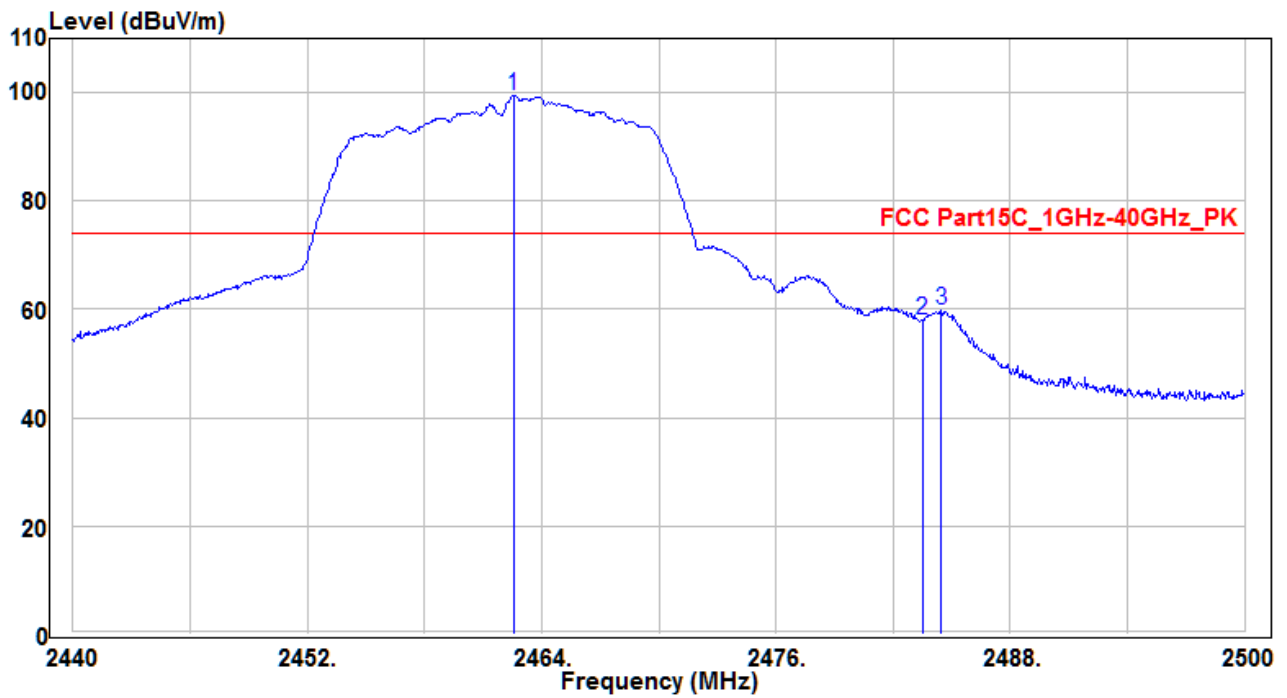

No	Frequency (MHz)	Reading (dBuV)	C.F (dB)	Measurement (dBuV/m)	Margin (dB)	Limit (dBuV)	Height (cm)	Angle (deg)	Remark (QP/PK/AV)
1	2462.56	101.49	-2.07	99.42	25.42	74	150	385	Peak
2	2483.5	59.97	-2.08	57.89	-16.11	74	150	385	Peak
3	* 2484.46	62	-2.08	59.92	-14.08	74	150	385	Peak

Note :

- "*" means the worst value in this measurement data °
- C.F (Correction Factor) = Antenna Factor (dB)+ Cable Loss (dB) – Preamplifier(dB) °
- Measurement (dBuV/m) = Reading(dBuV) + C.F (Correction Factor) °

EUT	14249-RF2-B	Test Date	2016.10.20
Factor	BBHA 9120D (1GHz~18GHz)	Temp. / Humidity	21°C / 57%
Polarity	Horizontal	Site / Engineer	AC1 / Kevin
Test Mode	MODE2-CH11	Test Voltage	By Battery

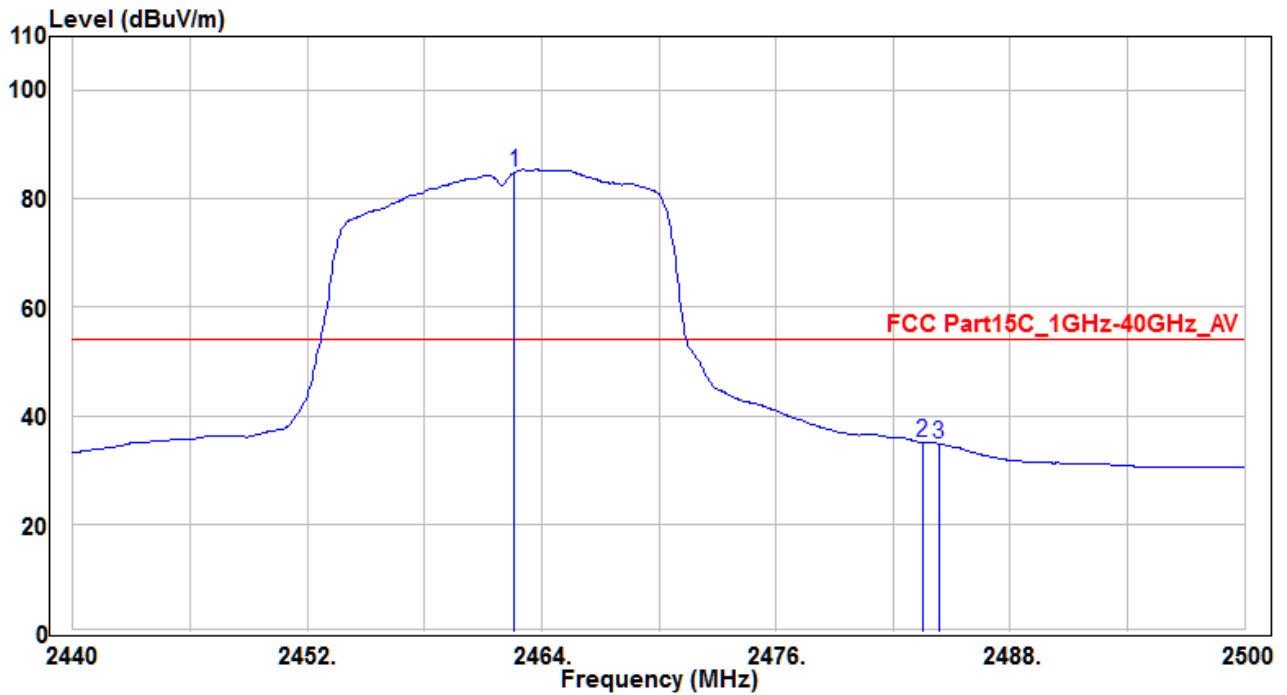

No	Frequency (MHz)	Reading (dBuV)	C.F (dB)	Measurement (dBuV/m)	Margin (dB)	Limit (dBuV)	Height (cm)	Angle (deg)	Remark (QP/PK/AV)
1	2462.62	87.03	-2.07	84.96	30.96	54	150	-30	Average
2	* 2483.5	37.11	-2.08	35.03	-18.97	54	150	-30	Average
3	2484.34	36.98	-2.08	34.9	-19.1	54	150	-30	Average

Note :

1. " * " means the worst value in this measurement data °
2. C.F (Correction Factor) = Antenna Factor (dB)+ Cable Loss (dB) – Preamplifier(dB) °
3. Measurement (dBuV/m) = Reading(dBuV) + C.F (Correction Factor) °

EUT	14249-RF2-B	Test Date	2016.10.20
Factor	BBHA 9120D (1GHz~18GHz)	Temp. / Humidity	21°C / 57%
Polarity	Vertical	Site / Engineer	AC1 / Kevin
Test Mode	MODE2-CH11	Test Voltage	By Battery

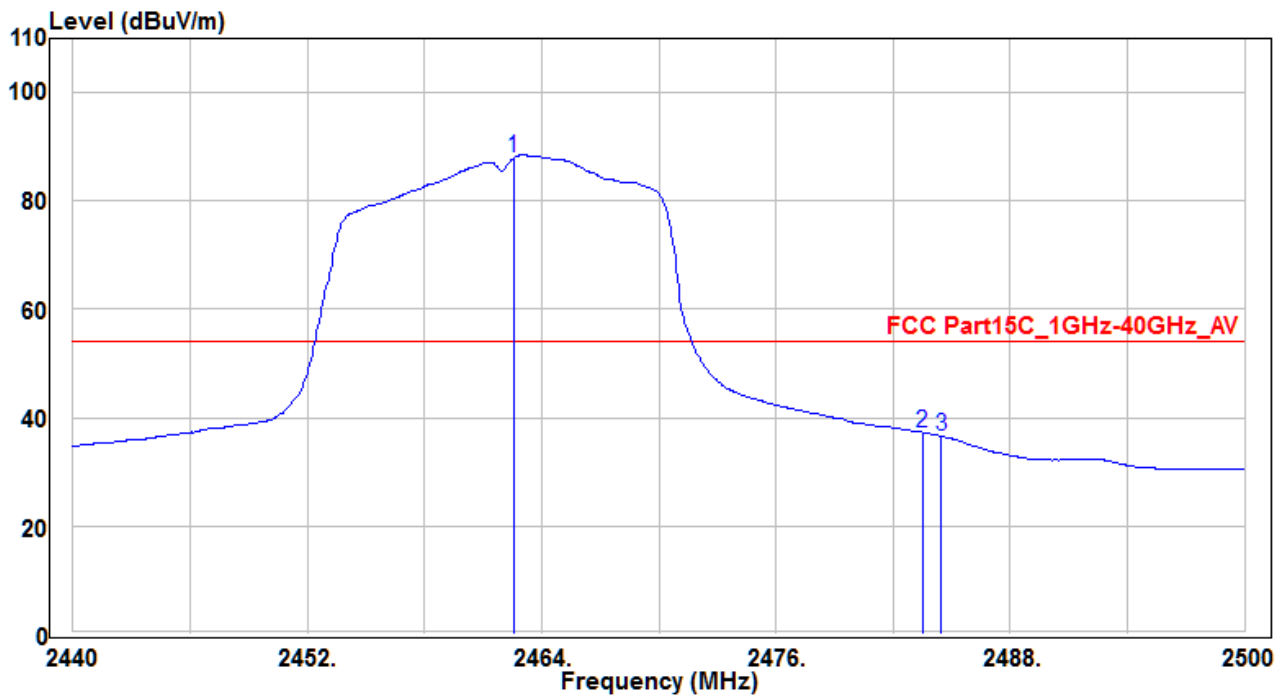

No	Frequency (MHz)	Reading (dBuV)	C.F (dB)	Measurement (dBuV/m)	Margin (dB)	Limit (dBuV)	Height (cm)	Angle (deg)	Remark (QP/PK/AV)
1	2462.56	90.03	-2.07	87.96	33.96	54	150	385	Average
2	* 2483.5	39.4	-2.08	37.32	-16.68	54	150	385	Average
3	2484.46	38.73	-2.08	36.65	-17.35	54	150	385	Average

Note :

- "*" means the worst value in this measurement data °
- C.F (Correction Factor) = Antenna Factor (dB)+ Cable Loss (dB) – Preamplifier(dB) °
- Measurement (dBuV/m) = Reading(dBuV) + C.F (Correction Factor) °

EUT	14249-RF2-B	Test Date	2016.10.20
Factor	BBHA 9120D (1GHz~18GHz)	Temp. / Humidity	21°C / 57%
Polarity	Horizontal	Site / Engineer	AC1 / Kevin
Test Mode	MODE3-CH01	Test Voltage	By Battery

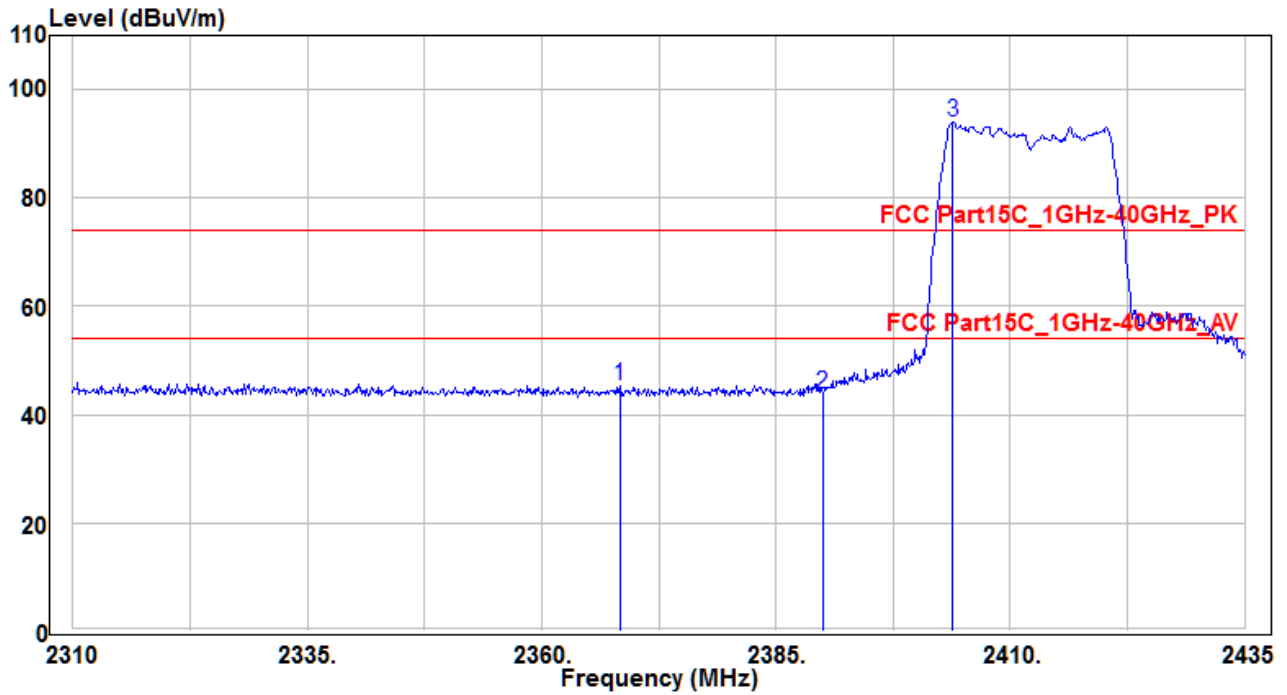

No		Frequency (MHz)	Reading (dBuV)	C.F (dB)	Measurement (dBuV/m)	Margin (dB)	Limit (dBuV)	Height (cm)	Angle (deg)	Remark (QP/PK/AV)
1	*	2368.375	47.27	-1.79	45.48	-28.52	74	150	25	Peak
2		2390	45.71	-1.84	43.87	-30.13	74	150	25	Peak
3		2403.875	95.99	-1.89	94.1	20.1	74	150	25	Peak

Note :

- "*" means the worst value in this measurement data °
- C.F (Correction Factor) = Antenna Factor (dB)+ Cable Loss (dB) – Preamplifier(dB) °
- Measurement (dBuV/m) = Reading(dBuV) + C.F (Correction Factor) °

EUT	14249-RF2-B	Test Date	2016.10.20
Factor	BBHA 9120D (1GHz~18GHz)	Temp. / Humidity	21°C / 57%
Polarity	Vertical	Site / Engineer	AC1 / Kevin
Test Mode	MODE3-CH01	Test Voltage	By Battery

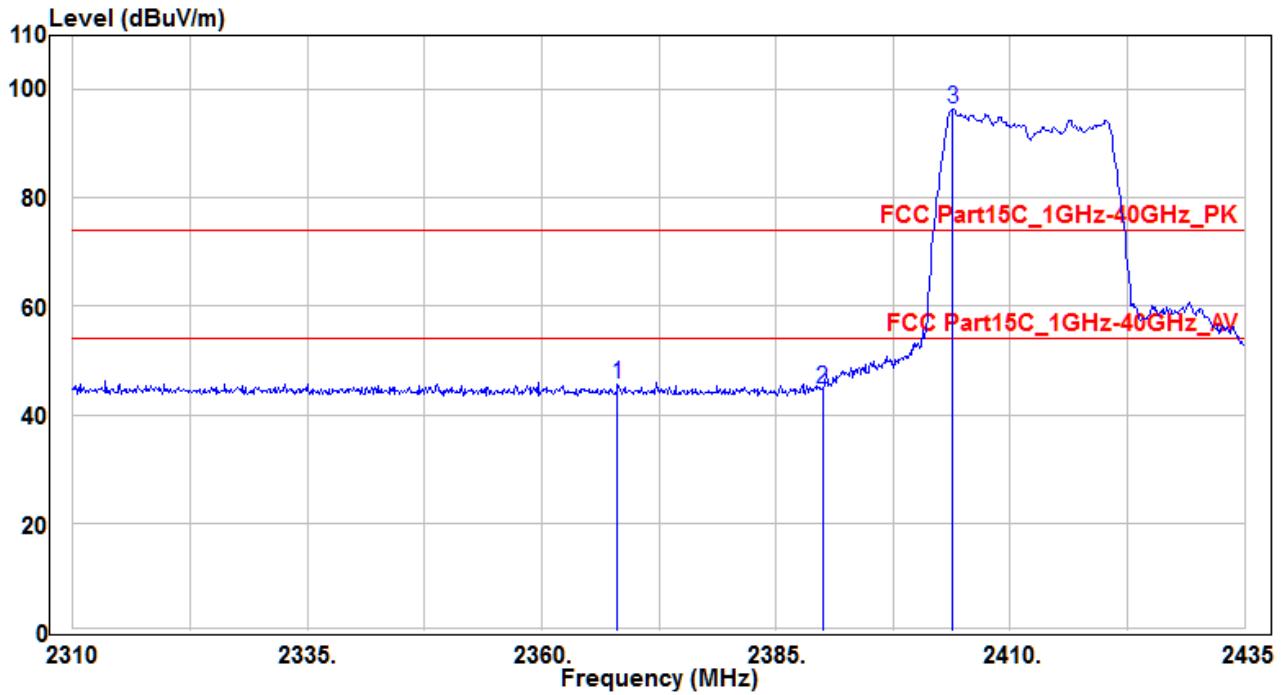

No		Frequency (MHz)	Reading (dBuV)	C.F (dB)	Measurement (dBuV/m)	Margin (dB)	Limit (dBuV)	Height (cm)	Angle (deg)	Remark (QP/PK/AV)
1	*	2368.125	47.43	-1.79	45.64	-28.36	74	150	330	Peak
2		2390	46.54	-1.84	44.7	-29.3	74	150	330	Peak
3		2403.875	98.3	-1.89	96.41	22.41	74	150	330	Peak

Note :

- "*" means the worst value in this measurement data °
- C.F (Correction Factor) = Antenna Factor (dB)+ Cable Loss (dB) – Preamplifier(dB) °
- Measurement (dBuV/m) = Reading(dBuV) + C.F (Correction Factor) °

EUT	14249-RF2-B	Test Date	2016.10.20
Factor	BBHA 9120D (1GHz~18GHz)	Temp. / Humidity	21°C / 57%
Polarity	Horizontal	Site / Engineer	AC1 / Kevin
Test Mode	MODE3-CH11	Test Voltage	By Battery

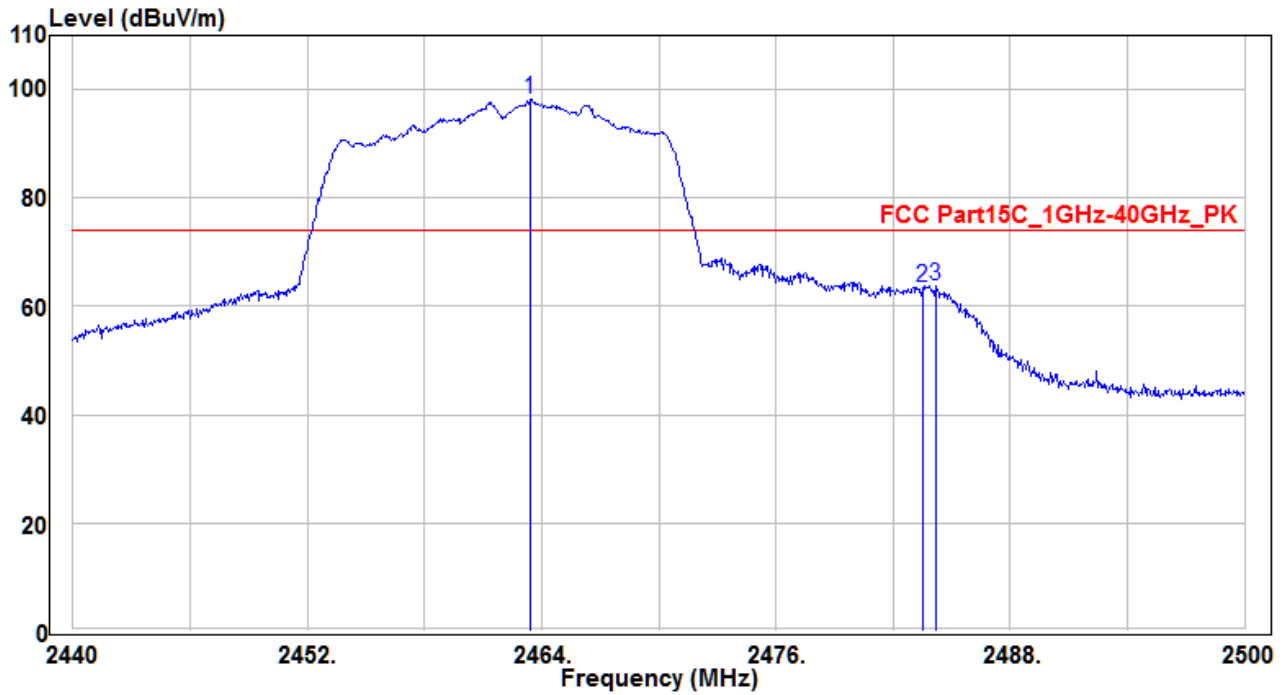

No	Frequency (MHz)	Reading (dBuV)	C.F (dB)	Measurement (dBuV/m)	Margin (dB)	Limit (dBuV)	Height (cm)	Angle (deg)	Remark (QP/PK/AV)
1	2463.4	100.31	-2.07	98.24	24.24	74	150	25	Peak
2	2483.5	65.64	-2.08	63.56	-10.44	74	150	25	Peak
3	* 2484.16	65.81	-2.08	63.73	-10.27	74	150	25	Peak

Note :

- "*" means the worst value in this measurement data °
- C.F (Correction Factor) = Antenna Factor (dB)+ Cable Loss (dB) – Preamplifier(dB) °
- Measurement (dBuV/m) = Reading(dBuV) + C.F (Correction Factor) °

EUT	14249-RF2-B	Test Date	2016.10.20
Factor	BBHA 9120D (1GHz~18GHz)	Temp. / Humidity	21°C / 57%
Polarity	Vertical	Site / Engineer	AC1 / Kevin
Test Mode	MODE3-CH11	Test Voltage	By Battery

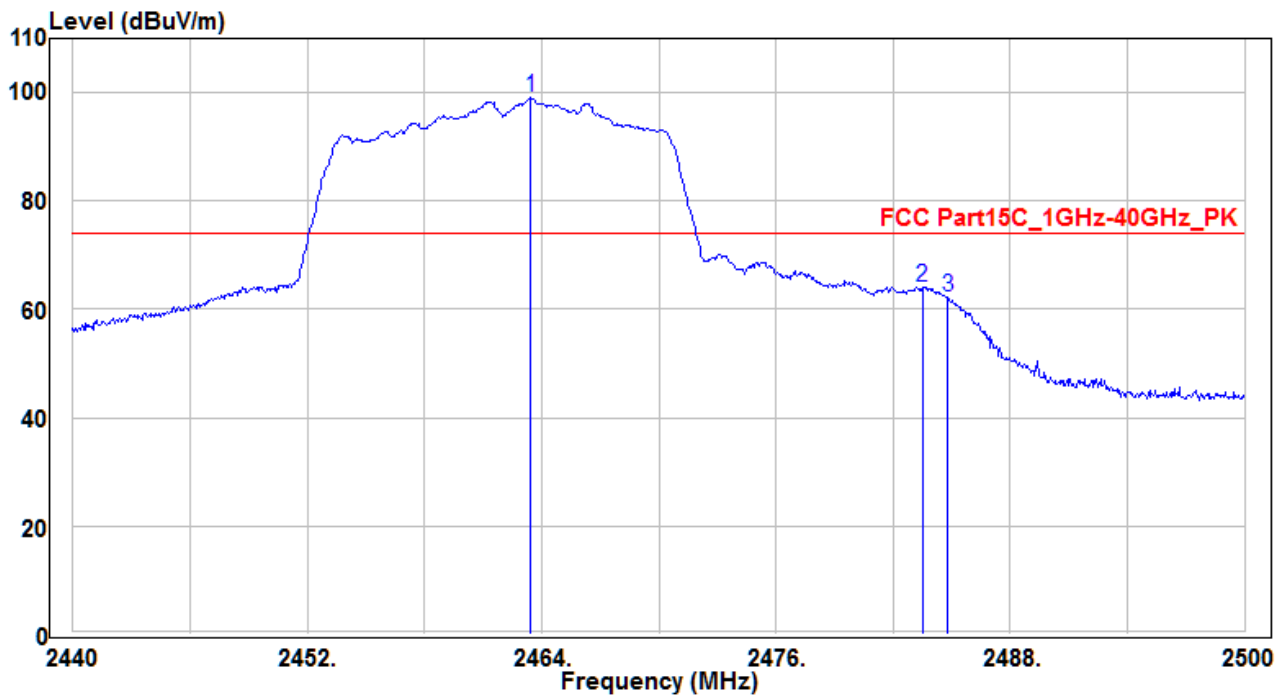

No	Frequency (MHz)	Reading (dBuV)	C.F (dB)	Measurement (dBuV/m)	Margin (dB)	Limit (dBuV)	Height (cm)	Angle (deg)	Remark (QP/PK/AV)
1	2463.46	101.1	-2.07	99.03	25.03	74	150	315	Peak
2	* 2483.5	66.14	-2.08	64.06	-9.94	74	150	315	Peak
3	2484.82	64.31	-2.08	62.23	-11.77	74	150	315	Peak

Note :

- "*" means the worst value in this measurement data °
- C.F (Correction Factor) = Antenna Factor (dB)+ Cable Loss (dB) – Preamplifier(dB) °
- Measurement (dBuV/m) = Reading(dBuV) + C.F (Correction Factor) °

EUT	14249-RF2-B	Test Date	2016.10.20
Factor	BBHA 9120D (1GHz~18GHz)	Temp. / Humidity	21°C / 57%
Polarity	Horizontal	Site / Engineer	AC1 / Kevin
Test Mode	MODE3-CH11	Test Voltage	By Battery

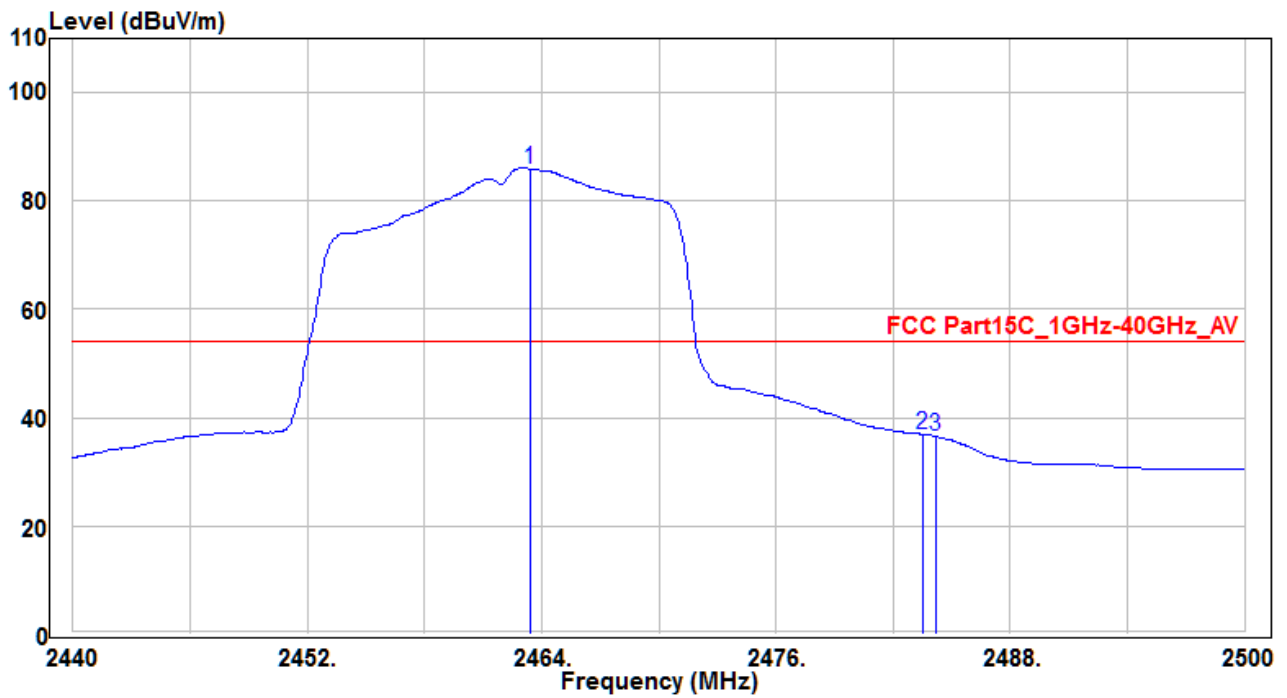

No	Frequency (MHz)	Reading (dBuV)	C.F (dB)	Measurement (dBuV/m)	Margin (dB)	Limit (dBuV)	Height (cm)	Angle (deg)	Remark (QP/PK/AV)
1	2463.4	88.01	-2.07	85.94	31.94	54	150	25	Average
2	* 2483.5	39.05	-2.08	36.97	-17.03	54	150	25	Average
3	2484.16	38.66	-2.08	36.58	-17.42	54	150	25	Average

Note :

- "*" means the worst value in this measurement data °
- C.F (Correction Factor) = Antenna Factor (dB)+ Cable Loss (dB) – Preamplifier(dB) °
- Measurement (dBuV/m) = Reading(dBuV) + C.F (Correction Factor) °

EUT	14249-RF2-B	Test Date	2016.10.20
Factor	BBHA 9120D (1GHz~18GHz)	Temp. / Humidity	21°C / 57%
Polarity	Vertical	Site / Engineer	AC1 / Kevin
Test Mode	MODE3-CH11	Test Voltage	By Battery

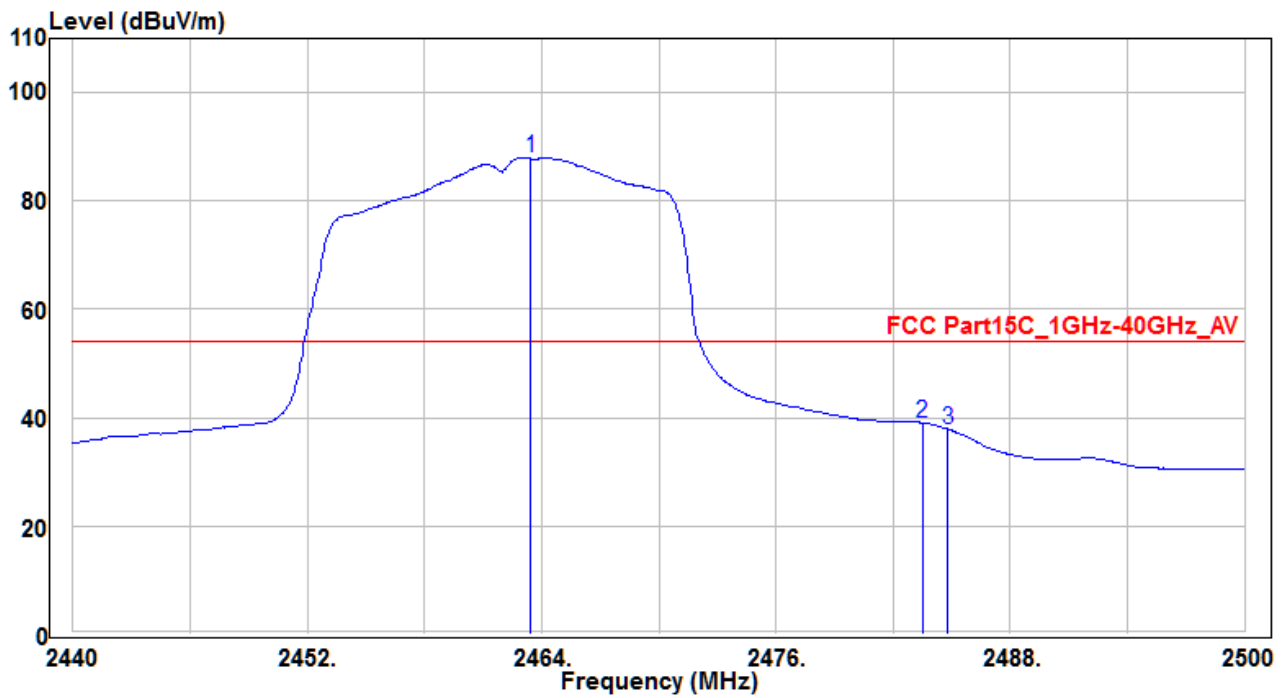

No	Frequency (MHz)	Reading (dBuV)	C.F (dB)	Measurement (dBuV/m)	Margin (dB)	Limit (dBuV)	Height (cm)	Angle (deg)	Remark (QP/PK/AV)
1	2463.46	89.88	-2.07	87.81	33.81	54	150	315	Average
2	* 2483.5	41.15	-2.08	39.07	-14.93	54	150	315	Average
3	2484.82	39.96	-2.08	37.88	-16.12	54	150	315	Average

Note :

- "*" means the worst value in this measurement data °
- C.F (Correction Factor) = Antenna Factor (dB)+ Cable Loss (dB) – Preamplifier(dB) °
- Measurement (dBuV/m) = Reading(dBuV) + C.F (Correction Factor) °

EUT	14249-RF2-B	Test Date	2016.10.20
Factor	BBHA 9120D (1GHz~18GHz)	Temp. / Humidity	21°C / 57%
Polarity	Horizontal	Site / Engineer	AC1 / Kevin
Test Mode	MODE4-CH03	Test Voltage	By Battery

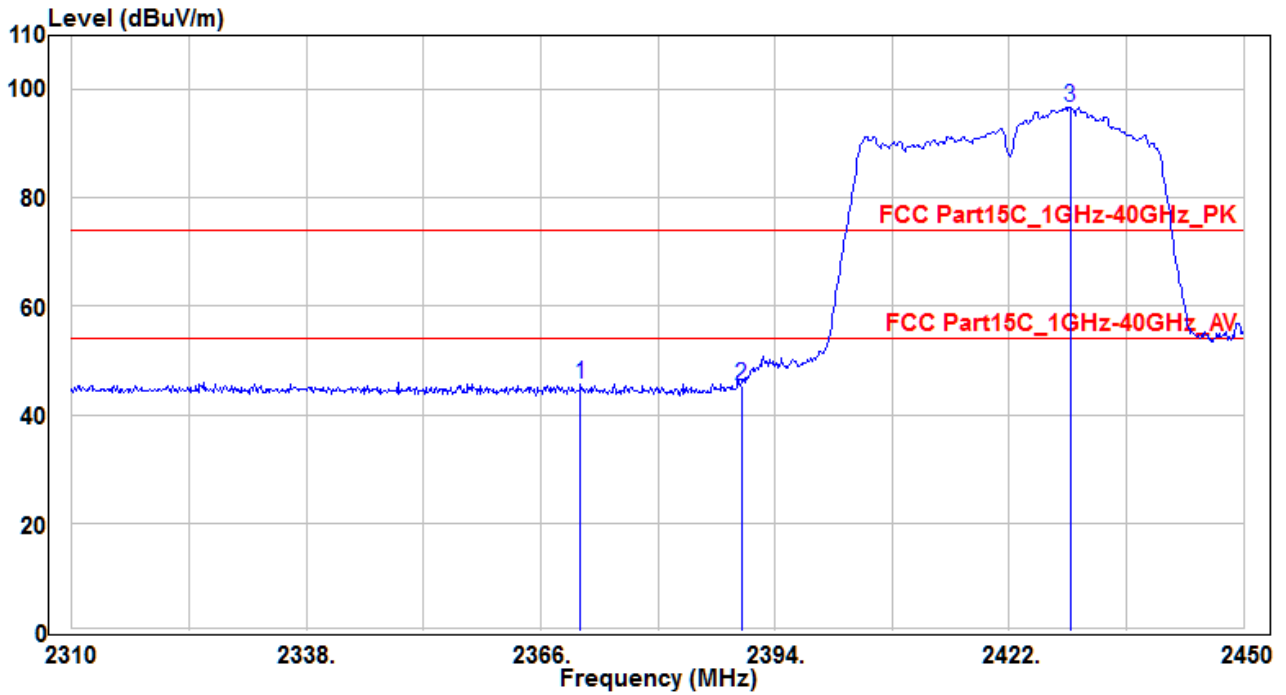

No	Frequency (MHz)	Reading (dBuV)	C.F (dB)	Measurement (dBuV/m)	Margin (dB)	Limit (dBuV)	Height (cm)	Angle (deg)	Remark (QP/PK/AV)
1	* 2370.76	47.29	-1.79	45.5	-28.5	74	150	-25	Peak
2	2390	47.26	-1.84	45.42	-28.58	74	150	-25	Peak
3	2429.28	98.82	-1.98	96.84	22.84	74	150	-25	Peak

Note :

- "*" means the worst value in this measurement data °
- C.F (Correction Factor) = Antenna Factor (dB)+ Cable Loss (dB) – Preamplifier(dB) °
- Measurement (dBuV/m) = Reading(dBuV) + C.F (Correction Factor) °

EUT	14249-RF2-B	Test Date	2016.10.20
Factor	BBHA 9120D (1GHz~18GHz)	Temp. / Humidity	21°C / 57%
Polarity	Vertical	Site / Engineer	AC1 / Kevin
Test Mode	MODE4-CH03	Test Voltage	By Battery

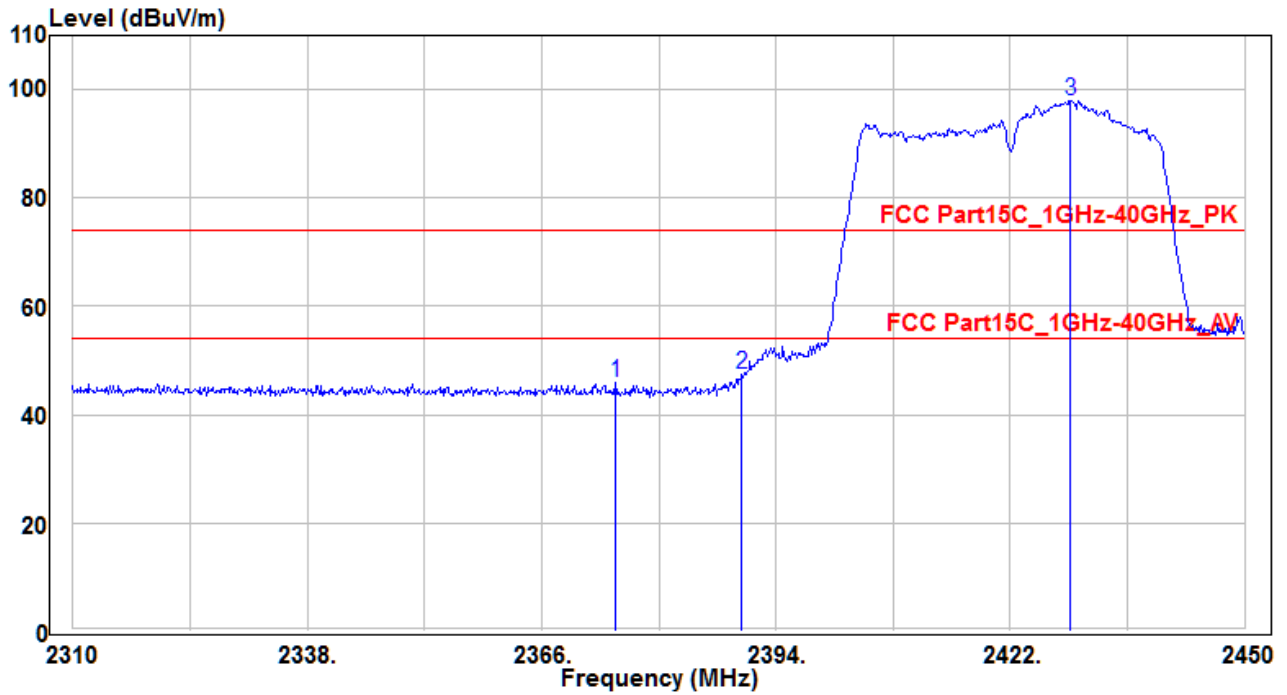

No	Frequency (MHz)	Reading (dBuV)	C.F (dB)	Measurement (dBuV/m)	Margin (dB)	Limit (dBuV)	Height (cm)	Angle (deg)	Remark (QP/PK/AV)
1	2374.82	47.79	-1.79	46	-28	74	150	390	Peak
2	* 2389.94	49.16	-1.84	47.32	-26.68	74	150	390	Peak
3	2429.14	100.04	-1.99	98.05	24.05	74	150	390	Peak

Note :

- "*" means the worst value in this measurement data °
- C.F (Correction Factor) = Antenna Factor (dB)+ Cable Loss (dB) – Preamplifier(dB) °
- Measurement (dBuV/m) = Reading(dBuV) + C.F (Correction Factor) °

EUT	14249-RF2-B	Test Date	2016.10.20
Factor	BBHA 9120D (1GHz~18GHz)	Temp. / Humidity	21°C / 57%
Polarity	Horizontal	Site / Engineer	AC1 / Kevin
Test Mode	MODE4-CH09	Test Voltage	By Battery

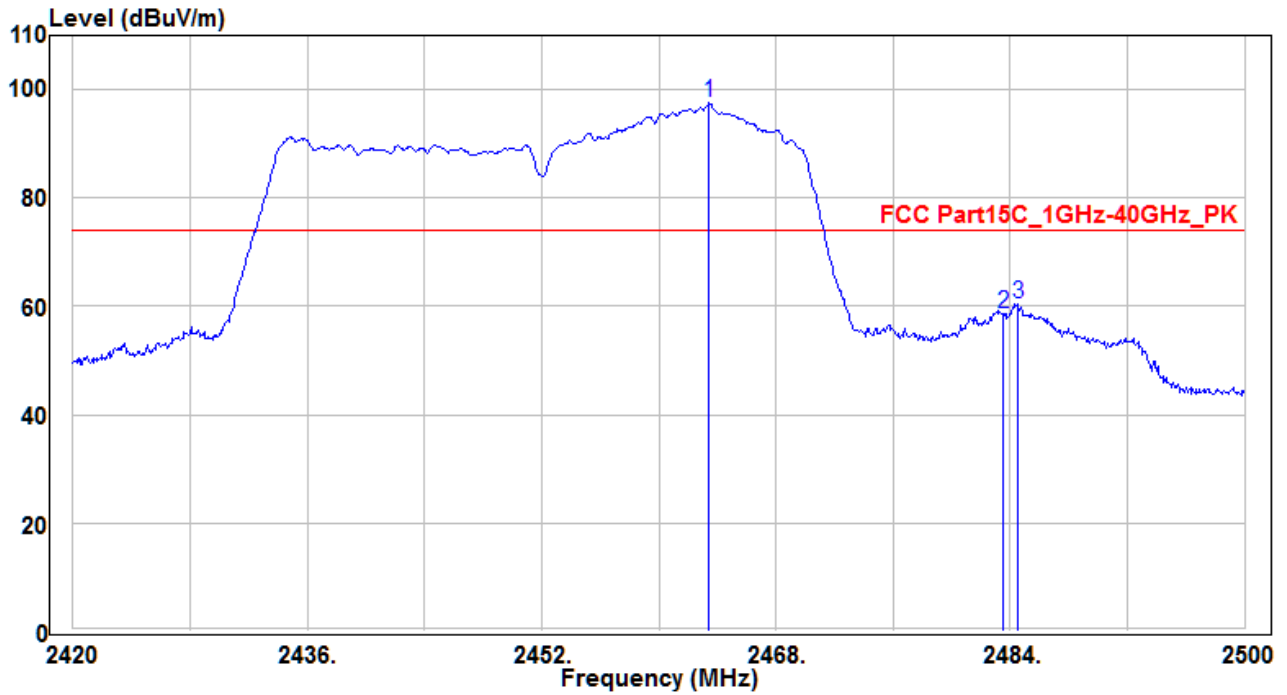

No	Frequency (MHz)	Reading (dBuV)	C.F (dB)	Measurement (dBuV/m)	Margin (dB)	Limit (dBuV)	Height (cm)	Angle (deg)	Remark (QP/PK/AV)
1	2463.44	99.58	-2.07	97.51	23.51	74	150	295	Peak
2	2483.52	60.73	-2.08	58.65	-15.35	74	150	295	Peak
3	* 2484.56	62.64	-2.08	60.56	-13.44	74	150	295	Peak

Note :

- "*" means the worst value in this measurement data °
- C.F (Correction Factor) = Antenna Factor (dB)+ Cable Loss (dB) – Preamplifier(dB) °
- Measurement (dBuV/m) = Reading(dBuV) + C.F (Correction Factor) °

EUT	14249-RF2-B	Test Date	2016.10.20
Factor	BBHA 9120D (1GHz~18GHz)	Temp. / Humidity	21°C / 57%
Polarity	Vertical	Site / Engineer	AC1 / Kevin
Test Mode	MODE4-CH09	Test Voltage	By Battery

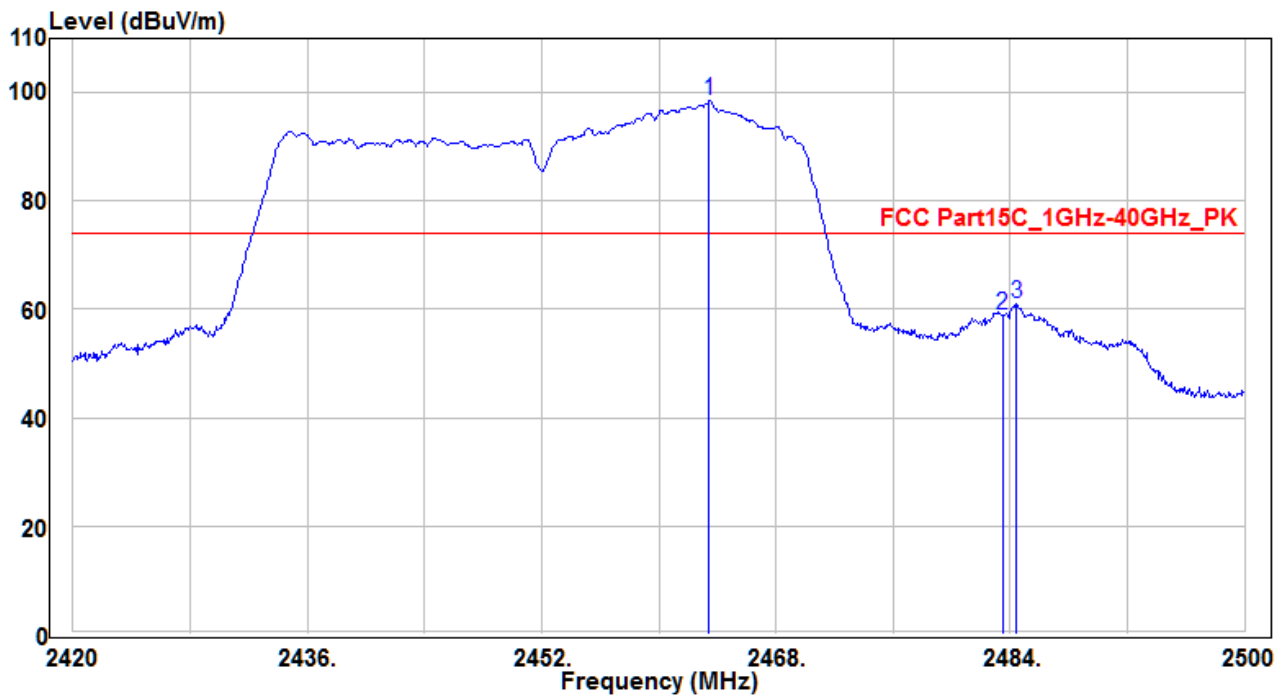

No	Frequency (MHz)	Reading (dBuV)	C.F (dB)	Measurement (dBuV/m)	Margin (dB)	Limit (dBuV)	Height (cm)	Angle (deg)	Remark (QP/PK/AV)
1	2463.44	100.52	-2.07	98.45	24.45	74	150	355	Peak
2	2483.5	61.02	-2.08	58.94	-15.06	74	150	355	Peak
3	* 2484.4	63.18	-2.08	61.1	-12.9	74	150	355	Peak

Note :

- "*" means the worst value in this measurement data °
- C.F (Correction Factor) = Antenna Factor (dB)+ Cable Loss (dB) – Preamplifier(dB) °
- Measurement (dBuV/m) = Reading(dBuV) + C.F (Correction Factor) °

EUT	14249-RF2-B	Test Date	2016.10.20
Factor	BBHA 9120D (1GHz~18GHz)	Temp. / Humidity	21°C / 57%
Polarity	Horizontal	Site / Engineer	AC1 / Kevin
Test Mode	MODE4-CH09	Test Voltage	By Battery

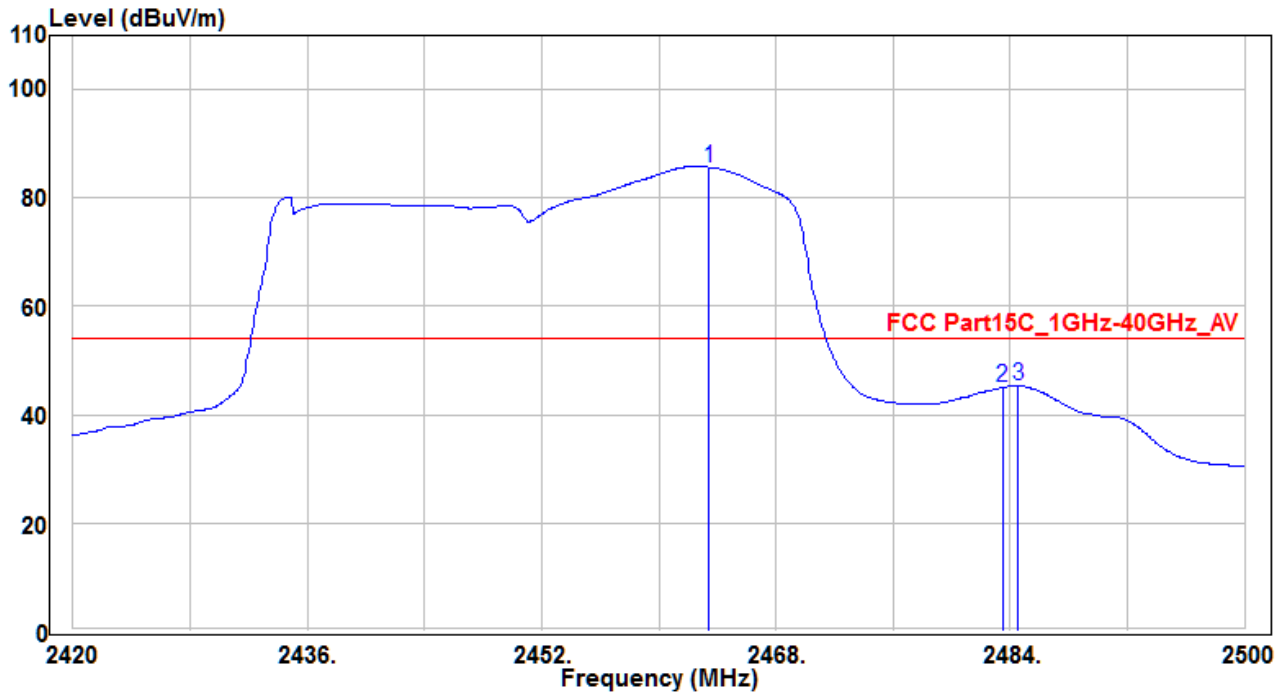

No	Frequency (MHz)	Reading (dBuV)	C.F (dB)	Measurement (dBuV/m)	Margin (dB)	Limit (dBuV)	Height (cm)	Angle (deg)	Remark (QP/PK/AV)
1	2463.44	87.69	-2.07	85.62	31.62	54	150	295	Average
2	2483.5	47.13	-2.08	45.05	-8.95	54	150	295	Average
3	* 2484.56	47.47	-2.08	45.39	-8.61	54	150	295	Average

Note :

- "*" means the worst value in this measurement data °
- C.F (Correction Factor) = Antenna Factor (dB)+ Cable Loss (dB) – Preamplifier(dB) °
- Measurement (dBuV/m) = Reading(dBuV) + C.F (Correction Factor) °

EUT	14249-RF2-B	Test Date	2016.10.20
Factor	BBHA 9120D (1GHz~18GHz)	Temp. / Humidity	21°C / 57%
Polarity	Vertical	Site / Engineer	AC1 / Kevin
Test Mode	MODE4-CH09	Test Voltage	By Battery

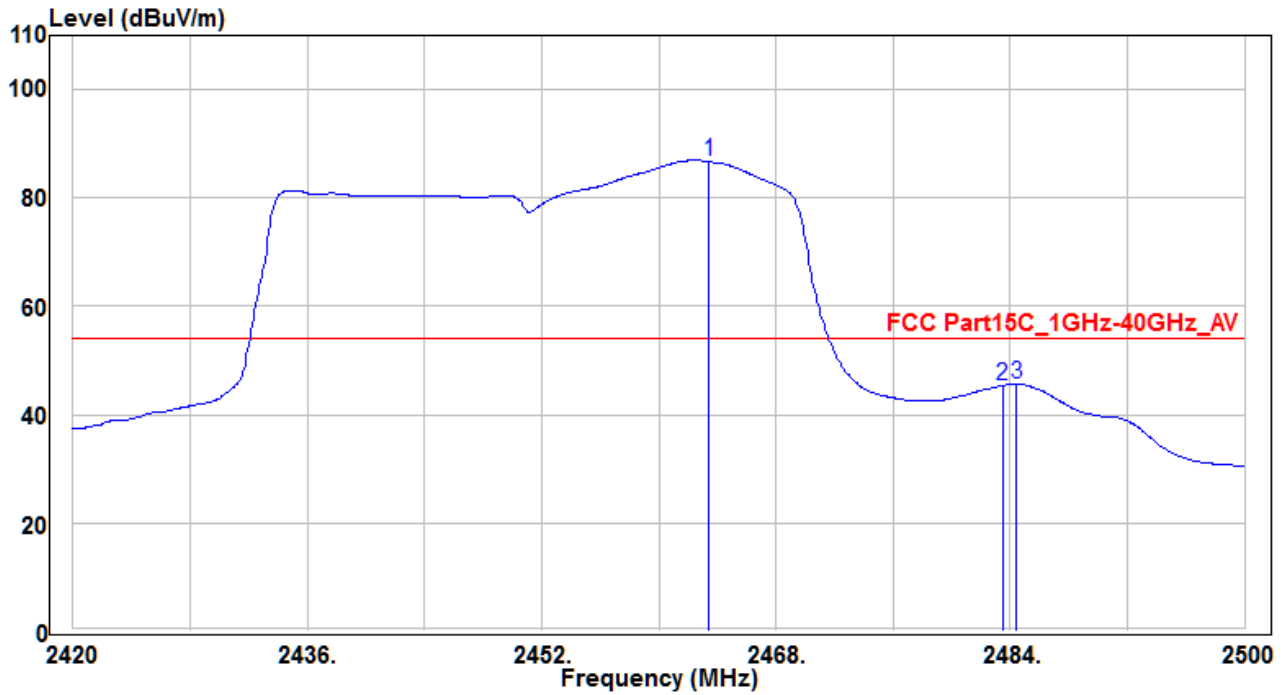

No	Frequency (MHz)	Reading (dBuV)	C.F (dB)	Measurement (dBuV/m)	Margin (dB)	Limit (dBuV)	Height (cm)	Angle (deg)	Remark (QP/PK/AV)
1	2463.44	88.78	-2.07	86.71	32.71	54	150	355	Average
2	2483.5	47.5	-2.08	45.42	-8.58	54	150	355	Average
3	* 2484.4	47.84	-2.08	45.76	-8.24	54	150	355	Average

Note :

- "*" means the worst value in this measurement data °
- C.F (Correction Factor) = Antenna Factor (dB)+ Cable Loss (dB) – Preamplifier(dB) °
- Measurement (dBuV/m) = Reading(dBuV) + C.F (Correction Factor) °

7.8. AC Conducted Emissions Measurement

7.8.1. Test Limit

FCC Part 15 Subpart C Paragraph 15.207 / RSS-Gen Limits		
Frequency (MHz)	QP (dB μ V)	Average (dB μ V)
0.15 - 0.50	66 - 56	56 - 46
0.50 - 5.0	56	46
5.0 - 30	60	50

Note 1: The lower limit shall apply at the transition frequencies.

Note 2: The limit decreases linearly with the logarithm of the frequency in the range 0.15MHz to 0.5MHz.

7.8.2. Test Setup

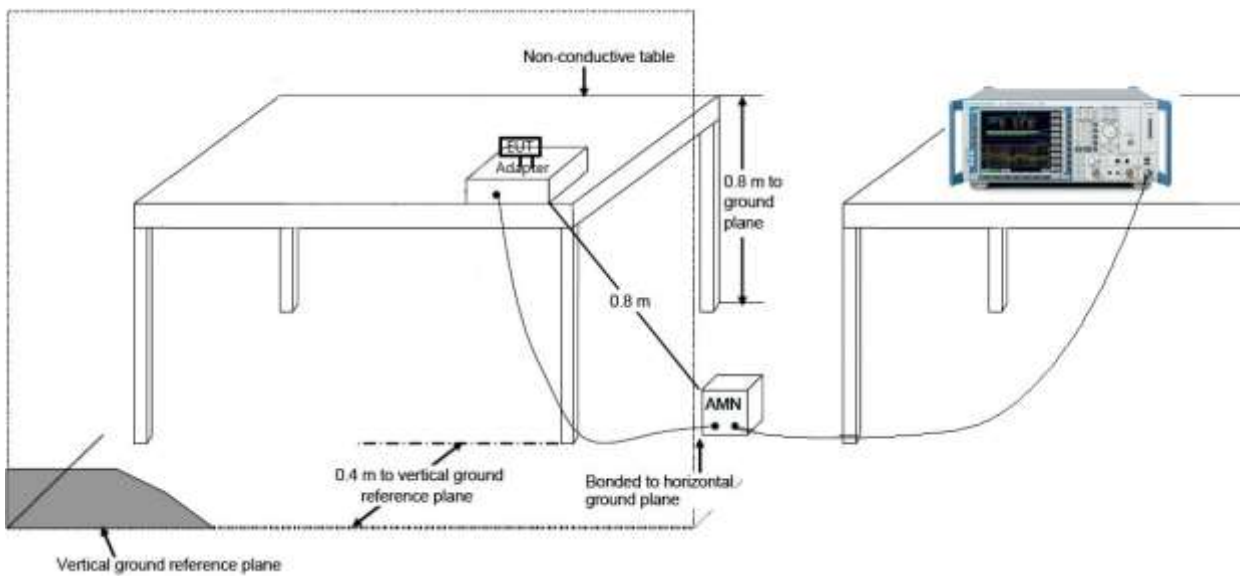

7.8.3. Test Result

EUT	14249-RF2-B	Test Date	2016.10.24
Factor	CE_ENV216-L1 (Filter ON)	Temp. / Humidity	24°C / 55%
Polarity	Line1	Site / Engineer	SR2 / Kevin
Test Mode	MODE1	Test Voltage	AC120V/60Hz(By NB)

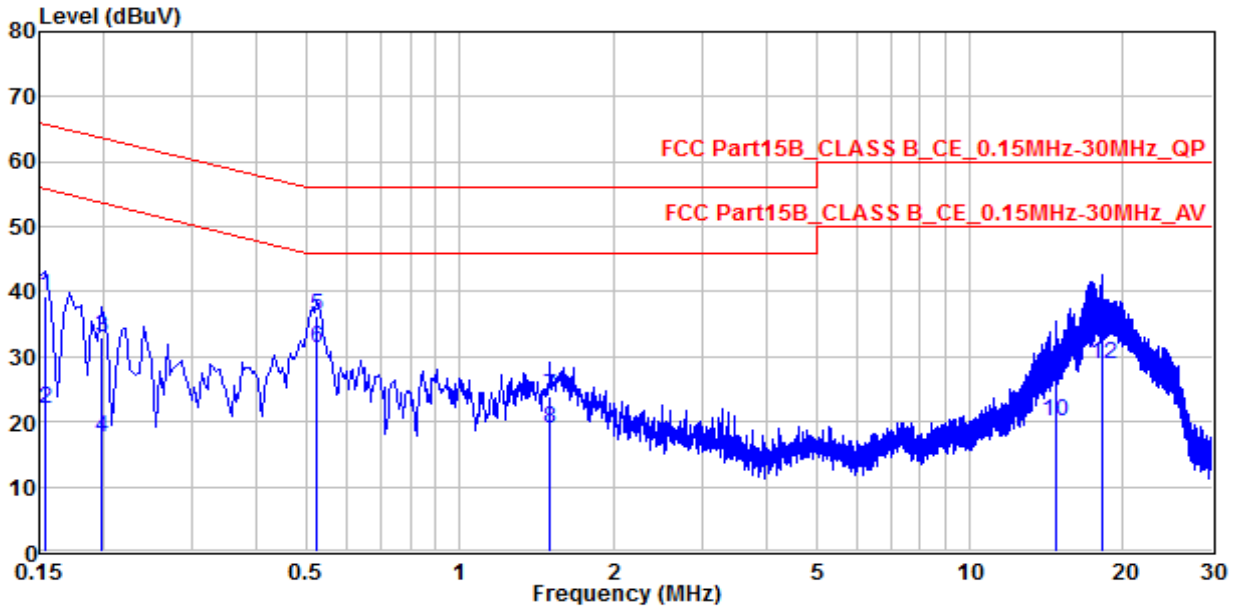

No	Frequency (MHz)	Reading (dBuV)	C.F (dB)	Measurement (dBuV)	Margin (dB)	Limit (dBuV)	Remark (QP/PK/AV)
1	0.1545	29.31	9.93	39.24	-26.51	65.75	QP
2	0.1545	11.99	9.93	21.92	-33.83	55.75	Average
3	0.1995	23.12	9.93	33.05	-30.58	63.63	QP
4	0.1995	7.54	9.93	17.47	-36.16	53.63	Average
5	* 0.52346	26.06	10.11	36.17	-19.83	56	QP
6	* 0.52346	21.15	10.11	31.26	-14.74	46	Average
7	1.509	14.03	9.87	23.9	-32.1	56	QP
8	1.509	9.15	9.87	19.02	-26.98	46	Average
9	14.72	15.63	9.98	25.61	-34.39	60	QP
10	14.72	10.21	9.98	20.19	-29.81	50	Average
11	18.18	24.97	10.05	35.02	-24.98	60	QP
12	18.18	18.75	10.05	28.8	-21.2	50	Average

Note :

- "*" means the worst value in this measurement data .
- C.F (Correction Factor) = Factor (dB)+ Cable Loss (dB) .
- Measurement (dBuV) = Reading(dBuV)+ C.F (Correction Factor) .
- Other mode was also verified. The test results shown represent the worst case emissions .

EUT	14249-RF2-B	Test Date	2016.10.24
Factor	CE_ENV216-N (Filter ON)	Temp. / Humidity	24°C / 55%
Polarity	Neutral	Site / Engineer	SR2 / Kevin
Test Mode	MODE1	Test Voltage	AC120V/60Hz(By NB)

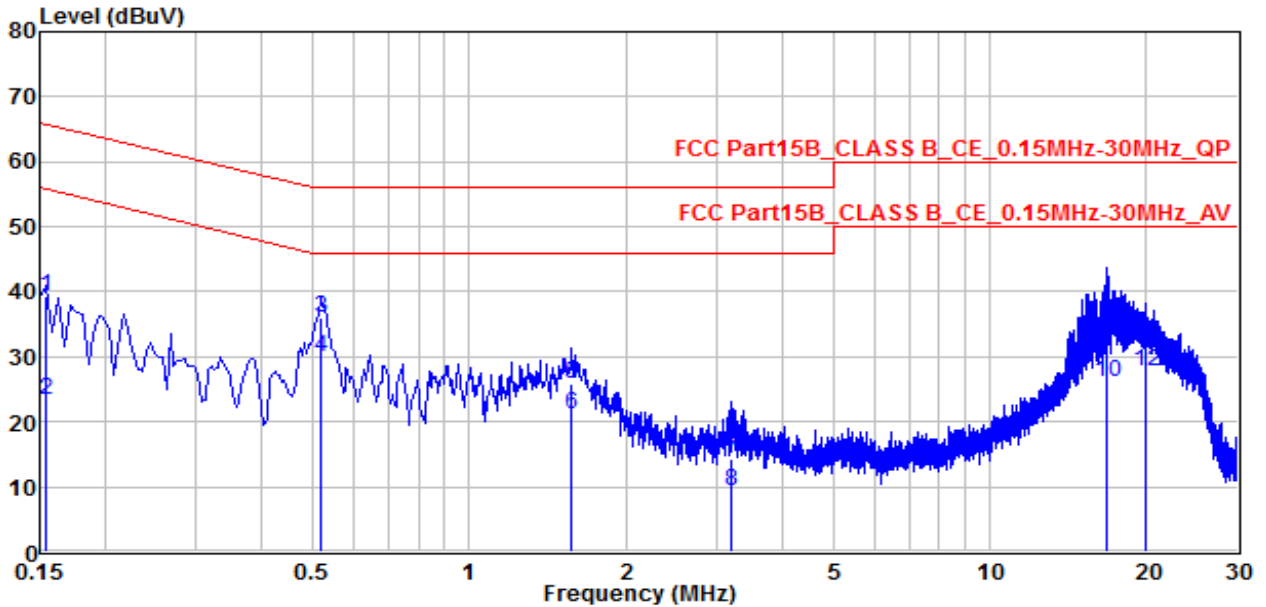

No	Frequency (MHz)	Reading (dBuV)	C.F (dB)	Measurement (dBuV)	Margin (dB)	Limit (dBuV)	Remark (QP/PK/AV)
1	0.1545	29.41	9.9	39.31	-26.44	65.75	QP
2	0.1545	13.33	9.9	23.23	-32.52	55.75	Average
3	* 0.51896	25.98	10.08	36.06	-19.94	56	QP
4	* 0.51896	19.87	10.08	29.95	-16.05	46	Average
5	1.576	15.91	9.87	25.78	-30.22	56	QP
6	1.576	11.38	9.87	21.25	-24.75	46	Average
7	3.178	4.37	9.82	14.19	-41.81	56	QP
8	3.178	-0.57	9.82	9.25	-36.75	46	Average
9	16.798	22.16	9.98	32.14	-27.86	60	QP
10	16.798	16.07	9.98	26.05	-23.95	50	Average
11	19.939	22.43	10	32.43	-27.57	60	QP
12	19.939	17.69	10	27.69	-22.31	50	Average

Note :

- "*" means the worst value in this measurement data .
- C.F (Correction Factor) = Factor (dB)+ Cable Loss (dB) .
- Measurement (dBuV) = Reading(dBuV)+ C.F (Correction Factor) .
- Other channel was also verified. The test results shown represent the worst case emissions.

8. CONCLUSION

The data collected relate only the item(s) tested and show that the **Nautiz X9, FCC ID:**

YY3-14249-RF2 is in compliance with Part 15C of the FCC Rules.

————— The End —————