



MEASUREMENT REPORT

FCC PART 22,24

FCC ID: YY3-14249-RF2
APPLICANT: HANDHELD GROUP AB
Application Type: Certification
Product: Nautiz X9
Model No.: 14249-RF2-B
Trade Mark **handheld**
FCC Classification: (PCE) PCS Licensed Transmitter held to ear
FCC Rule Part(s): Part 22H, Part 24E
Test Procedure(s): TIA 603-E 2016, KDB 971168 D01v03
Test Date: October 09, 2016 ~ January 25, 2018

Tested By : *Kevin Ker*
(Kevin Ker)
Reviewed By : *Paddy Chen*
(Paddy Chen)
Approved By : *Chenz Ker*
(Chenz Ker)



The test results relate only to the samples tested.

This equipment has been shown to be capable of compliance with the applicable technical standards as indicated in the measurement report and was tested in accordance with the measurement procedures specified in §2.947. Test results reported herein relate only to the item(s) tested.

The test report shall not be reproduced except in full without the written approval of MRT Technology (Taiwan) Co., Ltd.

Revision History

Report No.	Version	Description	Issue Date	Note
1801TW1902-U7	1.0	Original Report	2018-02-06	

CONTENTS

Description	Page
§2.1033 General Information	5
1. INTRODUCTION	6
1.1. Scope	6
1.2. MRT Test Location	6
2. PRODUCT INFORMATION	7
2.1. Feature of Equipment under Test.....	7
2.2. Equipment Description	7
2.3. Test Configuration	8
2.4. EMI Suppression Device(s)/Modifications.....	8
3. DESCRIPTION OF TEST	9
3.1. Evaluation Procedure	9
3.2. Cellular – Base Frequency Blocks	9
3.3. Cellular – Mobile Frequency Blocks.....	9
3.4. PCS – Base Frequency Blocks.....	10
3.5. PCS – Mobile Frequency Blocks	10
3.6. Occupied Bandwidth.....	11
3.7. Spurious and Harmonic Emissions at Antenna Terminal	11
3.8. Power and Radiated Spurious Emissions	12
3.9. Peak-Average Ratio	13
3.10. Frequency Stability / Temperature Variation	13
4. TEST EQUIPMENT CALIBRATION DATE.....	14
5. SAMPLE CALCULATIONS.....	15
6. MEASUREMENT UNCERTAINTY.....	16
7. TEST RESULT	17
7.1. Summary.....	17
7.2. Occupied Bandwidth.....	18
7.2.1. Test Limit	18
7.2.2. Test Procedure used.....	18
7.2.3. Test Setting.....	18
7.2.4. Test Setup	18
7.2.5. Test Result.....	19
7.3. Conducted Spurious Emissions.....	25
7.3.1. Test Limit	25

7.3.2.	Test Procedure Used	25
7.3.3.	Test Setting	25
7.3.4.	Test Setup	25
7.3.5.	Test Result	26
7.4.	Band Edge at Antenna Terminal	37
7.4.1.	Test Limit	37
7.4.2.	Test Procedure Used	37
7.4.3.	Test Setting	37
7.4.4.	Test Setup	37
7.4.5.	Test Result	38
7.5.	Power and Radiated Spurious Emissions	43
7.5.1	Test Limit	43
7.5.2	Test Procedure Used	43
7.5.3	Test Setting	43
7.5.4	Test Setup	45
7.5.5	Test Result	46
7.6.	Peak-Average Ratio	66
7.6.1	Test Limit	66
7.6.2	Test Procedure	66
7.6.3	Test Setup	66
7.6.4	Test Result	67
7.7.	Frequency Stability Under Temperature & Voltage Variations	73
7.7.1	Test Limit	73
7.7.2	Test Procedure	73
7.7.3	Test Setup	73
7.7.4	Test Result	74

§2.1033 General Information

Applicant	HANDHELD GROUP AB
Applicant Address	Kinnegatan 17 A ,531 33 Lidköping, Sweden
Manufacturer	HANDHELD GROUP AB
Manufacturer Address	Kinnegatan 17 A ,531 33 Lidköping, Sweden
Test Site	MRT Technology (Taiwan) Co., Ltd
Test Site Address	No. 38, Fuxing Second Rd., Guishan Dist., Taoyuan City 333, Taiwan (R.O.C)
MRT FCC Registration No.	291082
FCC Rule Part(s)	Part 22H,Part 24E
Test Device Serial No.	N/A <input type="checkbox"/> Production <input checked="" type="checkbox"/> Pre-Production <input type="checkbox"/> Engineering

Test Facility / Accreditations

1. MRT facility is a FCC registered (Reg. No. 291082) test facility with the site description report on file and is designated by the FCC as an Accredited Test Film.
2. MRT facility is an IC registered (MRT Reg. No. 21723-1) test laboratory with the site description on file at Industry Canada.
3. MRT Lab is accredited to ISO 17025 by the Taiwan Accreditation Foundation (TAF Cert. No. 3261) in EMC, Telecommunications and Radio testing for FCC, Industry Taiwan, EU and TELEC Rules.

1. INTRODUCTION

1.1. Scope

Measurement and determination of electromagnetic emissions (EMC) of radio frequency devices including intentional and/or unintentional radiators for compliance with the technical rules and regulations of the Federal Communications Commission and the Industry Canada Certification and Engineering Bureau.

1.2. MRT Test Location

The map below shows the location of the MRT LABORATORY, its proximity to the Taoyuan City. These measurement tests were conducted at the MRT Technology (Taiwan) Co., Ltd. Facility located at No.38, Fuxing 2nd Rd., Guishan Dist., Taoyuan City 33377, Taiwan (R.O.C).

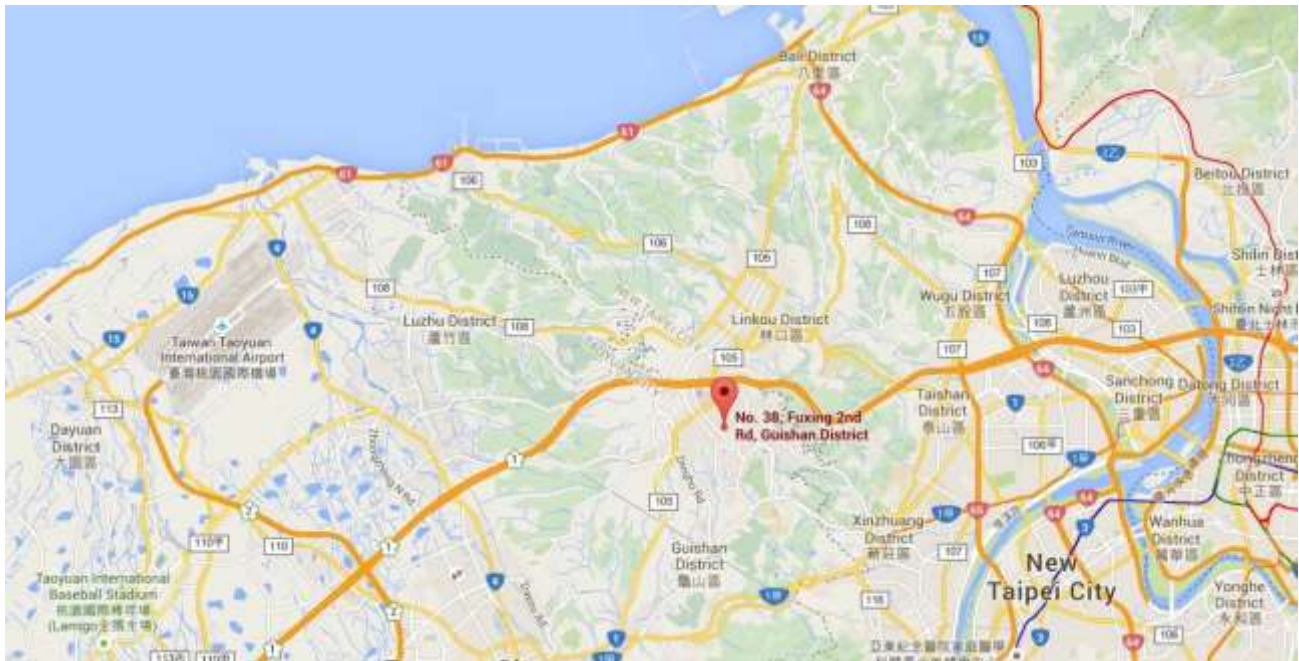

2. PRODUCT INFORMATION

2.1. Feature of Equipment under Test

Product Name	Nautiz X9
Model No.	14249-RF2-B
Brand Name	handheld
Supports Radios Spec.	WWAN : GSM/GPRS/EGPRS/WCDMA/HSPA/CDMA/EVDO/LTE WLAN : 2.4G : 802.11b/g/n-20/n-40; 5G : 802.11a/n-20/n-40 WPAN : Bluetooth/NFC
WWAN Specification	2G(GSM/GPRS/EDGE): 850/1900 3G(WCDMA): Band 2/5 3G(CDMA2000):BC0/BC1 4G(FDD/TDD): Band 2/4/5/7/12/13/17
Frequency Range	GSM 850/CDMA(EVDO)/WCDMA Band 5: 824~849MHz GSM 1900/CDMA(EVDO)/WCDMA Band 2: 1850~1910MHz

2.2. Equipment Description

Antenna Type	FPC
Antenna M/N	AP316-LTE-MAIN_V1 for GSM/WCDMA AP316-LTE-DRX_V1 for CDMA
Antenna Gain	AP316-LTE-MAIN_V1: 824~849: -3.94 dBi ;1850~1910: 3.31dBi AP316-LTE-DRX_V1: 824~849: -10.97 dBi ;1850~1910: -1.03dBi
Type of Modulation	GSM : GMSK/8PSK ; CDMA/WCDMA : QPSK

Note:

1. The test report has showed the worst test mode.
2. This EUT owns 2 SIM cards, one is for 2G and another one is for 2G/3G/4G . In 2G mode ,We have evaluated 2 SIM cards and showed the worst-case in this report.

2.3. Test Configuration

The **Nautiz X9** was tested per the guidance of ANSI/TIA-603-E-2016 and KDB 971168 D01v03. See section 3.0 of this report for a description of the radiated and antenna port conducted emissions tests.

2.4. EMI Suppression Device(s)/Modifications

No EMI suppression device(s) were added and no modifications were made during testing.

3.4. PCS – Base Frequency Blocks

§24.229

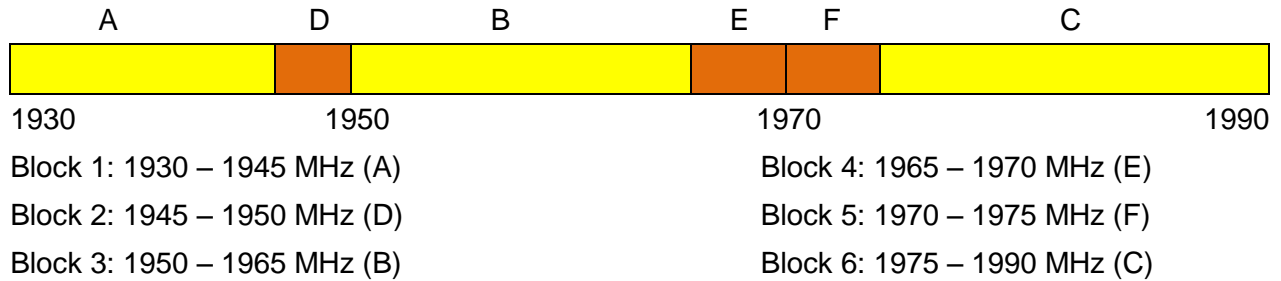

3.5. PCS – Mobile Frequency Blocks

§24.229

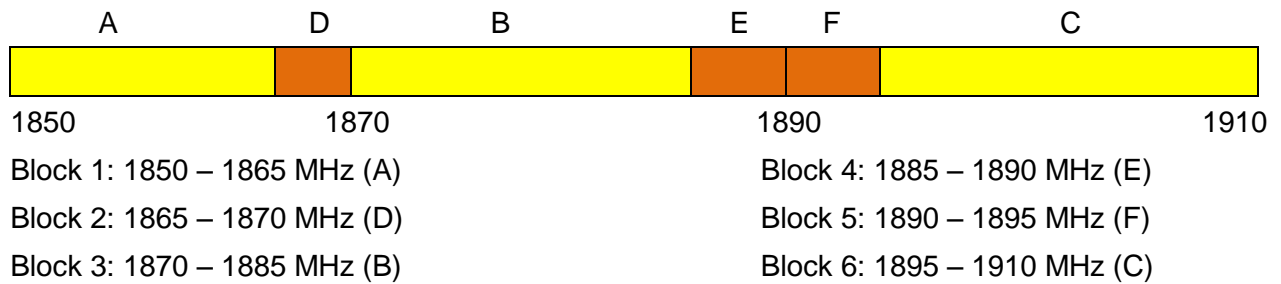

3.6. Occupied Bandwidth

§2.1049

The occupied bandwidth, that is the frequency bandwidth such that, below its lower and above its upper frequency limits, the mean powers radiated are each equal to 0.5 percent of the total mean power radiated by a given emission shall be measured. The spectrum analyzers' "occupied bandwidth" measurement function was used to record the occupied bandwidth in accordance with KDB 971168.

3.7. Spurious and Harmonic Emissions at Antenna Terminal

§2.1051 §22.917(a) §24.238(a)

The level of the carrier and the various conducted spurious and harmonic frequencies is measured by means of a calibrated spectrum analyzer. The spectrum is scanned from the lowest frequency generated in the equipment up to a frequency including its 10th harmonic. On any frequency outside a licensee's frequency block, the power of any emission shall be attenuated below the transmitter power (P) by at least $43 + 10 \log_{10}(P)$ dB. Compliance with these provisions is based on the use of measurement instrumentation employing a resolution bandwidth of 100 kHz or greater for Part 22. However, in the 1 MHz bands immediately outside and adjacent to the frequency block a resolution bandwidth of at least one percent of the emission bandwidth of the fundamental emission of the transmitter may be employed. The emission bandwidth is defined as the width of the signal between two points, one below the carrier center frequency and one above the carrier center frequency, outside of which all emission are attenuated at least 26 dB below the transmitter power.

3.8. Power and Radiated Spurious Emissions

§2.1053 §22.913(a.2) §22.917(a) §24.232(c) §24.238(a)

The radiated test facilities consisted of an indoor 3 meter semi-anechoic chamber used for final measurement and exploratory measurements, when necessary. The measurement area is contained within the semi-anechoic chamber which is shielded from any ambient interference. For measurements above 1GHz absorbers are arranged on the floor between the turn table and the antenna mast in such a way so as to maximize the reduction of reflections. For measurements below 1GHz, the absorbers are removed. A MF Model 210SS turntable is used for radiated measurement. It is a continuously rotatable, remote-controlled, metallic turntable and 2 meters (6.56 ft.) in diameter. The turn table is flush with the raised floor of the chamber in order to maintain its function as a ground plane. A 80cm high PVC support structure is placed on top of the turntable.

The equipment under test was transmitting while connected to its integral antenna and is placed on a wooden turntable 80cm above the ground plane and 3 meters from the receive antenna. The receive antenna height is adjusted between 1 and 4 meter height, the turntable is rotated through 360 degrees, and the EUT is manipulated through all orthogonal planes representative of its typical use to achieve the highest reading on the receive spectrum analyzer. Radiated power levels are also investigated with the receive antenna horizontally and vertically polarized. The maximized power level is recorded using the spectrum analyzer "Channel Power" function with the integration band set to the emissions' occupied bandwidth, a RMS detector, RBW = 100kHz, VBW = 300kHz, and a 1 second sweep time over a minimum of 10 sweeps, per the guidelines of KDB 971168.

Per the guidance of ANSI/TIA-603-E-2016, a half-wave dipole is then substituted in place of the EUT. For emissions above 1GHz, a horn antenna is substituted in place of the EUT. The substitute antenna is driven by a signal generator with the level of the signal generator being adjusted to obtain the same receive spectrum analyzer level previously recorded from the spurious emission from the EUT. The power of the emission is calculated using the following formula:

$$P_d \text{ [dBm]} = P_g \text{ [dBm]} - \text{cable loss [dB]} + \text{antenna gain [dBd/dBi]}$$

Where, P_d is the dipole equivalent power, P_g is the generator output into the substitution antenna, and the antenna gain is the gain of the substitute antenna used relative to either a half-wave dipole (dBd) or an isotropic source (dBi). The substitute level is equal to $P_g \text{ [dBm]} - \text{cable loss [dB]}$.

The calculated P_d levels are then compared to the absolute spurious emission limit of -13dBm which is equivalent to the required minimum attenuation of $43 + 10\log_{10} (\text{Power [Watts]})$ specified in 22.917(a).

3.9. Peak-Average Ratio

§24.232(d)

A peak to average ratio measurement is performed at the conducted port of the EUT. The spectrum analyzers Complementary Cumulative Distribution Function (CCDF) measurement profile is used to determine the largest deviation between the average and the peak power of the EUT in a given bandwidth. The CCDF curve shows how much time the peak waveform spends at or above a given average power level. The percent of time the signal spends at or above the level defines the probability for that particular power level.

For pulsed signals, the spectrum analyzer is set to use an internal “RF Burst” trigger that is synced with an incoming pulse and the measurement interval is set to less than the duration of the “on time” of one burst to ensure that energy is only captured during a time in which the transmitter is operating at maximum power. For continuous signals, the trigger is set to “free run” in the CCDF measurement mode.

3.10. Frequency Stability / Temperature Variation

§2.1055 §22.355 §22.863 §22.905 §24.229 §24.235

Frequency stability testing is performed in accordance with the guidelines of ANSI/TIA-603-E-2016.

The frequency stability of the transmitter is measured by:

- a.) Temperature: The temperature is varied from -30°C to +50°C in 10°C increments using an environmental chamber.
- b.) Primary Supply Voltage: The primary supply voltage is varied from End point to 115% of the nominal value for non hand-carried battery and AC powered equipment. For hand-carried, battery-powered equipment, primary supply voltage is reduced to the battery operating end point which shall be specified by the manufacturer.

Specification – For Part 22, the frequency stability of the transmitter shall be maintained within $\pm 0.00025\%$ (± 2.5 ppm) of the center frequency.

Time Period and Procedure:

1. The carrier frequency of the transmitter is measured at room temperature (20°C to provide a reference).
2. The equipment is turned on in a “standby” condition for fifteen minutes before applying power to the transmitter. Measurement of the carrier frequency of the transmitter is made within one minute after applying power to the transmitter.
3. Frequency measurements are made at 10°C intervals ranging from -30°C to +50°C. A period of at least one half-hour is provided to allow stabilization of the equipment at each temperature level.

4. TEST EQUIPMENT CALIBRATION DATE

Conducted Emissions – SR2

Instrument	Manufacturer	Type No.	Asset No.	Cali. Interval	Cali. Due Date
Two-Line V-Network	R&S	ENV216	MRTTWA00019	1 year	2018.03.15
Cable	Rosnol	N1C50-RG400-B 1C50-500CM	MRTTWE00013	1 year	2018.05.19
EMI Test Receiver	R&S	ESR3	MRTTWA00009	1 year	2018.03.16

Radiated Emissions – AC1

Instrument	Manufacturer	Type No.	Asset No.	Cali. Interval	Cali. Due Date
Broadband TRILOG Antenna	SCHWARZBECK	VULB 9162	MRTTWA00001	1 year	2018.05.14
EMI Test Receiver	R&S	ESR3	MRTTWA00009	1 year	2018.03.16
Active Loop Antenna	Schwarzbeck	FMZB 1519B	MRTTWA00002	1 year	2018.04.13
Broadband Horn antenna	SCHWARZBECK	BBHA 9120D	MRTTWA00003	1 year	2018.04.17
Breitband Hornantenna	Schwarzbeck	BBHA 9170	MRTTWA00004	1 year	2018.04.24
Broadband Amplifier	Schwarzbeck	BBV 9721	MRTTWA00006	1 year	2018.04.24
Broadband Preampfier	SCHWARZBECK	BBV 9718	MRTTWA00005	1 year	2018.04.19
Cable	HUBERSUHNER	SF106	MRTTWA00010	1 year	2018.05.19
Cable	Rosnol	K1K50-UP0264- K1K50-4M	MRTTWA00012	1 year	2018.05.19

Conducted Test Equipment – SR2

Instrument	Manufacturer	Type No.	Asset No.	Cali. Interval	Cali. Due Date
Spectrum Analyzer	KEYSIGHT	N9010A	MRTTWA00012	1 year	2018.07.24
USB Wideband Power Sensor	KEYSIGHT	U2021XA	MRTTWA00015	1 year	2018.03.19

Test Software

Software	Version	Function
e3	9.160520a	EMI Test Software
EMI	V3	EMI Test Software

5. SAMPLE CALCULATIONS

GSM Emission Designator

Emission Designator = 250KGXW

GSM BW = 250 kHz

G = Phase Modulation

X = Cases not otherwise covered

W = Combination (Audio/Data)

EGPRS Emission Designator

Emission Designator = 250KG7W

GSM BW = 250 kHz

G = Phase Modulation

7 = Quantized/Digital Info

W = Combination (Audio/Data)

CDMA Emission Designator

Emission Designator = 1M25F9W

WCDMA BW = 1.25 MHz

F = Frequency Modulation

9 = Composite Digital Info

W = Combination (Audio/Data)

WCDMA Emission Designator

Emission Designator = 5M00F9W

WCDMA BW = 5.00 MHz

F = Frequency Modulation

9 = Composite Digital Info

W = Combination (Audio/Data)

Spurious Radiated Emission

Example: Spurious emission at 1688.10 MHz

The receive spectrum analyzer reading at 3 meters with the EUT on the turntable was -65.0dBm . The gain of the substituted antenna is 6.5dBi . The signal generator connected to the substituted antenna terminals is adjusted to produce a reading of -65.0dBm on the spectrum analyzer. The loss of the cable between the signal generator and the terminals of the substituted antenna is 4.5 dB at 1688.1MHz . So 2 dB is added to the signal generator reading of -25dBm yielding -23dBm . The fundamental EIRP was 24.0dBm so this harmonic was $24.0\text{dBm} - (-23) = 47\text{dBc}$.

6. MEASUREMENT UNCERTAINTY

Where relevant, the following test uncertainty levels have been estimated for tests performed on the EUT as specified in CISPR 16-4-2. This uncertainty represents an expanded uncertainty expressed at approximately the 95% confidence level using a coverage factor of $k = 2$.

AC Conducted Emission Measurement – SR2
Measuring Uncertainty for a Level of Confidence of 95% ($U=2Uc(y)$): 150kHz~30MHz: 2.42dB
Conducted Measurement– SR1
Measuring Uncertainty for a Level of Confidence of 95% ($U=2Uc(y)$): 1.3dB
Radiated Emission Measurement – AC1
Measuring Uncertainty for a Level of Confidence of 95% ($U=2Uc(y)$): 4.22dB

7. TEST RESULT

7.1. Summary

Company Name: Nautiz X9
FCC Classification: (PCE) PCS Licensed Transmitter held to ear

FCC Part Section(s)	Test Description	Test Limit	Test Condition	Test Result	Reference
Transmitter Mode(TX)					
2.1049	Occupied bandwidth	N/A	Conducted	Pass	Section 7.2
2.1051 22.917(a) 24.238(a)	Conducted Spurious Emissions	$> 43 + 10 \log_{10} (P[\text{Watts}])$ at for all out-of-band emissions		Pass	Section 7.3
2.1051 22.917(a) 24.232(c) 24.238(a)	Band Edge	$> 43 + 10 \log_{10} (P[\text{Watts}])$ at for all out-of-band emissions		Pass	Section 7.4
2.1046	Conducted Output Power	N/A		Pass	Section 7.5
22.913(a.2)	Radiated Output Power	< 7 Watts max. ERP	Radiated	Pass	Section 7.5
24.232(c)	Radiated Output Power	< 2 Watts max. ERP		Pass	
2.1053 22.917(a) 24.238(a)	Radiated Spurious Emissions	$> 43 + 10 \log_{10}(P[\text{Watts}])$ for all out-of-band emissions		Pass	
24.232(d)	Peak-Average Ratio	< 13 dB		Pass	Section 7.6
2.1055 22.355 24.235	Frequency Stability	< 2.5 ppm		Pass	Section 7.6

Notes:

- 1) All modes of operation and data rates were investigated. The test results shown in the following sections represent the worst case emissions.
- 2) All antenna port conducted emissions testing was performed on a test bench with the antenna port of the EUT connected to the spectrum analyzer through calibrated cables, attenuators, and couplers.

7.2. Occupied Bandwidth

7.2.1. Test Limit

N/A

7.2.2. Test Procedure used

KDB 971168 D01v03 – Section 4 & ANSI/TIA-603-E-2016

7.2.3. Test Setting

1. The spectrum analyzer center frequency is set to the nominal EUT channel center frequency. The span range for the spectrum analyzer shall be between two and five times the anticipated OBW.
2. The nominal resolution bandwidth (RBW) shall be in the range of 1 to 5 % of the anticipated OBW, and the VBW shall be at least 3 times the RBW. (RBW = approximately 1% of the emission bandwidth).
3. Set the detection mode to peak, and the trace mode to max hold.
4. Use the 99 % power bandwidth function of the spectrum analyzer (if available) and report the measured bandwidth.

7.2.4. Test Setup

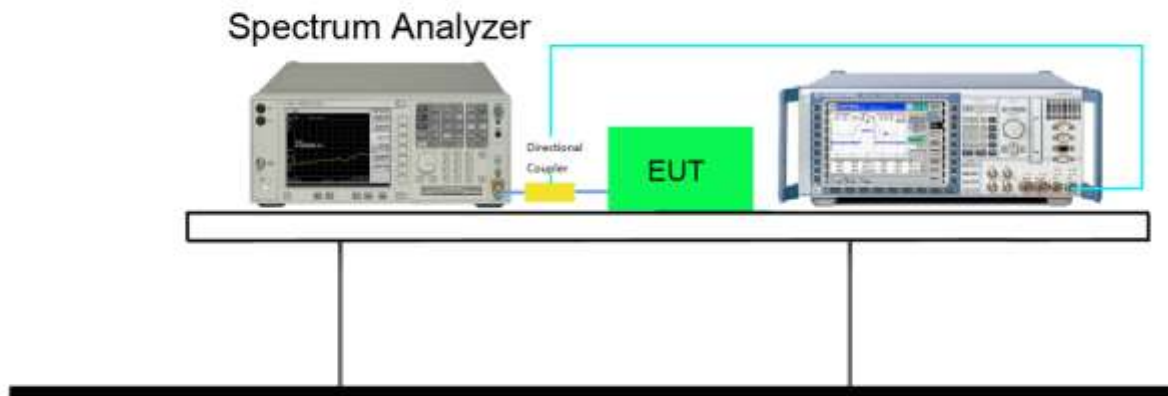

7.2.5. Test Result

Test Mode	Channel No.	Frequency (MHz)	99% Occupied Bandwidth (kHz)	-26dB Occupied Bandwidth (kHz)	Result
GPRS850	128	824.2	234.65	315.4	Pass
	190	836.6	247.55	314.2	Pass
	251	848.8	250.96	316.6	Pass
GPRS1900	512	1850.2	245.87	318.6	Pass
	661	1880.0	249.43	311.9	Pass
	810	1909.8	247.13	317.2	Pass
EGPRS850	128	824.2	248.57	318.2	Pass
	190	836.6	248.64	319.5	Pass
	251	848.8	249.09	313.8	Pass
EGPRS1900	512	1850.2	253.34	318.1	Pass
	661	1880.0	246.90	313.8	Pass
	810	1909.8	256.23	333.0	Pass
CDMA BC0 (850)	1013	824.7	1276.8	1435	Pass
	384	836.52	1269.9	1428	Pass
	777	848.31	1272.4	1430	Pass
CDMA BC1 (1900)	25	1851.25	1280.8	1459	Pass
	600	1880	1286.6	1505	Pass
	1175	1908.75	1285.9	1480	Pass
EVDO BC0 (850)	1013	824.7	1272.0	1435	Pass
	384	836.52	1284.8	1439	Pass
	777	848.31	1266.7	1432	Pass
EVDO BC1 (1900)	25	1851.25	1281.5	1592	Pass
	600	1880	1302.2	1875	Pass
	1175	1908.75	1296.6	1950	Pass
WCDMA Band II	9262	1852.4	4.2469	4946	Pass
	9400	1880.0	4.2727	4973	Pass
	9538	1907.6	4.2291	4940	Pass
WCDMA Band V	4132	826.4	4.2101	4878	Pass
	4182	836.4	4.2289	4867	Pass
	4233	846.6	4.2222	4856	Pass

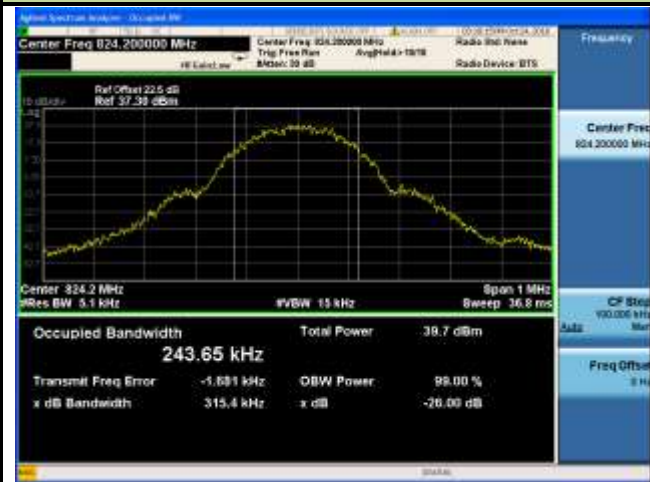
GPRS850-CH128

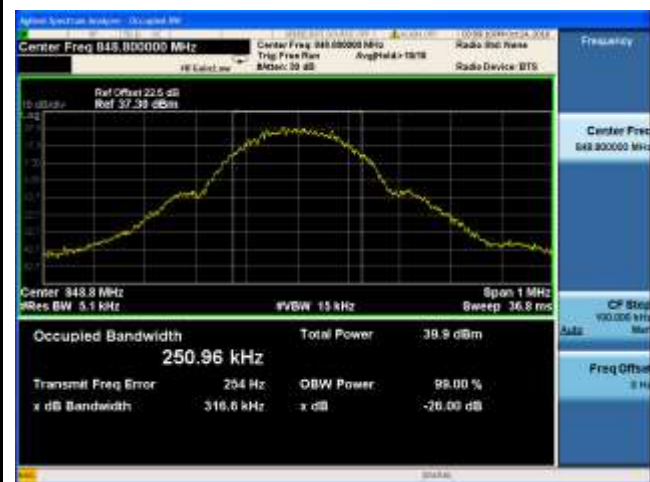
GPRS850-CH189

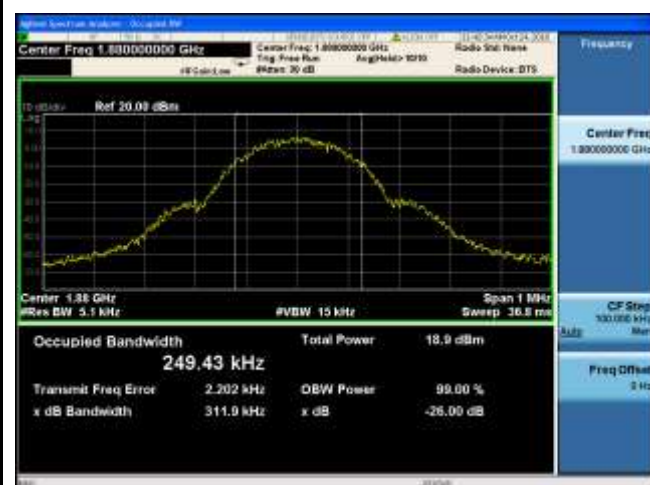
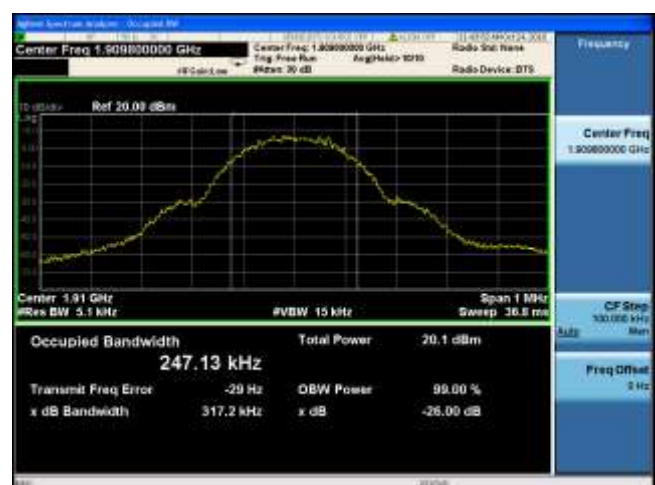
GPRS850-CH251

GPRS1900-CH512

GPRS1900-CH661

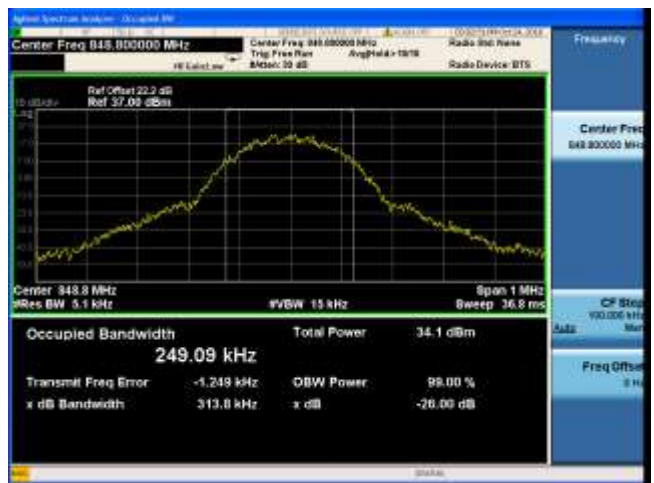
GPRS1900-CH810

EGPRS850-CH128

EGPRS850-CH189

EGPRS850-CH251

EGPRS1900-CH512

EGPRS1900-CH661

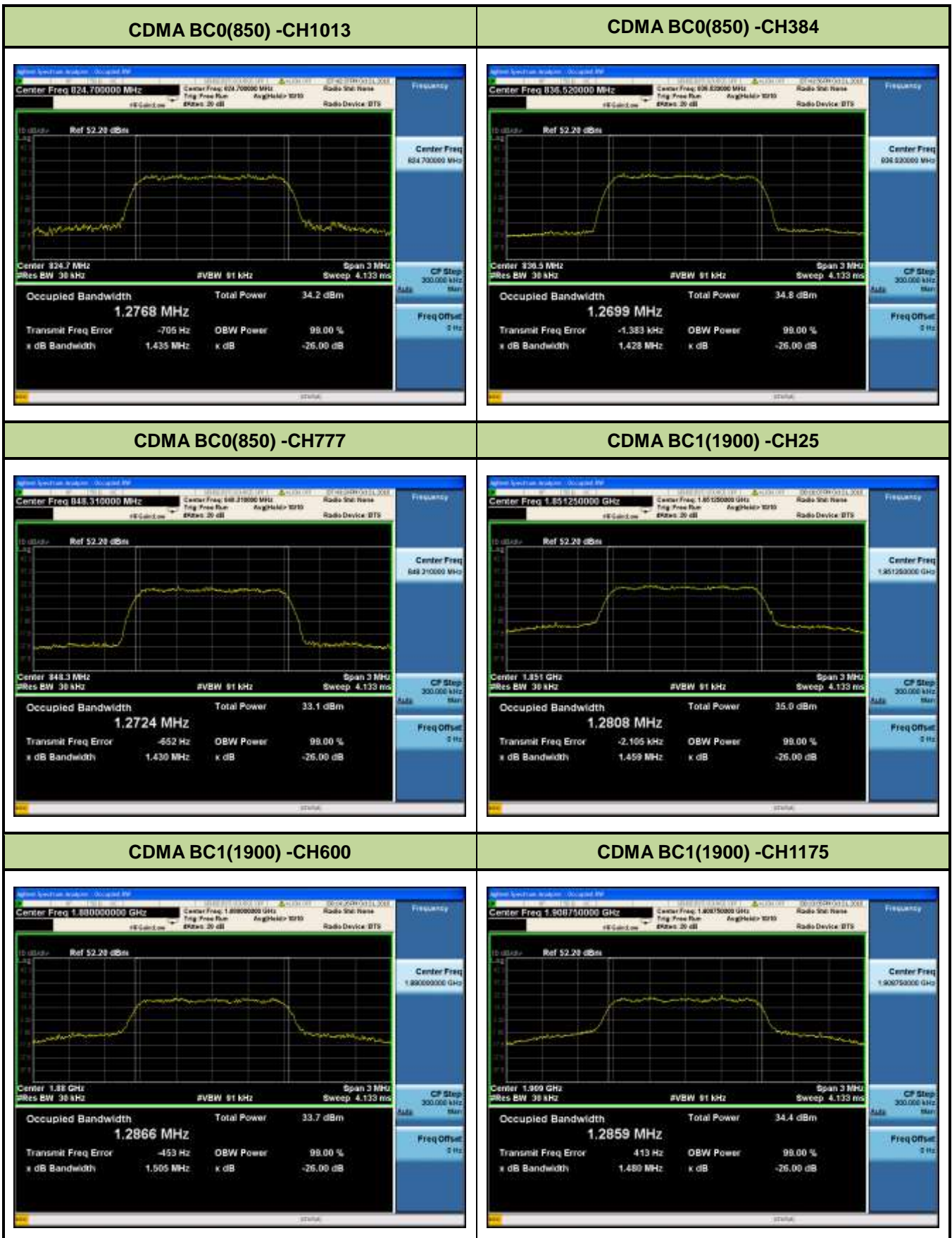
EGPRS1900-CH810

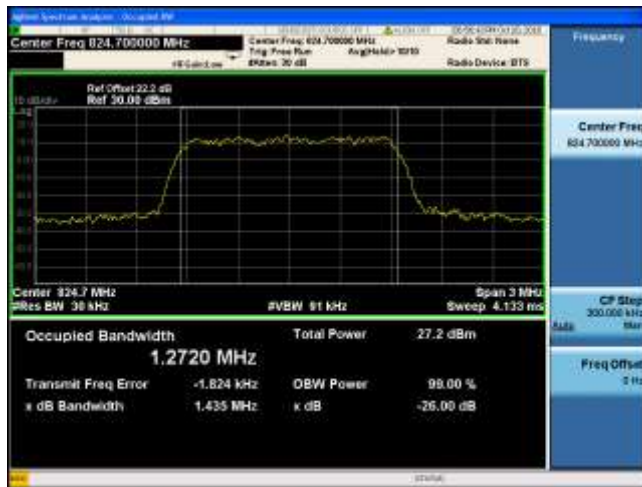

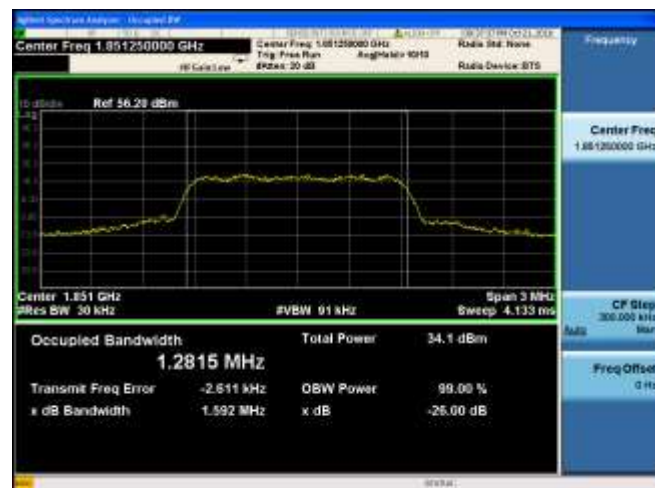

EVDO BC0(850)-CH1013

EVDO BC0(850)-CH384

EVDO BC0(850)-CH777

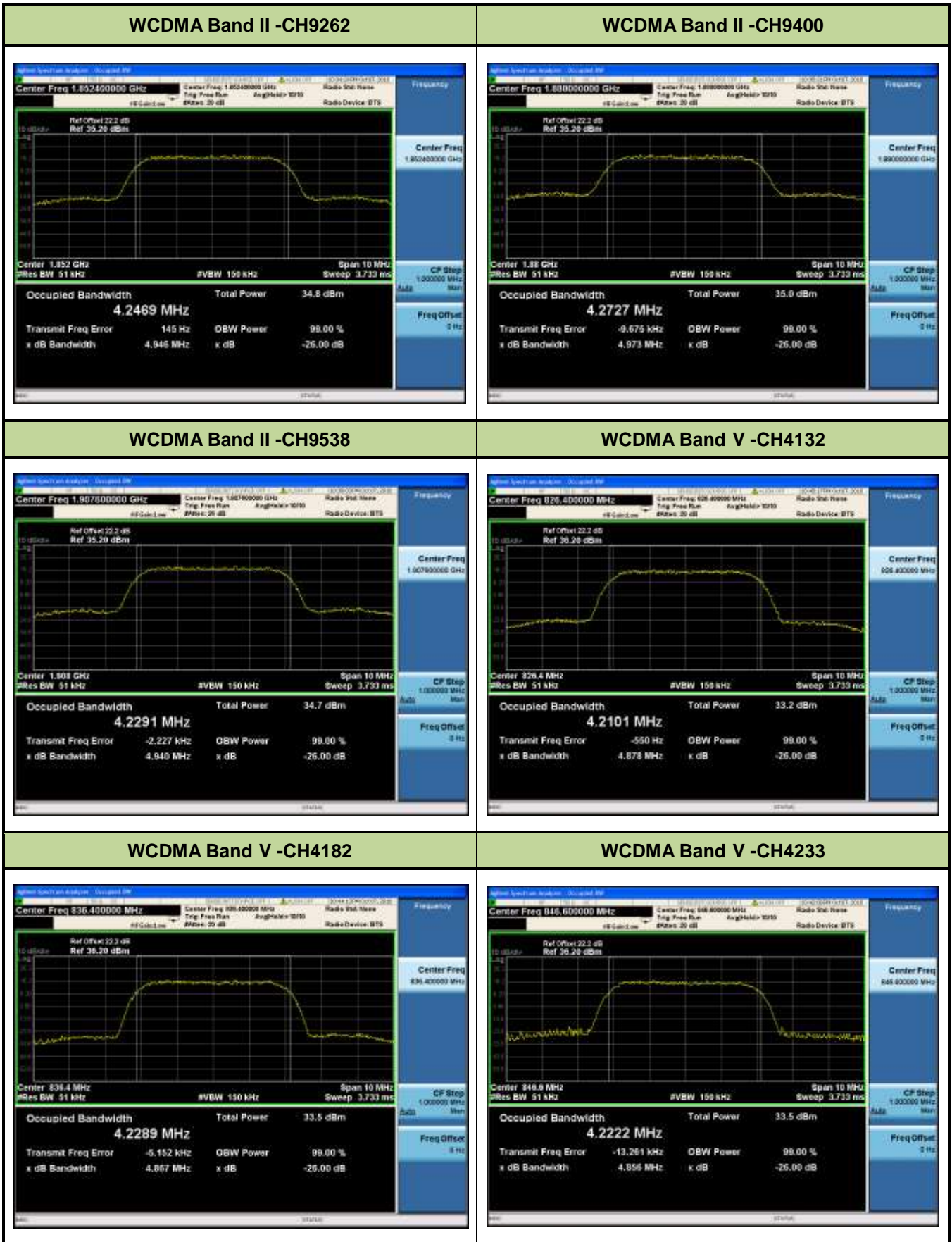
EVDO BC1(1900)-CH25

EVDO BC1(1900)-CH600

EVDO BC1(1900)-CH1175

7.3. Conducted Spurious Emissions

7.3.1. Test Limit

The power of any emission outside of the authorized operating frequency ranges must be attenuated below the transmitting power (P) by a factor of at least $43 + 10\log_{10}(P)$ dB.

7.3.2. Test Procedure Used

KDB 971168 D01v03 – Section 6.0 & ANSI/TIA-603-E-2016

7.3.3. Test Setting

Compliance with these rules is based on the use of measurement instrumentation employing a resolution bandwidth of 100 kHz is at or below 1GHz and 1MHz is above 1GHz, If any, up to 10th harmonic.

7.3.4. Test Setup

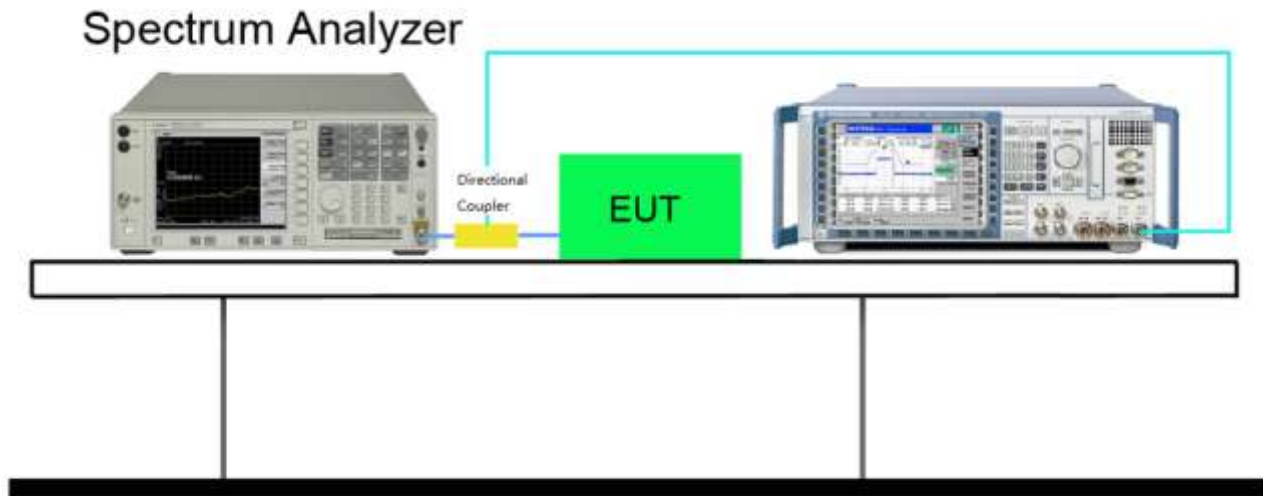

7.3.5. Test Result

Mode	Channel No.	Frequency (MHz)	Modulation	Test Result
GSM850	128	824.20	GMSK	Pass
GSM850	190	836.60	GMSK	Pass
GSM850	251	848.80	GMSK	Pass
PCS1900	512	1850.20	GMSK	Pass
PCS1900	661	1880.00	GMSK	Pass
PCS1900	810	1909.80	GMSK	Pass
EGPRS850	128	824.20	8PSK	Pass
EGPRS850	190	836.60	8PSK	Pass
EGPRS850	251	848.80	8PSK	Pass
EGPRS1900	512	1850.20	8PSK	Pass
EGPRS1900	661	1880.00	8PSK	Pass
EGPRS1900	810	1909.80	8PSK	Pass
CDMA 850	1013	824.7	QPSK	Pass
CDMA 850	384	836.52	QPSK	Pass
CDMA 850	777	848.31	QPSK	Pass
CDMA 1900	25	1851.25	QPSK	Pass
CDMA 1900	600	1880.00	QPSK	Pass
CDMA 1900	1175	1908.75	QPSK	Pass
EVDO 850	1013	824.7	QPSK	Pass
EVDO 850	384	836.52	QPSK	Pass
EVDO 850	777	848.31	QPSK	Pass
EVDO 1900	25	1851.25	QPSK	Pass
EVDO 1900	600	1880.00	QPSK	Pass
EVDO 1900	1175	1908.75	QPSK	Pass
WCDMA Band II	9262	1852.4	QPSK	Pass
WCDMA Band II	9400	1880.0	QPSK	Pass
WCDMA Band II	9538	1907.6	QPSK	Pass
WCDMA Band V	4132	826.40	QPSK	Pass
WCDMA Band V	4182	836.40	QPSK	Pass
WCDMA Band V	4233	846.60	QPSK	Pass

GPRS850-CH128 (824.2MHz)

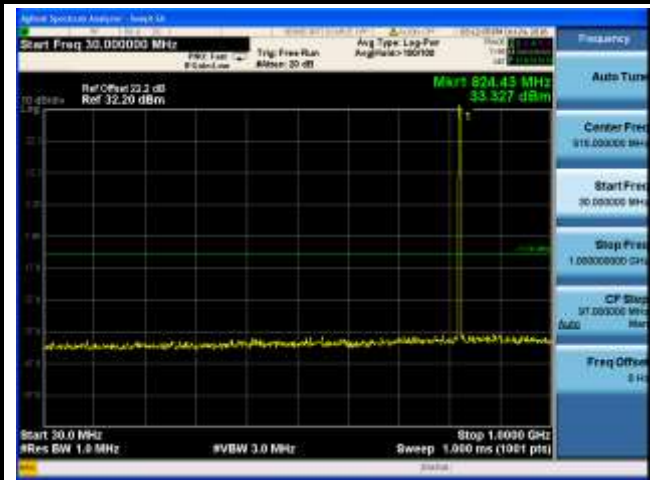

GPRS850-CH190 (836.6MHz)

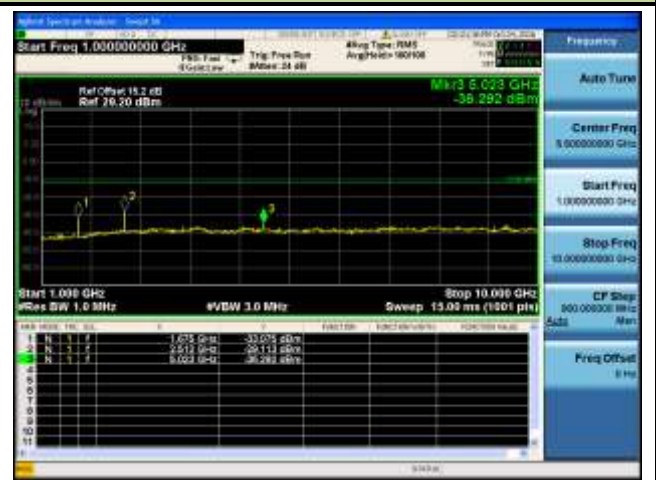
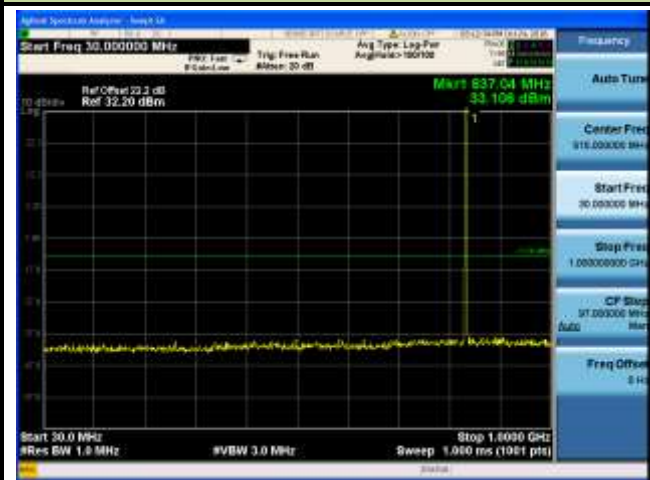

GPRS850-CH251 (848.8MHz)

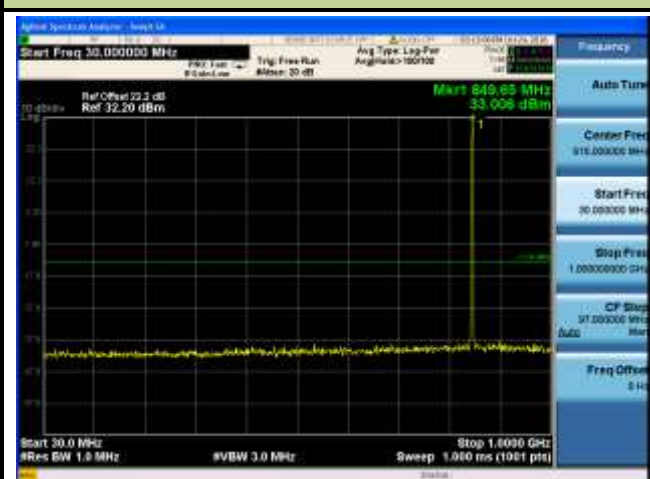

GPRS1900-CH512 (1850.2MHz)



GPRS1900-CH661 (1880.0MHz)



GPRS1900-CH810 (1909.8MHz)

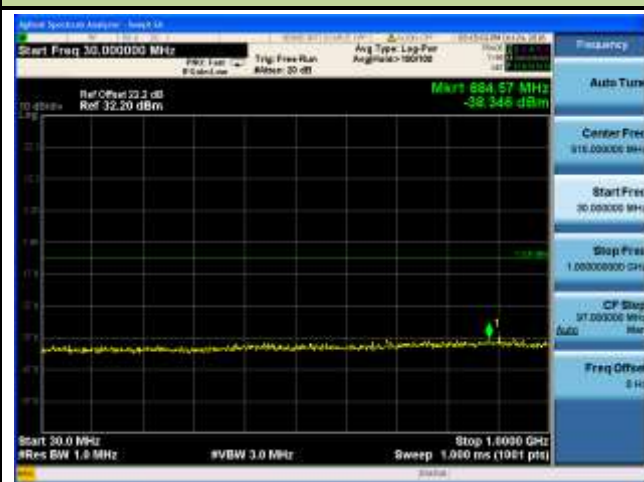

EGPRS850-CH128 (824.2MHz)

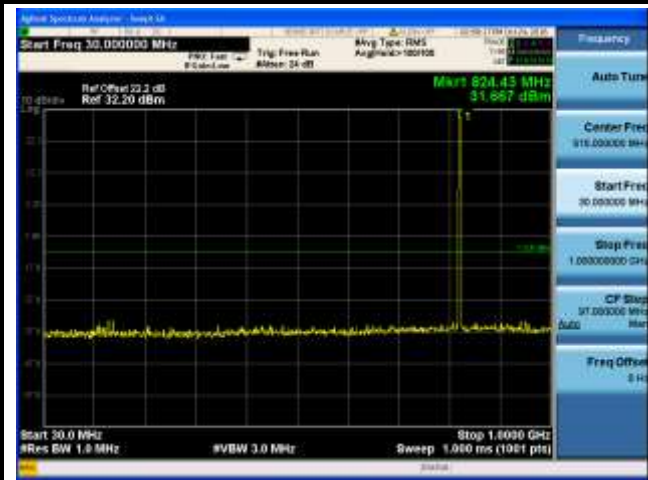

EGPRS850-CH190 (836.6MHz)



EGPRS850-CH251 (848.8MHz)

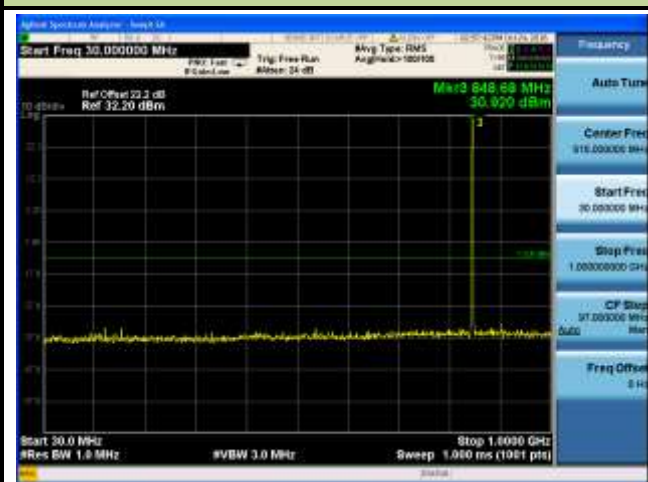

EGPRS1900-CH512 (1850.2MHz)

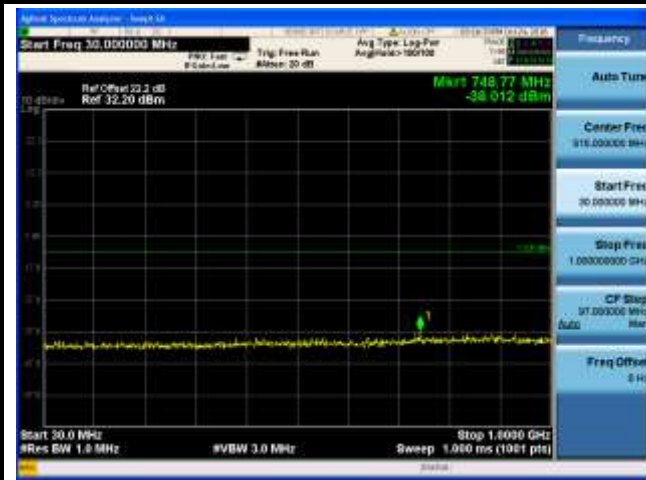

EGPRS1900-CH661 (1880.0MHz)

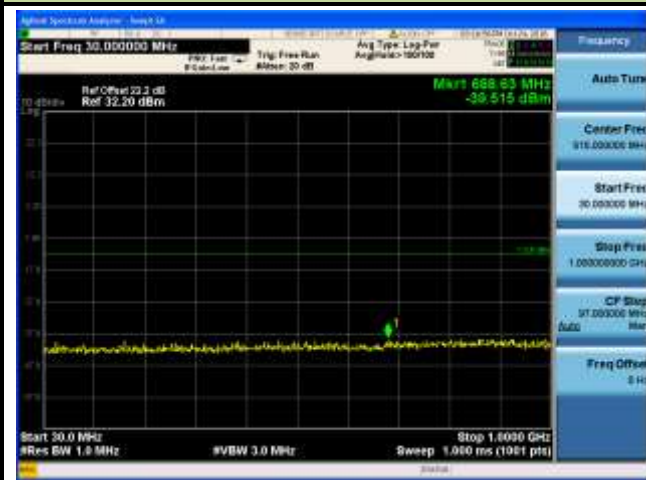

EGPRS1900-CH810 (1909.8MHz)



CDMA BC0(850)-CH1013 (824.7MHz)

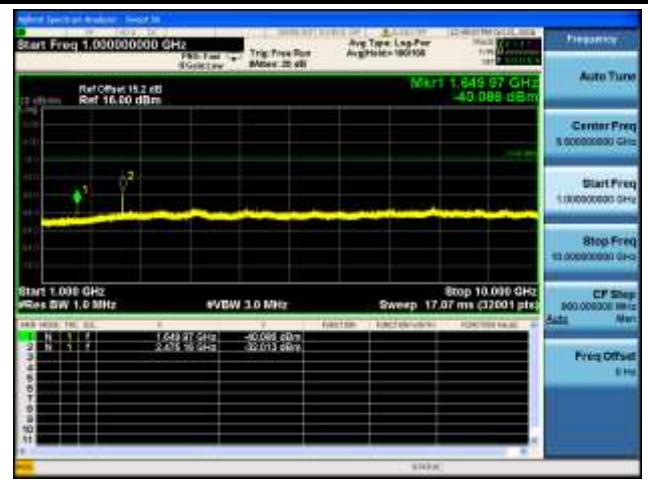
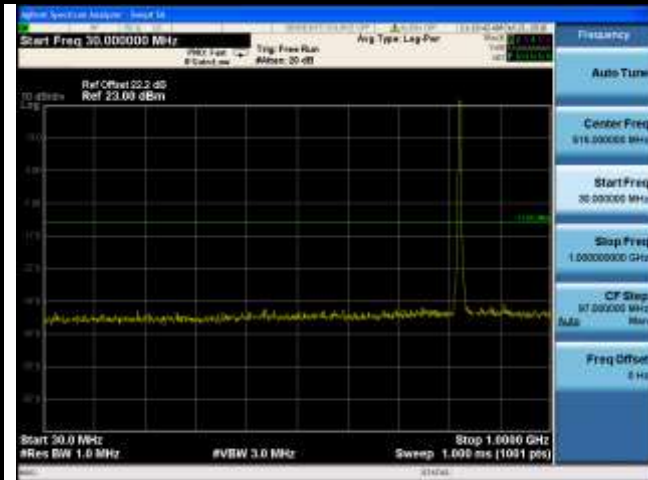

CDMA BC0(850)-CH384 (836.52MHz)

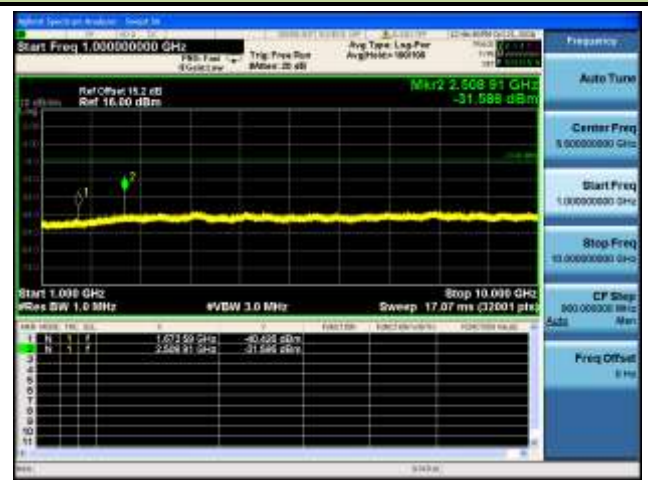
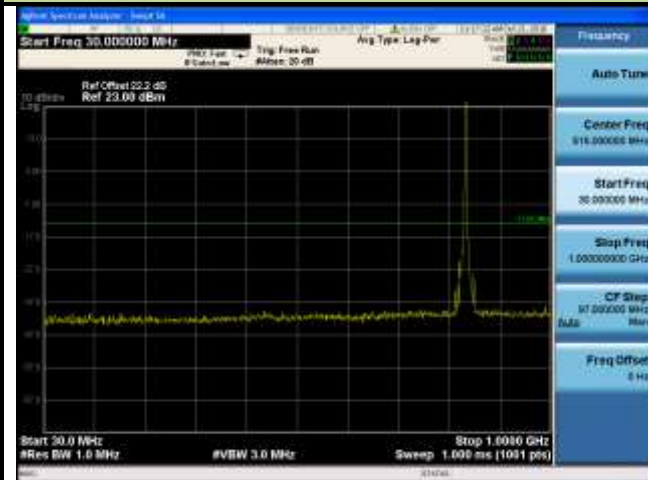

CDMA BC0(850)-CH777 (848.31MHz)

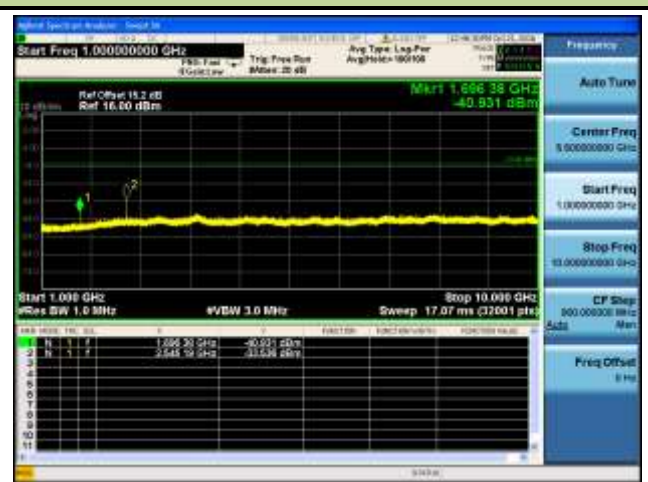
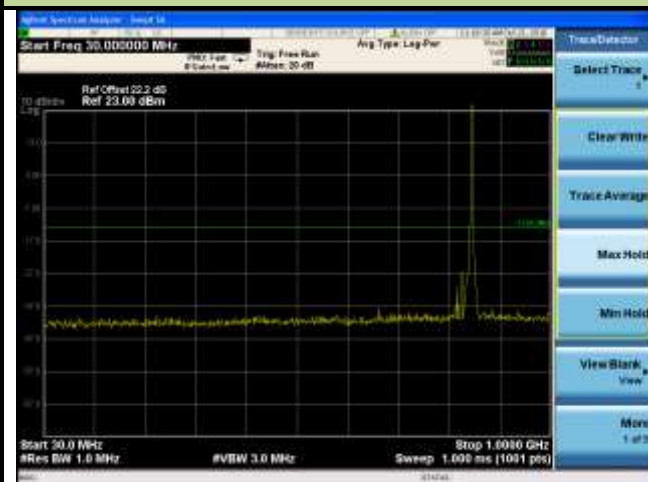

CDMA BC1(1900)-CH25 (1851.25MHz)

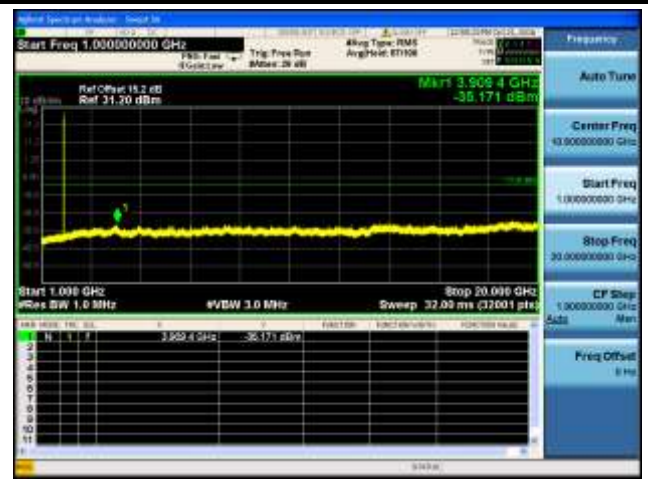

CDMA BC1(1900)-CH600 (1880MHz)

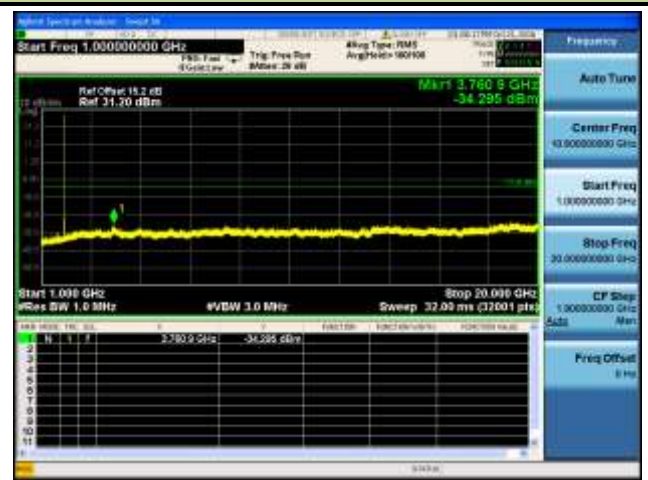

CDMA BC1(1900)-CH1175 (1908.75MHz)

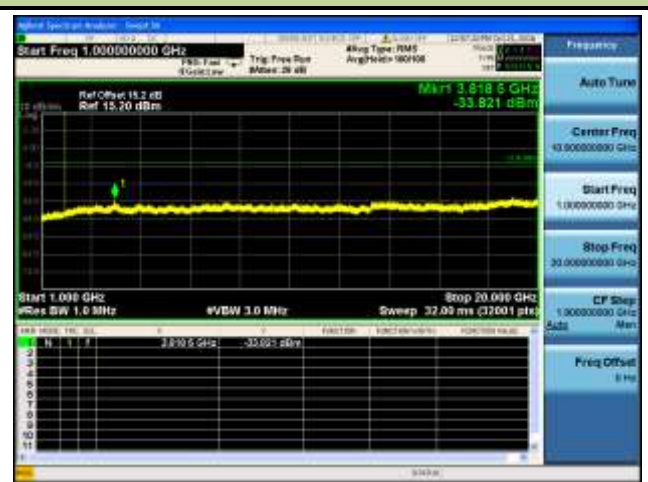

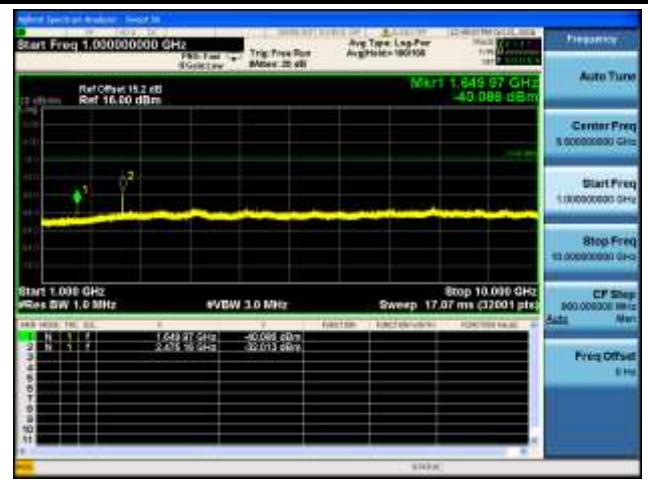
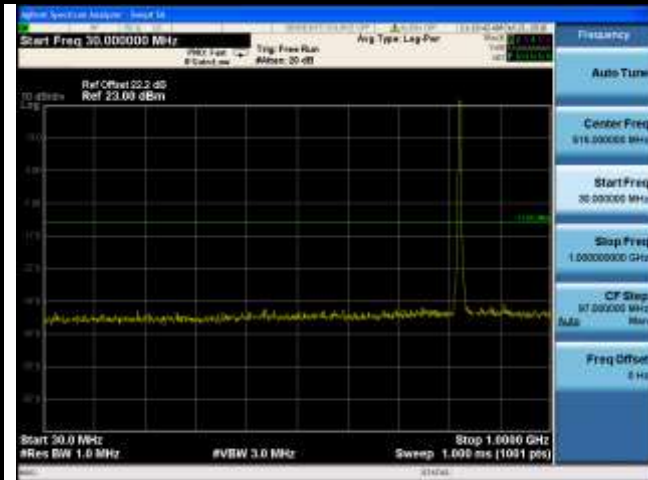
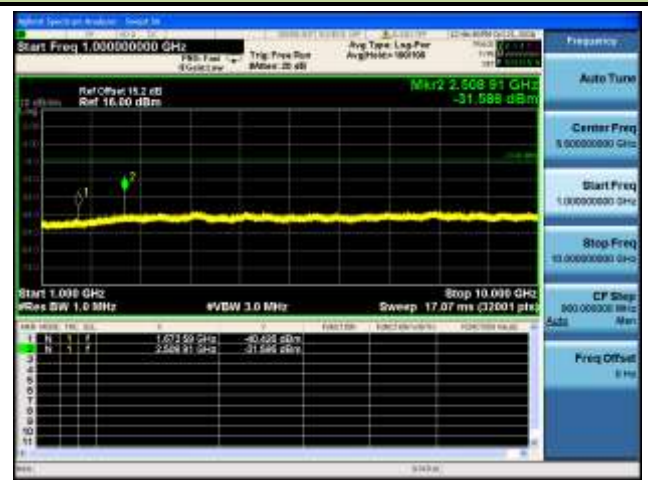
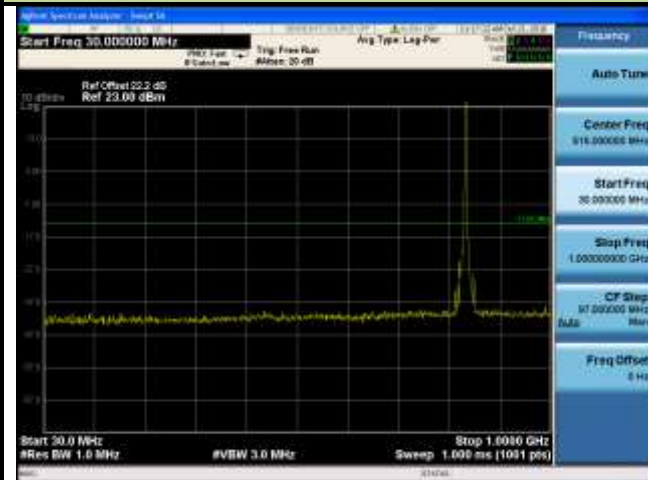
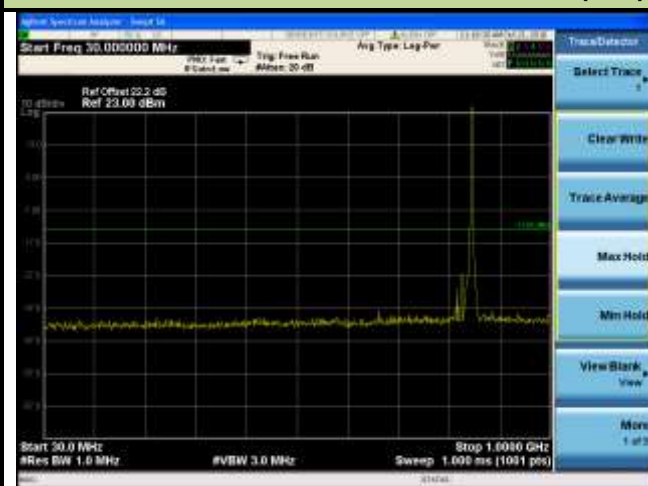
EVDO BC0(850)-CH1013 (824.7MHz)

EVDO BC0(850)-CH384 (836.52MHz)

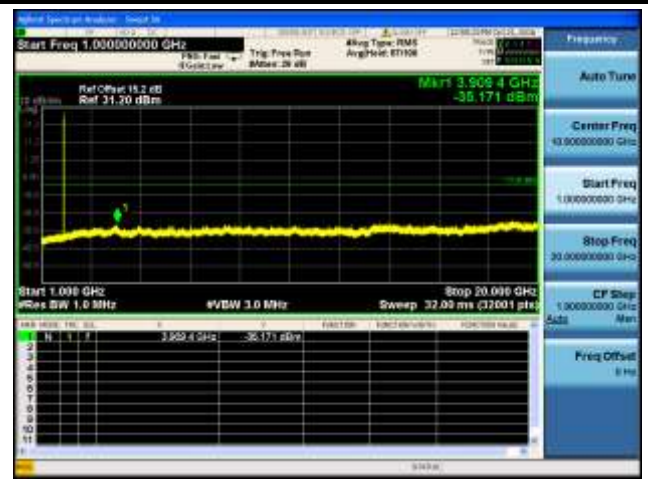
EVDO BC0(850)-CH777 (848.31MHz)

EVDO BC1(1900)-CH25 (1851.25Hz)

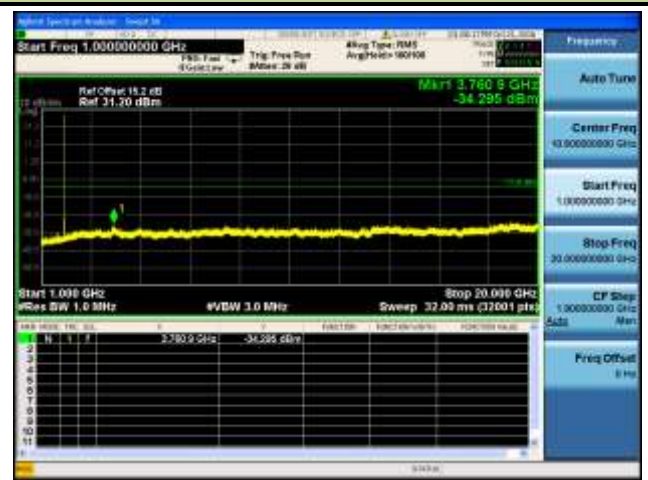

EVDO BC1(1900)-CH600 (1880Hz)



EVDO BC1(1900)-CH1175 (1908.75Hz)

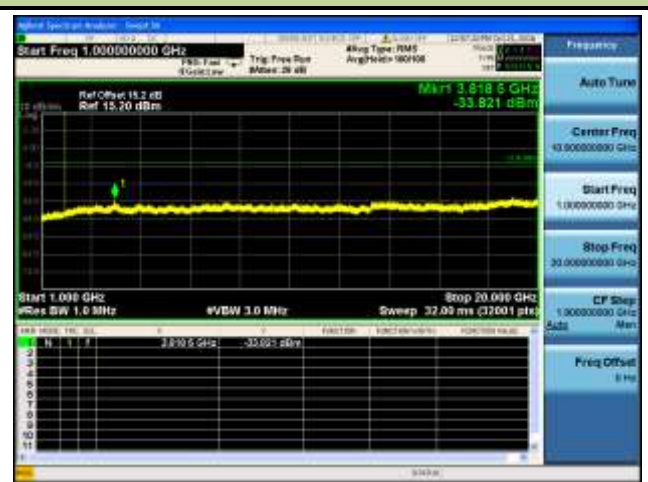

WCDMA Band II-CH9262 (1852.4Hz)

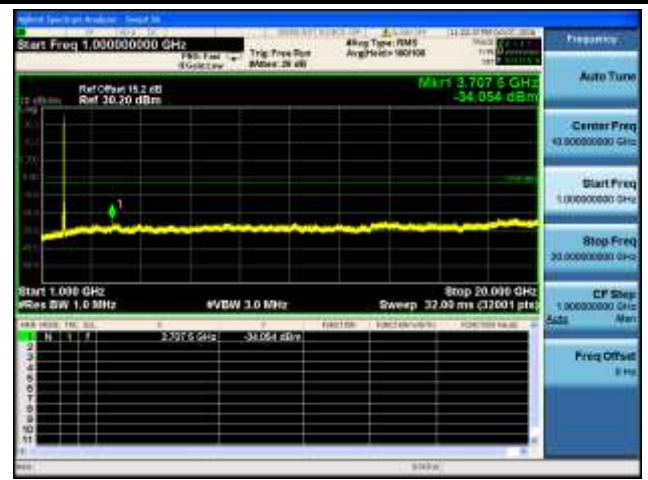
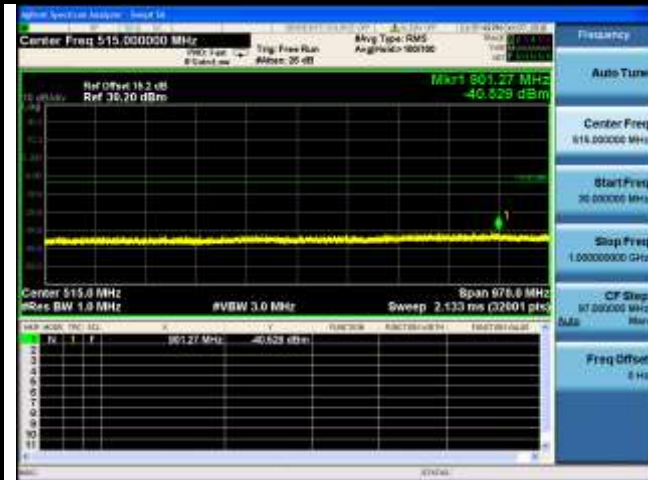

WCDMA Band II-CH9400 (1880.0Hz)

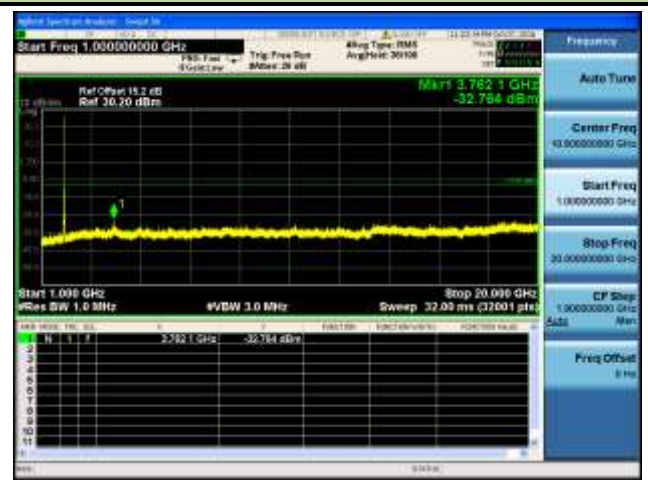
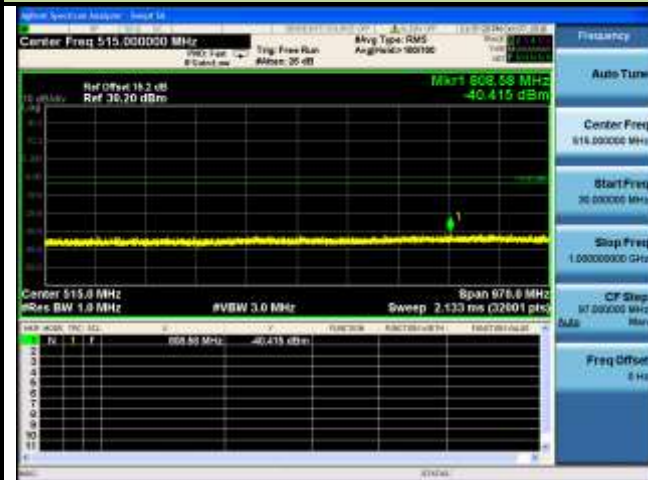

WCDMA Band II-CH9538 (1907.6Hz)

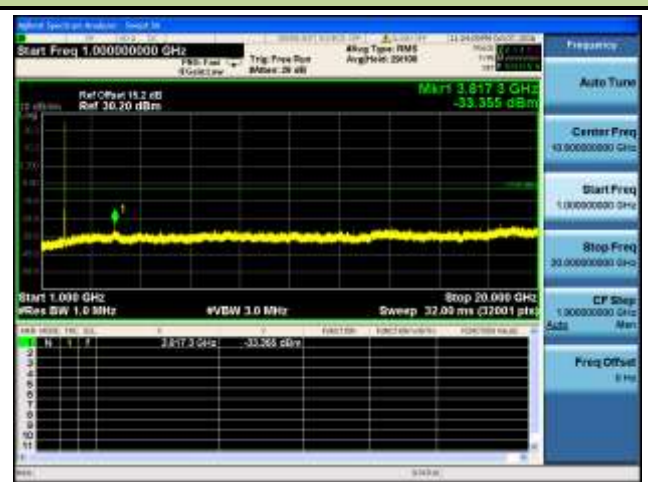
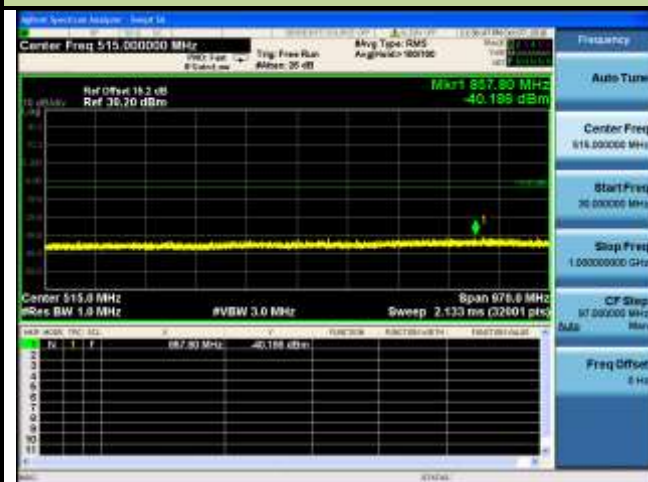

WCDMA Band V-CH4132 (826.4Hz)

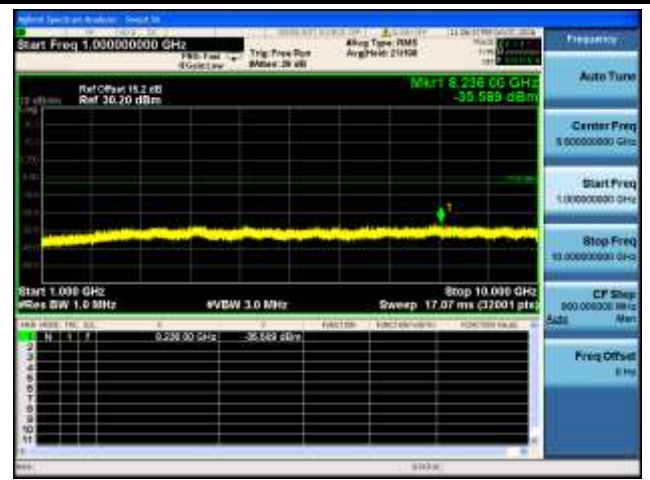
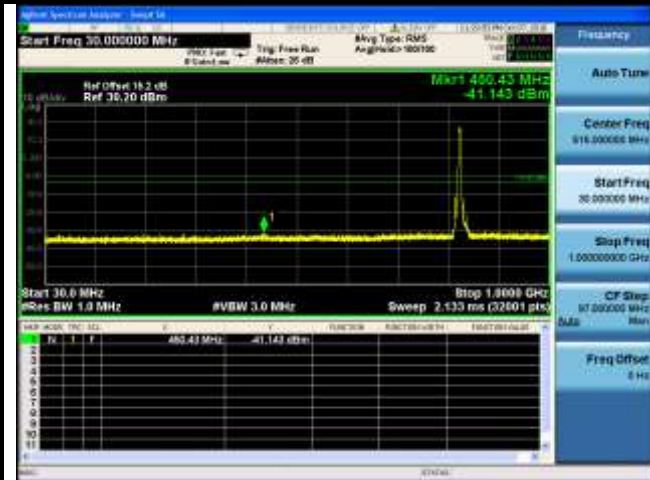

WCDMA Band V-CH4182 (836.4Hz)

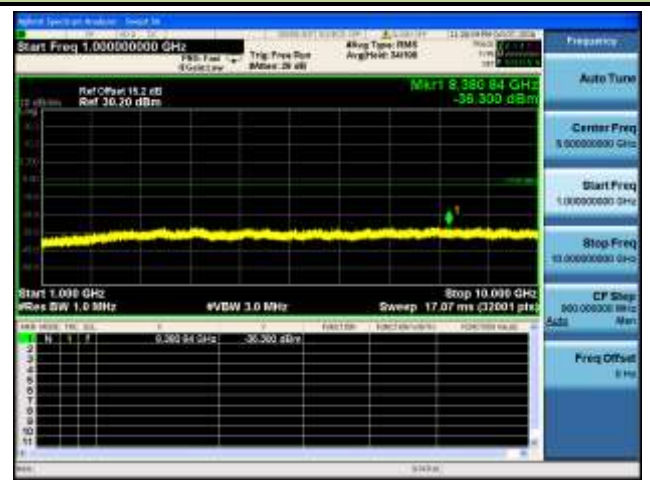
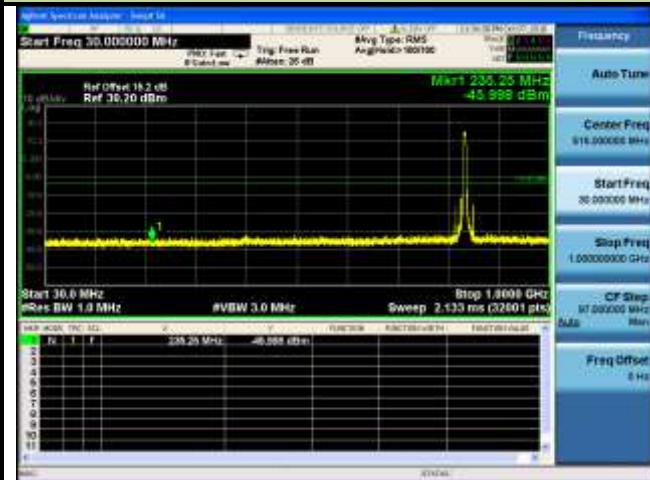

WCDMA Band V-CH4233 (846.6Hz)

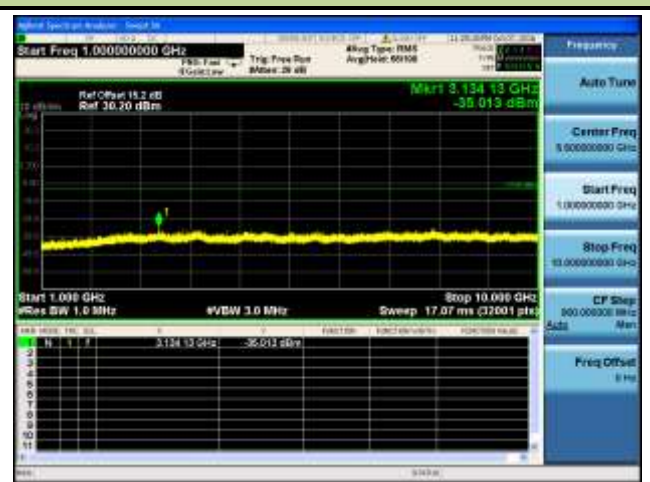
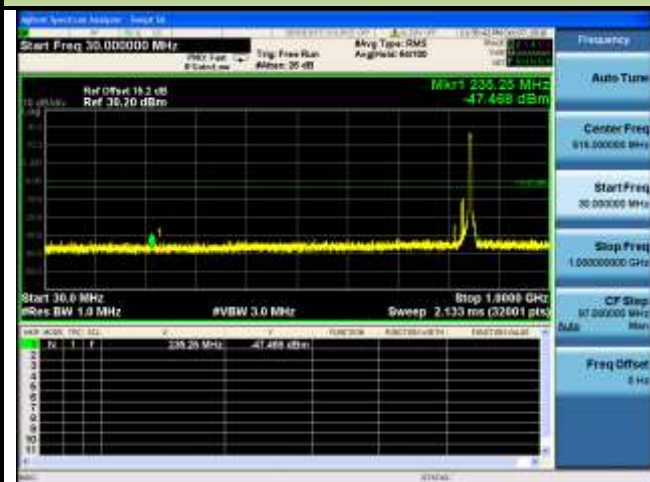

7.4. Band Edge at Antenna Terminal

7.4.1. Test Limit

The power of any emission outside of the authorized operating frequency ranges must be attenuated below the transmitting power (P) by a factor of at least $43 + 10\log_{10}(P)$ dB.

7.4.2. Test Procedure Used

KDB 971168 D01v03 – Section 6.0 & ANSI/TIA-603-E-2016

7.4.3. Test Setting

In the 1 MHz bands immediately outside and adjacent to the frequency block a resolution bandwidth of at least one percent of the emission bandwidth of the fundamental emission of the transmitter may be employed. A narrower resolution bandwidth is permitted in all cases to improve measurement accuracy provided the measured power is integrated over the full required measurement bandwidth (i.e. 100 kHz or 1 percent of emission bandwidth, as specified). The emission bandwidth is defined as the width of the signal between two points, one below the carrier center frequency and one above the carrier center frequency, outside of which all emissions are attenuated at least 26 dB below the transmitter power.

7.4.4. Test Setup

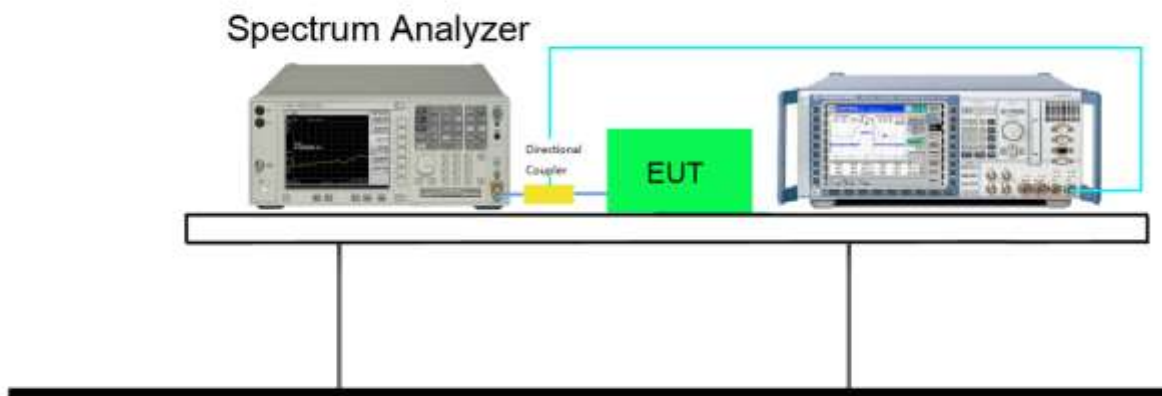

7.4.5. Test Result

Mode	Channel No.	Frequency (MHz)	Modulation	Test Result
GSM850	128	824.20	GMSK	Pass
GSM850	251	848.80	GMSK	Pass
PCS1900	512	1850.20	GMSK	Pass
PCS1900	810	1909.80	GMSK	Pass
EGPRS850	128	824.20	8PSK	Pass
EGPRS850	251	848.80	8PSK	Pass
EGPRS1900	512	1850.20	8PSK	Pass
EGPRS1900	810	1909.80	8PSK	Pass
CDMA 850	1013	824.7	QPSK	Pass
CDMA 850	777	848.31	QPSK	Pass
CDMA 1900	25	1851.25	QPSK	Pass
CDMA 1900	1175	1908.75	QPSK	Pass
EVDO 850	1013	824.7	QPSK	Pass
EVDO 850	777	848.31	QPSK	Pass
EVDO 1900	25	1851.25	QPSK	Pass
EVDO 1900	1175	1908.75	QPSK	Pass
WCDMA Band II	9262	1852.4	QPSK	Pass
WCDMA Band II	9538	1907.6	QPSK	Pass
WCDMA Band V	4132	826.40	QPSK	Pass
WCDMA Band V	4233	846.60	QPSK	Pass

GPRS 850-CH128

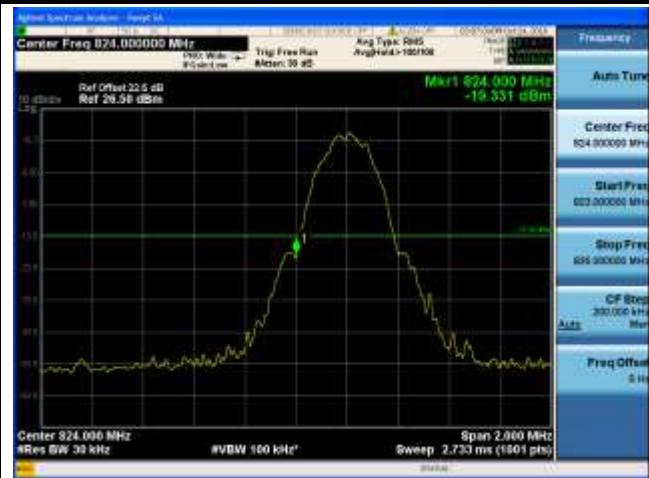

GPRS 850-CH251

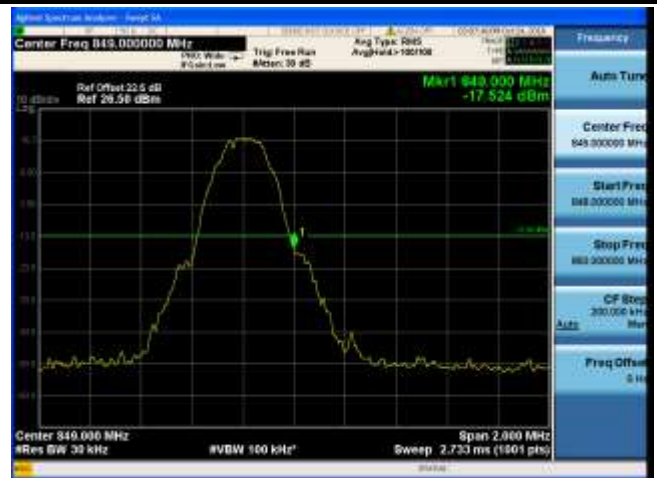

PCS 1900-CH512

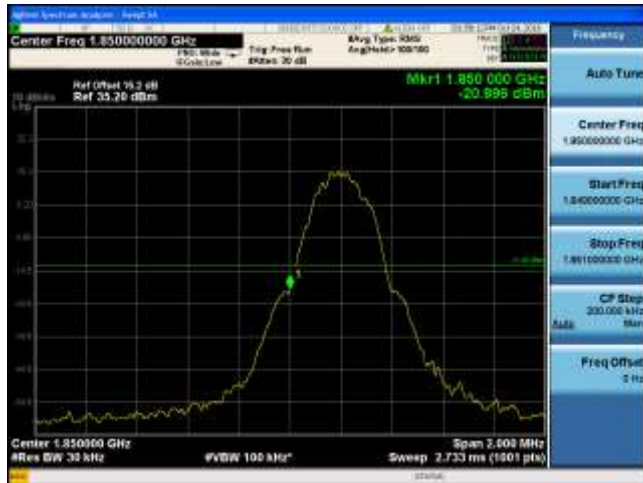

PCS 1900-CH810



EGPRS 850-CH128

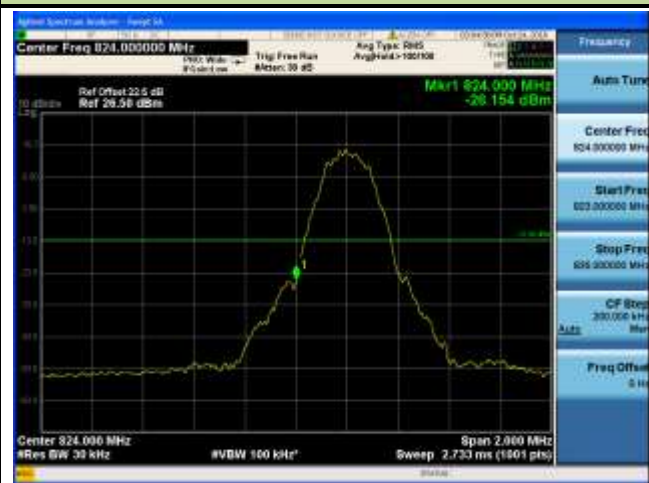

EGPRS 850-CH251

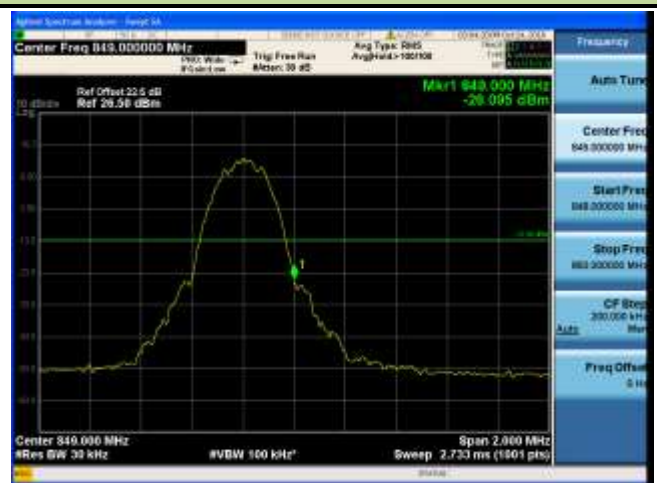

EGPRS 1900-CH512

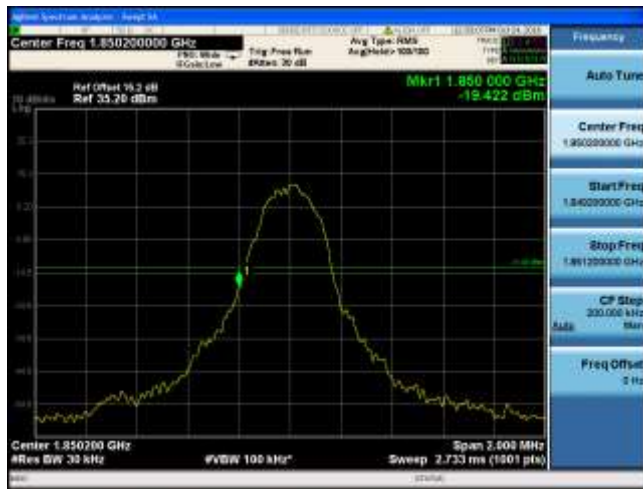

EGPRS 1900-CH810



CDMA 850-CH1013

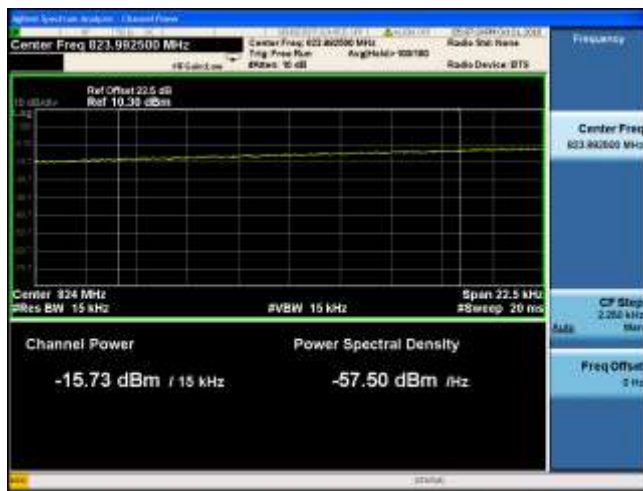

CDMA 850-CH777

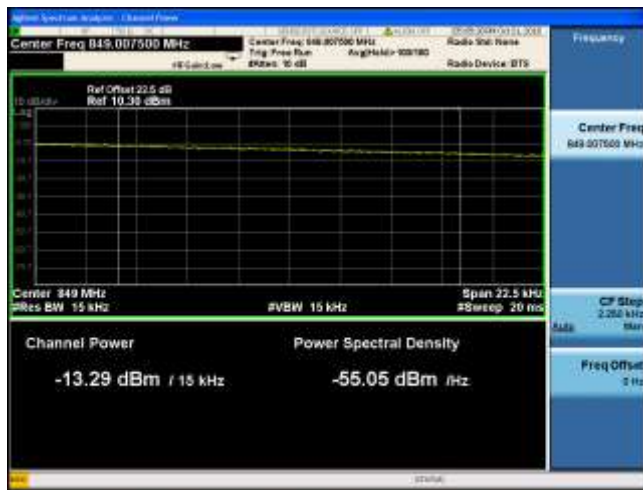

CDMA 1900-CH25



CDMA 1900-CH1175

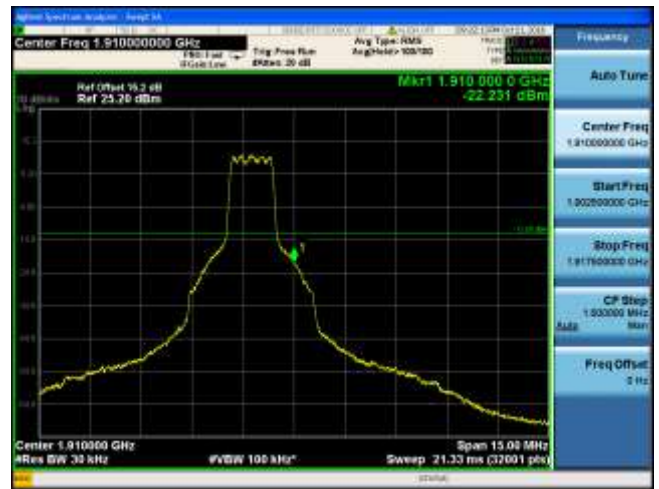

EVDO 850-CH1013

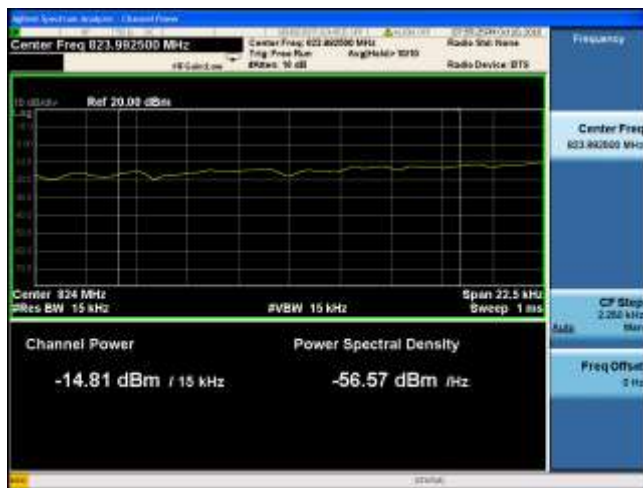

EVDO 850-CH777

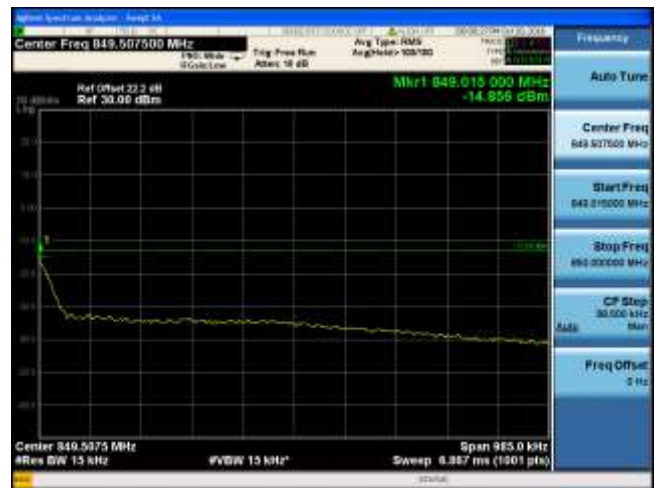
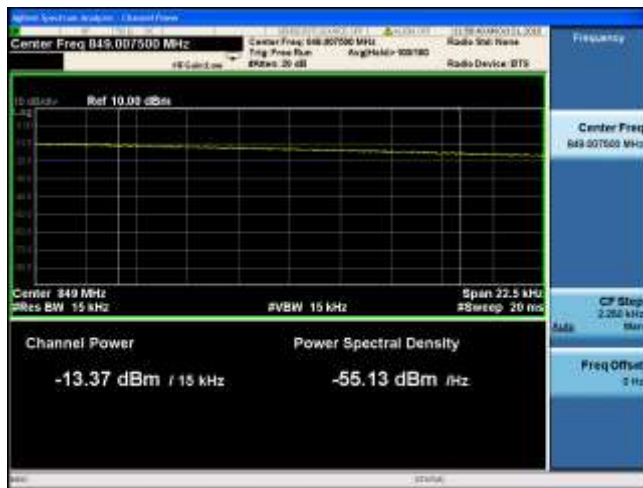

EVDO 1900-CH25

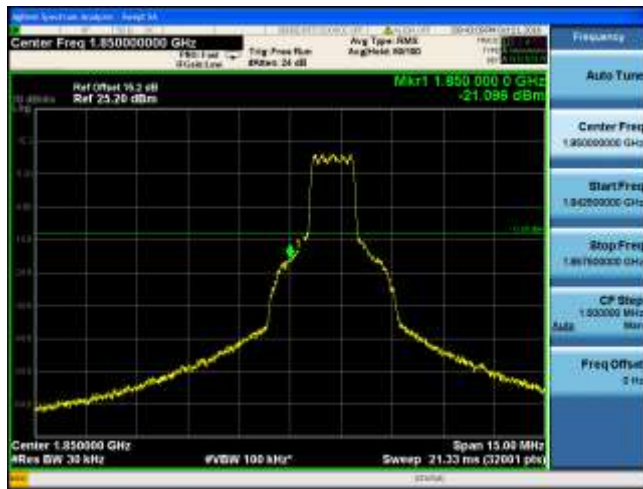

EVDO 1900-CH1175

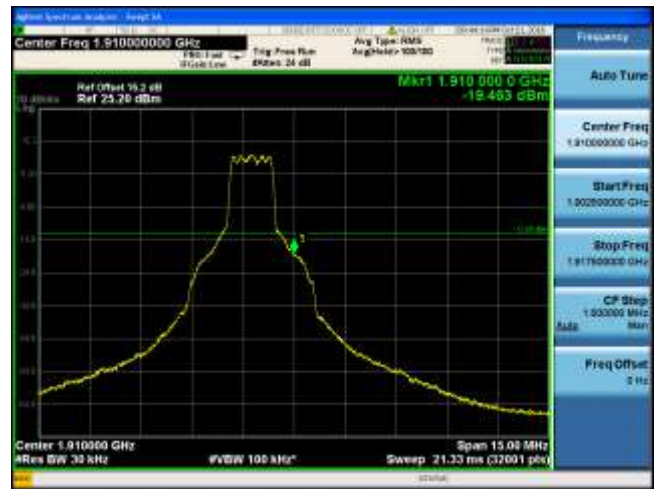

WCDMA Band II-CH9262



WCDMA Band II-CH9538



WCDMA Band V-CH4132



WCDMA Band V-CH4233



7.5. Power and Radiated Spurious Emissions

7.5.1 Test Limit

Radiated Power

For FCC Part 22.913(a)(2):

The ERP of mobile transmitters and auxiliary test transmitters must not exceed 7 Watts.

For FCC Part 24.232(b):

The EIRP of mobile transmitters and auxiliary test transmitters must not exceed 2 Watts.

Radiated Spurious Emissions

The power of any emission outside of the authorized operating frequency ranges must be attenuated below the transmitting power (P) by a factor of at least $43 + 10\log_{10}(P)$ dB.

7.5.2 Test Procedure Used

KDB 971168 D01v03 - Section 7.0 & ANSI/TIA-603-E-2016

7.5.3 Test Setting

1. The EUT shall be placed at the specified height on a support, and in the position closest to normal use as declared by provider.
2. The test antenna shall be oriented initially for vertical polarization and shall be chosen to correspond to the frequency of the transmitter
3. The output of the test antenna shall be connected to the measuring receiver.
4. The transmitter shall be switched on and the measuring receiver shall be tuned to the frequency of the transmitter under test.
5. The test antenna shall be raised and lowered through the specified range of height until a maximum signal level is detected by the measuring receiver.
6. The transmitter shall then be rotated through 360° in the horizontal plane, until the maximum signal level is detected by the measuring receiver.

7. The test antenna shall be raised and lowered again through the specified range of height until a maximum signal level is detected by the measuring receiver.
8. The maximum signal level detected by the measuring receiver shall be noted.
9. The transmitter shall be replaced by a substitution antenna.
10. The substitution antenna shall be orientated for vertical polarization and the length of the substitution antenna shall be adjusted to correspond to the frequency of the transmitter.
11. The substitution antenna shall be connected to a calibrated signal generator.
12. If necessary, the input attenuator setting of the measuring receiver shall be adjusted in order to increase the sensitivity of the measuring receiver.
13. The test antenna shall be raised and lowered through the specified range of height to ensure that the maximum signal is received.
14. The input signal to the substitution antenna shall be adjusted to the level that produces a level detected by the measuring receiver, that is equal to the level noted while the transmitter radiated power was measured, corrected for the change of input attenuator setting of the measuring receiver.
15. The measurement shall be repeated with the test antenna and the substitution antenna orientated for horizontal polarization.
16. The measure of the effective radiated power is the larger of the two levels recorded at the input to the substitution antenna, corrected for gain of the substitution antenna if necessary.
17. Test site anechoic chamber refer to ANSI C63.4: 2014.

7.5.4 Test Setup

Conducted Power

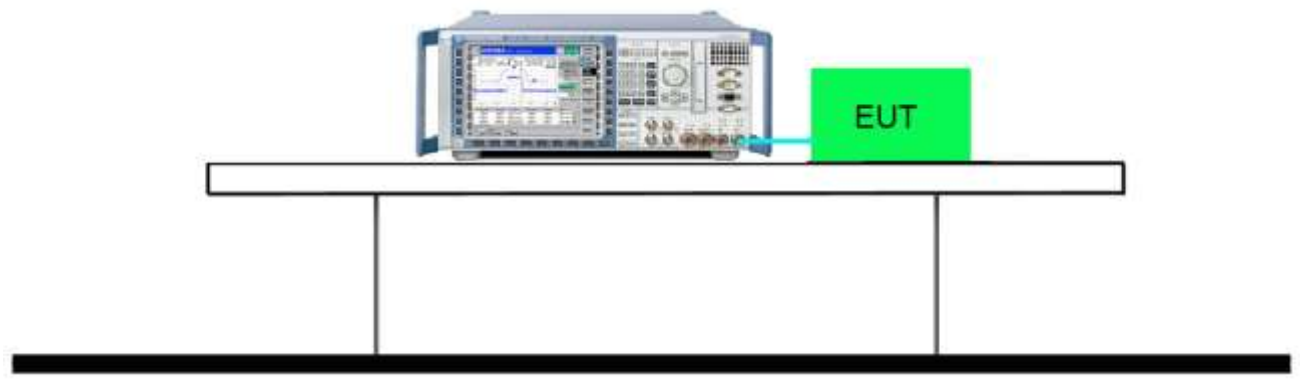

Radiated Power & Radiated Spurious Emissions

30MHz ~ 1GHz Test Setup:

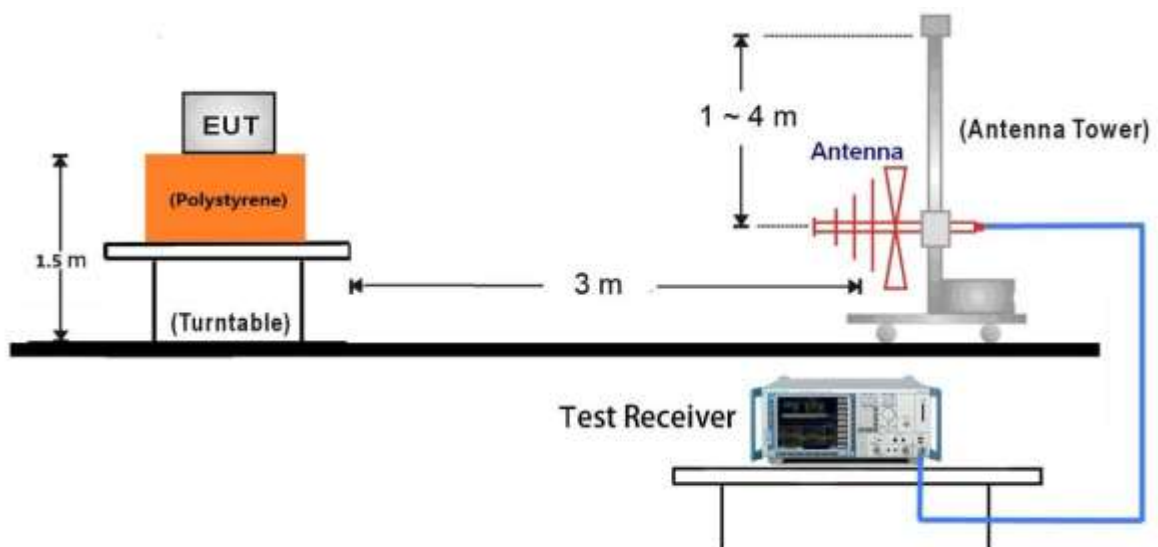

1GHz ~ 10GHz Test Setup:

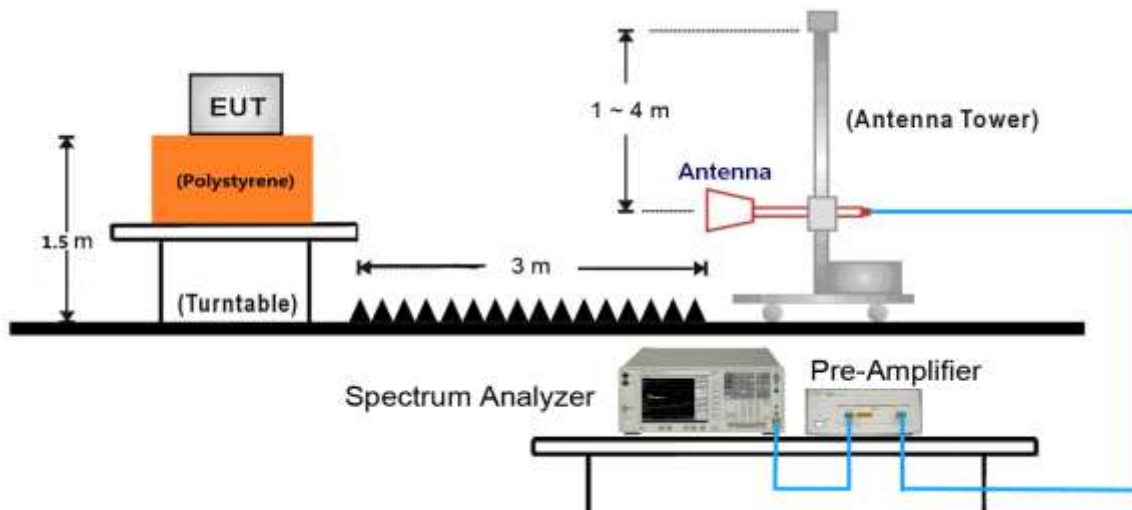

7.5.5 Test Result

Conducted Power

2G-GSM Mode	Channel No.	Frequency (MHz)	Conducted Power		
			Peak Power (dBm)	Duty Cycle Factor (dB)	Average Power(dBm)
GSM 850	128	824.2	32.40	-9.03	23.37
	190	836.6	32.40	-9.03	23.37
	251	848.8	32.30	-9.03	23.27
GPRS 850 (1 Slot)	128	824.2	32.40	-9.03	23.37
	190	836.6	32.40	-9.03	23.37
	251	848.8	32.30	-9.03	23.27
GPRS 850 (2 Slot)	128	824.2	31.80	-6.02	25.78
	190	836.6	31.80	-6.02	25.78
	251	848.8	31.80	-6.02	25.78
GPRS 850 (3 Slot)	128	824.2	30.20	-4.26	25.94
	190	836.6	30.20	-4.26	25.94
	251	848.8	30.20	-4.26	25.94
GPRS 850 (4 Slot)	128	824.2	29.20	-3.01	26.19
	190	836.6	29.10	-3.01	26.09
	251	848.8	29.00	-3.01	25.99
PCS 1900	512	1850.2	30.00	-9.03	20.97
	661	1880.0	30.20	-9.03	21.17
	810	1909.8	30.30	-9.03	21.27
GPRS 1900 (1 Slot)	512	1850.2	30.00	-9.03	20.97
	661	1880.0	30.20	-9.03	21.17
	810	1909.8	30.30	-9.03	21.27
GPRS 1900 (2 Slot)	512	1850.2	29.40	-6.02	23.38
	661	1880.0	29.60	-6.02	23.58
	810	1909.8	29.70	-6.02	23.68
GPRS 1900 (3 Slot)	512	1850.2	27.80	-4.26	23.54
	661	1880.0	28.00	-4.26	23.74
	810	1909.8	28.20	-4.26	23.94
GPRS 1900 (4 Slot)	512	1850.2	26.60	-3.01	23.59
	661	1880.0	26.90	-3.01	23.89
	810	1909.8	27.20	-3.01	24.19

EGPRS 850 (1 Slot)	128	824.2	27.90	-9.03	18.87
	190	836.6	27.80	-9.03	18.77
	251	848.8	27.70	-9.03	18.67
EGPRS 850 (2 Slot)	128	824.2	26.90	-6.02	20.88
	190	836.6	26.80	-6.02	20.78
	251	848.8	26.70	-6.02	20.68
EGPRS 850 (3 Slot)	128	824.2	25.00	-4.26	20.74
	190	836.6	24.90	-4.26	20.64
	251	848.8	24.80	-4.26	20.54
EGPRS 850 (4 Slot)	128	824.2	23.90	-3.01	20.89
	190	836.6	23.80	-3.01	20.79
	251	848.8	23.70	-3.01	20.69
EGPRS 1900 (1 Slot)	512	1850.2	27.30	-9.03	18.27
	661	1880	27.40	-9.03	18.37
	810	1909.8	27.60	-9.03	18.57
EGPRS 1900 (2 Slot)	512	1850.2	26.20	-9.03	17.17
	661	1880	26.30	-9.03	17.27
	810	1909.8	26.40	-9.03	17.37
EGPRS 1900 (3 Slot)	512	1850.2	24.20	-6.02	18.18
	661	1880	24.30	-6.02	18.28
	810	1909.8	24.40	-6.02	18.38
EGPRS 1900 (4 Slot)	512	1850.2	23.00	-4.26	18.74
	661	1880	23.10	-4.26	18.84
	810	1909.8	23.20	-4.26	18.94

3G-WCDMA Mode	3GPP Subtest	Conducted Power (dBm)			MPR
		Band II Channel			
		CH 9262 (1852.4MHz)	CH 9400 (1880MHz)	CH 9538 (1907.6MHz)	
WCDMA R99	N/A	24.74	24.93	24.98	N/A
Rel5 HSDPA	1	23.57	23.86	24.11	0
	2	22.39	22.73	23.28	0
	3	21.74	21.66	22.36	0.5
	4	21.66	21.61	22.02	0.5
Rel6 HSUPA	1	23.49	23.63	23.14	0
	2	23.26	23.42	23.87	2
	3	22.96	23.20	23.61	1
	4	22.77	22.98	23.39	2
	5	22.55	22.84	24.02	0
3G-WCDMA Mode	3GPP Subtest	Conducted Power (dBm)			MPR
		Band V Channel			
		CH 4132 (826.4MHz)	CH 4182 (836.4MHz)	CH 4233 (846.6MHz)	
WCDMA R99	N/A	23.45	23.48	23.32	N/A
Rel5 HSDPA	1	22.24	21.95	22.19	0
	2	22.13	22.02	21.98	0
	3	21.86	21.51	21.83	0.5
	4	21.84	21.75	21.78	0.5
Rel6 HSUPA	1	22.13	22.08	22.03	0
	2	21.76	21.64	21.63	2
	3	21.95	21.98	21.89	1
	4	21.84	21.67	21.77	2
	5	22.28	22.11	22.13	0

3G-CDMA Mode		Conducted Power (dBm)-BC0		
Radio Configuration (RC)	Service Option (SO)	CH 1013 (824.7MHz)	CH 384 (836.52MHz)	CH 777 (848.31MHz)
RC1	2(Loopback)	25.13	24.29	24.11
	55(Loopback)	25.12	24.17	24.07
RC2	9(Loopback)	25.09	24.70	24.11
	55(Loopback)	25.01	24.20	24.03
RC3	2(Loopback)	25.20	23.26	24.12
	55(Loopback)	25.03	24.19	24.10
	32(+F-CH)	25.0	24.18	23.93
	32(+SCH)	25.56	24.71	24.39
RC4	2(Loopback)	25.19	23.30	24.13
	55(Loopback)	25.03	24.18	24.07
	32(+F-CH)	25.28	24.32	24.02
	32(+SCH)	25.65	24.76	24.41
RC5	9(Loopback)	25.18	23.90	24.09
	55(Loopback)	25.01	24.16	24.05
3G-CDMA Mode		Conducted Power (dBm)-BC1		
Radio Configuration (RC)	Service Option (SO)	CH 25 (1851.25MHz)	CH 600 (1880MHz)	CH 1175 (1908.75MHz)
RC1	2(Loopback)	24.81	24.45	25.15
	55(Loopback)	24.68	24.49	25.15
RC2	9(Loopback)	24.74	24.48	25.15
	55(Loopback)	24.68	24.47	25.13
RC3	2(Loopback)	24.83	24.53	25.17
	55(Loopback)	24.77	24.54	25.19
	32(+F-CH)	24.74	24.58	25.21
	32(+SCH)	25.42	24.49	25.40
RC4	2(Loopback)	24.81	24.52	25.18
	55(Loopback)	24.77	24.56	25.20
	32(+F-CH)	24.85	24.55	25.27
	32(+SCH)	24.86	24.69	25.18
RC5	9(Loopback)	24.79	24.05	25.16
	55(Loopback)	24.78	24.54	25.21

3G-EVDO Mode			Conducted Power (dBm)		
Release	FTAP Rate	RTAP Rate	BC0		
			CH 1013 (824.7MHz)	CH 384 (836.52MHz)	CH 777 (848.31MHz)
0	307.2kbps (2 Slot QPSK)	153.6kbps	25.27	25.68	24.45
Release	FETAP Traffic Format	RETAP Payload Size	BC0		
			CH 1013 (824.7MHz)	CH 384 (836.52MHz)	CH 777 (848.31MHz)
A	307.2K, QPSK/ACK Channel is transmitted at all the slots	4096	25.31	25.34	24.53
Release	FTAP Rate	RTAP Rate	BC1		
			CH 25 (1851.25MHz)	CH 600 (1880MHz)	CH 1175 (1908.75MHz)
0	307.2kbps (2 Slot QPSK)	153.6kbps	24.46	24.78	24.91
Release	FETAP Traffic Format	RETAP Payload Size	BC1		
			CH 25 (1851.25MHz)	CH 600 (1880MHz)	CH 1175 (1908.75MHz)
A	307.2K, QPSK/ACK Channel is transmitted at all the slots	4096	24.95	24.61	24.93

Radiated Power

GSM(GPRS) 850

Frequency (MHz)	Ant. Pol. (H/V)	SA Reading (dBm)	Cable Loss (dB)	Substitute Antenna Gain (dBd)	ERP (dBm)	Limit (dBm)	Margin (dB)
CH 128							
824.2	H	29.51	0.87	0.68	29.32	38.5	-9.18
824.2	V	26.94	0.87	0.68	26.75	38.5	-11.75
CH 190							
836.6	H	29.3	0.87	0.68	29.11	38.5	-9.39
836.6	V	25.84	0.87	0.68	25.65	38.5	-12.85
CH 251							
848.8	H	30.04	0.88	0.68	29.84	38.5	-8.66
848.8	V	25.33	0.88	0.68	25.13	38.5	-13.37

GSM(GPRS) 1900

Frequency (MHz)	Ant. Pol. (H/V)	SA Reading (dBm)	Cable Loss (dB)	Substitute Antenna Gain (dBi)	EIRP (dBm)	Limit (dBm)	Margin (dB)
CH 512							
1850.2	H	17.94	1.71	10.04	26.27	38.5	-6.73
1850.2	V	19.51	1.71	10.04	27.84	38.5	-5.16
CH 661							
1880	H	17.87	1.71	10.04	26.2	38.5	-6.8
1880	V	19.04	1.71	10.04	27.37	38.5	-5.63
CH 810							
1909.8	H	18.96	1.71	10.04	27.29	38.5	-5.71
1909.8	V	18.69	1.71	10.04	27.02	38.5	-5.98

NOTES:

- ERP (dBm) / EIRP (dBm)=
SG (dBm) - Cable Loss (dB) + Substitute Antenna Gain (dBd/dBi)
- This unit was tested with its standard adapter.
- The EUT was tested in three orthogonal planes and in all possible test configurations and positioning.

EGPRS 850

Frequency (MHz)	Ant. Pol. (H/V)	SA Reading (dBm)	Cable Loss (dB)	Substitute Antenna Gain (dBd)	ERP (dBm)	Limit (dBm)	Margin (dB)
CH 128							
824.2	H	23.82	0.87	0.68	23.63	38.5	-14.87
824.2	V	21.44	0.87	0.68	21.25	38.5	-17.25
CH 190							
836.6	H	22.51	0.87	0.68	22.32	38.5	-16.18
836.6	V	21.24	0.87	0.68	21.05	38.5	-17.45
CH 251							
848.8	H	23.12	0.88	0.68	22.92	38.5	-15.58
848.8	V	21.23	0.88	0.68	21.03	38.5	-17.47

EGPRS 1900

Frequency (MHz)	Ant. Pol. (H/V)	SA Reading (dBm)	Cable Loss (dB)	Substitute Antenna Gain (dBi)	EIRP (dBm)	Limit (dBm)	Margin (dB)
CH 512							
1850.2	H	12.98	1.71	10.04	21.31	33	-11.69
1850.2	V	12	1.71	10.04	20.33	33	-12.67
CH 661							
1880	H	13.51	1.71	10.04	21.84	33	-11.16
1880	V	12.11	1.71	10.04	20.44	33	-12.56
CH 810							
1909.8	H	13.1	1.71	10.04	21.43	33	-11.57
1909.8	V	12.14	1.71	10.04	20.47	33	-12.53

NOTES:

- ERP (dBm) / EIRP (dBm)=
SG (dBm) - Cable Loss (dB) + Substitute Antenna Gain (dBd/dBi)
- This unit was tested with its standard adapter.
- The EUT was tested in three orthogonal planes and in all possible test configurations and positioning.

WCDMA Band V 850

Frequency (MHz)	Ant. Pol. (H/V)	SA Reading (dBm)	Cable Loss (dB)	Substitute Antenna Gain (dBd)	ERP (dBm)	Limit (dBm)	Margin (dB)
CH 4132							
826.4	H	19.67	0.87	0.68	19.48	38.5	-19.02
826.4	V	14.29	0.87	0.68	14.1	38.5	-24.4
CH 4182							
836.4	H	19.69	0.87	0.68	19.5	38.5	-19
836.4	V	14.62	0.87	0.68	14.43	38.5	-24.07
CH 4233							
846.6	H	19.91	0.88	0.68	19.71	38.5	-18.79
846.6	V	14.72	0.88	0.68	14.52	38.5	-23.98

WCDMA Band II 1900

Frequency (MHz)	Ant. Pol. (H/V)	SA Reading (dBm)	Cable Loss (dB)	Substitute Antenna Gain (dBi)	EIRP (dBm)	Limit (dBm)	Margin (dB)
CH 9262							
1852.4	H	17.38	1.71	10.04	25.71	33	-7.29
1852.4	V	15.82	1.71	10.04	24.15	33	-8.85
CH 9400							
1880	H	18.13	1.71	10.04	26.46	33	-6.54
1880	V	15.84	1.71	10.04	24.17	33	-8.83
CH 4233							
1907.6	H	18.67	1.71	10.04	27	33	-6
1907.6	V	15.92	1.71	10.04	24.25	33	-8.75

NOTES:

- ERP (dBm) / EIRP (dBm)=
SG (dBm) - Cable Loss (dB) + Substitute Antenna Gain (dBd/dBi)
- This unit was tested with its standard adapter.
- The EUT was tested in three orthogonal planes and in all possible test configurations and positioning.

CDMA BC0 850

Frequency (MHz)	Ant. Pol. (H/V)	SA Reading (dBm)	Cable Loss (dB)	Substitute Antenna Gain (dBd)	ERP (dBm)	Limit (dBm)	Margin (dB)
CH 1013							
824.7	H	16.73	0.87	0.68	16.54	38.5	-21.96
824.7	V	13.83	0.87	0.68	13.64	38.5	-24.86
CH 384							
836.52	H	17.1	0.87	0.68	16.91	38.5	-21.59
836.52	V	14.95	0.87	0.68	14.76	38.5	-23.74
CH 777							
848.31	H	16.18	0.88	0.68	15.98	38.5	-22.52
848.31	V	14.22	0.88	0.68	14.02	38.5	-24.48

CDMA BC1 1900

Frequency (MHz)	Ant. Pol. (H/V)	SA Reading (dBm)	Cable Loss (dB)	Substitute Antenna Gain (dBi)	EIRP (dBm)	Limit (dBm)	Margin (dB)
CH 25							
1851.25	H	12.19	1.71	10.04	20.52	33	-12.48
1851.25	V	10.79	1.71	10.04	19.12	33	-13.88
CH 600							
1880	H	11.2	1.71	10.04	19.53	33	-13.47
1880	V	11.56	1.71	10.04	19.89	33	-13.11
CH 1175							
1908.75	H	10.03	1.71	10.04	18.36	33	-14.64
1908.75	V	9.63	1.71	10.04	17.96	33	-15.04

NOTES:

- ERP (dBm) / EIRP (dBm)=
SG (dBm) - Cable Loss (dB) + Substitute Antenna Gain (dBd/dBi)
- This unit was tested with its standard adapter.
- The EUT was tested in three orthogonal planes and in all possible test configurations and positioning.

EVDO BC0 850

Frequency (MHz)	Ant. Pol. (H/V)	SA Reading (dBm)	Cable Loss (dB)	Substitute Antenna Gain (dBd)	ERP (dBm)	Limit (dBm)	Margin (dB)
CH 1013							
824.7	H	16.5	0.87	0.68	16.31	38.5	-22.19
824.7	V	13.4	0.87	0.68	13.21	38.5	-25.29
CH 384							
836.52	H	16.68	0.87	0.68	16.49	38.5	-22.01
836.52	V	15.2	0.87	0.68	15.01	38.5	-23.49
CH 777							
848.31	H	16.27	0.88	0.68	16.07	38.5	-22.43
848.31	V	14.07	0.88	0.68	13.87	38.5	-24.63

EVDO BC1 1900

Frequency (MHz)	Ant. Pol. (H/V)	SA Reading (dBm)	Cable Loss (dB)	Substitute Antenna Gain (dBi)	EIRP (dBm)	Limit (dBm)	Margin (dB)
CH 25							
1851.25	H	11.35	1.71	10.04	19.68	33	-13.32
1851.25	V	11.32	1.71	10.04	19.65	33	-13.35
CH 600							
1880	H	11.2	1.71	10.04	19.53	33	-13.47
1880	V	11.1	1.71	10.04	19.43	33	-13.57
CH 1175							
1908.75	H	10.57	1.71	10.04	18.9	33	-14.1
1908.75	V	10.34	1.71	10.04	18.67	33	-14.33

NOTES:

- ERP (dBm) / EIRP (dBm)=
SG (dBm) - Cable Loss (dB) + Substitute Antenna Gain (dBd/dBi)
- This unit was tested with its standard adapter.
- The EUT was tested in three orthogonal planes and in all possible test configurations and positioning.

Radiated Spurious Emission

GSM(GPRS) 850

Frequency (MHz)	Ant. Pol. (H/V)	SA Reading (dBm)	Cable Loss (dB)	Substitute Antenna Gain (dBi)	EIRP (dBm)	Limit (dBm)	Margin (dB)
CH 128							
2472.6	H	-35.53	1.91	10.75	-26.69	-13	-13.69
4121	H	-35.97	3.3	12.45	-26.82	-13	-13.82
5769.4	H	-44.02	4.12	13	-35.14	-13	-22.14
2472.6	V	-38.02	1.91	10.75	-29.18	-13	-16.18
4121	V	-35.57	3.3	12.45	-26.42	-13	-13.42
5769.4	V	-46.07	4.12	13	-37.19	-13	-24.19
CH 189							
2509.8	H	-35.31	1.91	10.75	-26.47	-13	-13.47
4183	H	-35.98	3.3	12.45	-26.83	-13	-13.83
5856.05	H	-44.89	4.12	13	-36.01	-13	-23.01
2509.8	V	-31.81	1.91	10.75	-22.97	-13	-9.97
4183	V	-35.78	3.3	12.45	-26.63	-13	-13.63
5856.2	V	-46.24	4.12	13	-37.36	-13	-24.36
CH 251							
2546.4	H	-35.21	1.91	10.75	-26.37	-13	-13.37
4244	H	-35.75	3.3	12.45	-26.6	-13	-13.6
5941.6	H	-44.21	4.12	13	-35.33	-13	-22.33
2546.4	V	-31.56	1.91	10.75	-22.72	-13	-9.72
4244	V	-35.59	3.3	12.45	-26.44	-13	-13.44
5941.6	V	-45.57	4.12	13	-36.69	-13	-23.69

Note:

- Spurious emissions within 30-1000MHz & Other harmonic were found more than 20dB below limit line.
- $EIRP (dBm) = SG (dBm) - Cable Loss (dB) + Substitute Antenna Gain (dBi)$

GSM(GPRS) 1900

Frequency (MHz)	Ant. Pol. (H/V)	SA Reading (dBm)	Cable Loss (dB)	Substitute Antenna Gain (dBi)	EIRP (dBm)	Limit (dBm)	Margin (dB)
CH 512							
3700.4	H	-57.94	3.05	12.32	-48.67	-13	-35.67
5550.6	H	-56.35	4.02	13.02	-47.35	-13	-34.35
3700.4	V	-60.03	3.05	12.32	-50.76	-13	-37.76
5550.6	V	-58.58	4.02	13.02	-49.58	-13	-36.58
CH 661							
3760	H	-58.61	3.05	12.32	-49.34	-13	-36.34
5640	H	-56.56	4.02	13.02	-47.56	-13	-34.56
3760	V	-60.81	3.05	12.32	-51.54	-13	-38.54
5640	V	-58.91	4.02	13.02	-49.91	-13	-36.91
CH 810							
3819.6	H	-57.16	3.05	12.32	-47.89	-13	-34.89
5729.4	H	-54.56	4.02	13.02	-45.56	-13	-32.56
3819.6	V	-59.62	3.05	12.32	-50.35	-13	-37.35
5729.4	V	-56.95	4.02	13.02	-47.95	-13	-34.95

Note:

- Spurious emissions within 30-1000MHz & Other harmonic were found more than 20dB below limit line.
- $EIRP (dBm) = SG (dBm) - Cable Loss (dB) + Substitute Antenna Gain (dBi)$

EGPRS 850

Frequency (MHz)	Ant. Pol. (H/V)	SA Reading (dBm)	Cable Loss (dB)	Substitute Antenna Gain (dBi)	EIRP (dBm)	Limit (dBm)	Margin (dB)
CH 128							
2472.6	H	-35.53	1.91	10.75	-26.69	-13	-13.69
4121	H	-35.97	3.3	12.45	-26.82	-13	-13.82
5769.4	H	-44.02	4.12	13	-35.14	-13	-22.14
2472.6	V	-38.02	1.91	10.75	-29.18	-13	-16.18
4121	V	-35.57	3.3	12.45	-26.42	-13	-13.42
5769.4	V	-46.07	4.12	13	-37.19	-13	-24.19
CH 189							
2509.8	H	-35.31	1.91	10.75	-26.47	-13	-13.47
4183	H	-35.98	3.3	12.45	-26.83	-13	-13.83
5856.05	H	-44.89	4.12	13	-36.01	-13	-23.01
2509.8	V	-31.81	1.91	10.75	-22.97	-13	-9.97
4183	V	-35.78	3.3	12.45	-26.63	-13	-13.63
5856.2	V	-46.24	4.12	13	-37.36	-13	-24.36
CH 251							
2546.4	H	-35.21	1.91	10.75	-26.37	-13	-13.37
4244	H	-35.75	3.3	12.45	-26.6	-13	-13.6
5941.6	H	-44.21	4.12	13	-35.33	-13	-22.33
2546.4	V	-31.56	1.91	10.75	-22.72	-13	-9.72
4244	V	-35.59	3.3	12.45	-26.44	-13	-13.44
5941.6	V	-45.57	4.12	13	-36.69	-13	-23.69

Note:

- Spurious emissions within 30-1000MHz & Other harmonic were found more than 20dB below limit line.
- $EIRP (dBm) = SG (dBm) - Cable Loss (dB) + Substitute Antenna Gain (dBi)$

EGPRS 1900

Frequency (MHz)	Ant. Pol. (H/V)	SA Reading (dBm)	Cable Loss (dB)	Substitute Antenna Gain (dBi)	EIRP (dBm)	Limit (dBm)	Margin (dB)
CH 512							
3700.4	H	-57.94	3.05	12.32	-48.67	-13	-35.67
5550.6	H	-56.35	4.02	13.02	-47.35	-13	-34.35
3700.4	V	-60.03	3.05	12.32	-50.76	-13	-37.76
5550.6	V	-58.58	4.02	13.02	-49.58	-13	-36.58
CH 661							
3760	H	-58.61	3.05	12.32	-49.34	-13	-36.34
5640	H	-56.56	4.02	13.02	-47.56	-13	-34.56
3760	V	-60.81	3.05	12.32	-51.54	-13	-38.54
5640	V	-58.91	4.02	13.02	-49.91	-13	-36.91
CH 810							
3819.6	H	-57.16	3.05	12.32	-47.89	-13	-34.89
5729.4	H	-54.56	4.02	13.02	-45.56	-13	-32.56
3819.6	V	-59.62	3.05	12.32	-50.35	-13	-37.35
5729.4	V	-56.95	4.02	13.02	-47.95	-13	-34.95

Note:

- Spurious emissions within 30-1000MHz & Other harmonic were found more than 20dB below limit line.
- $EIRP (dBm) = SG (dBm) - Cable Loss (dB) + Substitute Antenna Gain (dBi)$

WCDMA Band V-850

Frequency (MHz)	Ant. Pol. (H/V)	SA Reading (dBm)	Cable Loss (dB)	Substitute Antenna Gain (dBi)	EIRP (dBm)	Limit (dBm)	Margin (dB)
CH 4132							
4132	H	-65.71	3.3	12.46	-56.55	-13	-43.55
4958.4	H	-50.82	3.78	12.47	-42.13	-13	-29.13
5784.8	H	-53.15	4.12	13	-44.27	-13	-31.27
4132	V	-66.48	3.3	12.46	-57.32	-13	-44.32
4958.4	V	-47.86	3.78	12.47	-39.17	-13	-26.17
5784.8	V	-59.02	4.12	13	-50.14	-13	-37.14
CH 4182							
4182	H	-65.22	3.3	12.46	-56.06	-13	-43.06
5018.4	H	-50.57	3.78	12.47	-41.88	-13	-28.88
5854.8	H	-53.1	4.12	13	-44.22	-13	-31.22
4182	V	-66.15	3.3	12.46	-56.99	-13	-43.99
5018.4	V	-47.64	3.78	12.47	-38.95	-13	-25.95
5854.8	V	-58.9	4.12	13	-50.02	-13	-37.02
CH 4233							
4233	H	-65.22	3.3	12.46	-56.06	-13	-43.06
5079.6	H	-50.07	3.78	12.47	-41.38	-13	-28.38
5926.2	H	-52.56	4.12	13	-43.68	-13	-30.68
4233	V	-65.22	3.3	12.46	-56.06	-13	-43.06
5079.6	V	-50.07	3.78	12.47	-41.38	-13	-28.38
5926.2	V	-52.56	4.12	13	-43.68	-13	-30.68

Note:

- Spurious emissions within 30-1000MHz & Other harmonic were found more than 20dB below limit line.
- $EIRP (dBm) = SG (dBm) - Cable Loss (dB) + Substitute Antenna Gain (dBi)$

WCDMA Band II-1900

Frequency (MHz)	Ant. Pol. (H/V)	SA Reading (dBm)	Cable Loss (dB)	Substitute Antenna Gain (dBi)	EIRP (dBm)	Limit (dBm)	Margin (dB)
CH 9262							
3704.8	H	-53.27	3.05	12.32	-44	-13	-31
5557.2	H	-56.18	4.02	13.02	-47.18	-13	-34.18
3704.8	V	-56.45	3.05	12.32	-47.18	-13	-34.18
5557.2	V	-58.96	4.02	13.02	-49.96	-13	-36.96
CH 9400							
3760	H	-54.25	3.05	12.32	-44.98	-13	-31.98
5640	H	-56.25	4.02	13.02	-47.25	-13	-34.25
3760	V	-58.16	3.05	12.32	-48.89	-13	-35.89
5640	V	-60.25	4.02	13.02	-51.25	-13	-38.25
CH 9538							
3825.2	H	-54.14	3.05	12.32	-44.87	-13	-31.87
5722.8	H	-55.94	4.02	13.02	-46.94	-13	-33.94
3825.2	V	-57.45	3.05	12.32	-48.18	-13	-35.18
5722.8	V	-59.09	4.02	13.02	-50.09	-13	-37.09

Note:

- Spurious emissions within 30-1000MHz & Other harmonic were found more than 20dB below limit line.
- $EIRP (dBm) = SG (dBm) - Cable Loss (dB) + Substitute Antenna Gain (dBi)$

CDMA BC0-850

Frequency (MHz)	Ant. Pol. (H/V)	SA Reading (dBm)	Cable Loss (dB)	Substitute Antenna Gain (dBi)	EIRP (dBm)	Limit (dBm)	Margin (dB)
CH 1013							
1649.4	H	-54.3	1.05	9.71	-45.64	-13	-32.64
2474.1	H	-71.66	1.91	10.6	-62.97	-13	-49.97
3298.8	H	-63.8	3.05	12.24	-54.61	-13	-41.61
1649.4	V	-55.47	1.05	9.71	-46.81	-13	-33.81
2474.1	V	-75.92	1.91	10.6	-67.23	-13	-54.23
3298.8	V	-64.99	3.05	12.24	-55.8	-13	-42.8
CH 384							
1673.04	H	-62.29	1.05	9.71	-53.63	-13	-40.63
2509.56	H	-71.24	1.91	10.6	-62.55	-13	-49.55
3346.08	H	-60.35	3.05	12.24	-51.16	-13	-38.16
1673.04	V	-63.16	1.05	9.71	-54.5	-13	-41.5
2509.56	V	-68.94	1.91	10.6	-60.25	-13	-47.25
3346.08	V	-63.04	3.05	12.24	-53.85	-13	-40.85
CH 777							
1696.62	H	-66.52	1.05	9.71	-57.86	-13	-44.86
2544.93	H	-74.17	1.91	10.6	-65.48	-13	-52.48
3393.24	H	-62.42	3.05	12.24	-53.23	-13	-40.23
1696.62	V	-65.81	1.05	9.71	-57.15	-13	-44.15
2544.93	V	-71.66	1.91	10.6	-62.97	-13	-49.97
3393.24	V	-62.02	3.05	12.24	-52.83	-13	-39.83

Note:

- Spurious emissions within 30-1000MHz & Other harmonic were found more than 20dB below limit line.
- $EIRP (dBm) = SG (dBm) - Cable Loss (dB) + Substitute Antenna Gain (dBi)$

CDMA BC1-1900

Frequency (MHz)	Ant. Pol. (H/V)	SA Reading (dBm)	Cable Loss (dB)	Substitute Antenna Gain (dBi)	EIRP (dBm)	Limit (dBm)	Margin (dB)
CH 25							
3702.6	H	-51.35	3.05	12.32	-42.08	-13	-29.08
5553.9	H	-56.71	4.02	13.02	-47.71	-13	-34.71
7405.2	H	-47.69	5.31	11.06	-41.94	-13	-28.94
3702.6	V	-49.78	3.05	12.32	-40.51	-13	-27.51
5553.9	V	-57.36	4.02	13.02	-48.36	-13	-35.36
7405.2	V	-47.64	5.31	11.06	-41.89	-13	-28.89
CH 600							
3760	H	-52.07	3.05	12.32	-42.8	-13	-29.8
5640	H	-57.51	4.02	13.02	-48.51	-13	-35.51
7520	H	-49.38	5.31	11.06	-43.63	-13	-30.63
3760	V	-51.23	3.05	12.32	-41.96	-13	-28.96
5640	V	-58.3	4.02	13.02	-49.3	-13	-36.3
7520	V	-49.3	5.31	11.06	-43.55	-13	-30.55
CH 1175							
3817.5	H	-53.05	3.05	12.32	-43.78	-13	-30.78
5726.25	H	-58.15	4.02	13.02	-49.15	-13	-36.15
7635	H	-47.81	5.31	11.06	-42.06	-13	-29.06
3817.5	V	-50.63	3.05	12.32	-41.36	-13	-28.36
5726.25	V	-56	4.02	13.02	-47	-13	-34
7635	V	-48.19	5.31	11.06	-42.44	-13	-29.44

Note:

- Spurious emissions within 30-1000MHz & Other harmonic were found more than 20dB below limit line.
- $EIRP (dBm) = SG (dBm) - Cable Loss (dB) + Substitute Antenna Gain (dBi)$

EVDO BC0-850

Frequency (MHz)	Ant. Pol. (H/V)	SA Reading (dBm)	Cable Loss (dB)	Substitute Antenna Gain (dBi)	EIRP (dBm)	Limit (dBm)	Margin (dB)
CH 1013							
1649.4	H	-54.3	1.05	9.71	-45.64	-13	-32.64
2474.1	H	-71.66	1.91	10.6	-62.97	-13	-49.97
3298.8	H	-63.8	3.05	12.24	-54.61	-13	-41.61
1649.4	V	-55.47	1.05	9.71	-46.81	-13	-33.81
2474.1	V	-75.92	1.91	10.6	-67.23	-13	-54.23
3298.8	V	-64.99	3.05	12.24	-55.8	-13	-42.8
CH 384							
1673.04	H	-62.29	1.05	9.71	-53.63	-13	-40.63
2509.56	H	-71.24	1.91	10.6	-62.55	-13	-49.55
3346.08	H	-60.35	3.05	12.24	-51.16	-13	-38.16
1673.04	V	-63.16	1.05	9.71	-54.5	-13	-41.5
2509.56	V	-68.94	1.91	10.6	-60.25	-13	-47.25
3346.08	V	-63.04	3.05	12.24	-53.85	-13	-40.85
CH 777							
1696.62	H	-66.52	1.05	9.71	-57.86	-13	-44.86
2544.93	H	-74.17	1.91	10.6	-65.48	-13	-52.48
3393.24	H	-62.42	3.05	12.24	-53.23	-13	-40.23
1696.62	V	-65.81	1.05	9.71	-57.15	-13	-44.15
2544.93	V	-71.66	1.91	10.6	-62.97	-13	-49.97
3393.24	V	-62.02	3.05	12.24	-52.83	-13	-39.83

Note:

- Spurious emissions within 30-1000MHz & Other harmonic were found more than 20dB below limit line.
- $EIRP (dBm) = SG (dBm) - Cable Loss (dB) + Substitute Antenna Gain (dBi)$

EVDO BC1-1900

Frequency (MHz)	Ant. Pol. (H/V)	SA Reading (dBm)	Cable Loss (dB)	Substitute Antenna Gain (dBi)	EIRP (dBm)	Limit (dBm)	Margin (dB)
CH 25							
3702.6	H	-51.35	3.05	12.32	-42.08	-13	-29.08
5553.9	H	-56.71	4.02	13.02	-47.71	-13	-34.71
7405.2	H	-47.69	5.31	11.06	-41.94	-13	-28.94
3702.6	V	-49.78	3.05	12.32	-40.51	-13	-27.51
5553.9	V	-57.36	4.02	13.02	-48.36	-13	-35.36
7405.2	V	-47.64	5.31	11.06	-41.89	-13	-28.89
CH 600							
3760	H	-52.07	3.05	12.32	-42.8	-13	-29.8
5640	H	-57.51	4.02	13.02	-48.51	-13	-35.51
7520	H	-49.38	5.31	11.06	-43.63	-13	-30.63
3760	V	-51.23	3.05	12.32	-41.96	-13	-28.96
5640	V	-58.3	4.02	13.02	-49.3	-13	-36.3
7520	V	-49.3	5.31	11.06	-43.55	-13	-30.55
CH 1175							
3817.5	H	-53.05	3.05	12.32	-43.78	-13	-30.78
5726.25	H	-58.15	4.02	13.02	-49.15	-13	-36.15
7635	H	-47.81	5.31	11.06	-42.06	-13	-29.06
3817.5	V	-50.63	3.05	12.32	-41.36	-13	-28.36
5726.25	V	-56	4.02	13.02	-47	-13	-34
7635	V	-48.19	5.31	11.06	-42.44	-13	-29.44

Note:

- Spurious emissions within 30-1000MHz & Other harmonic were found more than 20dB below limit line.
- $EIRP (dBm) = SG (dBm) - Cable Loss (dB) + Substitute Antenna Gain (dBi)$

7.6. Peak-Average Ratio

7.6.1 Test Limit

The transmitter's peak-to-average power ratio (PAPR) shall not exceed 13 dB for more than 0.1% of the time using a signal corresponding to the highest PAPR during periods of continuous transmission.

7.6.2 Test Procedure

KDB 971168 D01v03 - Section 5.7 & ANSI/TIA-603-E-2016

7.6.3 Test Setup

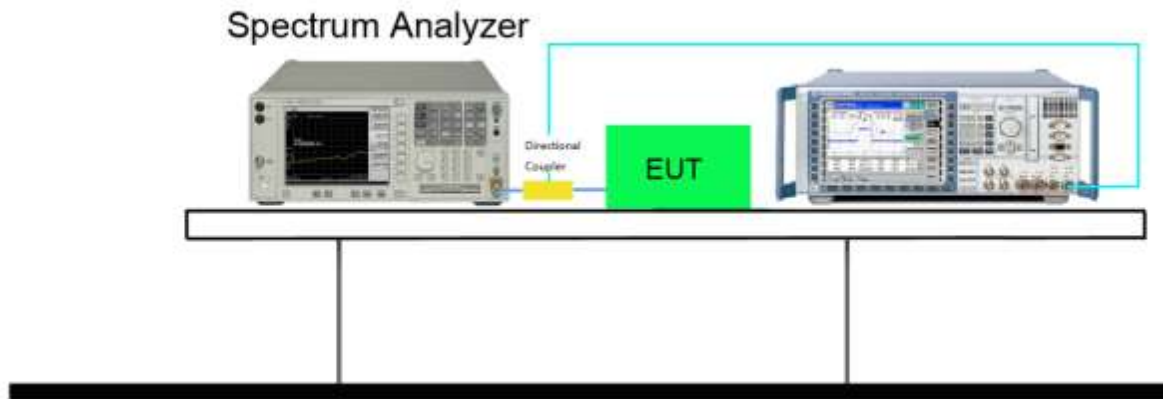

7.6.4 Test Result

Mode	Channel No.	Frequency (MHz)	Modulation	Test Result (13dBm)
GSM850	128	824.20	GMSK	Pass
	190	836.60	GMSK	Pass
	251	848.80	GMSK	Pass
PCS1900	512	1850.20	GMSK	Pass
	661	1880.0	GMSK	Pass
	810	1909.80	GMSK	Pass
EGPRS850	128	824.20	8PSK	Pass
	190	836.60	8PSK	Pass
	251	848.80	8PSK	Pass
EGPRS1900	512	1850.20	8PSK	Pass
	661	1880.0	8PSK	Pass
	810	1909.80	8PSK	Pass
CDMA 850	1013	824.7	QPSK	Pass
	384	836.52	QPSK	Pass
	777	848.31	QPSK	Pass
CDMA 1900	25	1851.25	QPSK	Pass
	600	1880	QPSK	Pass
	1175	1908.75	QPSK	Pass
EVDO 850	1013	824.7	QPSK	Pass
	384	836.52	QPSK	Pass
	777	848.31	QPSK	Pass
EVDO 1900	25	1851.25	QPSK	Pass
	600	1880	QPSK	Pass
	1175	1908.75	QPSK	Pass
WCDMA Band II	9262	1852.4	QPSK	Pass
	9400	1880.0	QPSK	Pass
	9538	1907.6	QPSK	Pass
WCDMA Band V	4132	826.40	QPSK	Pass
	4182	836.4	QPSK	Pass
	4233	846.60	QPSK	Pass

GPRS850-CH128

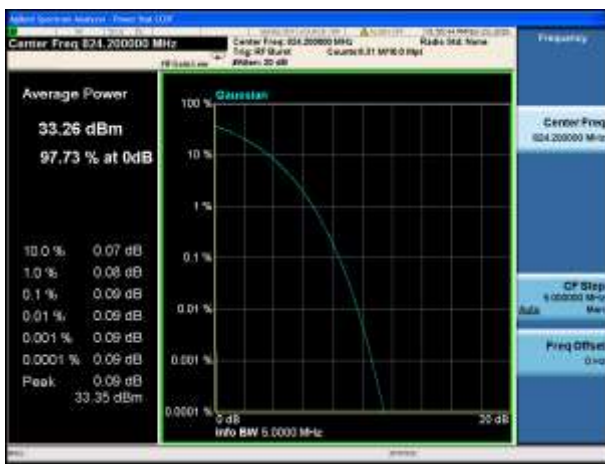

GPRS850-CH190

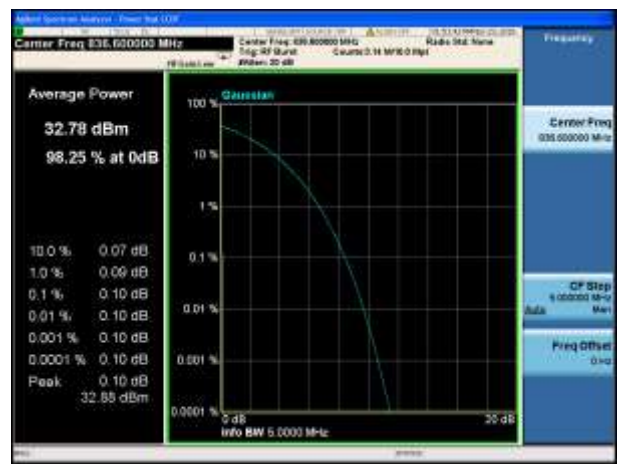

GPRS850-CH251

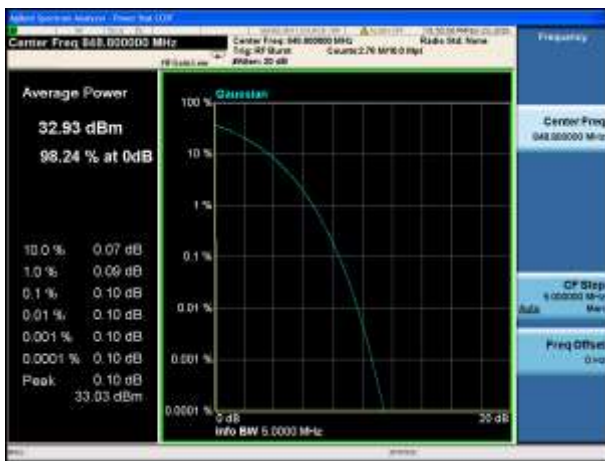

GPRS1900-CH512

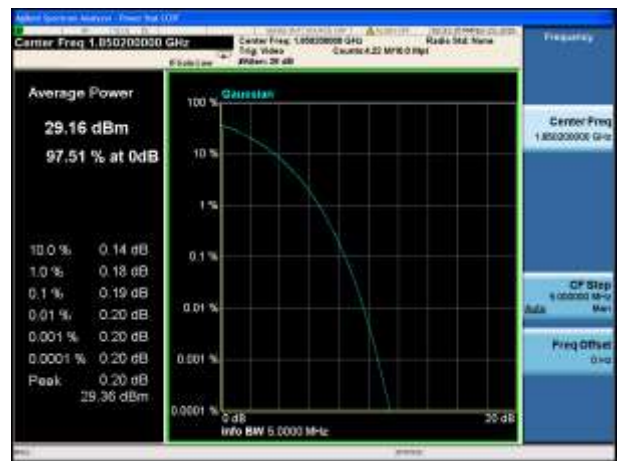

GPRS1900-CH661

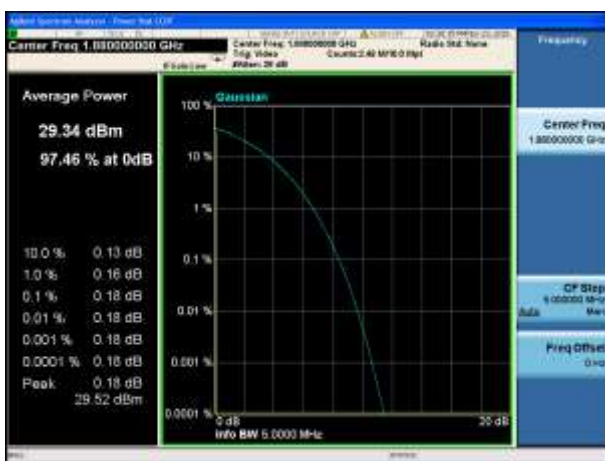

GPRS1900-CH810

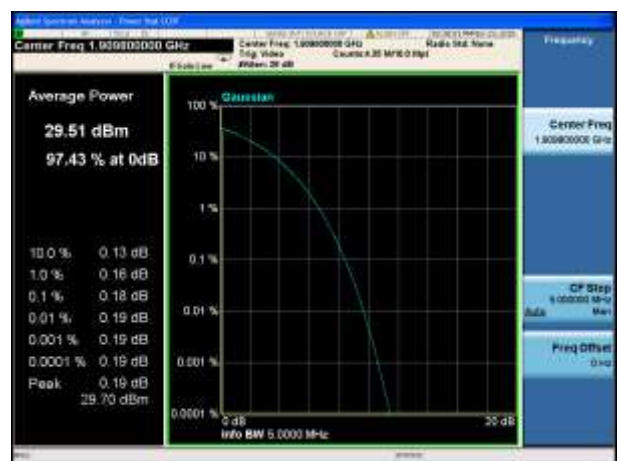

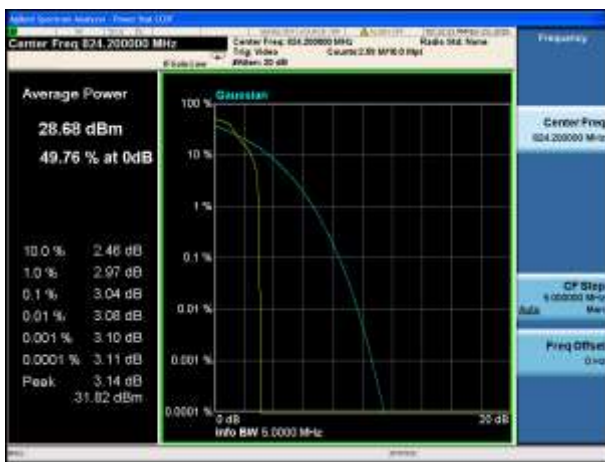
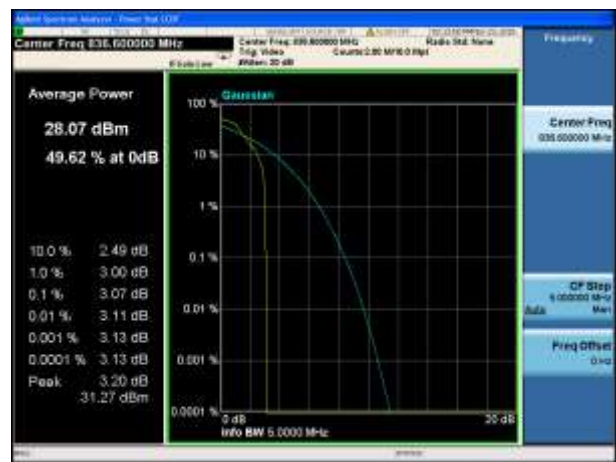
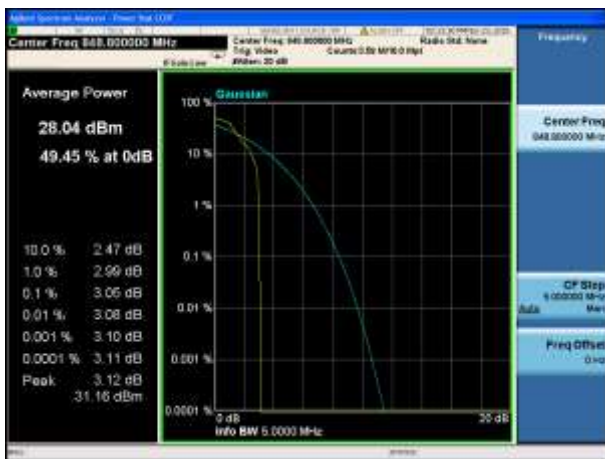
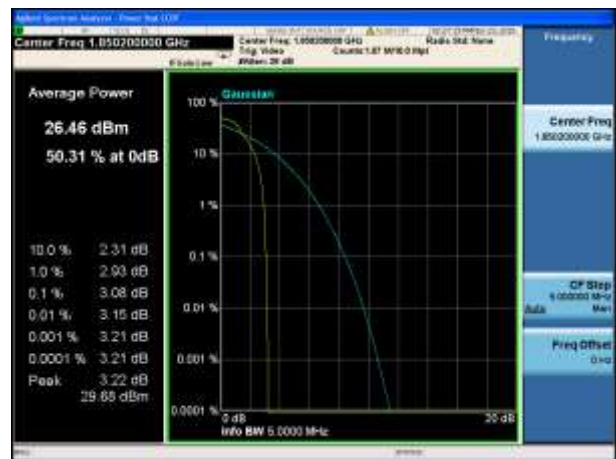
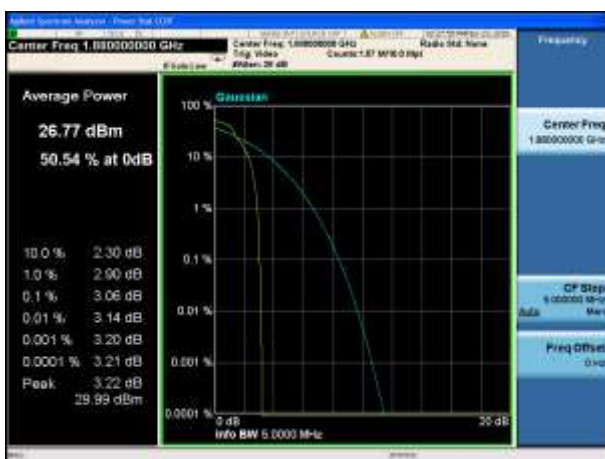
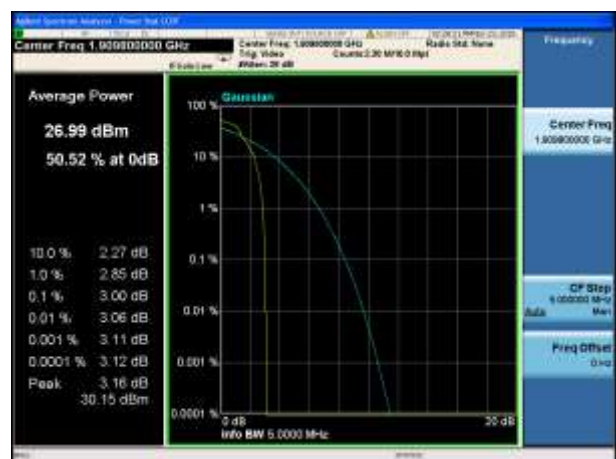
EGPRS850-CH128

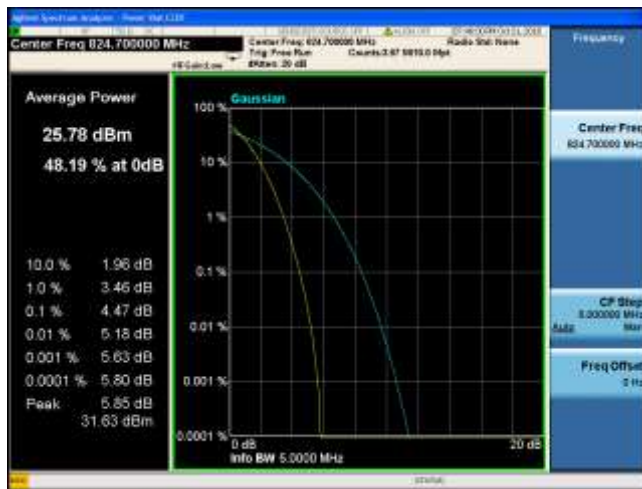
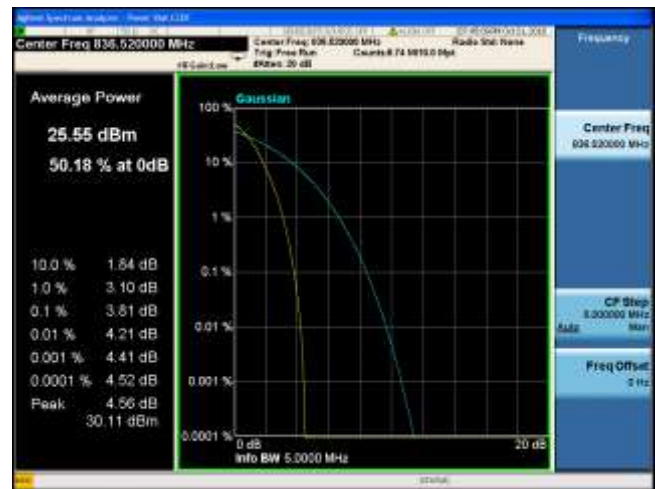
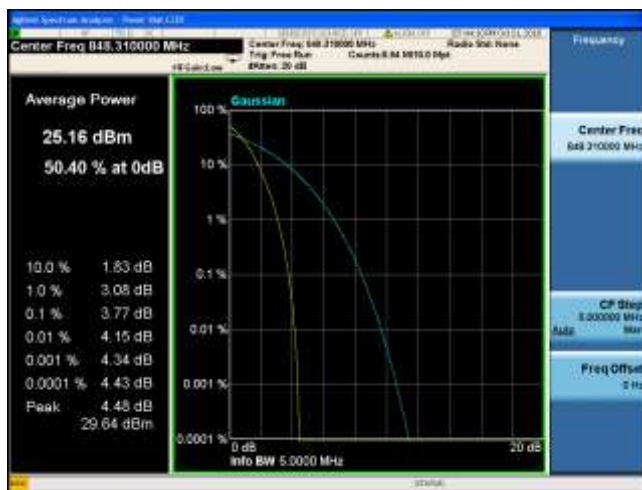
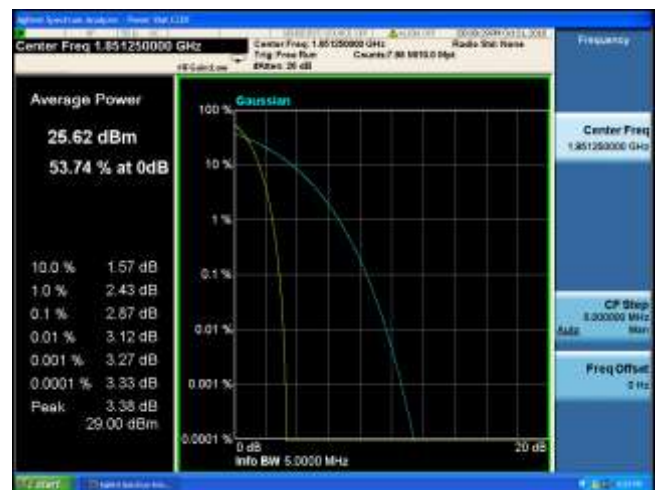
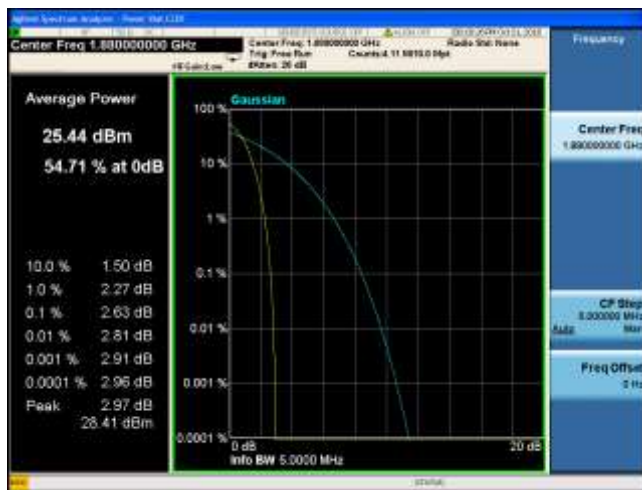
EGPRS850-CH190

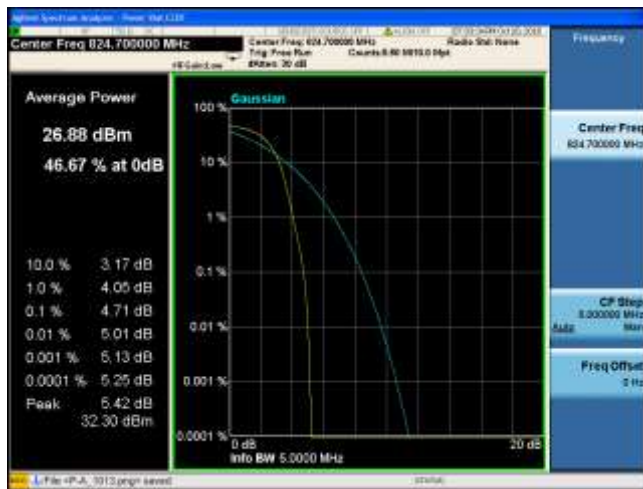
EGPRS850-CH251

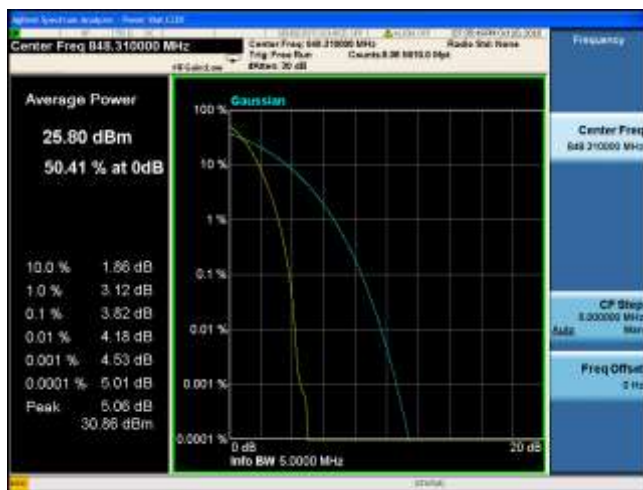
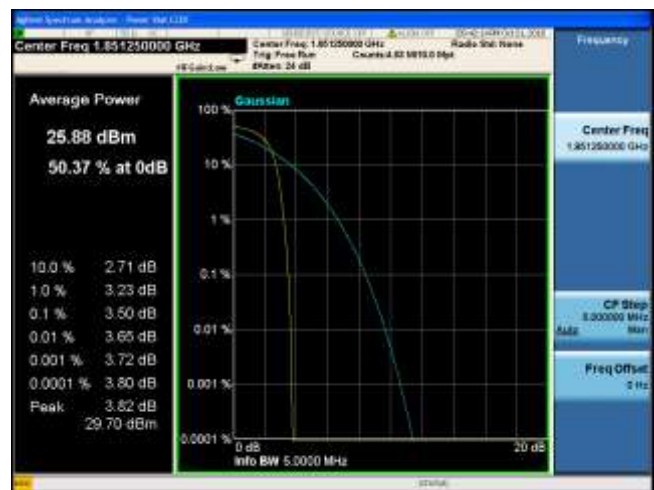
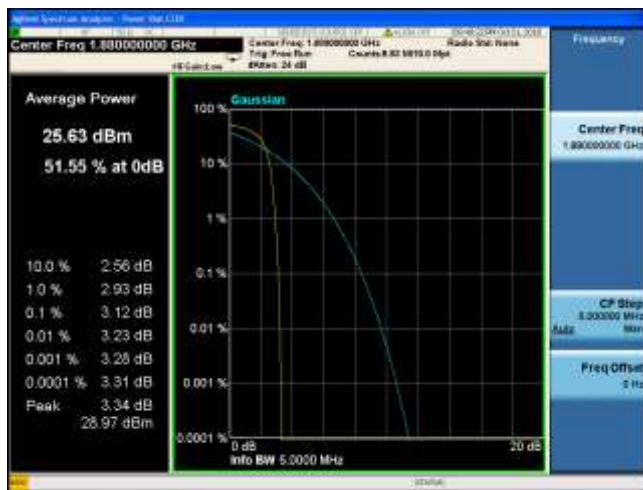
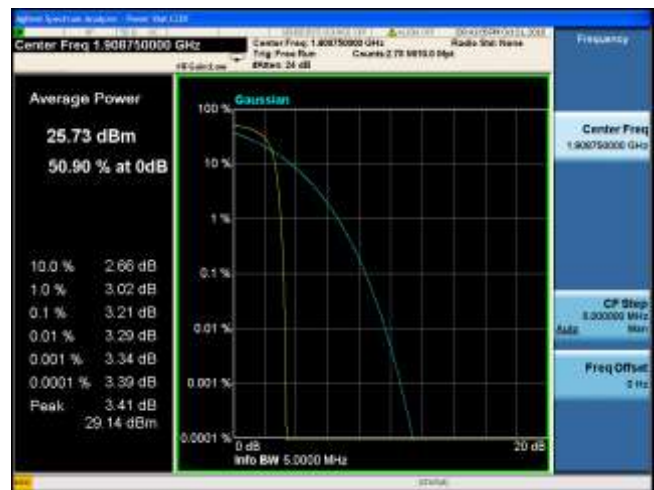
EGPRS1900-CH512

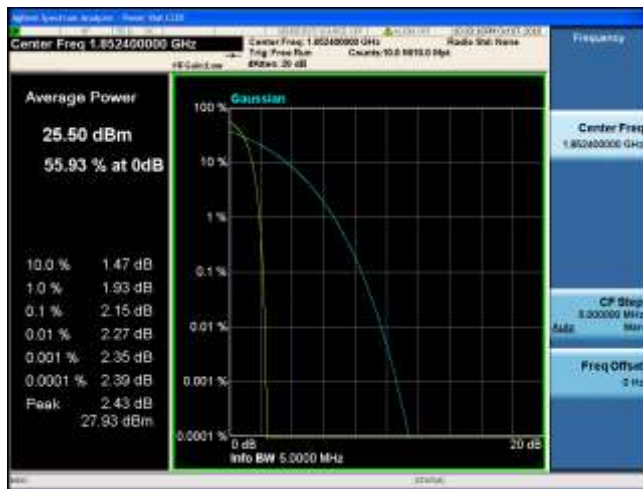
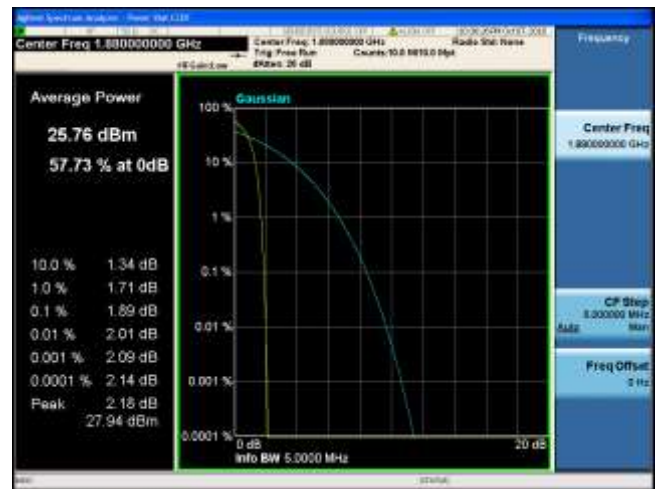
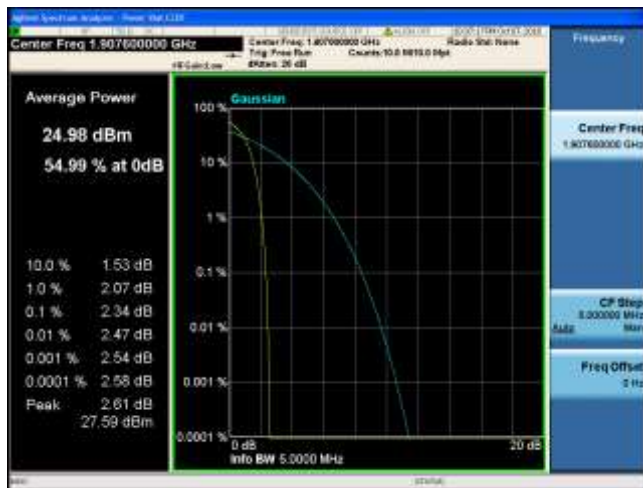
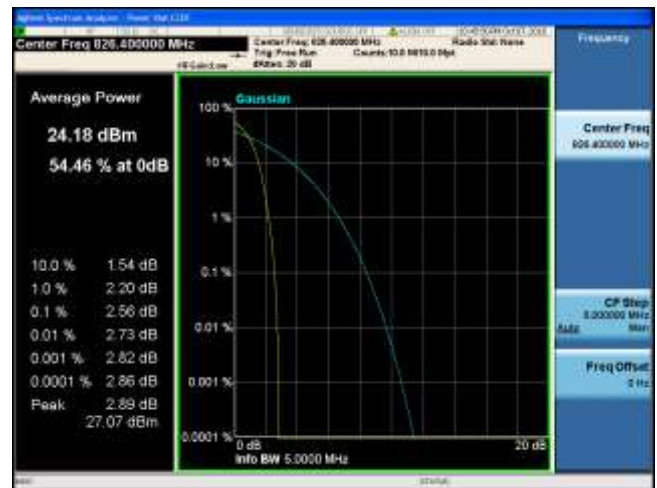
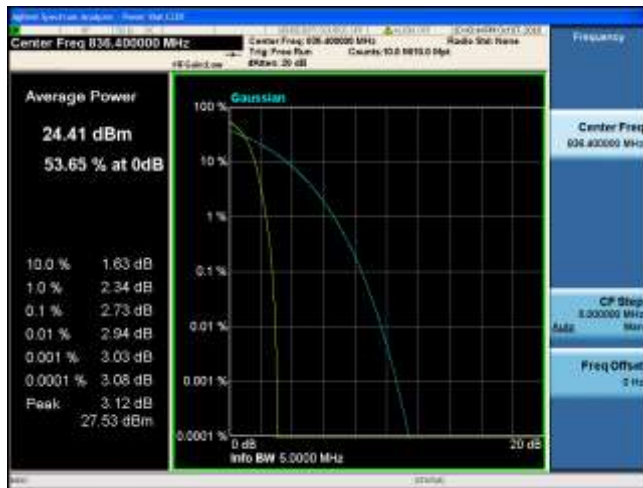
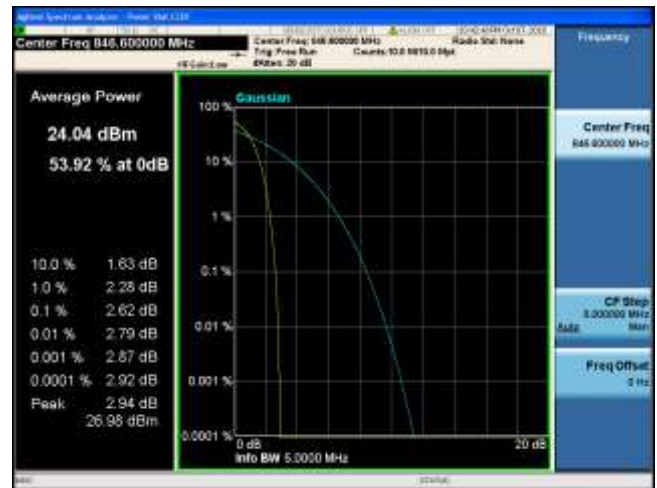
EGPRS1900-CH661

EGPRS1900-CH810

CDMA BC0(850) -CH1013

CDMA BC0(850) -CH384

CDMA BC0(850) -CH777

CDMA BC1(1900) -CH25

CDMA BC1(1900) -CH600

CDMA BC1(1900) -CH1175

EVDO BC0(850)-CH1013

EVDO BC0(850)-CH384

EVDO BC0(850)-CH777

EVDO BC1(1900)-CH25

EVDO BC1(1900)-CH600

EVDO BC1(1900)-CH1175

WCDMA Band II -CH9262

WCDMA Band II -CH9400

WCDMA Band II -CH9538

WCDMA Band V -CH4132

WCDMA Band V -CH4182

WCDMA Band V -CH4233

7.7. Frequency Stability Under Temperature & Voltage Variations

7.7.1 Test Limit

The frequency stability shall be sufficient to ensure that the fundamental emission stays within the authorized frequency block.

Limit	$< \pm 2.5 \text{ ppm}$
-------	-------------------------

7.7.2 Test Procedure

KDB 971168 D01v03 - Section 9.0 & ANSI/TIA-603-E-2016

7.7.3 Test Setup

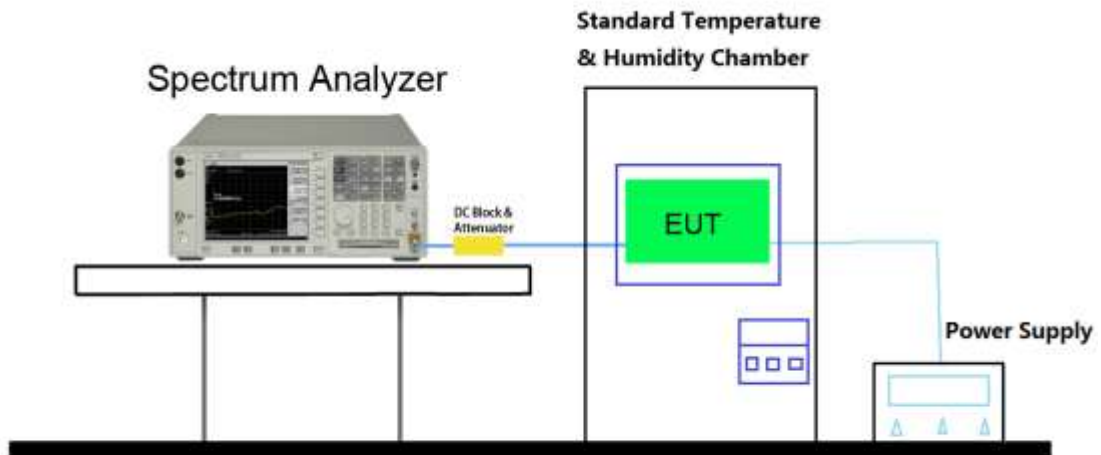

7.7.4 Test Result

Operating Frequency	836.6MHz
Channel	190
Test Mode	GSM-850
Reference Voltage	DC 3.7V

Voltage (%)	Power (DC)	TEMP (°C)	Freq. Dev. (kHz)	Limit (kHz)
100%	3.7V	50	0.0052	2.09
100%		40	0.0039	2.09
100%		30	0.0021	2.09
100%		20	0.0030	2.09
100%		10	0.0024	2.09
100%		0	0.0035	2.09
100%		-10	0.0041	2.09
100%		-20	0.0053	2.09
100%		-30	0.0048	2.09
115%		4.26	25	0.0031
End point	3.40	25	0.0037	2.09

Operating Frequency	1880MHz
Channel	190
Test Mode	GSM-1900
Reference Voltage	DC 3.7V

Voltage (%)	Power (DC)	TEMP (°C)	Freq. Dev. (kHz)	Limit (kHz)
100%	3.7V	50	0.0031	4.7
100%		40	0.0048	4.7
100%		30	0.0023	4.7
100%		20	0.0066	4.7
100%		10	0.0024	4.7
100%		0	0.0075	4.7
100%		-10	0.0055	4.7
100%		-20	0.0014	4.7
100%		-30	0.0063	4.7
115%		4.26	25	0.0021
End point	3.40	25	0.0053	4.7

Operating Frequency	1880MHz
Channel	9400
Test Mode	WCDMA Band II-1900
Reference Voltage	DC 3.7V

Voltage (%)	Power (DC)	TEMP (°C)	Freq. Dev. (kHz)	Limit (kHz)
100%	3.7V	50	0.0023	4.7
100%		40	0.0056	4.7
100%		30	0.0035	4.7
100%		20	0.0073	4.7
100%		10	0.0075	4.7
100%		0	0.0036	4.7
100%		-10	0.0066	4.7
100%		-20	0.0046	4.7
100%		-30	0.0073	4.7
115%		4.26	25	0.0072
End point	3.40	25	0.0036	4.7

Operating Frequency	836.6MHz
Channel	4182
Test Mode	WCDMA Band V-850
Reference Voltage	DC 3.7V

Voltage (%)	Power (DC)	TEMP (°C)	Freq. Dev. (kHz)	Limit (kHz)
100%	3.7V	50	0.0024	2.09
100%		40	0.0055	2.09
100%		30	0.0052	2.09
100%		20	0.0035	2.09
100%		10	0.0073	2.09
100%		0	0.0025	2.09
100%		-10	0.0075	2.09
100%		-20	0.0035	2.09
100%		-30	0.0063	2.09
115%		4.26	30	0.0033
End point	3.40	30	0.0035	2.09

Operating Frequency	836.52MHz
Channel	384
Test Mode	CDMA BC0
Reference Voltage	DC 3.7V

Voltage (%)	Power (DC)	TEMP (°C)	Freq. Dev. (kHz)	Limit (kHz)
100%	3.7V	50	0.0024	2.09
100%		40	0.0063	2.09
100%		30	0.0027	2.09
100%		20	0.0035	2.09
100%		10	0.0036	2.09
100%		0	0.0066	2.09
100%		-10	0.0025	2.09
100%		-20	0.0063	2.09
100%		-30	0.0025	2.09
115%		4.26	30	0.0077
End point	3.40	30	0.0073	2.09

Operating Frequency	1880MHz
Channel	600
Test Mode	CDMA BC1
Reference Voltage	DC 3.7V

Voltage (%)	Power (DC)	TEMP (°C)	Freq. Dev. (kHz)	Limit (kHz)
100%	3.7V	50	0.0052	4.7
100%		40	0.0039	4.7
100%		30	0.0021	4.7
100%		20	0.0030	4.7
100%		10	0.0024	4.7
100%		0	0.0035	4.7
100%		-10	0.0041	4.7
100%		-20	0.0053	4.7
100%		-30	0.0048	4.7
115%		4.26	30	0.0031
End point	3.40	30	0.0037	4.7

————— The End —————