

**ELECTROMAGNETIC EMISSIONS
COMPLIANCE REPORT**

Applicant: Handheld Group AB
Strandgatan 40, 531 60 Lidköping Sweden

Manufacturer: Handheld Group AB
Strandgatan 40, 531 60 Lidköping Sweden

Product Name: NAUTIZ X81

Brand Name: Handheld

Model No.: NX81-RF2-A00, NX81-RF0-A00

Model Difference: NX81-RF2-A00 has WWAN+WLAN,
NX81-RF0-A00 only has WLAN

Report Number: TERF2303000623E2

FCC ID YY3-142481

IC: 11695A-142481

Date of EUT Received: March 16, 2023

Date of Test: March 17, 2023 ~ April 27, 2023

Issue Date: May 15, 2023

Approved By _____

Vito Pei

We hereby certify that:

The above equipment was tested by SGS Taiwan Ltd. Central RF Lab The test data, data evaluation, test procedures, and equipment configurations shown in this report were made in accordance with the procedures given in ANSI C63.10:2013 and the energy emitted by the sample EUT comply with FCC rule part §15.247, ISED RSS-247.

The results of this report relate only to the sample identified in this report.

Unless otherwise stated the results shown in this test report refer only to the sample(s) tested and such sample(s) are retained for 90 days only.
除非另有說明，此報告結果僅對測試之樣品負責，同時此樣品僅保留90天。本報告未經本公司書面許可，不可部份複製。

This document is issued by the Company subject to its General Conditions of Service printed overleaf, available on request or accessible at <http://www.sgs.com.tw/Terms-and-Conditions> and for electronic format documents, subject to Terms and Conditions for Electronic Documents at <http://www.sgs.com.tw/Terms-and-Conditions>. Attention is drawn to the limitation of liability, indemnification and jurisdiction issues defined therein. Any holder of this document is advised that information contained hereon reflects the Company's findings at the time of its intervention only and within the limits of Client's instructions, if any. The Company's sole responsibility is to its Client and this document does not exonerate parties to a transaction from exercising all their rights and obligations under the transaction documents. This document cannot be reproduced except in full, without prior written approval of the Company. Any unauthorized alteration, forgery or falsification of the content or appearance of this document is unlawful and offenders may be prosecuted to the fullest extent of the law.

Revision History

Report Number	Revision	Description	Issue Date	Revised By	Remark
TERF2303000623E2	00	Original.	May 15, 2023	Yami Kuo	

Note:

- 1、The remark "*" indicates modification of the report upon requests from certification body.
- 2、Variant information of model numbers is provided by the applicant, test results of this report are applicable to the sample EUT(s) received.

Unless otherwise stated the results shown in this test report refer only to the sample(s) tested and such sample(s) are retained for 90 days only.
 除非另有說明，此報告結果僅對測試之樣品負責，同時此樣品僅保留90天。本報告未經本公司書面許可，不可部份複製。

This document is issued by the Company subject to its General Conditions of Service printed overleaf, available on request or accessible at <http://www.sgs.com.tw/Terms-and-Conditions> and for electronic format documents, subject to Terms and Conditions for Electronic Documents at <http://www.sgs.com.tw/Terms-and-Conditions>. Attention is drawn to the limitation of liability, indemnification and jurisdiction issues defined therein. Any holder of this document is advised that information contained hereon reflects the Company's findings at the time of its intervention only and within the limits of Client's instructions, if any. The Company's sole responsibility is to its Client and this document does not exonerate parties to a transaction from exercising all their rights and obligations under the transaction documents. This document cannot be reproduced except in full, without prior written approval of the Company. Any unauthorized alteration, forgery or falsification of the content or appearance of this document is unlawful and offenders may be prosecuted to the fullest extent of the law.

Table of Contents

1	GENERAL INFORMATION	4
2	SYSTEM TEST CONFIGURATION	7
3	SUMMARY OF TEST RESULTS	10
4	DESCRIPTION OF TEST MODES	11
5	MEASUREMENT UNCERTAINTY	13
6	MEASUREMENT EQUIPMENT USED	14
7	CONDUCTED EMISSION TEST	15
8	PEAK OUTPUT POWER MEASUREMENT	19
9	EMISSION BANDWIDTH MEASUREMENT	27
10	CONDUCTED BAND EDGES AND SPURIOUS EMISSION MEASUREMENT	34
11	RADIATED BANDEDGE AND SPURIOUS EMISSION MEASUREMENT	43
12	POWER SPECTRAL DENSITY	89
13	ANTENNA REQUIREMENT	93

Unless otherwise stated the results shown in this test report refer only to the sample(s) tested and such sample(s) are retained for 90 days only.

除非另有說明，此報告結果僅對測試之樣品負責，同時此樣品僅保留90天。本報告未經本公司書面許可，不可部份複製。

This document is issued by the Company subject to its General Conditions of Service printed overleaf, available on request or accessible at <http://www.sgs.com.tw/Terms-and-Conditions> and for electronic format documents, subject to Terms and Conditions for Electronic Documents at <http://www.sgs.com.tw/Terms-and-Conditions>. Attention is drawn to the limitation of liability, indemnification and jurisdiction issues defined therein. Any holder of this document is advised that information contained hereon reflects the Company's findings at the time of its intervention only and within the limits of Client's instructions, if any. The Company's sole responsibility is to its Client and this document does not exonerate parties to a transaction from exercising all their rights and obligations under the transaction documents. This document cannot be reproduced except in full, without prior written approval of the Company. Any unauthorized alteration, forgery or falsification of the content or appearance of this document is unlawful and offenders may be prosecuted to the fullest extent of the law.

1 GENERAL INFORMATION

1.1 Product Description

Product Name:	NAUTIZ X81
Brand Name:	Handheld
Model No.:	NX81-RF2-A00, NX81-RF0-A00
Model Difference:	NX81-RF2-A00 has WWAN+WLAN, NX81-RF0-A00 only has WLAN
Hardware Version:	R0.3
Firmware Version:	v001.06.00
EUT Series No.:	TE_SP_20230302243
Power Supply:	5 / 9 / 12 / 15 / 20Vdc from AC Adapter or 3.6Vdc from Lithium-ion Rechargeable Battery
Test Software (Name/Version)	default

1.2 RF Specification

WLAN 2.4GHz

Wi-Fi	Frequency Range	Channels	Rated Power (dBm)		Modulation Technology
			Peak	Avg.	
802.11b	2412~2462	11	22.28	20.03	DSSS
802.11g	2412~2462	11	24.46	15.46	OFDM
802.11n20	2412~2462	11	25.61	15.38	OFDM
802.11n40	2422~2452	7	25.47	15.67	OFDM
802.11ac20	2412~2462	11	24.71	15.32	OFDM
802.11ac40	2422~2452	7	24.66	15.49	OFDM
Modulation type:		CCK, DQPSK, DBPSK for DSSS 256 QAM, 64QAM, 16QAM, QPSK, BPSK for OFDM			
Data Rate:		802.11 b: 1/2/5.5/11 Mbps 802.11 g: 6/9/12/18/24/36/48/54 Mbps 802.11 n_20MHz: up to 72.2Mbps 802.11 n_40MHz: up to 150Mbps 802.11 ac_20MHz: up to 86.7Mbps 802.11 ac_40MHz: up to 200Mbps			

Unless otherwise stated the results shown in this test report refer only to the sample(s) tested and such sample(s) are retained for 90 days only.

除非另有說明，此報告結果僅對測試之樣品負責，同時此樣品僅保留90天。本報告未經本公司書面許可，不可部份複製。

This document is issued by the Company subject to its General Conditions of Service printed overleaf, available on request or accessible at <http://www.sgs.com.tw/Terms-and-Conditions>, and for electronic format documents, subject to Terms and Conditions for Electronic Documents at <http://www.sgs.com.tw/Terms-and-Conditions>. Attention is drawn to the limitation of liability, indemnification and jurisdiction issues defined therein. Any holder of this document is advised that information contained hereon reflects the Company's findings at the time of its intervention only and within the limits of Client's instructions, if any. The Company's sole responsibility is to its Client and this document does not exonerate parties to a transaction from exercising all their rights and obligations under the transaction documents. This document cannot be reproduced except in full, without prior written approval of the Company. Any unauthorized alteration, forgery or falsification of the content or appearance of this document is unlawful and offenders may be prosecuted to the fullest extent of the law.

WLAN 2.4GHz for IC

Wi-Fi	Frequency Range	Channels	Rated Power (dBm)		Rated Power in dBm (EIRP)	Modulation Technology
			Peak	Avg.		
802.11b	2412~2462	11	22.28	20.03	22.26	DSSS
802.11g	2412~2462	11	24.46	15.46	17.69	OFDM
802.11n20	2412~2462	11	25.61	15.38	17.61	OFDM
802.11n40	2422~2452	7	25.47	15.67	17.90	OFDM
802.11ac20	2412~2462	11	24.71	15.32	17.55	OFDM
802.11ac40	2422~2452	7	24.66	15.49	17.72	OFDM
Modulation type:		CCK, DQPSK, DBPSK for DSSS				
		256 QAM, 64QAM, 16QAM, QPSK, BPSK for OFDM				
Data Rate:		802.11 b: 1/2/5.5/11 Mbps				
		802.11 g: 6/9/12/18/24/36/48/54 Mbps				
		802.11 n_20MHz: up to 72.2Mbps				
		802.11 n_40MHz: up to 150Mbps				
		802.11 ac_20MHz: up to 86.7Mbps				
		802.11 ac_40MHz: up to 200Mbps				

1.3 Antenna Designation

Antenna Type	Freq. (MHz)	Peak Antenna Gain (dBi)
PRINT	2412 – 2462	2.23

Note:

1. Antenna information is provided by the applicant.

Unless otherwise stated the results shown in this test report refer only to the sample(s) tested and such sample(s) are retained for 90 days only.
 除非另有說明，此報告結果僅對測試之樣品負責，同時此樣品僅保留90天。本報告未經本公司書面許可，不可部份複製。

This document is issued by the Company subject to its General Conditions of Service printed overleaf, available on request or accessible at <http://www.sgs.com.tw/Terms-and-Conditions> and for electronic format documents, subject to Terms and Conditions for Electronic Documents at <http://www.sgs.com.tw/Terms-and-Conditions>. Attention is drawn to the limitation of liability, indemnification and jurisdiction issues defined therein. Any holder of this document is advised that information contained hereon reflects the Company's findings at the time of its intervention only and within the limits of Client's instructions, if any. The Company's sole responsibility is to its Client and this document does not exonerate parties to a transaction from exercising all their rights and obligations under the transaction documents. This document cannot be reproduced except in full, without prior written approval of the Company. Any unauthorized alteration, forgery or falsification of the content or appearance of this document is unlawful and offenders may be prosecuted to the fullest extent of the law.

1.4 Test Methodology of Applied Standards

FCC Part 15, Subpart C §15.247
 FCC KDB 558074 D01 15.247 Meas Guidance v05r02
 RSS-247 issue 2 Feb. 2017
 RSS-Gen,issue 5 April, 2018
 ANSI C63.10:2013

1.5 Test Facility

Laboratory	Test Site Address	Test Site Name	FCC Designation number	IC CAB identifier
SGS Taiwan Ltd. Central RF Lab. (TAF code 3702)	No.134, Wu Kung Road, New Taipei Industrial Park, Wuku District, New Taipei City, Taiwan.	SAC 1	TW0027	
		SAC 2		
		SAC 3		
		Conduction 1		
		Conducted 1		
		Conducted 2		
		Conducted 3		
		Conducted 4		
		Conducted 5		
	Conducted 6			
	No.2, Keji 1st Rd., Guishan District, Taoyuan City, Taiwan 333	Conduction C	TW0028	
		SAC C		
		SAC D		
		SAC G		
		Conducted A		
		Conducted B		
		Conducted C		
		Conducted D		
		Conducted E		
Conducted F				
Conducted G				

Note: Test site name is remarked on the equipment list in each section of this report as an indication where measurements occurred in specific test site and address.

1.6 Special Accessories

There are no special accessories used while test was conducted.

1.7 Equipment Modifications

There was no modification incorporated into the EUT.

Unless otherwise stated the results shown in this test report refer only to the sample(s) tested and such sample(s) are retained for 90 days only.
 除非另有說明，此報告結果僅對測試之樣品負責，同時此樣品僅保留90天。本報告未經本公司書面許可，不可部份複製。

This document is issued by the Company subject to its General Conditions of Service printed overleaf, available on request or accessible at <http://www.sgs.com.tw/Terms-and-Conditions> and for electronic format documents, subject to Terms and Conditions for Electronic Documents at <http://www.sgs.com.tw/Terms-and-Conditions>. Attention is drawn to the limitation of liability, indemnification and jurisdiction issues defined therein. Any holder of this document is advised that information contained hereon reflects the Company's findings at the time of its intervention only and within the limits of Client's instructions, if any. The Company's sole responsibility is to its Client and this document does not exonerate parties to a transaction from exercising all their rights and obligations under the transaction documents. This document cannot be reproduced except in full, without prior written approval of the Company. Any unauthorized alteration, forgery or falsification of the content or appearance of this document is unlawful and offenders may be prosecuted to the fullest extent of the law.

2 SYSTEM TEST CONFIGURATION

2.1 EUT Configuration

The EUT configuration for testing is installed on RF field strength measurement to meet the Commissions requirement and operating in a manner which intends to maximize its emission characteristics in a continuous normal application.

2.2 EUT Exercise

An engineering test mode (software/firmware) that applicant provided was utilized to manipulate the EUT into transmit, selection of the test channel, and modulation scheme.

2.3 Test Procedure

2.3.1 Conducted Emissions

The EUT is a placed on a table which is 0.8 m above ground plane. Conducted emissions from the EUT measured in the frequency range between 0.15 MHz and 30MHz. The CISPR Quasi-Peak and Average detector mode is employed. The two LISNs provide 50uH/50 ohm of coupling impedance for the measuring instrument. Both lines of the power mains connected to the EUT were checked for maximum conducted interference.

2.3.2 Conducted Test (RF)

The active antenna port of the unlicensed wireless device is connected to the spectrum analyzer with attenuator to protect the instrumentation. If a second antenna port is available, it is tested at one operating frequency, with other port(s) appropriately terminated, to verify it has similar output characteristics as the fully tested port.

2.3.3 Radiated Emissions

The EUT is a placed on a turn table. For emissions testing at or below 1 GHz, the table height shall be 0.8 m above the reference ground plane. For emission measurements above 1 GHz, the table height shall be 1.5 m. The turn table shall rotate 360 degrees to determine the position of maximum emission level. EUT is set 3m away from the receiving antenna which varied from 1m to 4m to find out the highest emission. And also, each emission was to be maximized by changing the polarization of receiving antenna both horizontal and vertical. In order to find out the max. emission, the relative positions of this transmitter (EUT) was rotated through three orthogonal axes and measurement procedures for electric field radiated emissions above 1 GHz the EUT measurement is to be made "while keeping the antenna in the 'cone of radiation' from that area and pointed at the area both in azimuth and elevation, with polarization oriented for maximum response." is still within the 3dB illumination BW of the measurement antenna.

Unless otherwise stated the results shown in this test report refer only to the sample(s) tested and such sample(s) are retained for 90 days only.
除非另有說明，此報告結果僅對測試之樣品負責，同時此樣品僅保留90天。本報告未經本公司書面許可，不可部份複製。

This document is issued by the Company subject to its General Conditions of Service printed overleaf, available on request or accessible at <http://www.sgs.com.tw/Terms-and-Conditions> and for electronic format documents, subject to Terms and Conditions for Electronic Documents at <http://www.sgs.com.tw/Terms-and-Conditions>. Attention is drawn to the limitation of liability, indemnification and jurisdiction issues defined therein. Any holder of this document is advised that information contained hereon reflects the Company's findings at the time of its intervention only and within the limits of Client's instructions, if any. The Company's sole responsibility is to its Client and this document does not exonerate parties to a transaction from exercising all their rights and obligations under the transaction documents. This document cannot be reproduced except in full, without prior written approval of the Company. Any unauthorized alteration, forgery or falsification of the content or appearance of this document is unlawful and offenders may be prosecuted to the fullest extent of the law.

2.4 Measurement Results Explanation Example

2.4.1 Radiated Emission Test Sites For Measurements From 9 kHz To 30 MHz

Radiated emission below 30MHz is measured in a 9m*6m*6m semi-anechoic chamber, the measurements correspond to those obtained at an open-field test site.

There is a comparison data of both open-field test site and semi-Anechoic chamber, and the result came out very similar.

2.4.2 For all conducted test items:

The offset level is set in the spectrum analyzer to compensate the RF cable loss and attenuation factor between EUT conducted port and spectrum analyzer. With the offset compensation, the spectrum analyzer reading level is exactly EUT RF output level.

Unless otherwise stated the results shown in this test report refer only to the sample(s) tested and such sample(s) are retained for 90 days only.
除非另有說明，此報告結果僅對測試之樣品負責，同時此樣品僅保留90天。本報告未經本公司書面許可，不可部份複製。

This document is issued by the Company subject to its General Conditions of Service printed overleaf, available on request or accessible at <http://www.sgs.com.tw/Terms-and-Conditions> and for electronic format documents, subject to Terms and Conditions for Electronic Documents at <http://www.sgs.com.tw/Terms-and-Conditions>. Attention is drawn to the limitation of liability, indemnification and jurisdiction issues defined therein. Any holder of this document is advised that information contained hereon reflects the Company's findings at the time of its intervention only and within the limits of Client's instructions, if any. The Company's sole responsibility is to its Client and this document does not exonerate parties to a transaction from exercising all their rights and obligations under the transaction documents. This document cannot be reproduced except in full, without prior written approval of the Company. Any unauthorized alteration, forgery or falsification of the content or appearance of this document is unlawful and offenders may be prosecuted to the fullest extent of the law.

2.5 Test Configuration

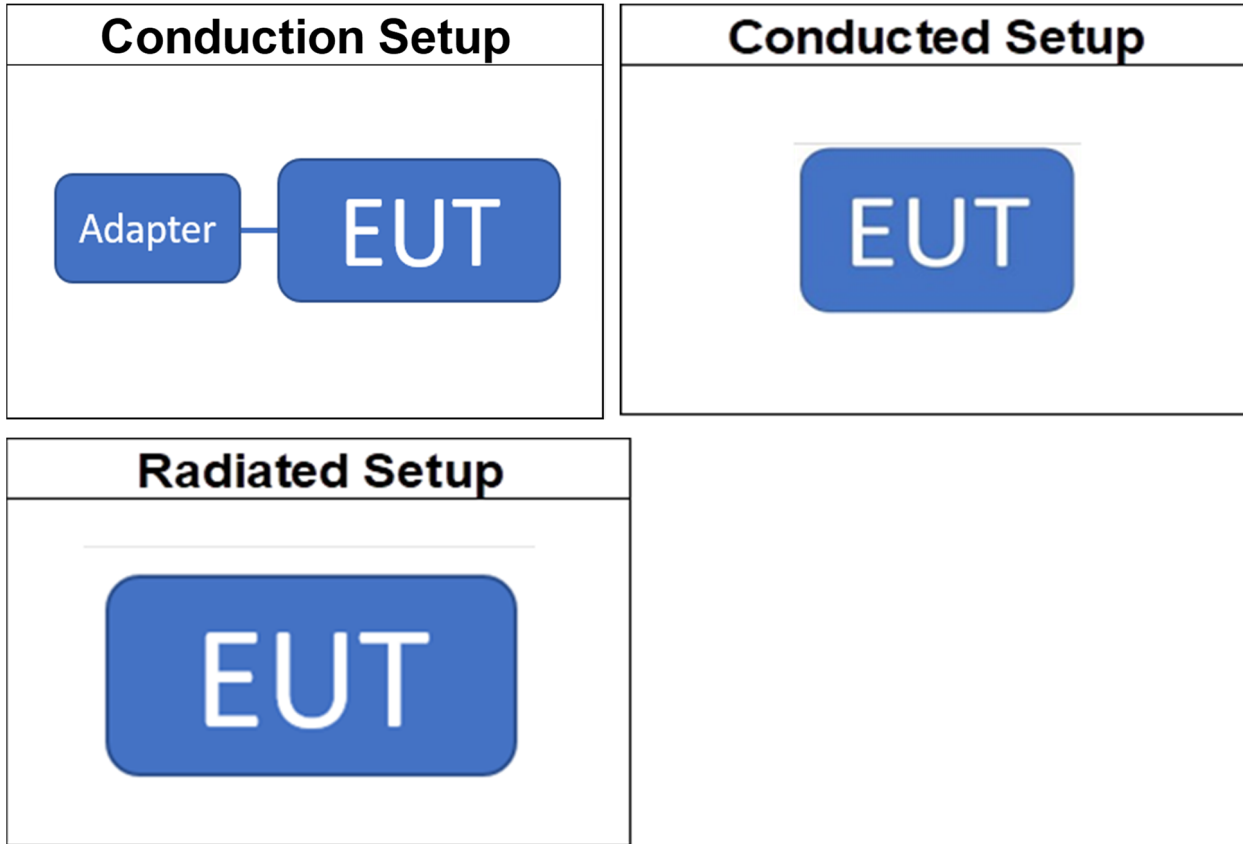

2.6 Control Unit(s)

AC Power-Line Conducted Emission Test Site: Conduction C					
EQUIPMENT TYPE	MFR	MODEL NUMBER	SERIAL NUMBER	LAST CAL.	CAL DUE.
Adapter	CULLPOWER	TYPE-C451C	N/A	N.C.R	N.C.R
USB Cable	Sheng Lintai	051-010003	N/A	N.C.R	N.C.R

Unless otherwise stated the results shown in this test report refer only to the sample(s) tested and such sample(s) are retained for 90 days only.

除非另有說明，此報告結果僅對測試之樣品負責，同時此樣品僅保留90天。本報告未經本公司書面許可，不可部份複製。

This document is issued by the Company subject to its General Conditions of Service printed overleaf, available on request or accessible at <http://www.sgs.com.tw/Terms-and-Conditions> and for electronic format documents, subject to Terms and Conditions for Electronic Documents at <http://www.sgs.com.tw/Terms-and-Conditions>. Attention is drawn to the limitation of liability, indemnification and jurisdiction issues defined therein. Any holder of this document is advised that information contained hereon reflects the Company's findings at the time of its intervention only and within the limits of Client's instructions, if any. The Company's sole responsibility is to its Client and this document does not exonerate parties to a transaction from exercising all their rights and obligations under the transaction documents. This document cannot be reproduced except in full, without prior written approval of the Company. Any unauthorized alteration, forgery or falsification of the content or appearance of this document is unlawful and offenders may be prosecuted to the fullest extent of the law.

3 SUMMARY OF TEST RESULTS

FCC Rules	ISED Rules	Description Of Test	Result
§15.207(a)	RSS-Gen §8.8	AC Power Line Conducted Emission	Compliant
§15.247(b) (3)	RSS-247 §5.4 d	Peak Output Power	Compliant
§15.247(a)(2)	RSS-247 §5.2 a RSS-Gen §6.7	Emission Bandwidth	Compliant
§15.205 §15.209 §15.247(d)	RSS-247 §5.5 RSS-Gen §8.9 RSS-Gen §8.10 RSS-Gen §6.13	Radiated & Conducted Band Edge and Spurious Emission	Compliant
§15.247(e)	RSS-247 §5.2 b	Power Spectral Density	Compliant
§15.203	N/A	Antenna Requirement	Compliant

Unless otherwise stated the results shown in this test report refer only to the sample(s) tested and such sample(s) are retained for 90 days only.
 除非另有說明，此報告結果僅對測試之樣品負責，同時此樣品僅保留90天。本報告未經本公司書面許可，不可部份複製。

This document is issued by the Company subject to its General Conditions of Service printed overleaf, available on request or accessible at <http://www.sgs.com.tw/Terms-and-Conditions> and for electronic format documents, subject to Terms and Conditions for Electronic Documents at <http://www.sgs.com.tw/Terms-and-Conditions>. Attention is drawn to the limitation of liability, indemnification and jurisdiction issues defined therein. Any holder of this document is advised that information contained hereon reflects the Company's findings at the time of its intervention only and within the limits of Client's instructions, if any. The Company's sole responsibility is to its Client and this document does not exonerate parties to a transaction from exercising all their rights and obligations under the transaction documents. This document cannot be reproduced except in full, without prior written approval of the Company. Any unauthorized alteration, forgery or falsification of the content or appearance of this document is unlawful and offenders may be prosecuted to the fullest extent of the law.

4 DESCRIPTION OF TEST MODES

4.1 Operatin Frequencies

Modulation of BW 20MHz		Modulation of BW 40MHz	
CHANNEL	FREQUENCY (MHz)	CHANNEL	FREQUENCY (MHz)
1	2412	3	2422
2	2417	4	2427
3	2422	5	2432
4	2427	6	2437
5	2432	7	2442
6	2437	8	2447
7	2442	9	2452
8	2447		
9	2452		
10	2457		
11	2462		

4.2 The Worst Test Modes and Channel Details

1. The EUT has been tested under operating condition.
2. Test program used to control the EUT for staying in continuous transmitting and receiving mode is programmed.
3. Investigation has been done on all the possible configurations for searching the worst case.

The gevin UE is pre-scanned among below modes.

Modulation		Transmission Chain						Single Transmission Spatial		Multi Transmission Spatial	
v	802.11 b	v	Ch0	Ch1	Ch2	Ch3	v	1TX	1TX		
v	802.11 g	v	Ch0	Ch1	Ch2	Ch3	v	1TX	1TX		
v	802.11 n	v	Ch0	Ch1	Ch2	Ch3	v	1TX	1TX		
v	802.11 ac	v	Ch0	Ch1	Ch2	Ch3	v	1TX	1TX		

Unless otherwise stated the results shown in this test report refer only to the sample(s) tested and such sample(s) are retained for 90 days only.

除非另有說明，此報告結果僅對測試之樣品負責，同時此樣品僅保留90天。本報告未經本公司書面許可，不可部份複製。
 This document is issued by the Company subject to its General Conditions of Service printed overleaf, available on request or accessible at <http://www.sgs.com.tw/Terms-and-Conditions> and for electronic format documents, subject to Terms and Conditions for Electronic Documents at <http://www.sgs.com.tw/Terms-and-Conditions>. Attention is drawn to the limitation of liability, indemnification and jurisdiction issues defined therein. Any holder of this document is advised that information contained hereon reflects the Company's findings at the time of its intervention only and within the limits of Client's instructions, if any. The Company's sole responsibility is to its Client and this document does not exonerate parties to a transaction from exercising all their rights and obligations under the transaction documents. This document cannot be reproduced except in full, without prior written approval of the Company. Any unauthorized alteration, forgery or falsification of the content or appearance of this document is unlawful and offenders may be prosecuted to the fullest extent of the law.

4. Therefore, below summary is the modes of test configuration that yield the highest reading and generate the highest emission chosen to carry out the relevantly mandatory test items.

Conducted					
MODE	AVAILABLE CHANNEL	TESTED CHANNEL	MODULATION	DATA RATE (Mbps)	ANTENNA PORT
802.11b	1 to 11	1,6,11	DSSS	1	ch0
802.11g	1 to 11	1,6,11	OFDM	6	ch0
802.11n (HT20)	1 to 11	1,6,11	OFDM	MCS0	ch0
802.11n (HT40)	3 to 9	3,6,9	OFDM	MCS0	ch0

RADIATED EMISSION TEST (BELOW 1 GHz)					
MODE	AVAILABLE CHANNEL	TESTED CHANNEL	MODULATION	DATA RATE (Mbps)	ANTENNA PORT
802.11g	1 to 11	6	OFDM	6	1TX

RADIATED EMISSION TEST (ABOVE 1 GHz)					
MODE	AVAILABLE CHANNEL	TESTED CHANNEL	MODULATION	DATA RATE (Mbps)	ANTENNA PORT
802.11b	1 to 11	1,6,11	DSSS	1	1TX
802.11g	1 to 11	1,6,11	OFDM	6	1TX
802.11n (HT20)	1 to 11	1,6,11	OFDM	MCS0	1TX
802.11n (HT40)	3 to 9	3,6,9	OFDM	MCS0	1TX

Note:

The field strength of radiated emission was measured as the EUT positioned in different orthogonal planes (E1/E2/H) based on actual usage of the EUT to pre-scan the emissions for determining the worst case scenario.

Unless otherwise stated the results shown in this test report refer only to the sample(s) tested and such sample(s) are retained for 90 days only.
 除非另有說明，此報告結果僅對測試之樣品負責，同時此樣品僅保留90天。本報告未經本公司書面許可，不可部份複製。

This document is issued by the Company subject to its General Conditions of Service printed overleaf, available on request or accessible at <http://www.sgs.com.tw/Terms-and-Conditions> and for electronic format documents, subject to Terms and Conditions for Electronic Documents at <http://www.sgs.com.tw/Terms-and-Conditions>. Attention is drawn to the limitation of liability, indemnification and jurisdiction issues defined therein. Any holder of this document is advised that information contained hereon reflects the Company's findings at the time of its intervention only and within the limits of Client's instructions, if any. The Company's sole responsibility is to its Client and this document does not exonerate parties to a transaction from exercising all their rights and obligations under the transaction documents. This document cannot be reproduced except in full, without prior written approval of the Company. Any unauthorized alteration, forgery or falsification of the content or appearance of this document is unlawful and offenders may be prosecuted to the fullest extent of the law.

5 MEASUREMENT UNCERTAINTY

Test Items	Uncertainty
AC Power Line Conducted Emission	+/- 2.32 dB
Output Power measurement	+/- 1 dB
Emission Bandwidth	+/- 1.53 Hz
Undesignable radiated emission measurement	+/- 1.68 dB
Peak Power Density	+/- 2.16 dB
Temperature	+/- 0.7 °C
Humidity	+/- 3 %
DC / AC Power Source	+/- 1 %

Radiated Spurious Emission Measurement Uncertainty			
Polarization: Vertical	+/-	2.8 dB	9kHz~30MHz
	+/-	4.82 dB	30MHz - 1000MHz
	+/-	4.37 dB	1GHz - 18GHz
	+/-	4.21 dB	18GHz - 40GHz
Polarization: Horizontal	+/-	2.8 dB	9kHz~30MHz
	+/-	4.54 dB	30MHz - 1000MHz
	+/-	4.37 dB	1GHz - 18GHz
	+/-	4.21 dB	18GHz - 40GHz

Note:

1. This uncertainty represents an expanded uncertainty expressed at approximately the 95% confidence level using a coverage factor of k=2.
2. The conformity assessment statement in this report is based solely on the test results, measurement uncertainty is excluded.

Unless otherwise stated the results shown in this test report refer only to the sample(s) tested and such sample(s) are retained for 90 days only.

除非另有說明，此報告結果僅對測試之樣品負責，同時此樣品僅保留90天。本報告未經本公司書面許可，不可部份複製。

This document is issued by the Company subject to its General Conditions of Service printed overleaf, available on request or accessible at <http://www.sgs.com.tw/Terms-and-Conditions> and for electronic format documents, subject to Terms and Conditions for Electronic Documents at <http://www.sgs.com.tw/Terms-and-Conditions>. Attention is drawn to the limitation of liability, indemnification and jurisdiction issues defined therein. Any holder of this document is advised that information contained hereon reflects the Company's findings at the time of its intervention only and within the limits of Client's instructions, if any. The Company's sole responsibility is to its Client and this document does not exonerate parties to a transaction from exercising all their rights and obligations under the transaction documents. This document cannot be reproduced except in full, without prior written approval of the Company. Any unauthorized alteration, forgery or falsification of the content or appearance of this document is unlawful and offenders may be prosecuted to the fullest extent of the law.

6 MEASUREMENT EQUIPMENT USED

6.1 Emission from AC power line

AC Power-Line Conducted Emission Test Site: Conduction C					
EQUIPMENT TYPE	MFR	MODEL NUMBER	SERIAL NUMBER	LAST CAL.	CAL DUE.
LISN	SCHWARZBECK Mess-	NSLK8127	973	04/20/2023	04/19/2024
EMI Test Receiver	R&S	ESCI	101342	04/25/2023	04/24/2024
Coaxial Cable	EC Lab	RF-HY-CAB-250	RF-HY-CAB-250-01	03/27/2023	03/26/2024
Pulse Limiter	EC Lab	VTSD 9561F-N	485	03/27/2023	03/26/2024
Test Software	audix	e3	E3 20923 SGS Ver.9 (C)	N.C.R	N.C.R

6.2 Condcuted Measurement

Conducted Emission Test Site: Conducted G					
EQUIPMENT TYPE	MFR	MODEL NUMBER	SERIAL NUMBER	LAST CAL.	CAL DUE.
Spectrum Analyzer	KEYSIGHT	N9010B	MY59071573	05/16/2022	05/15/2023
Power Meter	Anritsu	ML2496A	2138005	09/23/2022	09/22/2023
Power Sensor	Anritsu	MA2411B	1911395	09/23/2022	09/22/2023
Power Sensor	Anritsu	MA2411B	1911396	09/23/2022	09/22/2023
Test Software	SGS Taiwan	Radio Test Software	Ver.21	N.C.R	N.C.R
Attenuator	Woken	WATT-218FS-10	RF18	11/16/2022	11/15/2023
Attenuator	Woken	WATT-218FS-10	RF19	11/16/2022	11/15/2023
DC Block	PASTERNAK	PE8210	RF157	11/16/2022	11/15/2023

6.3 Radiated Measurement

Radiated Emission Test Site: SAC G					
EQUIPMENT TYPE	MFR	MODEL NUMBER	SERIAL NUMBER	LAST CAL.	CAL DUE.
Broadband	SCHWARZBECK	VULB 9168	1206	01/17/2023	01/16/2024
Horn Antenna	Schwarzbeck	BBHA9170	184	12/15/2022	12/14/2023
Horn Antenna	RF SPIN	DRH18-E	210105A18E	04/08/2022	05/07/2023
Loop Antenna	ETS.LINDGREN	6502	143303	05/06/2022	05/07/2023
3m Site NSA	SGS	966 chamber G	N/A	03/30/2023	03/29/2024
Spectrum Analyzer	KEYSIGHT	N9010A	MY51440113	07/13/2022	07/14/2023
Pre-Amplifier	EMC Instruments	EMC18405SEE	980881	10/25/2022	10/24/2023
Pre-Amplifier	EMC Instruments	EMC330N	980781	03/15/2023	03/14/2024
Pre-Amplifier	EMC Instruments	EMC118A45SE	980815	03/15/2023	03/14/2024
Test Software	audix	e3	E3 20923 SGS Ver.9 (C)	N.C.R	N.C.R
Coaxial Cable	EMC Instruments	EMCCFD400-NM-NM-8000-5000-2000	210216、210217、210218	03/15/2023	03/14/2024
Coaxial Cable	EMC Instruments	EMC104-SM-SM-8000-5000-5000	210219、210220、210221	03/15/2023	03/14/2024
Coaxial Cable	EMC Instruments	EMC105-NM-NM-5000-15000	210224、210306	03/15/2023	03/14/2024

NOTE: N.C.R refers to Not Calibrated Required.

Unless otherwise stated the results shown in this test report refer only to the sample(s) tested and such sample(s) are retained for 90 days only.
 除非另有說明，此報告結果僅對測試之樣品負責，同時此樣品僅保留90天。本報告未經本公司書面許可，不可部份複製。

This document is issued by the Company subject to its General Conditions of Service printed overleaf, available on request or accessible at <http://www.sgs.com.tw/Terms-and-Conditions> and for electronic format documents, subject to Terms and Conditions for Electronic Documents at <http://www.sgs.com.tw/Terms-and-Conditions>. Attention is drawn to the limitation of liability, indemnification and jurisdiction issues defined therein. Any holder of this document is advised that information contained hereon reflects the Company's findings at the time of its intervention only and within the limits of Client's instructions, if any. The Company's sole responsibility is to its Client and this document does not exonerate parties to a transaction from exercising all their rights and obligations under the transaction documents. This document cannot be reproduced except in full, without prior written approval of the Company. Any unauthorized alteration, forgery or falsification of the content or appearance of this document is unlawful and offenders may be prosecuted to the fullest extent of the law.

7 CONDUCTED EMISSION TEST

7.1 Standard Applicable

Frequency range within 150kHz to 30MHz shall not exceed the Limit table as below.

Frequency range MHz	Limits (dBuV)	
	Quasi-peak	Average
0.15 to 0.50	66 to 56	56 to 46
0.50 to 5	56	46
5 to 30	60	50

Note

- The lower limit shall apply at the transition frequencies
- The limit decreases linearly with the logarithm of the frequency in the range 0.15 MHz to 0.50 MHz.

7.2 EUT Setup

- The conducted emission tests were performed in the test site, using the setup in accordance with the ANSI C63.10:2013.
- The AC/DC Power adaptor of EUT was plug-in LISN. The EUT was placed flushed with the rear of the table.
- The LISN was connected with 120Vac/60Hz power source.

7.3 Test Setup

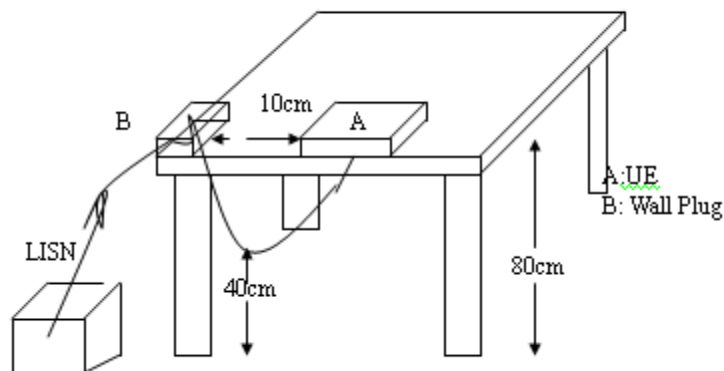

Unless otherwise stated the results shown in this test report refer only to the sample(s) tested and such sample(s) are retained for 90 days only.

除非另有說明，此報告結果僅對測試之樣品負責，同時此樣品僅保留90天。本報告未經本公司書面許可，不可部份複製。
This document is issued by the Company subject to its General Conditions of Service printed overleaf, available on request or accessible at <http://www.sgs.com.tw/Terms-and-Conditions> and for electronic format documents, subject to Terms and Conditions for Electronic Documents at <http://www.sgs.com.tw/Terms-and-Conditions>. Attention is drawn to the limitation of liability, indemnification and jurisdiction issues defined therein. Any holder of this document is advised that information contained hereon reflects the Company's findings at the time of its intervention only and within the limits of Client's instructions, if any. The Company's sole responsibility is to its Client and this document does not exonerate parties to a transaction from exercising all their rights and obligations under the transaction documents. This document cannot be reproduced except in full, without prior written approval of the Company. Any unauthorized alteration, forgery or falsification of the content or appearance of this document is unlawful and offenders may be prosecuted to the fullest extent of the law.

7.4 Measurement Procedure

1. The EUT was placed on a table which is 0.8m above ground plane.
2. Maximum procedure was performed on the six highest emissions to ensure EUT compliance.
3. Repeat above procedures until all phases of power being supplied by given UE are completed

7.5 Measurement Result

Note: Refer to next page for measurement data and plots.

Note2: The * reveals the worst-case results that closest to the limit.

Unless otherwise stated the results shown in this test report refer only to the sample(s) tested and such sample(s) are retained for 90 days only.
除非另有說明，此報告結果僅對測試之樣品負責，同時此樣品僅保留90天。本報告未經本公司書面許可，不可部份複製。

This document is issued by the Company subject to its General Conditions of Service printed overleaf, available on request or accessible at <http://www.sgs.com.tw/Terms-and-Conditions> and for electronic format documents, subject to Terms and Conditions for Electronic Documents at <http://www.sgs.com.tw/Terms-and-Conditions>. Attention is drawn to the limitation of liability, indemnification and jurisdiction issues defined therein. Any holder of this document is advised that information contained hereon reflects the Company's findings at the time of its intervention only and within the limits of Client's instructions, if any. The Company's sole responsibility is to its Client and this document does not exonerate parties to a transaction from exercising all their rights and obligations under the transaction documents. This document cannot be reproduced except in full, without prior written approval of the Company. Any unauthorized alteration, forgery or falsification of the content or appearance of this document is unlawful and offenders may be prosecuted to the fullest extent of the law.

AC POWER LINE CONDUCTED EMISSION TEST DATA

Report Number	:TERF2303000623E2	Test Site	:Conduction C
Test Mode	:Wifi 2.4G	Test Date	:2023-04-26
Power	:120V60Hz	Temp./Humi.	:23.4°C /64%
Probe	:L1	Engineer	:Temo Chen

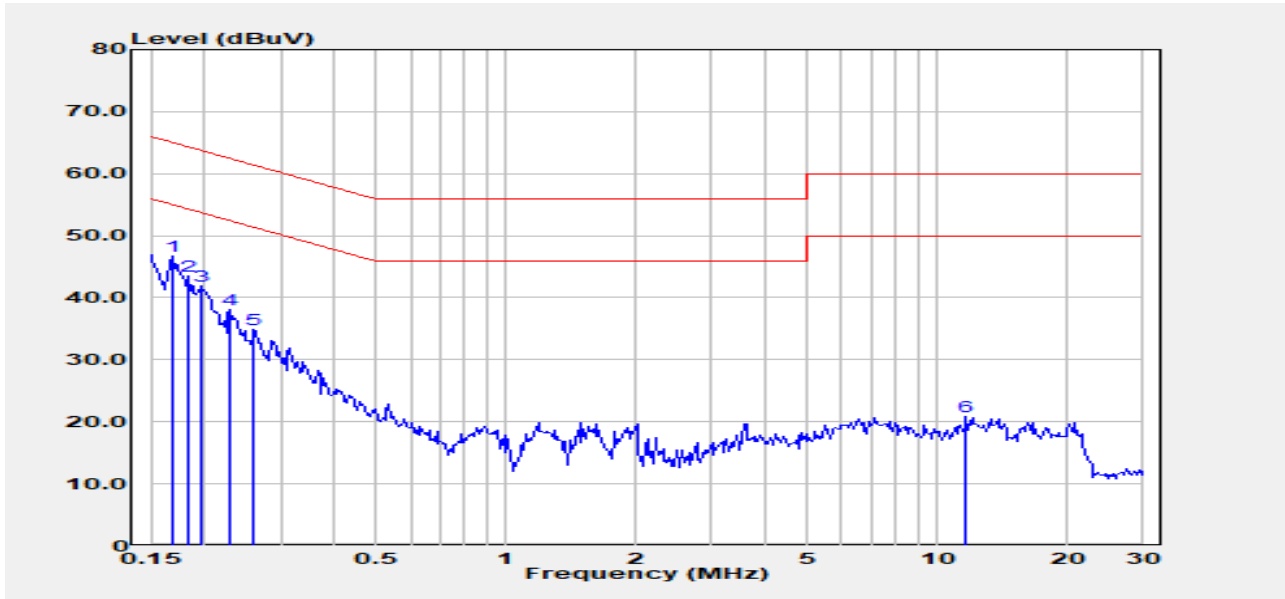

Freq.	Detector	Spectrum	Factor	Actual	Limit	Margin
MHz	Mode	Reading Level		FS		
	PK/QP/AV	dB μ V	dB	dB μ V	dB μ V	dB
0.169	Peak	36.40	10.27	46.67	65.03	-18.36
0.183	Peak	33.23	10.27	43.50	64.33	-20.83
0.195	Peak	31.71	10.27	41.98	63.80	-21.82
0.229	Peak	27.86	10.28	38.14	62.48	-24.34
0.260	Peak	24.57	10.28	34.85	61.42	-26.57
11.683	Peak	10.19	10.71	20.90	60.00	-39.10

Unless otherwise stated the results shown in this test report refer only to the sample(s) tested and such sample(s) are retained for 90 days only.

除非另有說明，此報告結果僅對測試之樣品負責，同時此樣品僅保留90天。本報告未經本公司書面許可，不可部份複製。
 This document is issued by the Company subject to its General Conditions of Service printed overleaf, available on request or accessible at <http://www.sgs.com.tw/Terms-and-Conditions> and for electronic format documents, subject to Terms and Conditions for Electronic Documents at <http://www.sgs.com.tw/Terms-and-Conditions>. Attention is drawn to the limitation of liability, indemnification and jurisdiction issues defined therein. Any holder of this document is advised that information contained hereon reflects the Company's findings at the time of its intervention only and within the limits of Client's instructions, if any. The Company's sole responsibility is to its Client and this document does not exonerate parties to a transaction from exercising all their rights and obligations under the transaction documents. This document cannot be reproduced except in full, without prior written approval of the Company. Any unauthorized alteration, forgery or falsification of the content or appearance of this document is unlawful and offenders may be prosecuted to the fullest extent of the law.

Report Number	:TERF2303000623E2	Test Site	:Conduction C
Test Mode	:Wifi 2.4G	Test Date	:2023-04-26
Power	:120V60Hz	Temp./Humi.	:23.4°C /64%
Probe	:N	Engineer	:Temo Chen

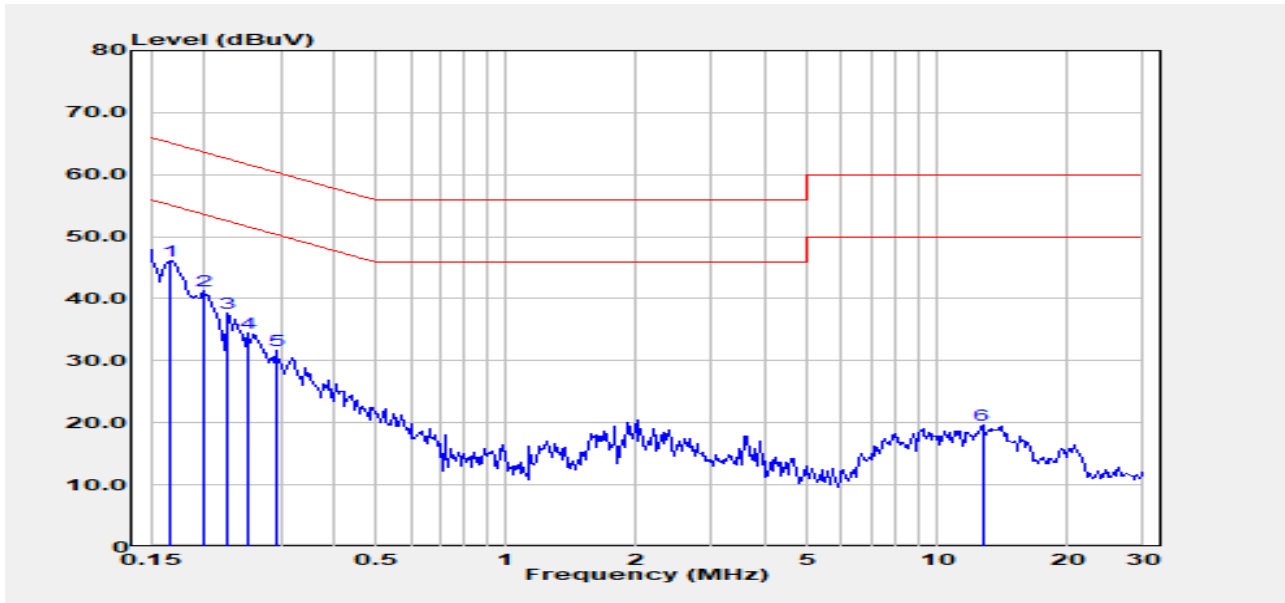

Freq.	Detector	Spectrum	Factor	Actual	Limit	Margin
MHz	Mode	Reading Level	dB	FS	dBμV	dB
	PK/QP/AV	dBμV		dBμV		
0.167	Peak	35.85	10.28	46.13	65.12	-18.99
0.200	Peak	31.00	10.27	41.27	63.62	-22.36
0.227	Peak	27.35	10.27	37.62	62.57	-24.94
0.252	Peak	24.20	10.28	34.48	61.69	-27.21
0.292	Peak	21.47	10.28	31.76	60.46	-28.70
12.716	Peak	8.91	10.69	19.60	60.00	-40.40

Unless otherwise stated the results shown in this test report refer only to the sample(s) tested and such sample(s) are retained for 90 days only.

除非另有說明，此報告結果僅對測試之樣品負責，同時此樣品僅保留90天。本報告未經本公司書面許可，不可部份複製。

This document is issued by the Company subject to its General Conditions of Service printed overleaf, available on request or accessible at <http://www.sgs.com.tw/Terms-and-Conditions> and for electronic format documents, subject to Terms and Conditions for Electronic Documents at <http://www.sgs.com.tw/Terms-and-Conditions>. Attention is drawn to the limitation of liability, indemnification and jurisdiction issues defined therein. Any holder of this document is advised that information contained hereon reflects the Company's findings at the time of its intervention only and within the limits of Client's instructions, if any. The Company's sole responsibility is to its Client and this document does not exonerate parties to a transaction from exercising all their rights and obligations under the transaction documents. This document cannot be reproduced except in full, without prior written approval of the Company. Any unauthorized alteration, forgery or falsification of the content or appearance of this document is unlawful and offenders may be prosecuted to the fullest extent of the law.

8 PEAK OUTPUT POWER MEASUREMENT

8.1 Standard Applicable

8.2 Duty Cycle

Pre-analysis Check: While conducting average power measurement, duty cycle of each mode shall be checked to ensure its duty cycle in order to compensate for the loss due to insufficient ratio of duty cycle.

All duty cycle is pre-scanned, and result as obtained below shows only the most representative ones where duty cycle is conducted as the given transmission with given virtual operation that expresses the percentage.

8.3 Output Power

For systems using digital modulation in the 2400-2483.5 MHz bands, the limit for peak output power is 1Watt and the e.i.r.p. shall not exceed 4 W.

If the transmitting antenna of directional gain greater than 6dBi are used the peak output power form the intentional radiator shall be reduced below the above stated value by the amount in dB that the directional gain of the Antenna exceeds 6dBi.

In case of point-to-point operation, the limit has to be reduced by 1dB for every 3dB that the directional gain of Antenna exceeds 6dBi.

The antenna gain is not greater than 6 dBi. Therefore, reduction of power is not required.

8.4 Test Setup

8.4.1 Duty Cycle

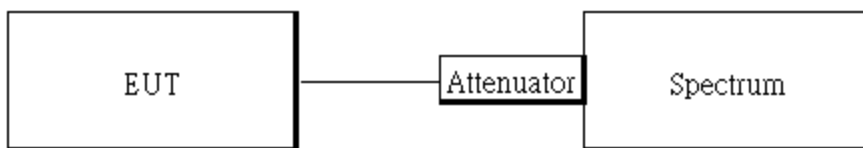

8.4.2 Output Power:

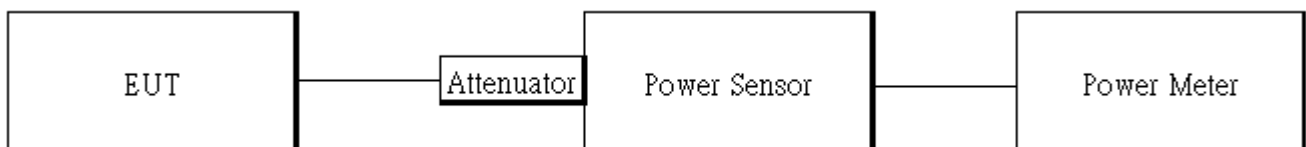

Unless otherwise stated the results shown in this test report refer only to the sample(s) tested and such sample(s) are retained for 90 days only.
 除非另有說明，此報告結果僅對測試之樣品負責，同時此樣品僅保留90天。本報告未經本公司書面許可，不可部份複製。

This document is issued by the Company subject to its General Conditions of Service printed overleaf, available on request or accessible at <http://www.sgs.com.tw/Terms-and-Conditions> and for electronic format documents, subject to Terms and Conditions for Electronic Documents at <http://www.sgs.com.tw/Terms-and-Conditions>. Attention is drawn to the limitation of liability, indemnification and jurisdiction issues defined therein. Any holder of this document is advised that information contained hereon reflects the Company's findings at the time of its intervention only and within the limits of Client's instructions, if any. The Company's sole responsibility is to its Client and this document does not exonerate parties to a transaction from exercising all their rights and obligations under the transaction documents. This document cannot be reproduced except in full, without prior written approval of the Company. Any unauthorized alteration, forgery or falsification of the content or appearance of this document is unlawful and offenders may be prosecuted to the fullest extent of the law.

8.5 Measurement Procedure

8.5.1 Duty Cycle:

1. Set span = Zero
2. RBW = 8MHz
3. VBW = 8MHz,
4. Detector = Peak

8.5.2 Output Power

1. Place the EUT on the table and set it in transmitting mode.
2. The testing follows the Measurement Procedure of FCC KDB 558074 D01 DTS Meas. Guidance .
3. Remove the antenna from the EUT and then connect a low loss RF cable from the antenna port to the power meter.

Power Meter:

It is used as the auxiliary test equipment to conduct the output power measurement.

4. Record the max. Reading as observed from Spectrum or Power Meter.

*** Note: The duty cycle factor and below is compensated to obtain the maximum value of measurement in average.**

8.6 Measurement Result

8.6.1 Duty Cycle:

	Duty Cycle (%) = Ton / (Ton+Toff)	Duty Factor (dB) =10*log (1/Duty Cycle)	1/T (kHz)	VBW setting (kHz)
802.11b	99.57	0.02	0.12	0.01
802.11g	96.94	0.13	0.72	1.00
802.11n_20	96.73	0.14	0.77	1.00
802.11n_40	93.64	0.29	1.54	2.00
802.11ac_20	96.76	0.14	0.76	1.00
802.11ac_40	93.68	0.28	1.53	2.00

Unless otherwise stated the results shown in this test report refer only to the sample(s) tested and such sample(s) are retained for 90 days only.
除非另有說明，此報告結果僅對測試之樣品負責，同時此樣品僅保留90天。本報告未經本公司書面許可，不可部份複製。

This document is issued by the Company subject to its General Conditions of Service printed overleaf, available on request or accessible at <http://www.sgs.com.tw/Terms-and-Conditions> and for electronic format documents, subject to Terms and Conditions for Electronic Documents at <http://www.sgs.com.tw/Terms-and-Conditions>. Attention is drawn to the limitation of liability, indemnification and jurisdiction issues defined therein. Any holder of this document is advised that information contained hereon reflects the Company's findings at the time of its intervention only and within the limits of Client's instructions, if any. The Company's sole responsibility is to its Client and this document does not exonerate parties to a transaction from exercising all their rights and obligations under the transaction documents. This document cannot be reproduced except in full, without prior written approval of the Company. Any unauthorized alteration, forgery or falsification of the content or appearance of this document is unlawful and offenders may be prosecuted to the fullest extent of the law.

8.6.2 Duty Cycle test plots

802.11b_20MHz_Chain0_2412MHz

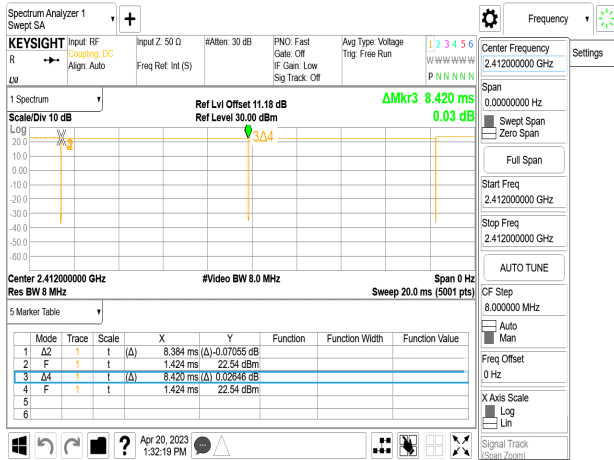

802.11n_40MHz_Chain0_2422MHz

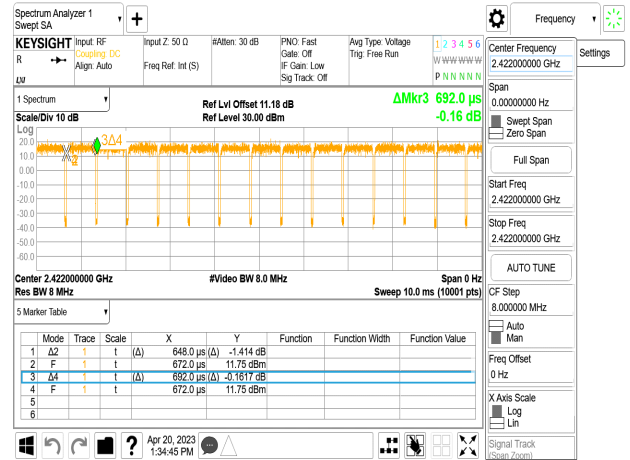

802.11g_20MHz_Chain0_2412MHz

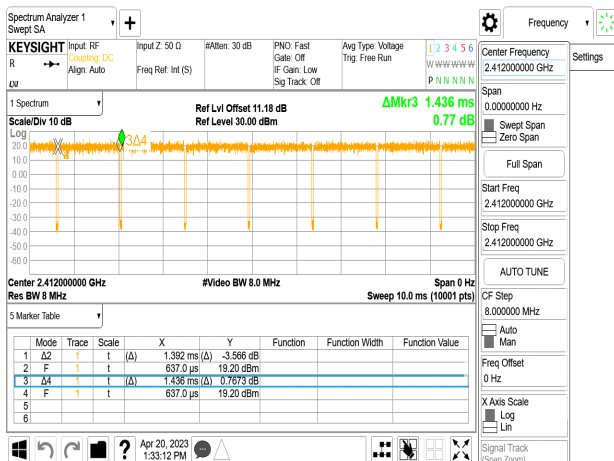

802.11ac_20MHz_Chain0_2412MHz



802.11n_20MHz_Chain0_2412MHz

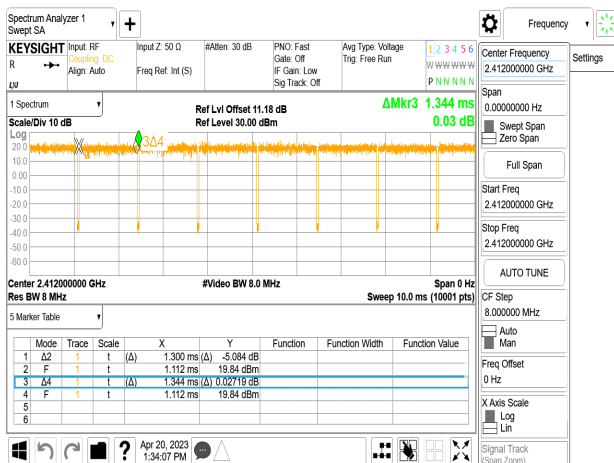

802.11ac_40MHz_Chain0_2422MHz

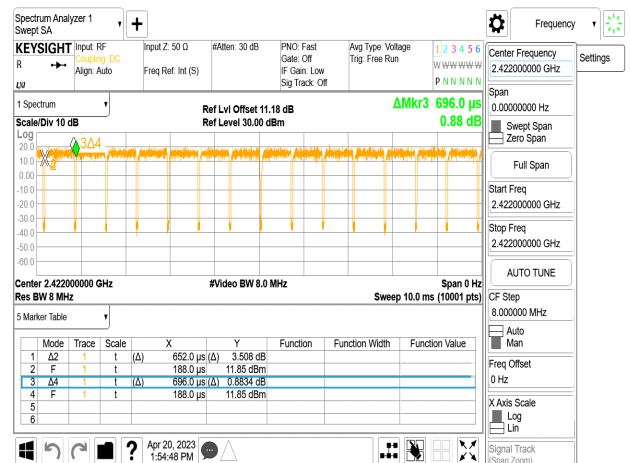

Unless otherwise stated the results shown in this test report refer only to the sample(s) tested and such sample(s) are retained for 90 days only.

除非另有說明，此報告結果僅對測試之樣品負責，同時此樣品僅保留90天。本報告未經本公司書面許可，不可部份複製。

This document is issued by the Company subject to its General Conditions of Service printed overleaf, available on request or accessible at <http://www.sgs.com.tw/Terms-and-Conditions> and for electronic format documents, subject to Terms and Conditions for Electronic Documents at <http://www.sgs.com.tw/Terms-and-Conditions>. Attention is drawn to the limitation of liability, indemnification and jurisdiction issues defined therein. Any holder of this document is advised that information contained hereon reflects the Company's findings at the time of its intervention only and within the limits of Client's instructions, if any. The Company's sole responsibility is to its Client and this document does not exonerate parties to a transaction from exercising all their rights and obligations under the transaction documents. This document cannot be reproduced except in full, without prior written approval of the Company. Any unauthorized alteration, forgery or falsification of the content or appearance of this document is unlawful and offenders may be prosecuted to the fullest extent of the law.

8.6.3 Output Power

802.11b Ch0						
CH	Freq. (MHz)	Data Rate	Power set	Peak Output Power (dBm)	Limit (dBm)	RESULT
1	2412	1	20.5	22.19	30.00	PASS
6	2437	1	20.5	22.28	30.00	PASS
11	2462	1	20.5	22.22	30.00	PASS

802.11b Ch0						
CH	Freq. (MHz)	Data Rate	Power set	Max. Avg. Output include tune up tolerance Power (dBm)	Limit (dBm)	RESULT
1	2412	1	20.5	19.96	30.00	PASS
6	2437	1	20.5	20.03	30.00	PASS
11	2462	1	20.5	19.97	30.00	PASS

802.11g Ch0						
CH	Freq. (MHz)	Data Rate	Power set	Peak Output Power (dBm)	Limit (dBm)	RESULT
1	2412	6	15	24.07	30.00	PASS
6	2437	6	16	24.46	30.00	PASS
11	2462	6	16	24.39	30.00	PASS

802.11g Ch0						
CH	Freq. (MHz)	Data Rate	Power set	Max. Avg. Output include tune up tolerance Power (dBm)	Limit (dBm)	RESULT
1	2412	6	15	14.64	30.00	PASS
6	2437	6	16	15.46	30.00	PASS
11	2462	6	16	15.37	30.00	PASS

Unless otherwise stated the results shown in this test report refer only to the sample(s) tested and such sample(s) are retained for 90 days only.

除非另有說明，此報告結果僅對測試之樣品負責，同時此樣品僅保留90天。本報告未經本公司書面許可，不可部份複製。

This document is issued by the Company subject to its General Conditions of Service printed overleaf, available on request or accessible at <http://www.sgs.com.tw/Terms-and-Conditions> and for electronic format documents, subject to Terms and Conditions for Electronic Documents at <http://www.sgs.com.tw/Terms-and-Conditions>. Attention is drawn to the limitation of liability, indemnification and jurisdiction issues defined therein. Any holder of this document is advised that information contained hereon reflects the Company's findings at the time of its intervention only and within the limits of Client's instructions, if any. The Company's sole responsibility is to its Client and this document does not exonerate parties to a transaction from exercising all their rights and obligations under the transaction documents. This document cannot be reproduced except in full, without prior written approval of the Company. Any unauthorized alteration, forgery or falsification of the content or appearance of this document is unlawful and offenders may be prosecuted to the fullest extent of the law.

802.11n_HT_20M Ch0						
CH	Freq. (MHz)	Data Rate	Power set	Peak Output Power (dBm)	Limit (dBm)	RESULT
1	2412	MCS0	14.5	24.85	30.00	PASS
6	2437	MCS0	16	25.61	30.00	PASS
11	2462	MCS0	16	25.50	30.00	PASS

802.11n_HT_20M Ch0						
CH	Freq. (MHz)	Data Rate	Power set	Max. Avg. Output include tune up tolerance Power (dBm)	Limit (dBm)	RESULT
1	2412	MCS0	14.5	13.93	30.00	PASS
6	2437	MCS0	16	15.38	30.00	PASS
11	2462	MCS0	16	15.27	30.00	PASS

802.11n_HT_40M Ch0						
CH	Freq. (MHz)	Data Rate	Power set	Peak Output Power (dBm)	Limit (dBm)	RESULT
3	2422	MCS0	12	22.55	30.00	PASS
6	2437	MCS0	16	25.47	30.00	PASS
9	2452	MCS0	15	25.16	30.00	PASS

802.11n_HT_40M Ch0						
CH	Freq. (MHz)	Data Rate	Power set	Max. Avg. Output include tune up tolerance Power (dBm)	Limit (dBm)	RESULT
3	2422	MCS0	12	11.83	30.00	PASS
6	2437	MCS0	16	15.67	30.00	PASS
9	2452	MCS0	15	14.75	30.00	PASS

Unless otherwise stated the results shown in this test report refer only to the sample(s) tested and such sample(s) are retained for 90 days only.

除非另有說明，此報告結果僅對測試之樣品負責，同時此樣品僅保留90天。本報告未經本公司書面許可，不可部份複製。

This document is issued by the Company subject to its General Conditions of Service printed overleaf, available on request or accessible at <http://www.sgs.com.tw/Terms-and-Conditions> and for electronic format documents, subject to Terms and Conditions for Electronic Documents at <http://www.sgs.com.tw/Terms-and-Conditions>. Attention is drawn to the limitation of liability, indemnification and jurisdiction issues defined therein. Any holder of this document is advised that information contained hereon reflects the Company's findings at the time of its intervention only and within the limits of Client's instructions, if any. The Company's sole responsibility is to its Client and this document does not exonerate parties to a transaction from exercising all their rights and obligations under the transaction documents. This document cannot be reproduced except in full, without prior written approval of the Company. Any unauthorized alteration, forgery or falsification of the content or appearance of this document is unlawful and offenders may be prosecuted to the fullest extent of the law.

802.11ac_VHT_20M Ch0						
CH	Freq. (MHz)	Data Rate	Power set	Peak Output Power (dBm)	Limit (dBm)	RESULT
1	2412	MCS0	14.5	23.33	30.00	PASS
6	2437	MCS0	16	24.71	30.00	PASS
11	2462	MCS0	16	24.59	30.00	PASS
802.11ac_VHT_20M Ch0						
CH	Freq. (MHz)	Data Rate	Power set	Max. Avg. Output include tune up tolerance Power (dBm)	Limit (dBm)	RESULT
1	2412	MCS0	14.5	13.88	30.00	PASS
6	2437	MCS0	16	15.32	30.00	PASS
11	2462	MCS0	16	15.25	30.00	PASS

802.11ac_VHT_40M Ch0						
CH	Freq. (MHz)	Data Rate	Power set	Peak Output Power (dBm)	Limit (dBm)	RESULT
3	2422	MCS0	12	21.52	30.00	PASS
6	2437	MCS0	16	24.66	30.00	PASS
9	2452	MCS0	15	24.05	30.00	PASS
802.11ac_VHT_40M Ch0						
CH	Freq. (MHz)	Data Rate	Power set	Max. Avg. Output include tune up tolerance Power (dBm)	Limit (dBm)	RESULT
3	2422	MCS0	12	11.79	30.00	PASS
6	2437	MCS0	16	15.49	30.00	PASS
9	2452	MCS0	15	14.73	30.00	PASS

Unless otherwise stated the results shown in this test report refer only to the sample(s) tested and such sample(s) are retained for 90 days only.

除非另有說明，此報告結果僅對測試之樣品負責，同時此樣品僅保留90天。本報告未經本公司書面許可，不可部份複製。

This document is issued by the Company subject to its General Conditions of Service printed overleaf, available on request or accessible at <http://www.sgs.com.tw/Terms-and-Conditions> and for electronic format documents, subject to Terms and Conditions for Electronic Documents at <http://www.sgs.com.tw/Terms-and-Conditions>. Attention is drawn to the limitation of liability, indemnification and jurisdiction issues defined therein. Any holder of this document is advised that information contained hereon reflects the Company's findings at the time of its intervention only and within the limits of Client's instructions, if any. The Company's sole responsibility is to its Client and this document does not exonerate parties to a transaction from exercising all their rights and obligations under the transaction documents. This document cannot be reproduced except in full, without prior written approval of the Company. Any unauthorized alteration, forgery or falsification of the content or appearance of this document is unlawful and offenders may be prosecuted to the fullest extent of the law.

802.11b Ch0							
CH	Freq. (MHz)	Data Rate	Avg. Output Power (dBm)	Antenna Gain (dBi)	EIRP (dBm)	Limit (dBm)	RESULT
1	2412	1	19.96	2.23	22.19	36	PASS
6	2437	1	20.03	2.23	22.26	36	PASS
11	2462	1	19.97	2.23	22.20	36	PASS

802.11g Ch0							
CH	Freq. (MHz)	Data Rate	Avg. Output Power (dBm)	Antenna Gain (dBi)	EIRP (dBm)	Limit (dBm)	RESULT
1	2412	6	14.64	2.23	16.87	36	PASS
6	2437	6	15.46	2.23	17.69	36	PASS
11	2462	6	15.37	2.23	17.60	36	PASS

802.11n_HT_20M Ch0							
CH	Freq. (MHz)	Data Rate	Avg. Output Power (dBm)	Antenna Gain (dBi)	EIRP (dBm)	Limit (dBm)	RESULT
1	2412	MCS0	13.93	2.23	16.16	36	PASS
6	2437	MCS0	15.38	2.23	17.61	36	PASS
11	2462	MCS0	15.27	2.23	17.50	36	PASS

802.11n_HT_40M Ch0							
CH	Freq. (MHz)	Data Rate	Avg. Output Power (dBm)	Antenna Gain (dBi)	EIRP (dBm)	Limit (dBm)	RESULT
3	2422	MCS0	11.83	2.23	14.06	36	PASS
6	2437	MCS0	15.67	2.23	17.90	36	PASS
9	2452	MCS0	14.75	2.23	16.98	36	PASS

802.11ac_VHT_20M Ch0							
CH	Freq. (MHz)	Data Rate	Avg. Output Power (dBm)	Antenna Gain (dBi)	EIRP (dBm)	Limit (dBm)	RESULT
1	2412	MCS0	13.88	2.23	16.11	36	PASS
6	2437	MCS0	15.32	2.23	17.55	36	PASS
11	2462	MCS0	15.25	2.23	17.48	36	PASS

Unless otherwise stated the results shown in this test report refer only to the sample(s) tested and such sample(s) are retained for 90 days only.

除非另有說明，此報告結果僅對測試之樣品負責，同時此樣品僅保留90天。本報告未經本公司書面許可，不可部份複製。

This document is issued by the Company subject to its General Conditions of Service printed overleaf, available on request or accessible at <http://www.sgs.com.tw/Terms-and-Conditions> and for electronic format documents, subject to Terms and Conditions for Electronic Documents at <http://www.sgs.com.tw/Terms-and-Conditions>. Attention is drawn to the limitation of liability, indemnification and jurisdiction issues defined therein. Any holder of this document is advised that information contained hereon reflects the Company's findings at the time of its intervention only and within the limits of Client's instructions, if any. The Company's sole responsibility is to its Client and this document does not exonerate parties to a transaction from exercising all their rights and obligations under the transaction documents. This document cannot be reproduced except in full, without prior written approval of the Company. Any unauthorized alteration, forgery or falsification of the content or appearance of this document is unlawful and offenders may be prosecuted to the fullest extent of the law.

802.11ac_VHT_40M Ch0							
CH	Freq. (MHz)	Data Rate	Avg. Output Power (dBm)	Antenna Gain (dBi)	EIRP (dBm)	Limit (dBm)	RESULT
3	2422	MCS0	11.79	2.23	14.02	36	PASS
6	2437	MCS0	15.49	2.23	17.72	36	PASS
9	2452	MCS0	14.73	2.23	16.96	36	PASS

Unless otherwise stated the results shown in this test report refer only to the sample(s) tested and such sample(s) are retained for 90 days only.
 除非另有說明，此報告結果僅對測試之樣品負責，同時此樣品僅保留90天。本報告未經本公司書面許可，不可部份複製。

This document is issued by the Company subject to its General Conditions of Service printed overleaf, available on request or accessible at <http://www.sgs.com.tw/Terms-and-Conditions> and for electronic format documents, subject to Terms and Conditions for Electronic Documents at <http://www.sgs.com.tw/Terms-and-Conditions>. Attention is drawn to the limitation of liability, indemnification and jurisdiction issues defined therein. Any holder of this document is advised that information contained hereon reflects the Company's findings at the time of its intervention only and within the limits of Client's instructions, if any. The Company's sole responsibility is to its Client and this document does not exonerate parties to a transaction from exercising all their rights and obligations under the transaction documents. This document cannot be reproduced except in full, without prior written approval of the Company. Any unauthorized alteration, forgery or falsification of the content or appearance of this document is unlawful and offenders may be prosecuted to the fullest extent of the law.

9 EMISSION BANDWIDTH MEASUREMENT

9.1 Standard Applicable

The minimum 6 dB bandwidth shall be at least 500 kHz.

9.2 Test Setup

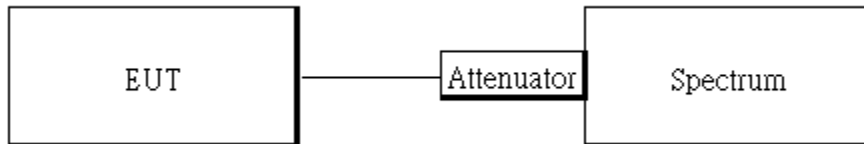

9.3 Measurement Procedure:

1. Place the EUT on the table and set it in transmitting mode.
2. Remove the antenna from the EUT and then connect a low loss RF cable from the antenna port to the spectrum analyzer.

9.3.1 FCC measurements

1. The testing follows the Measurement Procedure of the KDB 558074 D01.
2. Set the spectrum analyzer as
RBW= 100 kHz ,
VBW = 3 X RBW,
Span= 2 to 5 times of the OBW,
Sweep=auto, Detector = Peak, and Max hold.
3. Mark the upper and lower frequencies of -6dB.
4. Repeat above procedures until all test default channel is completed.

9.3.2 ISED measurements

1. The testing follows the Measurement Procedure of the RSS-Gen section 6.7.
2. Set the spectrum analyzer as
RBW= 1 % to 5% of 99% and -6dB Bandwidth ,
VBW \geq 3 X RBW,
Span= large enough to capture all products of the modulation process
Sweep=auto, Detector = Peak, and Max hold.
3. Mark the upper and lower frequencies of 99% and -6dB.
4. Repeat above procedures until all test default channel is completed.

Unless otherwise stated the results shown in this test report refer only to the sample(s) tested and such sample(s) are retained for 90 days only.
除非另有說明，此報告結果僅對測試之樣品負責，同時此樣品僅保留90天。本報告未經本公司書面許可，不可部份複製。

This document is issued by the Company subject to its General Conditions of Service printed overleaf, available on request or accessible at <http://www.sgs.com.tw/Terms-and-Conditions> and for electronic format documents, subject to Terms and Conditions for Electronic Documents at <http://www.sgs.com.tw/Terms-and-Conditions>. Attention is drawn to the limitation of liability, indemnification and jurisdiction issues defined therein. Any holder of this document is advised that information contained hereon reflects the Company's findings at the time of its intervention only and within the limits of Client's instructions, if any. The Company's sole responsibility is to its Client and this document does not exonerate parties to a transaction from exercising all their rights and obligations under the transaction documents. This document cannot be reproduced except in full, without prior written approval of the Company. Any unauthorized alteration, forgery or falsification of the content or appearance of this document is unlawful and offenders may be prosecuted to the fullest extent of the law.

9.4 6dB Bandwidth

802.11b Ch0

Freq. (MHz)	6dB BW (kHz)	Limit (kHz)	Result
2412	8567.00	≥ 500	PASS
2437	8103.00	≥ 500	PASS
2462	8096.00	≥ 500	PASS

802.11g Ch0

Freq. (MHz)	6dB BW (kHz)	Limit (kHz)	Result
2412	15140.00	≥ 500	PASS
2437	15150.00	≥ 500	PASS
2462	15140.00	≥ 500	PASS

802.11n_HT_20M Ch0

Freq. (MHz)	6dB BW (kHz)	Limit (kHz)	Result
2412	15350.00	≥ 500	PASS
2437	15150.00	≥ 500	PASS
2462	15160.00	≥ 500	PASS

802.11n_HT_40M Ch0

Freq. (MHz)	6dB BW (kHz)	Limit (kHz)	Result
2422	35160.00	≥ 500	PASS
2437	35160.00	≥ 500	PASS
2452	35160.00	≥ 500	PASS

Unless otherwise stated the results shown in this test report refer only to the sample(s) tested and such sample(s) are retained for 90 days only.
 除非另有說明，此報告結果僅對測試之樣品負責，同時此樣品僅保留90天。本報告未經本公司書面許可，不可部份複製。

This document is issued by the Company subject to its General Conditions of Service printed overleaf, available on request or accessible at <http://www.sgs.com.tw/Terms-and-Conditions> and for electronic format documents, subject to Terms and Conditions for Electronic Documents at <http://www.sgs.com.tw/Terms-and-Conditions>. Attention is drawn to the limitation of liability, indemnification and jurisdiction issues defined therein. Any holder of this document is advised that information contained hereon reflects the Company's findings at the time of its intervention only and within the limits of Client's instructions, if any. The Company's sole responsibility is to its Client and this document does not exonerate parties to a transaction from exercising all their rights and obligations under the transaction documents. This document cannot be reproduced except in full, without prior written approval of the Company. Any unauthorized alteration, forgery or falsification of the content or appearance of this document is unlawful and offenders may be prosecuted to the fullest extent of the law.

802.11b_20MHz_Chain0_2412MHz

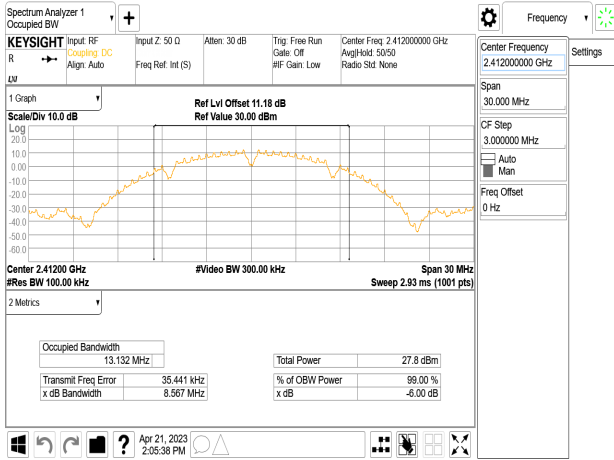

802.11g_20MHz_Chain0_2412MHz

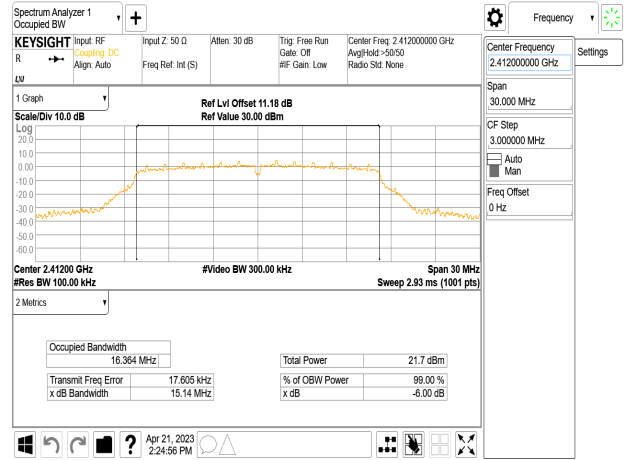

802.11b_20MHz_Chain0_2437MHz

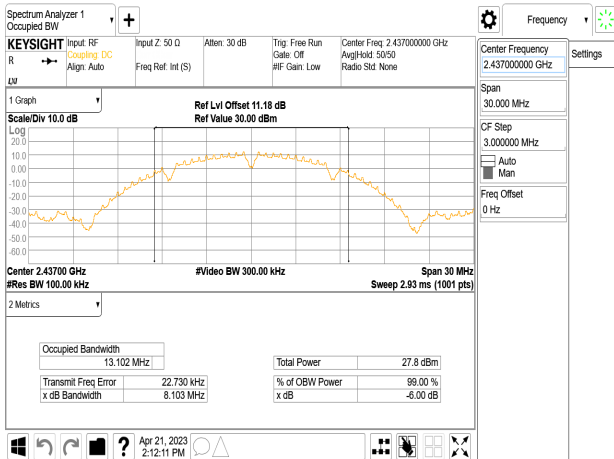

802.11g_20MHz_Chain0_2437MHz

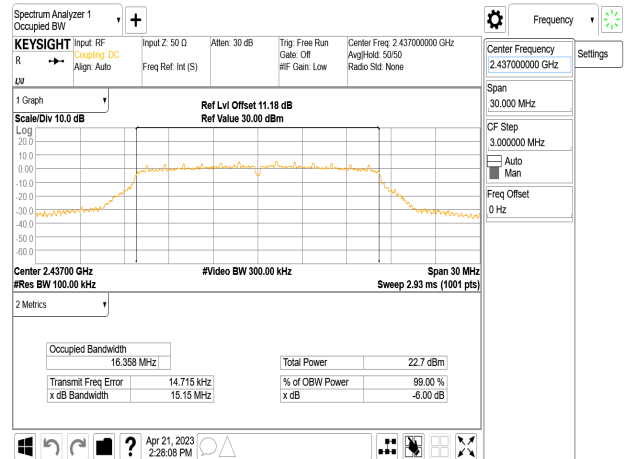

802.11b_20MHz_Chain0_2462MHz

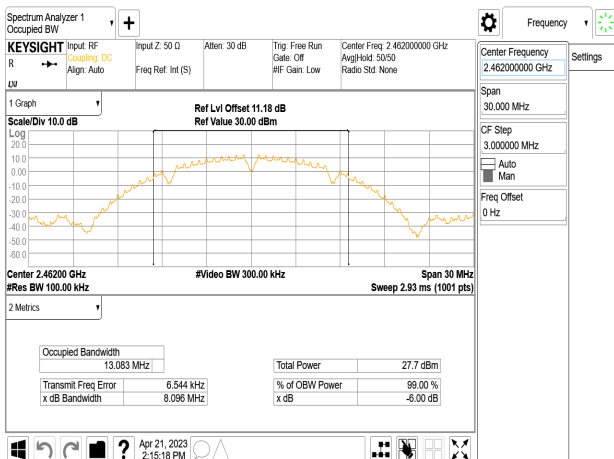

802.11g_20MHz_Chain0_2462MHz

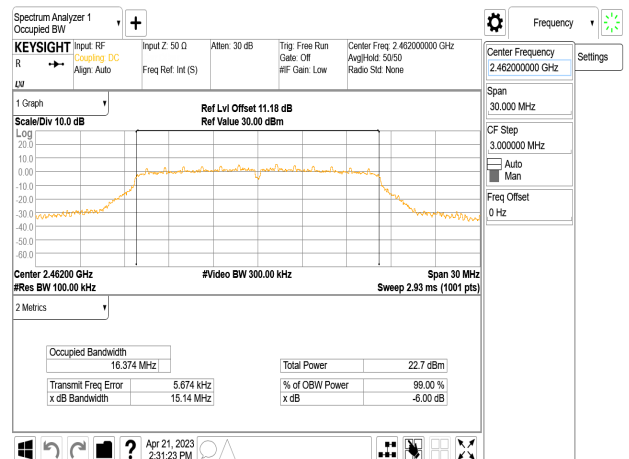

Unless otherwise stated the results shown in this test report refer only to the sample(s) tested and such sample(s) are retained for 90 days only.

除非另有說明，此報告結果僅對測試之樣品負責，同時此樣品僅保留90天。本報告未經本公司書面許可，不可部份複製。

This document is issued by the Company subject to its General Conditions of Service printed overleaf, available on request or accessible at <http://www.sgs.com.tw/Terms-and-Conditions> and for electronic format documents, subject to Terms and Conditions for Electronic Documents at <http://www.sgs.com.tw/Terms-and-Conditions>. Attention is drawn to the limitation of liability, indemnification and jurisdiction issues defined therein. Any holder of this document is advised that information contained hereon reflects the Company's findings at the time of its intervention only and within the limits of Client's instructions, if any. The Company's sole responsibility is to its Client and this document does not exonerate parties to a transaction from exercising all their rights and obligations under the transaction documents. This document cannot be reproduced except in full, without prior written approval of the Company. Any unauthorized alteration, forgery or falsification of the content or appearance of this document is unlawful and offenders may be prosecuted to the fullest extent of the law.

802.11n_20MHz_Chain0_2412MHz

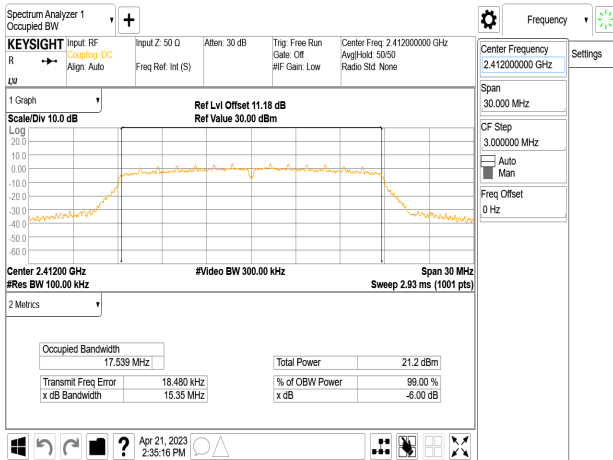

802.11n_40MHz_Chain0_2422MHz

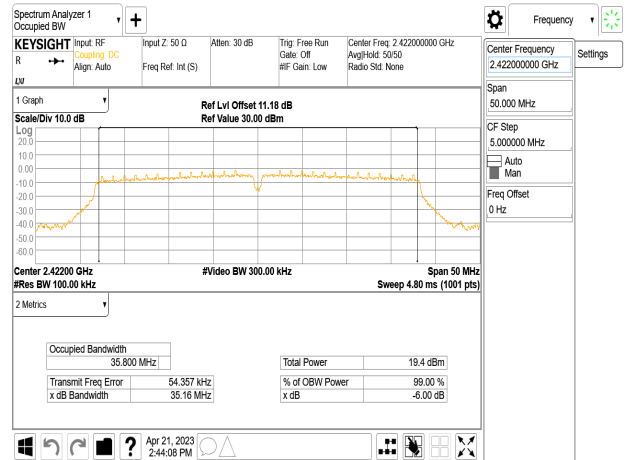

802.11n_20MHz_Chain0_2437MHz

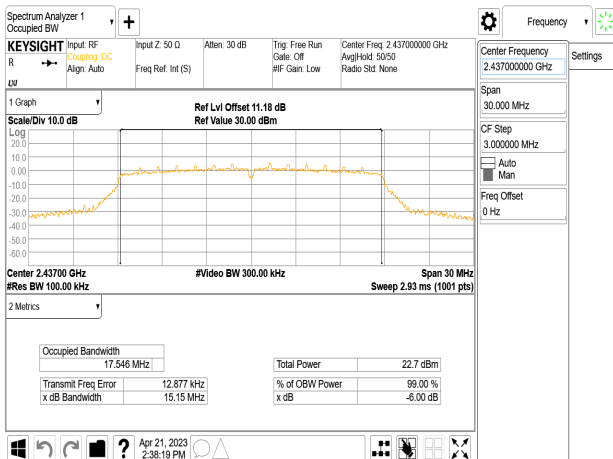

802.11n_40MHz_Chain0_2437MHz

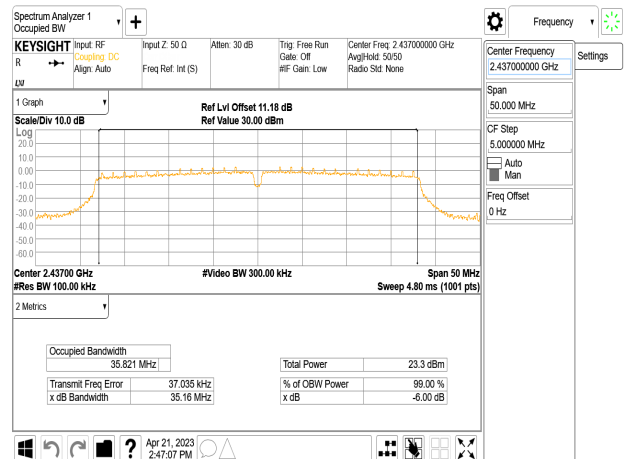

802.11n_20MHz_Chain0_2462MHz

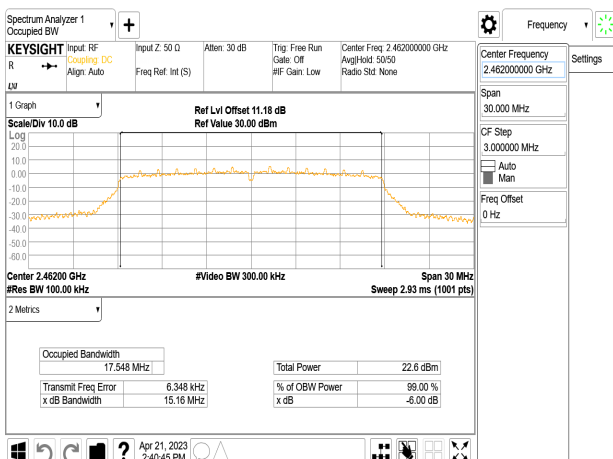

802.11n_40MHz_Chain0_2452MHz

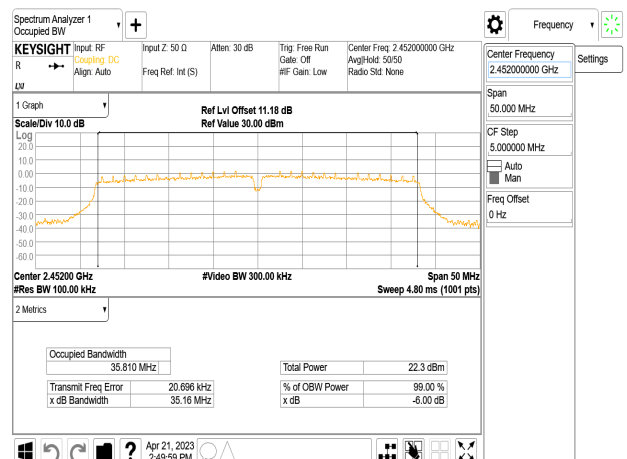

Unless otherwise stated the results shown in this test report refer only to the sample(s) tested and such sample(s) are retained for 90 days only.

除非另有說明，此報告結果僅對測試之樣品負責，同時此樣品僅保留90天。本報告未經本公司書面許可，不可部份複製。

This document is issued by the Company subject to its General Conditions of Service printed overleaf, available on request or accessible at <http://www.sgs.com.tw/Terms-and-Conditions> and for electronic format documents, subject to Terms and Conditions for Electronic Documents at <http://www.sgs.com.tw/Terms-and-Conditions>. Attention is drawn to the limitation of liability, indemnification and jurisdiction issues defined therein. Any holder of this document is advised that information contained hereon reflects the Company's findings at the time of its intervention only and within the limits of Client's instructions, if any. The Company's sole responsibility is to its Client and this document does not exonerate parties to a transaction from exercising all their rights and obligations under the transaction documents. This document cannot be reproduced except in full, without prior written approval of the Company. Any unauthorized alteration, forgery or falsification of the content or appearance of this document is unlawful and offenders may be prosecuted to the fullest extent of the law.

9.5 99% Bandwidth

802.11b Ch0

Freq. (MHz)	99% BW (MHz)
2412	13.156
2437	13.128
2462	13.076

802.11g Ch0

Freq. (MHz)	99% BW (MHz)
2412	16.686
2437	16.680
2462	16.686

802.11n_HT20M Ch0

Freq. (MHz)	99% BW (MHz)
2412	17.706
2437	17.730
2462	17.703

802.11n_HT40M Ch0

Freq. (MHz)	99% BW (MHz)
2422	36.111
2437	36.128
2452	36.120

Unless otherwise stated the results shown in this test report refer only to the sample(s) tested and such sample(s) are retained for 90 days only.
 除非另有說明，此報告結果僅對測試之樣品負責，同時此樣品僅保留90天。本報告未經本公司書面許可，不可部份複製。

This document is issued by the Company subject to its General Conditions of Service printed overleaf, available on request or accessible at <http://www.sgs.com.tw/Terms-and-Conditions> and for electronic format documents, subject to Terms and Conditions for Electronic Documents at <http://www.sgs.com.tw/Terms-and-Conditions>. Attention is drawn to the limitation of liability, indemnification and jurisdiction issues defined therein. Any holder of this document is advised that information contained hereon reflects the Company's findings at the time of its intervention only and within the limits of Client's instructions, if any. The Company's sole responsibility is to its Client and this document does not exonerate parties to a transaction from exercising all their rights and obligations under the transaction documents. This document cannot be reproduced except in full, without prior written approval of the Company. Any unauthorized alteration, forgery or falsification of the content or appearance of this document is unlawful and offenders may be prosecuted to the fullest extent of the law.

802.11b_20MHz_Chain0_2412MHz

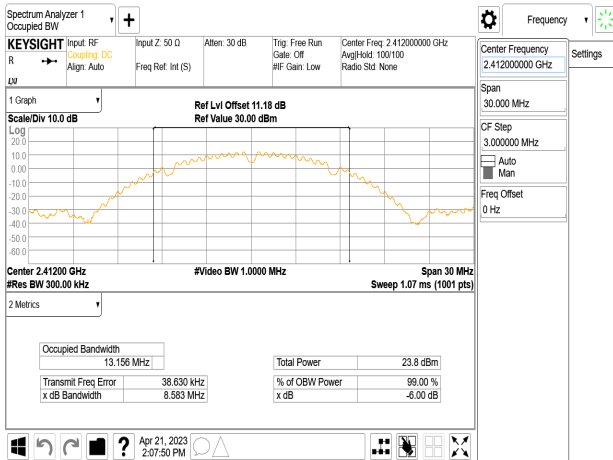

802.11g_20MHz_Chain0_2412MHz

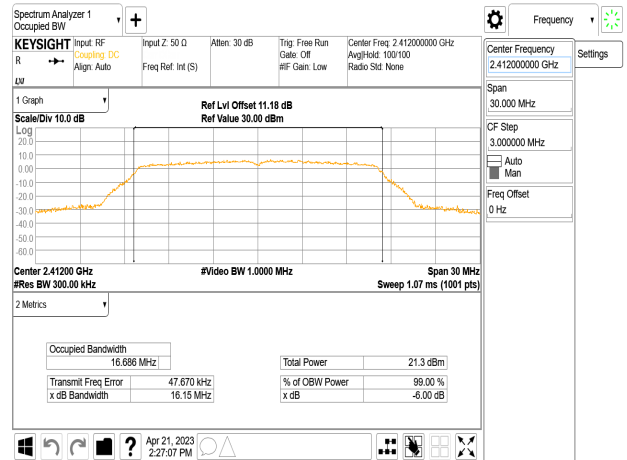

802.11b_20MHz_Chain0_2437MHz

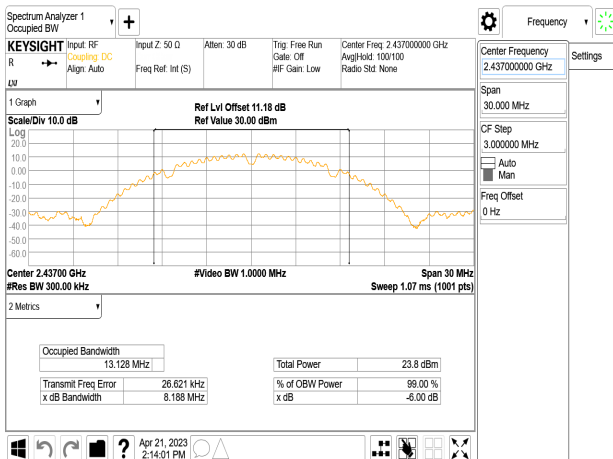

802.11g_20MHz_Chain0_2437MHz

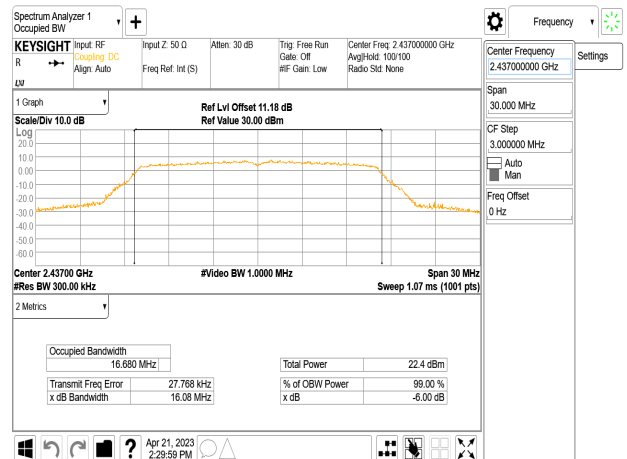

802.11b_20MHz_Chain0_2462MHz

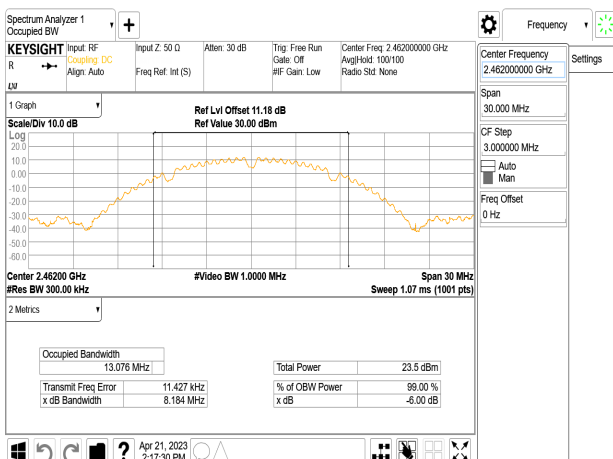

802.11g_20MHz_Chain0_2462MHz

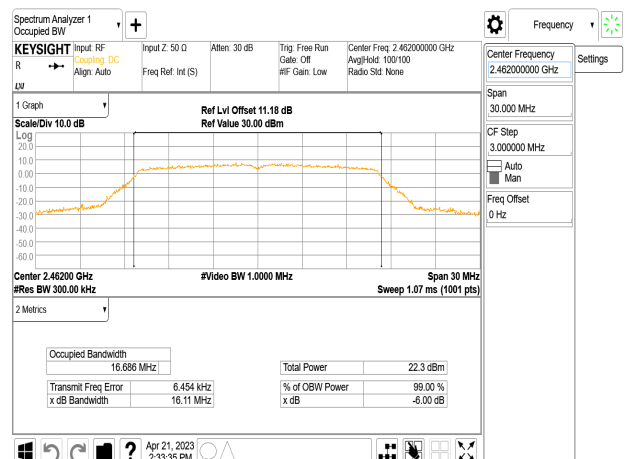

Unless otherwise stated the results shown in this test report refer only to the sample(s) tested and such sample(s) are retained for 90 days only.

除非另有說明，此報告結果僅對測試之樣品負責，同時此樣品僅保留90天。本報告未經本公司書面許可，不可部份複製。

This document is issued by the Company subject to its General Conditions of Service printed overleaf, available on request or accessible at <http://www.sgs.com.tw/Terms-and-Conditions> and for electronic format documents, subject to Terms and Conditions for Electronic Documents at <http://www.sgs.com.tw/Terms-and-Conditions>. Attention is drawn to the limitation of liability, indemnification and jurisdiction issues defined therein. Any holder of this document is advised that information contained hereon reflects the Company's findings at the time of its intervention only and within the limits of Client's instructions, if any. The Company's sole responsibility is to its Client and this document does not exonerate parties to a transaction from exercising all their rights and obligations under the transaction documents. This document cannot be reproduced except in full, without prior written approval of the Company. Any unauthorized alteration, forgery or falsification of the content or appearance of this document is unlawful and offenders may be prosecuted to the fullest extent of the law.

802.11n_20MHz_Chain0_2412MHz

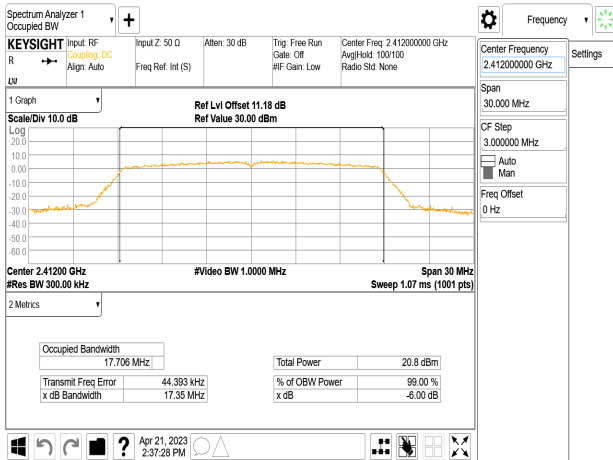

802.11n_40MHz_Chain0_2422MHz

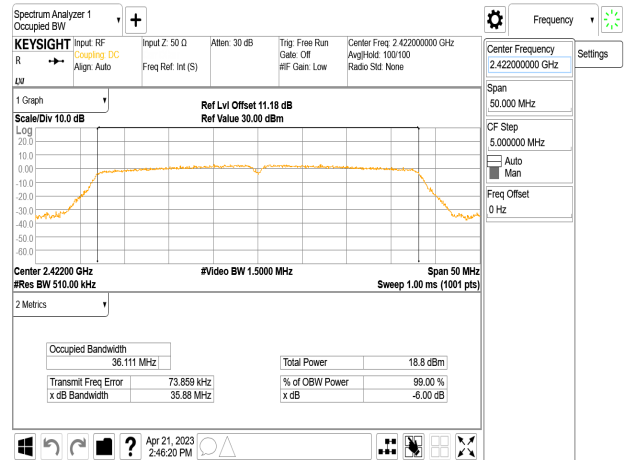

802.11n_20MHz_Chain0_2437MHz

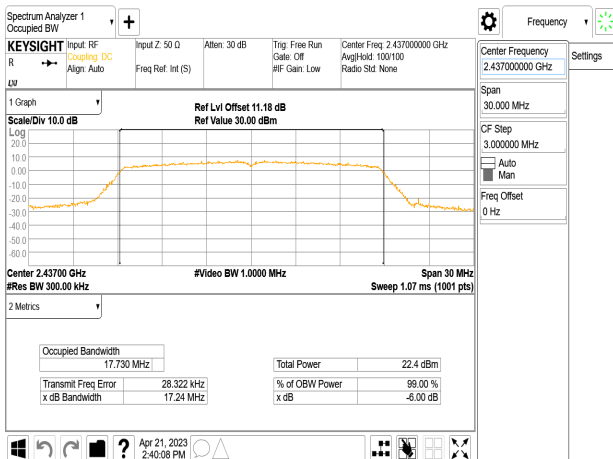

802.11n_40MHz_Chain0_2437MHz

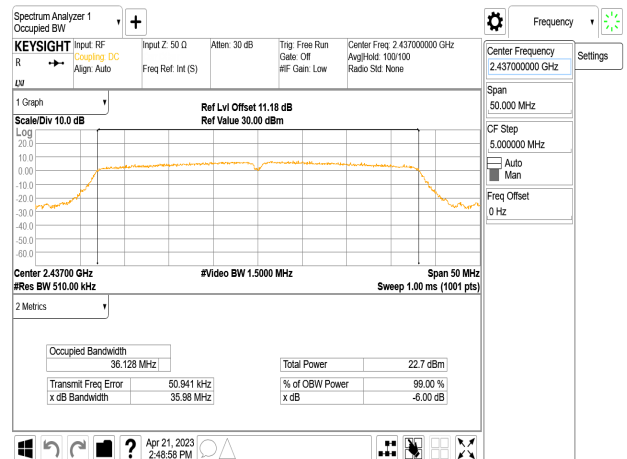

802.11n_20MHz_Chain0_2462MHz

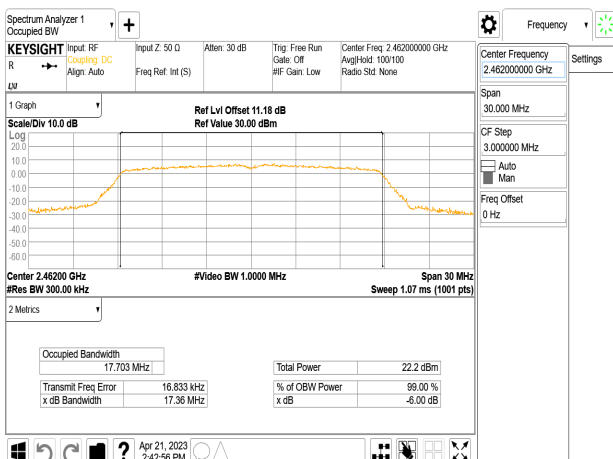

802.11n_40MHz_Chain0_2452MHz

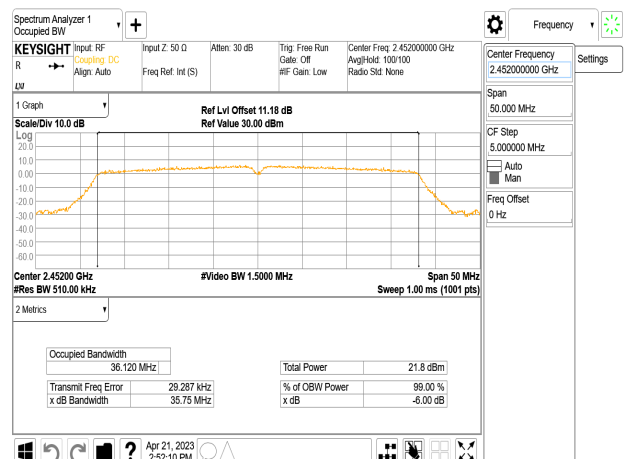

Unless otherwise stated the results shown in this test report refer only to the sample(s) tested and such sample(s) are retained for 90 days only.

除非另有說明，此報告結果僅對測試之樣品負責，同時此樣品僅保留90天。本報告未經本公司書面許可，不可部份複製。

This document is issued by the Company subject to its General Conditions of Service printed overleaf, available on request at <http://www.sgs.com.tw/Terms-and-Conditions> and for electronic format documents, subject to Terms and Conditions for Electronic Documents at <http://www.sgs.com.tw/Terms-and-Conditions>. Attention is drawn to the limitation of liability, indemnification and jurisdiction issues defined therein. Any holder of this document is advised that information contained hereon reflects the Company's findings at the time of its intervention only and within the limits of Client's instructions, if any. The Company's sole responsibility is to its Client and this document does not exonerate parties to a transaction from exercising all their rights and obligations under the transaction documents. This document cannot be reproduced except in full, without prior written approval of the Company. Any unauthorized alteration, forgery or falsification of the content or appearance of this document is unlawful and offenders may be prosecuted to the fullest extent of the law.

10 CONDUCTED BAND EDGES AND SPURIOUS EMISSION MEASUREMENT

10.1 Standard Applicable

In any 100 kHz bandwidth outside the frequency band in which the spread spectrum or digitally modulated intentional radiator is operating, the radio frequency power that is produced by the intentional radiator shall be at least 20 dB below that in the 100 kHz bandwidth within the band that contains the highest level of the desired power, based on either an RF conducted or a radiated measurement, provided the transmitter demonstrates compliance with the peak conducted power limits.

In addition, radiated emissions which fall in the restricted bands, as defined in §15.205(a) & RSS-Gen §8.10, must also comply with the radiated emission limits specified in §15.209(a) & RSS-Gen §8.9.

10.2 Test Setup

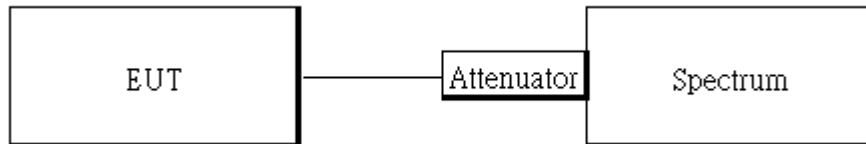

10.3 Measurement Procedure

10.3.1 Reference Level of Emission Limit:

1. Set analyzer center frequency to DTS channel center frequency.
2. The testing follows the Measurement Procedure of FCC KDB 558074 D01 DTS Meas. Guidance .
3. Set the span to 1.5 times the DTS channel bandwidth.
4. Set the RBW = 100kHz & VBW = 300 kHz.
5. Detector = peak.
6. Sweep time = auto couple.
7. Trace mode = max hold.
8. Allow trace to fully stabilize.
9. Use the peak marker function to determine the maximum amplitude level.

Unless otherwise stated the results shown in this test report refer only to the sample(s) tested and such sample(s) are retained for 90 days only.
除非另有說明，此報告結果僅對測試之樣品負責，同時此樣品僅保留90天。本報告未經本公司書面許可，不可部份複製。

This document is issued by the Company subject to its General Conditions of Service printed overleaf, available on request or accessible at <http://www.sgs.com.tw/Terms-and-Conditions> and for electronic format documents, subject to Terms and Conditions for Electronic Documents at <http://www.sgs.com.tw/Terms-and-Conditions>. Attention is drawn to the limitation of liability, indemnification and jurisdiction issues defined therein. Any holder of this document is advised that information contained hereon reflects the Company's findings at the time of its intervention only and within the limits of Client's instructions, if any. The Company's sole responsibility is to its Client and this document does not exonerate parties to a transaction from exercising all their rights and obligations under the transaction documents. This document cannot be reproduced except in full, without prior written approval of the Company. Any unauthorized alteration, forgery or falsification of the content or appearance of this document is unlawful and offenders may be prosecuted to the fullest extent of the law.

10.3.2 Conducted Band Edge:

1. To connect Antenna Port of EUT to Spectrum.
2. The testing follows the Measurement Procedure of FCC KDB 558074 D01 DTS Meas. Guidance .
3. Remove the antenna from the EUT and then connect a low loss RF cable from the antenna port to the spectrum analyzer.
4. Set start to edge frequency, and stop frequency of spectrum analyzer so as to encompass the spectrum to be examined.
5. Set the spectrum analyzer as RBW=100 kHz, VBW=300 kHz, Detector = Peak, Sweep = auto
6. Mark the highest reading of the emission as the reference level measurement.
7. Set DL as the limit = reading on marker of reference level measurement – 20dBm
8. Mark the highest readings of the emissions outside of 2400MHz~2483.5MHz.
9. Repeat above procedures until all default test channel (low, middle, and high) was complete.

Conducted Spurious Emission:

1. To connect Antenna Port of EUT to Spectrum
2. The testing follows the Measurement Procedure of FCC KDB 558074 D01 DTS Meas. Guidance .
3. Set RBW = 100 kHz & VBW= 300 kHz, Detector =Peak, Sweep = Auto.
4. Allow trace to fully stabilize.
5. Use the peak marker function to determine the maximum power level in any 100 kHz band segment within the fundamental EBW.
6. Repeat above procedures until all default test channel measured were complete.

Unless otherwise stated the results shown in this test report refer only to the sample(s) tested and such sample(s) are retained for 90 days only.
除非另有說明，此報告結果僅對測試之樣品負責，同時此樣品僅保留90天。本報告未經本公司書面許可，不可部份複製。

This document is issued by the Company subject to its General Conditions of Service printed overleaf, available on request or accessible at <http://www.sgs.com.tw/Terms-and-Conditions> and for electronic format documents, subject to Terms and Conditions for Electronic Documents at <http://www.sgs.com.tw/Terms-and-Conditions>. Attention is drawn to the limitation of liability, indemnification and jurisdiction issues defined therein. Any holder of this document is advised that information contained hereon reflects the Company's findings at the time of its intervention only and within the limits of Client's instructions, if any. The Company's sole responsibility is to its Client and this document does not exonerate parties to a transaction from exercising all their rights and obligations under the transaction documents. This document cannot be reproduced except in full, without prior written approval of the Company. Any unauthorized alteration, forgery or falsification of the content or appearance of this document is unlawful and offenders may be prosecuted to the fullest extent of the law.

10.4 Measurement Result

802.11b Ch0

Reference Level of Limit		
Freq. (MHz)	PSD (dBm)	Reference Level of Limit (dBm)
2412	12.26	-7.74
2437	12.11	-7.89
2462	12.12	-7.88

802.11g Ch0

Reference Level of Limit 802.11g mode		
Freq. (MHz)	PSD (dBm)	Reference Level of Limit (dBm)
2412	4.44	-15.56
2437	5.46	-14.54
2462	5.15	-14.85

802.11n_HT_20M Ch0

Reference Level of Limit 802.11n20 MODE		
Freq. (MHz)	PSD (dBm)	Reference Level of Limit (dBm)
2412	3.98	-16.02
2437	5.65	-14.35
2462	5.37	-14.63

802.11n_HT_40M Ch0

Reference Level of Limit 802.11n40 MODE		
Freq. (MHz)	PSD (dBm)	Reference Level of Limit (dBm)
2422	-1.17	-21.17
2437	2.66	-17.34
2452	1.87	-18.13

Unless otherwise stated the results shown in this test report refer only to the sample(s) tested and such sample(s) are retained for 90 days only.

除非另有說明，此報告結果僅對測試之樣品負責，同時此樣品僅保留90天。本報告未經本公司書面許可，不可部份複製。

This document is issued by the Company subject to its General Conditions of Service printed overleaf, available on request or accessible at <http://www.sgs.com.tw/Terms-and-Conditions> and for electronic format documents, subject to Terms and Conditions for Electronic Documents at <http://www.sgs.com.tw/Terms-and-Conditions>. Attention is drawn to the limitation of liability, indemnification and jurisdiction issues defined therein. Any holder of this document is advised that information contained hereon reflects the Company's findings at the time of its intervention only and within the limits of Client's instructions, if any. The Company's sole responsibility is to its Client and this document does not exonerate parties to a transaction from exercising all their rights and obligations under the transaction documents. This document cannot be reproduced except in full, without prior written approval of the Company. Any unauthorized alteration, forgery or falsification of the content or appearance of this document is unlawful and offenders may be prosecuted to the fullest extent of the law.

802.11b_20MHz_Chain0_2412MHz

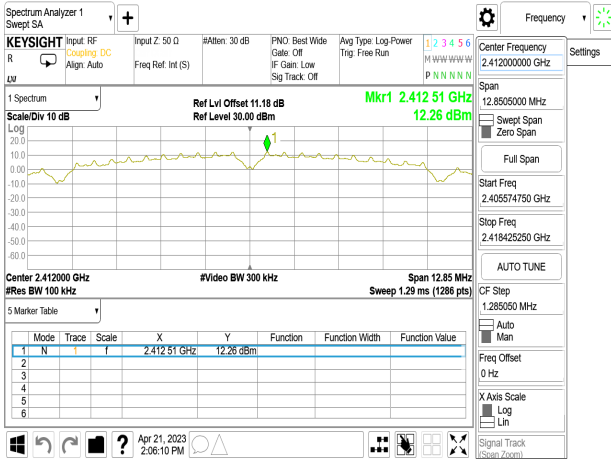

802.11g_20MHz_Chain0_2412MHz



802.11b_20MHz_Chain0_2437MHz

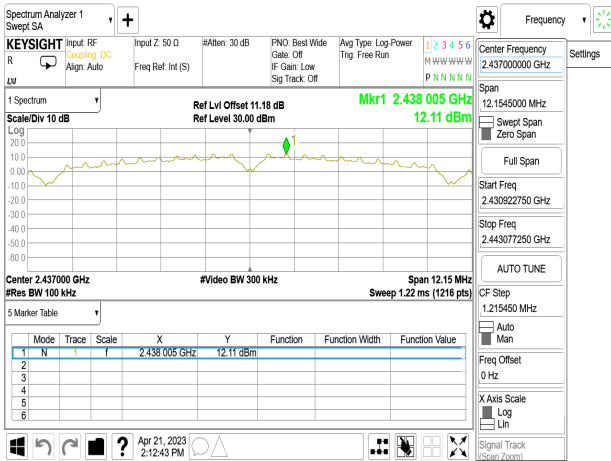

802.11g_20MHz_Chain0_2437MHz

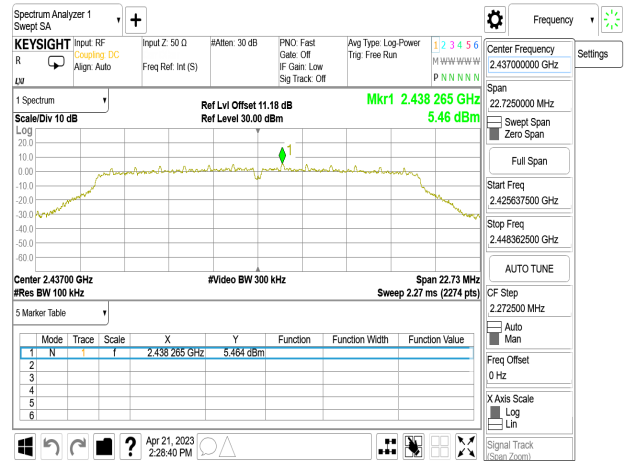

802.11b_20MHz_Chain0_2462MHz



802.11g_20MHz_Chain0_2462MHz

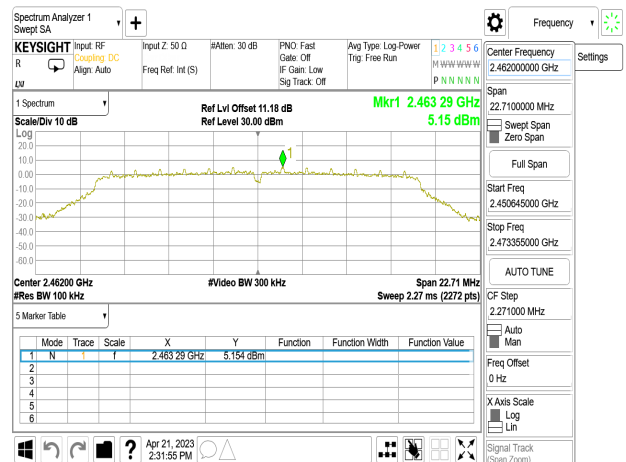

Unless otherwise stated the results shown in this test report refer only to the sample(s) tested and such sample(s) are retained for 90 days only.

除非另有說明，此報告結果僅對測試之樣品負責，同時此樣品僅保留90天。本報告未經本公司書面許可，不可部份複製。

This document is issued by the Company subject to its General Conditions of Service printed overleaf, available on request or accessible at <http://www.sgs.com.tw/Terms-and-Conditions> and for electronic format documents, subject to Terms and Conditions for Electronic Documents at <http://www.sgs.com.tw/Terms-and-Conditions>. Attention is drawn to the limitation of liability, indemnification and jurisdiction issues defined therein. Any holder of this document is advised that information contained hereon reflects the Company's findings at the time of its intervention only and within the limits of Client's instructions, if any. The Company's sole responsibility is to its Client and this document does not exonerate parties to a transaction from exercising all their rights and obligations under the transaction documents. This document cannot be reproduced except in full, without prior written approval of the Company. Any unauthorized alteration, forgery or falsification of the content or appearance of this document is unlawful and offenders may be prosecuted to the fullest extent of the law.

802.11n_20MHz_Chain0_2412MHz



802.11n_40MHz_Chain0_2422MHz

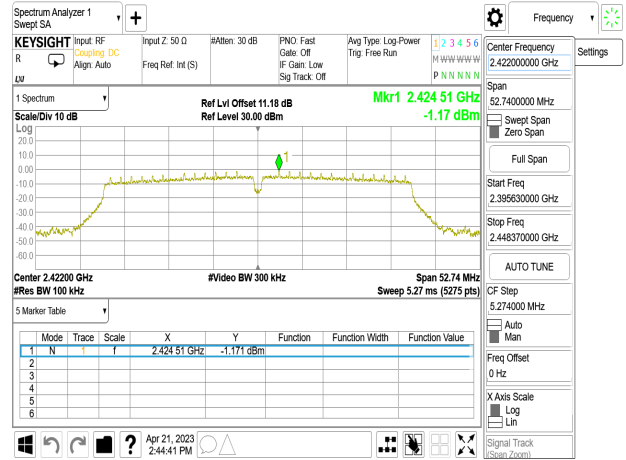

802.11n_20MHz_Chain0_2437MHz

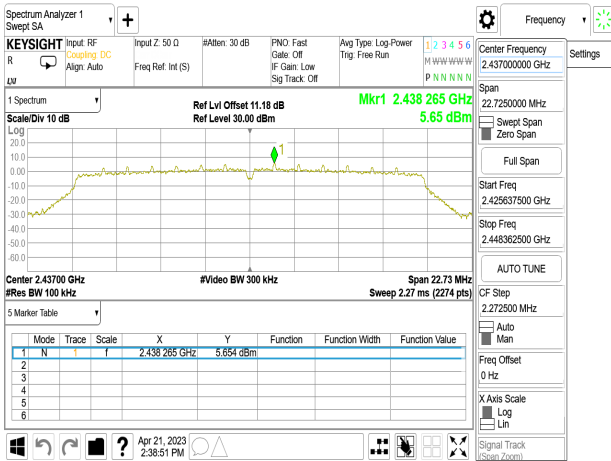

802.11n_40MHz_Chain0_2437MHz

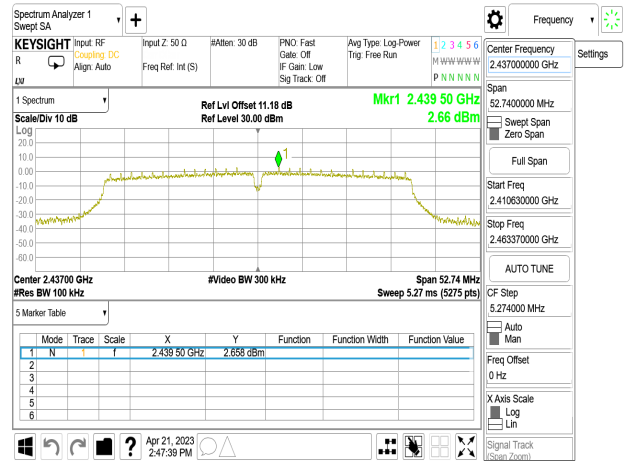

802.11n_20MHz_Chain0_2462MHz



802.11n_40MHz_Chain0_2452MHz

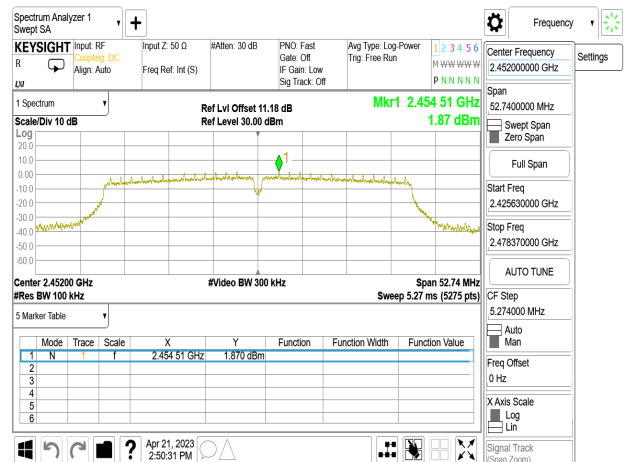

Unless otherwise stated, the results shown in this test report refer only to the sample(s) tested and such sample(s) are retained for 90 days only.

除非另有說明，此報告結果僅對測試之樣品負責，同時此樣品僅保留90天。本報告未經本公司書面許可，不可部份複製。

This document is issued by the Company subject to its General Conditions of Service printed overleaf, available on request or accessible at <http://www.sgs.com.tw/Terms-and-Conditions> and for electronic format documents, subject to Terms and Conditions for Electronic Documents at <http://www.sgs.com.tw/Terms-and-Conditions>. Attention is drawn to the limitation of liability, indemnification and jurisdiction issues defined therein. Any holder of this document is advised that information contained hereon reflects the Company's findings at the time of its intervention only and within the limits of Client's instructions, if any. The Company's sole responsibility is to its Client and this document does not exonerate parties to a transaction from exercising all their rights and obligations under the transaction documents. This document cannot be reproduced except in full, without prior written approval of the Company. Any unauthorized alteration, forgery or falsification of the content or appearance of this document is unlawful and offenders may be prosecuted to the fullest extent of the law.

802.11b_20MHz_Chain0_2412MHz



802.11g_20MHz_Chain0_2462MHz

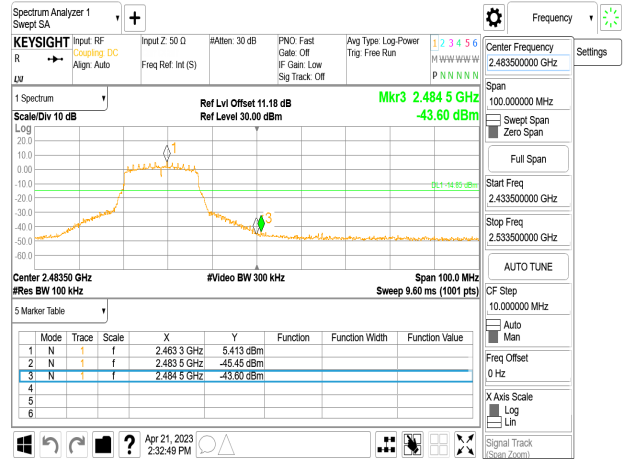

802.11b_20MHz_Chain0_2462MHz



802.11n_20MHz_Chain0_2412MHz

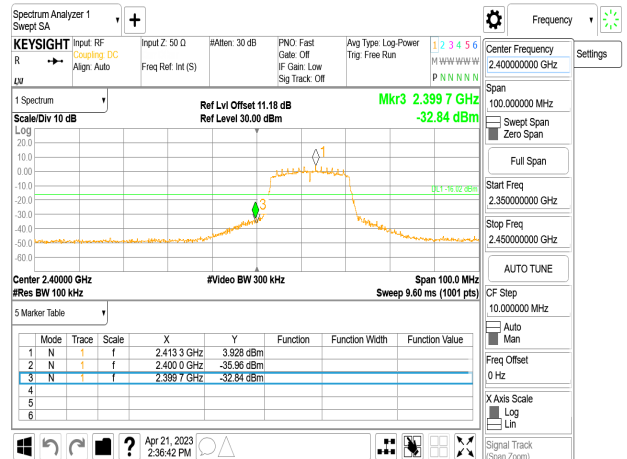

802.11g_20MHz_Chain0_2412MHz

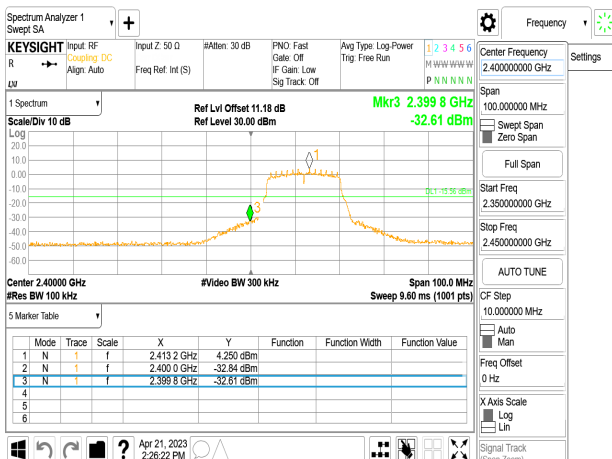

802.11n_20MHz_Chain0_2462MHz

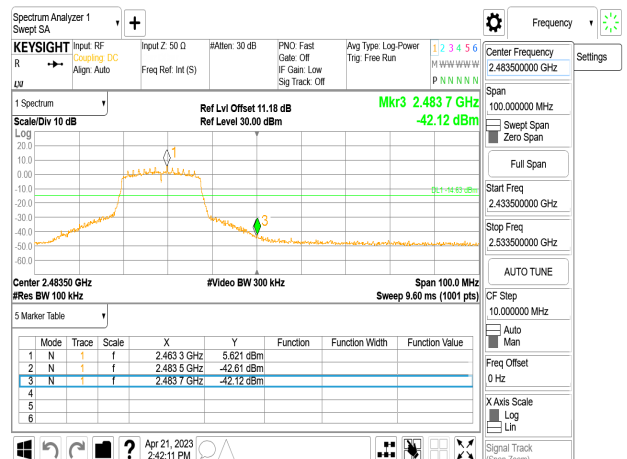

Unless otherwise stated the results shown in this test report refer only to the sample(s) tested and such sample(s) are retained for 90 days only.

除非另有說明，此報告結果僅對測試之樣品負責，同時此樣品僅保留90天。本報告未經本公司書面許可，不可部份複製。

This document is issued by the Company subject to its General Conditions of Service printed overleaf, available on request or accessible at <http://www.sgs.com.tw/Terms-and-Conditions> and for electronic format documents, subject to Terms and Conditions for Electronic Documents at <http://www.sgs.com.tw/Terms-and-Conditions>. Attention is drawn to the limitation of liability, indemnification and jurisdiction issues defined therein. Any holder of this document is advised that information contained hereon reflects the Company's findings at the time of its intervention only and within the limits of Client's instructions, if any. The Company's sole responsibility is to its Client and this document does not exonerate parties to a transaction from exercising all their rights and obligations under the transaction documents. This document cannot be reproduced except in full, without prior written approval of the Company. Any unauthorized alteration, forgery or falsification of the content or appearance of this document is unlawful and offenders may be prosecuted to the fullest extent of the law.