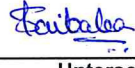

Produkte
Products

Prüfbericht - Nr.: Appendix 10		Seite 1 von 129			
<i>Test Report No.:</i>		<i>Page 1 of 129</i>			
Auftraggeber: <i>Client:</i>	HANDHELD GROUP AB Kinnegatan 17 A 531 33 Lidköping Sweden Tel: +46 (0) 510-54 71 70				
Gegenstand der Prüfung: <i>Test item:</i>	Rugged 7" Tablet				
Bezeichnung: <i>Identification:</i>	118207	Serien-Nr.: <i>Serial No.</i>	Engineering Sample		
Wareneingangs-Nr.: <i>Receipt No.:</i>	1803156247	Eingangsdatum: <i>Date of receipt:</i>	20.07.2016		
Prüfort: <i>Testing location:</i>	Refer Page 4 of 129 for test facilities				
Prüfgrundlage: <i>Test specification:</i>	IEEE Std 1528-2013 & IEC 62209-1 :2005, IEC 62209-2: 2010 , RSS 102 Issue 5				
Prüfergebnis: <i>Test Result:</i>	Siehe Testergebnis Zusammenfassung <i>See test result summary</i>				
Prüflaboratorium: <i>Testing Laboratory:</i>	TÜV Rheinland (India) Pvt. Ltd. TÜV Rheinland India Pvt Ltd. 82/A, West Wing, 3rd Main Road Electronic Cit Phase 1, Bangalore – 560100 FCC Registration No.: 176555 & IC OATS Reg. Number.: 3466E				
geprüft / tested by:		kontrolliert / reviewed by:			
07.03.2017	Shrikanth S Naik Sr. Engineer		15.03.2017	Saibaba Siddapur Assistant Manager	
Datum <i>Date</i>	Name/Stellung <i>Name/Position</i>	Unterschrift <i>Signature</i>	Datum <i>Date</i>	Name/Stellung <i>Name/Position</i>	Unterschrift <i>Signature</i>
Sonstiges / Other Aspects:		FCC ID: YY3-118207 & IC: 11695A-118207			
Abkürzungen:	<i>P(ass) = entspricht Prüfgrundlage</i> <i>F(ail) = entspricht nicht Prüfgrundlage</i> <i>N/A = nicht anwendbar</i> <i>N/T = nicht getestet</i>	Abbreviations:	<i>P(ass) = passed</i> <i>F(ail) = failed</i> <i>N/A = not applicable</i> <i>N/T = not tested</i>		
<p>Dieser Prüfbericht bezieht sich nur auf das o.g. Prüfmuster und darf ohne Genehmigung der Prüfstelle nicht auszugsweise vervielfältigt werden. Dieser Bericht berechtigt nicht zur Verwendung eines Prüfzeichens.</p> <p><i>This test report relates to the a. m. test sample. Without permission of the test center this test report is not permitted to be duplicated in extracts. This test report does not entitle to carry any safety mark on this or similar products.</i></p>					

TÜV Rheinland India Pvt. Ltd. 82/A, 3rd Main, West Wing Electronic City Phase 1, Hosur Road, Bangalore-560100, India
 Tel.: +9180 6723 3500 · Fax: +9180 6723 3542 · Web: www.tuv.com

Test Result Summary:

Band		Measured 1g SAR (W/kg)	Reported 1g SAR (W/kg)	Limit (W/Kg)	Result
GSM850	Body	0.17	0.19	1.6	Pass
	Head	0.43	0.47	1.6	Pass
PCS1900	Body	0.14	0.15	1.6	Pass
	Head	0.51	0.55	1.6	Pass
WCDMA Band 2	Head	1.19	1.39	1.6	Pass
	Body	0.60	0.69	1.6	Pass
WCDMA Band 4	Head	1.1	1.26	1.6	Pass
	Body	0.64	0.71	1.6	Pass
WCDMA Band 5	Head	0.66	0.73	1.6	Pass
	Body	0.384	0.42	1.6	Pass
Wi-Fi	Body	0.30	0.33	1.6	Pass
Wi-Fi	Head	0.43	0.48	1.6	Pass
Bluetooth	Body	0.01	0.01	1.6	Pass
LTE Band 2	Body	0.37	0.41	1.6	Pass
LTE Band 4	Body	0.45	0.59	1.6	Pass
LTE Band 5	Body	0.305	0.35	1.6	Pass
LTE F Band 17	Body	0.25	0.29	1.6	Pass
LTE Band 13	Body	0.34	0.36	1.6	Pass

Note:

It is declared in the user manual that a separation distance of 10mm shall be maintained from the Human body in the normal use. Hence, separation distance of 10mm is considered for Body SAR measurements in this test report.

www.tuv.com

Content

List of Test and Measurement Instruments	4
General Product Information	5
Product Function and Intended Use	5
Ratings and System Details.....	5
Test Set-up and Operation Mode	6
Principle of Configuration Selection.....	6
Test Operation and Test Software	6
Special Accessories and Auxiliary Equipment.....	6
Test Results.....	7
1. SAR Limits.....	7
2. Tissue simulating liquid dielectric parameters	9
3. System Validation	12
4. Specific Absorption rate of EUT.....	38

List of Test and Measurement Instruments

Equipment	Type	Serial Number	Periodicity	Calibration Due Date
E-Filed Probe EX3DV4	SP-EX3 004 CC	7435	Yearly	26.09.2017
DAE 4	SD 000 D04 BM	1320	Yearly	09.05.2017
RF and microwave Signal Generator	SMB100A	108788	Yearly	01.12.2017
Power Sensor	E4412A	MY50360055	Yearly	29.11.2017
Power Meter	N1913A	MY50000459	Yearly	30.11.2017
Dielectric Probe	DAK-3.5	1100	Yearly	04.12.2017
Dipole D835V2	SA AAD 083 BB	1017	Yearly	14.09.2017
Dipole D1750V2	SA AAD 175 AA	1066	Yearly	14.09.2017
Dipole D1950V3	SA AAD 195 BA	5D157	Yearly	14.09.2017
Dipole D2450V2	SA AAD 245 BB	889	Yearly	14.09.2017

Testing Facilities

BNNSPEAG
11/11 Sector III, Rajindra Nagar
Sahibabad - 201005
Distt. Ghaziabad, Uttar Pradesh, INDIA
Tel : +91 120 4281067
Fax : +91 120 4562656

www.tuv.com

General Product Information

Product Function and Intended Use

The Algiz RT7 is a rugged tablet, designed for use by field personnel in demanding conditions. It integrates best-in-class connectivity with efficient computing and multimedia features. The tablet runs Android Lollipop (5.1.1) operating system, and comes pre-installed with many Google applications, including Google Play.

Ratings and System Details

Operating Bands	GSM: 850MHz ,1900MHz WCDMA :Band 2, Band 4, Band 5; Wi-Fi: 2.4GHz; Bluetooth: 2.4GHz; LTE: Band 2, Band 4, Band 5, Band 17, Band 13;
Antenna Type	Integral Antenna
Number of antenna – License free Band	Primary Antenna – One
Number of antenna – License Band	Primary Antenna – One Diversity Antenna - One (For Receiver Only)
Antenna Gain	0 dBi
Supply Voltage	Internal Battery Pack -> 3.7- 4.2 VDC & Adaptor 5VDC to EUT
Dimensions	216.1 mm x 132.3 mm x 23.8 mm (including the shock bumpers)
Environmental	Environmental conditions are -20°C to +50 °C operating and -40°C to 70°C storage

www.tuv.com

Test Set-up and Operation Mode

Principle of Configuration Selection

Continuous transmission was enabled on lowest, middle and highest operating channel at each supporting frequency band at maximum defined power level & for License bands, Transmission was enabled with help of CMW500 on low, mid and high channel.

Test Operation and Test Software

Wi-Fi: QRCT test software (from QUALCOMM) was used to enable continuous transmission, channel selection (low/mid/high) and data rates on the EUT for the tests in this report & GSM/WCDMA/LTE: A base station simulator was used to enable channel, Band and Power level selection and continuous transmission.

Special Accessories and Auxiliary Equipment

- None

Note: Product Rugged 7" Tablet has multiple protocols. All the supported wireless protocols regulatory test results and their respective test report numbers are mentioned in the below table.

Radio Protocol	Report Number
NFC	19660243 001
Wi-Fi (IEEE 802.11bgn)	19660240 001
BLE	19660242 001
Bluetooth (BDR+EDR)	19660241 001
GSM	19660244 001
W-CDMA	19660245 001
LTE	19660246 001

www.tuv.com

Test Results

1. SAR Limits

The below standards are applied for SAR testing of this product under FCC regulations.

IEEE Std C95.3-2002: IEEE Standard for Safety Levels with Respect to Human Exposure to Radio Frequency Electromagnetic Fields, 3 kHz to 300 GHz, Inst. of Electrical and Electronics Engineers, Inc.

IEEE STD 1528-2013: Recommended Practice for Determining the Peak Spatial-Average Specific Absorption Rate (SAR) in the Human Body Due to Wireless Communications Devices: Experimental Techniques, Inst. of Electrical and Electronics Engineers, Inc.

KDB 865664 D01 SAR Measurement 100 MHz to 6 GHz v01r04: SAR Measurement Requirements for 100 MHz to 6 GHz

KDB 248227 D01 802.11 Wi-Fi SAR v02r02: SAR guidance for IEEE 802.11 (WI-FI) transmitters

447498 D01 General RF Exposure Guidance v06: RF Exposure Procedures and Equipment Authorization Policies for Mobile and Portable Devices

941225 D01 3G SAR Procedures v03r01: 3G SAR Measurement Procedures

941225 D05 SAR for LTE Devices v02r05: SAR Evaluation Considerations for LTE devices

Limits:

Body Region	Devices Used by the General Public SAR Limit (W/kg)
Localized Head and Trunk	1.6

Worst Case Measured Maximum Output Power as listed in Below Table

Radio Protocol	Channel / Frequency (MHz)	Measured Power (dBm)
Bluetooth	Low / 2402	9.11
	Mid / 2440	8.42
	High / 2480	7.21
Wi-Fi 2.4GHz b/g Mode	Low / 2412	13.48
	Mid / 2437	13.70
	High / 2462	12.90
GSM 850	Low / 824.2	30.62
	Mid / 836.6	30.74
	High / 848.8	31.42
PCS 1900	Low / 1850.2	27.39
	Mid / 1880	27.49
	High / 1909.8	27.47
W-CDMA FDD 2	Low / 1852.4	19.55
	Mid / 1880	20.21
	High / 1907.6	19.47
W-CDMA FDD 4	Low / 1712.4	17.98
	Mid / 1732.4	18.49
	High / 1752.6	20.14
W-CDMA FDD 5	Low / 826.4	19.19
	Mid / 836.6	19.09
	High / 846.6	20.57
LTE band 2	Low / 1860	21.42
	Mid / 1880	21.93
	High / 1900	21.74
LTE band 4	Low / 1712.5	21.37
	Mid / 1732.5	21.84
	High / 1752.5	21.52
LTE band 5	Low / 829	21.56
	Mid / 836.5	21.36
	High / 844	21.62
LTE band 17	Mid / 710	22.25
LTE band 13	Mid / 782	21.99

2. Tissue simulating liquid dielectric parameters

For the purpose of the tests as described in this report the following tissue dielectric parameters have been determined by use of a Vector Network Analyzer (VNA). The tables indicate the dielectric parameters of the liquids used during the tests. The indicated required values are derived from IEEE STD 1528-2013 & FCC KDB "865664 D01 SAR Measurement 100 MHz to 6 GHz v01r04"

Dielectric parameters for 850MHz Tissue

850MHz head and muscle simulant liquid was used for the tests for 850MHz band frequencies. The following liquid validation results were obtained, where the maximum deviation should not be more than 10 % of the Relative values (standard).

Results for 850 MHz Band

Date	Liquid	Frequency (MHz)	Measured Liquid Temperature (°C)	Measured relative Permittivity	Measured Conductivity (S/m)	Relative Permittivity Standard	Conductivity Standard (S/m)	Relative Permittivity Deviation (%)	Conductivity Deviation (%)
12.10.2016	HSL	850	22.68	40.85	0.96	41.50	0.92	-2	4
05.11.2016	HSL	850	21.6	40.85	0.96	41.50	0.92	-2	4
21.10.2016	MSL	850	21.9	55.38	0.94	55.10	0.99	1	5
22.10.2016	MSL	850	21.5	53.38	0.93	55.10	0.99	-3	-6
25.10.2016	MSL	850	20.30	55.46	0.95	55.10	0.99	1	4

Dielectric parameters for 1750MHz Tissue

1750 MHz head and muscle simulant liquid was used for the tests for 1750 MHz band frequencies. The following liquid validation results were obtained, where the maximum deviation should not be more than 10 % of the Relative values (standard).

Results for 1750 MHz Band

Date	Liquid	Frequency (MHz)	Measured Liquid Temperature (°C)	Measured relative Permittivity	Measured Conductivity (S/m)	Relative Permittivity Standard	Conductivity Standard (S/m)	Relative Permittivity Deviation (%)	Conductivity Deviation (%)
24.10.2016	MSL	1750	20.2	54.18	1.43	53.4	1.49	1	-4
25.10.2016	MSL	1750	20.3	54.42	1.39	53.4	1.49	2	-6
05.11.2016	HSL	1750	21.6	40.91	1.35	40.1	1.37	2	-1

www.tuv.com

Dielectric parameters for 1900 MHz Tissue

1900 MHz head and muscle simulant liquid was used for the tests for 1950 MHz band frequencies. The following liquid validation results were obtained, where the maximum deviation should not be more than 10 % of the Relative values (standard).

Results for 1950 MHz Band

Date	Liquid	Frequency (MHz)	Measured Liquid Temperature (°C)	Measured relative Permittivity	Measured Conductivity (S/m)	Relative Permittivity Standard	Conductivity Standard (S/m)	Relative Permittivity Deviation (%)	Conductivity Deviation (%)
17.10.2016	HSL	1900	21.6	38.82	1.46	40	1.4	-3	4
22.10.2016	MSL	1900	21.5	53.84	1.55	53.30	1.52	1	2
24.10.2016	MSL	1900	20.2	54.14	1.40	53.30	1.52	2	-4
25.10.2016	MSL	1900	20.3	53.97	1.47	53.30	1.52	1	-3
05.11.2016	HSL	1900	21.6	40.72	1.45	40.00	1.40	2	4

Dielectric parameters for 2450 MHz Tissue

2450 MHz head and muscle simulant liquid was used for the tests for 2450 MHz band frequencies. The following liquid validation results were obtained, where the maximum deviation should not be more than 10 % of the Relative values (standard).

Results for 2450 MHz Band

Date	Liquid	Frequency (MHz)	Measured Liquid Temperature (°C)	Measured relative Permittivity	Measured Conductivity (S/m)	Relative Permittivity Standard	Conductivity Standard (S/m)	Relative Permittivity Deviation (%)	Conductivity Deviation (%)
20.10.2016	HSL	2450	21.6	39.8	1.81	39.20	1.80	2	1
21.10.2016	MSL	2450	21.9	53.05	1.95	52.70	1.95	1	0
02.11.2016	MSL	2450	22.3	51.70	1.94	52.70	1.95	-2	-1

www.tuv.com

For LTE Band 17, 13 & Non-Barcode unit SAR measurement:

Broad band liquid HBBL 600-6000V6 & MBBL600-6000V6 are used.

Date	Liquid Type	Frequency (MHz)	Measured Liquid Temperature (°C)	Measured relative Permittivity	Measured Conductivity (S/m)	Relative Permittivity Standard	Conductivity Standard (S/m)	Relative Permittivity Deviation (%)	Conductivity Deviation (%)
16.01.2017	MSL	710	22.5	54.307	0.9516	55.687	0.96	-2.47	-0.87
01.02.2017	MSL	850	22.7	54.51	1.017	55.1538	0.988	-1.16	2.9
01.02.2017	MSL	1750	22.7	53.356	1.454	53.4316	1.488	-0.14	-2.28
01.02.2017	MSL	1900	22.7	53.505	1.532	53.30	1.52	0.38	0.78
01.02.2017	MSL	710	22.7	54.213	0.948	55.687	0.96	-2.65	-1.25
02.02.2017	MSL	850	22.6	54.42	1.01	55.1538	0.988	-1.33	2.23
02.02.2017	MSL	1750	22.6	53.52	1.42	53.4316	1.488	0.17	-4.57
02.02.2017	MSL	1900	22.6	53.825	1.526	53.30	1.52	0.98	0.39
03.02.2017	MSL	850	23.0	54.51	1.017	55.1538	0.988	-1.17	2.94
03.02.2017	MSL	1750	23.0	53.542	1.45	53.4316	1.488	0.21	-2.55
03.02.2017	MSL	1900	23.0	52.86	1.506	53.30	1.52	-0.83	-0.92
03.02.2017	MSL	2450	23.0	52.66	1.95	52.7	1.95	-0.08	0.00
06.02.2017	HSL	850	22.4	43.07	0.94	41.5	0.916	3.78	2.62
06.02.2017	HSL	1750	22.4	40.97	1.375	40.078	1.371	2.23	0.29
06.02.2017	HSL	1900	22.4	40.78	1.42	40.0	1.40	1.95	1.43
06.02.2017	HSL	2450	22.4	40.154	1.81	39.2	1.8	2.43	0.56
07.02.2017	HSL	850	22.8	42.98	0.91	41.5	0.916	3.57	-0.66
07.02.2017	HSL	1750	22.8	40.89	1.36	40.078	1.371	2.03	-0.80
07.02.2017	HSL	1900	22.8	39.98	1.39	40.0	1.40	-0.05	-0.71
07.02.2017	HSL	2450	22.8	40.17	1.85	39.2	1.8	2.47	2.78
06.03.2017	MSL	800	22.5	54.637	0.98	55.34	0.97	-1.26	1.29

3. System Validation

The purpose of the system performance check (system check) is to verify that the system operates within its specifications at the device test frequency. The system check is to make sure that the system works correctly at the time of the compliance test. The system check has been performed using the specified tissue-equivalent liquid and at a chosen fixed frequency that is within $\pm 10\%$ of the compliance test mid-band frequency. The system check is performed prior to compliance tests and the result must always be within $\pm 10\%$ of the target value corresponding to the test frequency, liquid and the source used. The system check detects possible short-term drift and uncertainties in the system, such as:

- a) Changes in the liquid parameters (e.g., due to water evaporation or temperature change),
- b) Test system component failures,
- c) Test system component drift,
- d) Operator errors in the set-up or software parameters,
- e) Other possible adverse conditions in the system configuration, e.g., RF interference.

The results show that this system check is within 10% of the expected values.

System check Setup

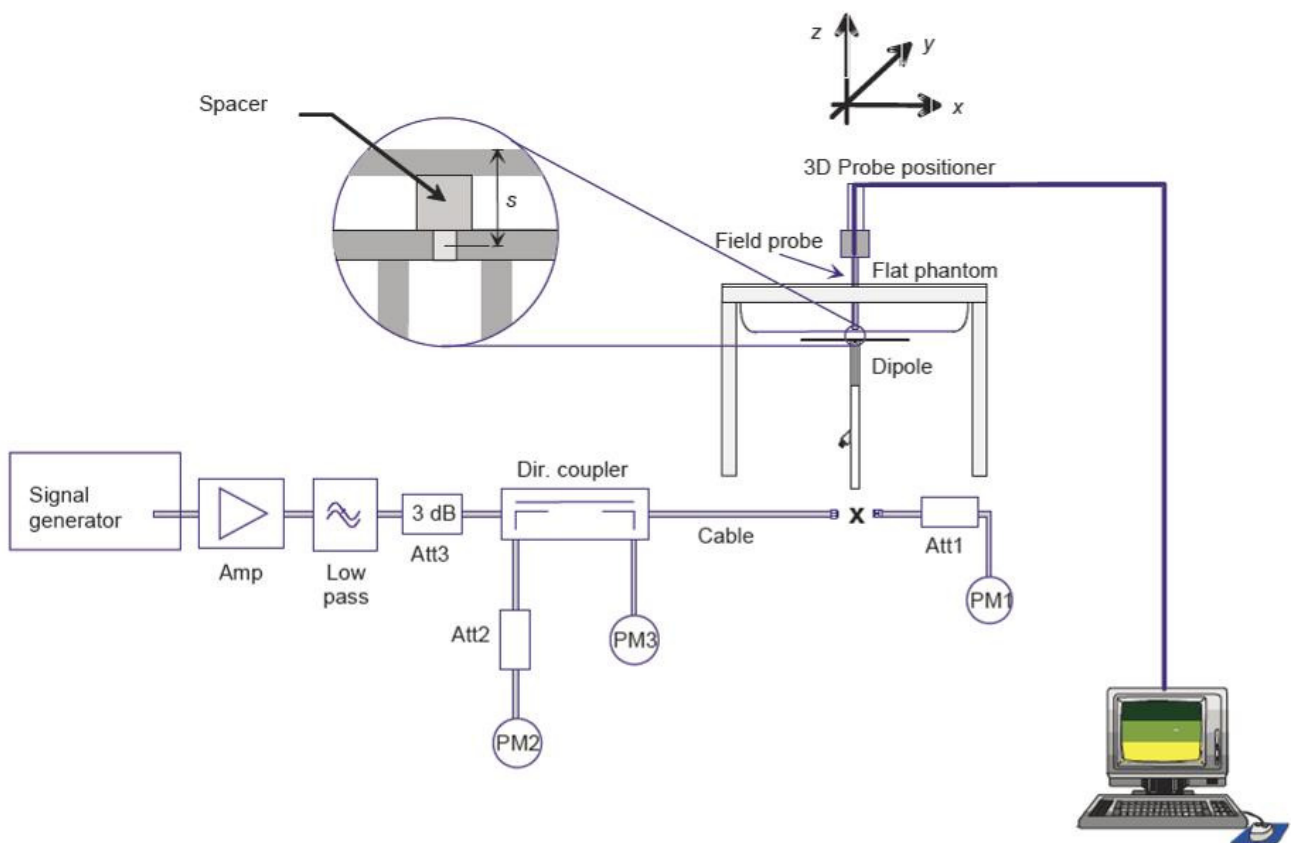

www.tuv.com

Results

At 850, 1750, 1900 and 2450 MHz a system check was executed according KDB 865664 D01. The following system performance check results were obtained (referenced to 1W):

Liquid Type	Date	Frequency	Target Value (W/kg)	Measured Value (W/kg)	Deviation from Target value (%)	Permissible deviation from target value (%)
HSL	12.10.2016	850	9.50	10.2	7.37	±10
	05.11.2016	850	9.50	10.3	8.42	±10
	05.11.2016	1750	36.8	37.2	1.09	±10
	17.10.2016	1900	39.7	41.5	4.53	±10
	05.11.2016	1900	39.7	42.8	7.81	±10
	20.10.2016	2450	51.7	52.4	1.35	±10
MSL	22.10.2016	850	9.91	10.2	2.93	±10
	24.10.2016	850	9.91	10.5	5.95	±10
	25.10.2016	850	9.91	10.2	2.93	±10
	25.10.2016	1750	36.5	36.9	1.10	±10
	24.10.2016	1750	36.5	38.1	4.38	±10
	25.10.2016	1900	39.7	40.0	0.76	±10
	24.10.2016	1900	39.7	40.0	0.76	±10
	22.10.2016	1900	39.7	42.5	7.05	±10
	21.10.2016	2450	52.7	54.9	4.17	±10
	02.11.2016	2450	52.7	50.0	-5.12	±10
HSL	06.02.2017	850	9.50	9.48	-0.21	±10
	06.02.2017	1750	36.8	35.0	-4.89	±10
	06.02.2017	1900	39.7	38.6	-2.77	±10
	06.02.2017	2450	51.7	52.4	1.35	±10
MSL	01.02.2017	850	9.91	9.14	-7.77	±10
	01.02.2017	1750	36.5	35.2	-3.56	±10
	01.02.2017	1900	39.7	41.4	4.28	±10
	01.02.2017	2450	52.7	52.6	-0.19	±10

www.tuv.com

Head Simulating Liquids:

System Validation - Band: 850 MHz

Temperature of Liquid	: 22.68 °C
Test Frequency	: 850MHz
Measured Conductivity	: 0.96 S/m
Measured Permittivity	: 40.85

Final Scan Results:

Power input to Dipole	: 100mW
Grid Dimension	: 8mmX8mmX7mm
Power Reference	: 41.22V/m
Measured SAR	: 1.02 W/kg
Normalized to 1W power	: 10.2 W/Kg
Power Drift	: 0.11 dB

Measurement Plot

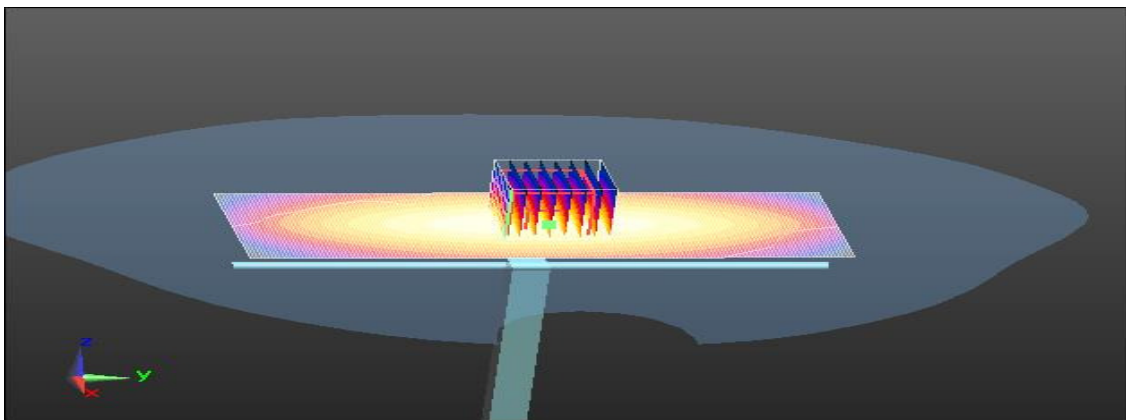

www.tuv.com

System Validation - Band: 850 MHz

Temperature of Liquid	: 21.6 °C
Test Frequency	: 850MHz
Measured Conductivity	: 0.963 S/m
Measured Permittivity	: 40.851

Final Scan Results:

Power input to Dipole	: 100mW
Grid Dimension	: 8mmX8mmX7mm
Power Reference	: 39.65V/m
Measured SAR	: 1.03 W/kg
Normalized to 1W power	: 10.3 W/Kg
Power Drift	: 0 dB

Measurement Plot

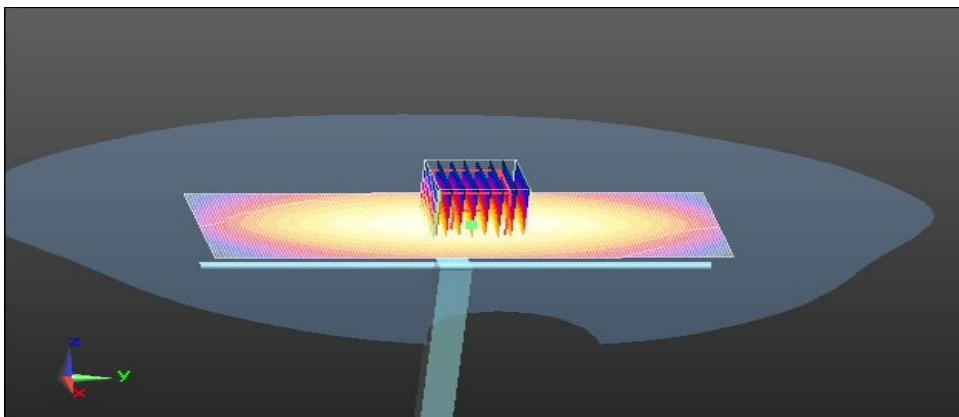

www.tuv.com

System Validation - Band: 1750 MHz

Temperature of Liquid	: 21.6 °C
Test Frequency	: 1750MHz
Measured Conductivity	: 1.43 S/m
Measured Permittivity	: 54.18

Final Scan Results:

Power input to Dipole	: 100mW
Grid Dimension	: 61mmX101mmX1mm
Power Reference	: 65.93V/m
Measured SAR	: 3.81 W/kg
Normalized to 1W power	: 38.1 W/Kg
Power Drift	: 0.07dB

Measurement Plot

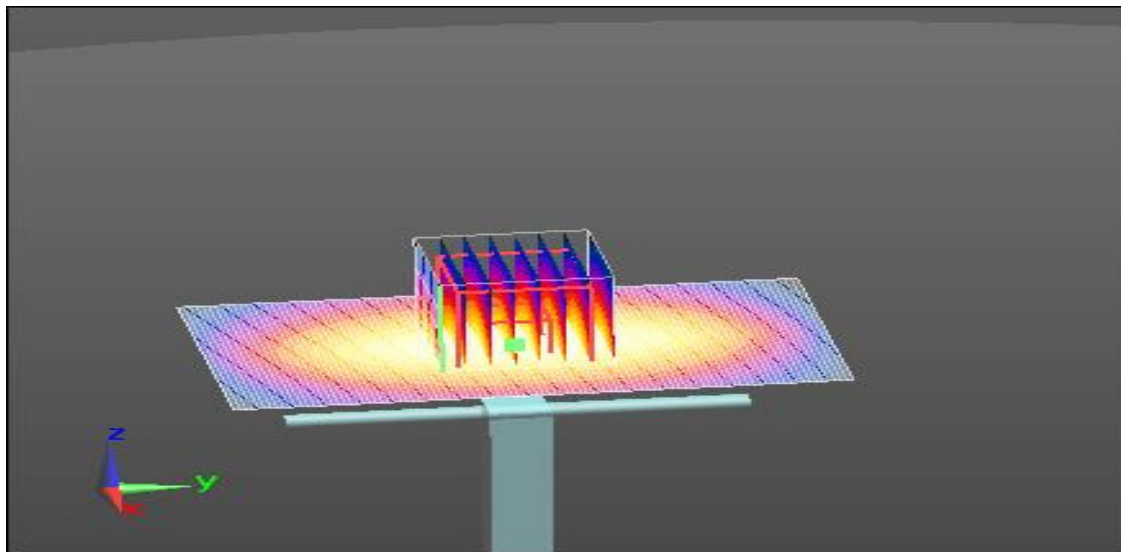

www.tuv.com

System Validation - Band: 1900 MHz

Temperature of Liquid	: 21.6 °C
Test Frequency	: 1900MHz
Measured Conductivity	: 1.455 S/m
Measured Permittivity	: 38.82

Final Scan Results:

Power input to Dipole	: 100mW
Grid Dimension	: 7mmX7mmX7mm
Power Reference	: 68.92V/m
Measured SAR	: 4.15 W/kg
Normalized to 1W power	: 41.5 W/Kg
Power Drift	: 0.04dB

Measurement Plot

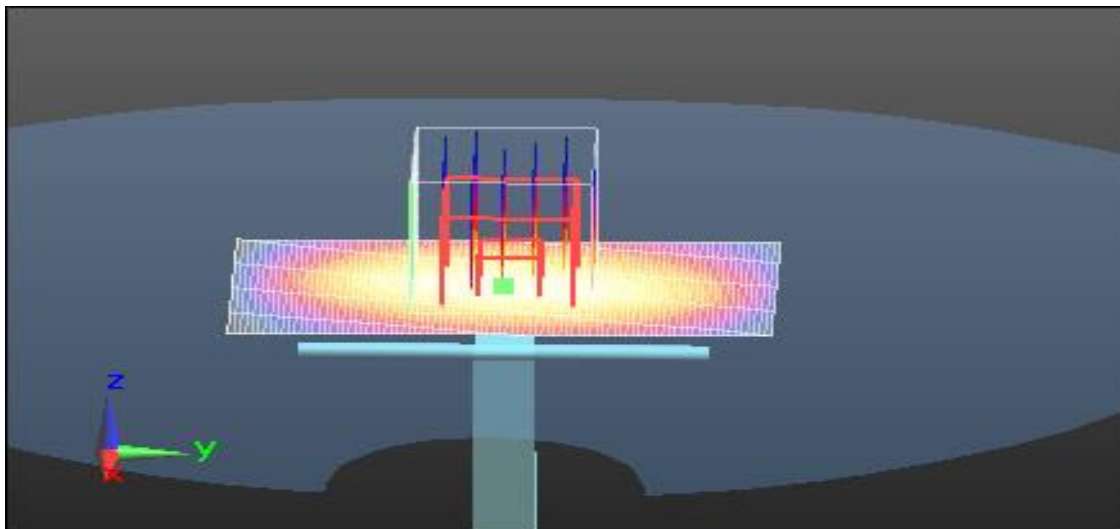

www.tuv.com

System Validation - Band: 1900 MHz

Temperature of Liquid	: 21.6 °C
Test Frequency	: 1900MHz
Measured Conductivity	: 1.446 S/m
Measured Permittivity	: 40.724

Final Scan Results:

Power input to Dipole	: 100mW
Grid Dimension	: 51mmX91mmX4mm
Power Reference	: 68.72V/m
Measured SAR	: 4.28 W/kg
Normalized to 1W power	: 42.8 W/Kg
Power Drift	: 0.03dB

Measurement Plot

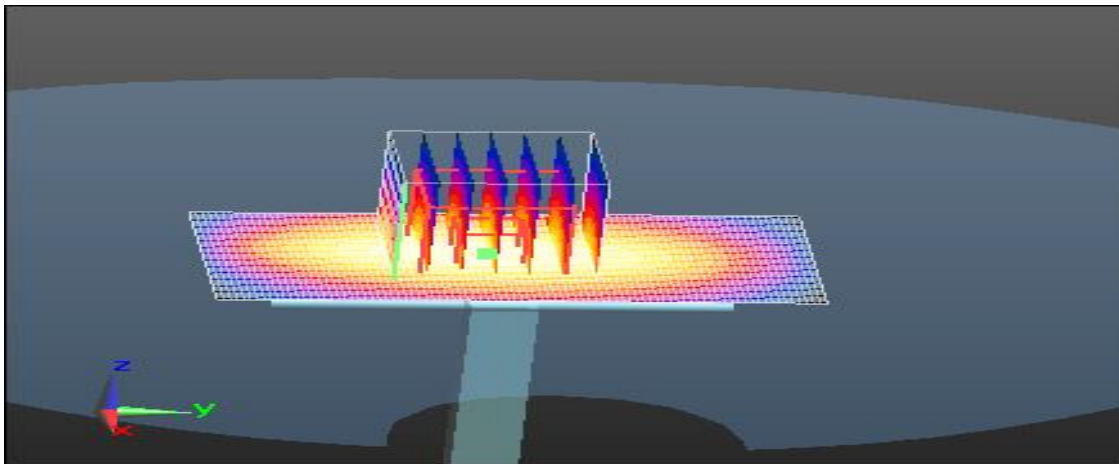

www.tuv.com

System Validation - Band: 2450 MHz

Temperature of Liquid	: 21.6 °C
Test Frequency	: 2450MHz
Measured Conductivity	: 1.81 S/m
Measured Permittivity	: 39.80

Final Scan Results:

Power input to Dipole	: 100mW
Grid Dimension	: 8mmX8mmX7mm
Power Reference	: 72.53V/m
Measured SAR	: 5.19 W/kg
Normalized to 1W power	: 51.9 W/Kg
Power Drift	: -0.15dB

Measurement Plot

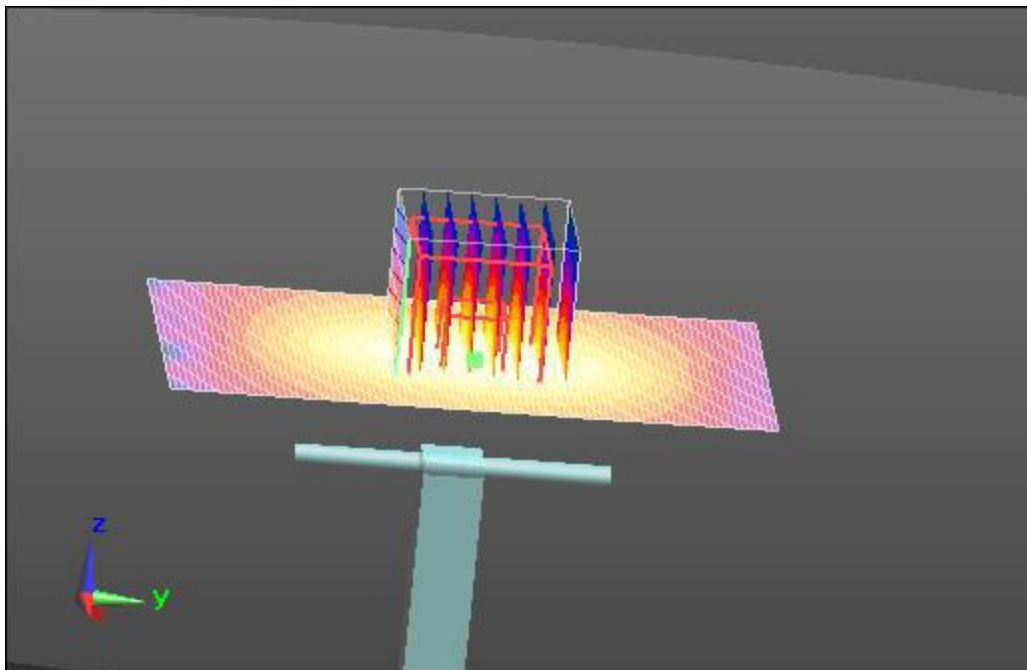

www.tuv.com

Muscle Simulating Liquids:

System Validation - Band: 850 MHz

Temperature of Liquid	: 21.5 °C
Test Frequency	: 850MHz
Measured Conductivity	: 0.93 S/m
Measured Permittivity	: 53.38

Final Scan Results:

Power input to Dipole	: 100mW
Grid Dimension	: 8mmX8mmX7mm
Power Reference	: 41.92V/m
Measured SAR	: 1.02 W/kg
Normalized to 1W power	: 10.2 W/Kg
Power Drift	: -0.15dB

Measurement Plot

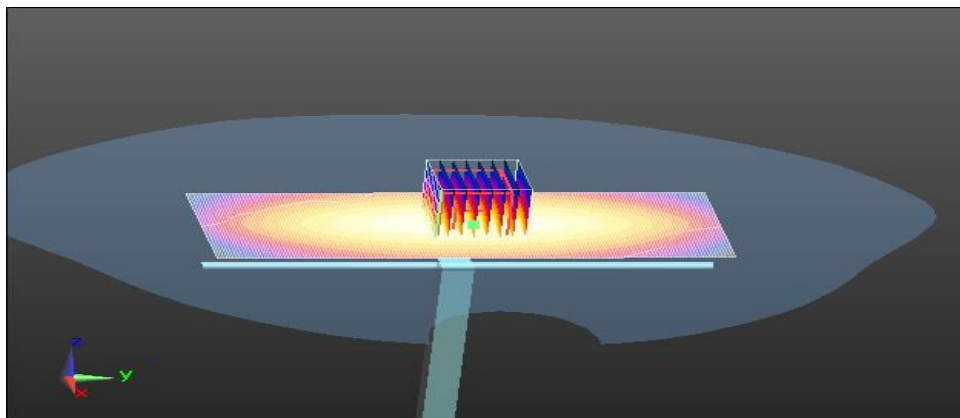

www.tuv.com

System Validation - Band: 850 MHz

Temperature of Liquid	: 21.9 °C
Test Frequency	: 850MHz
Measured Conductivity	: 0.94 S/m
Measured Permittivity	: 55.38

Final Scan Results:

Power input to Dipole	: 100mW
Grid Dimension	: 8mmX8mmX7mm
Power Reference	: 41.72V/m
Measured SAR	: 1.05 W/kg
Normalized to 1W power	: 10.5 W/Kg
Power Drift	: -0.13dB

Measurement Plot

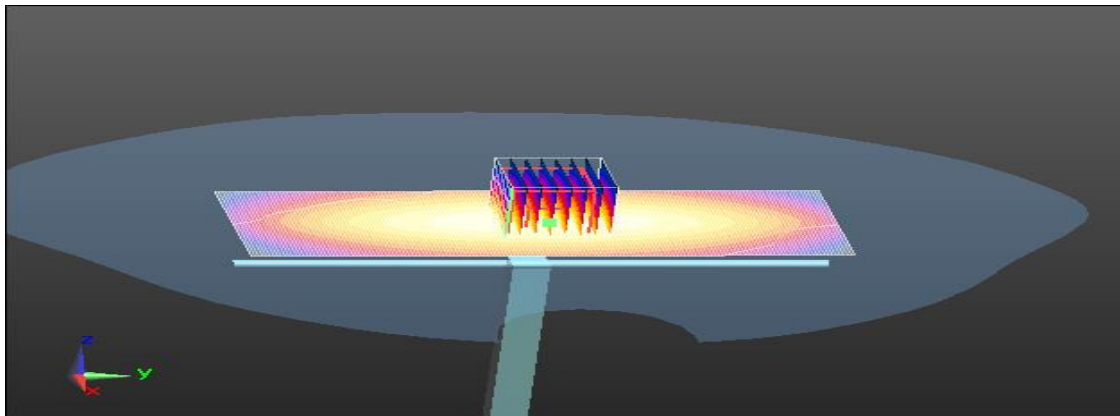

www.tuv.com

System Validation - Band: 850 MHz

Temperature of Liquid	: 20.3 °C
Test Frequency	: 850MHz
Measured Conductivity	: 0.950 S/m
Measured Permittivity	: 55.46

Final Scan Results:

Power input to Dipole	: 100mW
Grid Dimension	: 8mmX8mmX7mm
Power Reference	: 41.70V/m
Measured SAR	: 1.02 W/kg
Normalized to 1W power	: 10.2 W/Kg
Power Drift	: -0.12dB

Measurement Plot

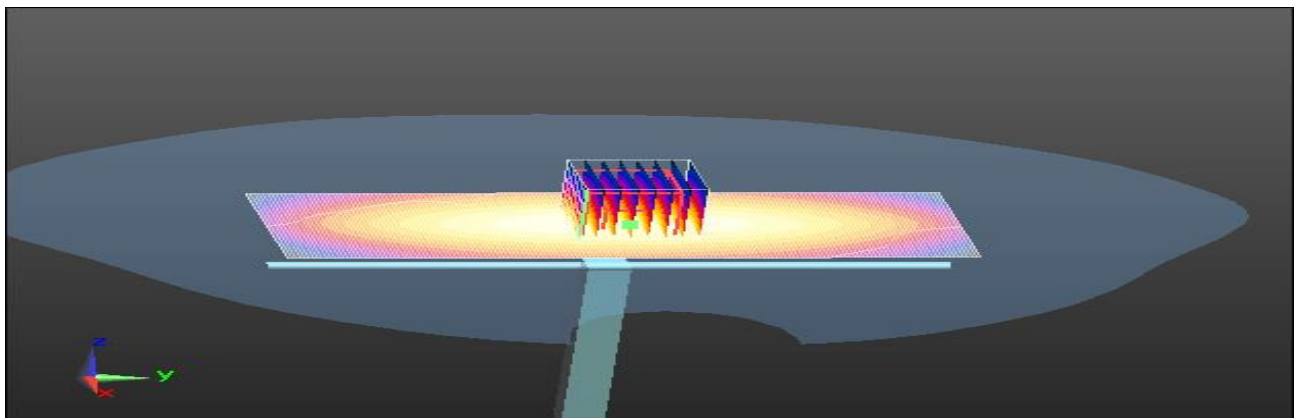

www.tuv.com

System Validation - Band: 1750 MHz

Temperature of Liquid	: 20.3 °C
Test Frequency	: 1750MHz
Measured Conductivity	: 1.39 S/m
Measured Permittivity	: 54.42

Final Scan Results:

Power input to Dipole	: 100mW
Grid Dimension	: 8mmX8mmX7mm
Power Reference	: 65.49 V/m
Measured SAR	: 3.69 W/kg
Normalized to 1W power	: 36.9 W/Kg
Power Drift	: -0.09dB

Measurement Plot

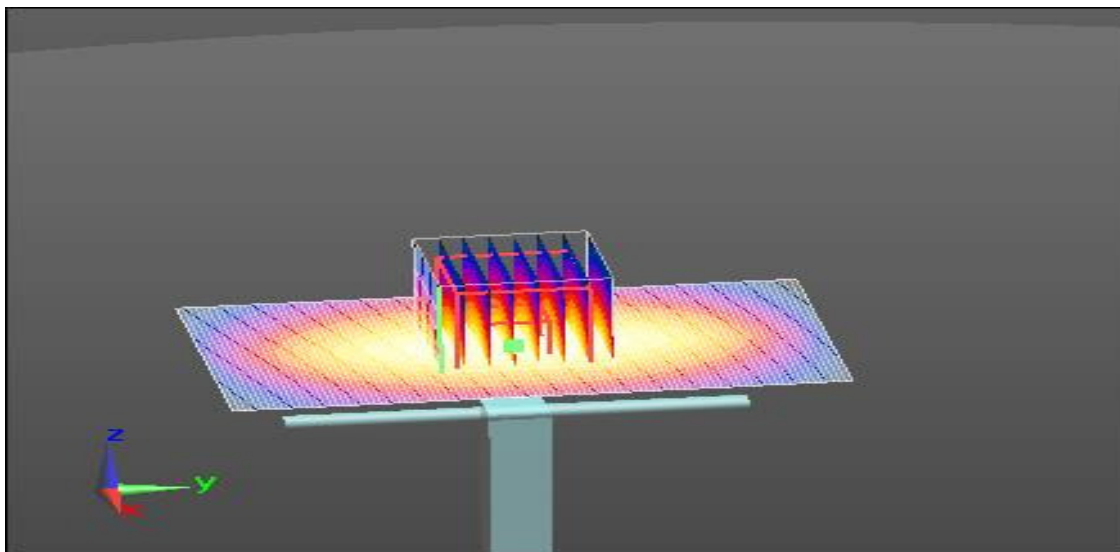

www.tuv.com

System Validation - Band: 1750 MHz

Temperature of Liquid	: 20.2 °C
Test Frequency	: 1750MHz
Measured Conductivity	: 1.43 S/m
Measured Permittivity	: 54.18

Final Scan Results:

Power input to Dipole	: 100mW
Grid Dimension	: 61mmX101mmX7mm
Power Reference	: 65.93 V/m
Measured SAR	: 3.81 W/kg
Normalized to 1W power	: 38.1 W/Kg
Power Drift	: -0.07dB

Measurement Plot

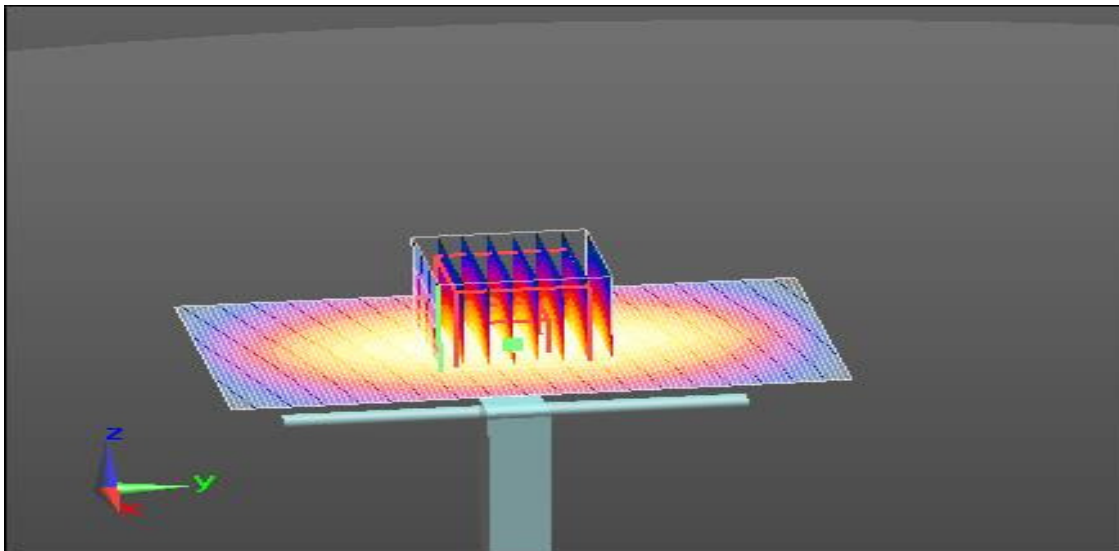

www.tuv.com

System Validation - Band: 1900 MHz

Temperature of Liquid	: 20.3 °C
Test Frequency	: 1900MHz
Measured Conductivity	: 1.47 S/m
Measured Permittivity	: 53.97

Final Scan Results:

Power input to Dipole	: 100mW
Grid Dimension	: 7mmX7mmX7mm
Power Reference	: 69.39V/m
Measured SAR	: 3.98 W/kg
Normalized to 1W power	: 39.8 W/Kg
Power Drift	: -0.01dB

Measurement Plot

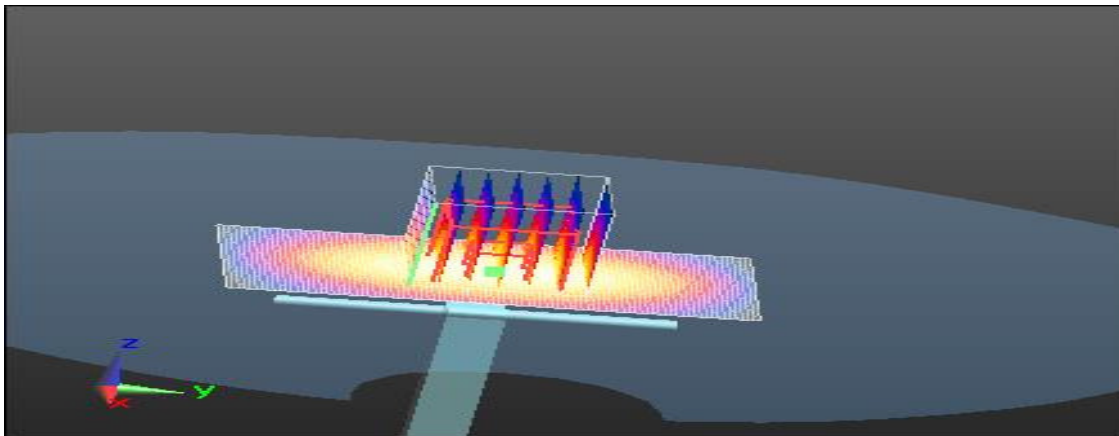

www.tuv.com

System Validation - Band: 1900 MHz

Temperature of Liquid	: 20.2 °C
Test Frequency	: 1900MHz
Measured Conductivity	: 1.40 S/m
Measured Permittivity	: 54.14

Final Scan Results:

Power input to Dipole	: 100mW
Grid Dimension	: 7mmX7mmX7mm
Power Reference	: 69.39V/m
Measured SAR	: 4.0 W/kg
Normalized to 1W power	: 40.0 W/Kg
Power Drift	: -0.11dB

Measurement Plot

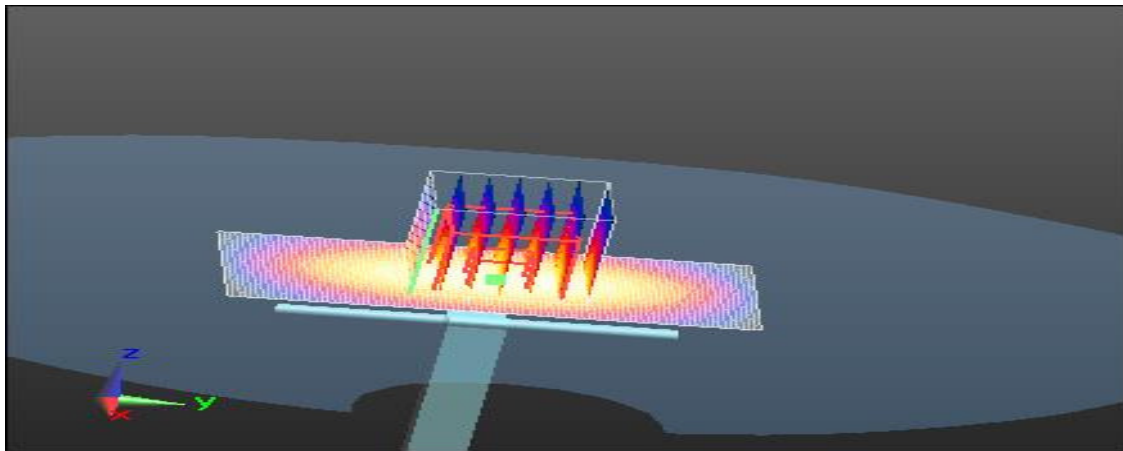

www.tuv.com

System Validation - Band: 1900 MHz

Temperature of Liquid	: 21.5 °C
Test Frequency	: 1900MHz
Measured Conductivity	: 1.55 S/m
Measured Permittivity	: 53.84

Final Scan Results:

Power input to Dipole	: 100mW
Grid Dimension	: 7mmX7mmX7mm
Power Reference	: 68.92V/m
Measured SAR	: 4.25 W/kg
Normalized to 1W power	: 42.5 W/Kg
Power Drift	: -0.09dB

Measurement Plot

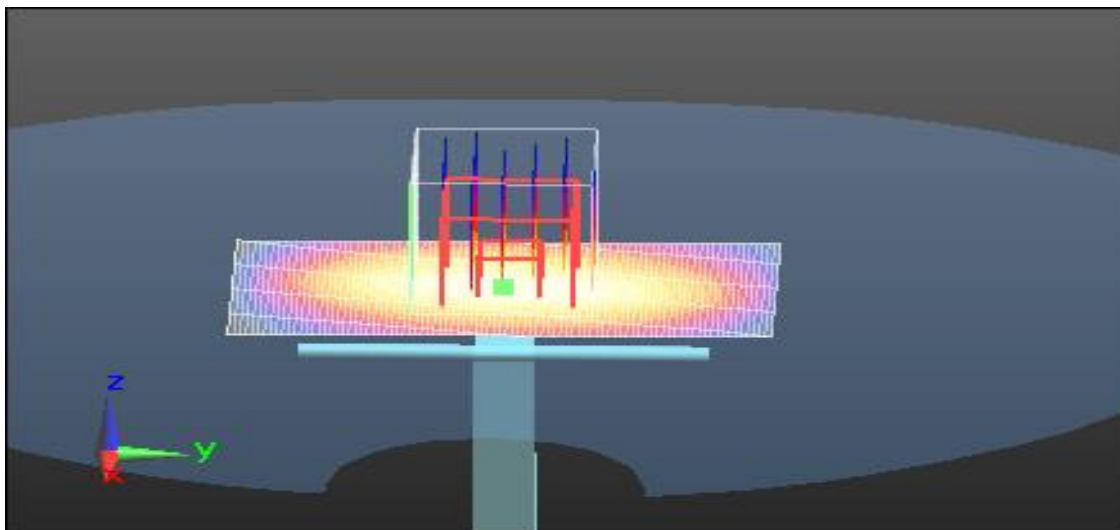

www.tuv.com

System Validation - Band: 2450 MHz

Temperature of Liquid	: 21.9 °C
Test Frequency	: 2450MHz
Measured Conductivity	: 1.95 S/m
Measured Permittivity	: 53.05

Final Scan Results:

Power input to Dipole	: 100mW
Grid Dimension	: 8mmX8mmX7mm
Power Reference	: 79.53V/m
Measured SAR	: 5.49 W/kg
Normalized to 1W power	: 54.9 W/Kg
Power Drift	: -0.18dB

Measurement Plot

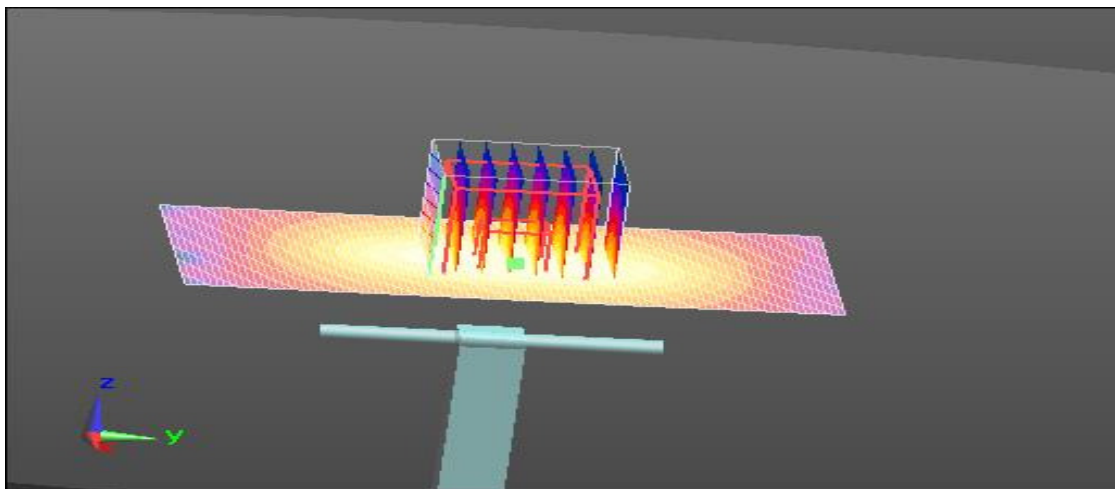

www.tuv.com

System Validation - Band: 2450 MHz

Temperature of Liquid	: 22.3 °C
Test Frequency	: 2450MHz
Measured Conductivity	: 1.94 S/m
Measured Permittivity	: 51.70

Final Scan Results:

Power input to Dipole	: 100mW
Grid Dimension	: 7mmX7mmX7mm
Power Reference	: 68.3V/m
Measured SAR	: 5.00 W/kg
Normalized to 1W power	: 50.0 W/Kg
Power Drift	: -0.12dB

Measurement Plot

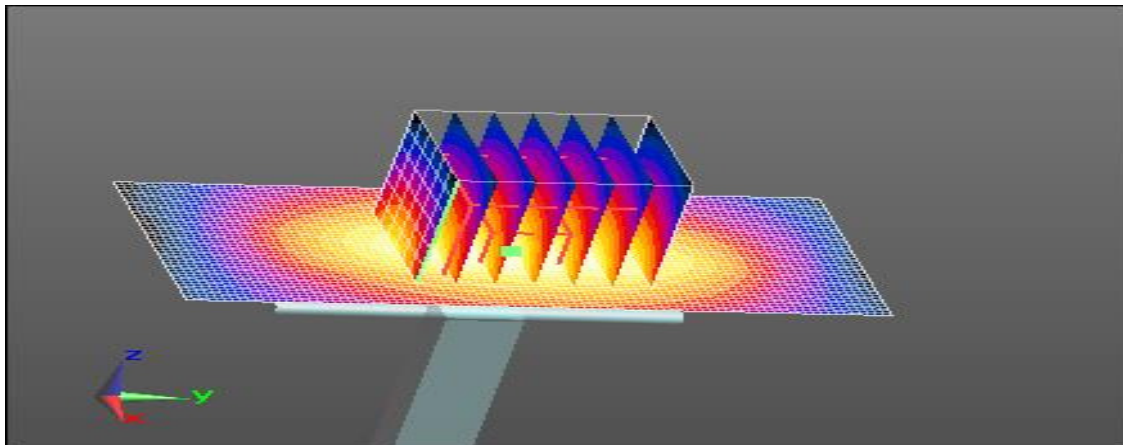

www.tuv.com

System Validation - HSL: 850 MHz

Temperature of Liquid	: 22.4 °C
Test Frequency	: 850 MHz
Measured Conductivity	: 0.94 S/m
Measured Permittivity	: 43.07

Final Scan Results:

Power input to Dipole	: 50mW
Grid Dimension	: 7mmX7mmX7mm
Power Reference	: 24.5 V/m
Measured SAR	: 0.474 W/kg
Normalized to 1W power	: 9.48 W/Kg
Power Drift	: -0.59dB

Measurement Plot

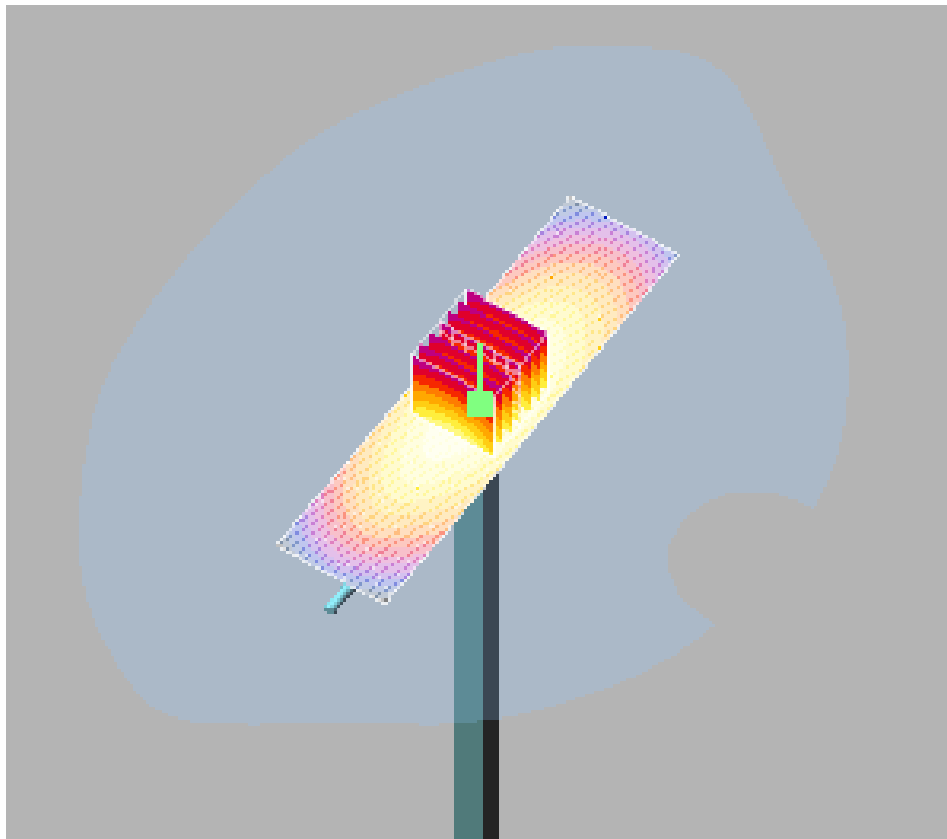

www.tuv.com

System Validation - HSL: 1750 MHz

Temperature of Liquid	: 22.4 °C
Test Frequency	: 1750MHz
Measured Conductivity	: 1.375 S/m
Measured Permittivity	: 40.97

Final Scan Results:

Power input to Dipole	: 50mW
Grid Dimension	: 7mmX7mmX7mm
Power Reference	: 38.1V/m
Measured SAR	: 1.75 W/kg
Normalized to 1W power	: 35 W/Kg
Power Drift	: -0.12dB

Measurement Plot

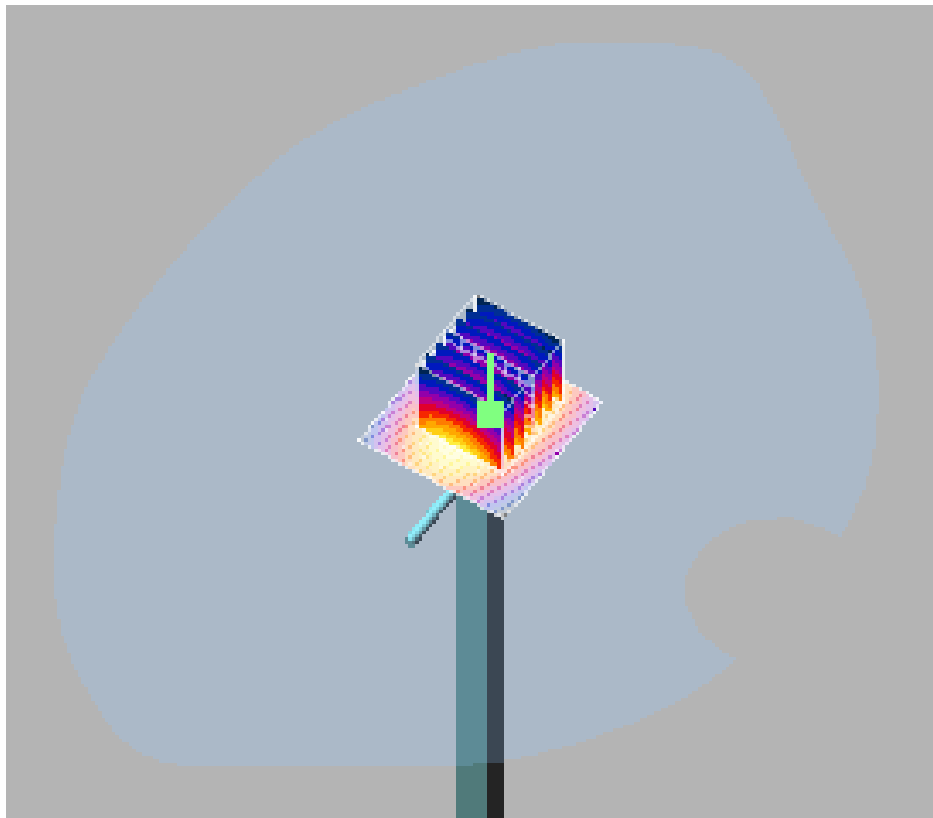

www.tuv.com

System Validation - HSL: 1900 MHz

Temperature of Liquid	: 22.4 °C
Test Frequency	: 1900MHz
Measured Conductivity	: 1.42 S/m
Measured Permittivity	: 40.78

Final Scan Results:

Power input to Dipole	: 50mW
Grid Dimension	: 7mmX7mmX7mm
Power Reference	: 42.3V/m
Measured SAR	: 1.93 W/kg
Normalized to 1W power	: 38.6 W/Kg
Power Drift	: -0.15dB

Measurement Plot

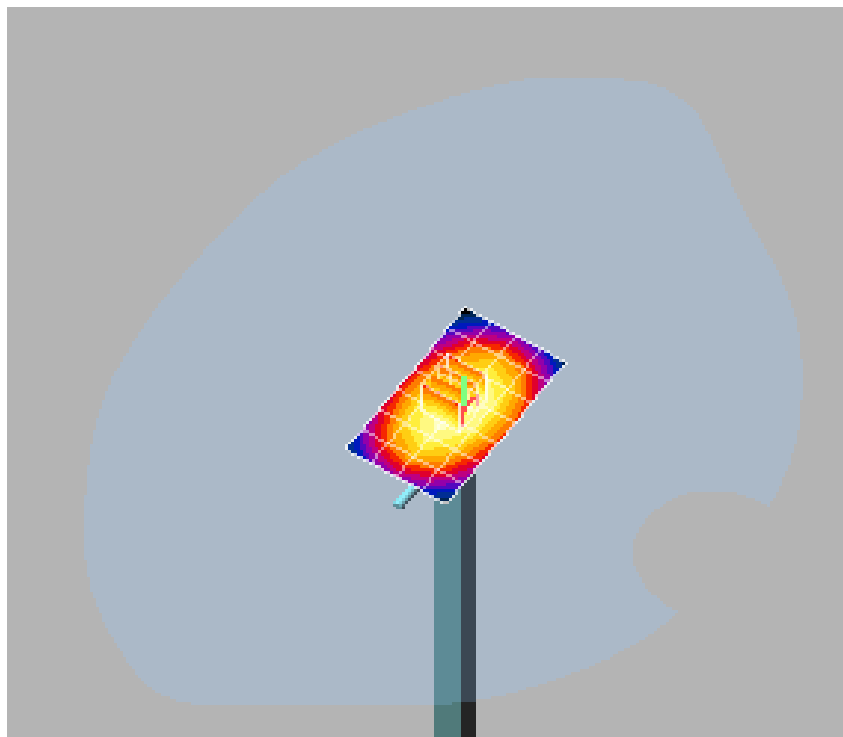

www.tuv.com

System Validation - HSL: 2450 MHz

Temperature of Liquid	: 22.4 °C
Test Frequency	: 2450MHz
Measured Conductivity	: 1.81 S/m
Measured Permittivity	: 40.154

Final Scan Results:

Power input to Dipole	: 50mW
Grid Dimension	: 7mmX7mmX7mm
Power Reference	: 41.5V/m
Measured SAR	: 2.62 W/kg
Normalized to 1W power	: 52.4 W/Kg
Power Drift	: -0.25dB

Measurement Plot

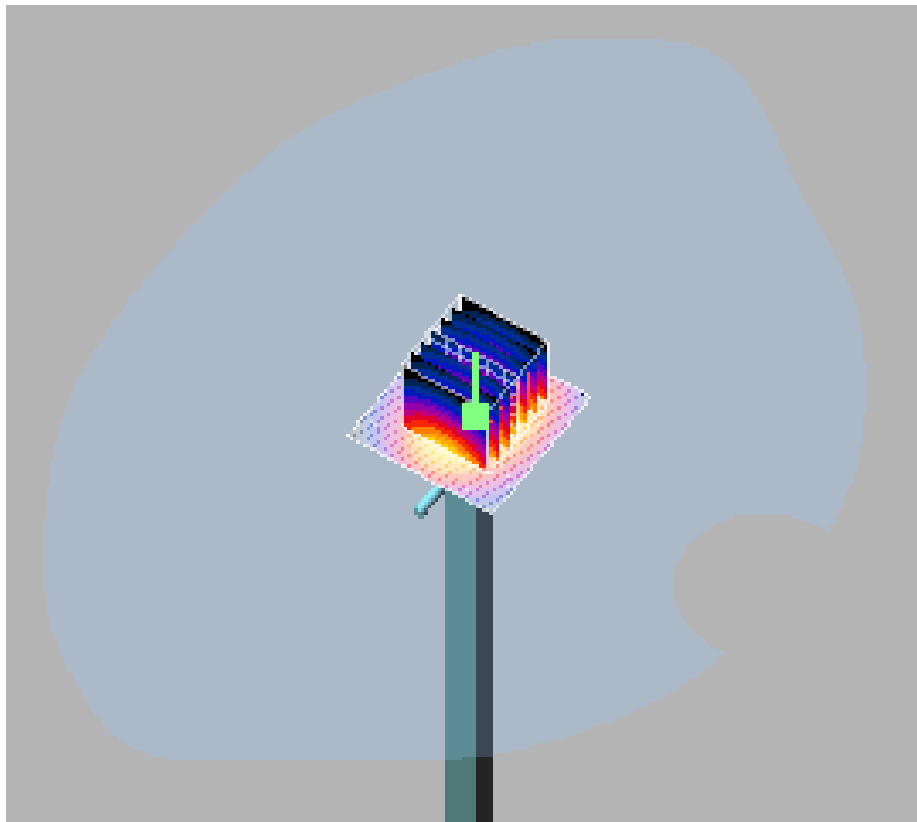

www.tuv.com

System Validation - MSL: 850 MHz

Temperature of Liquid	: 22.7 °C
Test Frequency	: 850 MHz
Measured Conductivity	: 1.017 S/m
Measured Permittivity	: 54.51

Final Scan Results:

Power input to Dipole	: 50mW
Grid Dimension	: 7mmX7mmX7mm
Power Reference	: 21.6 V/m
Measured SAR	: 0.457 W/kg
Normalized to 1W power	: 9.14 W/Kg
Power Drift	: 0.21 dB

Measurement Plot

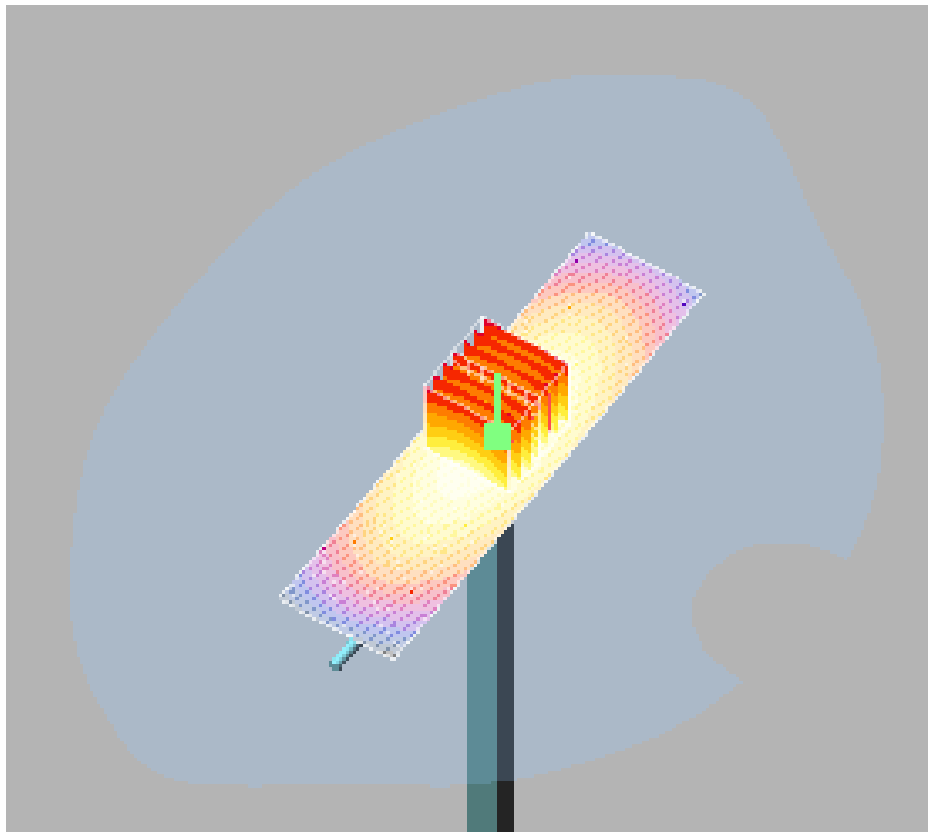

www.tuv.com

System Validation - MSL: 1750 MHz

Temperature of Liquid	: 22.7 °C
Test Frequency	: 1750MHz
Measured Conductivity	: 1.454 S/m
Measured Permittivity	: 53.356

Final Scan Results:

Power input to Dipole	: 50mW
Grid Dimension	: 7mmX7mmX7mm
Power Reference	: 37.2 V/m
Measured SAR	: 1.76 W/kg
Normalized to 1W power	: 35.2 W/Kg
Power Drift	: -0.02dB

Measurement Plot

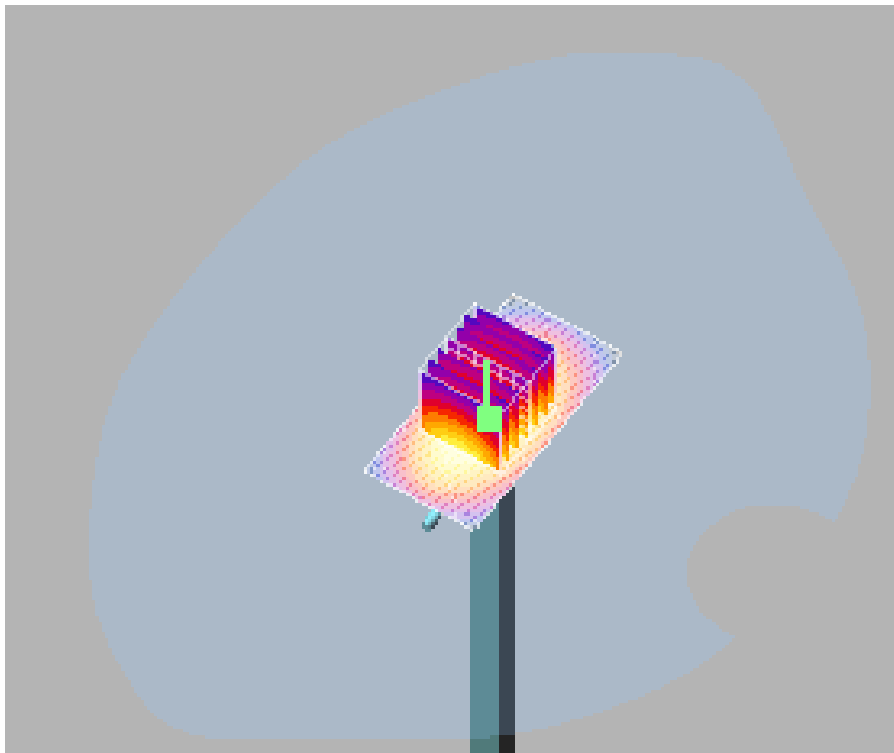

www.tuv.com

System Validation - MSL: 1900 MHz

Temperature of Liquid	: 22.7 °C
Test Frequency	: 1900MHz
Measured Conductivity	: 1.532 S/m
Measured Permittivity	: 53.505

Final Scan Results:

Power input to Dipole	: 50mW
Grid Dimension	: 7mmX7mmX7mm
Power Reference	: 38.3 V/m
Measured SAR	: 2.07 W/kg
Normalized to 1W power	: 41.4 W/Kg
Power Drift	: -0.05dB

Measurement Plot

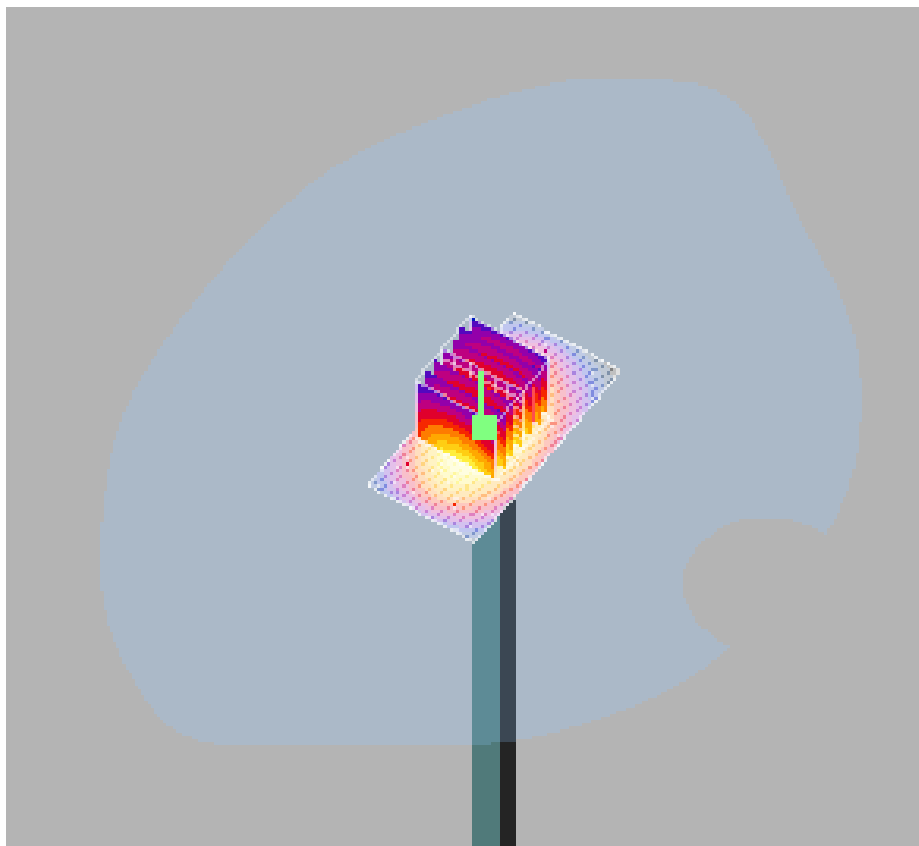

www.tuv.com

System Validation - MBL: 2450 MHz

Temperature of Liquid	: 23 °C
Test Frequency	: 2450MHz
Measured Conductivity	: 1.95 S/m
Measured Permittivity	: 52.66

Final Scan Results:

Power input to Dipole	: 50mW
Grid Dimension	: 7mmX7mmX7mm
Power Reference	: 18.5 V/m
Measured SAR	: 2.63 W/kg
Normalized to 1W power	: 52.6 W/Kg
Power Drift	: 0.28dB

Measurement Plot

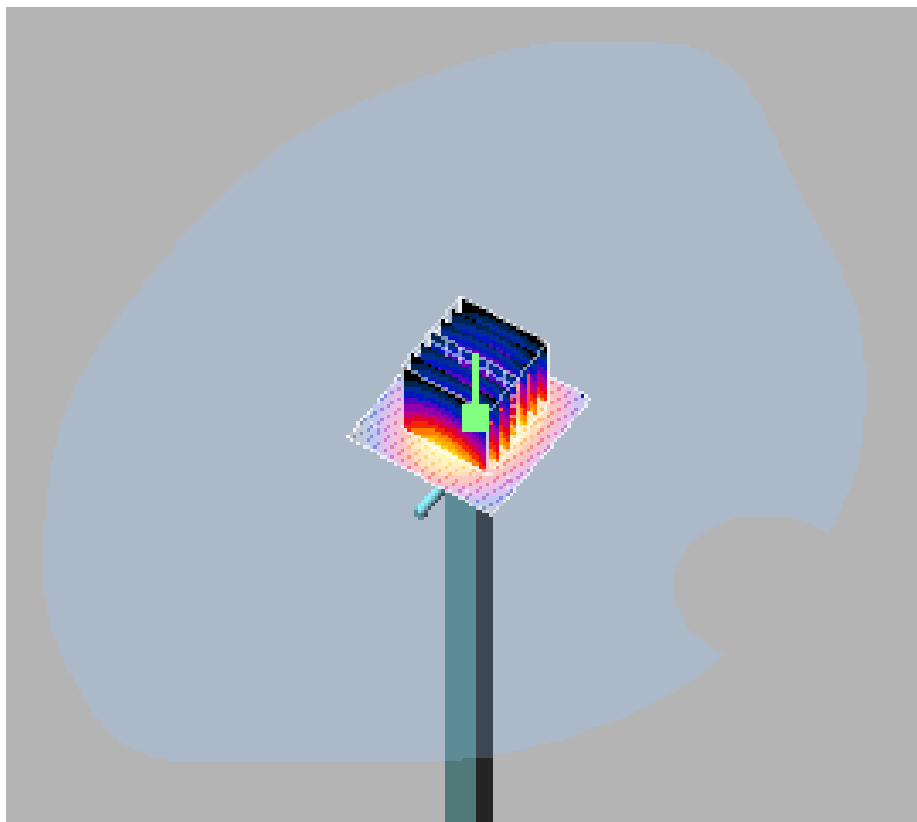

4. Specific Absorption rate of EUT

System Description

The SAR measurement system used by TUV India is the SPEAG DASY4, which consists of a Staubli robot-arm and controller, SPEAG probe and amplifier and an appropriate phantom as required and considered appropriate for the applied test. The robot is used to move and manipulate the probe to programmed positions inside the phantom to obtain the SAR readings from the EUT.

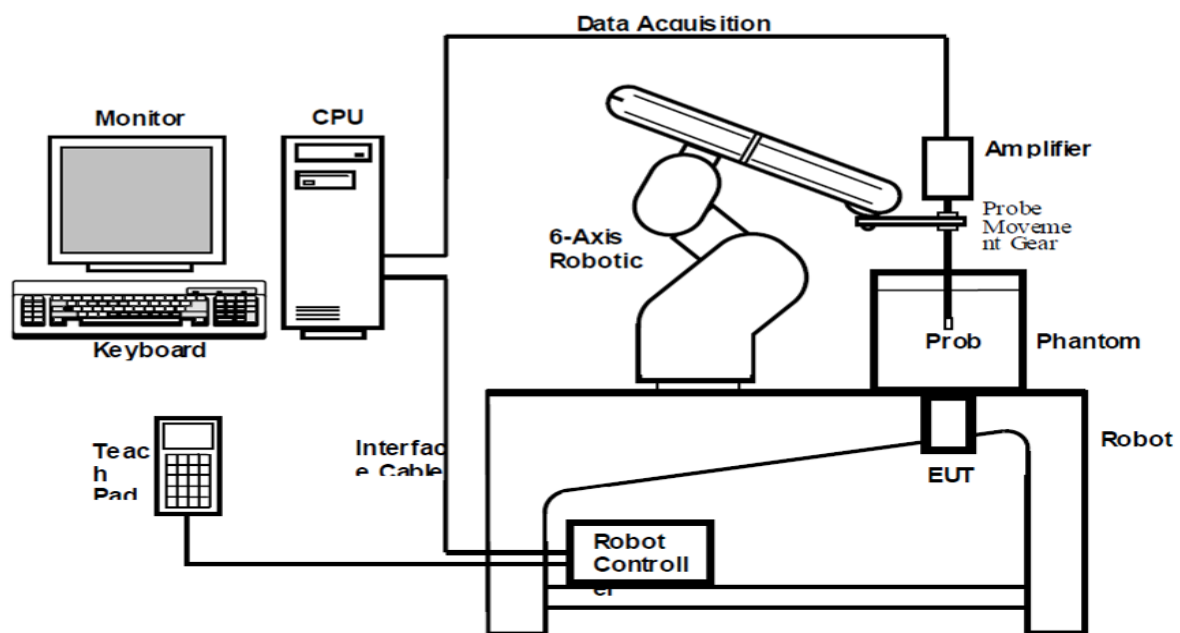

The system is remote controlled by a PC, which contains the software to control the robot and data acquisition equipment. The software also displays the data obtained from test scans by calculating the measured values into corresponding SAR values based on the currently acceptable calculation methods.

The position and digitized shape of the phantom are made available to the software for accurate positioning of the probe and reduction of set-up time.

In operation, the system first does an area (2D) scan at a fixed depth within the liquid from the inside wall of the phantom. When the maximum SAR point has been found, the system will then carry out a 3D scan centered at that point to determine volume averaged SAR level.

Measurement Procedure

During the SAR measurement, the positioning of the probe is performed with sufficient accuracy to obtain repeatable measurements in the presence of rapid spatial attenuation phenomena. The accurate positioning of the E-field probe is accomplished by using the high precision robot. The robot can be taught to position the probe sensor following a specific pattern of points.

After an area scan has been done a 3D scan is set up around the location of the maximum spot SAR. First, a point within the scan area is visited by the probe and a SAR reading taken at the start of testing. At the end of testing, the probe is returned to the same point and a second reading is taken. Comparison between these start and end readings enables the power (SAR) drift during measurement to be assessed.

www.tuv.com

Step size and scan information

For the EUT's 2.4 GHz band a 30 x 30 mm area is scanned centered around the hotspot using 6 steps in the x-y plane and 10 steps of 3.0 mm in the z plane. The first area scan is performed with the probe tip 5 mm above the phantom bottom shell. For the EUT's 5 GHz band a 24 x 24 mm area is scanned centered around the hotspot using 6 steps in the x-y plane and 6 steps of 3 mm in the z plane. The first area scan is performed with the probe tip 2 mm above the phantom bottom shell.

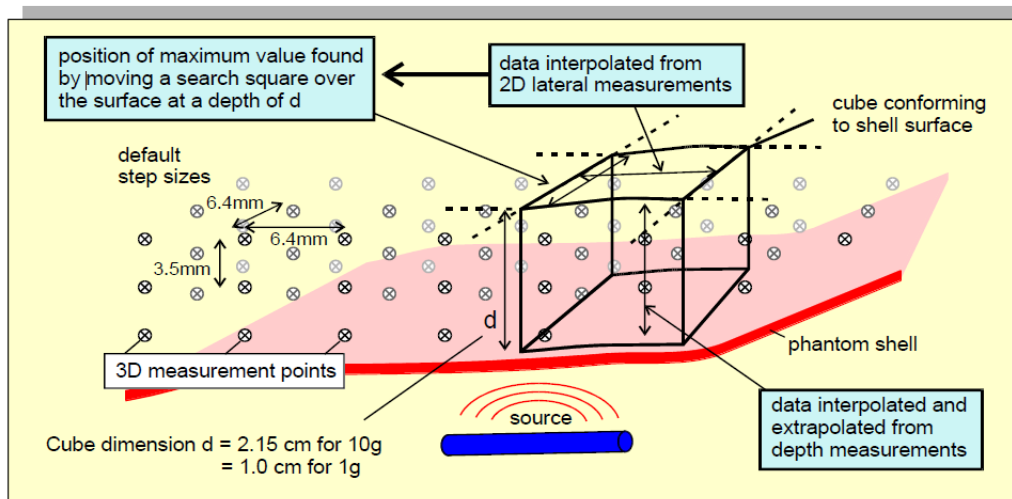

SARA2 Interpolation and Extrapolation schemes

SARA2 software contains support for both 2D cubic B-spline interpolation as well as 3D cubic B-spline interpolation. In addition, for extrapolation purposes, a general n^{th} order polynomial fitting routine is implemented following a singular value decomposition algorithm. A 4th order polynomial fit is used by default for data extrapolation.

Interpolations of 2D area scan

The 2D cubic B-spline interpolation is used after the initial area scan at fixed distance from the phantom shell wall. The initial scan data are collected with approximately 10 mm spatial resolution and spline interpolation is used to find the location of the local maximum to within a 1 mm resolution for positioning the subsequent 3D scanning.

Extrapolation of 3D scan

For the 3D scan, data are collected on a spatially regular 3D grid having (by default) 6.4 mm steps in the lateral dimensions and 3.5 mm steps in the depth direction (away from the source). DASY4 enables full control over the selection of alternative step sizes in all directions. The digitized shape of the Flat Phantom is available to the DASY4 software, which decides which points in the 3D array are sufficiently well within the shell wall to be visited by the SAR probe. After the data collection, the data are extrapolated in the depth direction to assign values to points in the 3D array closer to the shell wall. A notional extrapolation value is also assigned to the first point outside the shell wall so that subsequent interpolation schemes will be applicable right up to the shell wall boundary.

www.tuv.com

Interpolation of 3D scan and volume averaging

The procedure used for defining the shape of the volumes used for SAR averaging in the SARA2 software follow the method of adapting the surface of the „cube“ to conform with the surface of the phantom. This is called, here, the conformal scheme.

For each row of data in the depth direction, the data are extrapolated and interpolated to less than 1 mm spacing and average values are calculated from the phantom surface for the row of data over distances corresponding to the requisite depth for 10g and 1g cubes. These results in two 2D arrays of data, which are then cubic B-spline interpolated to sub mm lateral resolution. A search routine then moves an averaging square around through the 2D array and records the maximum value of the corresponding 1g and 10g volume averages. For measurements in rectangular, box phantoms, the distance between the phantom wall and the closest set of gridded data points is entered into the software.

The default step size (dstep) used is 3.5 mm, but this is under user-control. The compromise is with time of scan, so it is not practical to make it much smaller or scan times become long and power -drop influences become larger. The robot positioning system specification for the repeatability of the positioning (dss) is 0.04 mm.

The flat phantom is made from Polymethylmethacrylate (PMMA), a low-loss dielectric material with dielectric constant and loss tangent less than 5.0 and 0.05 respectively. The shell thickness for all regions coupled to the test device and its antenna are within 2.0 ± 0.2 mm.

For the upright phantom, the alignment is based upon registration of the rotation axis of the phantom on its 253 mm-diameter base plate bearing and the position of the probe axis when commanded to go to the axial position. A laser alignment tool is provided. This enables the registration of the phantom tip (dmis) to be assured to within approx. 0.2 mm. This alignment is done with reference to the actual probe tip after installation and probe alignment.

www.tuv.com

Summary of Results: GSM

The tests were done with all 6 EUT Positions and the worst case emissions are found when EUT front face was touching the Phantom. The same results are reported in the below table.

Limit : 1.6 W/kg									
Band	Channel Frequency (MHz)	Measured Power (dBm)	Measured Power (mW)	Tune-Up Scaling Factor (dB)	Tune-Up Scaling Factor (mW)	Maximum Tune-up Tolerance (mw)	Measured SAR (W/kg)	Reported SAR (W/kg)	Worst Case EUT Position
GSM 850_Head	824.2	30.62	1153.45	0.5	1.12	1294.20	0.389	0.436	Right Touch
	836.6	30.74	1185.77	0.5	1.12	1330.45	0.419	0.470	Right Touch
	848.8	31.42	1386.76	0.5	1.12	1555.97	0.425	0.477	Right Touch
GSM 850_Body	824.2	30.62	1153.45	0.5	1.12	1294.20	0.138	0.155	Edge 1
	836.6	30.74	1185.77	0.5	1.12	1330.45	0.153	0.172	Edge 1
	848.8	31.42	1386.76	0.5	1.12	1555.97	0.171	0.192	Edge 1
PCS1900_Head	1850.2	27.39	548.28	0.3	1.07	587.49	0.512	0.549	Right Touch
	1880	27.49	561.05	0.3	1.07	601.17	0.433	0.464	Right Touch
	1909.8	27.47	558.47	0.3	1.07	598.41	0.481	0.515	Right Touch
PCS1900_Body	1850.2	27.39	548.28	0.3	1.07	587.49	0.142	0.152	Front Face
	1880	27.49	561.05	0.3	1.07	601.17	0.133	0.143	Front Face
	1909.8	27.47	558.47	0.3	1.07	598.41	0.132	0.141	Front Face

Note: Test Performed with Voice mode having Worst case power.

www.tuv.com

Protocol	Band	Channel Frequency (MHz)
GSM	GSM850	824.2

Temperature of Liquid : 22.68 °C
 Measured Conductivity : 0.93 S/m
 Measured Permittivity : 40.805

Area Scan

Grid Dimension : 131mmX81mmX1mm
 Maximum SAR : 0.579 W/Kg

Zoom Scan

Grid Dimension : 7mmX7mmX7mm
 Power Reference : 11.57 V/m
 Measured SAR : 0.389 W/Kg
 Power Drift : 0.20 dB

Measurement Plot:

EUT Position: Right Touch

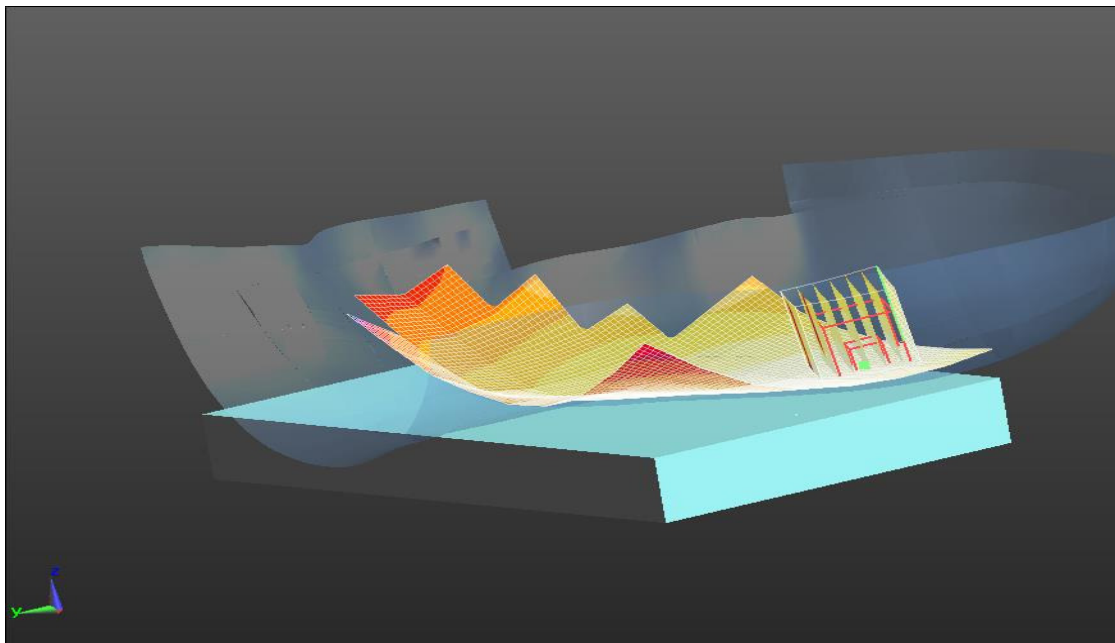

www.tuv.com

Protocol	Band	Channel Frequency (MHz)
GSM	GSM850	836.6

Temperature of Liquid : 22.68 °C
 Measured Conductivity : 0.96 S/m
 Measured Permittivity : 40.905

Area Scan

Grid Dimension : 131mmX81mmX1mm
 Maximum SAR : 0.549W/Kg

Zoom Scan

Grid Dimension : 7mmX7mmX7mm
 Power Reference : 11.57 V/m
 Measured SAR : 0.419 W/Kg
 Power Drift : 0.22 dB

Measurement Plot:

EUT Position: Right Touch

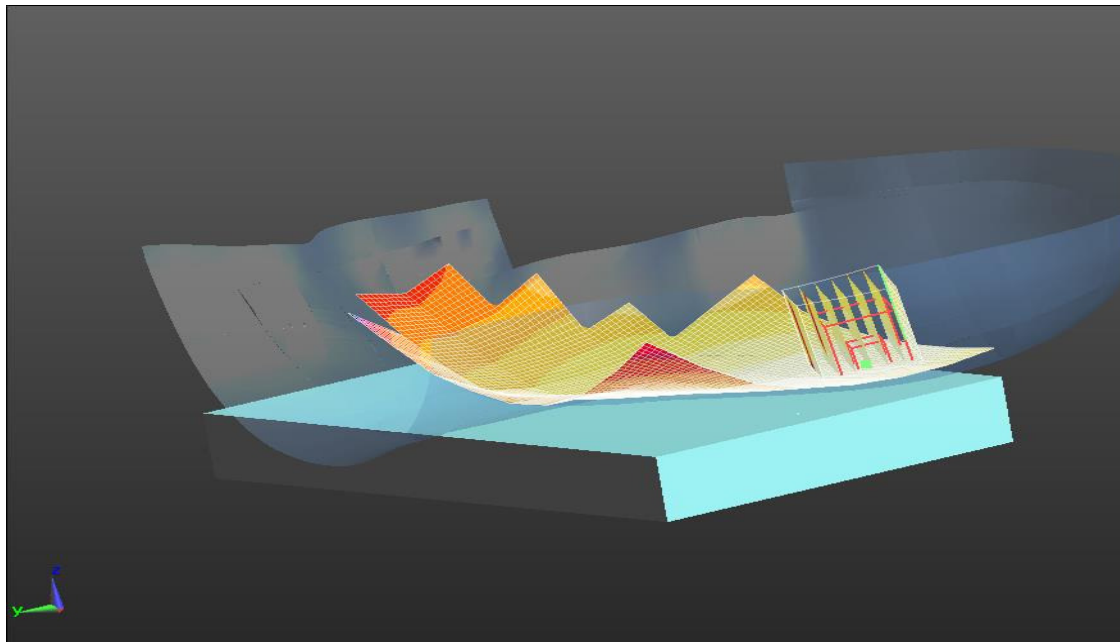

www.tuv.com

Protocol	Band	Channel Frequency (MHz)
GSM	GSM850	848.8

Temperature of Liquid : 24.03 °C
 Measured Conductivity : 0.97 S/m
 Measured Permittivity : 40.985

Area Scan

Grid Dimension : 131mmX81mmX1mm
 Maximum SAR : 0.599W/Kg

Zoom Scan

Grid Dimension : 7mmX7mmX7mm
 Power Reference : 11.21 V/m
 Measured SAR : 0.425 W/Kg
 Power Drift : 0.18 dB

Measurement Plot:

EUT Position: Edge 1

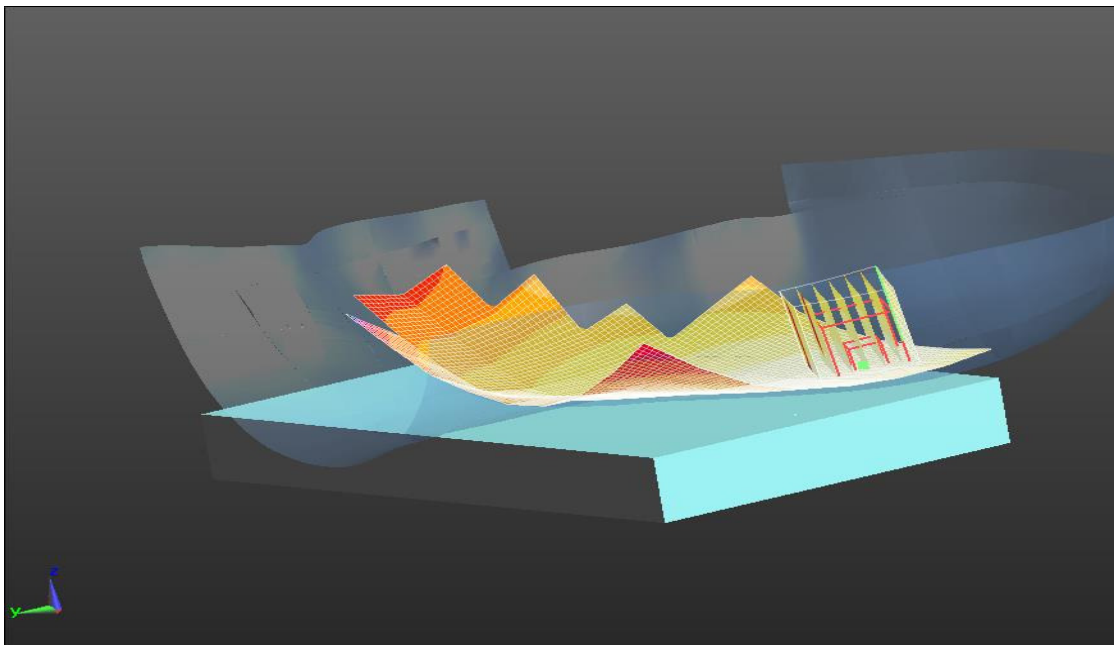

www.tuv.com

Protocol	Band	Channel Frequency (MHz)
GSM	GSM850	824.2

Temperature of Liquid : 21.9 °C
 Measured Conductivity : 0.895 S/m
 Measured Permittivity : 55.408

Area Scan

Grid Dimension : 81mmX91mmX1mm
 Maximum SAR : 0.182W/Kg

Zoom Scan

Grid Dimension : 7mmX9mmX7mm
 Power Reference : 14.08 V/m
 Measured SAR : 0.138 W/Kg
 Power Drift : -0.34 dB

Measurement Plot:

EUT Position: Edge 1

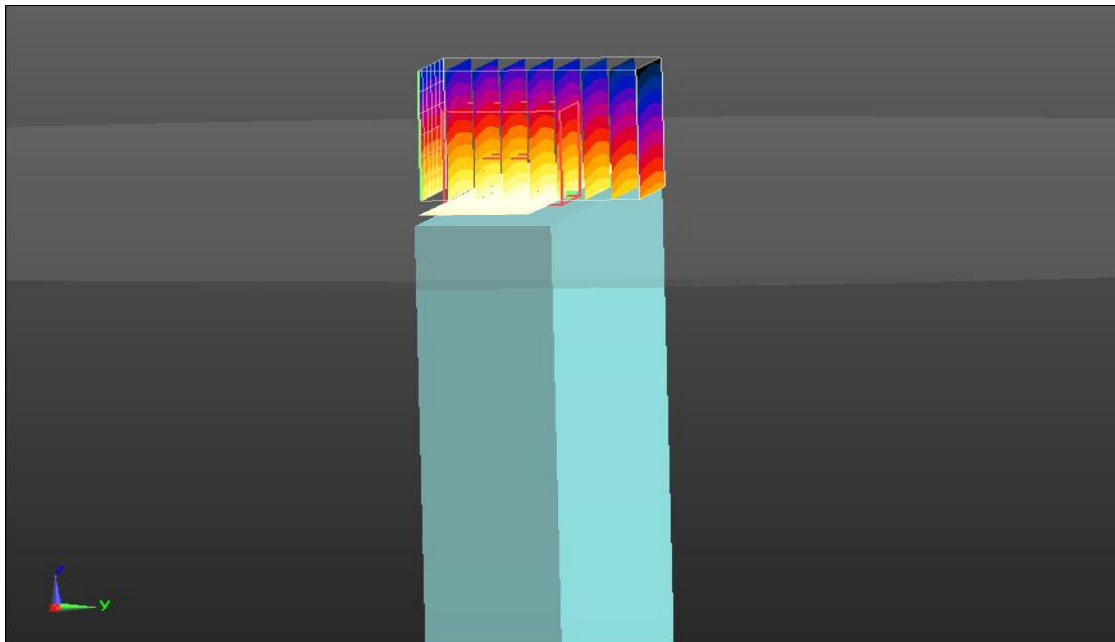

www.tuv.com

Protocol	Band	Channel Frequency (MHz)
GSM	GSM850	836.6

Temperature of Liquid : 21.9 °C
 Measured Conductivity : 0.89 S/m
 Measured Permittivity : 55.38

Area Scan

Grid Dimension : 71mmX91mmX1mm
 Maximum SAR : 0.229W/Kg

Zoom Scan

Grid Dimension : 7mmX7mmX7mm
 Power Reference : 16.26 V/m
 Measured SAR : 0.153 W/Kg
 Power Drift : -0.17 dB

Measurement Plot:

EUT Position: Edge 1

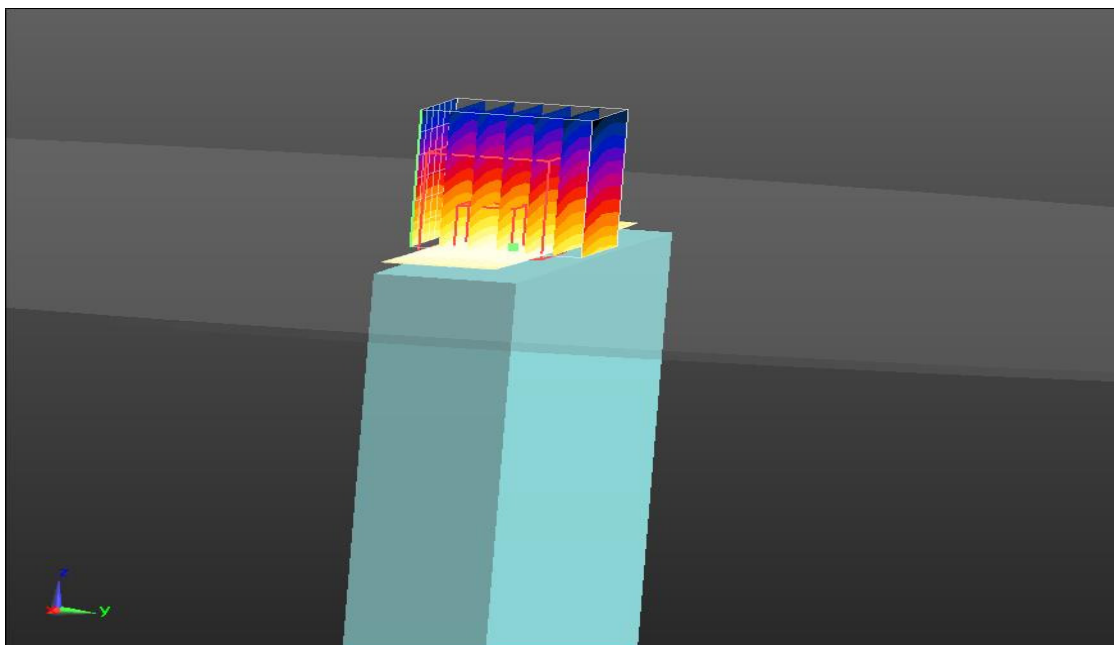

www.tuv.com

Protocol	Band	Channel Frequency (MHz)
GSM	GSM850	848.8

Temperature of Liquid : 21.9 °C
 Measured Conductivity : 0.902 S/m
 Measured Permittivity : 55.35

Area Scan

Grid Dimension : 91mmX91mmX1mm
 Maximum SAR : 0.203W/Kg

Zoom Scan

Grid Dimension : 8mmX9mmX7mm
 Power Reference : 16.43 V/m
 Measured SAR : 0.171 W/Kg
 Power Drift : -0.64 dB

Measurement Plot:

EUT Position: Edge 1

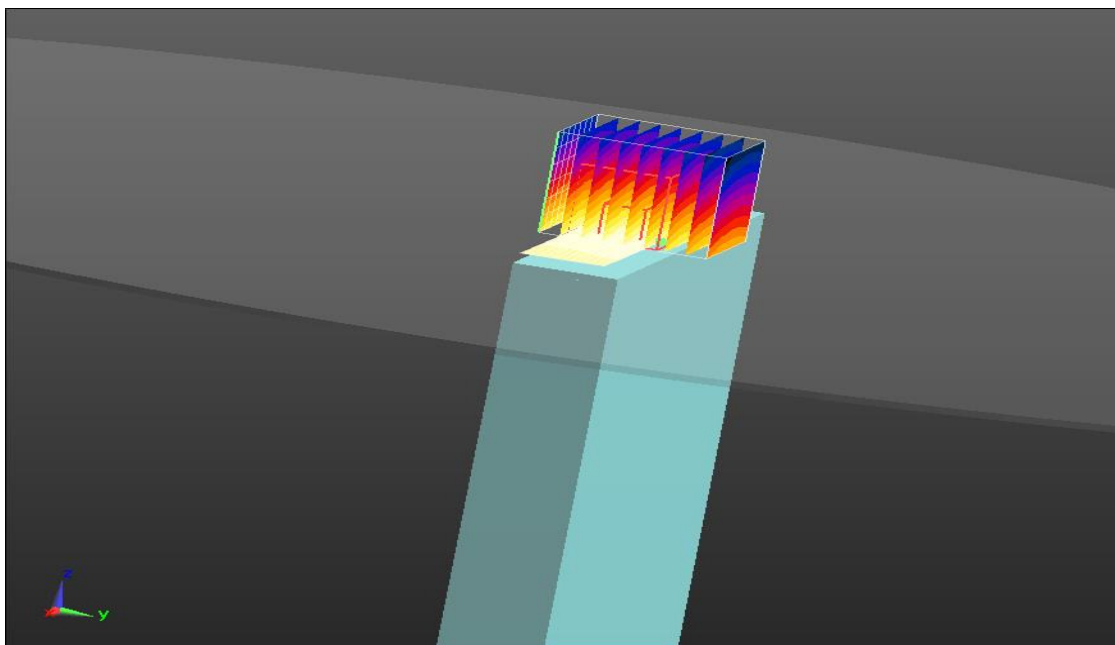

www.tuv.com

Protocol	Band	Channel Frequency (MHz)
GSM	PCS1900	1850.2

Temperature of Liquid : 21.6 °C
 Measured Conductivity : 1.432 S/m
 Measured Permittivity : 39.086

Area Scan

Grid Dimension : 131mmX101mmX1mm
 Maximum SAR : 0.617W/Kg

Zoom Scan

Grid Dimension : 7mmX7mmX7mm
 Power Reference : 5.298V/m
 Measured SAR : 0.512 W/Kg
 Power Drift :-0.10dB

Measurement Plot:

EUT Position: Right Touch

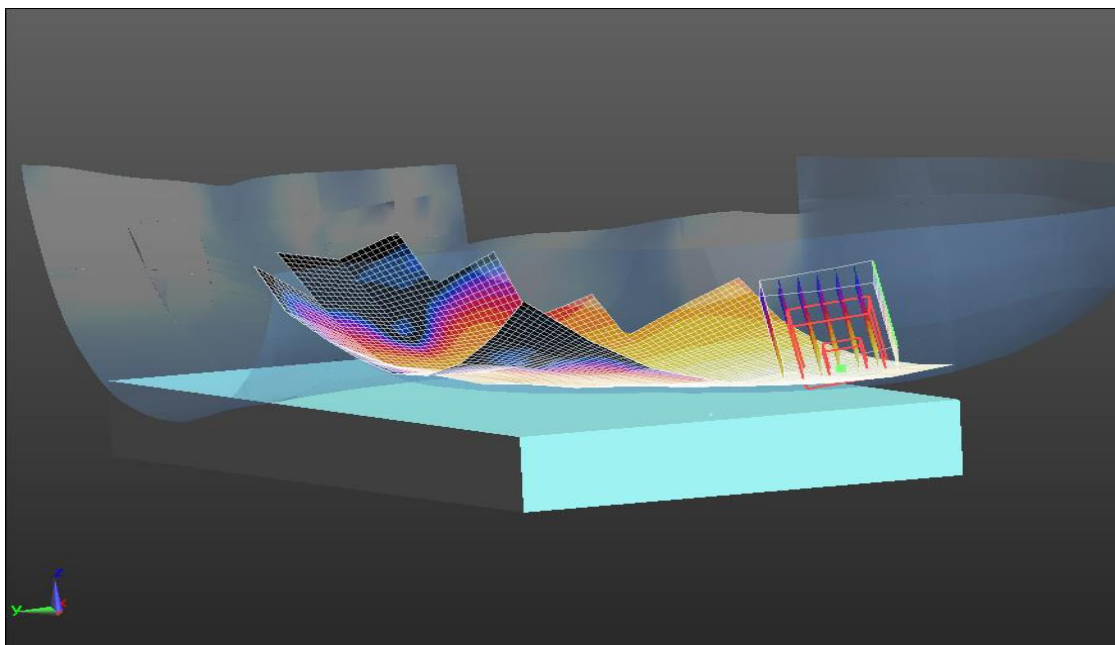

www.tuv.com

Protocol	Band	Channel Frequency (MHz)
GSM	PCS1900	1880

Temperature of Liquid : 21.6 °C
 Measured Conductivity : 1.446 S/m
 Measured Permittivity : 38.927

Area Scan

Grid Dimension : 131mmX91mmX1mm
 Maximum SAR : 0.574 W/Kg

Zoom Scan

Grid Dimension : 7mmX7mmX7mm
 Power Reference : 4.878 V/m
 Measured SAR : 0.433 W/Kg
 Power Drift : -0.36dB

Measurement Plot:

EUT Position: Right Touch

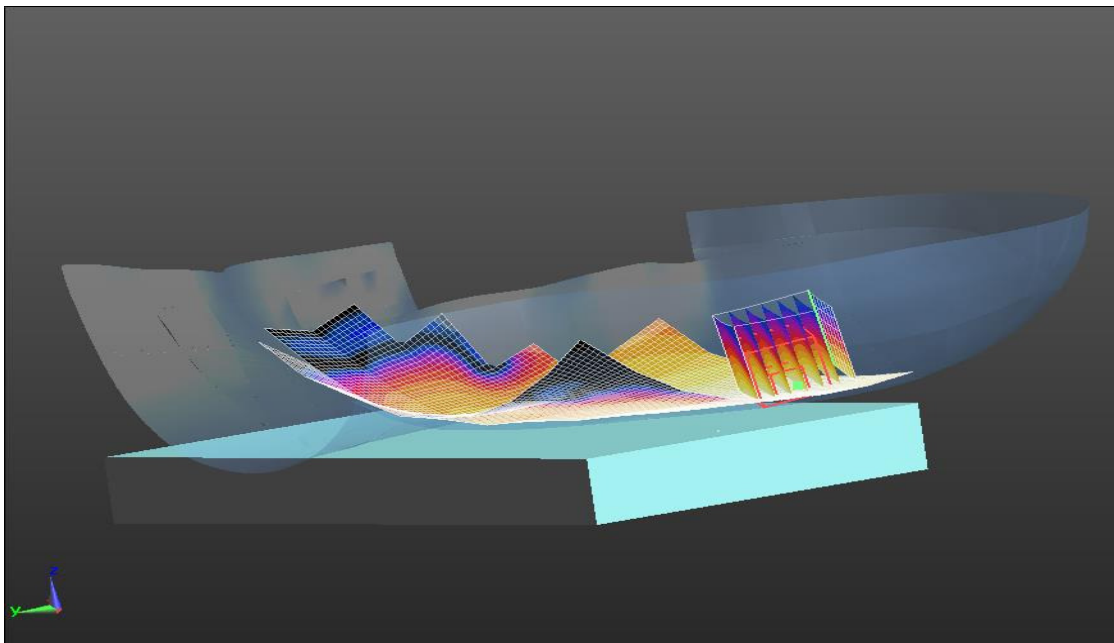

www.tuv.com

Protocol	Band	Channel Frequency (MHz)
GSM	PCS1900	1909.8

Temperature of Liquid : 21.6 °C
 Measured Conductivity : 1.457 S/m
 Measured Permittivity : 38.772

Area Scan

Grid Dimension : 131mmX101mmX1mm
 Maximum SAR : 0.496W/Kg

Zoom Scan

Grid Dimension : 7mmX7mmX7mm
 Power Reference : 5.134V/m
 Measured SAR : 0.481 W/Kg
 Power Drift : -0.01dB

Measurement Plot:

EUT Position: Right Touch

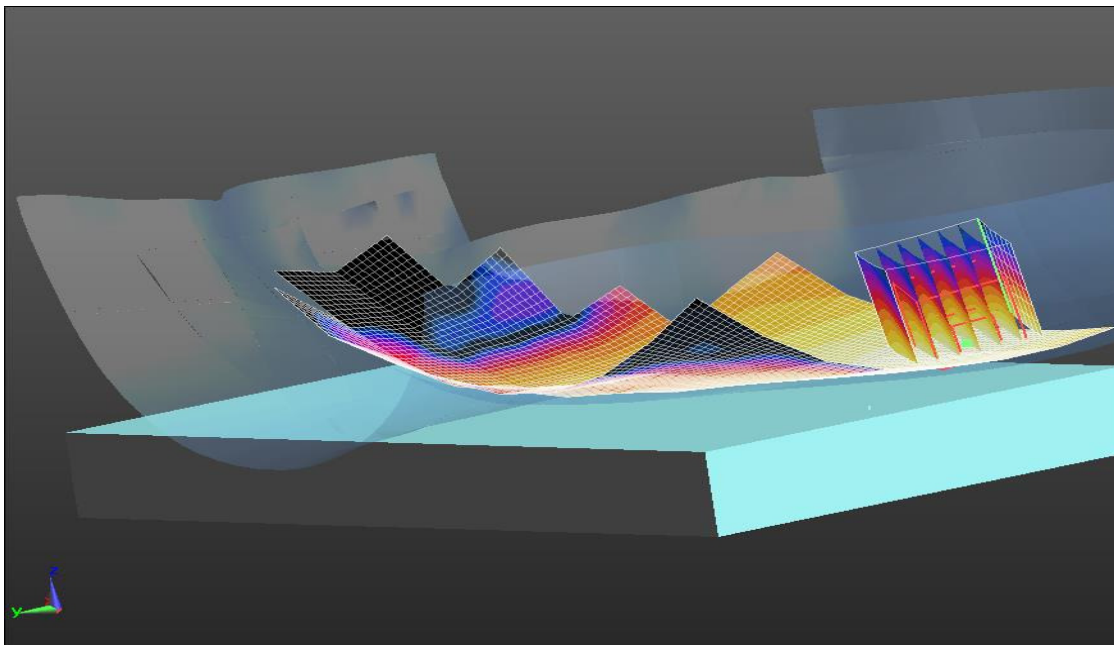

www.tuv.com

Protocol	Band	Channel Frequency (MHz)
GSM	PCS1900	1850.2

Temperature of Liquid : 21.5 °C
 Measured Conductivity : 1.55 S/m
 Measured Permittivity : 53.842

Area Scan

Grid Dimension : 131mmX101mmX1mm
 Maximum SAR : 0.193 W/Kg

Zoom Scan

Grid Dimension : 8mmX8mmX7mm
 Power Reference : 4.392 V/m
 Measured SAR : 0.142 W/Kg
 Power Drift : -0.06 dB

Measurement Plot:

EUT Position: Front Face

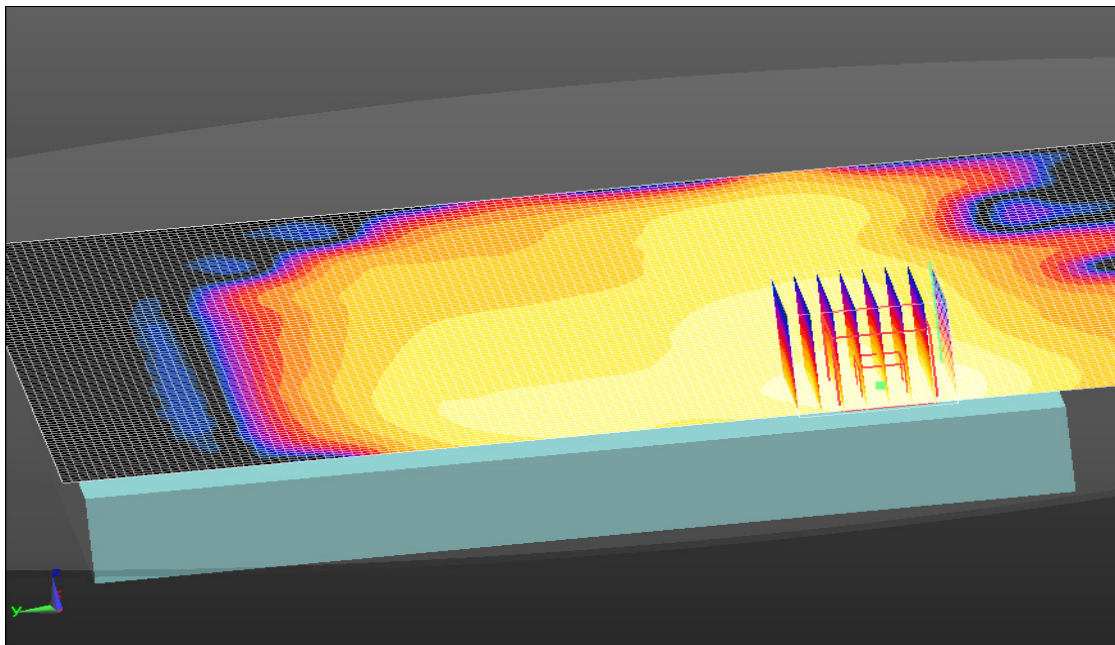

www.tuv.com

Protocol	Band	Channel Frequency (MHz)
GSM	PCS1900	1880

Temperature of Liquid : 21.5 °C
 Measured Conductivity : 1.55 S/m
 Measured Permittivity : 53.842

Area Scan

Grid Dimension : 131mmX91mmX1mm
 Maximum SAR : 0.189 W/Kg

Zoom Scan

Grid Dimension : 8mmX8mmX7mm
 Power Reference : 4.598 V/m
 Measured SAR : 0.133 W/Kg
 Power Drift : 0.28 dB

Measurement Plot:

EUT Position: Front Face

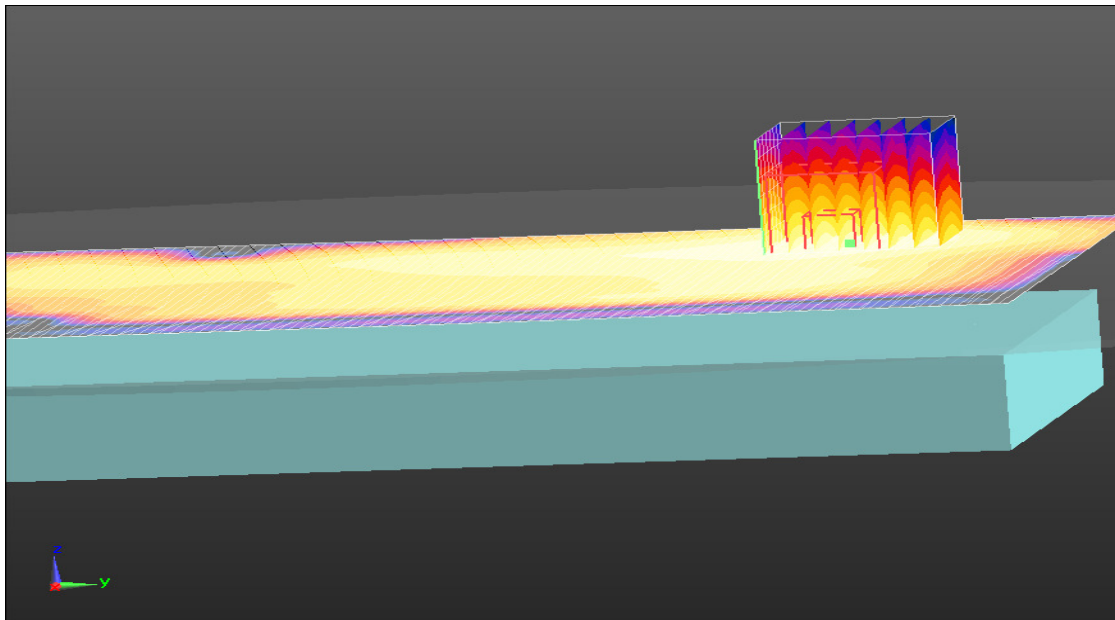

www.tuv.com

Protocol	Band	Channel Frequency (MHz)
GSM	PCS1900	1909.8

Temperature of Liquid : 21.5 °C
 Measured Conductivity : 1.58 S/m
 Measured Permittivity : 53.735

Area Scan

Grid Dimension : 131mmX101mmX1mm
 Maximum SAR : 0.183W/Kg

Zoom Scan

Grid Dimension : 8mmX8mmX7mm
 Power Reference : 4.272V/m
 Measured SAR : 0.132 W/Kg
 Power Drift : -0.10dB

Measurement Plot:

EUT Position: Right Touch

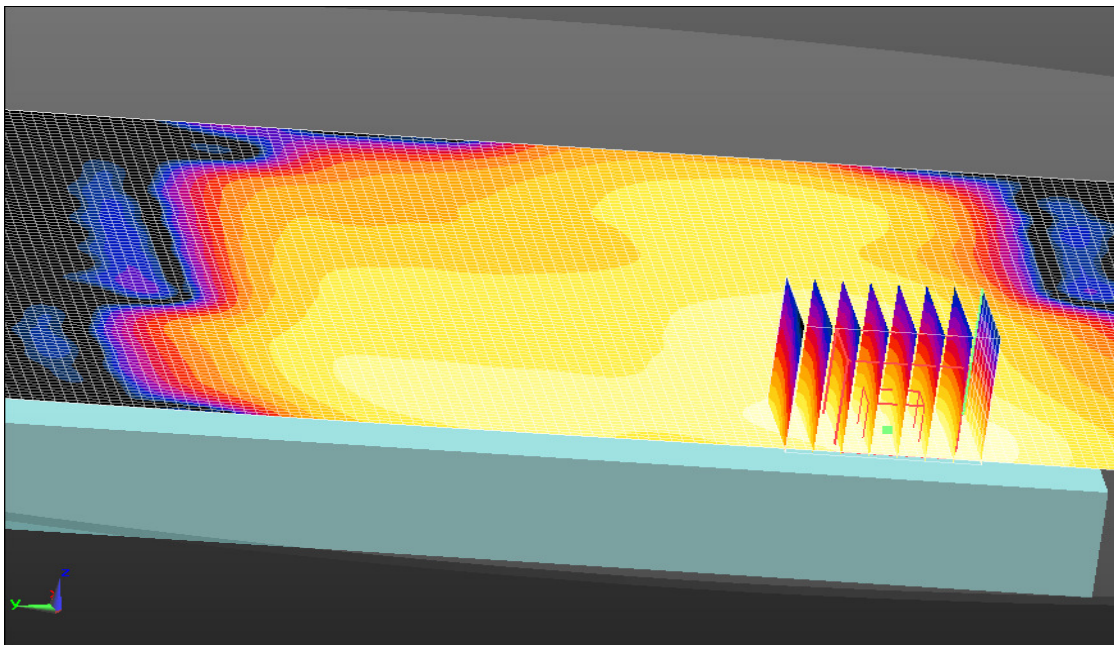

www.tuv.com
Summary of Results: WCDMA

Band	Channel Frequency (MHz)	Measured Power (dBm)	Measured Power (mW)	Tune-Up Scaling Factor (dB)	Tune-Up Scaling Factor (mW)	Maximum Tune-up Tolerance (mw)	Measured SAR (W/kg)	Reported SAR (W/kg)	Worst Case EUT Position
W-CDMA Band 2_Body	1852.4	19.55	90.16	0.7	1.17	105.93	0.600	0.705	Front Face
	1880	20.21	104.95	0.7	1.17	123.31	0.444	0.522	Front Face
	1907.6	19.47	88.51	0.7	1.17	103.99	0.324	0.381	Front Face
W-CDMA Band 4_Body	1712.4	17.98	62.81	0.6	1.15	72.11	0.619	0.711	Back Face
	1732.4	18.49	70.63	0.6	1.15	81.10	0.63	0.723	Back Face
	1752.6	20.14	103.28	0.6	1.15	118.58	0.54	0.620	Back Face
W-CDMA Band 5_Body	826.4	19.19	82.99	0.4	1.10	90.99	0.13	0.143	Edge 1
	836.6	19.09	81.10	0.4	1.10	88.92	0.348	0.382	Edge 1
	846.6	20.57	114.02	0.4	1.10	125.03	0.228	0.250	Edge 1
W-CDMA Band 2_Head	1852.4	19.55	90.16	0.7	1.17	105.93	0.879	1.033	Right Touch
	1880	20.21	104.95	0.7	1.17	123.31	1.19	1.398	Right Touch
	1907.6	19.47	88.51	0.7	1.17	103.99	0.618	0.726	Right Touch
W-CDMA Band 4_Head	1712.4	17.98	62.81	0.6	1.15	72.11	1.10	1.263	Right Touch
	1732.4	18.49	70.63	0.6	1.15	81.10	0.917	1.053	Right Touch
	1752.6	20.14	103.28	0.6	1.15	118.58	0.863	0.991	Right Touch
W-CDMA Band 5_Head	826.4	19.19	82.99	0.4	1.10	90.99	0.333	0.365	Right Touch
	836.6	19.09	81.10	0.4	1.10	88.92	0.667	0.731	Right Touch
	846.6	20.57	114.02	0.4	1.10	125.03	0.201	0.220	Right Touch

www.tuv.com

Protocol	Band	Channel Frequency (MHz)
W-CDMA	FDD Band 2	1852.4

Temperature of Liquid : 20.2 °C
 Measured Conductivity : 1.413 S/m
 Measured Permittivity : 54.269

Area Scan

Grid Dimension : 131mmX101mmX1mm
 Maximum SAR : 0.803W/Kg

Zoom Scan

Grid Dimension : 7mmX7mmX7mm
 Power Reference : 10.15 V/m
 Measured SAR : 0.60 W/Kg
 Power Drift : 0.15 dB

Measurement Plot:

EUT Position: Front Face

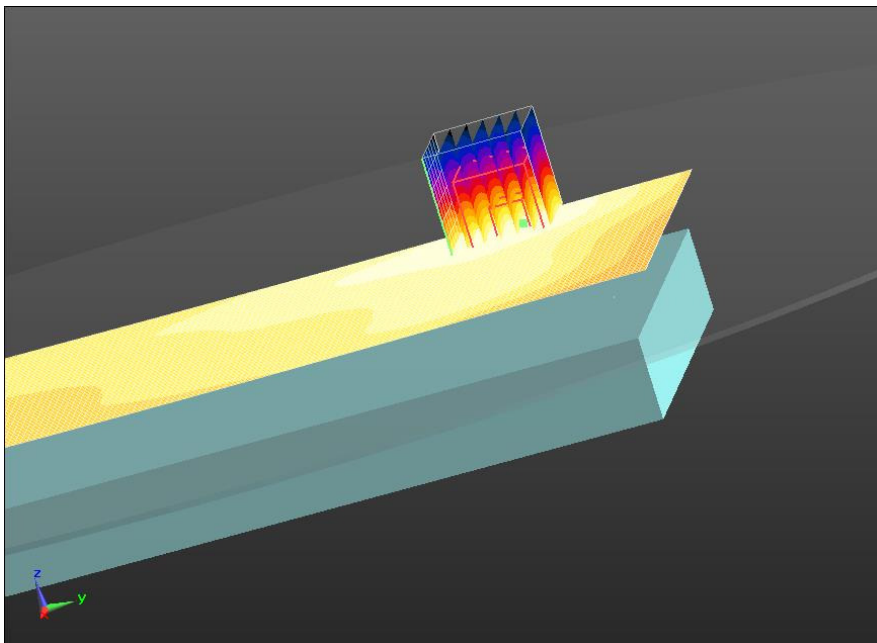

www.tuv.com

Protocol	Band	Channel Frequency (MHz)
W-CDMA	FDD Band 2	1880

Temperature of Liquid : 20.2 °C
 Measured Conductivity : 1.408 S/m
 Measured Permittivity : 54.196

Area Scan

Grid Dimension : 131mmX91mmX1mm
 Maximum SAR : 0.591 W/Kg

Zoom Scan

Grid Dimension : 7mmX7mmX7mm
 Power Reference : 9.158 V/m
 Measured SAR : 0.444 W/Kg
 Power Drift : 0.04 dB

Measurement Plot:

EUT Position: Front Face

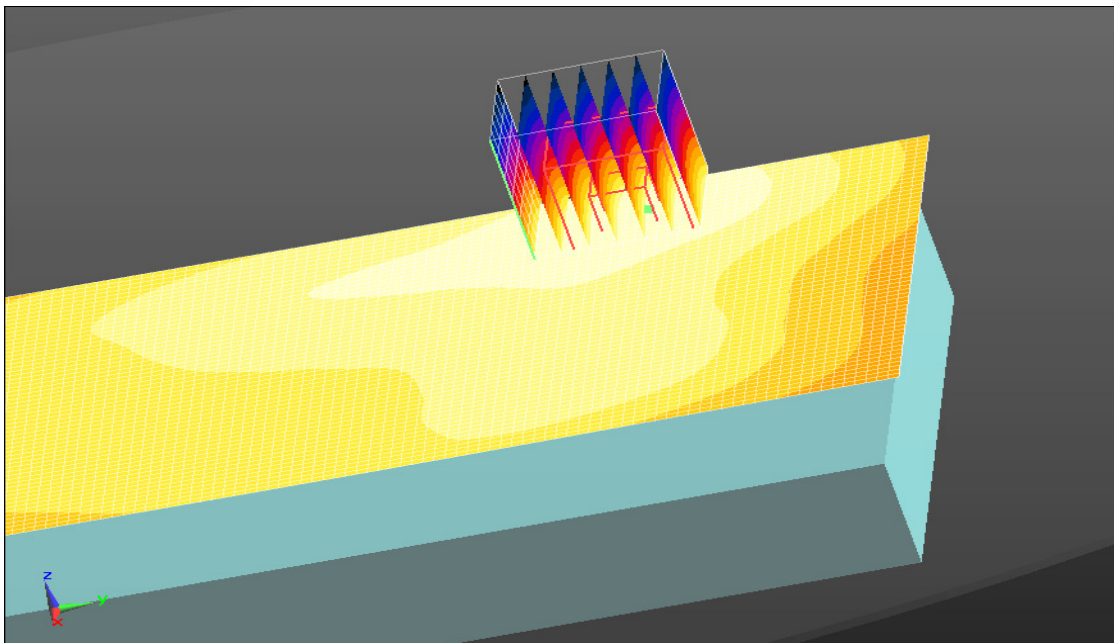

www.tuv.com

Protocol	Band	Channel Frequency (MHz)
W-CDMA	FDD Band 2	1907.6

Temperature of Liquid : 20.2 °C
 Measured Conductivity : 1.402 S/m
 Measured Permittivity : 54.144

Area Scan

Grid Dimension : 131mmX91mmX1mm
 Maximum SAR : 0.437 W/Kg

Zoom Scan

Grid Dimension : 7mmX7mmX7mm
 Power Reference : 7.642 V/m
 Measured SAR : 0.324 W/Kg
 Power Drift : -0.17 dB

Measurement Plot:

EUT Position: Front Face

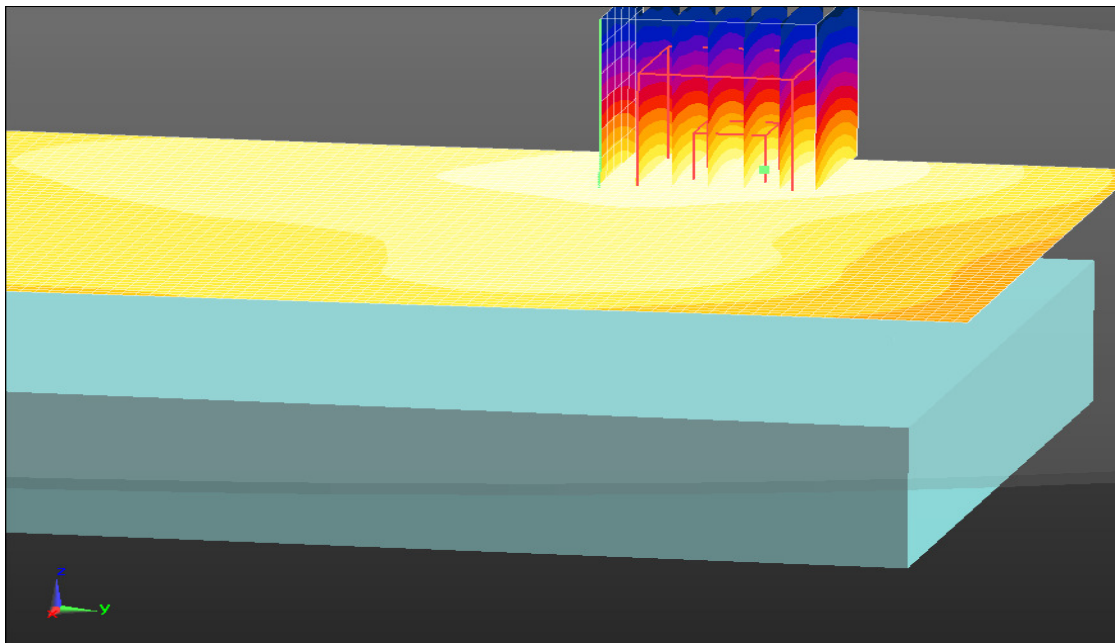

www.tuv.com

Protocol	Band	Channel Frequency (MHz)
W-CDMA	FDD Band 4	1712.4

Temperature of Liquid : 20.2 °C
 Measured Conductivity : 1.363 S/m
 Measured Permittivity : 54.418

Area Scan

Grid Dimension : 131mmX101mmX1mm
 Maximum SAR : 0.914W/Kg

Zoom Scan

Grid Dimension : 8mmX8mmX7mm
 Power Reference : 6.464 V/m
 Measured SAR : 0.619 W/Kg
 Power Drift : -0.38 dB

Measurement Plot:

EUT Position: Back Face

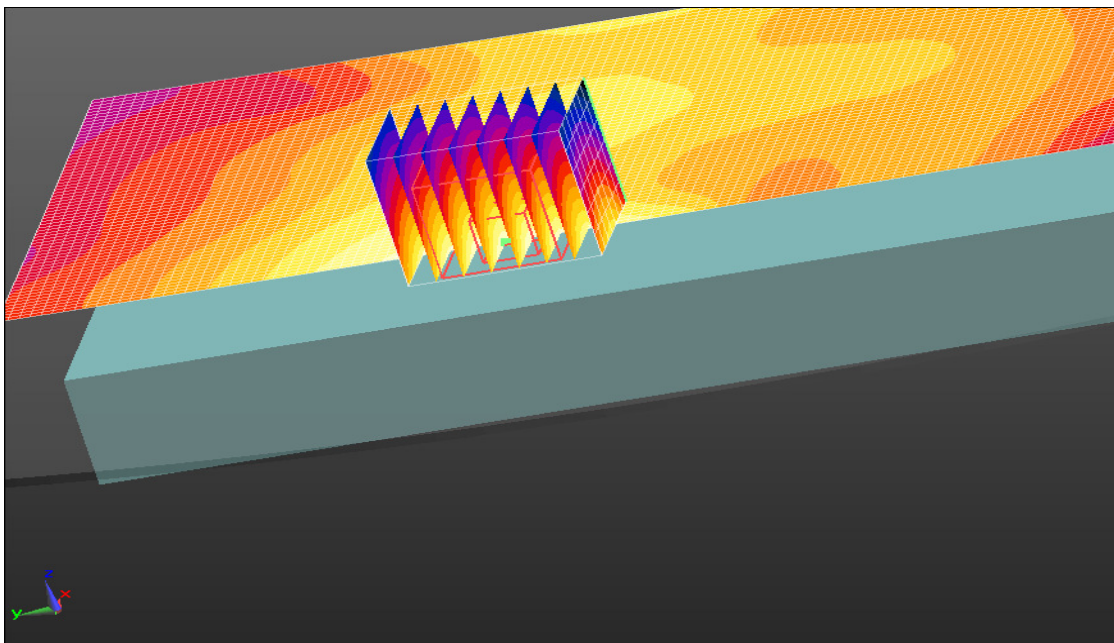

www.tuv.com

Protocol	Band	Channel Frequency (MHz)
W-CDMA	FDD Band 4	1732.6

Temperature of Liquid : 20.2 °C
 Measured Conductivity : 1.348 S/m
 Measured Permittivity : 54.422

Area Scan

Grid Dimension : 131mmX91mmX1mm
 Maximum SAR : 0.842 W/Kg

Zoom Scan

Grid Dimension : 7mmX7mmX7mm
 Power Reference : 7.275 V/m
 Measured SAR : 0.630 W/Kg
 Power Drift : -0.12 dB

Measurement Plot:

EUT Position: Back Face

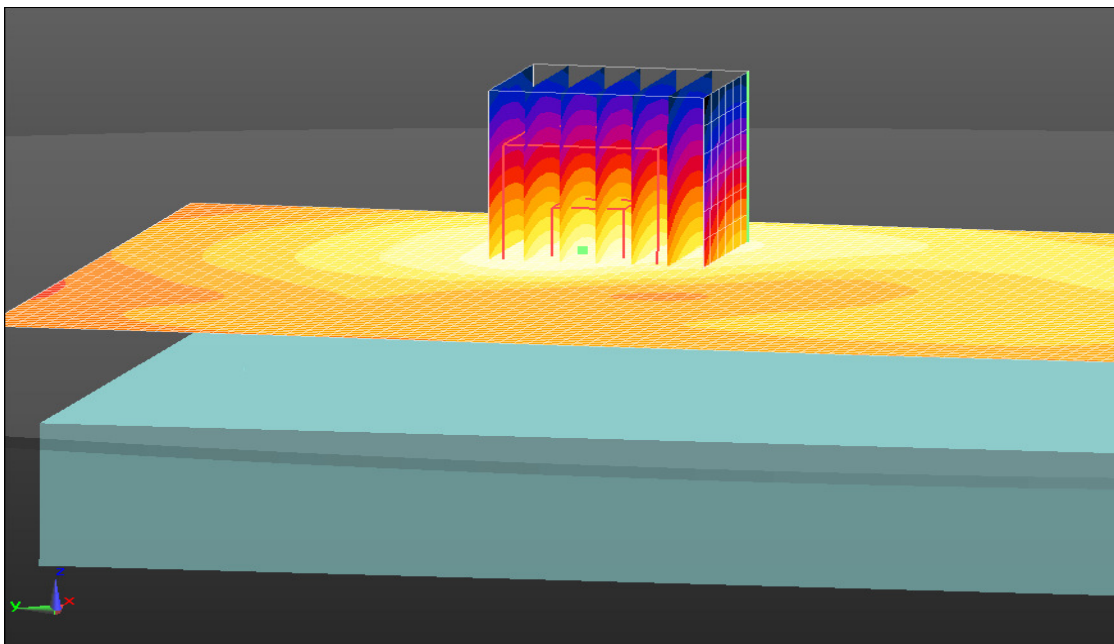

www.tuv.com

Protocol	Band	Channel Frequency (MHz)
W-CDMA	FDD Band 4	1752.6

Temperature of Liquid : 20.2 °C
 Measured Conductivity : 1.392 S/m
 Measured Permittivity : 54.425

Area Scan

Grid Dimension : 131mmX91mmX1mm
 Maximum SAR : 0.738 W/Kg

Zoom Scan

Grid Dimension : 7mmX7mmX7mm
 Power Reference : 7.456 V/m
 Measured SAR : 0.540 W/Kg
 Power Drift : 0.16 dB

Measurement Plot:

EUT Position: Back Face

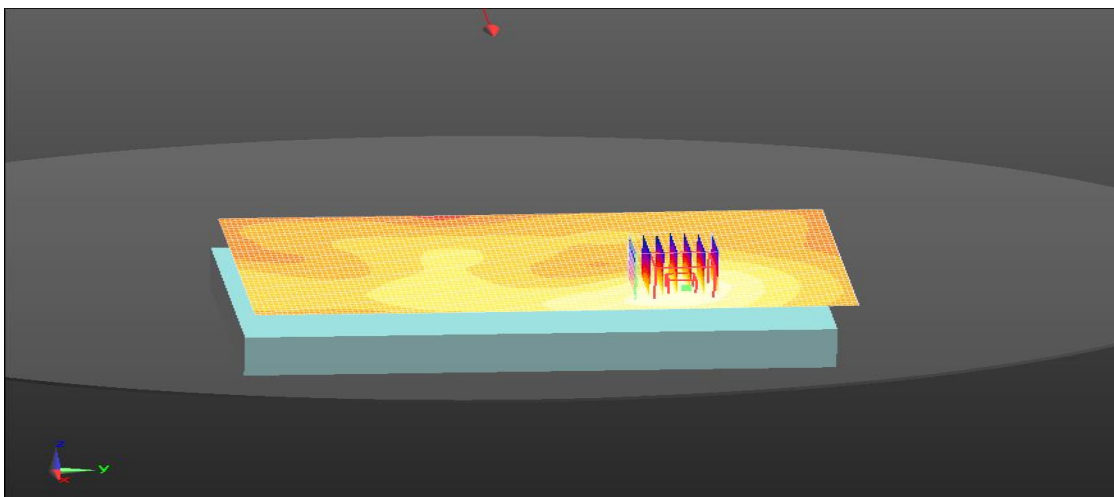

www.tuv.com

Protocol	Band	Channel Frequency (MHz)
W-CDMA	FDD Band 5	826.4

Temperature of Liquid : 20.2 °C
 Measured Conductivity : 0.896 S/m
 Measured Permittivity : 55.403

Area Scan

Grid Dimension : 91mmX91mmX1mm
 Maximum SAR : 0.162 W/Kg

Zoom Scan

Grid Dimension : 7mmX7mmX7mm
 Power Reference : 12.73 V/m
 Measured SAR : 0.130 W/Kg
 Power Drift : 0.39 dB

Measurement Plot:

EUT Position: Edge 1

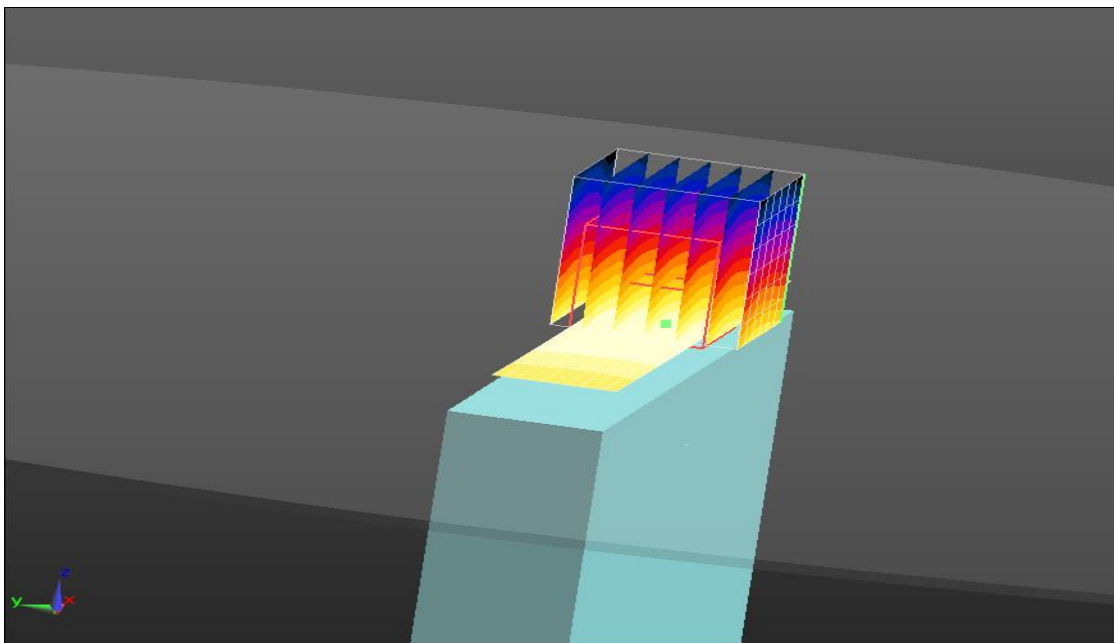

www.tuv.com

Protocol	Band	Channel Frequency (MHz)
W-CDMA	FDD Band 5	836.6

Temperature of Liquid : 20.2 °C
 Measured Conductivity : 0.899 S/m
 Measured Permittivity : 55.379

Area Scan

Grid Dimension : 81mmX91mmX1mm
 Maximum SAR : 0.360 W/Kg

Zoom Scan

Grid Dimension : 7mmX7mmX7mm
 Power Reference : 20.15 V/m
 Measured SAR : 0.348 W/Kg
 Power Drift : 0.39dB

Measurement Plot:

EUT Position: Edge 1

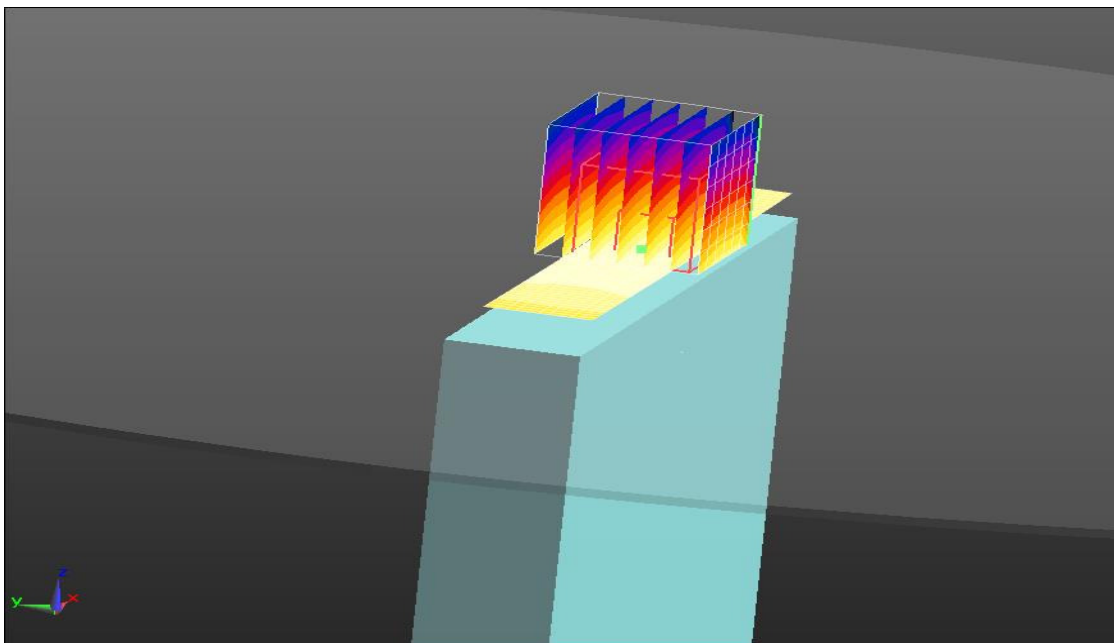

www.tuv.com

Protocol	Band	Channel Frequency (MHz)
W-CDMA	FDD Band 5	846.6

Temperature of Liquid : 20.2 °C
 Measured Conductivity : 0.902 S/m
 Measured Permittivity : 55.355

Area Scan

Grid Dimension : 91mmX91mmX1mm
 Maximum SAR : 0.331 W/Kg

Zoom Scan

Grid Dimension : 8mmX8mmX7mm
 Power Reference : 18.06V/m
 Measured SAR : 0.228 W/Kg
 Power Drift : -0.64dB

Measurement Plot:

EUT Position: Edge 1

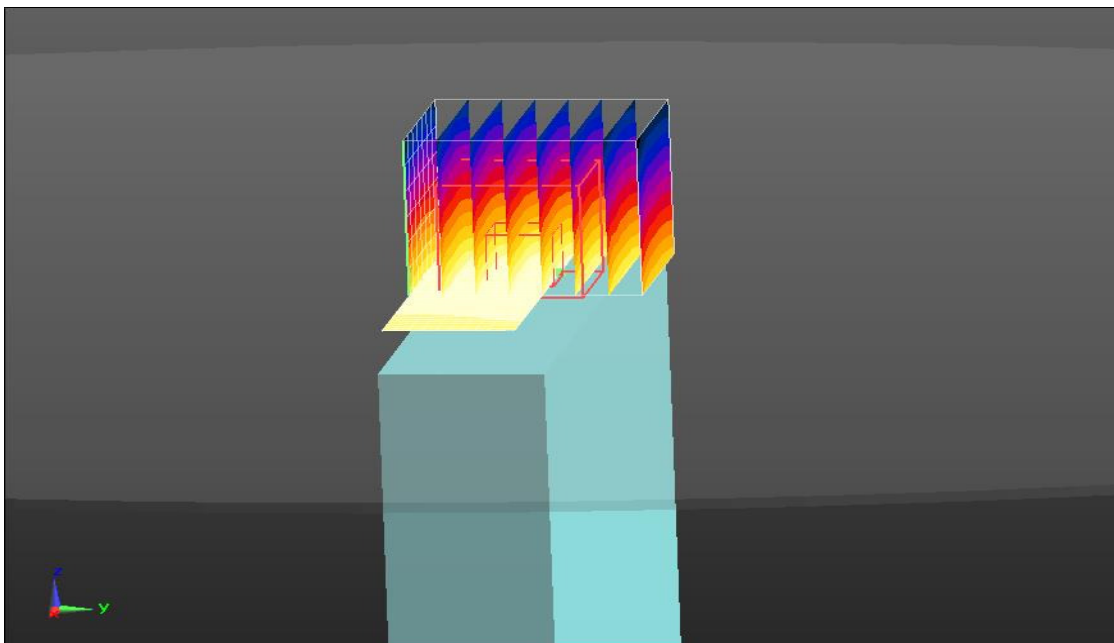

www.tuv.com

Protocol	Band	Channel Frequency (MHz)
W-CDMA	FDD Band 2	1852.4

Temperature of Liquid : 21.6 °C
 Measured Conductivity : 1.422 S/m
 Measured Permittivity : 40.727

Area Scan

Grid Dimension : 131mmX91mmX1mm
 Measured SAR : 1.26 W/Kg

Zoom Scan

Grid Dimension : 7mmX7mmX7mm
 Power Reference : 9.835 V/m
 Maximum SAR : 0.879 W/Kg
 Power Drift : -0.15 dB

Measurement Plot:

EUT Position: Right Touch

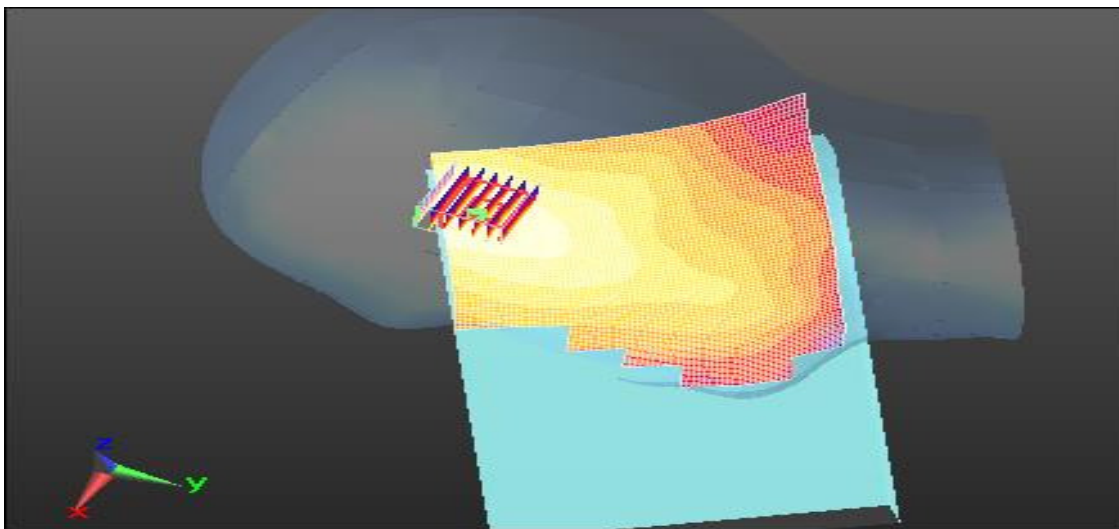

www.tuv.com

Protocol	Band	Channel Frequency (MHz)
W-CDMA	FDD Band 2	1880

Temperature of Liquid : 21.6 °C
 Measured Conductivity : 1.436 S/m
 Measured Permittivity : 40.726

Area Scan

Grid Dimension : 131mmX81mmX1mm
 Maximum SAR : 1.61 W/Kg

Zoom Scan

Grid Dimension : 9mmX8mmX7mm
 Power Reference : 10.04 V/m
 Measured SAR : 1.19 W/Kg
 Power Drift : -0.23dB

Measurement Plot:

EUT Position: Right Touch

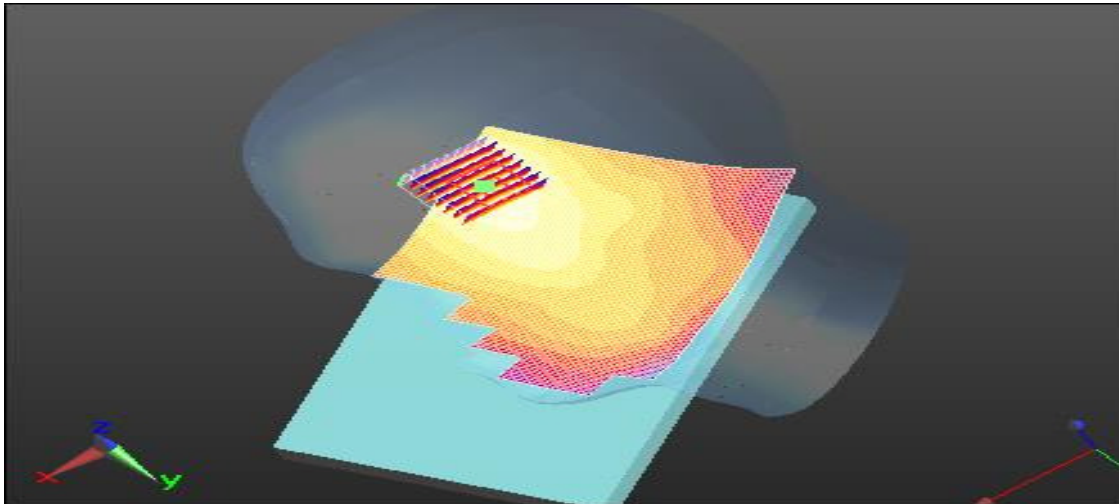

www.tuv.com

Protocol	Band	Channel Frequency (MHz)
W-CDMA	FDD Band 2	1907.6

Temperature of Liquid : 21.6 °C
 Measured Conductivity : 1.45 S/m
 Measured Permittivity : 40.718

Area Scan

Grid Dimension : 131mmX91mmX1mm
 Maximum SAR : 0.901 W/Kg

Zoom Scan

Grid Dimension : 7mmX7mmX7mm
 Power Reference : 9.03 V/m
 Measured SAR : 0.618 W/Kg
 Power Drift : -0.22 dB

Measurement Plot:

EUT Position: Right Touch

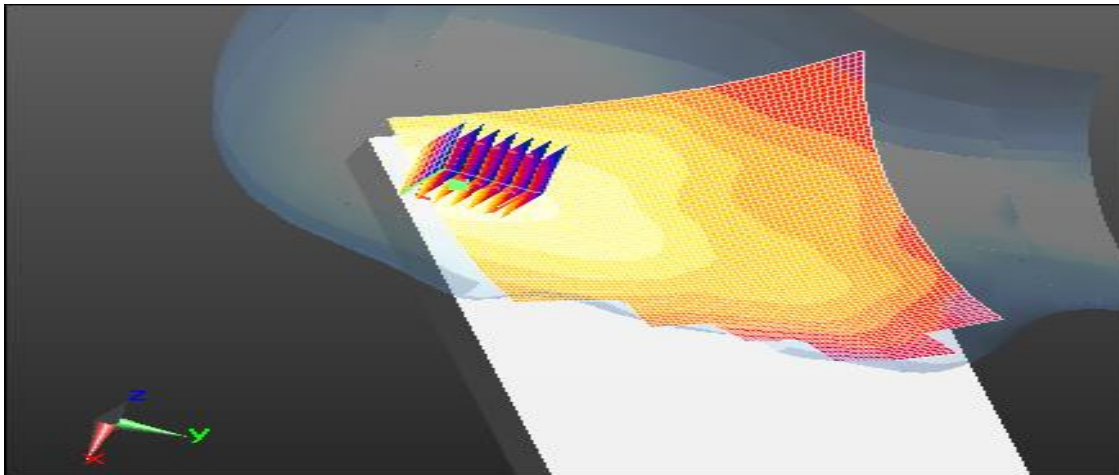

www.tuv.com

Protocol	Band	Channel Frequency (MHz)
W-CDMA	FDD Band 4	1712.4

Temperature of Liquid : 21.6 °C
 Measured Conductivity : 1.339 S/m
 Measured Permittivity : 41

Area Scan

Grid Dimension : 131mmX101mmX1mm
 Maximum SAR : 1.54 W/Kg

Zoom Scan

Grid Dimension : 7mmX8mmX7mm
 Power Reference : 7.256 V/m
 Measured SAR : 1.1 W/Kg
 Power Drift : -0.35 dB

Measurement Plot:

EUT Position: Right Touch

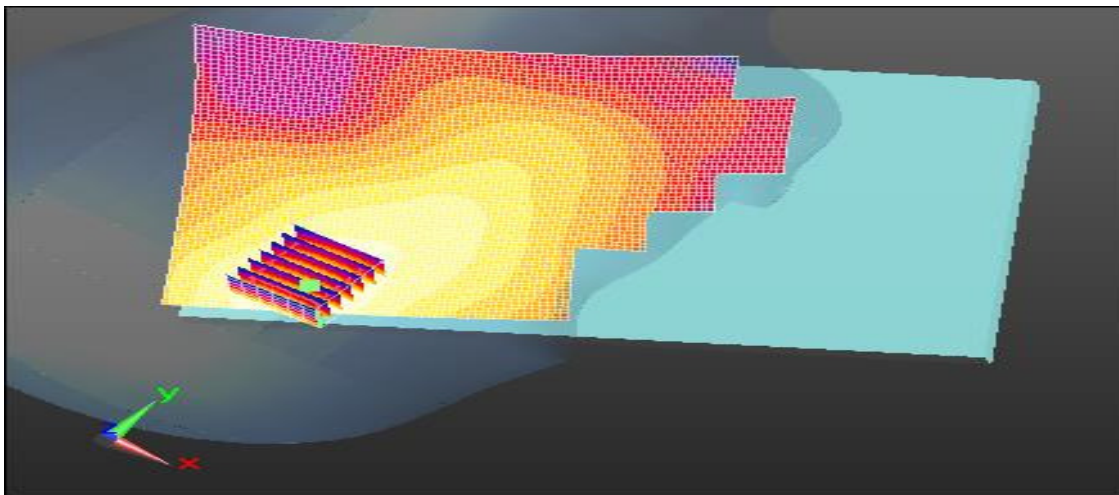

www.tuv.com

Protocol	Band	Channel Frequency (MHz)
W-CDMA	FDD Band 4	1732.6

Temperature of Liquid : 21.6 °C
 Measured Conductivity : 1.35 S/m
 Measured Permittivity : 40.953

Area Scan

Grid Dimension : 131mmX91mmX1mm
 Maximum SAR : 1.28 W/Kg

Zoom Scan

Grid Dimension : 9mmX8mmX7mm
 Power Reference : 7.748 V/m
 Measured SAR : 0.917 W/Kg
 Power Drift : -0.07dB

Measurement Plot:

EUT Position: Right Touch

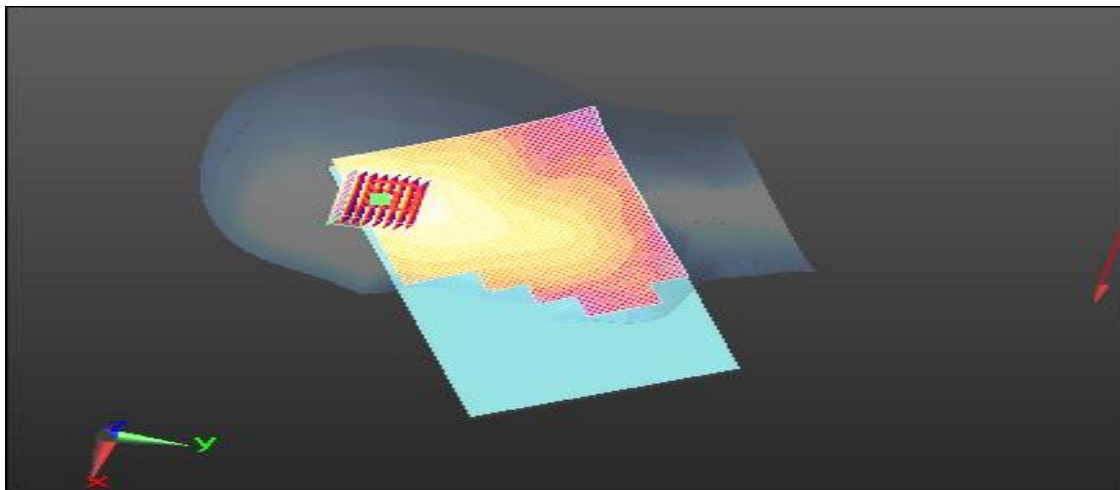

www.tuv.com

Protocol	Band	Channel Frequency (MHz)
W-CDMA	FDD Band 4	1752.6

Temperature of Liquid : 21.6 °C
 Measured Conductivity : 1.362 S/m
 Measured Permittivity : 40.907

Area Scan

Grid Dimension : 41mmX101mmX1mm
 Maximum SAR : 1.20 W/Kg

Zoom Scan

Grid Dimension : 7mmX7mmX7mm
 Power Reference : 7.007 V/m
 Measured SAR : 0.863 W/Kg
 Power Drift : -0.04 dB

Measurement Plot:

EUT Position: Right Touch

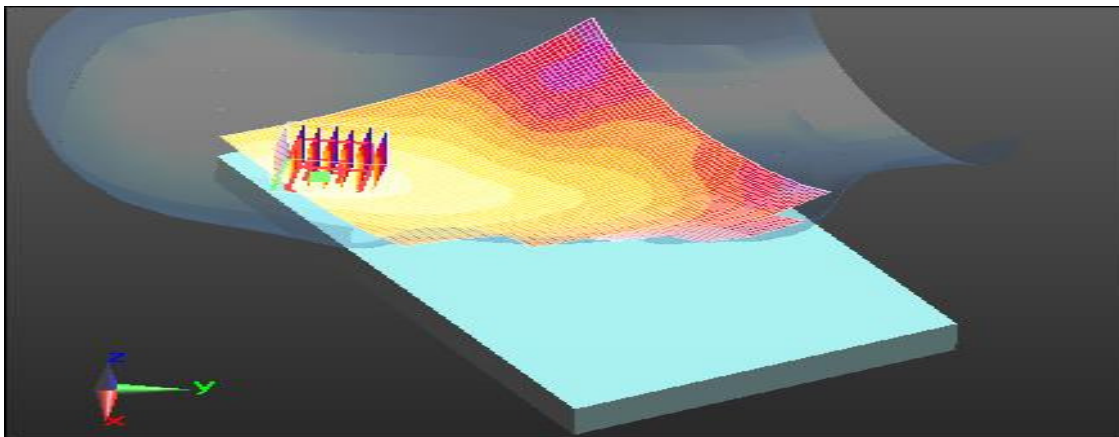

www.tuv.com

Protocol	Band	Channel Frequency (MHz)
W-CDMA	FDD Band 2	826.4

Temperature of Liquid : 21.6 °C
 Measured Conductivity : 0.948 S/m
 Measured Permittivity : 42.935

Area Scan

Grid Dimension : 131mmX101mmX1mm
 Maximum SAR : 0.418 W/Kg

Zoom Scan

Grid Dimension : 7mmX7mmX7mm
 Power Reference : 8.852 V/m
 Measured SAR : 0.333 W/Kg
 Power Drift : -0.20 dB

Measurement Plot:

EUT Position: Right Touch

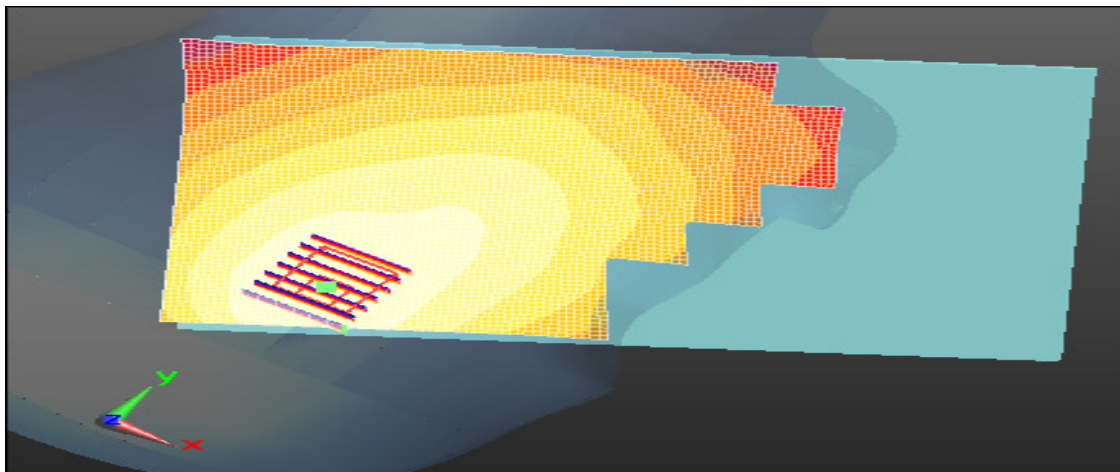

www.tuv.com

Protocol	Band	Channel Frequency (MHz)
W-CDMA	FDD Band 5	836.6

Temperature of Liquid : 21.6 °C
 Measured Conductivity : 0.952 S/m
 Measured Permittivity : 42.88

Area Scan

Grid Dimension : 131mmX91mmX1mm
 Maximum SAR : 0.431 W/Kg

Zoom Scan

Grid Dimension : 9mmX9mmX7mm
 Power Reference : 9.836 V/m
 Measured SAR : 0.667 W/Kg
 Power Drift : -0.09 dB

Measurement Plot:

EUT Position: Right Touch

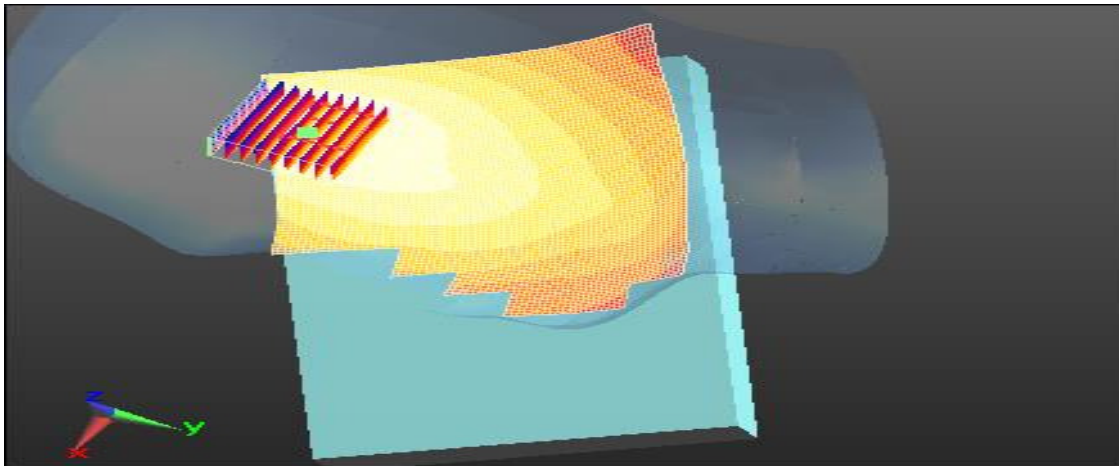

www.tuv.com

Protocol	Band	Channel Frequency (MHz)
W-CDMA	FDD Band 2	846.6

Temperature of Liquid : 21.6 °C
 Measured Conductivity : 0.956 S/m
 Measured Permittivity : 42.842

Area Scan

Grid Dimension : 131mmX101mmX1mm
 Maximum SAR : 0.254 W/Kg

Zoom Scan

Grid Dimension : 7mmX7mmX7mm
 Power Reference : 6.851 V/m
 Measured SAR : 0.201 W/Kg
 Power Drift : -0.19dB

Measurement Plot:

EUT Position: Right Touch

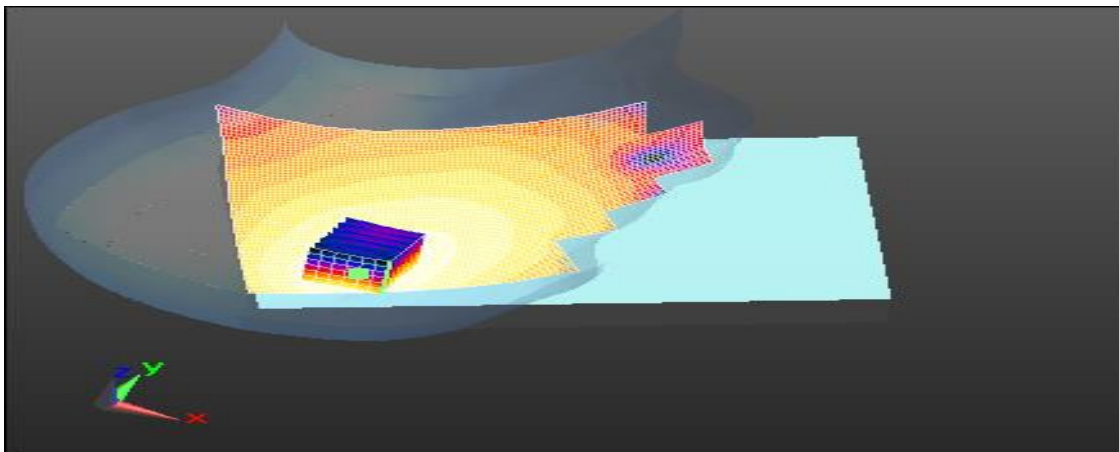

www.tuv.com

Test Result Summary: Wi-Fi & Bluetooth

Band	Channel Frequency (MHz)	Measured Power (dBm)	Measured Power (mW)	Tune-Up Scaling Factor (dB)	Tune-Up Scaling Factor (mW)	Maximum Tune-up Tolerance (mw)	Measured SAR (W/kg)	Reported SAR (W/kg)	Worst Case EUT Position
2.4GHz_ Wi-Fi_Body	2412	13.48	22.28	0.5	1.12	23.41	0.164	0.184	Edge 1
	2437	13.7	23.44	0.5	1.12	24.56	0.291	0.327	Edge 1
	2462	12.9	19.50	0.5	1.12	20.62	0.264	0.296	Edge 1
2.4GHz_ Wi-Fi_Head	2412	13.48	22.28	0.5	1.12	23.41	0.245	0.275	Left Tilt
	2437	13.7	23.44	0.5	1.12	24.56	0.162	0.182	Left Tilt
	2462	12.9	19.50	0.5	1.12	20.62	0.430	0.482	Left Tilt
2.4GHz_Bluetooth_Body	2402	9.11	8.15	0.5	1.12	9.27	0.00693	0.008	Edge 1
	2440	8.42	6.95	0.5	1.12	8.07	0.00735	0.008	Front Face
	2480	7.21	5.26	0.5	1.12	6.38	0.00819	0.009	Edge 1

www.tuv.com

Protocol	Data Rate	Channel Frequency (MHz)
Wi-Fi	1Mbps	2412

Temperature of Liquid : 21.9 °C
 Measured Conductivity : 1.928 S/m
 Measured Permittivity : 53.103

Area Scan

Grid Dimension : 41mmX91mmX1mm
 Maximum SAR : 0.105 W/Kg

Zoom Scan

Grid Dimension : 9mmX10mmX7mm
 Power Reference : 2.569 V/m
 Measured SAR : 0.164 W/Kg
 Power Drift : -0.49 dB

Measurement Plot:

EUT Position: Edge 1

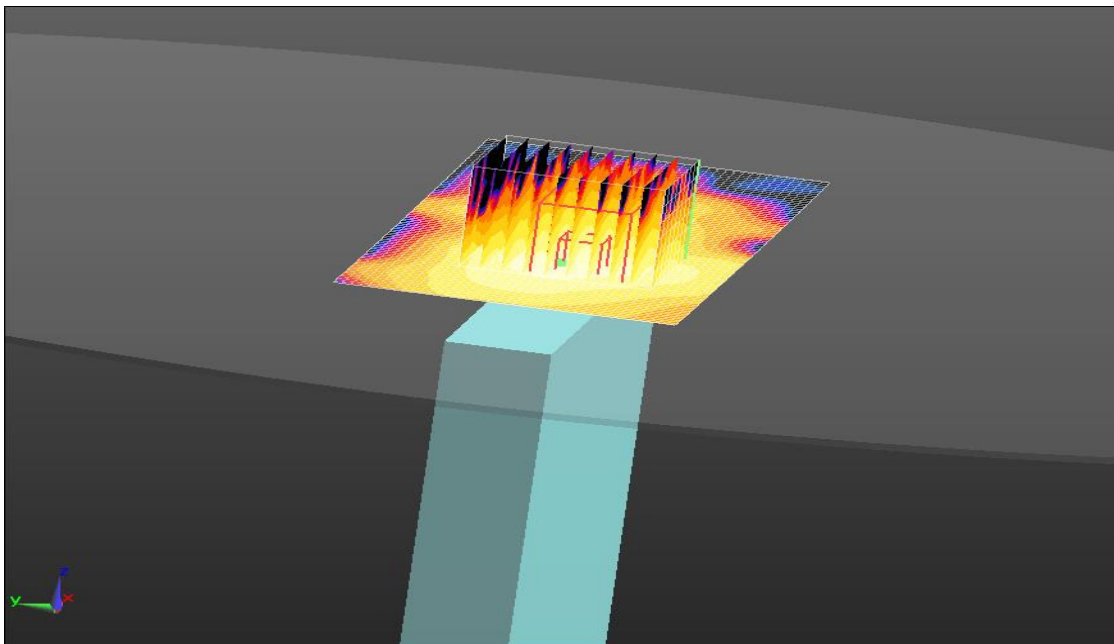

www.tuv.com

Protocol	Data Rate	Channel Frequency (MHz)
Wi-Fi	1Mbps	2442

Temperature of Liquid : 21.9 °C
 Measured Conductivity : 1.951 S/m
 Measured Permittivity : 53.05

Area Scan

Grid Dimension : 41mmX101mmX1mm
 Maximum SAR : 0.489 W/Kg

Zoom Scan

Grid Dimension : 13mmX12mmX7mm
 Power Reference : 4.536 V/m
 Measured SAR : 0.291 W/Kg
 Power Drift : -0.04 dB

Measurement Plot:

EUT Position: Edge 1

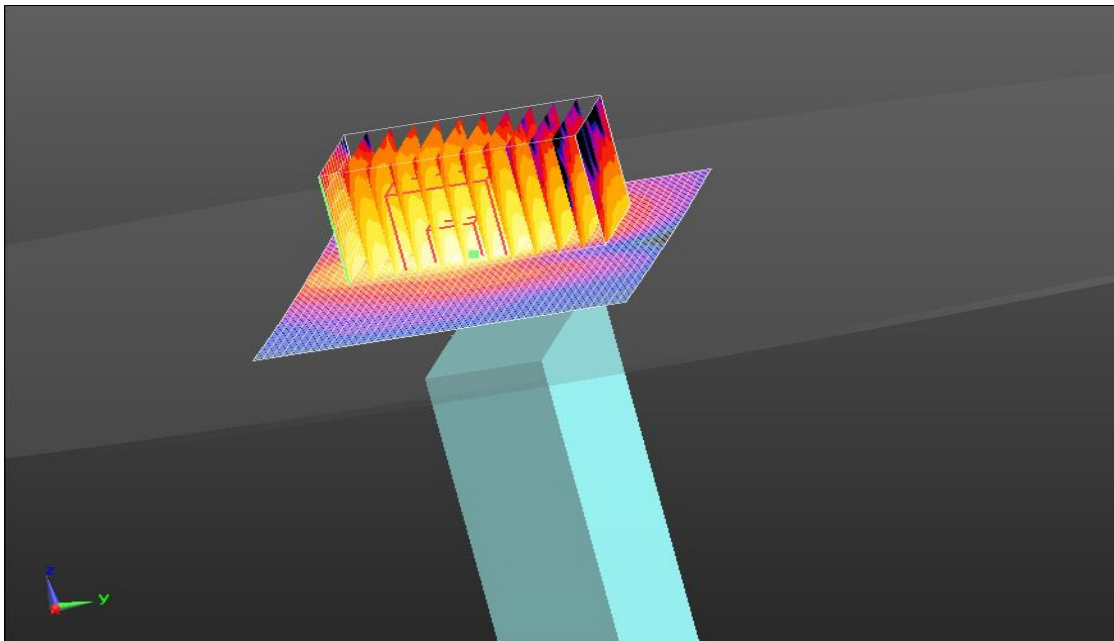

www.tuv.com

Protocol	Data Rate	Channel Frequency (MHz)
Wi-Fi	1Mbps	2462

Temperature of Liquid : 21.9 °C
 Measured Conductivity : 1.968 S/m
 Measured Permittivity : 53.056

Area Scan

Grid Dimension : 41mmX91mmX1mm
 Maximum SAR : 0.459 W/Kg

Zoom Scan

Grid Dimension : 9mmX10mmX7mm
 Power Reference : 4.369 V/m
 Measured SAR : 0.264 W/Kg
 Power Drift : -0.39dB

Measurement Plot:

EUT Position: Edge 1

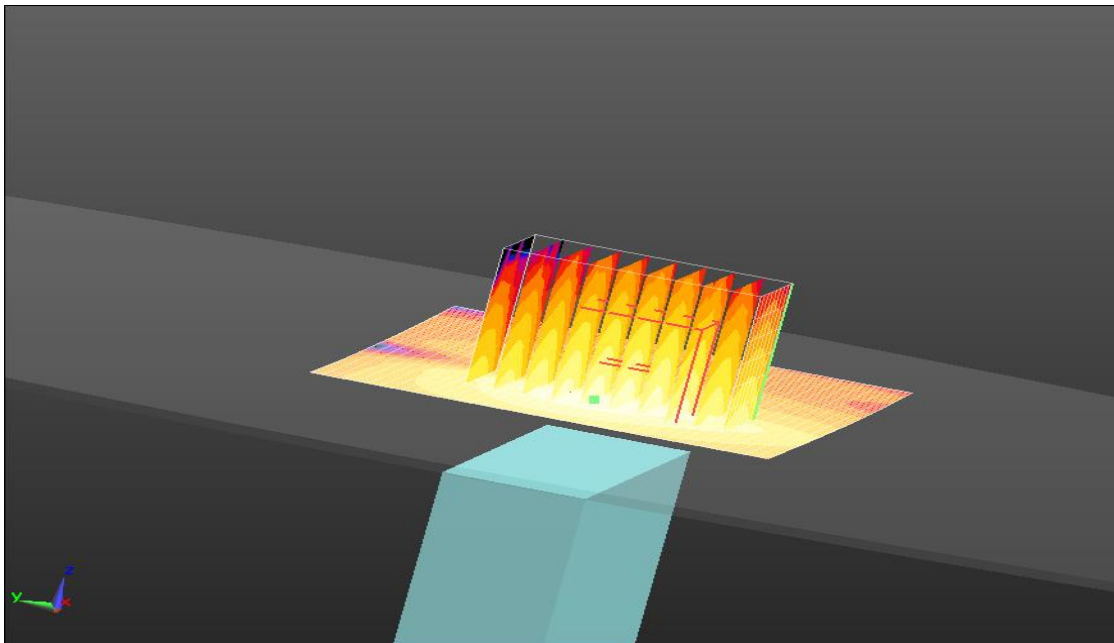

www.tuv.com

Protocol	Data Rate	Channel Frequency (MHz)
Wi-Fi	1Mbps	2412

Temperature of Liquid : 21.6 °C
 Measured Conductivity : 1.828 S/m
 Measured Permittivity : 38.103

Area Scan

Grid Dimension : 131mmX81mmX1mm
 Maximum SAR : 0.465 W/Kg

Zoom Scan

Grid Dimension : 9mmX9mmX7mm
 Power Reference : 9.354 V/m
 Measured SAR : 0.245 W/Kg
 Power Drift : -0.05dB

Measurement Plot:

EUT Position: Left Tilt

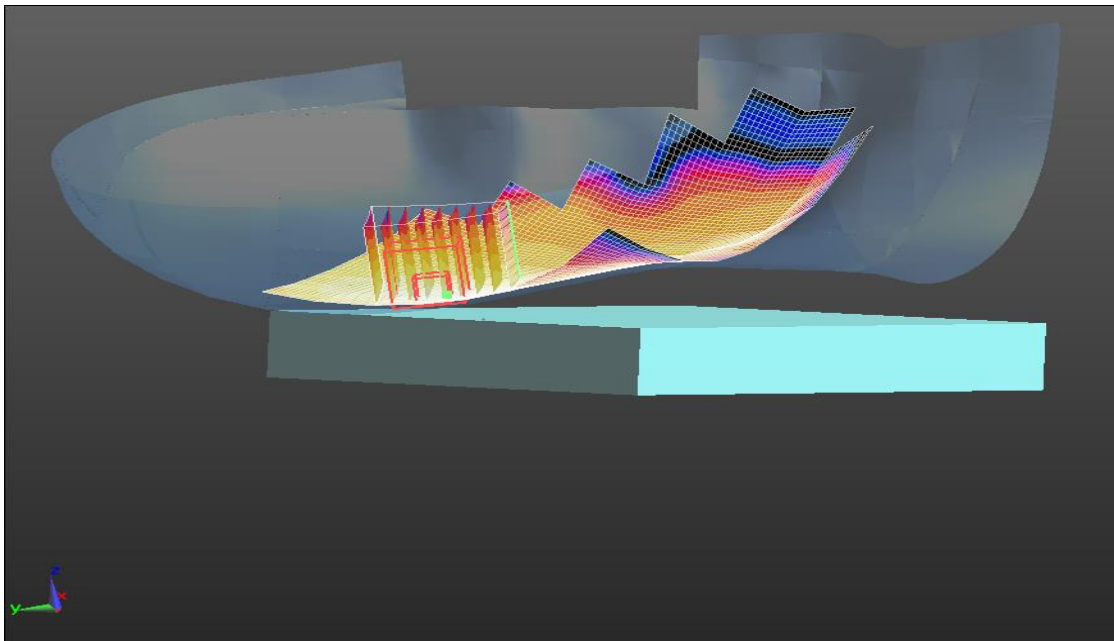

www.tuv.com

Protocol	Data Rate	Channel Frequency (MHz)
Wi-Fi	1Mbps	2442

Temperature of Liquid : 21.6 °C
 Measured Conductivity : 1.851 S/m
 Measured Permittivity : 38.05

Area Scan

Grid Dimension : 251mmX161mmX1mm
 Maximum SAR : 0.349/Kg

Zoom Scan

Grid Dimension : 9mmX8mmX7mm
 Power Reference : 7.222 V/m
 Measured SAR : 0.162 W/Kg
 Power Drift : -0.05 dB

Measurement Plot:

EUT Position: Left Tilt

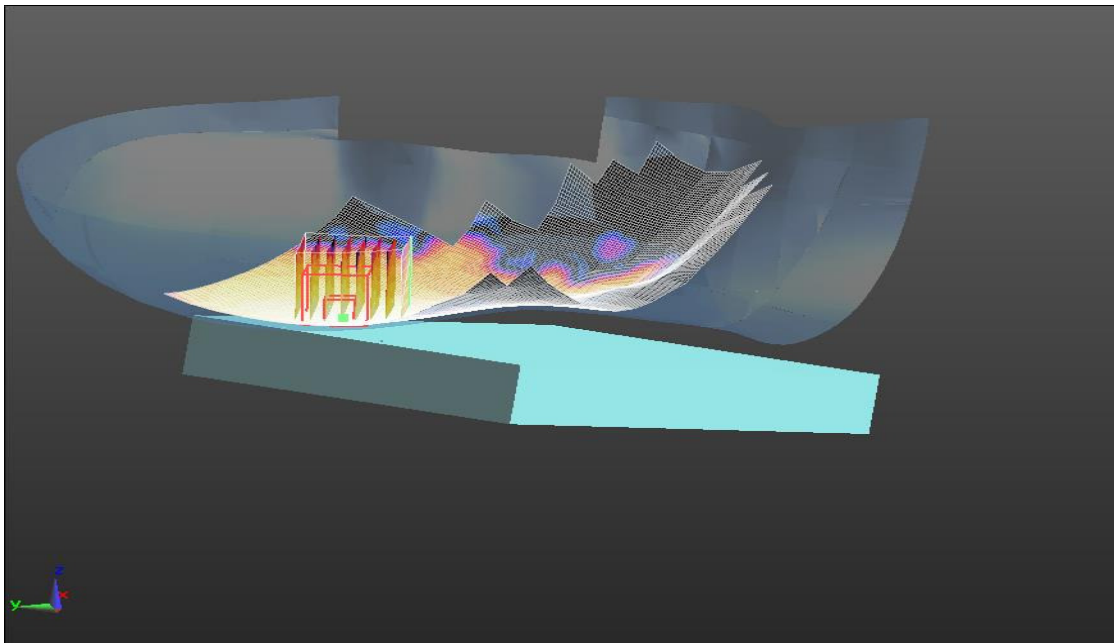

www.tuv.com

Protocol	Data Rate	Channel Frequency (MHz)
Wi-Fi	1Mbps	2462

Temperature of Liquid : 21.6 °C
 Measured Conductivity : 1.868 S/m
 Measured Permittivity : 38.056

Area Scan

Grid Dimension : 131mmX81mmX1mm
 Maximum SAR : 0.764/Kg

Zoom Scan

Grid Dimension : 9mmX9mmX7mm
 Power Reference : 11.78 V/m
 Measured SAR : 0.430 W/Kg
 Power Drift : -0.15 dB

Measurement Plot:

EUT Position: Left Tilt

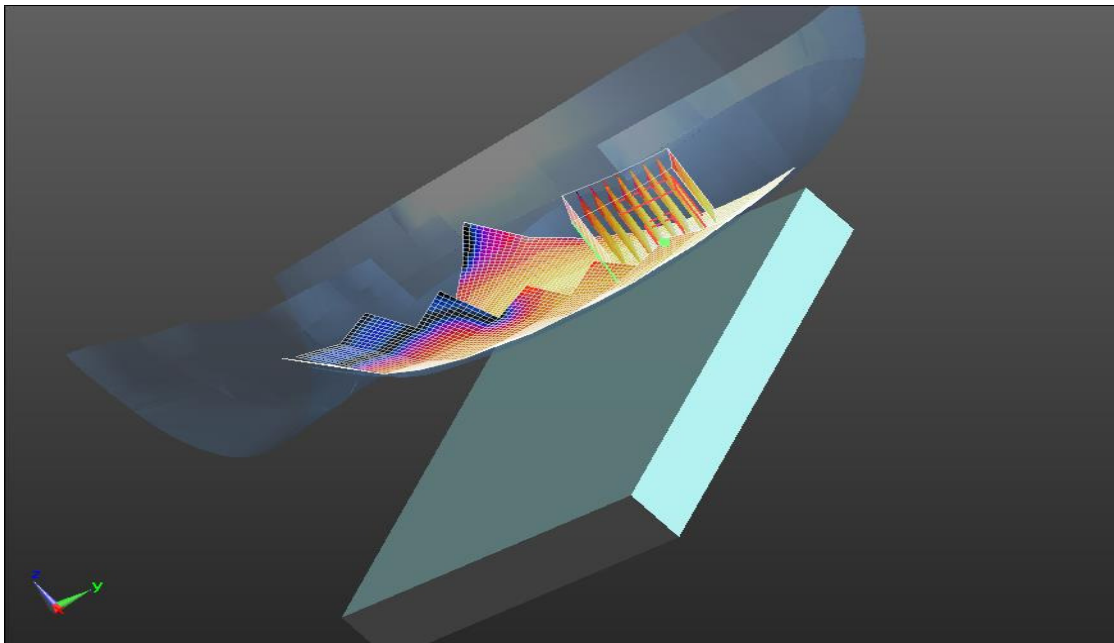

www.tuv.com

Protocol	Data Rate	Channel Frequency (MHz)
Bluetooth	1Mbps	2402

Temperature of Liquid : 22.3 °C
 Measured Conductivity : 1.90 S/m
 Measured Permittivity : 51.841

Area Scan

Grid Dimension : 111mmX91mmX1mm
 Maximum SAR : 0.00733 W/Kg

Zoom Scan

Grid Dimension : 9mmX9mmX7mm
 Power Reference : 1.454 V/m
 Measured SAR : 0.00686 W/Kg
 Power Drift : -0.21 dB

Measurement Plot:

EUT Position: Edge 1

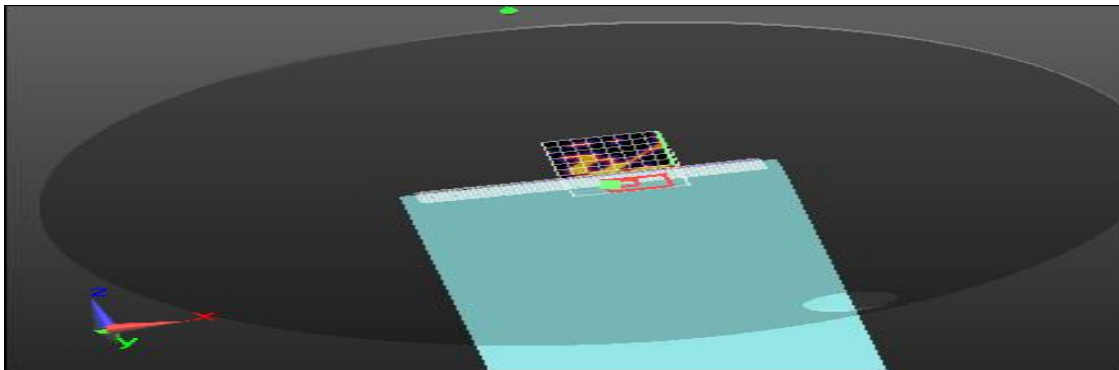

www.tuv.com

Protocol	Data Rate	Channel Frequency (MHz)
Bluetooth	1Mbps	2441

Temperature of Liquid : 22.3 °C
 Measured Conductivity : 1.93 S/m
 Measured Permittivity : 51.737

Area Scan

Grid Dimension : 131mmX91mmX1mm
 Maximum SAR : 0.0271/Kg

Zoom Scan

Grid Dimension : 10mmX10mmX7mm
 Power Reference : 1.850 V/m
 Measured SAR : 0.00735 W/Kg
 Power Drift : -0.47 dB

Measurement Plot:

EUT Position: Front Face

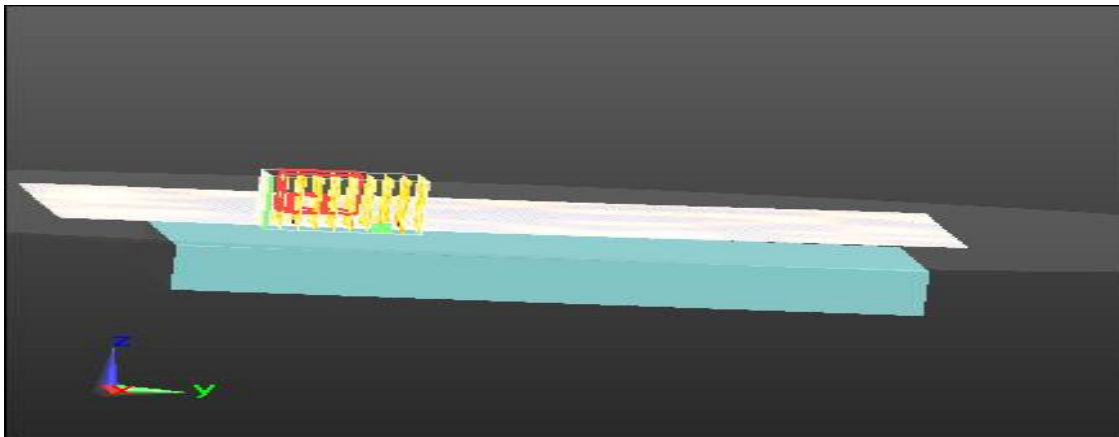

www.tuv.com

Protocol	Data Rate	Channel Frequency (MHz)
Bluetooth	1Mbps	2480

Temperature of Liquid : 22.3 °C
 Measured Conductivity : 1.97 S/m
 Measured Permittivity : 51.731

Area Scan

Grid Dimension : 101mmX91mmX1mm
 Maximum SAR : 0.0170/Kg

Zoom Scan

Grid Dimension : 9mmX9mmX7mm
 Power Reference : 0.7420 V/m
 Measured SAR : 0.00819 W/Kg
 Power Drift : 0.24 dB

Measurement Plot:

EUT Position: Edge 1

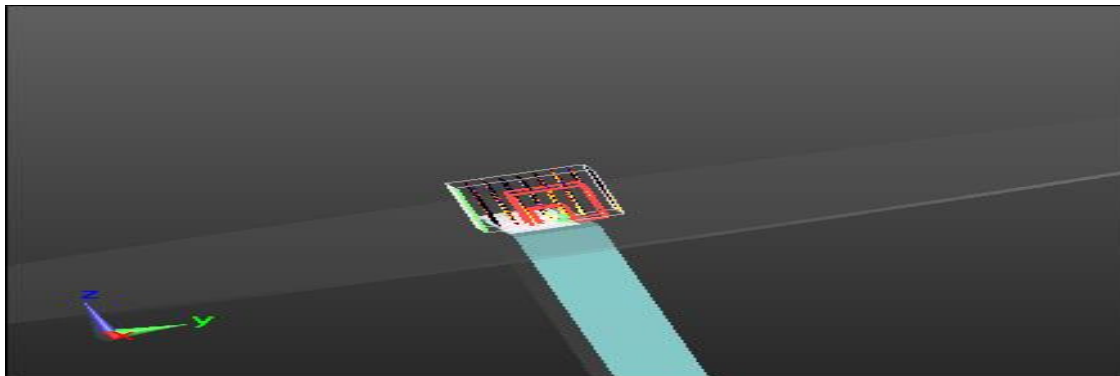

Test Result Summary: LTE

Band	Channel Frequency (MHz)	Measured Power (dBm)	Measured Power (mW)	Tune-Up Scaling Factor (dB)	Tune-Up Scaling Factor (mW)	Maximum Tune-up Tolerance (mw)	Measured SAR (W/kg)	Reported SAR (W/kg)	Worst Case EUT Position
LTE Band 2_Body	1860	21.42	138.68	0.5	1.12	139.80	0.368	0.413	Edge 1
	1880	21.93	155.96	0.5	1.12	157.08	0.343	0.385	Edge 1
	1900	21.74	149.28	0.5	1.12	150.40	0.267	0.300	Edge 1
LTE Band 4_Body	1712.5	21.37	137.09	1.2	1.32	138.41	0.366	0.482	Edge 2
	1732.5	21.84	152.76	1.2	1.32	154.07	0.432	0.569	Edge 2
	1752.5	21.52	141.91	1.2	1.32	143.22	0.377	0.497	Edge 2
LTE Band 5_Body	829	21.56	143.22	0.6	1.15	144.37	0.319	0.366	Edge 1
	836.5	21.36	136.77	0.6	1.15	137.92	0.305	0.350	Edge 1
	844	21.62	145.21	0.6	1.15	146.36	0.208	0.239	Edge 1
LTE Band 17_Body	710	22.25	167.88	0.6	1.15	169.03	0.257	0.295	Edge1
LTE Band 13_Body	782	21.99	158.12	0.03	1.01	159.13	0.342	0.366	Edge2

Note: SAR verified with 1RB, 50% RB & 100%RB with all supporting bandwidths & modulations on low, mid & high channels and Worst case results are reported for the LTE bands

www.tuv.com

Protocol	Bandwidth (MHz)	Channel Frequency (MHz)
LTE FDD Band 2	20	1860

Temperature of Liquid : 20.3 °C
 Measured Conductivity : 1.482 S/m
 Measured Permittivity : 54.031

Area Scan

Grid Dimension : 61mmX131mmX1mm
 Maximum SAR : 0.430 W/Kg

Zoom Scan

Grid Dimension : 8mmX9mmX7mm
 Power Reference : 10.48 V/m
 Measured SAR : 0.368 W/Kg
 Power Drift : -0.19 dB

Measurement Plot:

EUT Position: Edge 1

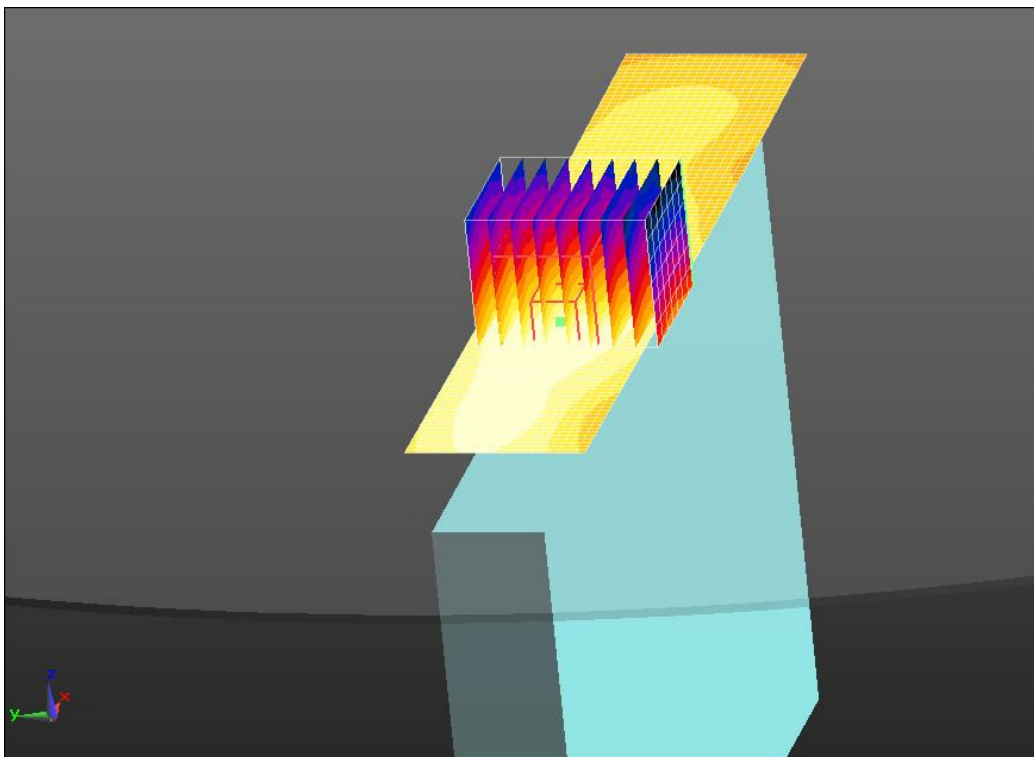

www.tuv.com

Protocol	Bandwidth (MHz)	Channel Frequency (MHz)
LTE_FDD Band 2	20	1880

Temperature of Liquid : 20.3 °C
 Measured Conductivity : 1.476 S/m
 Measured Permittivity : 53.994

Area Scan

Grid Dimension : 61mmX131mmX1mm
 Maximum SAR : 0.468W/Kg

Zoom Scan

Grid Dimension : 8mmX8mmX7mm
 Power Reference : 9.741 V/m
 Measured SAR : 0.343 W/Kg
 Power Drift : -0.35 dB

Measurement Plot:

EUT Position: Edge 1

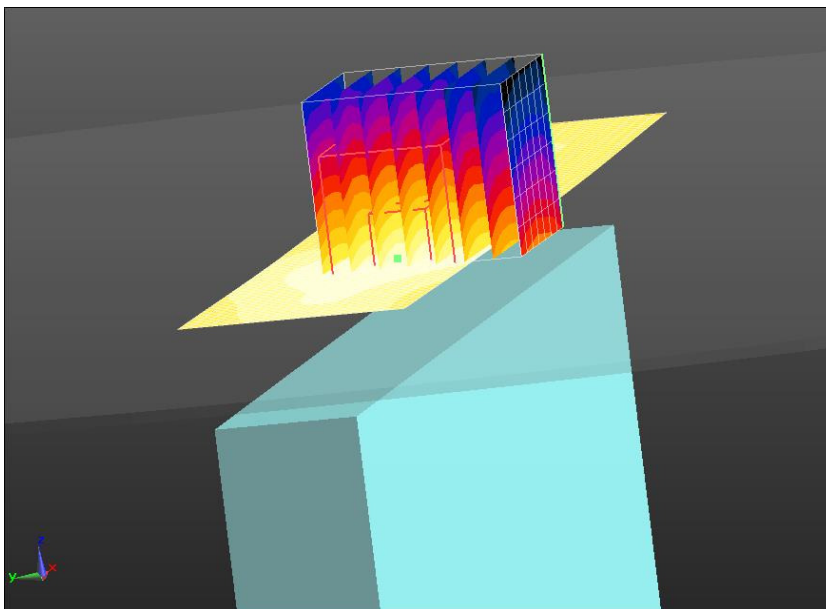

www.tuv.com

Protocol	Bandwidth (MHz)	Channel Frequency (MHz)
LTE FDD Band 2	20	1900

Temperature of Liquid : 20.3 °C
 Measured Conductivity : 1.45 S/m
 Measured Permittivity : 54.188

Area Scan

Grid Dimension : 61mmX131mmX1mm
 Maximum SAR : 0.377 W/Kg

Zoom Scan

Grid Dimension : 8mmX9mmX7mm
 Power Reference : 9.984 V/m
 Measured SAR : 0.267 W/Kg
 Power Drift : 0.10 dB

Measurement Plot:

EUT Position: Edge 1

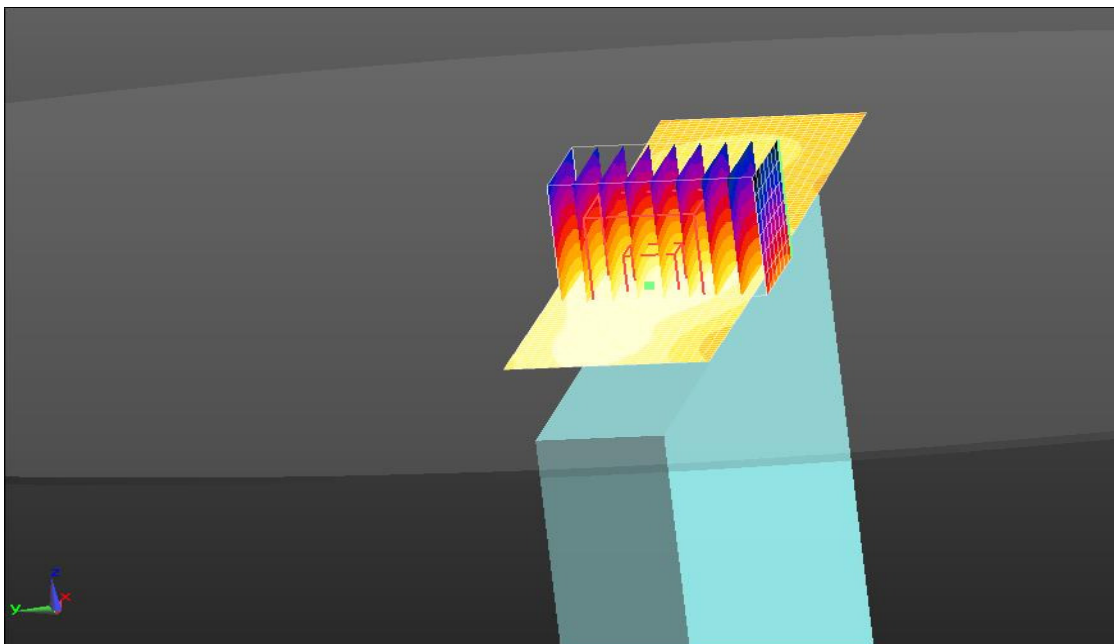

www.tuv.com

Protocol	Bandwidth (MHz)	Channel Frequency (MHz)
LTE_FDD Band 4	5	1712.5

Temperature of Liquid : 20.3 °C
 Measured Conductivity (σ) : 1.402 S/m
 Measured Permittivity (ϵ_r) : 54.214

Area Scan

Grid Dimension : 61mmX131mmX1mm
 Maximum SAR : 0.541 W/Kg

Zoom Scan

Grid Dimension : 8mmX9mmX7mm
 Power Reference : 8.447 V/m
 Measured SAR : 0.366 W/Kg
 Power Drift : -0.03 dB

Measurement Plot:

EUT Position: Edge 2

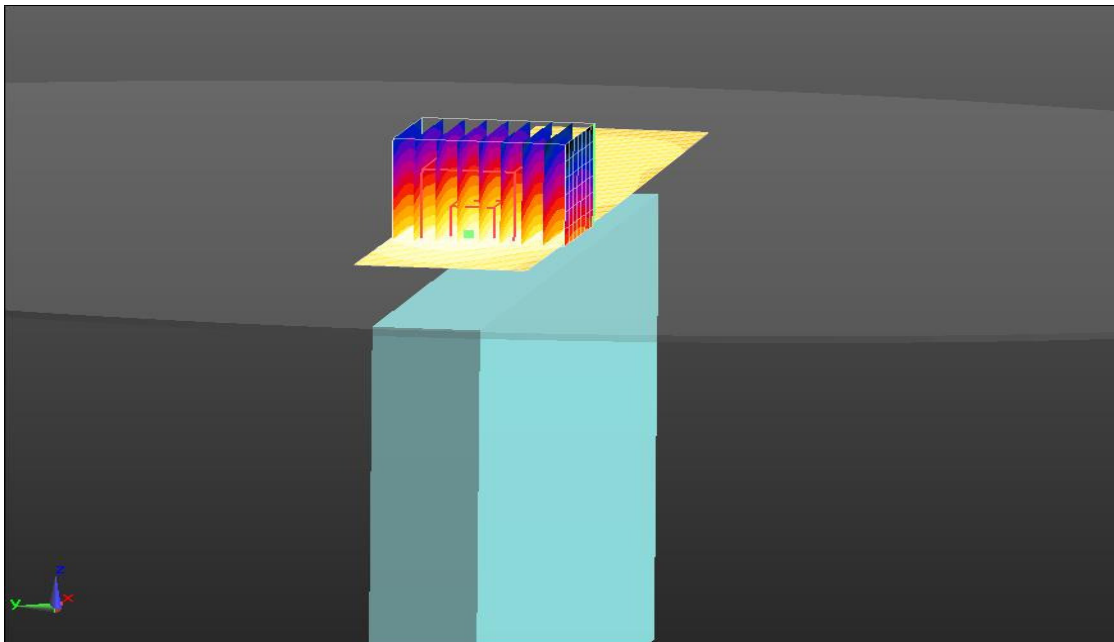

www.tuv.com

Protocol	Bandwidth (MHz)	Channel Frequency (MHz)
LTE_FDD Band 4	5	1732.5

Temperature of Liquid : 20.3 °C
 Measured Conductivity (σ) : 1.416 S/m
 Measured Permittivity (ϵ_r) : 54.195

Area Scan

Grid Dimension : 61mmX131mmX1mm
 Maximum SAR : 0.620 W/Kg

Zoom Scan

Grid Dimension : 8mmX8mmX7mm
 Power Reference : 7.973 V/m
 Measured SAR : 0.432 W/Kg
 Power Drift : 0.01 dB

Measurement Plot:

EUT Position: Edge 2

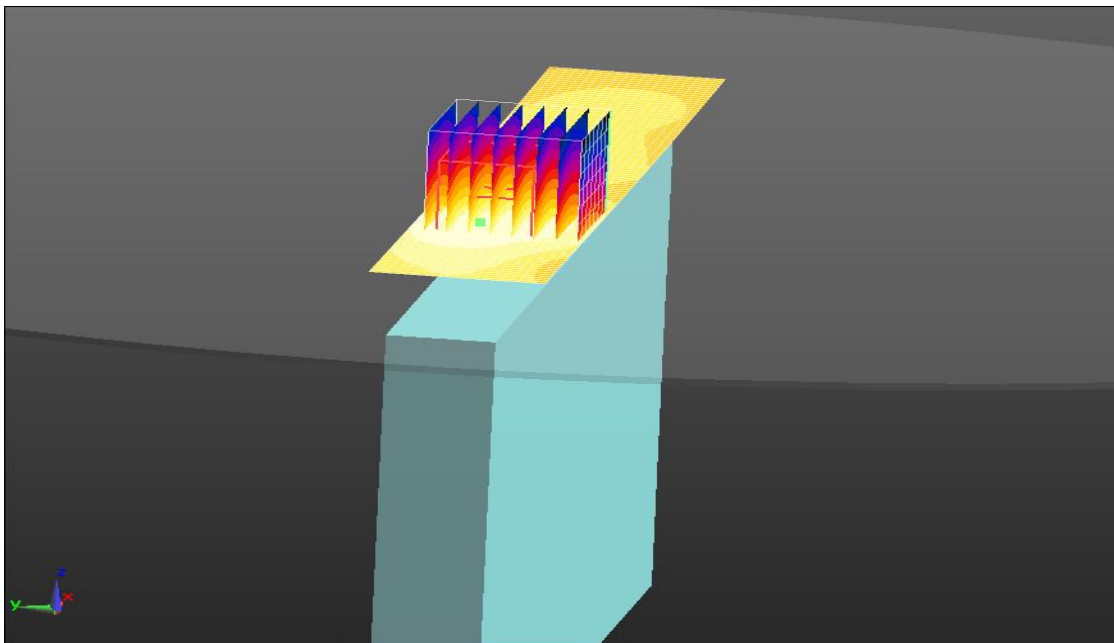

www.tuv.com

Protocol	Bandwidth (MHz)	Channel Frequency (MHz)
LTE_FDD Band 4	5	1752.5

Temperature of Liquid : 20.3 °C
 Measured Conductivity (σ) : 1.431 S/m
 Measured Permittivity (ϵ_r) : 54.179

Area Scan

Grid Dimension : 61mmX131mmX1mm
 Maximum SAR : 0.545 W/Kg

Zoom Scan

Grid Dimension : 8mmX8mmX7mm
 Power Reference : 6.597 V/m
 Measured SAR : 0.377 W/Kg
 Power Drift : -0.07 dB

Measurement Plot:

EUT Position: Edge 2

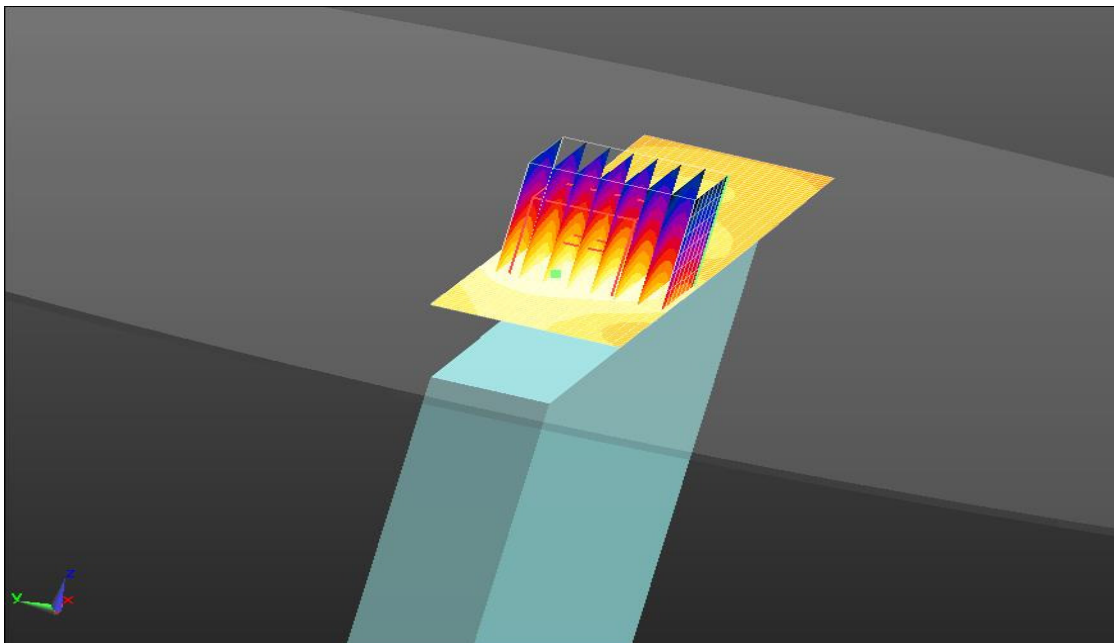

www.tuv.com

Protocol	Bandwidth (MHz)	Channel Frequency (MHz)
LTE FDD Band 5	10	829

Temperature of Liquid : 20.3 °C
 Measured Conductivity : 0.942 S/m
 Measured Permittivity : 55.534

Area Scan

Grid Dimension : 101mmX91mmX1mm
 Maximum SAR : 0.303 W/Kg

Zoom Scan

Grid Dimension : 9mmX8mmX7mm
 Power Reference : 16.73 V/m
 Measured SAR : 0.319 W/Kg
 Power Drift : -0.39 dB

Measurement Plot:

EUT Position: Edge 1

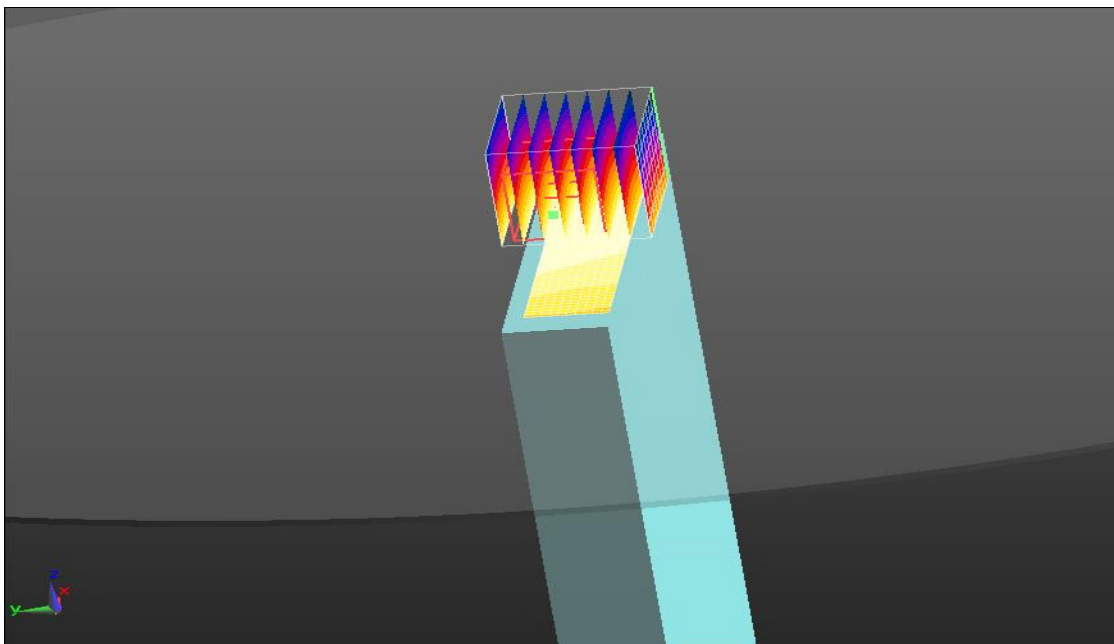

www.tuv.com

Protocol	Bandwidth (MHz)	Channel Frequency (MHz)
LTE FDD Band 5	10	836.5

Temperature of Liquid : 20.3 °C
 Measured Conductivity : 0.945 S/m
 Measured Permittivity : 55.508

Area Scan

Grid Dimension : 91mmX91mmX1mm
 Maximum SAR : 0.403 W/Kg

Zoom Scan

Grid Dimension : 8mmX7mmX7mm
 Power Reference : 20.93 V/m
 Measured SAR : 0.305 W/Kg
 Power Drift : -0.28 dB

Measurement Plot:

EUT Position: Edge 1

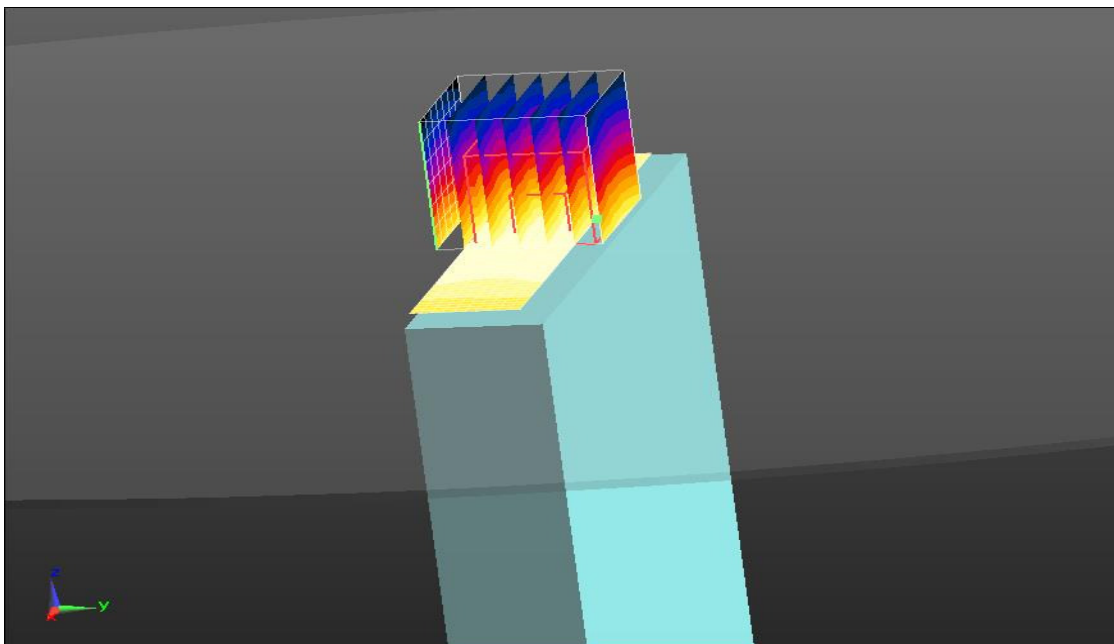

www.tuv.com

Protocol	Bandwidth (MHz)	Channel Frequency (MHz)
LTE FDD Band 5	10	844

Temperature of Liquid : 20.3 °C
 Measured Conductivity : 0.948 S/m
 Measured Permittivity : 55.483

Area Scan

Grid Dimension : 101mmX91mmX1mm
 Maximum SAR : 0.294W/Kg

Zoom Scan

Grid Dimension : 9mmX8mmX7mm
 Power Reference : 16.25 V/m
 Measured SAR : 0.208 W/Kg
 Power Drift : -0.07 dB

Measurement Plot:

EUT Position: Edge 1

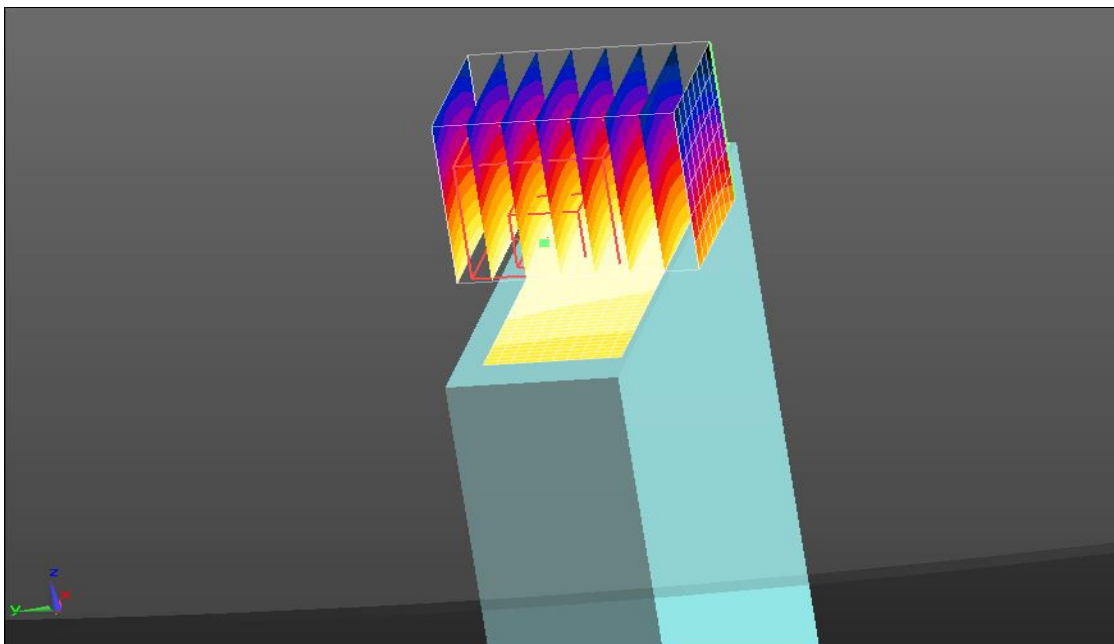

www.tuv.com

Protocol	Bandwidth (MHz)	Channel Frequency (MHz)
LTE_FDD Band 17	10	710

Temperature of Liquid : 22.5 °C
 Measured Conductivity : 0.9516 S/m
 Measured Permittivity : 54.3071

Area Scan

Grid Dimension : 41mmX141mmX1mm
 Maximum SAR : 0.269W/Kg

Zoom Scan

Grid Dimension : 7mmX7mmX7mm
 Power Reference : 12.3 V/m
 Measured SAR : 0.257 W/Kg
 Power Drift : -0.063 dB

Measurement Plot:

EUT Position: Edge 1

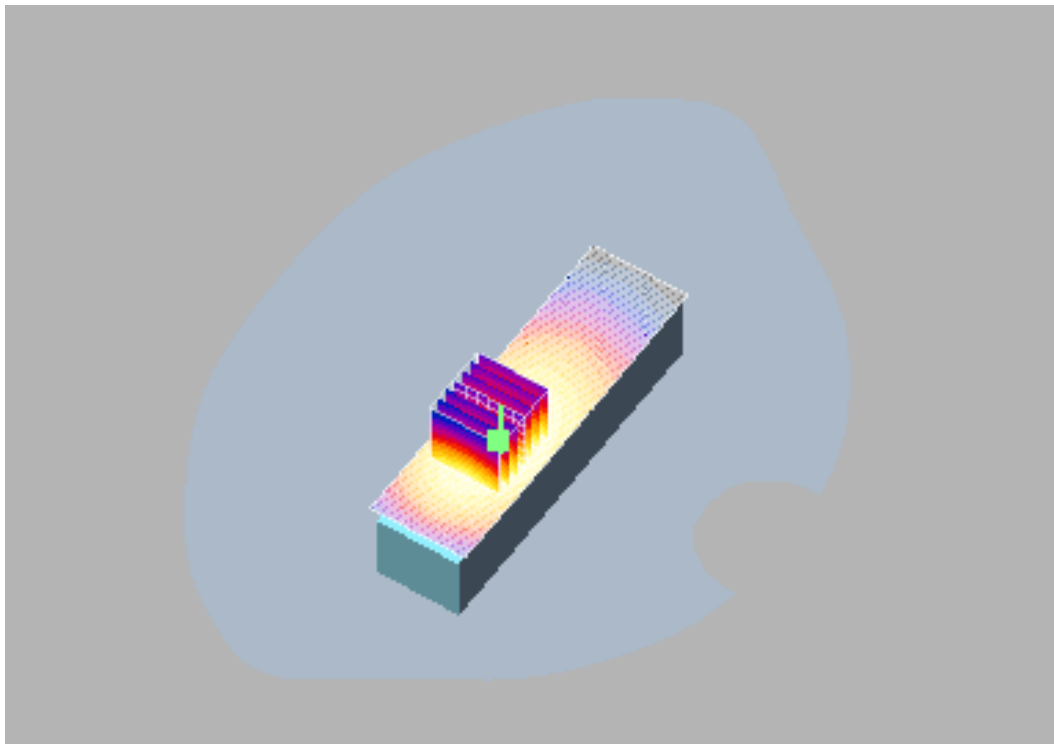

www.tuv.com

Protocol	Bandwidth (MHz)	Channel Frequency (MHz)
LTE_FDD Band 17	5	710

Temperature of Liquid : 22.5 °C
 Measured Conductivity : 0.9516 S/m
 Measured Permittivity : 54.3071

Area Scan

Grid Dimension : 41mmX141mmX1mm
 Maximum SAR : 0.218W/Kg

Zoom Scan

Grid Dimension : 7mmX7mmX7mm
 Power Reference : 11.2 V/m
 Measured SAR : 0.209 W/Kg
 Power Drift : -0.114 dB

Measurement Plot:

EUT Position: Edge 1

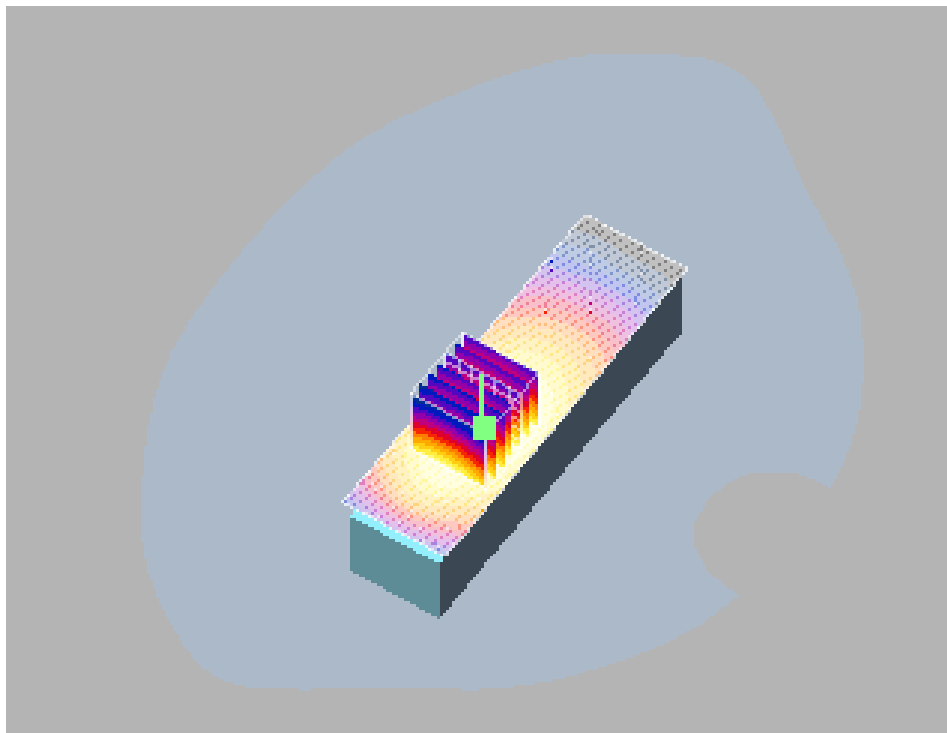

www.tuv.com

Protocol	Bandwidth (MHz)	Channel Frequency (MHz)
LTE_FDD Band 13	10	782

Temperature of Liquid : 22.5 °C
 Measured Conductivity : 0.973 S/m
 Measured Permittivity : 54.52

Area Scan

Grid Dimension : 41mmX141mmX1mm
 Maximum SAR : 0.354W/Kg

Zoom Scan

Grid Dimension : 7mmX7mmX7mm
 Power Reference : 16.82 V/m
 Measured SAR : 0.342 W/Kg
 Power Drift : -0.15 dB

Measurement Plot:

EUT Position: Edge 1

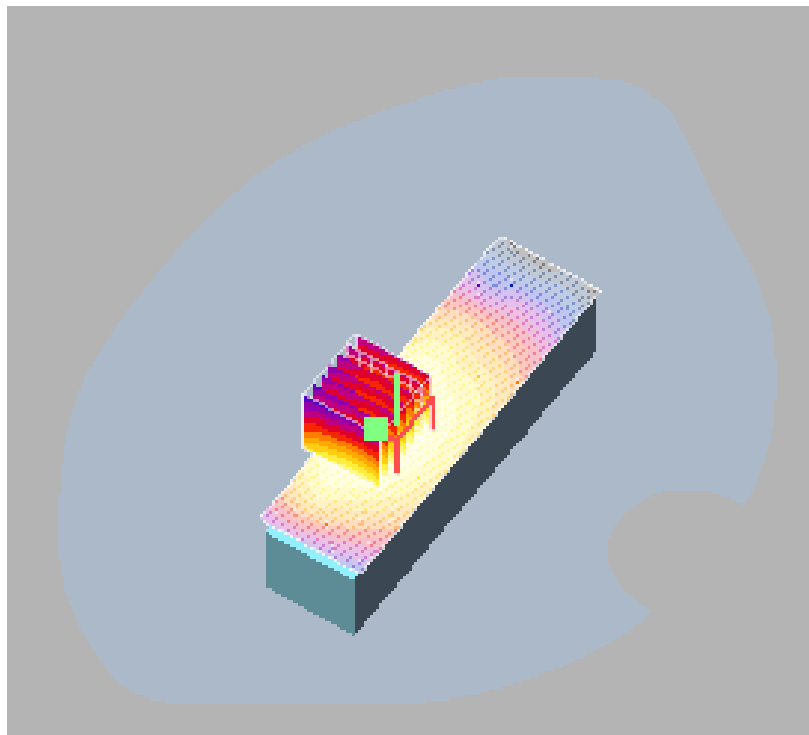

www.tuv.com

SAR Test Result for the Barcode module removed from the Tablet:

Note: Test result for worst case configuration is listed below.

Summary of Test Results: GSM

Band	Channel Frequency (MHz)	Measured Power (mW)	Tune-Up Scaling Factor (dB)	Tune – Up Scaling Factor (mW)	Maximum Tune –Up Tolerance in (mW)	Measured SAR (W/kg)	Reported SAR (W/kg)	Worst Case EUT Position
GSM 850_Head	848.8	1386.76	0.5	1.12	1555.97	0.383	0.430	Right Touch
GSM 850_Body	848.8	1386.76	0.5	1.12	1555.97	0.156	0.175	Edge 1
PCS1900_Head	1850.2	548.28	0.3	1.07	587.49	0.335	0.359	Right Touch
PCS1900_Body	1850.2	548.28	0.3	1.07	587.49	0.148	0.159	Front Face

Note: Maximum output power was observed in voice mode hence SAR tests are performed for the same mode.

www.tuv.com

Protocol	Band	Channel Frequency (MHz)
GSM	GSM850	848.8

Temperature of Liquid : 22.4 °C
 Measured Conductivity : 0.941 S/m
 Measured Permittivity : 43.07

Area Scan

Grid Dimension : 121mmX111mmX1mm
 Maximum SAR : 0.402 W/Kg

Zoom Scan

Grid Dimension : 7mmX7mmX7mm
 Power Reference : 11.5 V/m
 Measured SAR : 0.383 W/Kg
 Power Drift : 0.041 dB

Measurement Plot:

EUT Position: Right Touch

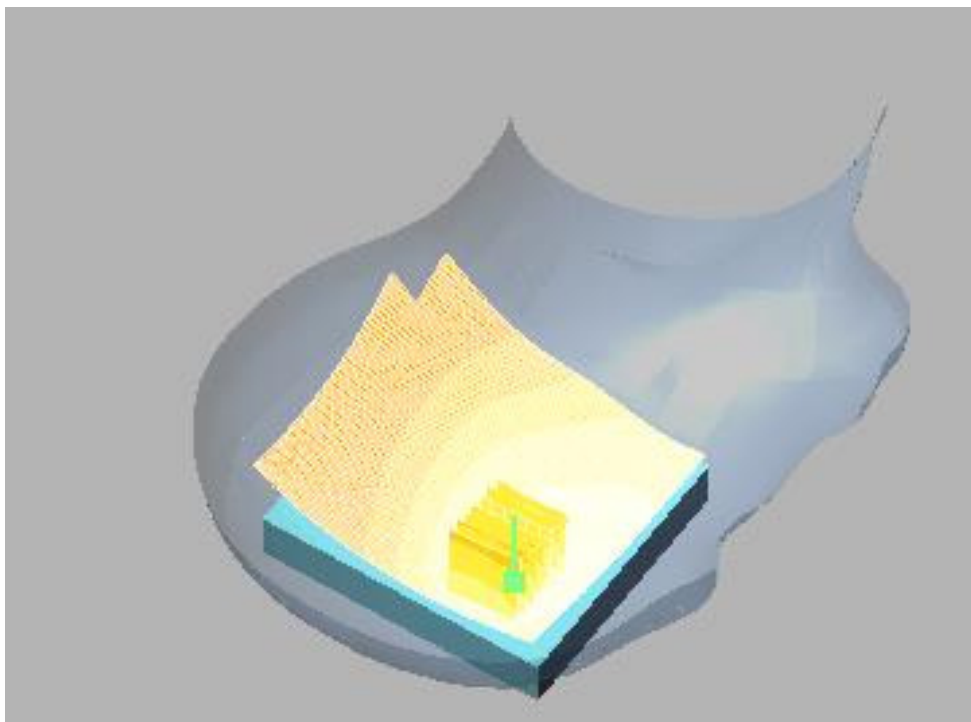

www.tuv.com

Protocol	Band	Channel Frequency (MHz)
GSM	GSM850	848.8

Temperature of Liquid : 22.7 °C
 Measured Conductivity : 1.017 S/m
 Measured Permittivity : 54.51

Area Scan

Grid Dimension : 31mmX91mmX1mm
 Maximum SAR : 0.163 W/Kg

Zoom Scan

Grid Dimension : 7mmX7mmX7mm
 Power Reference : 10.9 V/m
 Measured SAR : 0.156 W/Kg
 Power Drift : 0.20 dB

Measurement Plot:

EUT Position: Edge 1

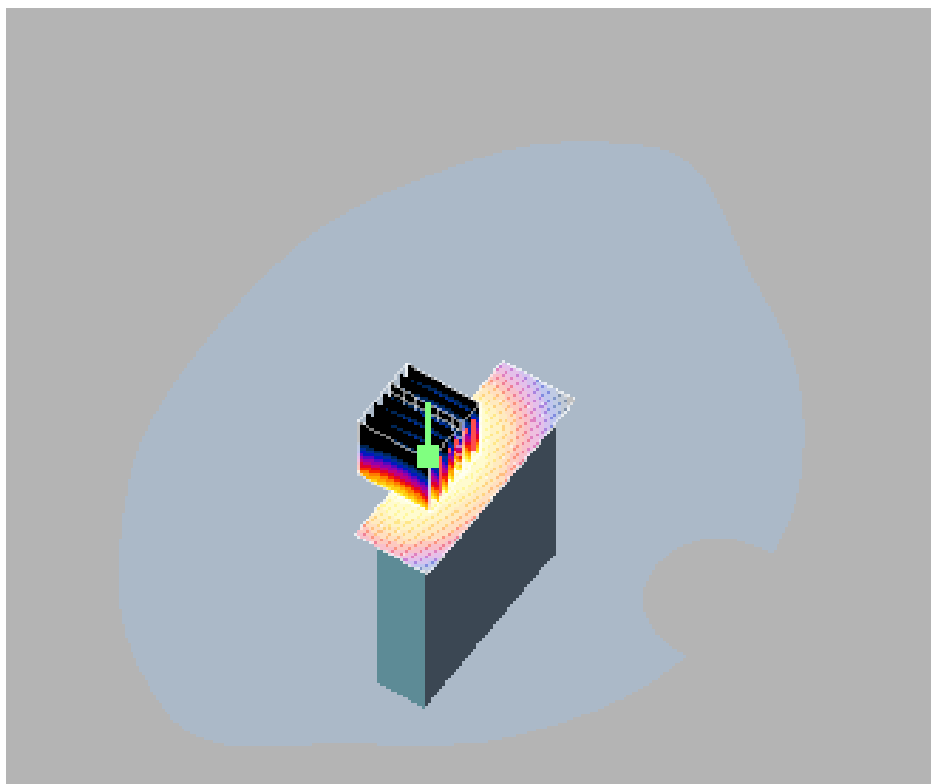

www.tuv.com

Protocol	Band	Channel Frequency (MHz)
GSM	PCS1900	1850.2

Temperature of Liquid : 22.4 °C
 Measured Conductivity : 1.42 S/m
 Measured Permittivity : 41.3

Area Scan

Grid Dimension : 121mmX111mmX1mm
 Maximum SAR : 0.36 W/Kg

Zoom Scan

Grid Dimension : 7mmX7mmX7mm
 Power Reference : 9.28 V/m
 Measured SAR : 0.335 W/Kg
 Power Drift : -0.175 dB

Measurement Plot:

EUT Position: Right Touch

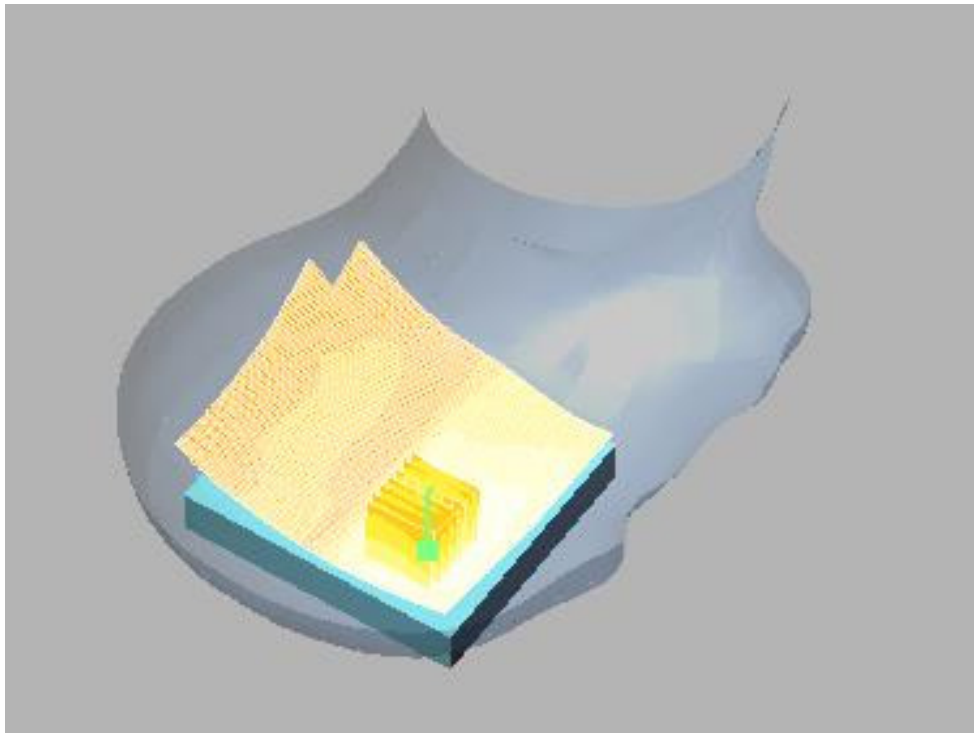

www.tuv.com

Protocol	Band	Channel Frequency (MHz)
GSM	PCS1900	1850.2

Temperature of Liquid : 22.5 °C
 Measured Conductivity : 1.495 S/m
 Measured Permittivity : 53.66

Area Scan

Grid Dimension : 151mmX161mmX1mm
 Maximum SAR : 0.162 W/Kg

Zoom Scan

Grid Dimension : 7mmX7mmX7mm
 Power Reference : 6.7 V/m
 Measured SAR : 0.148 W/Kg
 Power Drift : 0.12 dB

Measurement Plot:

EUT Position: Front Face

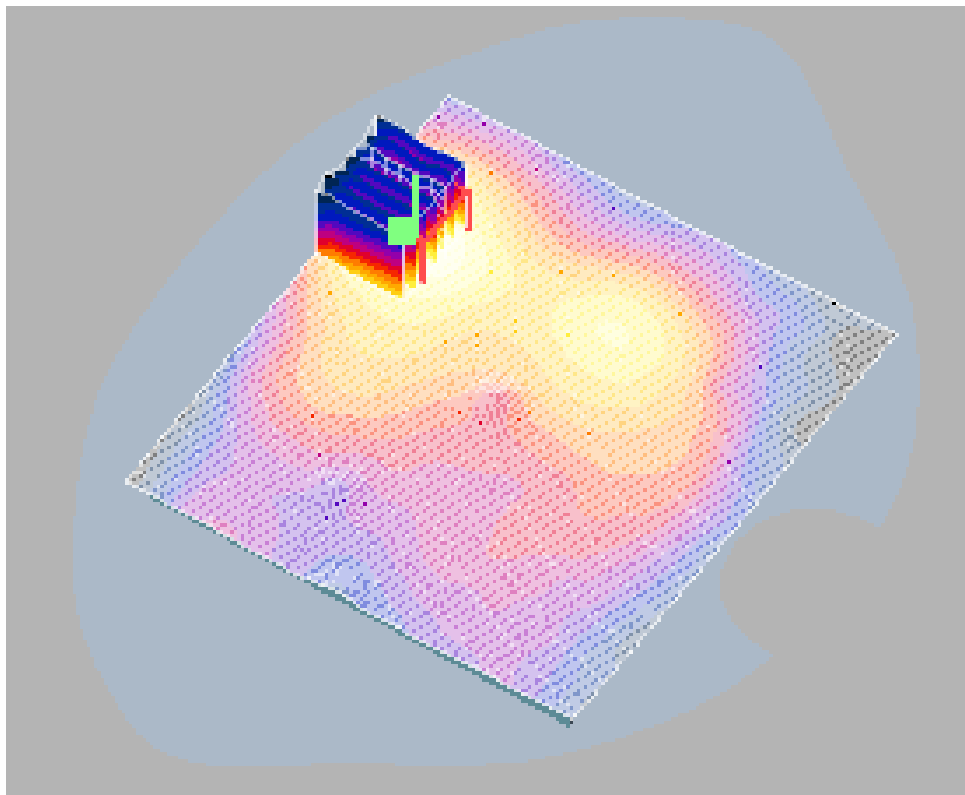

www.tuv.com

Summary of Test Results: WCDMA

Band	Channel Frequency (MHz)	Measured Power (mW)	Tune-Up Scaling Factor (dB)	Tune – Up Scaling Factor (mW)	Maximum Tune –Up Tolerance in (mW)	Measured SAR (W/kg)	Reported SAR (W/kg)	Worst Case EUT Position
W-CDMA Band 2_Body	1852.4	90.16	0.7	1.17	105.93	0.573	0.673	Front Face
W-CDMA Band 4_Body	1732.4	70.63	0.6	1.15	81.1	0.544	0.625	Back Face
W-CDMA Band 5_Body	836.6	81.10	0.4	1.10	88.92	0.211	0.231	Edge 1
W-CDMA Band 2_Head	1880	104.95	0.7	1.17	123.31	1.17	1.375	Right Touch
W-CDMA Band 4_Head	1712.4	62.81	0.6	1.15	72.11	0.421	0.483	Right Touch
W-CDMA Band 5_Head	836.6	81.10	0.4	1.10	88.92	0.667	0.731	Right Touch

Note: Maximum output power was observed in voice mode hence SAR tests are performed for the same mode.

www.tuv.com

Protocol	Band	Channel Frequency (MHz)
W-CDMA	FDD Band 2	1852.4

Temperature of Liquid : 22.6 °C
 Measured Conductivity : 1.495 S/m
 Measured Permittivity : 53.67

Area Scan

Grid Dimension : 151mmX161mmX1mm
 Maximum SAR : 0.628W/Kg

Zoom Scan

Grid Dimension : 7mmX7mmX7mm
 Power Reference : 8.06 V/m
 Measured SAR : 0.573 W/Kg
 Power Drift : -0.03 dB

Measurement Plot:

EUT Position: Front Face

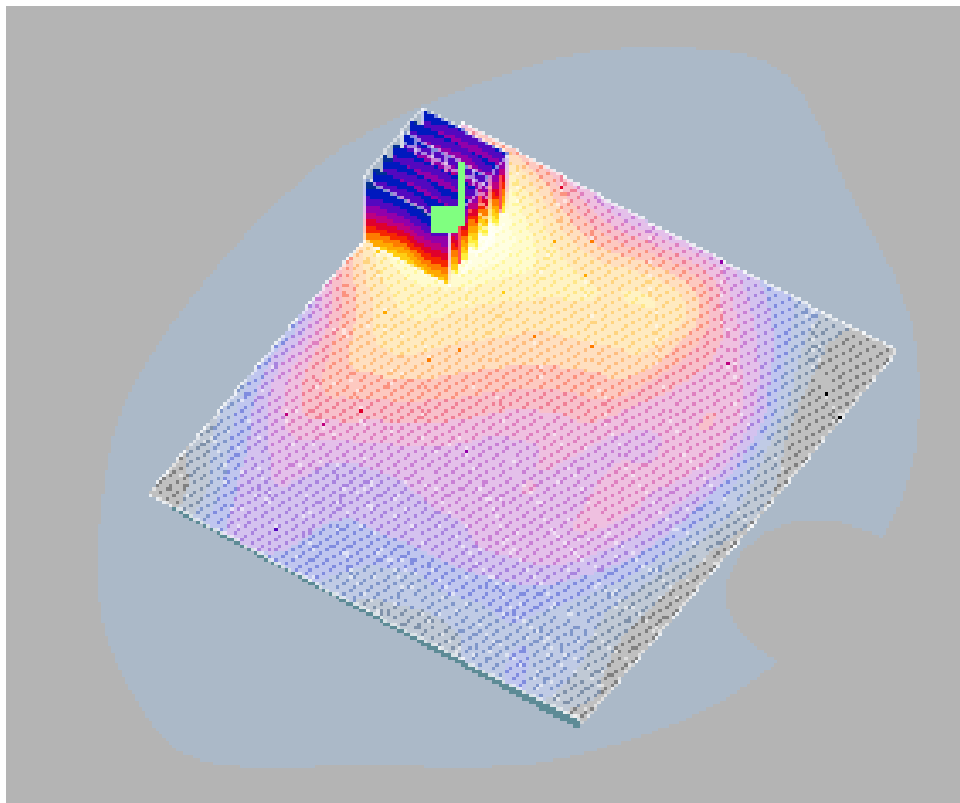

www.tuv.com

Protocol	Band	Channel Frequency (MHz)
W-CDMA	FDD Band 4	1732.4

Temperature of Liquid : 22.5 °C
 Measured Conductivity : 1.418 S/m
 Measured Permittivity : 53.68

Area Scan

Grid Dimension : 151mmX161mmX1mm
 Maximum SAR : 0.576W/Kg

Zoom Scan

Grid Dimension : 7mmX7mmX7mm
 Power Reference : 4.29 V/m
 Measured SAR : 0.544 W/Kg
 Power Drift : 0.16 dB

Measurement Plot:

EUT Position: Back Face

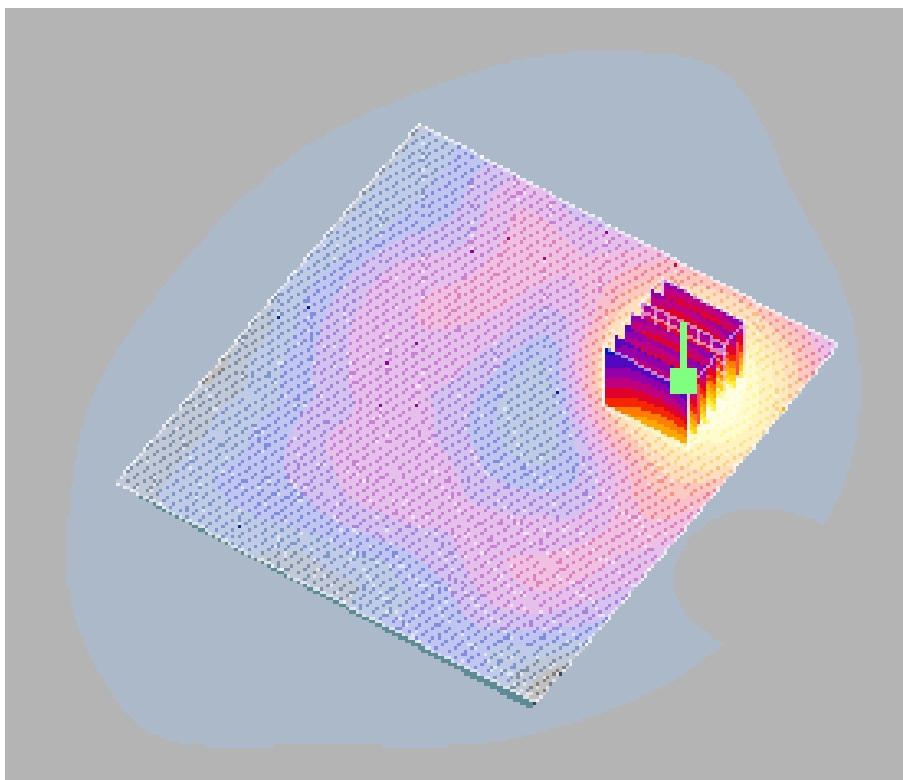

www.tuv.com

Protocol	Band	Channel Frequency (MHz)
W-CDMA	FDD Band 5	836.6

Temperature of Liquid : 22.5 °C
 Measured Conductivity : 1.007 S/m
 Measured Permittivity : 54.12

Area Scan

Grid Dimension : 41mmX161mmX1mm
 Maximum SAR : 0.239W/Kg

Zoom Scan

Grid Dimension : 7mmX7mmX7mm
 Power Reference : 14.2 V/m
 Measured SAR : 0.211 W/Kg
 Power Drift : -0.61 dB

Measurement Plot:

EUT Position: Edge 1

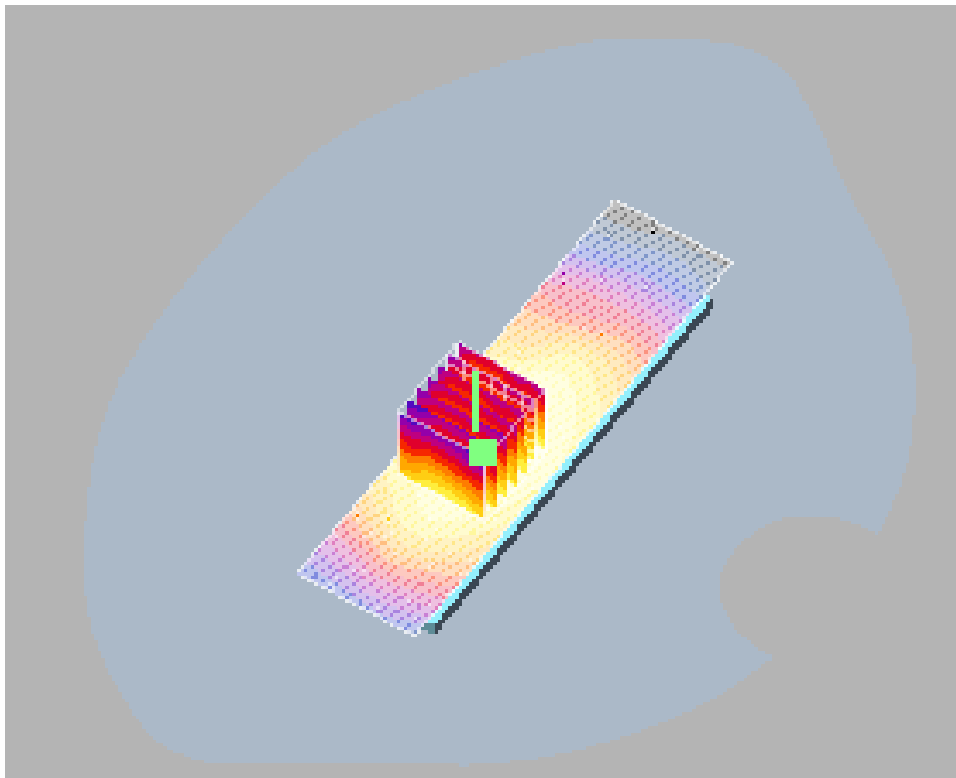

www.tuv.com

Protocol	Band	Channel Frequency (MHz)
W-CDMA	FDD Band 2	1880

Temperature of Liquid : 22.4 °C
 Measured Conductivity : 1.433 S/m
 Measured Permittivity : 40.99

Area Scan

Grid Dimension : 151mmX161mmX1mm
 Maximum SAR : 1.18W/Kg

Zoom Scan

Grid Dimension : 7mmX7mmX7mm
 Power Reference : 16.1 V/m
 Measured SAR : 1.17 W/Kg
 Power Drift : -0.47 dB

Measurement Plot:

EUT Position: Right Touch

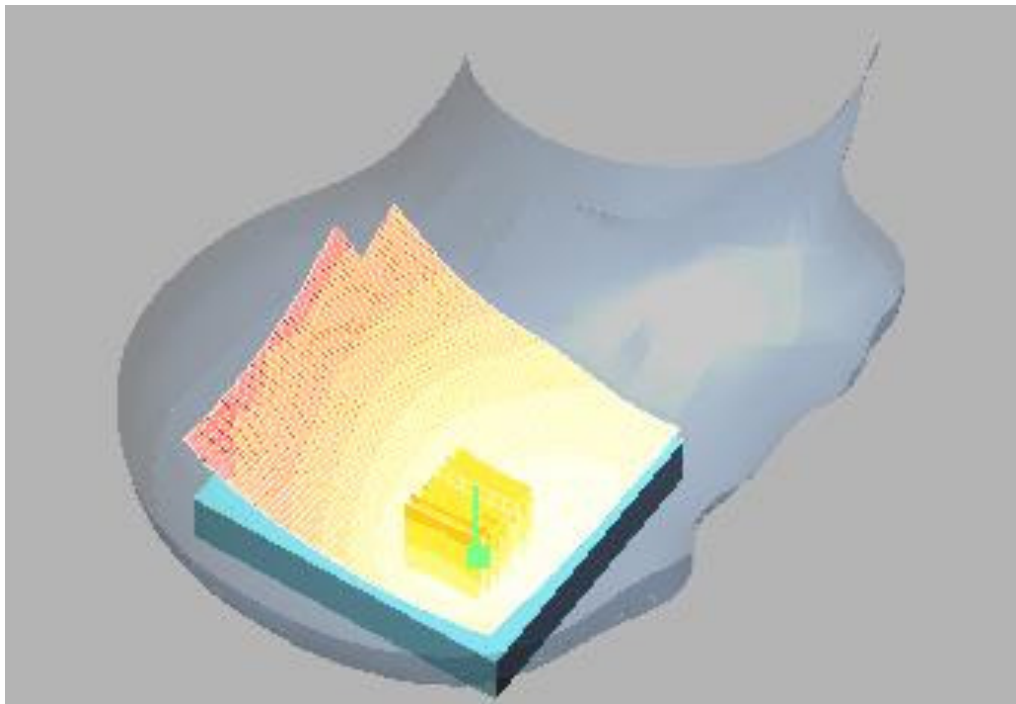

www.tuv.com

Protocol	Band	Channel Frequency (MHz)
W-CDMA	FDD Band 4	1712.4

Temperature of Liquid : 22.4 °C
 Measured Conductivity : 1.35 S/m
 Measured Permittivity : 41.53

Area Scan

Grid Dimension : 121mmX111mmX1mm
 Maximum SAR : 0.465W/Kg

Zoom Scan

Grid Dimension : 7mmX7mmX7mm
 Power Reference : 8.25 V/m
 Measured SAR : 0.421 W/Kg
 Power Drift : -0.24 dB

Measurement Plot:

EUT Position: Right Touch

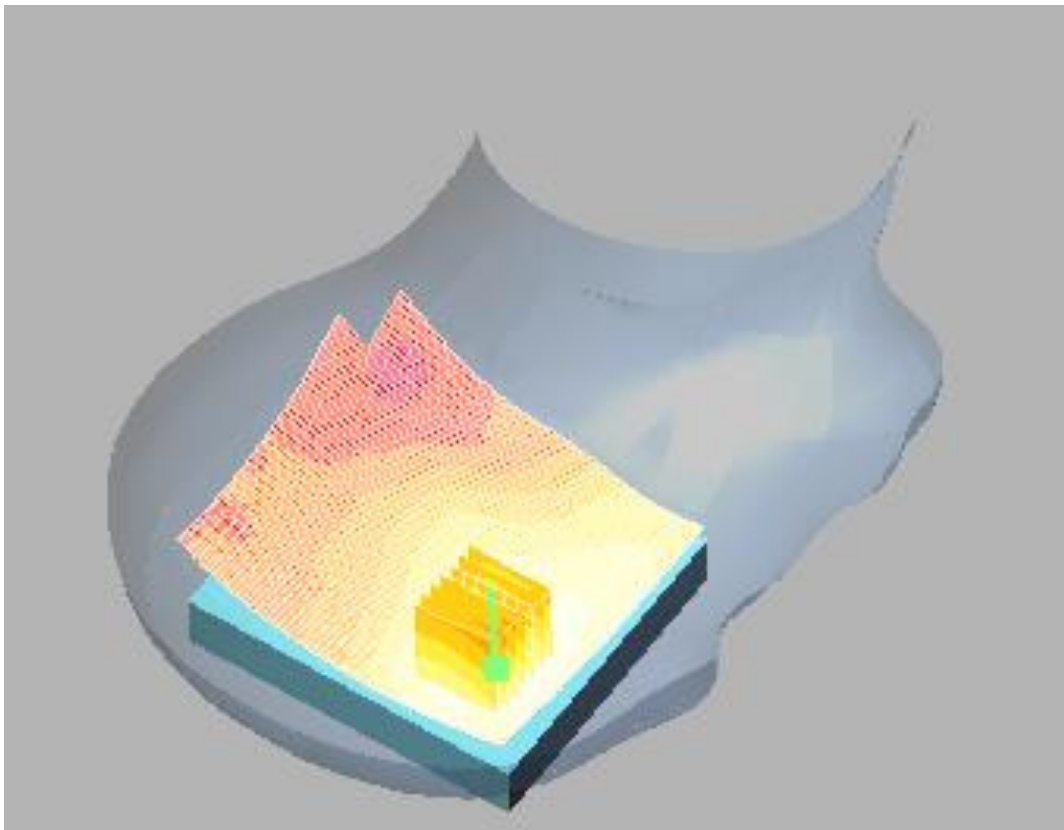

www.tuv.com

Protocol	Band	Channel Frequency (MHz)
W-CDMA	FDD Band 5	836.6

Temperature of Liquid : 22.4 °C
 Measured Conductivity : 0.932 S/m
 Measured Permittivity : 42.82

Area Scan

Grid Dimension : 121mmX111mmX1mm
 Maximum SAR : 0.730W/Kg

Zoom Scan

Grid Dimension : 7mmX7mmX7mm
 Power Reference : 14.6 V/m
 Measured SAR : 0.667 W/Kg
 Power Drift : -0.074 dB

Measurement Plot:

EUT Position: Right Touch

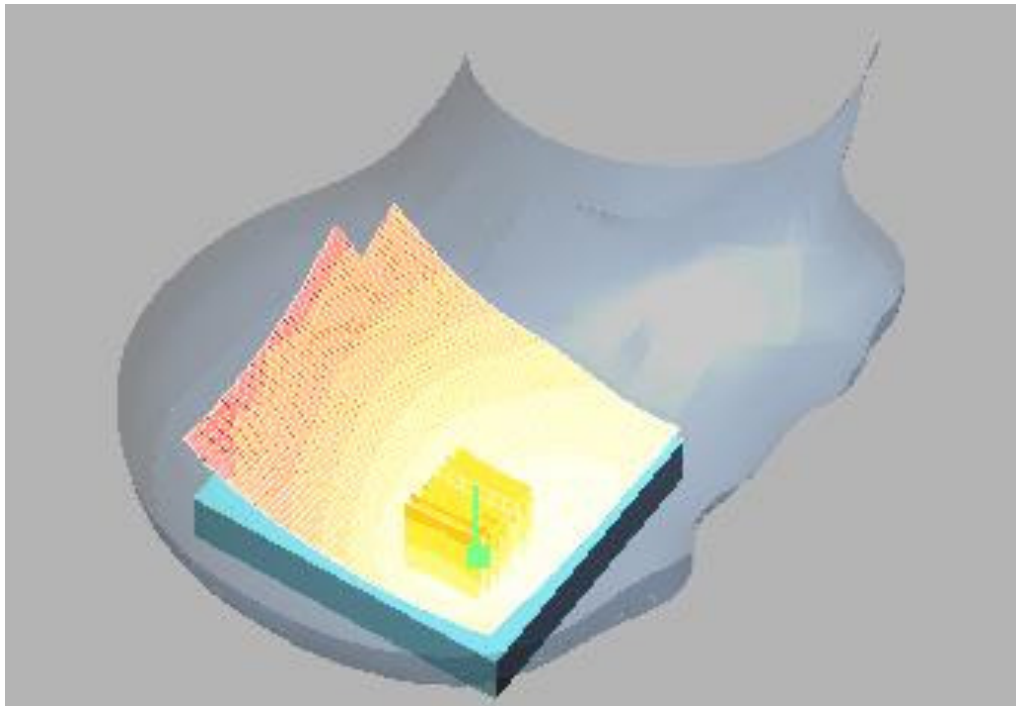

www.tuv.com

Test Result Summary: Wi-Fi & Bluetooth

Band	Channel Frequency (MHz)	Measured Power (mW)	Tune-Up Scaling Factor (dB)	Tune –Up Scaling Factor (mW)	Maximum Tune –Up Tolerance in (mW)	Measured SAR (W/kg)	Reported SAR (W/kg)	Worst Case EUT Position
2.4GHz_Wi-Fi_Body	2437	23.44	0.5	1.12	24.56	0.161	0.181	Edge 1
2.4GHz_Wi-Fi_Head	2462	19.50	0.5	1.12	20.62	0.172	0.193	Left Tilt
2.4GHz_Bluetooth_Body	2480	5.26	0.5	1.12	6.38	0.00415	0.005	Edge 1

www.tuv.com

Protocol	Data Rate	Channel Frequency (MHz)
Wi-Fi	1Mbps	2437

Temperature of Liquid : 23 °C
 Measured Conductivity : 1.935 S/m
 Measured Permittivity : 52.75

Area Scan

Grid Dimension : 41mmX141mmX1mm
 Maximum SAR : 0.169 W/Kg

Zoom Scan

Grid Dimension : 7mmX7mmX7mm
 Power Reference : 4.66 V/m
 Measured SAR : 0.161 W/Kg
 Power Drift : -0.39dB

Measurement Plot:

EUT Position: Edge 1

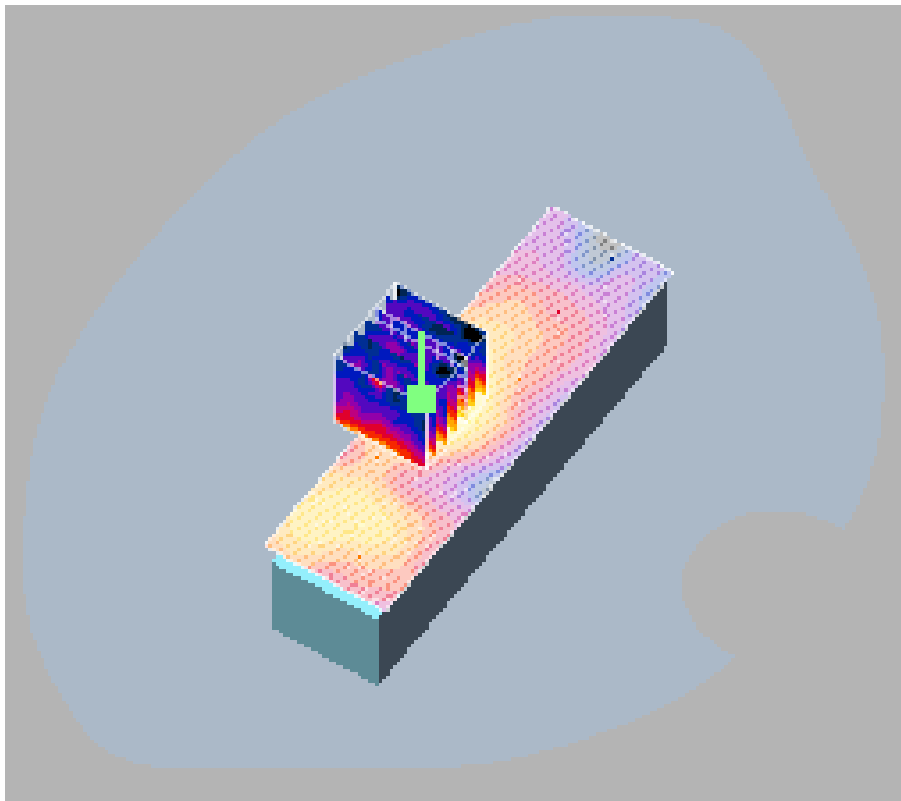

www.tuv.com

Protocol	Data Rate	Channel Frequency (MHz)
Wi-Fi	1Mbps	2437

Temperature of Liquid : 22.8 °C
 Measured Conductivity : 1.795 S/m
 Measured Permittivity : 40.185

Area Scan

Grid Dimension : 81mmX141mmX1mm
 Maximum SAR : 0.164 W/Kg

Zoom Scan

Grid Dimension : 7mmX7mmX7mm
 Power Reference : 6.18 V/m
 Measured SAR : 0.172 W/Kg
 Power Drift : -0.39dB

Measurement Plot:

EUT Position: Left Tilt

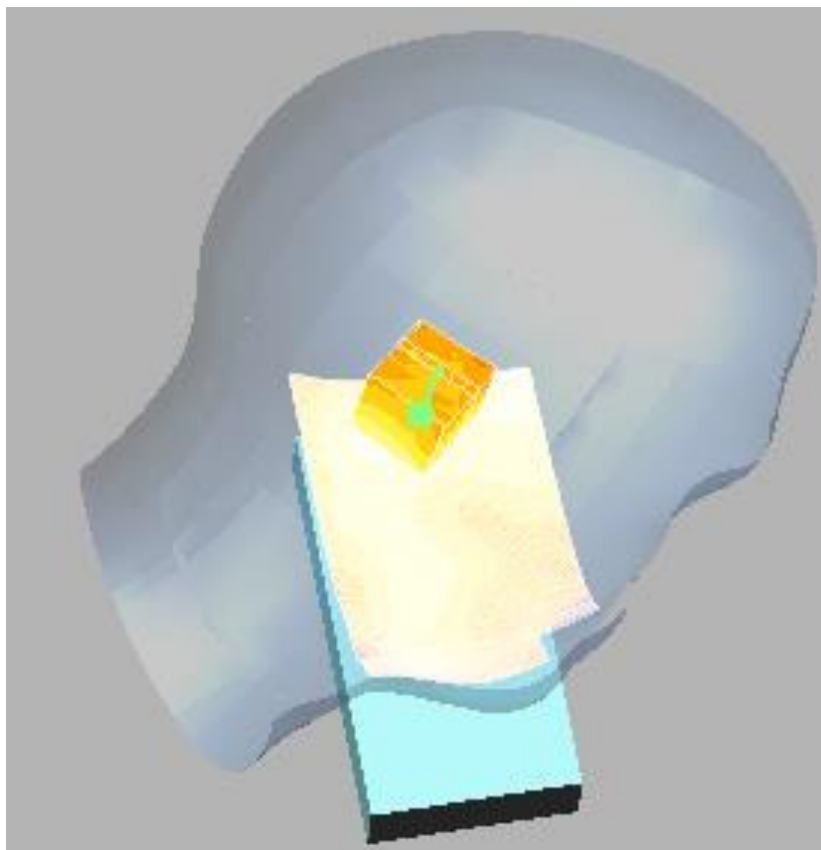

www.tuv.com

Protocol	Data Rate	Channel Frequency (MHz)
Bluetooth	3Mbps	2440

Temperature of Liquid : 23 °C
 Measured Conductivity : 1.935 S/m
 Measured Permittivity : 52.75

Area Scan

Grid Dimension : 41mmX141mmX1mm
 Maximum SAR : 0.01 W/Kg

Zoom Scan

Grid Dimension : 7mmX7mmX7mm
 Power Reference : 3.68 V/m
 Measured SAR : 0.00415 W/Kg
 Power Drift : -0.79dB

Measurement Plot:

EUT Position: Edge 1

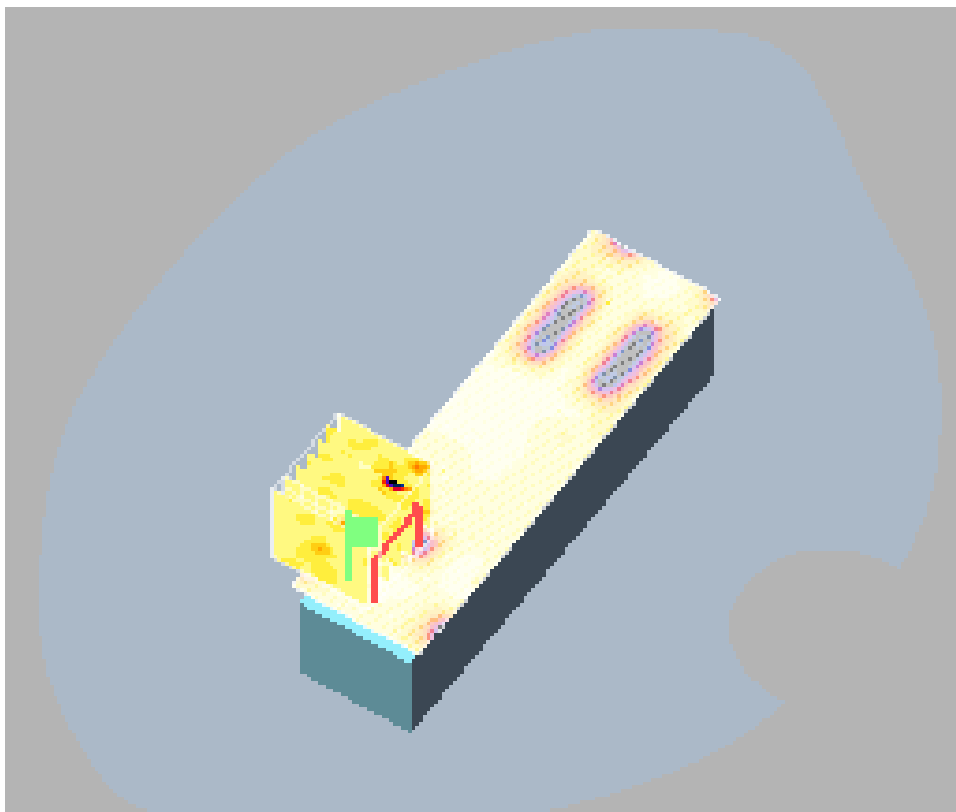

www.tuv.com

Test Result Summary: LTE

Band	Channel Frequency (MHz)	Measured Power (mW)	Tune-Up Scaling Factor (dB)	Tune -Up Scaling Factor (mW)	Maximum Tune -Up Tolerance in (mW)	Measured SAR (W/kg)	Reported SAR (W/kg)	Worst Case EUT Position
LTE Band 2_Body	1860	138.68	0.5	1.12	139.8	0.193	0.217	Edge 1
LTE Band 4_Body	1732.5	152.76	1.2	1.32	154.07	0.454	0.598	Edge 2
LTE Band 5_Body	829	143.22	0.6	1.15	144.37	0.173	0.199	Edge 1
LTE Band 17_Body	710	167.88	0.6	1.15	169.03	0.182	0.209	Edge 1

www.tuv.com

Protocol	Bandwidth (MHz)	Channel Frequency (MHz)
LTE_FDD Band 2	20	1860

Temperature of Liquid : 23 °C
 Measured Conductivity (σ) : 1.497 S/m
 Measured Permittivity (ϵ_r) : 53.507

Area Scan

Grid Dimension : 41mmX161mmX1mm
 Maximum SAR : 0.196 W/Kg

Zoom Scan

Grid Dimension : 7mmX7mmX7mm
 Power Reference : 11.2 V/m
 Measured SAR : 0.193 W/Kg
 Power Drift : -0.0 dB

Measurement Plot:

EUT Position: Edge 1

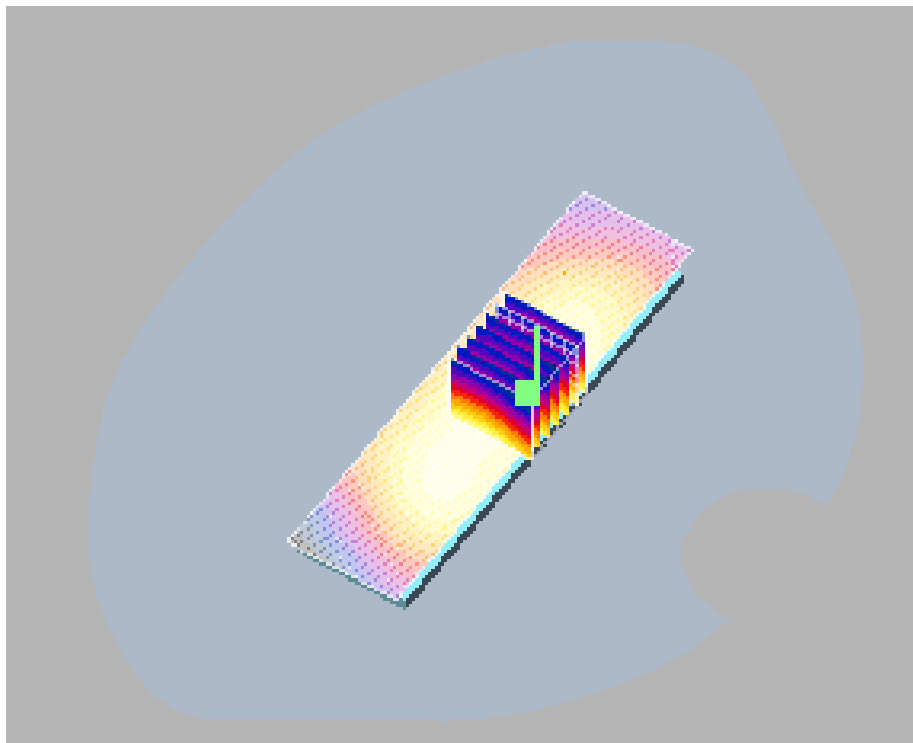

www.tuv.com

Protocol	Bandwidth (MHz)	Channel Frequency (MHz)
LTE_FDD Band 4	5	1732.5

Temperature of Liquid : 23 °C
 Measured Conductivity (σ) : 1.445 S/m
 Measured Permittivity (ϵ_r) : 53.68

Area Scan

Grid Dimension : 41mmX161mmX1mm
 Maximum SAR : 0.397 W/Kg

Zoom Scan

Grid Dimension : 7mmX7mmX7mm
 Power Reference : 11.2 V/m
 Measured SAR : 0.454 W/Kg
 Power Drift : -0.72 dB

Measurement Plot:

EUT Position: Edge 2

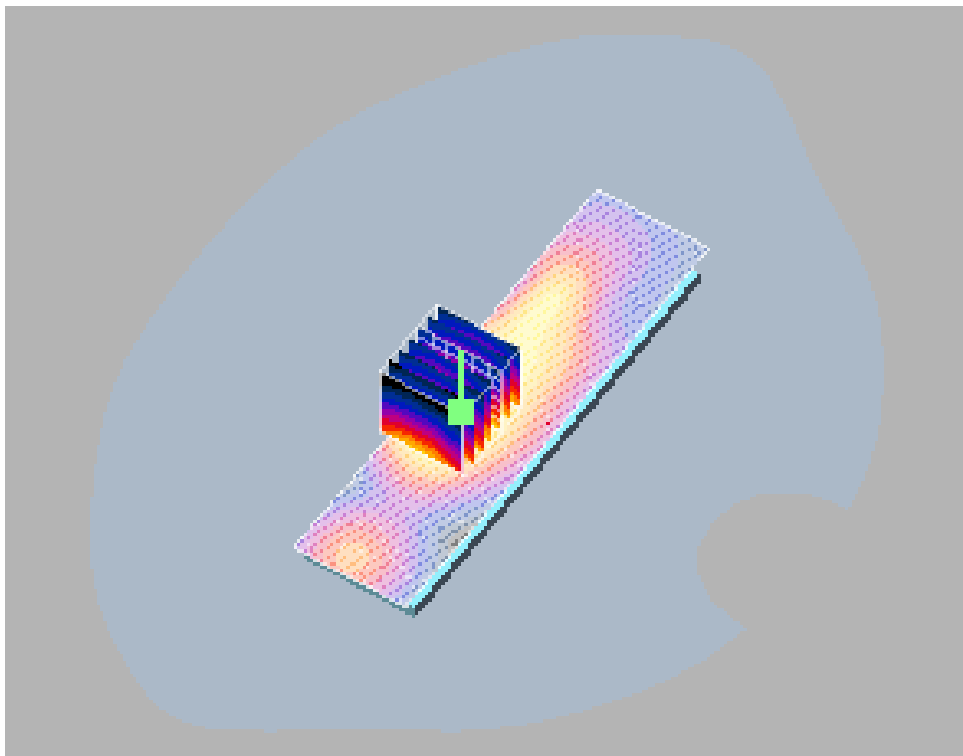

www.tuv.com

Protocol	Bandwidth (MHz)	Channel Frequency (MHz)
LTE_FDD Band 5	10	829

Temperature of Liquid : 23 °C
 Measured Conductivity (σ) : 1.002 S/m
 Measured Permittivity (ϵ_r) : 54.

Area Scan

Grid Dimension : 41mmX161mmX1mm
 Maximum SAR : 0.188 W/Kg

Zoom Scan

Grid Dimension : 7mmX7mmX7mm
 Power Reference : 10.8 V/m
 Measured SAR : 0.173 W/Kg
 Power Drift : 0.37 dB

Measurement Plot:

EUT Position: Edge 1

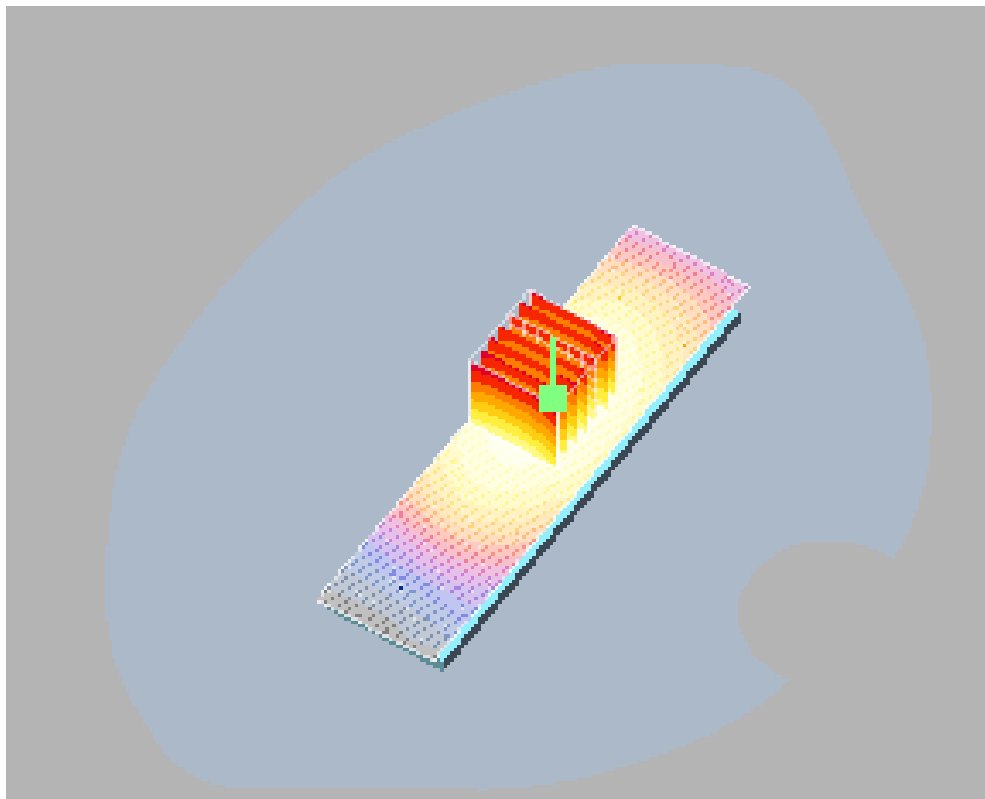

www.tuv.com

Protocol	Bandwidth (MHz)	Channel Frequency (MHz)
LTE_FDD Band 17	10	710

Temperature of Liquid : 23 °C
 Measured Conductivity (σ) : 0.989 S/m
 Measured Permittivity (ϵ_r) : 53.54

Area Scan

Grid Dimension : 41mmX161mmX1mm
 Maximum SAR : 0.195 W/Kg

Zoom Scan

Grid Dimension : 7mmX7mmX7mm
 Power Reference : 10.8 V/m
 Measured SAR : 0.182 W/Kg
 Power Drift : 0.37 dB

Measurement Plot:

EUT Position: Edge 1

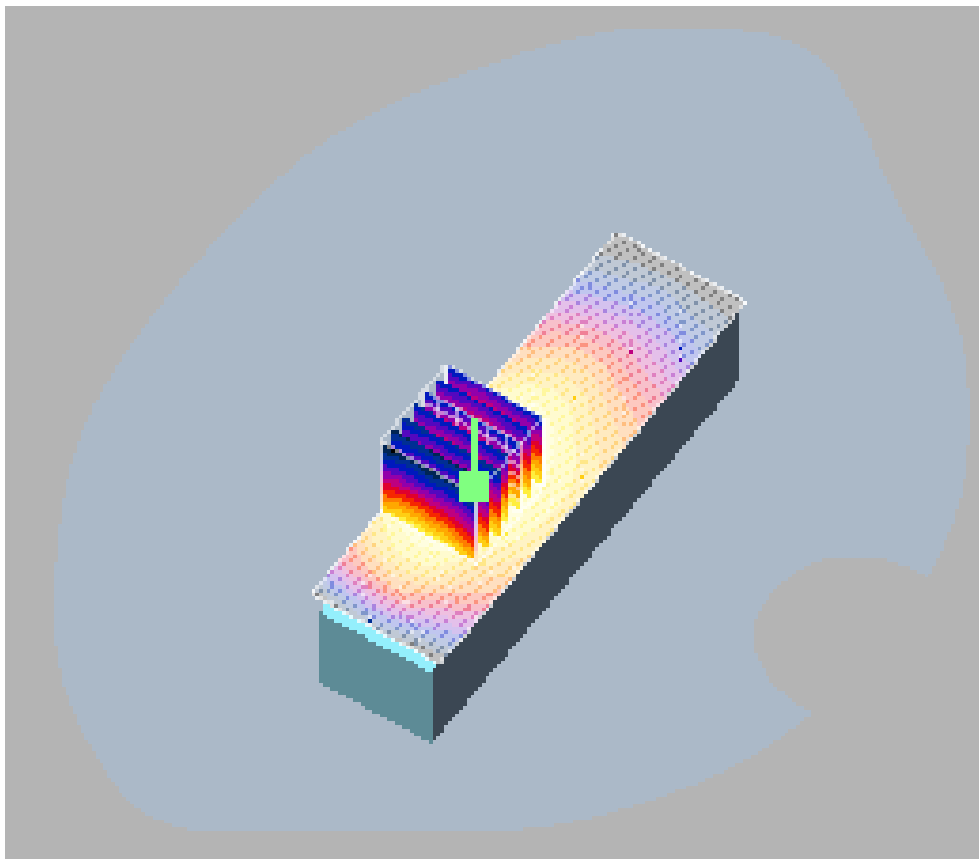

www.tuv.com

Protocol	Bandwidth (MHz)	Channel Frequency (MHz)
LTE_FDD Band 13	10	782

Temperature of Liquid : 22.5 °C
 Measured Conductivity : 0.973 S/m
 Measured Permittivity : 54.52

Area Scan

Grid Dimension : 41mmX141mmX1mm
 Maximum SAR : 0.338W/Kg

Zoom Scan

Grid Dimension : 7mmX7mmX7mm
 Power Reference : 16.54 V/m
 Measured SAR : 0.326 W/Kg
 Power Drift : 0.2 dB

Measurement Plot:

EUT Position: Edge 1

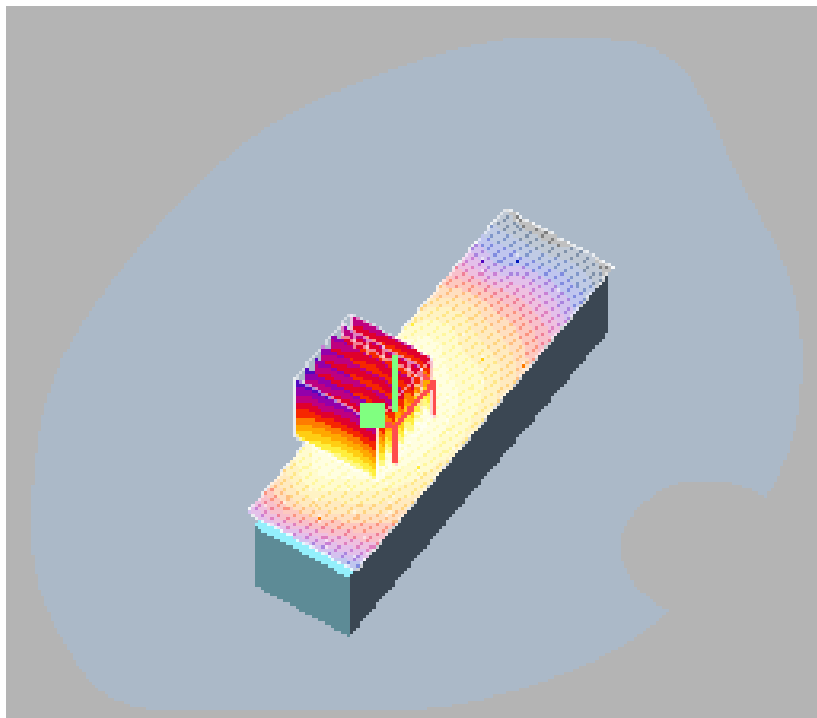

www.tuv.com

Test Results: Simultaneous Operation

Simultaneous Transmission Configuration as mentioned below;

GSM & Wi-Fi, along with NFC; BLE/BT & GPS Transmit Simultaneously.

3G along with NFC, BLE/BT & GPS Transmit Simultaneously.

4G along with NFC, BLE/BT & GPS Transmit Simultaneously.

Data network supported by tablet are as follows in the order of priority, one mode at a time – Wired Ethernet, WIFI (2G calls can work during this, the same simultaneous transmission calculation is reported), 2G data, 3G data or 4G data & WIFI hotspot functionality will be active but data connection will be cut during the phone call.

WLAN and BT/BLE share the same antenna, and cannot transmit simultaneously.

Based on network signal strength product will choose either GSM or WCDMA, Therefore, they will not Transmit Simultaneously.

Simultaneous transmission combined SAR value is as listed in below table;

	GSM850	PCS1900	Wi-Fi	Σ 1-g SAR (W/kg)
Head	0.43	-	0.45	0.89
Body	0.17	-	0.3	0.48
Head	-	0.51	0.45	0.97
Body	-	0.14	0.3	0.45

For simultaneous transmission analysis, Bluetooth SAR is estimated per KDB 447498 D01 based on the formula below

- a) $[(\text{Max. Power of channel, including tune-up tolerance, mW}) / (\text{min. test separation distance, mm})] * [\sqrt{f \text{ (GHz)/x}}] \text{ W/kg}$ for test separation distances 50mm;

Where $x = 7.5$ for 1-g SAR and $x = 18.75$ for 10-g SAR.

- b) When the minimum separation distance is <5mm, the distance is used 5mm to determine SAR test exclusion

Frequency (GHz)	Max. Power (mW)	Min. Test Separation distance	SAR Test Exclusion Calculation Values	1-g Extremity SAR Test exclusion Thresholds	Results
2.402 – 2.480_BT	8.14	5mm	0.38	3	Pass
2.402 – 2.480_BLE	2.04	5mm	0.08	3	Pass

SAR Sensor on 118207

- A short note

Background -

The SAR sensor is basically a proximity sensor which is used for detecting the proximity of head or body to the antenna of the Wireless product. The operation is purely based on detection of capacitance change. Interrupts are generated by this SAR sensor chip to the processor and the processor communicates with the transceiver chip to drive the appropriate power level defined by the back-off algorithm.

Current scenario -

The SAR sensor mounted on the main board of 118207 is active but currently not running any power back-off algorithm because the measured SAR values as per FCC & IC regulations are well below the limits and hence power back-off is actually required.

Bottom note –

SAR sensors chip are added during the design stage based on the virtual SAR 3D simulations with PC software. Later, after the product is ready for testing, the actual SAR value is measured and based on these measured values, the appropriate algorithm is added based on the back-off requirements.

www.tuv.com

Test Setup Photos:



System Validation



System Validation



SAR Test Setup_10mm Spacer



SAR Test Setup_10mm Spacer



SAR Test Setup



SAR Test Setup

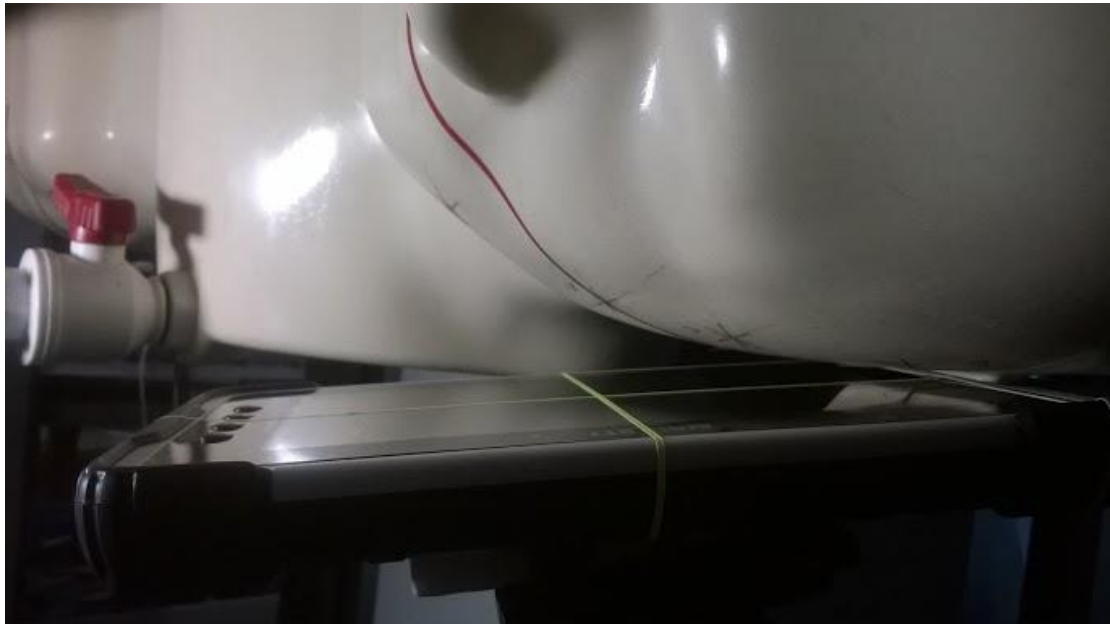

SAR Test Setup



SAR Test Setup

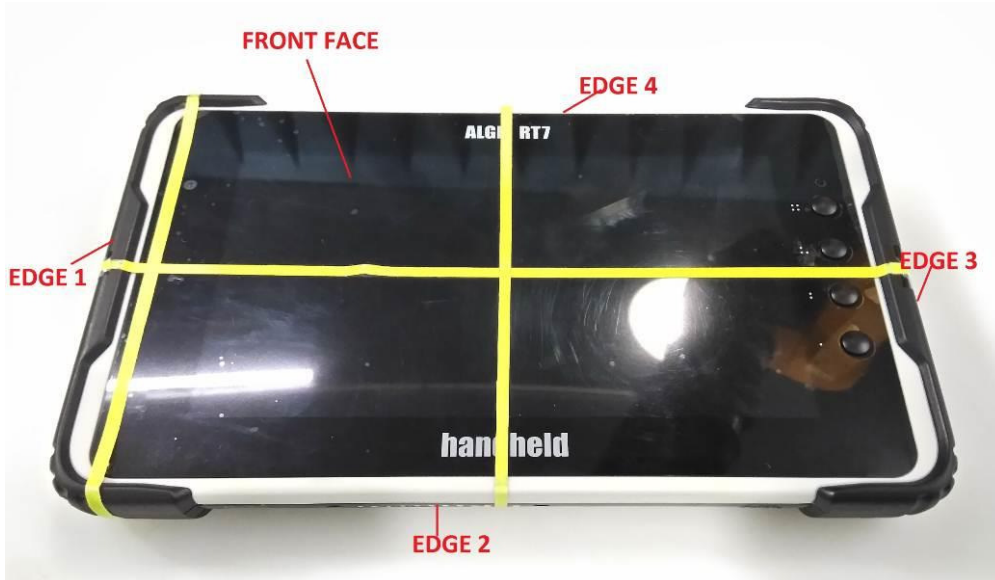

EUT Edge Identification



Antenna Location Image

Annual Confirmation of SAR Reference Dipole.

Annual Check Date: 14.09.2016

Frequency (MHz)	Item	Original Value	Annual Check Value	Deviation	Accepted Tolerance	Note
850	Return Loss	-25.7	-26.06	1%	20%	Pass
	Impedance Real Part	50.1	51.74	-1.64	±5Ω	Pass
	Impedance Imaginary Part	-5.2	-4.87	0.33	±5Ω	Pass
1750	Return Loss	-42.8	-36.91	-16%	20%	Pass
	Impedance Real Part	49.5	49.74	-0.24	±5Ω	Pass
	Impedance Imaginary Part	-0.5	1.65	-2.15	±5Ω	Pass
1900	Return Loss	-25	-27.74	10%	20%	Pass
	Impedance Real Part	53	52.85	0.15	±5Ω	Pass
	Impedance Imaginary Part	5	3.19	1.81	±5Ω	Pass
2450	Return Loss	-27.4	-29.32	7%	20%	Pass
	Impedance Real Part	53.7	53.93	-0.23	±5Ω	Pass
	Impedance Imaginary Part	2.4	-0.85	3.25	±5Ω	Pass

www.tuv.com

Impedance-Return Loss Plots 850 MHz

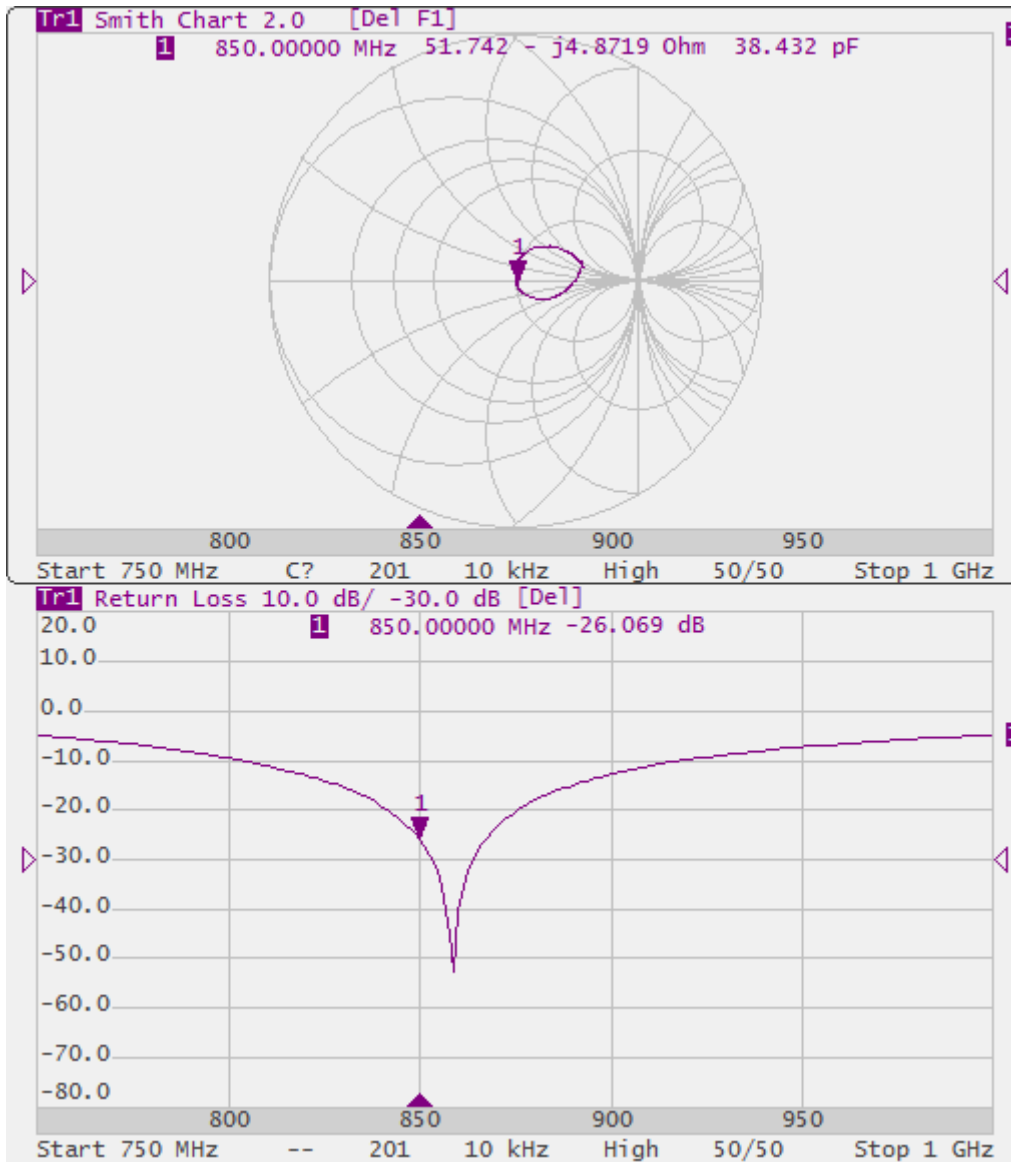

www.tuv.com

Impedance-Return Loss Plots 1750 MHz

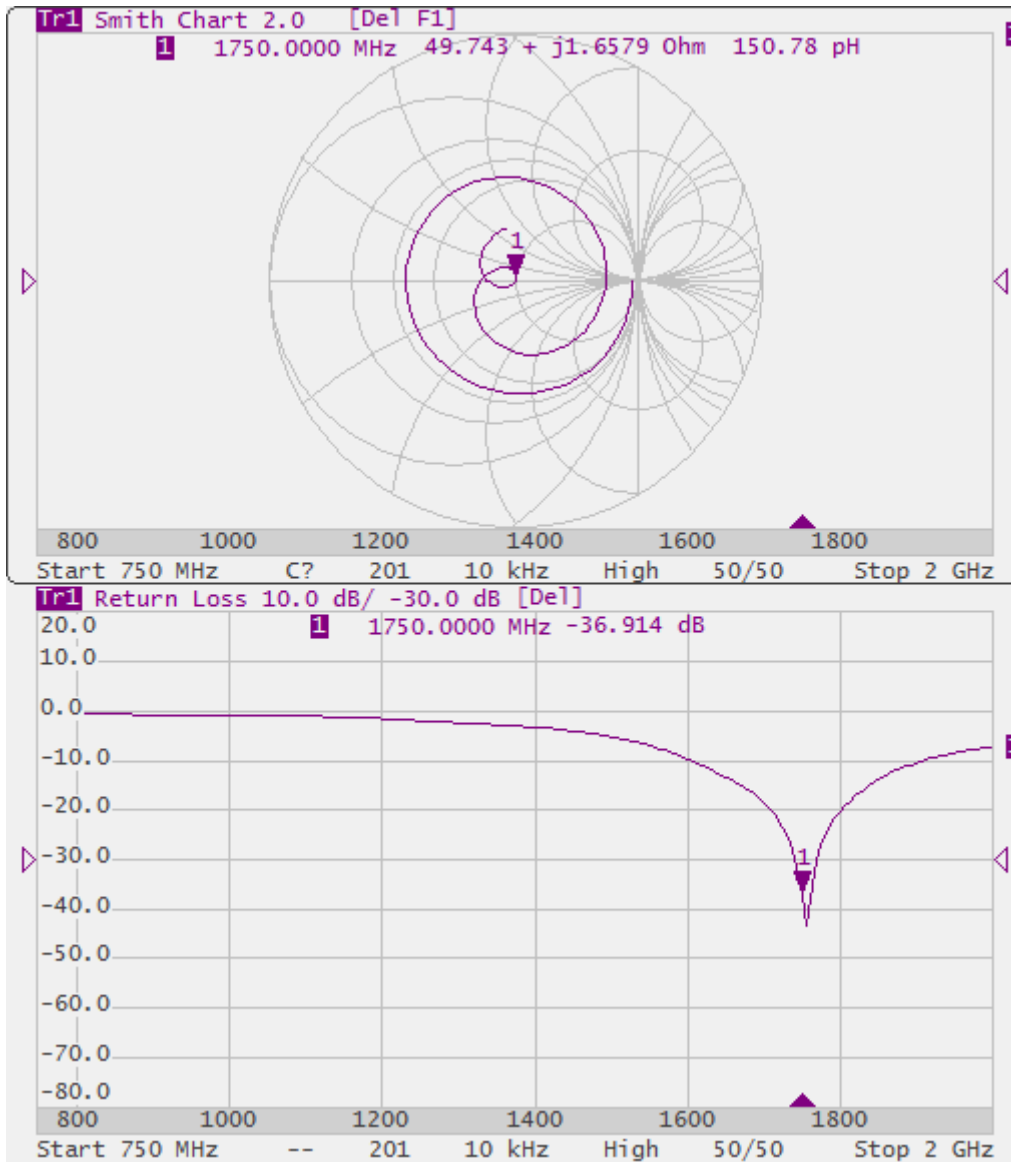

www.tuv.com

Impedance-Return Loss Plots 1900 MHz

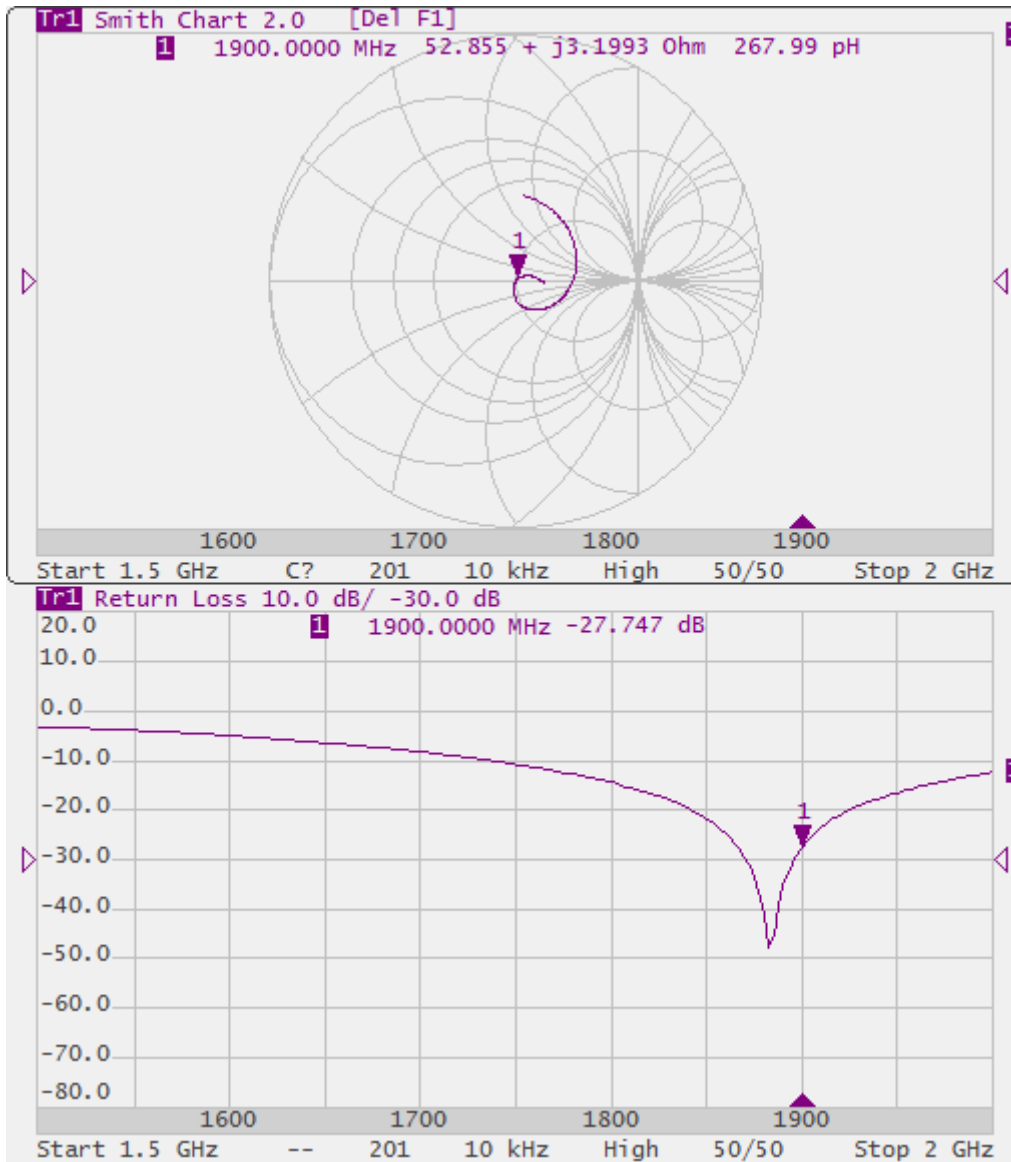

www.tuv.com

Impedance-Return Loss Plots 2450 MHz

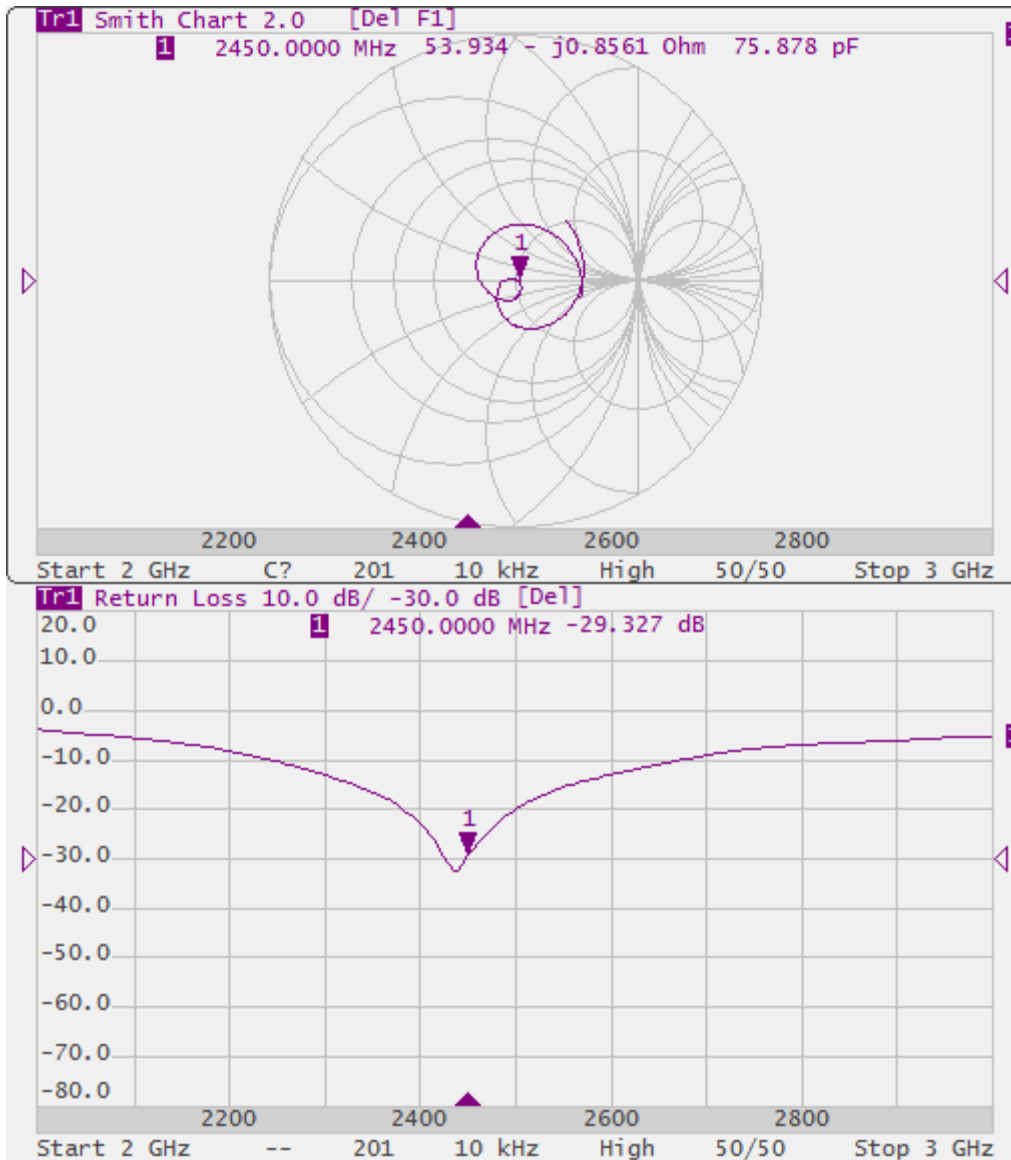

END OF TEST REPORT

Worst-Case uncertainty budget was assessed according to IEEE 1528. The budget is valid for the frequency range 300MHz - 3GHz and represents a worst-case analysis. For specific tests and configurations, the uncertainty could be considerable smaller.

Error Description	Uncertainty Value	Prob. Dist.	Div.	(ci) 1g	(ci) 10g	Std. Unc. (1g)	Std. Unc. (10g)
Measurement System							
Probe Calibration	±5.9%	N	1	1.00	1.00	±5.9%	±5.9%
Axial Isotropy	±4.7%	R	1.73	0.70	0.70	±1.9%	±1.9%
Hemispherical Isotropy	±9.6%	R	1.73	0.70	0.70	±3.9%	±3.9%
Boundary effect	±1%	R	1.73	1.00	1.00	±0.6%	±0.6%
Linearity	±4.7%	R	1.73	1.00	1.00	±2.7%	±2.7%
System Detection Limits	±1.0%	R	1.73	1.00	1.00	±0.6%	±0.6%
Readout Electronics	±0.3%	N	1.00	1.00	1.00	±0.3%	±0.3%
Response time	±0.8%	R	1.73	1.00	1.00	±0.5%	±0.5%
Integration time	±2.6%	R	1.73	1.00	1.00	±1.5%	±1.5%
RF Ambient Conditions	±3.0%	R	1.73	1.00	1.00	±1.7%	±1.7%
Probe Positioner Mechanical Tolerance	±0.4%	R	1.73	1.00	1.00	±0.2%	±0.2%
Probe Positioning w.r.t. Phantom Shell	±2.9%	R	1.73	1	1	±1.7%	±1.7%
SAR Evaluation Algorithms	±1.0%	R	1.73	1	1	±0.6%	±0.6%
Test Sample Related							
Device Positioning	±2.9%	N	1.00	1	1	±2.9%	±2.9%
Device Holder	±3.6%	N	1.00	1	1	±3.6%	±3.6%
Output Power Drift	±5.0%	R	1.73	1	1	±2.9%	±2.9%
Phantom and Tissue Parameters							
Phantom Uncertainty (shape and thickness)	±4.0%	R	1.73	1.00	1.00	±2.3%	±2.3%
Liquid conductivity (Deviation from target)	±5.0%	R	1.73	0.64	0.43	±1.8%	±1.2%
Liquid conductivity (measurement uncert.)	±2.5%	N	1.00	0.64	0.43	±1.6%	±1.1%
Liquid permittivity (Deviation from target)	±5.0%	R	1.73	0.60	0.49	±1.7%	±1.4%
Liquid permittivity (measurement uncert.)	±2.5%	N	1.00	0.60	0.49	±1.5%	±1.2%
Combined standard uncertainty						±10.8%	±10.6%
Expanded uncertainty						±21.6%	±21.1%

(95% Confidence Level) K=2



Accredited by the Swiss Accreditation Service (SAS)
The Swiss Accreditation Service is one of the signatories to the EA
Multilateral Agreement for the recognition of calibration certificates

Accreditation No.: **SCS 0108**

Client **BNN-SPEAG Laboratory**

Certificate No: **D2450V2-889_Sep15**

CALIBRATION CERTIFICATE

Object **D2450V2 - SN: 889**

Calibration procedure(s) **QA CAL-05.v9
Calibration procedure for dipole validation kits above 700 MHz**

Calibration date: **September 02, 2015**

This calibration certificate documents the traceability to national standards, which realize the physical units of measurements (SI).
The measurements and the uncertainties with confidence probability are given on the following pages and are part of the certificate.

All calibrations have been conducted in the closed laboratory facility: environment temperature (22 ± 3)°C and humidity < 70%.

Calibration Equipment used (M&TE critical for calibration)

Primary Standards	ID #	Cal Date (Certificate No.)	Scheduled Calibration
Power meter EPM-442A	GB37480704	07-Oct-14 (No. 217-02020)	Oct-15
Power sensor HP 8481A	US37292783	07-Oct-14 (No. 217-02020)	Oct-15
Power sensor HP 8481A	MY41092317	07-Oct-14 (No. 217-02021)	Oct-15
Reference 20 dB Attenuator	SN: 5058 (20k)	01-Apr-15 (No. 217-02131)	Mar-16
Type-N mismatch combination	SN: 5047.2 / 06327	01-Apr-15 (No. 217-02134)	Mar-16
Reference Probe EX3DV4	SN: 7349	30-Dec-14 (No. EX3-7349_Dec14)	Dec-15
DAE4	SN: 601	17-Aug-15 (No. DAE4-601_Aug15)	Aug-16
Secondary Standards	ID #	Check Date (in house)	Scheduled Check
RF generator R&S SMT-06	100005	04-Aug-99 (in house check Oct-13)	In house check: Oct-16
Network Analyzer HP 8753E	US37390585 S4206	18-Oct-01 (in house check Oct-14)	In house check: Oct-15

Calibrated by: **Israe Elnaouq** Name: **Israe Elnaouq** Function: **Laboratory Technician**

Approved by: **Katja Pokovic** Name: **Katja Pokovic** Function: **Technical Manager**

Signature
Israe Elnaouq
Katja Pokovic

Issued: September 3, 2015

This calibration certificate shall not be reproduced except in full without written approval of the laboratory.



Accredited by the Swiss Accreditation Service (SAS)
The Swiss Accreditation Service is one of the signatories to the EA
Multilateral Agreement for the recognition of calibration certificates

Accreditation No.: **SCS 0108**

Glossary:

TSL	tissue simulating liquid
ConvF	sensitivity in TSL / NORM x,y,z
N/A	not applicable or not measured

Calibration is Performed According to the Following Standards:

- IEEE Std 1528-2013, "IEEE Recommended Practice for Determining the Peak Spatial-Averaged Specific Absorption Rate (SAR) in the Human Head from Wireless Communications Devices: Measurement Techniques", June 2013
- IEC 62209-1, "Procedure to measure the Specific Absorption Rate (SAR) for hand-held devices used in close proximity to the ear (frequency range of 300 MHz to 3 GHz)", February 2005
- IEC 62209-2, "Procedure to determine the Specific Absorption Rate (SAR) for wireless communication devices used in close proximity to the human body (frequency range of 30 MHz to 6 GHz)", March 2010
- KDB 865664, "SAR Measurement Requirements for 100 MHz to 6 GHz"

Additional Documentation:

- DASY4/5 System Handbook

Methods Applied and Interpretation of Parameters:

- Measurement Conditions:** Further details are available from the Validation Report at the end of the certificate. All figures stated in the certificate are valid at the frequency indicated.
- Antenna Parameters with TSL:** The dipole is mounted with the spacer to position its feed point exactly below the center marking of the flat phantom section, with the arms oriented parallel to the body axis.
- Feed Point Impedance and Return Loss:** These parameters are measured with the dipole positioned under the liquid filled phantom. The impedance stated is transformed from the measurement at the SMA connector to the feed point. The Return Loss ensures low reflected power. No uncertainty required.
- Electrical Delay:** One-way delay between the SMA connector and the antenna feed point. No uncertainty required.
- SAR measured:** SAR measured at the stated antenna input power.
- SAR normalized:** SAR as measured, normalized to an input power of 1 W at the antenna connector.
- SAR for nominal TSL parameters:** The measured TSL parameters are used to calculate the nominal SAR result.

The reported uncertainty of measurement is stated as the standard uncertainty of measurement multiplied by the coverage factor $k=2$, which for a normal distribution corresponds to a coverage probability of approximately 95%.

Measurement Conditions

DASY system configuration, as far as not given on page 1.

DASY Version	DASY5	V52.8.8
Extrapolation	Advanced Extrapolation	
Phantom	Modular Flat Phantom	
Distance Dipole Center - TSL	10 mm	with Spacer
Zoom Scan Resolution	dx, dy, dz = 5 mm	
Frequency	2450 MHz \pm 1 MHz	

Head TSL parameters

The following parameters and calculations were applied.

	Temperature	Permittivity	Conductivity
Nominal Head TSL parameters	22.0 °C	39.2	1.80 mho/m
Measured Head TSL parameters	(22.0 \pm 0.2) °C	39.1 \pm 6 %	1.85 mho/m \pm 6 %
Head TSL temperature change during test	< 0.5 °C	----	----

SAR result with Head TSL

SAR averaged over 1 cm ³ (1 g) of Head TSL	Condition	
SAR measured	250 mW input power	13.1 W/kg
SAR for nominal Head TSL parameters	normalized to 1W	51.7 W/kg \pm 17.0 % (k=2)

SAR averaged over 10 cm ³ (10 g) of Head TSL	condition	
SAR measured	250 mW input power	6.16 W/kg
SAR for nominal Head TSL parameters	normalized to 1W	24.5 W/kg \pm 16.5 % (k=2)

Body TSL parameters

The following parameters and calculations were applied.

	Temperature	Permittivity	Conductivity
Nominal Body TSL parameters	22.0 °C	52.7	1.95 mho/m
Measured Body TSL parameters	(22.0 \pm 0.2) °C	53.2 \pm 6 %	2.00 mho/m \pm 6 %
Body TSL temperature change during test	< 0.5 °C	----	----

SAR result with Body TSL

SAR averaged over 1 cm ³ (1 g) of Body TSL	Condition	
SAR measured	250 mW input power	13.3 W/kg
SAR for nominal Body TSL parameters	normalized to 1W	52.7 W/kg \pm 17.0 % (k=2)

SAR averaged over 10 cm ³ (10 g) of Body TSL	condition	
SAR measured	250 mW input power	6.25 W/kg
SAR for nominal Body TSL parameters	normalized to 1W	24.9 W/kg \pm 16.5 % (k=2)

Appendix (Additional assessments outside the scope of SCS 0108)

Antenna Parameters with Head TSL

Impedance, transformed to feed point	53.7 Ω + 2.4 j Ω
Return Loss	- 27.4 dB

Antenna Parameters with Body TSL

Impedance, transformed to feed point	49.6 Ω + 5.0 j Ω
Return Loss	- 26.0 dB

General Antenna Parameters and Design

Electrical Delay (one direction)	1.160 ns
----------------------------------	----------

After long term use with 100W radiated power, only a slight warming of the dipole near the feedpoint can be measured.

The dipole is made of standard semirigid coaxial cable. The center conductor of the feeding line is directly connected to the second arm of the dipole. The antenna is therefore short-circuited for DC-signals. On some of the dipoles, small end caps are added to the dipole arms in order to improve matching when loaded according to the position as explained in the "Measurement Conditions" paragraph. The SAR data are not affected by this change. The overall dipole length is still according to the Standard.

No excessive force must be applied to the dipole arms, because they might bend or the soldered connections near the feedpoint may be damaged.

Additional EUT Data

Manufactured by	SPEAG
Manufactured on	October 06, 2011

DASY5 Validation Report for Head TSL

Date: 02.09.2015

Test Laboratory: SPEAG, Zurich, Switzerland

DUT: Dipole 2450 MHz; Type: D2450V2; Serial: D2450V2 - SN: 889

Communication System: UID 0 - CW; Frequency: 2450 MHz

Medium parameters used: $f = 2450$ MHz; $\sigma = 1.85$ S/m; $\epsilon_r = 39.1$; $\rho = 1000$ kg/m³

Phantom section: Flat Section

Measurement Standard: DASY5 (IEEE/IEC/ANSI C63.19-2011)

DASY52 Configuration:

- Probe: EX3DV4 - SN7349; ConvF(7.67, 7.67, 7.67); Calibrated: 30.12.2014;
- Sensor-Surface: 2mm (Mechanical Surface Detection)
- Electronics: DAE4 Sn601; Calibrated: 17.08.2015
- Phantom: Flat Phantom 5.0 (front); Type: QD000P50AA; Serial: 1001
- DASY52 52.8.8(1222); SEMCAD X 14.6.10(7331)

Dipole Calibration for Head Tissue/Pin=250 mW, d=10mm/Zoom Scan (7x7x7)/Cube 0:

Measurement grid: dx=5mm, dy=5mm, dz=5mm

Reference Value = 105.1 V/m; Power Drift = 0.04 dB

Peak SAR (extrapolated) = 26.8 W/kg

SAR(1 g) = 13.1 W/kg; SAR(10 g) = 6.16 W/kg

Maximum value of SAR (measured) = 19.8 W/kg

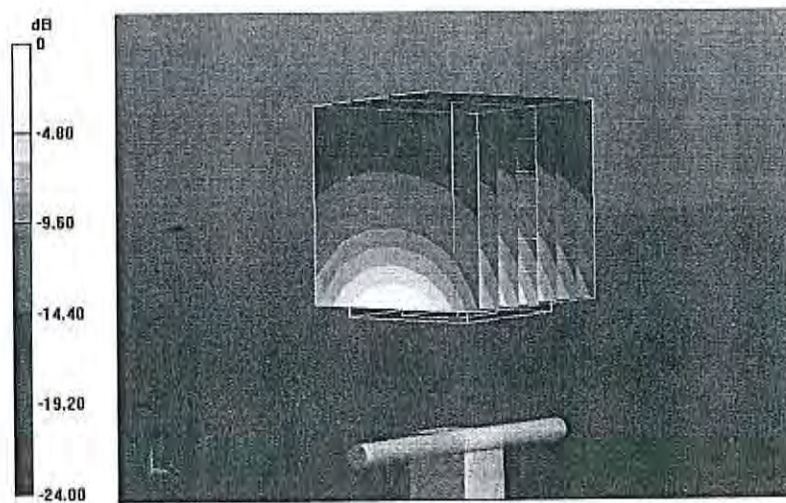

0 dB = 19.8 W/kg = 12.97 dBW/kg

Impedance Measurement Plot for Head TSL

2 Sep 2015 18:14:37
[CH1] S11 1 U FS 1: 53.701 Ω 2: 3887 Ω 155.17 μH 2 450.000 000 MHz

*
De1
Cor

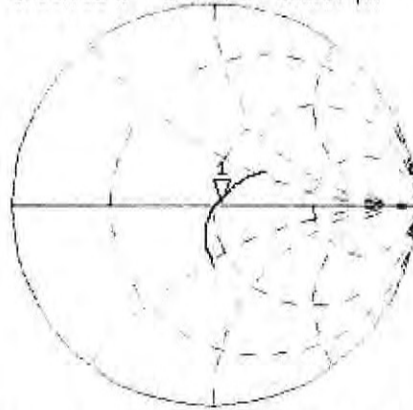

Avg
16

H1d

CH2 S11 LOG 5 dB/REF -20 dB 1: -27.430 dB 2 450.000 000 MHz

Cor

Avg
16

H1d

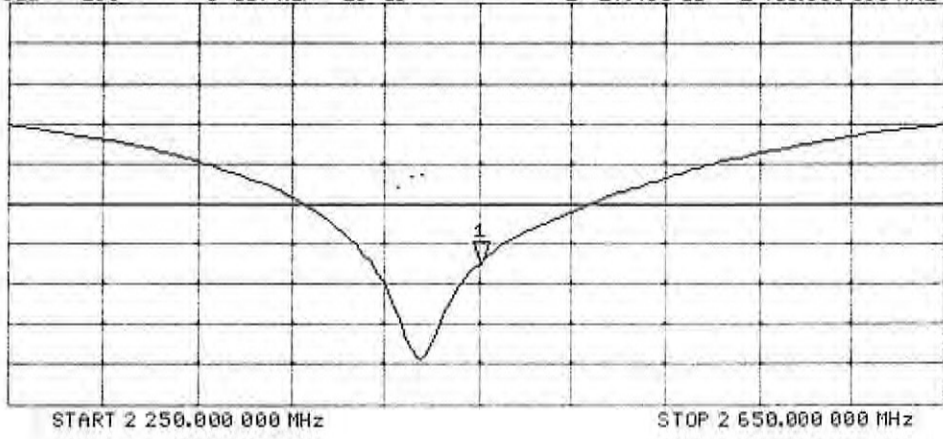

DASY5 Validation Report for Body TSL

Date: 02.09.2015

Test Laboratory: SPEAG, Zurich, Switzerland

DUT: Dipole 2450 MHz; Type: D2450V2; Serial: D2450V2 - SN: 889

Communication System: UID 0 - CW; Frequency: 2450 MHz

Medium parameters used: $f = 2450$ MHz; $\sigma = 2$ S/m; $\epsilon_r = 53.2$; $\rho = 1000$ kg/m³

Phantom section: Flat Section

Measurement Standard: DASY5 (IEEE/IEC/ANSI C63.19-2011)

DASY52 Configuration:

- Probe: EX3DV4 - SN7349; ConvF(7.53, 7.53, 7.53); Calibrated: 30.12.2014;
- Sensor-Surface: 2mm (Mechanical Surface Detection)
- Electronics: DAE4 Sn601; Calibrated: 17.08.2015
- Phantom: Flat Phantom 5.0 (back); Type: QD000P50AA; Serial: 1002
- DASY52 52.8.8(1222); SEMCAD X 14.6.10(7331)

Dipole Calibration for Body Tissue/Pin=250 mW, d=10mm/Zoom Scan (7x7x7)/Cube 0:

Measurement grid: dx=5mm, dy=5mm, dz=5mm

Reference Value = 101.3 V/m; Power Drift = 0.02 dB

Peak SAR (extrapolated) = 26.4 W/kg

SAR(1 g) = 13.3 W/kg; SAR(10 g) = 6.25 W/kg

Maximum value of SAR (measured) = 19.9 W/kg

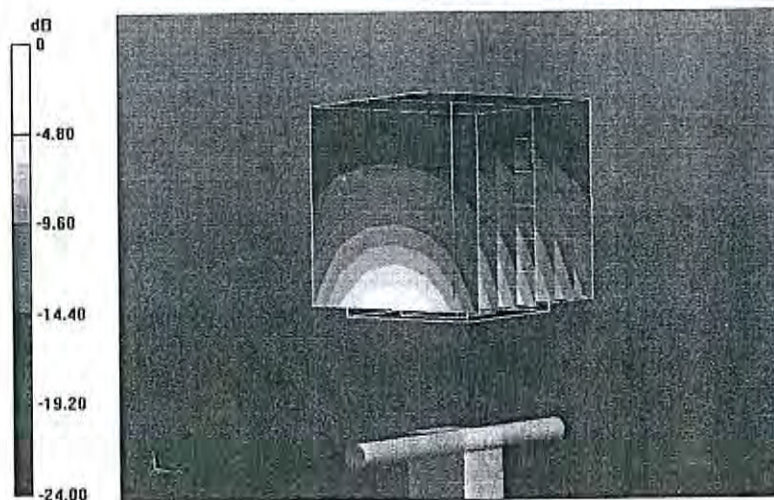

0 dB = 19.9 W/kg = 12.99 dBW/kg

Impedance Measurement Plot for Body TSL

2 Sep 2015 18:14:10
[CH1] S11 1 U FS 1: 49.619 Ω 4.9648 μ 322.52 pF 2 450.000 000 MHz

*
Del
Cor

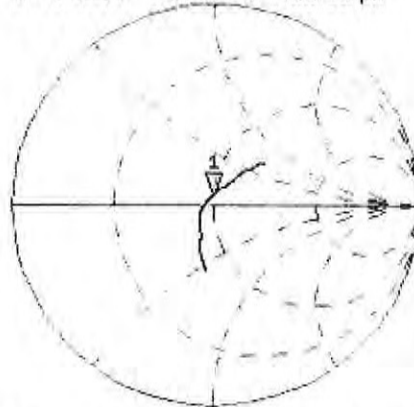

Avg
16

H1d

CH2 S11 LOG 5 dB/REF -20 dB 1: -26.031 dB 2 450.000 000 MHz

Cor

Avg
16

H1d

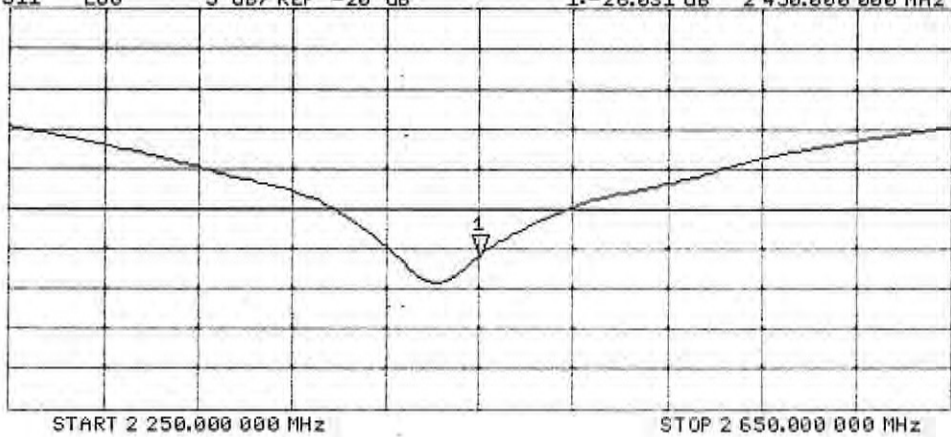



Accredited by the Swiss Accreditation Service (SAS)
The Swiss Accreditation Service is one of the signatories to the EA
Multilateral Agreement for the recognition of calibration certificates

Accreditation No.: **SCS 0108**

Client **BNN-SPEAG Laboratory**

Certificate No: **D1750V2-1066_Sep15**

CALIBRATION CERTIFICATE

Object **D1750V2 - SN: 1066**

Calibration procedure(s) **QA CAL-05.v9**
Calibration procedure for dipole validation kits above 700 MHz

Calibration date: **September 03, 2015**

This calibration certificate documents the traceability to national standards, which realize the physical units of measurements (SI).
The measurements and the uncertainties with confidence probability are given on the following pages and are part of the certificate.

All calibrations have been conducted in the closed laboratory facility: environment temperature $(22 \pm 3)^\circ\text{C}$ and humidity $< 70\%$.

Calibration Equipment used (M&TE critical for calibration)

Primary Standards	ID #	Cal Date (Certificate No.)	Scheduled Calibration
Power meter EPM-442A	GB37480704	07-Oct-14 (No. 217-02020)	Oct-15
Power sensor HP 8481A	US37292783	07-Oct-14 (No. 217-02020)	Oct-15
Power sensor HP 8481A	MY41092317	07-Oct-14 (No. 217-02021)	Oct-15
Reference 20 dB Attenuator	SN: 5058 (20k)	01-Apr-15 (No. 217-02131)	Mar-16
Type-N mismatch combination	SN: 5047.2 / 06327	01-Apr-15 (No. 217-02134)	Mar-16
Reference Probe EX3DV4	SN: 7349	30-Dec-14 (No. EX3-7349_Dec14)	Dec-15
DAE4	SN: 601	17-Aug-15 (No. DAE4-601_Aug15)	Aug-16
Secondary Standards	ID #	Check Date (in house)	Scheduled Check
RF generator R&S SMT-06	100005	04-Aug-99 (in house check Oct-13)	In house check: Oct-16
Network Analyzer HP 8753E	US37390585 S4206	18-Oct-01 (in house check Oct-14)	In house check: Oct-15

Calibrated by: **Michael Weber** Name: **Michael Weber** Function: **Laboratory Technician**

Approved by: **Katja Pokovic** Name: **Katja Pokovic** Function: **Technical Manager**

Signature

Issued: September 3, 2015

This calibration certificate shall not be reproduced except in full without written approval of the laboratory.



Accredited by the Swiss Accreditation Service (SAS)
The Swiss Accreditation Service is one of the signatories to the EA
Multilateral Agreement for the recognition of calibration certificates

Accreditation No.: **SCS 0108**

Glossary:

TSL	tissue simulating liquid
ConvF	sensitivity in TSL / NORM x,y,z
N/A	not applicable or not measured

Calibration is Performed According to the Following Standards:

- IEEE Std 1528-2013, "IEEE Recommended Practice for Determining the Peak Spatial-Averaged Specific Absorption Rate (SAR) in the Human Head from Wireless Communications Devices: Measurement Techniques", June 2013
- IEC 62209-1, "Procedure to measure the Specific Absorption Rate (SAR) for hand-held devices used in close proximity to the ear (frequency range of 300 MHz to 3 GHz)", February 2005
- IEC 62209-2, "Procedure to determine the Specific Absorption Rate (SAR) for wireless communication devices used in close proximity to the human body (frequency range of 30 MHz to 6 GHz)", March 2010
- KDB 865664, "SAR Measurement Requirements for 100 MHz to 6 GHz"

Additional Documentation:

- DASY4/5 System Handbook

Methods Applied and Interpretation of Parameters:

- Measurement Conditions:** Further details are available from the Validation Report at the end of the certificate. All figures stated in the certificate are valid at the frequency indicated.
- Antenna Parameters with TSL:** The dipole is mounted with the spacer to position its feed point exactly below the center marking of the flat phantom section, with the arms oriented parallel to the body axis.
- Feed Point Impedance and Return Loss:** These parameters are measured with the dipole positioned under the liquid filled phantom. The impedance stated is transformed from the measurement at the SMA connector to the feed point. The Return Loss ensures low reflected power. No uncertainty required.
- Electrical Delay:** One-way delay between the SMA connector and the antenna feed point. No uncertainty required.
- SAR measured:** SAR measured at the stated antenna input power.
- SAR normalized:** SAR as measured, normalized to an input power of 1 W at the antenna connector.
- SAR for nominal TSL parameters:** The measured TSL parameters are used to calculate the nominal SAR result.

The reported uncertainty of measurement is stated as the standard uncertainty of measurement multiplied by the coverage factor $k=2$, which for a normal distribution corresponds to a coverage probability of approximately 95%.

Measurement Conditions

DASY system configuration, as far as not given on page 1.

DASY Version	DASY5	V52.8.8
Extrapolation	Advanced Extrapolation	
Phantom	Modular Flat Phantom	
Distance Dipole Center - TSL	10 mm	with Spacer
Zoom Scan Resolution	dx, dy, dz = 5 mm	
Frequency	1750 MHz \pm 1 MHz	

Head TSL parameters

The following parameters and calculations were applied.

	Temperature	Permittivity	Conductivity
Nominal Head TSL parameters	22.0 °C	40.1	1.37 mho/m
Measured Head TSL parameters	(22.0 \pm 0.2) °C	39.9 \pm 6 %	1.36 mho/m \pm 6 %
Head TSL temperature change during test	< 0.5 °C	----	----

SAR result with Head TSL

SAR averaged over 1 cm ³ (1 g) of Head TSL	Condition	
SAR measured	250 mW input power	9.16 W/kg
SAR for nominal Head TSL parameters	normalized to 1W	36.8 W/kg \pm 17.0 % (k=2)

SAR averaged over 10 cm ³ (10 g) of Head TSL	condition	
SAR measured	250 mW input power	4.87 W/kg
SAR for nominal Head TSL parameters	normalized to 1W	19.5 W/kg \pm 16.5 % (k=2)

Body TSL parameters

The following parameters and calculations were applied.

	Temperature	Permittivity	Conductivity
Nominal Body TSL parameters	22.0 °C	53.4	1.49 mho/m
Measured Body TSL parameters	(22.0 \pm 0.2) °C	52.1 \pm 6 %	1.48 mho/m \pm 6 %
Body TSL temperature change during test	< 0.5 °C	----	----

SAR result with Body TSL

SAR averaged over 1 cm ³ (1 g) of Body TSL	Condition	
SAR measured	250 mW input power	9.15 W/kg
SAR for nominal Body TSL parameters	normalized to 1W	36.5 W/kg \pm 17.0 % (k=2)

SAR averaged over 10 cm ³ (10 g) of Body TSL	condition	
SAR measured	250 mW input power	4.88 W/kg
SAR for nominal Body TSL parameters	normalized to 1W	19.5 W/kg \pm 16.5 % (k=2)

Appendix (Additional assessments outside the scope of SCS 0108)

Antenna Parameters with Head TSL

Impedance, transformed to feed point	49.5 Ω - 0.5 j Ω
Return Loss	- 42.8 dB

Antenna Parameters with Body TSL

Impedance, transformed to feed point	46.7 Ω - 1.0 j Ω
Return Loss	- 28.9 dB

General Antenna Parameters and Design

Electrical Delay (one direction)	1.219 ns
----------------------------------	----------

After long term use with 100W radiated power, only a slight warming of the dipole near the feedpoint can be measured.

The dipole is made of standard semirigid coaxial cable. The center conductor of the feeding line is directly connected to the second arm of the dipole. The antenna is therefore short-circuited for DC-signals. On some of the dipoles, small end caps are added to the dipole arms in order to improve matching when loaded according to the position as explained in the "Measurement Conditions" paragraph. The SAR data are not affected by this change. The overall dipole length is still according to the Standard.

No excessive force must be applied to the dipole arms, because they might bend or the soldered connections near the feedpoint may be damaged.

Additional EUT Data

Manufactured by	SPEAG
Manufactured on	June 15, 2010

DASY5 Validation Report for Head TSL

Date: 03.09.2015

Test Laboratory: SPEAG, Zurich, Switzerland

DUT: Dipole 1750 MHz; Type: D1750V2; Serial: D1750V2 - SN: 1066

Communication System: UID 0 - CW; Frequency: 1750 MHz

Medium parameters used: $f = 1750$ MHz; $\sigma = 1.36$ S/m; $\epsilon_r = 39.9$; $\rho = 1000$ kg/m³

Phantom section: Flat Section

Measurement Standard: DASY5 (IEEE/IEC/ANSI C63.19-2011)

DASY52 Configuration:

- Probe: EX3DV4 - SN7349; ConvF(8.38, 8.38, 8.38); Calibrated: 30.12.2014;
- Sensor-Surface: 2mm (Mechanical Surface Detection)
- Electronics: DAE4 Sn601; Calibrated: 17.08.2015
- Phantom: Flat Phantom 5.0 (front); Type: QD000P50AA; Serial: 1001
- DASY52 52.8.8(1222); SEMCAD X 14.6.10(7331)

Dipole Calibration for Head Tissue/Pin=250 mW, d=10mm/Zoom Scan (7x7x7)/Cube 0:

Measurement grid: dx=5mm, dy=5mm, dz=5mm

Reference Value = 98.10 V/m; Power Drift = 0.00 dB

Peak SAR (extrapolated) = 16.6 W/kg

SAR(1 g) = 9.16 W/kg; SAR(10 g) = 4.87 W/kg

Maximum value of SAR (measured) = 12.8 W/kg

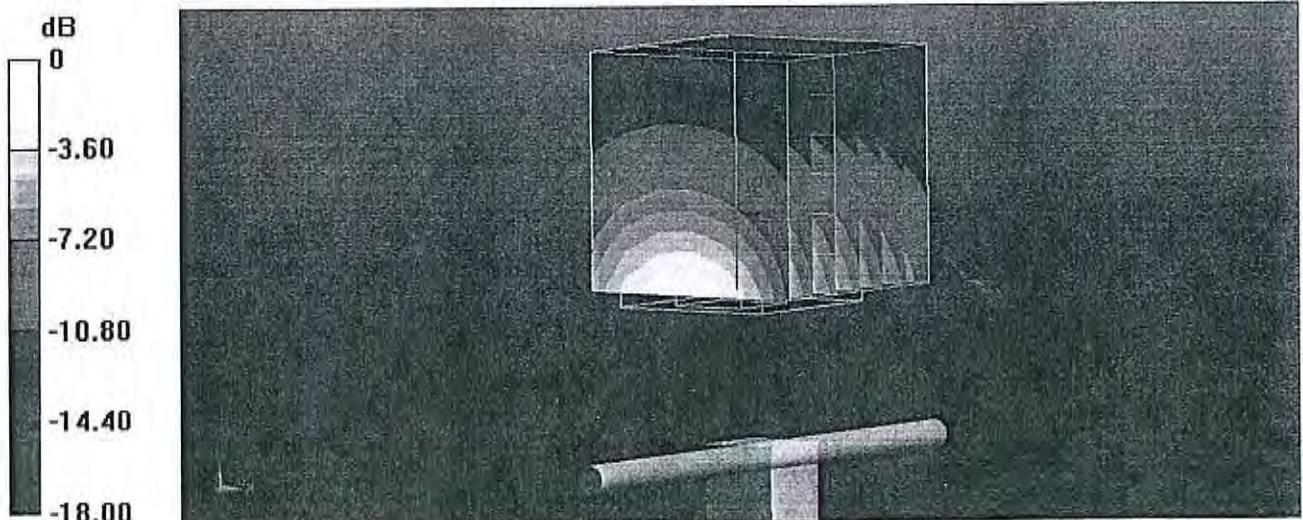

0 dB = 12.8 W/kg = 11.07 dBW/kg

Impedance Measurement Plot for Head TSL

2 Sep 2015 14:48:09
[CH1] S11 1 U FS 1: 49.459 Ω -478.52 $m\Omega$ 190.06 pF 1 750.000 000 MHz

*
Del
Cor

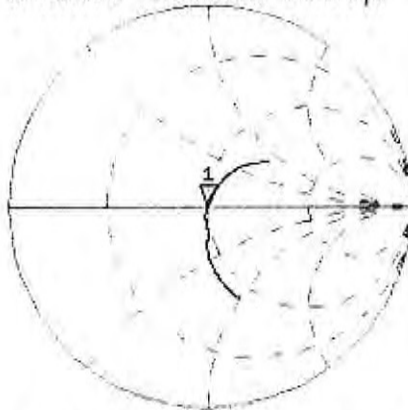

Avg
16

H1d

CH2 S11 LOG 5 dB/REF -20 dB 1:-42.797 dB 1 750.000 000 MHz

Cor

Avg
16

H1d

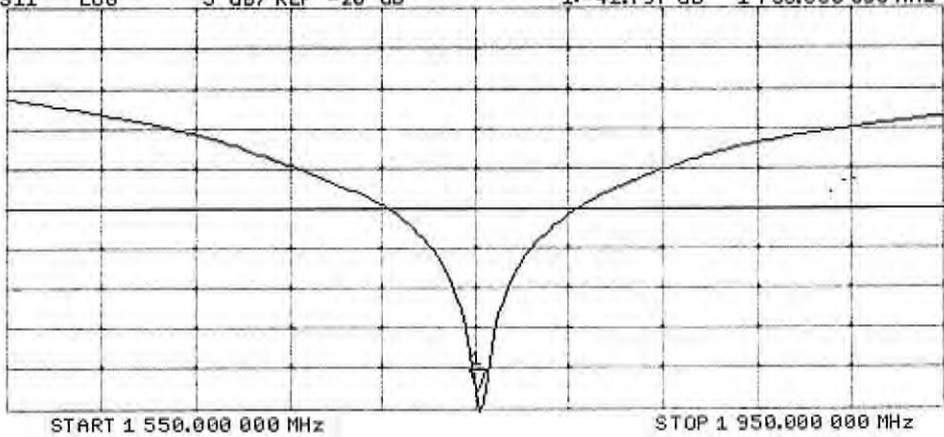

DASY5 Validation Report for Body TSL

Date: 03.09.2015

Test Laboratory: SPEAG, Zurich, Switzerland

DUT: Dipole 1750 MHz; Type: D1750V2; Serial: D1750V2 - SN: 1066

Communication System: UID 0 - CW; Frequency: 1750 MHz

Medium parameters used: $f = 1750$ MHz; $\sigma = 1.48$ S/m; $\epsilon_r = 52.1$; $\rho = 1000$ kg/m³

Phantom section: Flat Section

Measurement Standard: DASY5 (IEEE/IEC/ANSI C63.19-2011)

DASY52 Configuration:

- Probe: EX3DV4 - SN7349; ConvF(8.25, 8.25, 8.25); Calibrated: 30.12.2014;
- Sensor-Surface: 2mm (Mechanical Surface Detection)
- Electronics: DAE4 Sn601; Calibrated: 17.08.2015
- Phantom: Flat Phantom 5.0 (back); Type: QD000P50AA; Serial: 1002
- DASY52 52.8.8(1222); SEMCAD X 14.6.10(7331)

Dipole Calibration for Body Tissue/Pin=250 mW, d=10mm/Zoom Scan (7x7x7)/Cube 0:

Measurement grid: dx=5mm, dy=5mm, dz=5mm

Reference Value = 95.02 V/m; Power Drift = 0.03 dB

Peak SAR (extrapolated) = 16.2 W/kg

SAR(1 g) = 9.15 W/kg; SAR(10 g) = 4.88 W/kg

Maximum value of SAR (measured) = 12.9 W/kg

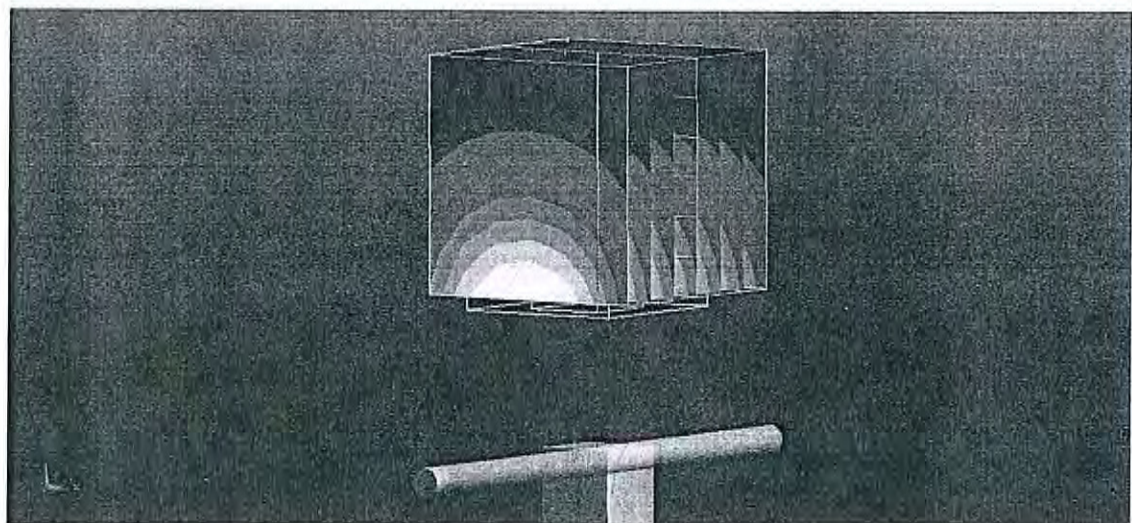

0 dB = 12.9 W/kg = 11.11 dBW/kg

Impedance Measurement Plot for Body TSL

2 Sep 2015 14:47:30
[CH1] S11 1 U FS 1: 46.664 Ω -1.0293 Ω 88.357 pF 1 750.000 000 MHz

*
Del
Cor

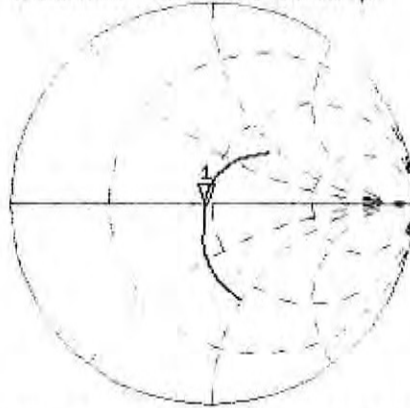

Avg
16

H1d

CH2 S11 LOG 5 dB/REF -20 dB 1:-28.851 dB 1 750.000 000 MHz

Cor

Avg
16

H1d

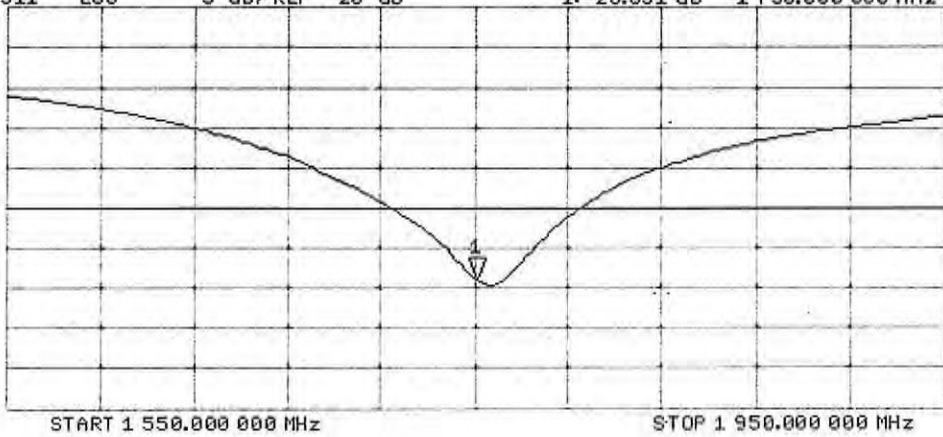



Accredited by the Swiss Accreditation Service (SAS)
The Swiss Accreditation Service is one of the signatories to the EA
Multilateral Agreement for the recognition of calibration certificates

Accreditation No.: **SCS 108**

Client **BNN-SPEAG Laboratory**

Certificate No: **D1900V2-5d157_May12**

CALIBRATION CERTIFICATE

Object **D1900V2 - SN: 5d157**

Calibration procedure(s) **QA CAL-05.v8
Calibration procedure for dipole validation kits above 700 MHz**

Calibration date: **May 09, 2012**

This calibration certificate documents the traceability to national standards, which realize the physical units of measurements (SI).
The measurements and the uncertainties with confidence probability are given on the following pages and are part of the certificate.

All calibrations have been conducted in the closed laboratory facility: environment temperature (22 ± 3)°C and humidity < 70%.

Calibration Equipment used (M&TE critical for calibration)

Primary Standards	ID #	Cal Date (Certificate No.)	Scheduled Calibration
Power meter EPM-442A	GB37480704	05-Oct-11 (No. 217-01451)	Oct-12
Power sensor HP 8481A	US37292783	05-Oct-11 (No. 217-01451)	Oct-12
Reference 20 dB Attenuator	SN: 5058 (20k)	27-Mar-12 (No. 217-01530)	Apr-13
Type-N mismatch combination	SN: 5047.2 / 06327	27-Mar-12 (No. 217-01533)	Apr-13
Reference Probe ES3DV3	SN: 3205	30-Dec-11 (No. ES3-3205_Dec11)	Dec-12
DAE4	SN: 601	04-Jul-11 (No. DAE4-601_Jul11)	Jul-12
Secondary Standards	ID #	Check Date (in house)	Scheduled Check
Power sensor HP 8481A	MY41092317	18-Oct-02 (in house check Oct-11)	In house check: Oct-13
RF generator R&S SMT-06	100005	04-Aug-99 (in house check Oct-11)	In house check: Oct-13
Network Analyzer HP 8753E	US37390585 S4206	18-Oct-01 (in house check Oct-11)	In house check: Oct-12

Calibrated by:	Name Israe El-Naouq	Function Laboratory Technician	Signature
Approved by:	Katja Pokovic	Technical Manager	

Issued: May 9, 2012

This calibration certificate shall not be reproduced except in full without written approval of the laboratory.



Accredited by the Swiss Accreditation Service (SAS)
The Swiss Accreditation Service is one of the signatories to the EA
Multilateral Agreement for the recognition of calibration certificates

Glossary:

TSL	tissue simulating liquid
ConvF	sensitivity in TSL / NORM x,y,z
N/A	not applicable or not measured

Calibration is Performed According to the Following Standards:

- IEEE Std 1528-2003, "IEEE Recommended Practice for Determining the Peak Spatial-Averaged Specific Absorption Rate (SAR) in the Human Head from Wireless Communications Devices: Measurement Techniques", December 2003
- IEC 62209-1, "Procedure to measure the Specific Absorption Rate (SAR) for hand-held devices used in close proximity to the ear (frequency range of 300 MHz to 3 GHz)", February 2005
- Federal Communications Commission Office of Engineering & Technology (FCC OET), "Evaluating Compliance with FCC Guidelines for Human Exposure to Radiofrequency Electromagnetic Fields; Additional Information for Evaluating Compliance of Mobile and Portable Devices with FCC Limits for Human Exposure to Radiofrequency Emissions", Supplement C (Edition 01-01) to Bulletin 65

Additional Documentation:

- DASY4/5 System Handbook

Methods Applied and Interpretation of Parameters:

- Measurement Conditions:** Further details are available from the Validation Report at the end of the certificate. All figures stated in the certificate are valid at the frequency indicated.
- Antenna Parameters with TSL:** The dipole is mounted with the spacer to position its feed point exactly below the center marking of the flat phantom section, with the arms oriented parallel to the body axis.
- Feed Point Impedance and Return Loss:** These parameters are measured with the dipole positioned under the liquid filled phantom. The impedance stated is transformed from the measurement at the SMA connector to the feed point. The Return Loss ensures low reflected power. No uncertainty required.
- Electrical Delay:** One-way delay between the SMA connector and the antenna feed point. No uncertainty required.
- SAR measured:** SAR measured at the stated antenna input power.
- SAR normalized:** SAR as measured, normalized to an input power of 1 W at the antenna connector.
- SAR for nominal TSL parameters:** The measured TSL parameters are used to calculate the nominal SAR result.

The reported uncertainty of measurement is stated as the standard uncertainty of measurement multiplied by the coverage factor $k=2$, which for a normal distribution corresponds to a coverage probability of approximately 95%.

Measurement Conditions

DASY system configuration, as far as not given on page 1.

DASY Version	DASY5	V52.8.1
Extrapolation	Advanced Extrapolation	
Phantom	Modular Flat Phantom	
Distance Dipole Center - TSL	10 mm	with Spacer
Zoom Scan Resolution	dx, dy, dz = 5 mm	
Frequency	1900 MHz \pm 1 MHz	

Head TSL parameters

The following parameters and calculations were applied.

	Temperature	Permittivity	Conductivity
Nominal Head TSL parameters	22.0 °C	40.0	1.40 mho/m
Measured Head TSL parameters	(22.0 \pm 0.2) °C	40.5 \pm 6 %	1.37 mho/m \pm 6 %
Head TSL temperature change during test	< 0.5 °C	----	----

SAR result with Head TSL

SAR averaged over 1 cm ³ (1 g) of Head TSL	Condition	
SAR measured	250 mW input power	9.76 mW / g
SAR for nominal Head TSL parameters	normalized to 1W	39.7 mW /g \pm 17.0 % (k=2)

SAR averaged over 10 cm ³ (10 g) of Head TSL	condition	
SAR measured	250 mW input power	5.16 mW / g
SAR for nominal Head TSL parameters	normalized to 1W	20.8 mW /g \pm 16.5 % (k=2)

Appendix

Antenna Parameters with Head TSL

Impedance, transformed to feed point	53.0 Ω + 5.0 j Ω
Return Loss	- 25.0 dB

General Antenna Parameters and Design

Electrical Delay (one direction)	1.198 ns
----------------------------------	----------

After long term use with 100W radiated power, only a slight warming of the dipole near the feedpoint can be measured.

The dipole is made of standard semirigid coaxial cable. The center conductor of the feeding line is directly connected to the second arm of the dipole. The antenna is therefore short-circuited for DC-signals. On some of the dipoles, small end caps are added to the dipole arms in order to improve matching when loaded according to the position as explained in the "Measurement Conditions" paragraph. The SAR data are not affected by this change. The overall dipole length is still according to the Standard.

No excessive force must be applied to the dipole arms, because they might bend or the soldered connections near the feedpoint may be damaged.

Additional EUT Data

Manufactured by	SPEAG
Manufactured on	December 20, 2011

DASY5 Validation Report for Head TSL

Date: 09.05.2012

Test Laboratory: SPEAG, Zurich, Switzerland

DUT: Dipole 1900 MHz; Type: D1900V2; Serial: D1900V2 - SN: 5d157

Communication System: CW; Frequency: 1900 MHz

Medium parameters used: $f = 1900$ MHz; $\sigma = 1.37$ mho/m; $\epsilon_r = 40.5$; $\rho = 1000$ kg/m³

Phantom section: Flat Section

Measurement Standard: DASY5 (IEEE/IEC/ANSI C63.19-2007)

DASY52 Configuration:

- Probe: ES3DV3 - SN3205; ConvF(5.01, 5.01, 5.01); Calibrated: 30.12.2011;
- Sensor-Surface: 3mm (Mechanical Surface Detection)
- Electronics: DAE4 Sn601; Calibrated: 04.07.2011
- Phantom: Flat Phantom 5.0 (front); Type: QD000P50AA; Serial: 1001
- DASY52 52.8.1(838); SEMCAD X 14.6.5(6469)

Dipole Calibration for Head Tissue/Pin=250 mW, d=10mm/Zoom Scan (7x7x7)/Cube 0:

Measurement grid: dx=5mm, dy=5mm, dz=5mm

Reference Value = 97.303 V/m; Power Drift = 0.04 dB

Peak SAR (extrapolated) = 17.392 mW/g

SAR(1 g) = 9.76 mW/g; SAR(10 g) = 5.16 mW/g

Maximum value of SAR (measured) = 12.0 mW/g



0 dB = 12.0 mW/g = 21.58 dB mW/g

Impedance Measurement Plot for Head TSL

9 May 2012 09:48:55

[CH1] S11 1 U FS 1: 52.961 Ω 4.9980 Ω 418.67 pF 1 900.000 000 MHz

*
De1
Cor

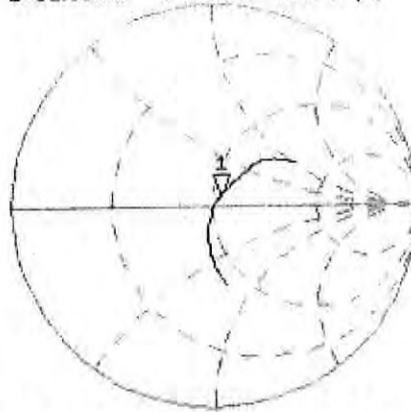

Avg
16

H1d

CH2 S11 LOG 5 dB/REF -20 dB 1: -24.980 dB 1 900.000 000 MHz

De1
Cor

Avg
16

H1d

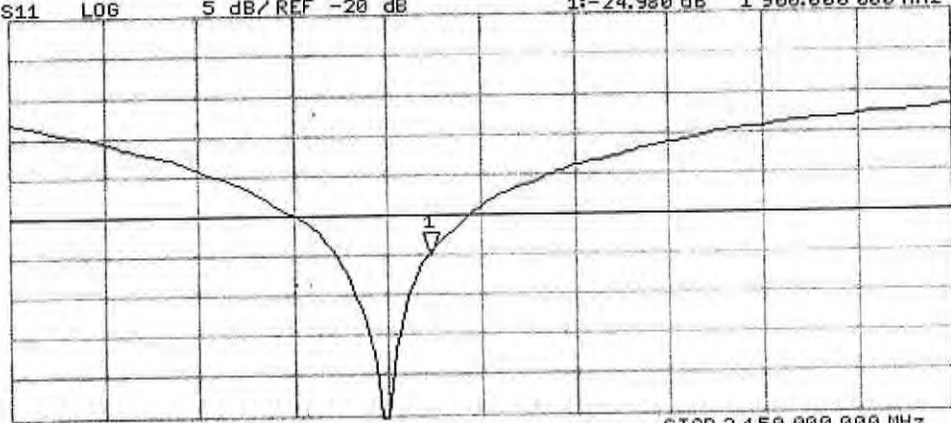

START 1 700.000 000 MHz

STOP 2 150.000 000 MHz



Accredited by the Swiss Accreditation Service (SAS) —
The Swiss Accreditation Service is one of the signatories to the EA
Multilateral Agreement for the recognition of calibration certificates

Accreditation No.: **SCS 0108**

Client **BNN-SPEAG Laboratory**

Certificate No: **D850V2-1017_Sep15**

CALIBRATION CERTIFICATE

Object **D850V2 - SN: 1017**

Calibration procedure(s) **QA CAL-05.v9**
Calibration procedure for dipole validation kits above 700 MHz

Calibration date: **September 21, 2015**

This calibration certificate documents the traceability to national standards, which realize the physical units of measurements (SI).
The measurements and the uncertainties with confidence probability are given on the following pages and are part of the certificate.

All calibrations have been conducted in the closed laboratory facility: environment temperature (22 ± 3)°C and humidity < 70%.

Calibration Equipment used (M&TE critical for calibration)

Primary Standards	ID #	Cal Date (Certificate No.)	Scheduled Calibration
Power meter EPM-442A	GB37480704	07-Oct-14 (No. 217-02020)	Oct-15
Power sensor HP 8481A	US37292783	07-Oct-14 (No. 217-02020)	Oct-15
Power sensor HP 8481A	MY41092317	07-Oct-14 (No. 217-02021)	Oct-15
Reference 20 dB Attenuator	SN: 5058 (20k)	01-Apr-15 (No. 217-02131)	Mar-16
Type-N mismatch combination	SN: 5047.2 / 06327	01-Apr-15 (No. 217-02134)	Mar-16
Reference Probe EX3DV4	SN: 7349	30-Dec-14 (No. EX3-7349_Dec14)	Dec-15
DAE4	SN: 601	17-Aug-15 (No. DAE4-601_Aug15)	Aug-16
Secondary Standards	ID #	Check Date (in house)	Scheduled Check
RF generator R&S SMT-06	100972	15-Jun-15 (in house check Jun-15)	In house check: Jun-18
Network Analyzer HP 8753E	US37390585 S4206	18-Oct-01 (in house check Oct-14)	In house check: Oct-15

Calibrated by: **Israe Elnaouq** Name: **Israe Elnaouq** Function: **Laboratory Technician**

Approved by: **Katja Pokovic** Name: **Katja Pokovic** Function: **Technical Manager**

Signature
Israe Elnaouq
Katja Pokovic

Issued: September 23, 2015

This calibration certificate shall not be reproduced except in full without written approval of the laboratory.



Accredited by the Swiss Accreditation Service (SAS)
The Swiss Accreditation Service is one of the signatories to the EA
Multilateral Agreement for the recognition of calibration certificates

Accreditation No.: **SCS 0108**

Glossary:

TSL	tissue simulating liquid
ConvF	sensitivity in TSL / NORM x,y,z
N/A	not applicable or not measured

Calibration is Performed According to the Following Standards:

- IEEE Std 1528-2013, "IEEE Recommended Practice for Determining the Peak Spatial-Averaged Specific Absorption Rate (SAR) in the Human Head from Wireless Communications Devices: Measurement Techniques", June 2013
- IEC 62209-1, "Procedure to measure the Specific Absorption Rate (SAR) for hand-held devices used in close proximity to the ear (frequency range of 300 MHz to 3 GHz)", February 2005
- IEC 62209-2, "Procedure to determine the Specific Absorption Rate (SAR) for wireless communication devices used in close proximity to the human body (frequency range of 30 MHz to 6 GHz)", March 2010
- KDB 865664, "SAR Measurement Requirements for 100 MHz to 6 GHz"

Additional Documentation:

- DASY4/5 System Handbook

Methods Applied and Interpretation of Parameters:

- Measurement Conditions:* Further details are available from the Validation Report at the end of the certificate. All figures stated in the certificate are valid at the frequency indicated.
- Antenna Parameters with TSL:* The dipole is mounted with the spacer to position its feed point exactly below the center marking of the flat phantom section, with the arms oriented parallel to the body axis.
- Feed Point Impedance and Return Loss:* These parameters are measured with the dipole positioned under the liquid filled phantom. The impedance stated is transformed from the measurement at the SMA connector to the feed point. The Return Loss ensures low reflected power. No uncertainty required.
- Electrical Delay:* One-way delay between the SMA connector and the antenna feed point. No uncertainty required.
- SAR measured:* SAR measured at the stated antenna input power.
- SAR normalized:* SAR as measured, normalized to an input power of 1 W at the antenna connector.
- SAR for nominal TSL parameters:* The measured TSL parameters are used to calculate the nominal SAR result.

The reported uncertainty of measurement is stated as the standard uncertainty of measurement multiplied by the coverage factor $k=2$, which for a normal distribution corresponds to a coverage probability of approximately 95%.

Measurement Conditions

DASY system configuration, as far as not given on page 1.

DASY Version	DASY5	V52.8.8
Extrapolation	Advanced Extrapolation	
Phantom	Modular Flat Phantom	
Distance Dipole Center - TSL	15 mm	with Spacer
Zoom Scan Resolution	dx, dy, dz = 5 mm	
Frequency	850 MHz \pm 1 MHz	

Head TSL parameters

The following parameters and calculations were applied.

	Temperature	Permittivity	Conductivity
Nominal Head TSL parameters	22.0 °C	41.5	0.92 mho/m
Measured Head TSL parameters	(22.0 \pm 0.2) °C	41.8 \pm 6 %	0.94 mho/m \pm 6 %
Head TSL temperature change during test	< 0.5 °C	----	----

SAR result with Head TSL

SAR averaged over 1 cm ³ (1 g) of Head TSL	Condition	
SAR measured	250 mW input power	2.41 W/kg
SAR for nominal Head TSL parameters	normalized to 1W	9.50 W/kg \pm 17.0 % (k=2)

SAR averaged over 10 cm ³ (10 g) of Head TSL	condition	
SAR measured	250 mW input power	1.56 W/kg
SAR for nominal Head TSL parameters	normalized to 1W	6.17 W/kg \pm 16.5 % (k=2)

Body TSL parameters

The following parameters and calculations were applied.

	Temperature	Permittivity	Conductivity
Nominal Body TSL parameters	22.0 °C	55.2	0.99 mho/m
Measured Body TSL parameters	(22.0 \pm 0.2) °C	53.7 \pm 6 %	1.01 mho/m \pm 6 %
Body TSL temperature change during test	< 0.5 °C	----	----

SAR result with Body TSL

SAR averaged over 1 cm ³ (1 g) of Body TSL	Condition	
SAR measured	250 mW input power	2.53 W/kg
SAR for nominal Body TSL parameters	normalized to 1W	9.91 W/kg \pm 17.0 % (k=2)

SAR averaged over 10 cm ³ (10 g) of Body TSL	condition	
SAR measured	250 mW input power	1.65 W/kg
SAR for nominal Body TSL parameters	normalized to 1W	6.50 W/kg \pm 16.5 % (k=2)

Appendix (Additional assessments outside the scope of SCS 0108)

Antenna Parameters with Head TSL

Impedance, transformed to feed point	50.1 Ω - 5.2 j Ω
Return Loss	- 25.7 dB

Antenna Parameters with Body TSL

Impedance, transformed to feed point	46.8 Ω - 7.0 j Ω
Return Loss	- 22.0 dB

General Antenna Parameters and Design

Electrical Delay (one direction)	1.427 ns
----------------------------------	----------

After long term use with 100W radiated power, only a slight warming of the dipole near the feedpoint can be measured.

The dipole is made of standard semirigid coaxial cable. The center conductor of the feeding line is directly connected to the second arm of the dipole. The antenna is therefore short-circuited for DC-signals. On some of the dipoles, small end caps are added to the dipole arms in order to improve matching when loaded according to the position as explained in the "Measurement Conditions" paragraph. The SAR data are not affected by this change. The overall dipole length is still according to the Standard.

No excessive force must be applied to the dipole arms, because they might bend or the soldered connections near the feedpoint may be damaged.

Additional EUT Data

Manufactured by	SPEAG
Manufactured on	February 18, 2015

DASY5 Validation Report for Head TSL

Date: 07.09.2015

Test Laboratory: SPEAG, Zurich, Switzerland

DUT: Dipole 850 MHz; Type: D850V2; Serial: D850V2 - SN: 1017

Communication System: UID 0 - CW; Frequency: 850 MHz

Medium parameters used: $f = 850$ MHz; $\sigma = 0.94$ S/m; $\epsilon_r = 41.8$; $\rho = 1000$ kg/m³

Phantom section: Flat Section

Measurement Standard: DASY5 (IEEE/IEC/ANSI C63.19-2011)

DASY52 Configuration:

- Probe: EX3DV4 - SN7349; ConvF(9.76, 9.76, 9.76); Calibrated: 30.12.2014;
- Sensor-Surface: 1.4mm (Mechanical Surface Detection)
- Electronics: DAE4 Sn601; Calibrated: 17.08.2015
- Phantom: Flat Phantom 4.9L; Type: QD000P49AA; Serial: 1001
- DASY52 52.8.8(1222); SEMCAD X 14.6.10(7331)

Dipole Calibration for Head Tissue/Pin=250 mW, d=15mm/Zoom Scan (7x7x7)/Cube 0:

Measurement grid: dx=5mm, dy=5mm, dz=5mm

Reference Value = 62.03 V/m; Power Drift = -0.06 dB

Peak SAR (extrapolated) = 3.72 W/kg

SAR(1 g) = 2.41 W/kg; SAR(10 g) = 1.56 W/kg

Maximum value of SAR (measured) = 3.26 W/kg

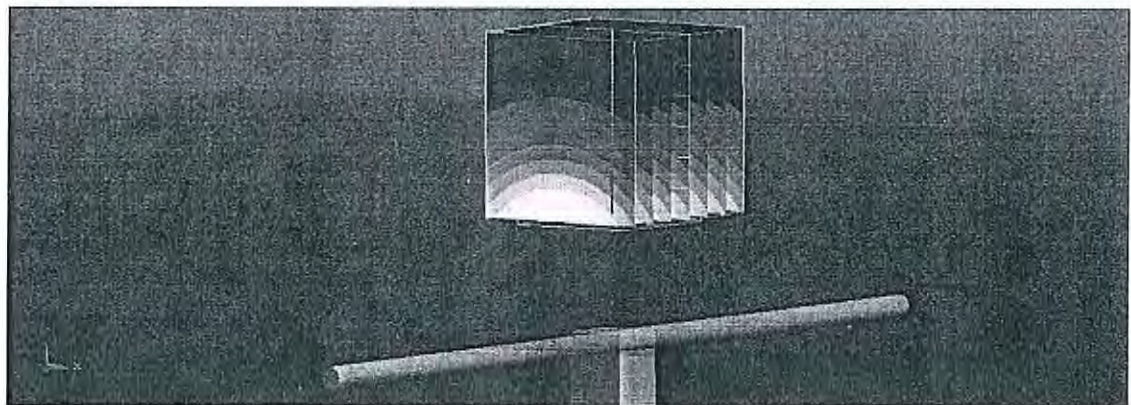

0 dB = 3.26 W/kg = 5.13 dBW/kg

Impedance Measurement Plot for Head TSL

[CH1] S11 1 U FS 2: 50.131 Ω -5.1934 Ω 36.054 pF 7 Sep 2015 10:28:34 850.000 000 MHz

*
De l
Ca

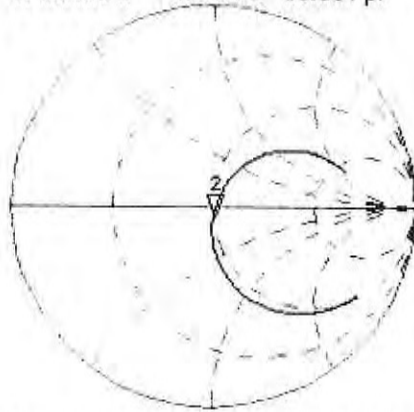

Avg
16

H1 d

CH2 S11 LOG 5 dB/REF -20 dB 2:-25.706 dB 850.000 000 MHz

Ca

Avg
16

H1 d

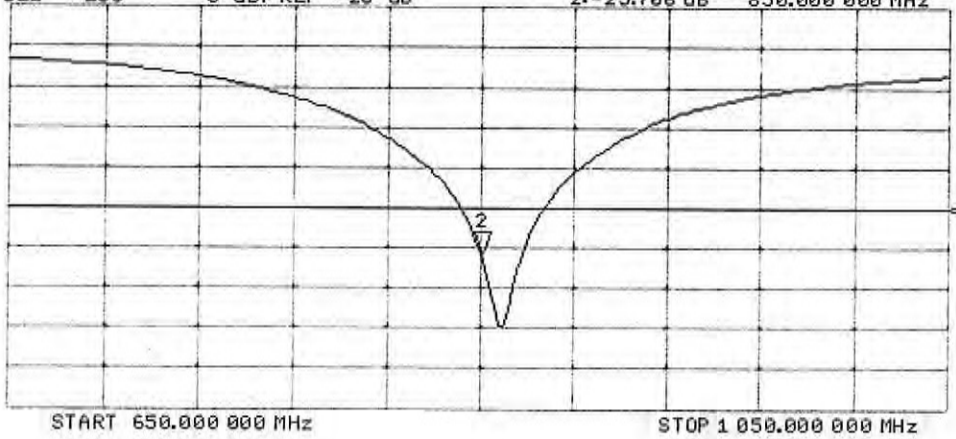

DASY5 Validation Report for Body TSL

Date: 14.09.2015

Test Laboratory: SPEAG, Zurich, Switzerland

DUT: Dipole 850 MHz; Type: D850V2; Serial: D850V2 - SN: 1017

Communication System: UID 0 - CW; Frequency: 850 MHz

Medium parameters used: $f = 850$ MHz; $\sigma = 1.01$ S/m; $\epsilon_r = 53.7$; $\rho = 1000$ kg/m³

Phantom section: Flat Section

Measurement Standard: DASY5 (IEEE/IEC/ANSI C63.19-2011)

DASY52 Configuration:

- Probe: EX3DV4 - SN7349; ConvF(9.39, 9.39, 9.39); Calibrated: 30.12.2014;
- Sensor-Surface: 1.4mm (Mechanical Surface Detection)
- Electronics: DAE4 Sn601; Calibrated: 17.08.2015
- Phantom: Flat Phantom 4.9L; Type: QD000P49AA; Serial: 1001
- DASY52 52.8.8(1222); SEMCAD X 14.6.10(7331)

Dipole Calibration for Body Tissue/Pin=250 mW, d=15mm/Zoom Scan (7x7x7)/Cube 0:

Measurement grid: dx=5mm, dy=5mm, dz=5mm

Reference Value = 60.97 V/m; Power Drift = 0.02 dB

Peak SAR (extrapolated) = 3.78 W/kg

SAR(1 g) = 2.53 W/kg; SAR(10 g) = 1.65 W/kg

Maximum value of SAR (measured) = 3.34 W/kg

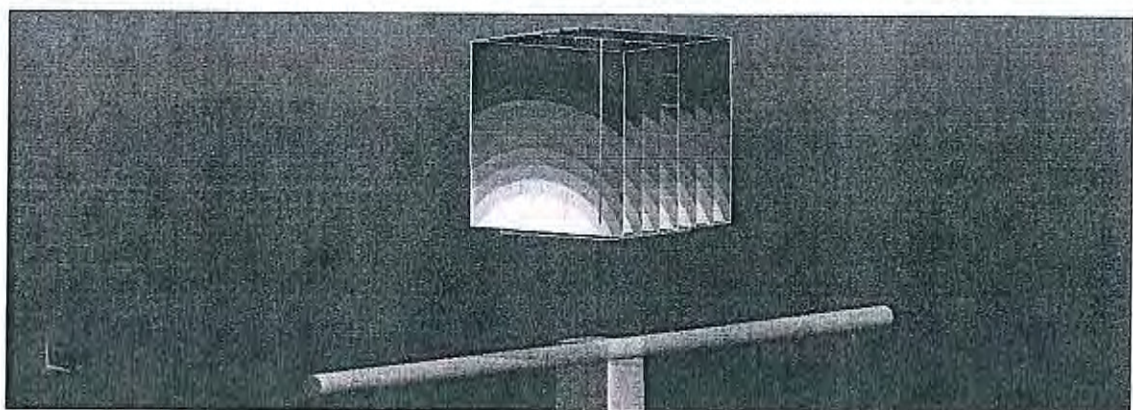
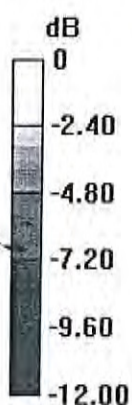

0 dB = 3.34 W/kg = 5.24 dBW/kg

Impedance Measurement Plot for Body TSL

14 Sep 2015 11:17:40
[CH1] S11 1 U FS 1: 46.750 Ω -6.9863 Ω 26.801 pF 850.000 000 MHz

*
De1
CA

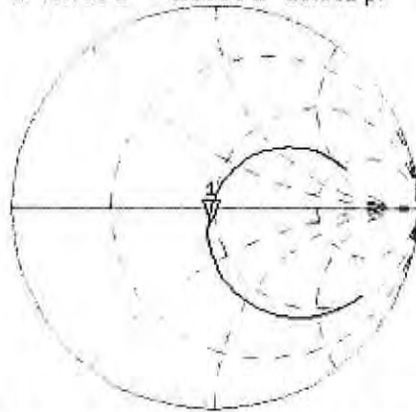

Avg
16

H1d

CH2 S11 LOG 5 dB/REF -20 dB 1: -22.002 dB 850.000 000 MHz

De1

CA

Avg
16

H1d

