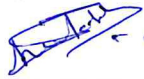
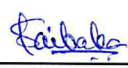

Produkte
Products

Prüfbericht - Nr.: 19660244 001		Seite 1 von 74			
<i>Test Report No.:</i>		<i>Page 1 of 74</i>			
Auftraggeber: <i>Client:</i>	HANDHELD GROUP AB Kinnegatan 17 A 531 33 Lidköping Sweden Tel: +46 (0) 510-54 71 70				
Gegenstand der Prüfung: <i>Test item:</i>	Rugged 7" Tablet				
Bezeichnung: <i>Identification:</i>	118207	Serien-Nr.: <i>Serial No.</i>	Engineering Sample		
Wareneingangs-Nr.: <i>Receipt No.:</i>	1803156247	Eingangsdatum: <i>Date of receipt:</i>	20.07.2016		
Prüfort: <i>Testing location:</i>	Refer Page 4 of 74 for test facilities				
Prüfgrundlage: <i>Test specification:</i>	FCC Part 2, Part 22H, Part 24E & RSS 132 Issue 3, RSS 133 Issue 6, ANSI C63.10-2013 & TIA-603-D-2010				
Prüfergebnis: <i>Test Result:</i>	Der Prüfgegenstand entspricht oben genannter Prüfgrundlage(n). <i>The test items passed the test specification(s).</i>				
Prüflaboratorium: <i>Testing Laboratory:</i>	TÜV Rheinland (India) Pvt. Ltd. 82/A, 3rd Main, West Wing, Electronic City Phase 1 Hosur Road, Bangalore – 560 100. India FCC Registration No.: 176555 & IC OATS Reg. Number.: 3466E				
geprüft / tested by:		kontrolliert / reviewed by:			
06.10.2016	Shrikanth S Naik Sr.Engineer		18.10.2016	Saibaba Siddapur Assistant Manager	
Datum <i>Date</i>	Name/Stellung <i>Name/Position</i>	Unterschrift <i>Signature</i>	Datum <i>Date</i>	Name/Stellung <i>Name/Position</i>	Unterschrift <i>Signature</i>
Sonstiges / Other Aspects: FCC ID : YY3-118207 & IC : 11695A-118207					
Abkürzungen:			Abbreviations:		
P(ass) = entspricht Prüfgrundlage F(ail) = entspricht nicht Prüfgrundlage N/A = nicht anwendbar N/T = nicht getestet			P(ass) = passed F(ail) = failed N/A = not applicable N/T = not tested		
Dieser Prüfbericht bezieht sich nur auf das o.g. Prüfmuster und darf ohne Genehmigung der Prüfstelle nicht auszugsweise vervielfältigt werden. Dieser Bericht berechtigt nicht zur Verwendung eines Prüfzeichens. <i>This test report relates to the a. m. test sample. Without permission of the test center this test report is not permitted to be duplicated in extracts. This test report does not entitle to carry any safety mark on this or similar products.</i>					

TÜV Rheinland India Pvt. Ltd. 82/A, 3rd Main, West Wing Electronic City Phase 1, Hosur Road, Bangalore-560100, India
 Tel.: +9180 6723 3500 · Fax: +9180 6723 3542 · Web: www.tuv.com

Test Result Summary

Test Item	Clause		Result
	FCC	IC	
RF Output Power– Conducted Mode	FCC Part 2.1046	RSS 132 Issue 3 section 5.4, SRSP-503 section 5.1.3 & RSS 133 Issue 6 section 4.1/6.4, SRSP-510.5.1.2	Pass
99% Occupied Bandwidth & 26dB Emission Bandwidth	FCC Part 2.1049	RSS-Gen Issue 4 section 6.6	Pass
Band Edge Compliance	FCC Part 2.1051, 22.917(a)(b), 24.238(a)(b)	RSS 132 Issue 3 section 5.5(i)(ii), RSS 133 Issue 6 section 6.5.1 (i)(ii)	Pass
Conducted Spurious Emission	FCC Part 2.1051, 22.917(a)(b) 24.238(a)(b)	RSS 132 Issue 3 section 5.5 (i)(ii) & RSS 133 Issue 6 section 6.5.1 (i)(ii)	Pass
Frequency Stability	FCC Part 2.1055(a)(1), 22.355, 24.235	RSS 132 Issue 3 section 5.3 , RSS 133 Issue 6 section 6.3	Pass
RF Output Power (ERP/EIRP) – Radiated Mode	FCC Part 2.1046, 22.913(a)(2) 24.232(c)	RSS 132 Issue 3 section 5.4, SRSP-503 section 5.1.3 & RSS 133 Issue 6 section 4.1/6.4, SRSP-510.5.1.2	Pass
Field Strength of Spurious Radiation	FCC Part 2.1053(a), 22.917(a)(b), 24.238(a)(b)	RSS 132 Issue 3 section 5.5 (i)(ii) & RSS 133 Issue 6 section 6.5.1 (i)(ii)	Pass

Note: Testing Performed according to the procedure given in 971168 D01 Power Meas License Digital Systems v02r02.

Content

List of Test and Measurement Instruments.....	4
General Product Information	5
Product Function and Intended Use.....	5
Ratings and System Details.....	5
Test Set-up and Operation Mode.....	7
Principle of Configuration Selection	7
Test Operation and Test Software	7
Test Modes – Data Rates and Modulations	7
Operational description	8
Test Methodology	9
Test Results	11
RF Output Power – Conducted Mode.....	11
99% Occupied Bandwidth & 26dB Emission Bandwidth.....	31
Band Edge Measurement.....	41
Conducted Spurious Emission	48
Frequency Stability.....	67
RF Power (ERP/EIRP) – Radiated Mode	71
Field Strength of Spurious Radiation	72
Appendix 1: Test Setup Photo	
Appendix 2: EUT External Photo	
Appendix 3: EUT Internal Photo	
Appendix 4: FCC Label and Label Location	
Appendix 5: Block Diagram	
Appendix 6: Specification of EUT	
Appendix 7: Schematic Diagrams	
Appendix 8: Bill of Material	
Appendix 9: User Manual	
Appendix 10: SAR Test Report	

List of Test and Measurement Instruments

Equipment	Manufacturer	Model Name	Serial Number	Calibration Due Date	Periodicity	Used for Test Items
EMI Test Receiver	Rohde & Schwarz	ESU 40	100288	23.11.2016	Yearly	Spurious Radiated Emissions
Broadband Antenna	Frankonia	ALX-4000	ALX-4000-806	20.01.2017	Yearly	
Active Loop Antenna	Frankonia	LAX-10	LAX-10-800	22.12.2016	Yearly	
Broadband Horn Antenna	Frankonia	HAX-18	HAX18-802	14.03.2017	Yearly	
Double-Ridged Waveguide Horn Antenna	ETS Lindgren	116706	00107323	02.11.2016	Yearly	
Anechoic Chamber	Frankonia	-	-		-	
Spectrum Analyser	Agilent Technologies	E4407B	US41192772	23.04.2017	Yearly	Antenna - Port Conducted Tests
Signal Analyzer	Rohde & Schwarz	FSV7	101644	07.12.2016	Yearly	
Environmental Chamber	Envisys	EM80-40H	ET/022/14-15	09.06.2017	Yearly	
Wideband Radio Communication Tester	Rohde & Schwarz	CMW500	158345	26.09.2017	Yearly	

Testing Facilities:

TUV Rheinland (India) Private Limited
 108 , Beside ISBR Business School,
 Electronic city Phase I
 Bangalore - 560 100.

www.tuv.com

General Product Information

Product Function and Intended Use

The Algiz RT7 is a rugged tablet, designed for use by field personnel in demanding conditions. It integrates best-in-class connectivity with efficient computing and multimedia features. The tablet runs Android Lollipop (5.1.1) operating system, and comes pre-installed with many Google applications, including Google Play.

Ratings and System Details

Modulation	GSM -> GMSK ; GPRS -> GMSK & EDGE -> 8PSK
Channel Spacing	200kHz
Number of Antenna	One
Antenna Gain and Antenna type	0dBi & Integrated Antenna
Supply Voltage to Product	Internal Battery Pack -> 3.7- 4.2 VDC & Adaptor 5VDC to EUT
Environmental	Storage Temperature -> -40°C to +70 °C Operating Temperature-> -20°C to 50°C in a humidity up to 95% noncondensing

Test Conditions:

Supply Voltage: 3.7- 4.2 VDC & Adaptor 5VDC to EUT

Environmental conditions:

Temperature: +25 °C RH: 62%

www.tuv.com

Equipment used for testing as identified in below Table.

Equipment Used for	S/N Number	IMEI No.	Hardware Version	Software version
Conducted Measurement on Antenna Port	6G010057	911381250014927 & 911381250014935	Engineering Sample	Android 5.1.1, LMY47V'
Radiated Mode Test	6G010310	911381250019983 & 911381250019991	Engineering Sample	Android 5.1.1, LMY47V'

Summary of Measured Power & Emission Designator:

Mode	Measured Output Power Conducted Mode		Measured Output Power (dBm) Radiated Mode	Power Class	Maximum Power Level (PCL)	Emission Designator
	dBm	Watt				
GSM 850	31.42	1.3868	26.00	4 (2Watt)	5	245KGXW
GPRS 850	31.34	1.3614	23.50	4 (2Watt)	5	249KGXW
E-GPRS 850	27.95	0.6237	20.62	4 (2Watt)	5	245KG7W
GSM 1900	27.49	0.5610	27.45	1 (1Watt)	0	247KGXW
GPRS 1900	27.37	0.5458	26.53	1 (1Watt)	0	248KGXW
E-GPRS 1900	26.21	0.4178	26.51	1 (1Watt)	0	253KG7W

Note: Product Rugged 7" Tablet has multiple protocols. All the supported wireless protocols and their respective test reports are as in the below table.

Radio Protocol	Report Number
NFC	19660243 001
Wi-Fi (IEEE 802.11bgn)	19660240 001
BLE	19660242 001
Bluetooth (BDR+EDR)	19660241 001
W-CDMA	19660245 001
LTE	19660246 001

www.tuv.com

Test Set-up and Operation Mode

Principle of Configuration Selection

Transmission was enabled with help of CMW500 on low, mid and high channel

Test Operation and Test Software

No Special Test software used for enabling the Transmission, SIM inserted in EUT to communicate with CMW500 simulator

Special Accessories and Auxiliary Equipment

- None

Countermeasures to achieve EMC Compliance

A ferrite bead was used on the USB cable which is connected to the adaptor (accessory) closer to the DUT during testing. Refer appendix 1 for test setup photos.

Ferrite no. 742 711 12 & 742 717 33 (make: Würth Electronics).

Test Modes – Data Rates and Modulations

For Radiated spurious emissions, the tests were performed for all data rates and only worst case results are reported in this report.

GSM/PCS - Frequency List of Low/Mid/High channel				
Frequency Band	Channel/Frequency (MHz)	Low	Mid	High
GSM850	Channel No.	128	190	251
	Frequency	824.2	836.6	848.8
PCS1900	Channel No.	512	661	810
	Frequency	1850.2	1880	1909.8

GSM/PCS Frequency band details

Frequency Band	Uplink Frequency (MHz)	Downlink Frequency (MHz)
GSM850	824.2 – 849.2	869.2 – 893.8
PCS1900	1850.2 – 1909.8	1930.2 – 1989.8

www.tuv.com

Operational description

Whether you're collecting data, crunching numbers or viewing graphics, the Algiz RT7's powerful Qualcomm quad-core processor provides reliable, uninterrupted work performance.

And the Algiz RT7 doesn't just run Android flawlessly — its capacitive touchscreen also enhances the Android experience with five-point multi-touch capability, 600-nit high-brightness sunlight readability and chemically strengthened glass.

Yet the Algiz RT7 also meets stringent MIL-STD-810G military standards for withstanding extreme temperatures, drops and vibrations, and its IP65 rating means it's waterproof and fully protected against sand and dust.

www.tuv.com

Test Methodology

Frequency Range 9 kHz -30 MHz

Test performed as per ANSI C63.10-2013 section 6.4

The loop Antenna was placed at 1m above the ground plane & EUT is 3 meters far from the measuring antenna. With 3m measurement distance, correction data were applied to the measured results. The test arrangement, measuring antenna guidelines and operational configurations in 6.3.1 and 6.3.2, shall be followed. The measurement antenna shall be positioned with its plane perpendicular to the ground at the Specified distance, when perpendicular to the ground plane, the lowest height of the magnetic antenna shall be 1 m above the ground and shall be positioned at the specified distance from the EUT. EUT & its associates are placed on non-conducting table of 0.8m height which is placed on the turn table, For each measurement antenna alignment, the EUT shall be rotated through 0° to 360° on a turntable. The report shall list worst case emission results, for each of the parallel & perpendicular orientations.

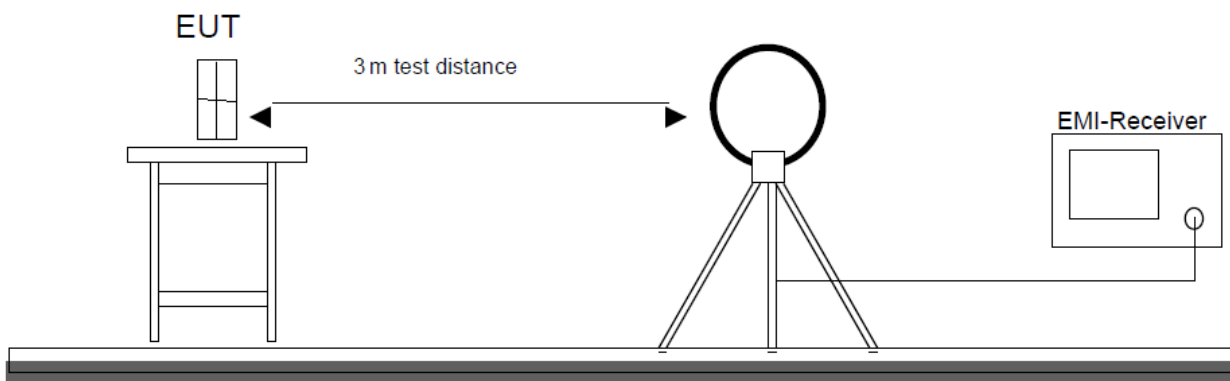

Frequency Range 30MHz to 10th harmonics of the highest fundamental frequency

Test performed as per ANSI/TIA-603-D-2010 Clause 2.2.12/17

ERP/EIRP Radiated Power & Radiated spurious emission test are performed as below.

The equipment under test is placed on non-conductive table at 3m away from the receive antenna in accordance with above mentioned standard. Turn table is rotated through 360 degree, and receiver antenna height is varied in order to determine the level of maximum emission. The maximum emission level and position of the maximized emission is recorded with use of spectrum analyzer.

The EUT is substituted by a substitution antenna. The substitute antenna is connected to a signal generator. Adjust the output level of the signal generator to get the same power recorded in with EUT and record the power level of Signal Generator. The cable loss at the test frequency should be compensated

www.tuv.com

The Power is calculated by the following formula

$$P_d \text{ (dBm)} = P_g \text{ (dBm)} - \text{Cable Loss (dB)} + \text{Antenna Gain (dB)}$$

Where

P_d is the dipole equivalent power.

P_g is the generator output power into the substitution antenna

These steps are repeated with the receiving antenna in the both vertical & horizontal polarization

Measurement Method

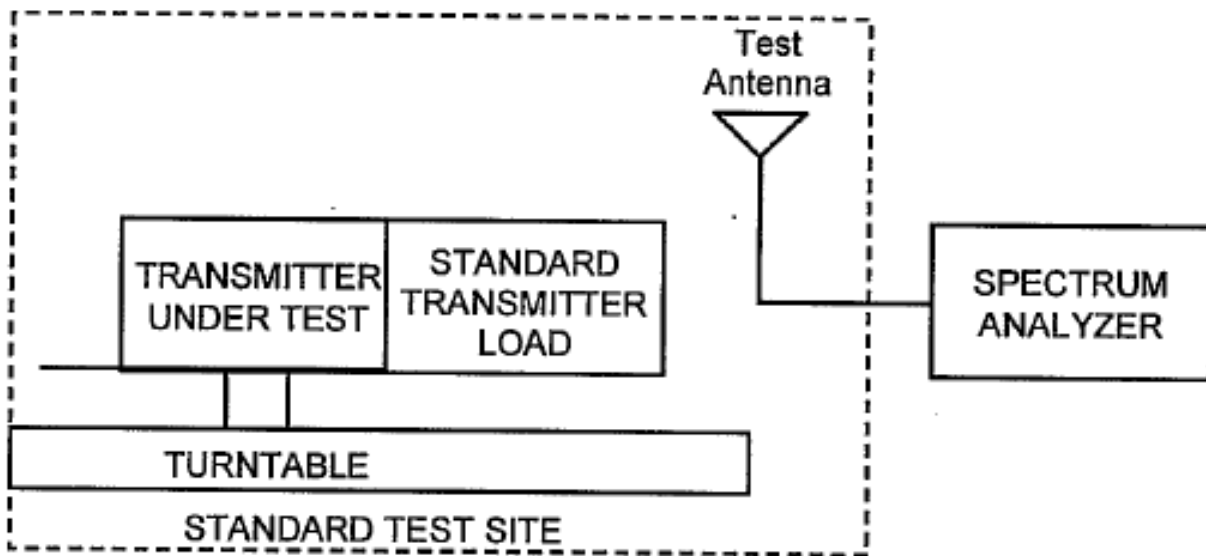

Substitute measurement method

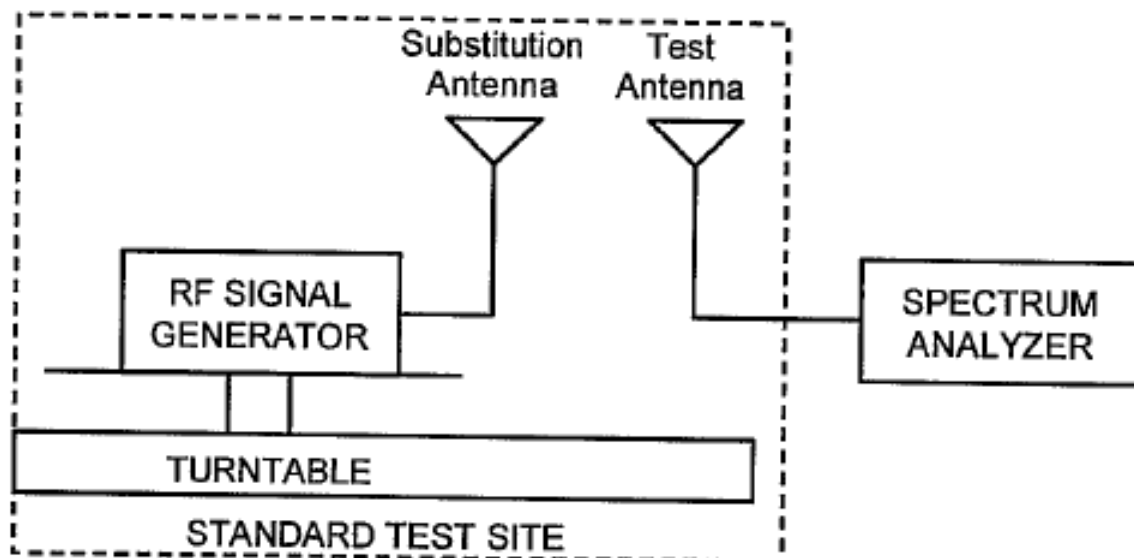

www.tuv.com

Test Results

**RF Output Power – Conducted Mode
Result**

Pass

Specification	FCC Part 2.1046(a), & RSS 132 Issue 3 section 5.4, SRSP-503 section 5.1.3 & RSS 133 Issue 6 section 4.1/6.4, SRSP-510.5.1.2
Measurement Bandwidth (RBW)	≥ OBW
Detector Function	Peak/Average

Test Setup:

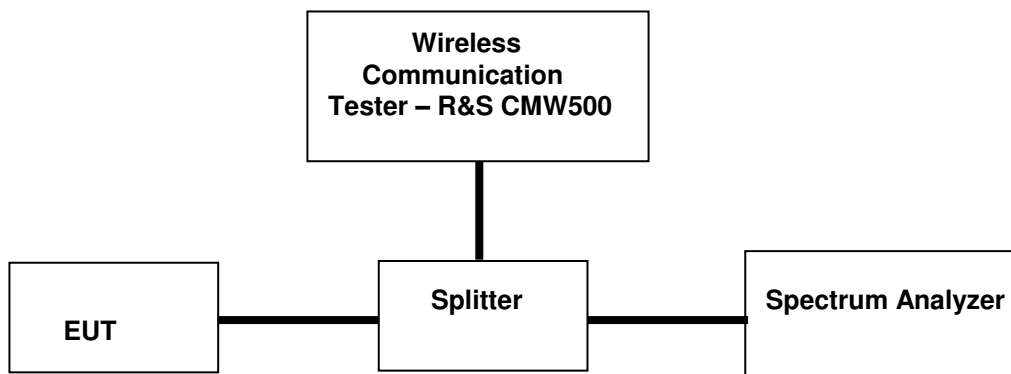

Note: For measurement of RF Output Power, section 5.1 & 5.2 in “971168 D01 Power Meas License Digital Systems v02r02” was used and Attenuator & Cable loss is included in the test results

Peak Output Power Test Results

Band	Channel Number	Channel Frequency (MHz)	Measured Power - Voice (dBm)	Measured Power - GPRS Data (dBm)	Measured Power - E-GPRS data (dBm)
GSM850	128	824.2	30.62	30.62	26.97
	190	836.6	30.74	30.71	27.24
	251	848.8	31.42	31.34	27.95
PCS1900	512	1850.2	27.39	27.37	25.99
	661	1880	27.49	27.33	25.98
	810	1909.8	27.47	27.31	26.21

www.tuv.com

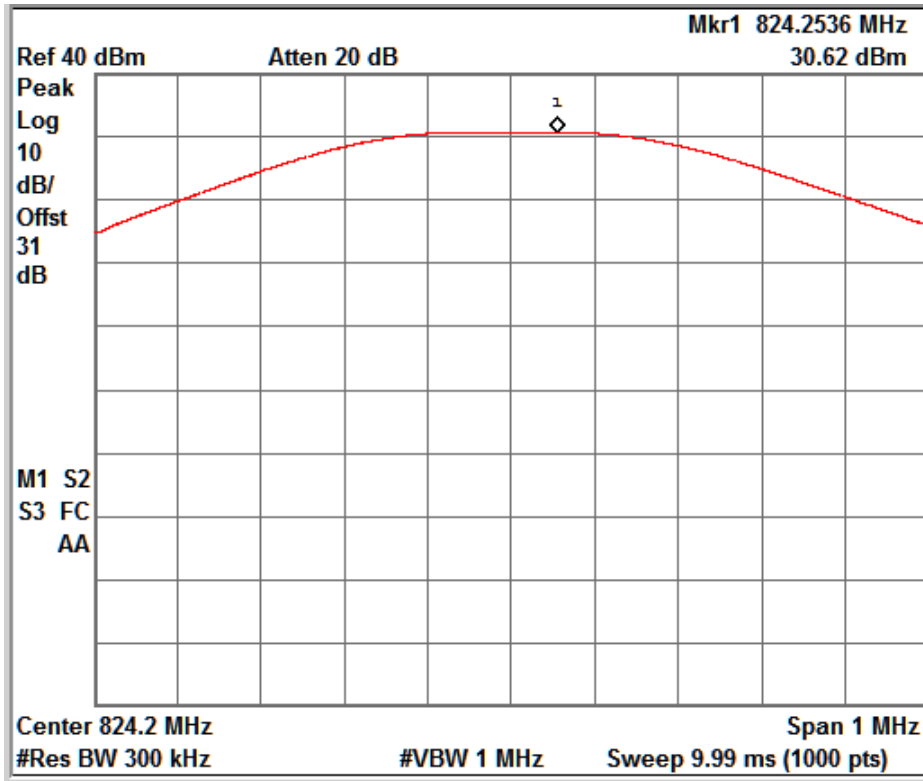

GSM_Voice_Channel No. 128

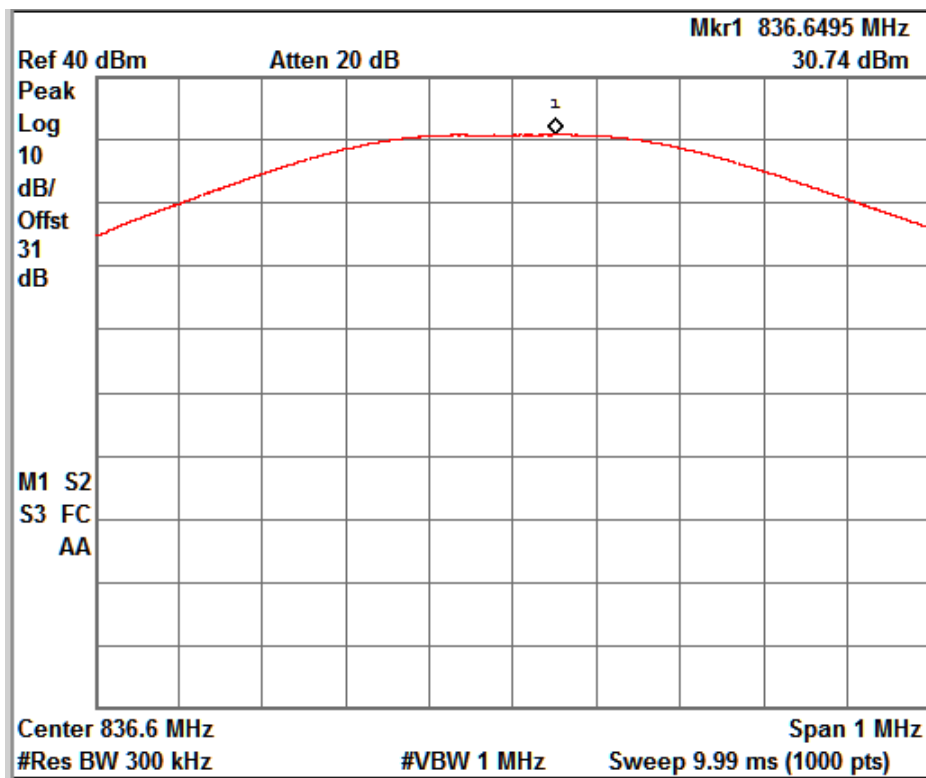

GSM_Voice_Channel No. 190

www.tuv.com

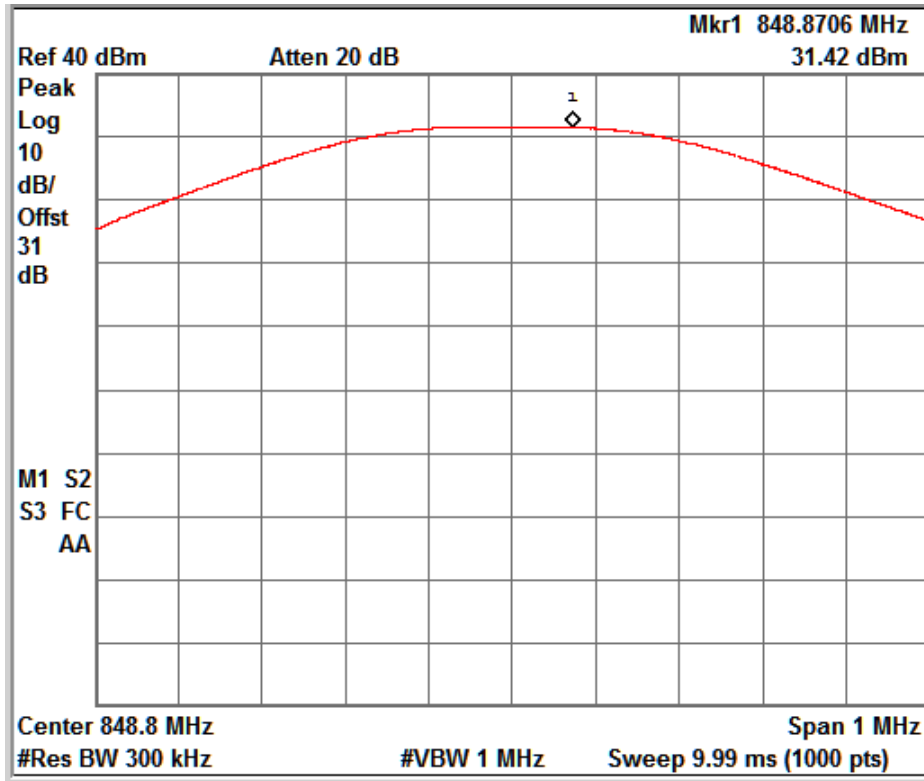

GSM_Voice_Channel No. 251

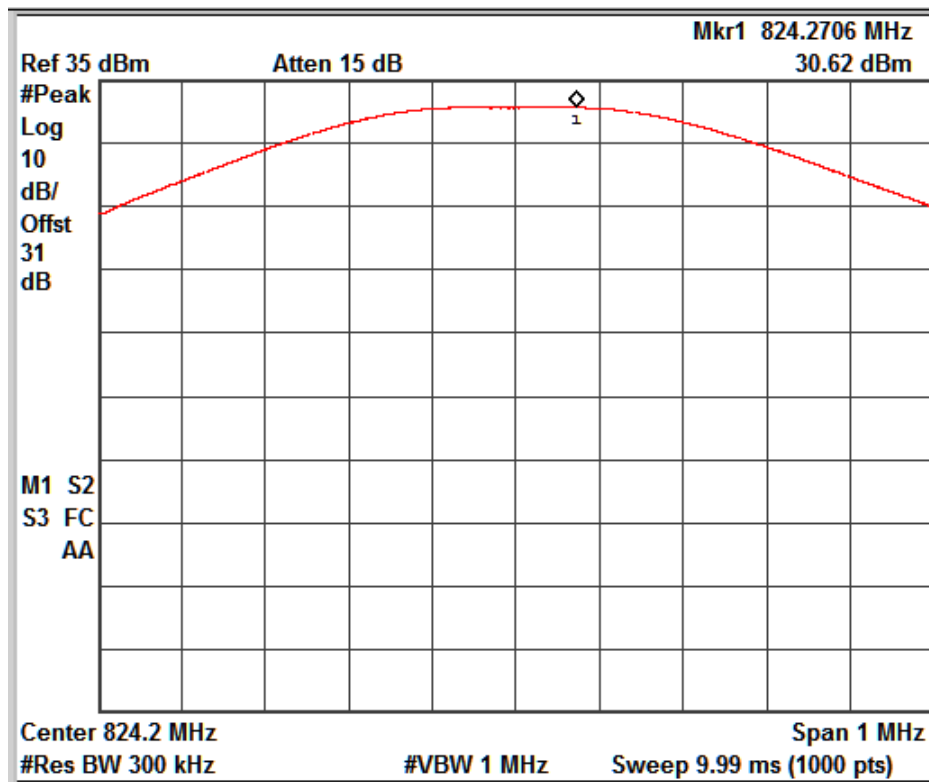

GSM_GPRS_Channel No. 128

www.tuv.com

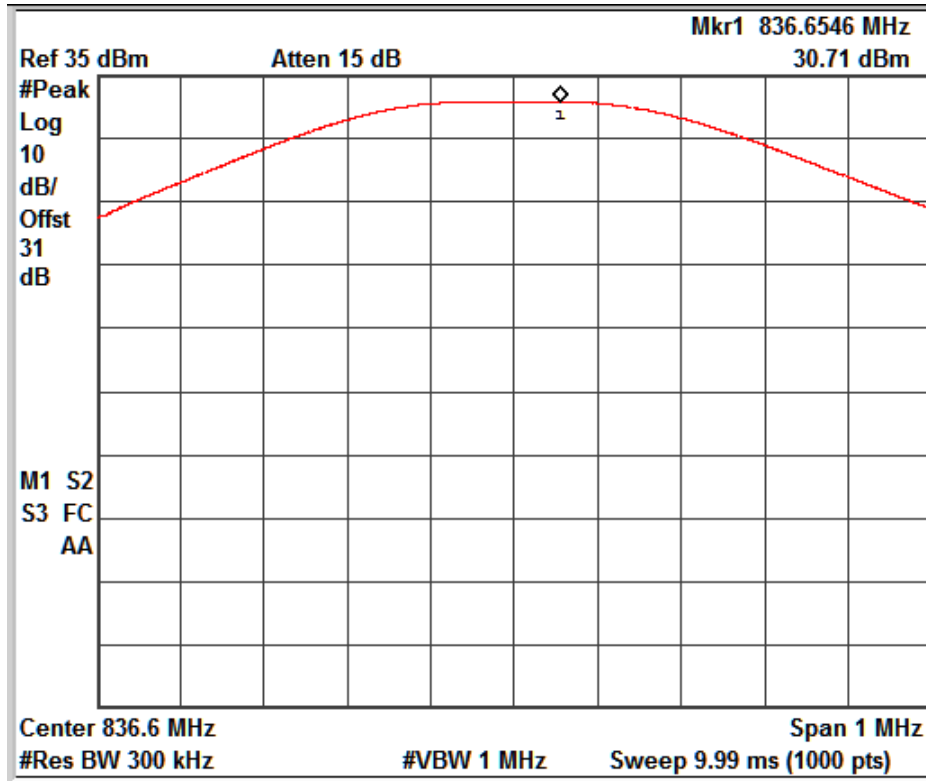

GSM_GPRS_Channel No. 190

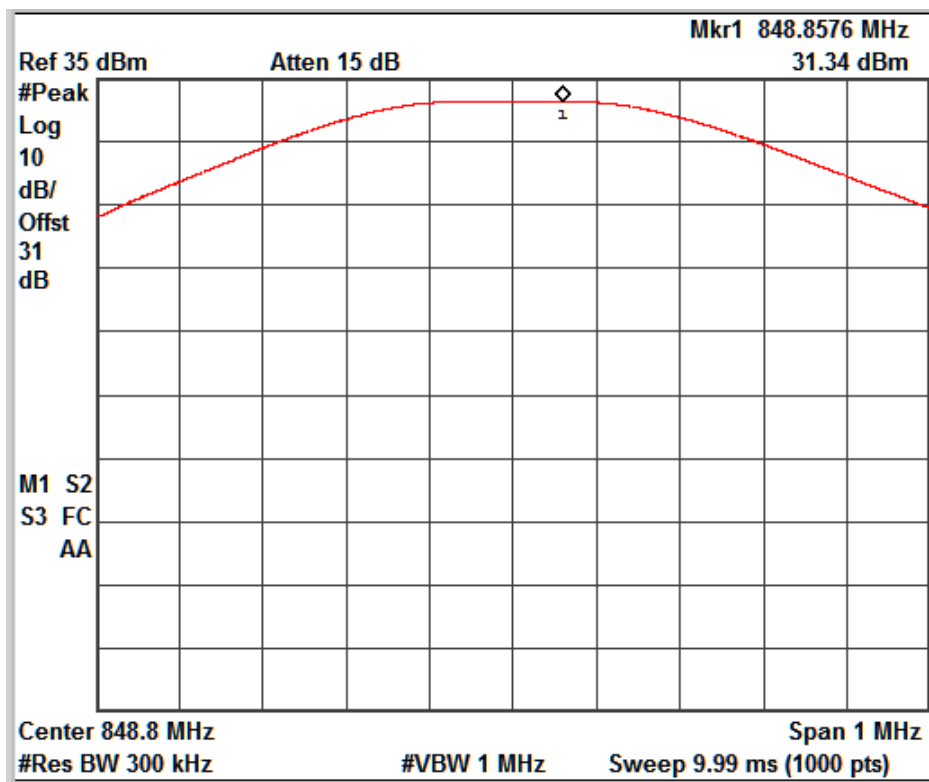

GSM_GPRS_Channel No. 251

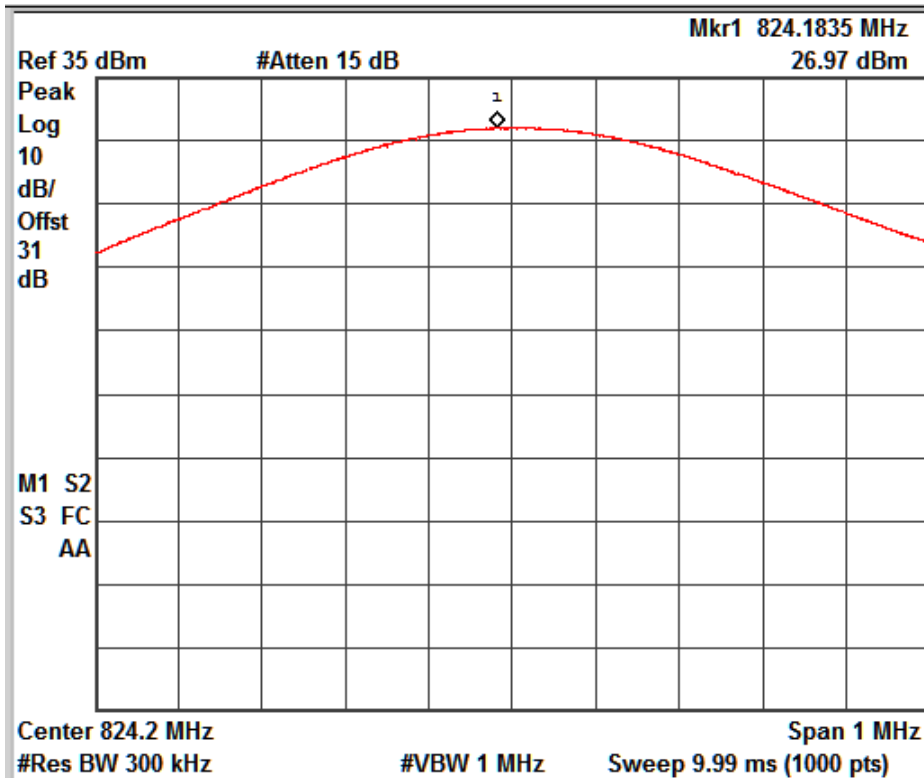

GSM_E-GPRS _ Channel No. 128

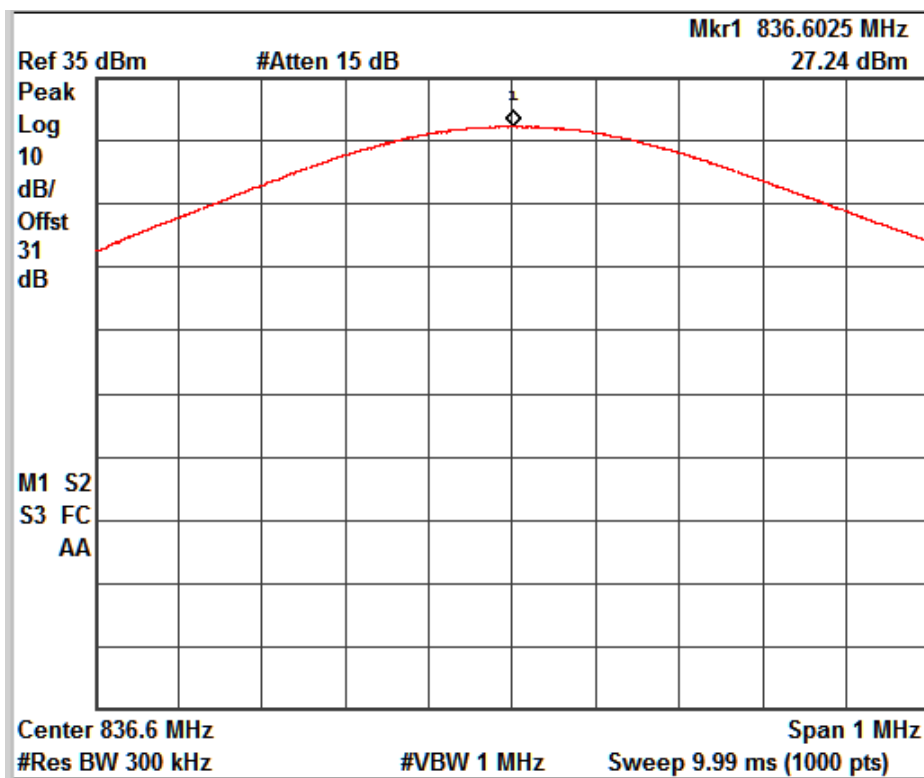

GSM_E-GPRS _ Channel No. 190

www.tuv.com

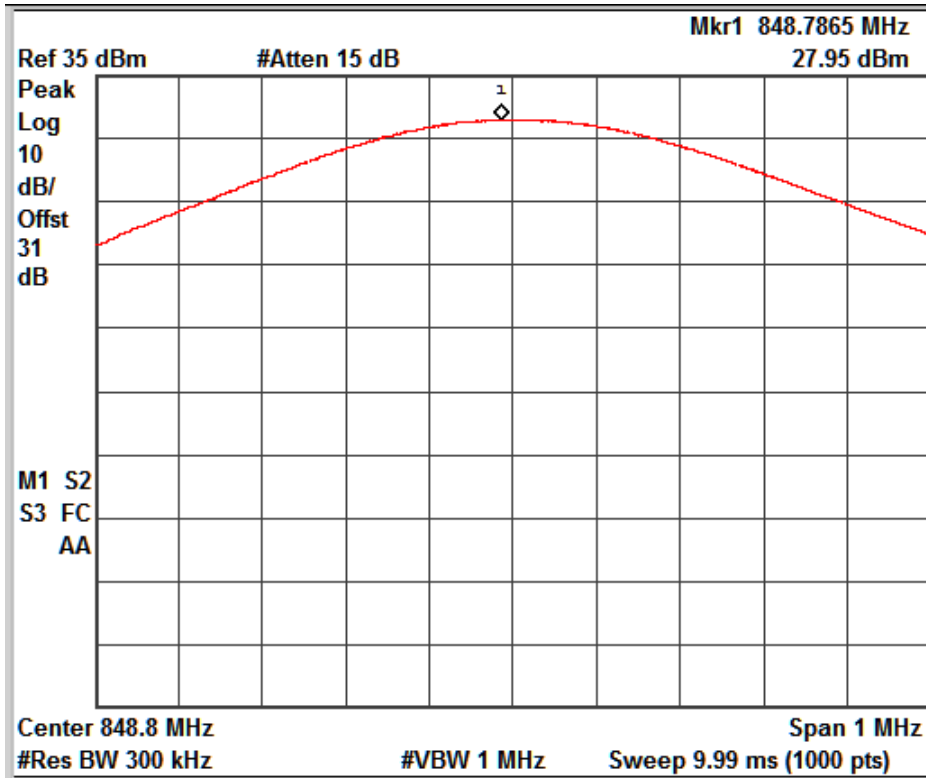

GSM_E-GPRS _ Channel No. 251

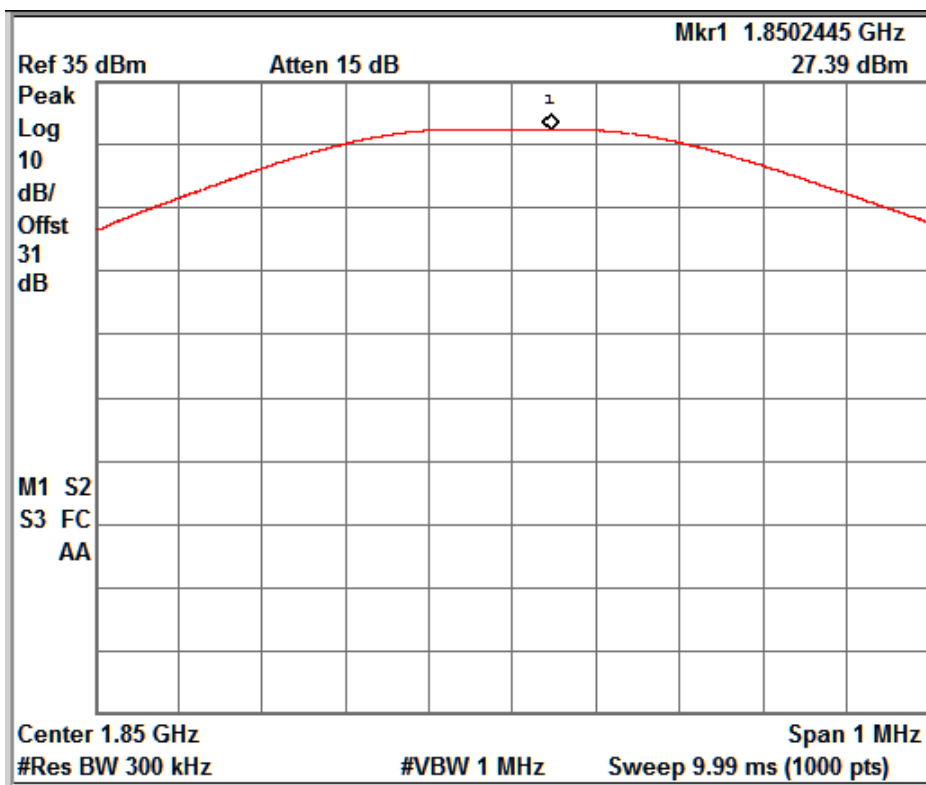

GSM_Voice _ Channel No. 512

www.tuv.com

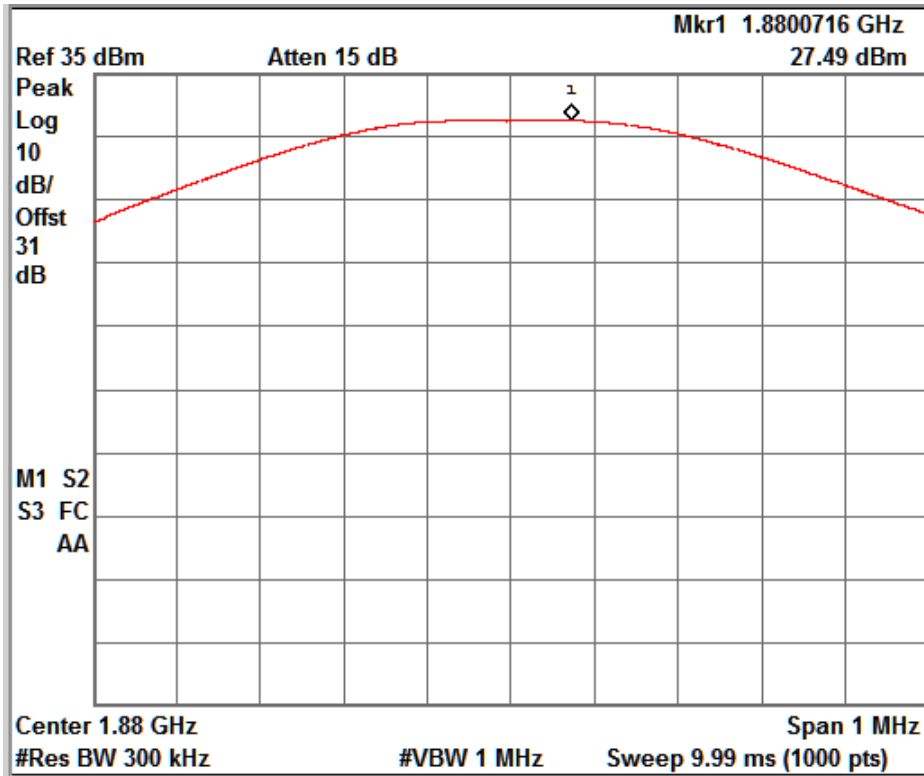

GSM_Voice_Channel No. 661

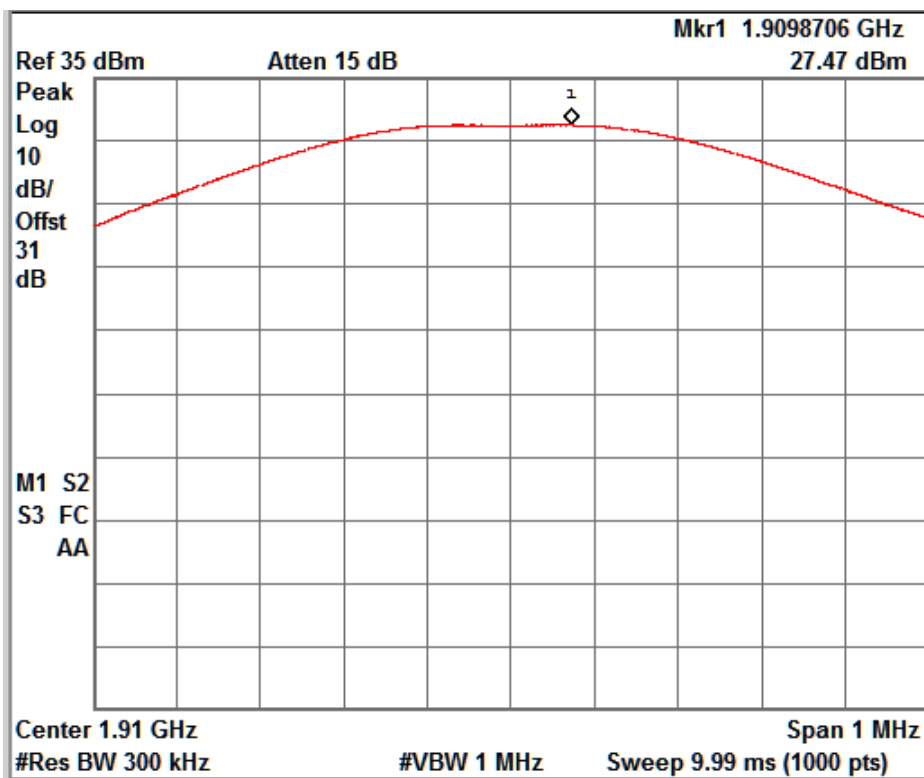

GSM_Voice_Channel No. 810

www.tuv.com

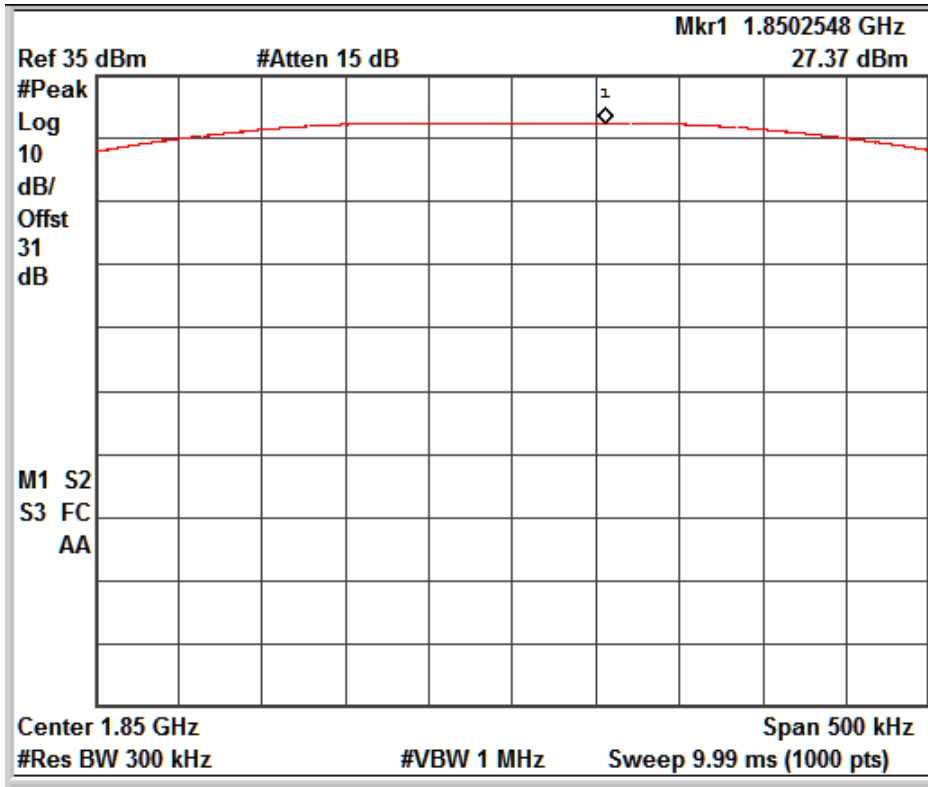

GSM_GPRS_Channel No. 512

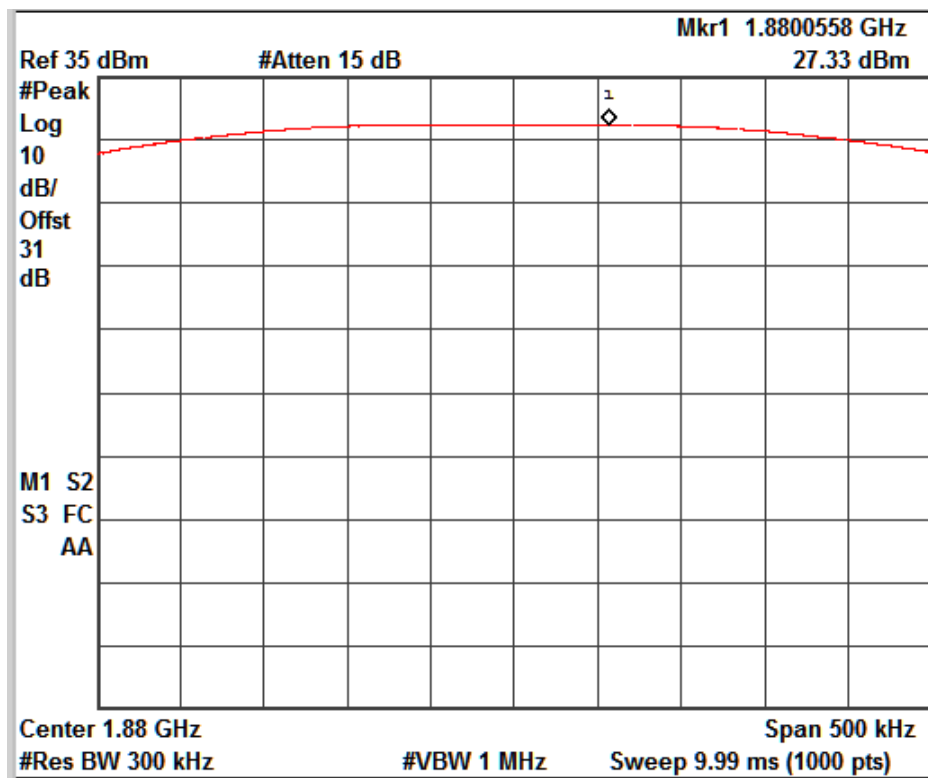

GSM_GPRS_Channel No. 661

www.tuv.com

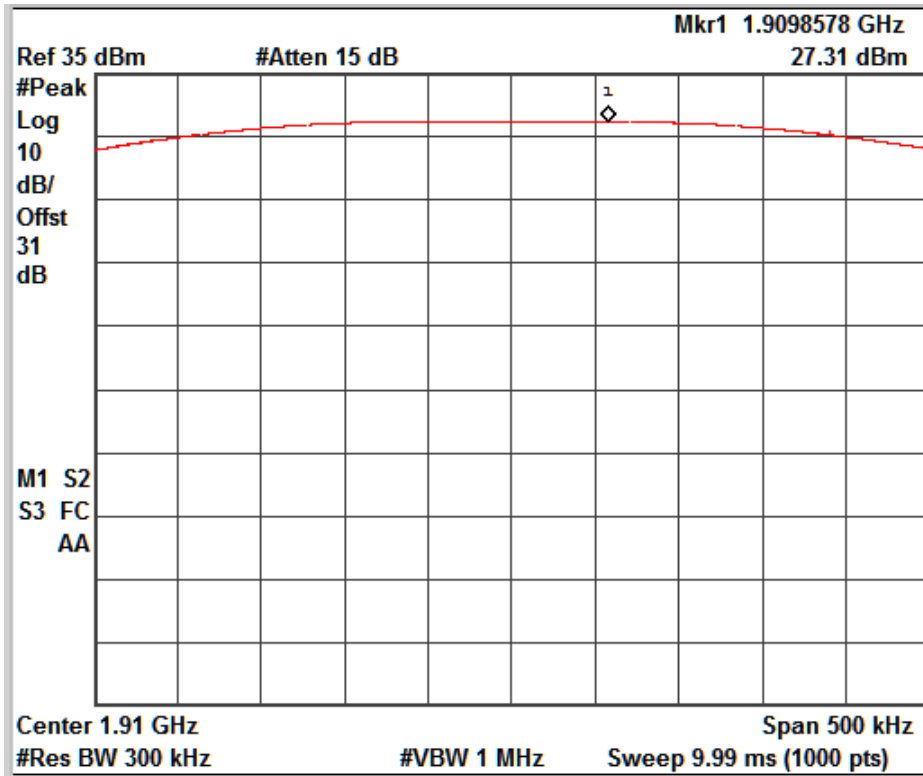

GSM_GPRS_Channel No. 810

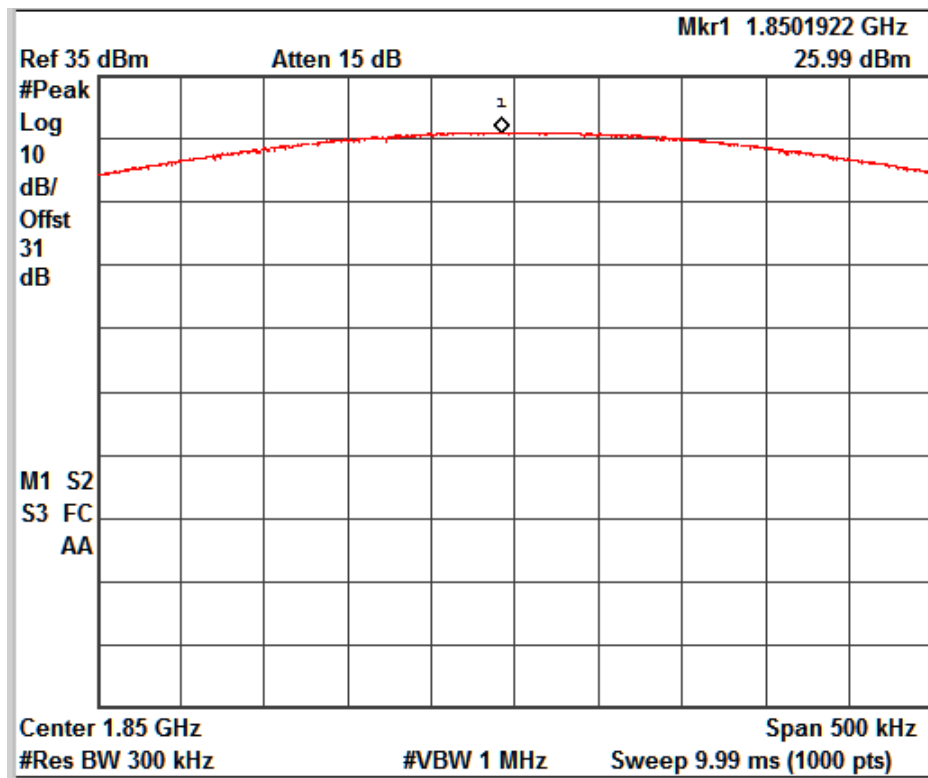

GSM_E-GPRS_Channel No. 512

www.tuv.com

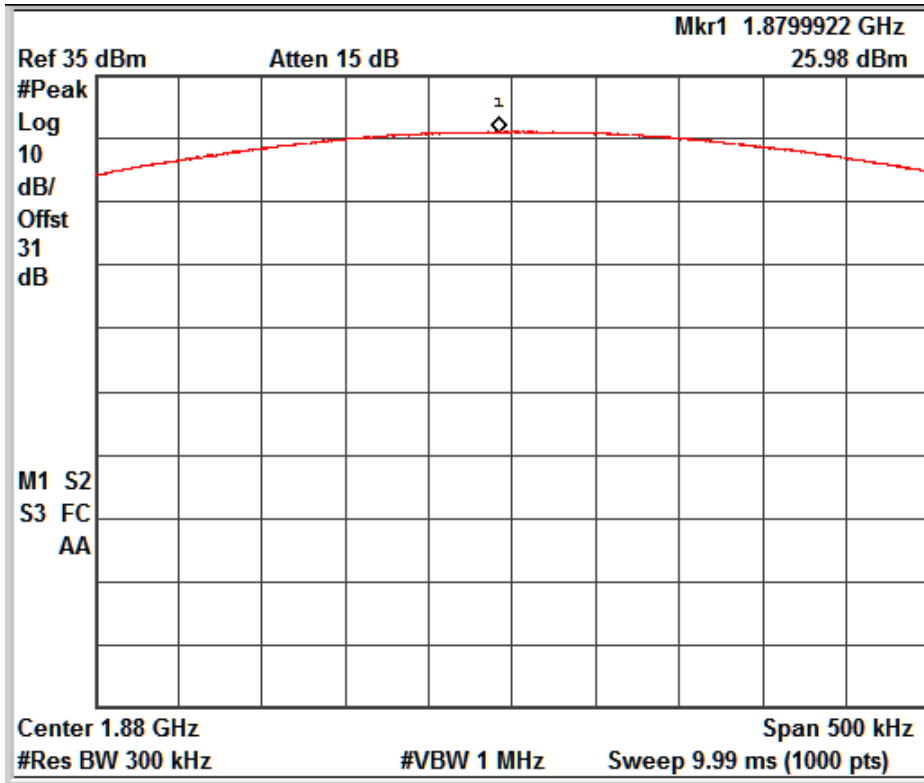

GSM_E-GPRS _ Channel No. 661

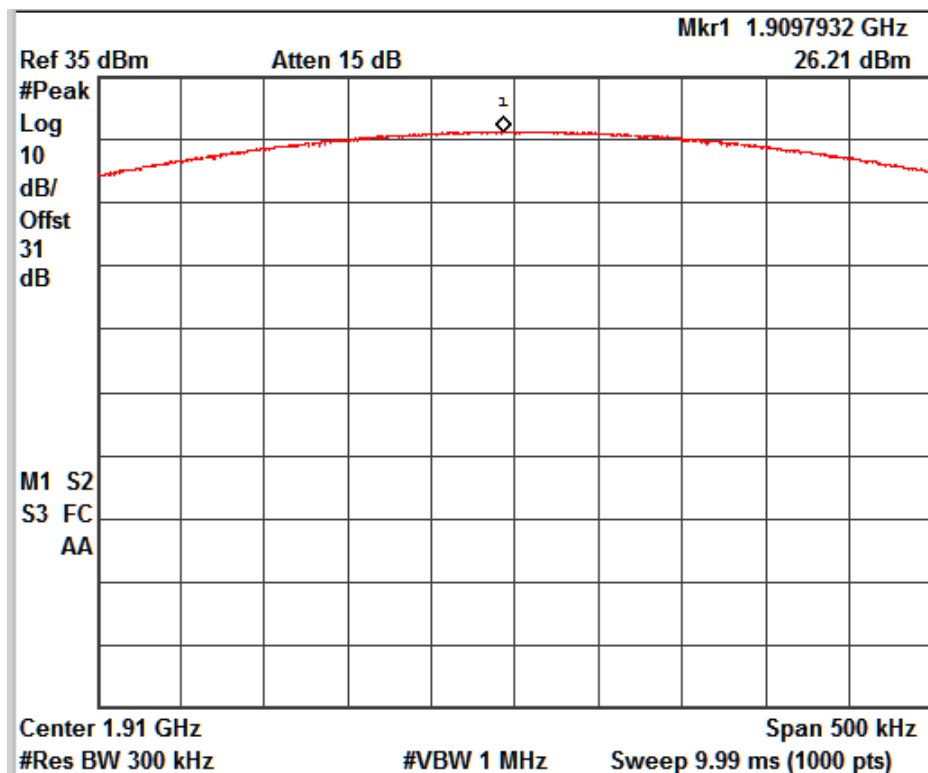

GSM_E-GPRS _ Channel No. 810

www.tuv.com

Average Output Power Test Results

Band	Channel Number	Channel Frequency (MHz)	Measured Power - Voice (dBm)	Measured Power - GPRS Data (dBm)	Measured Power - E-GPRS data (dBm)
GSM850	128	824.2	29.99	27.98	23.20
	190	836.6	30.06	27.93	23.34
	251	848.8	30.59	28.49	24.00
PCS1900	512	1850.2	26.60	24.33	22.12
	661	1880.0	26.63	24.75	22.39
	810	1909.8	26.52	24.86	22.24

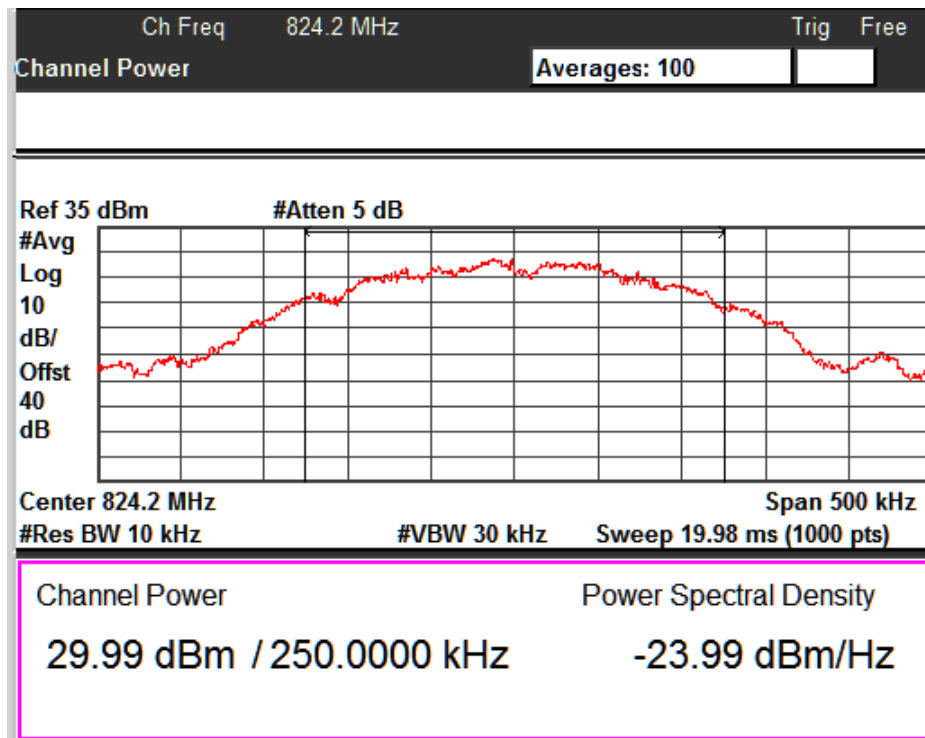

GSM_Voice _ Channel No. 128

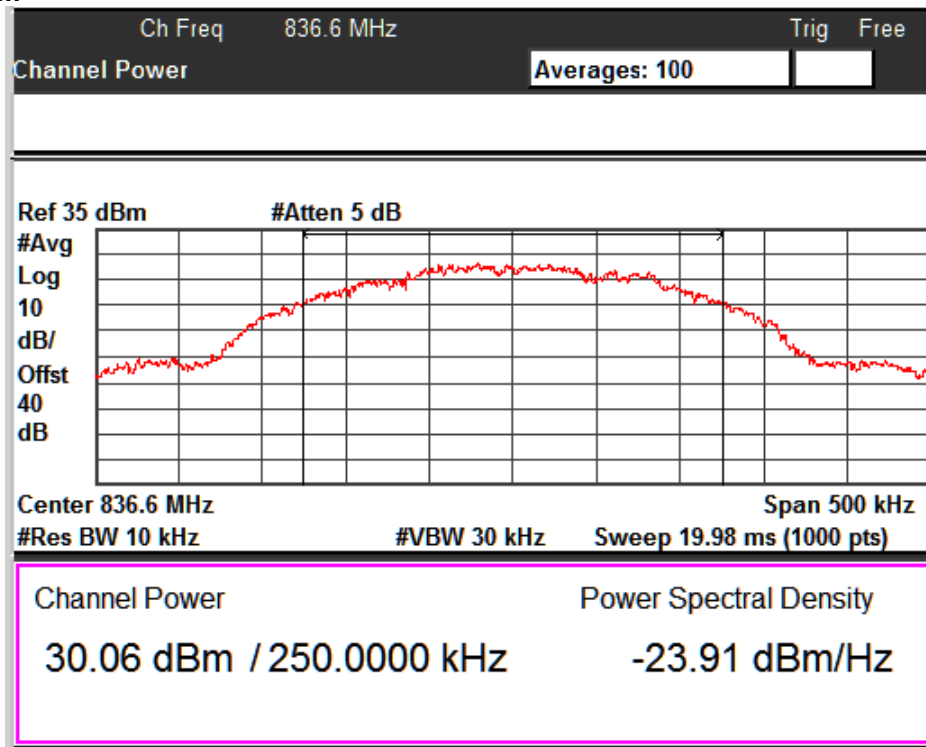

GSM_Voice _ Channel No. 190

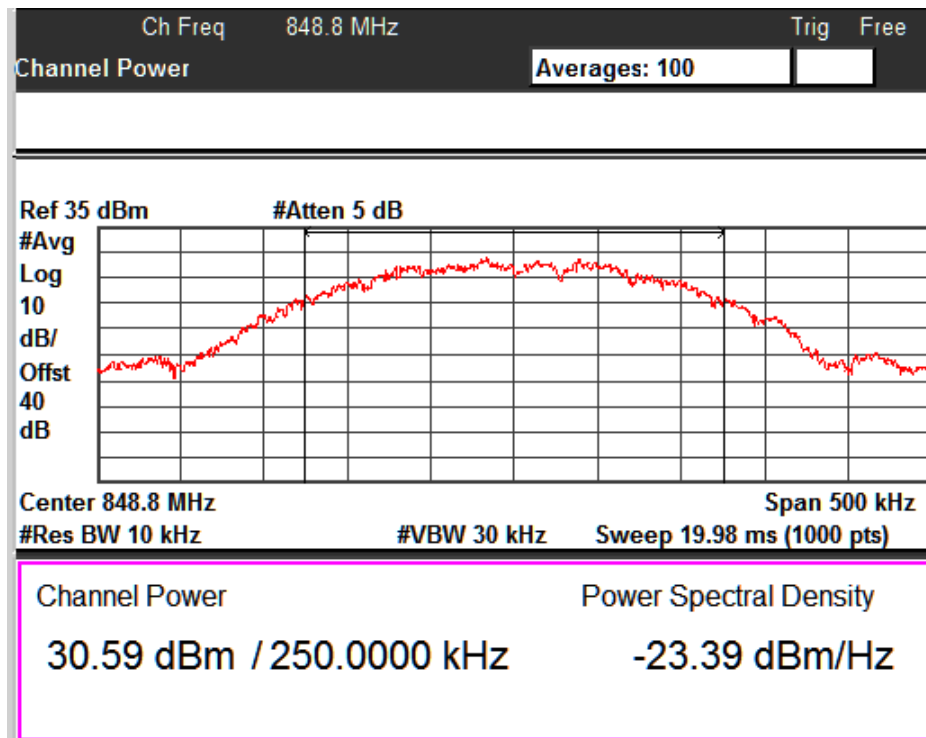

GSM_Voice _ Channel No. 251

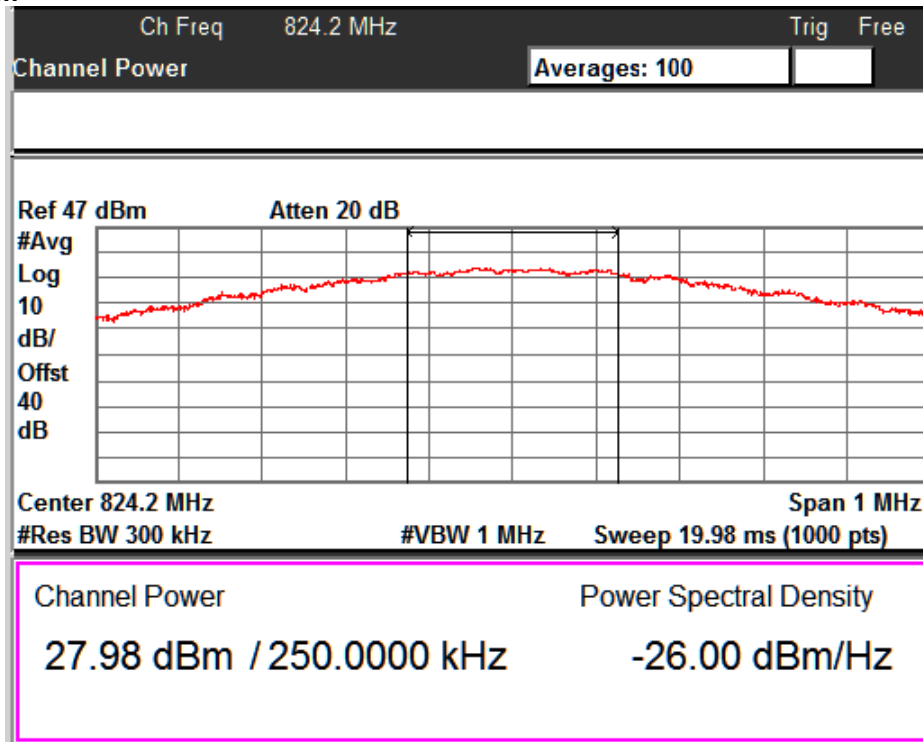

GSM_ GPRS _ Channel No. 128

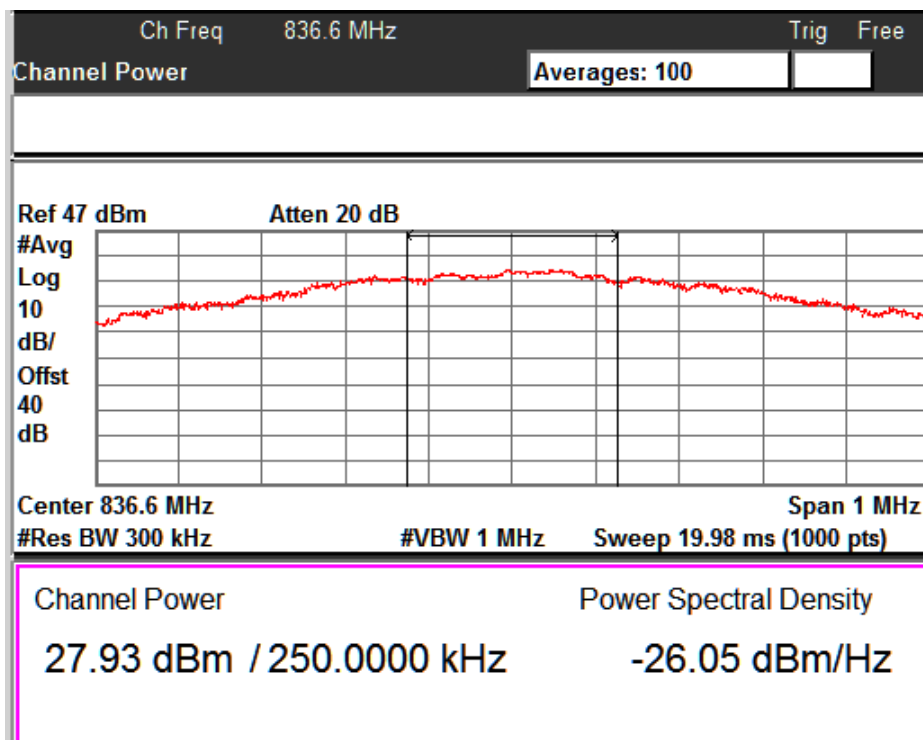

GSM_ GPRS _ Channel No. 190

www.tuv.com

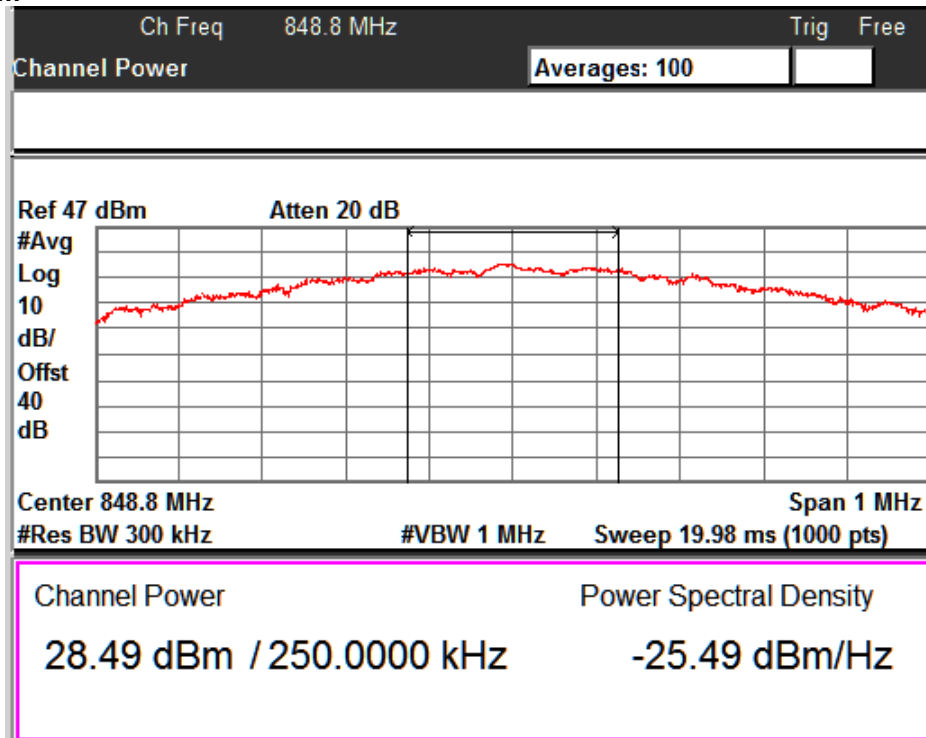

GSM_GPRS_Channel No. 251

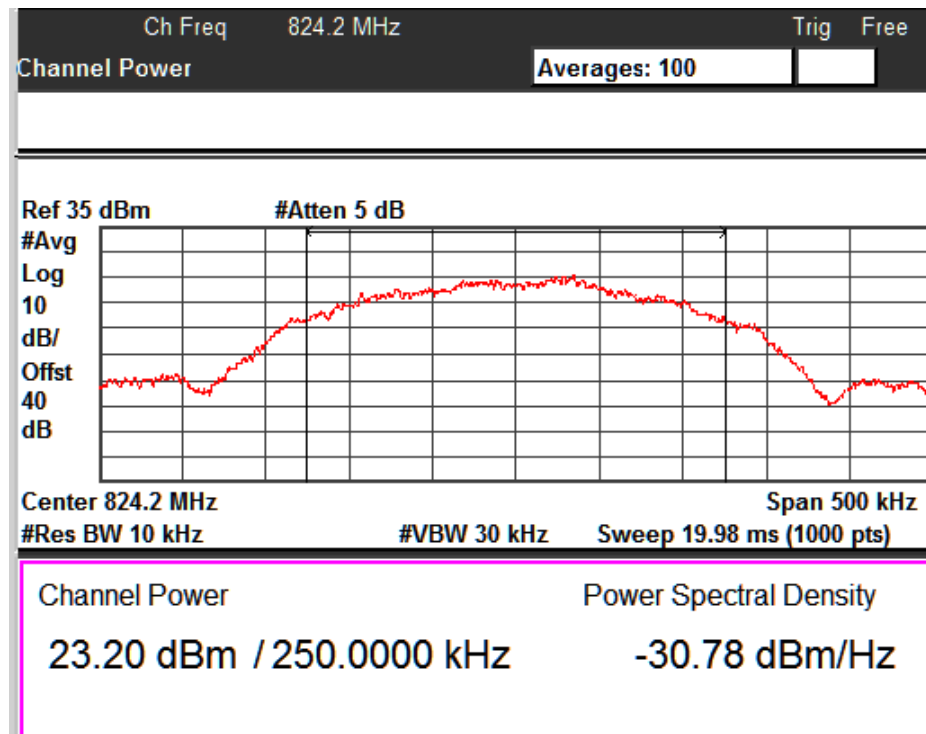

GSM_E-GPRS_Channel No. 128

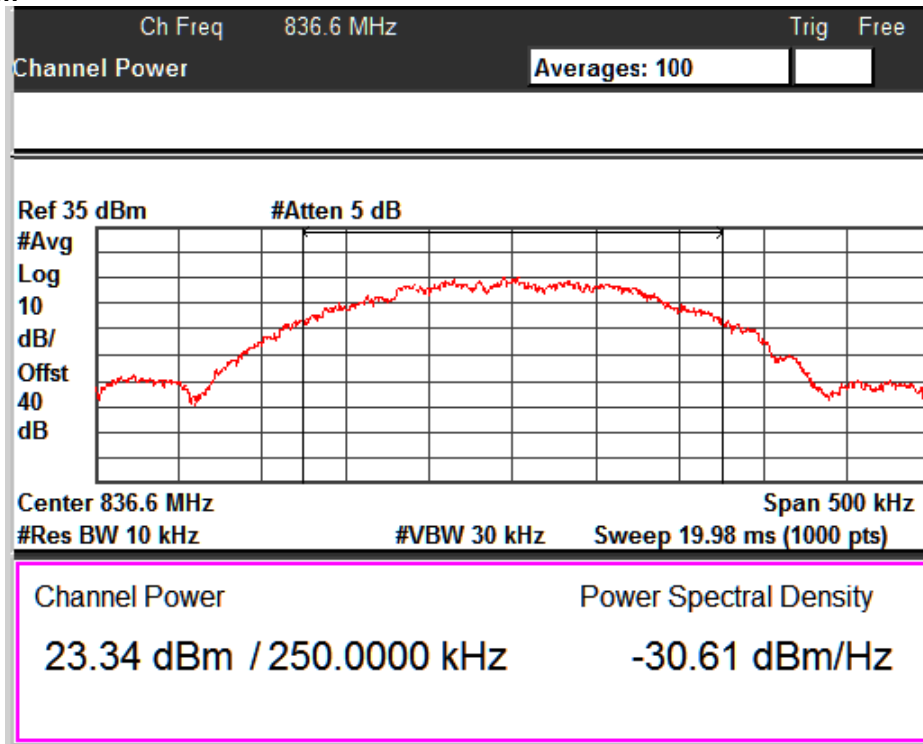
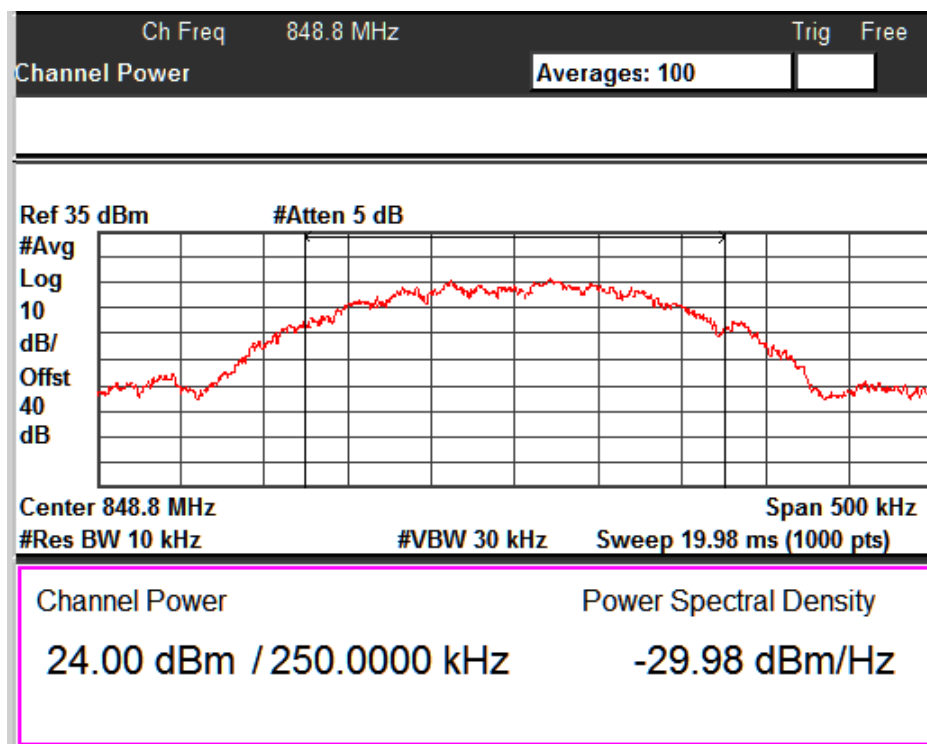
GSM_E-GPRS_ Channel No. 190

GSM_E-GPRS_ Channel No. 251

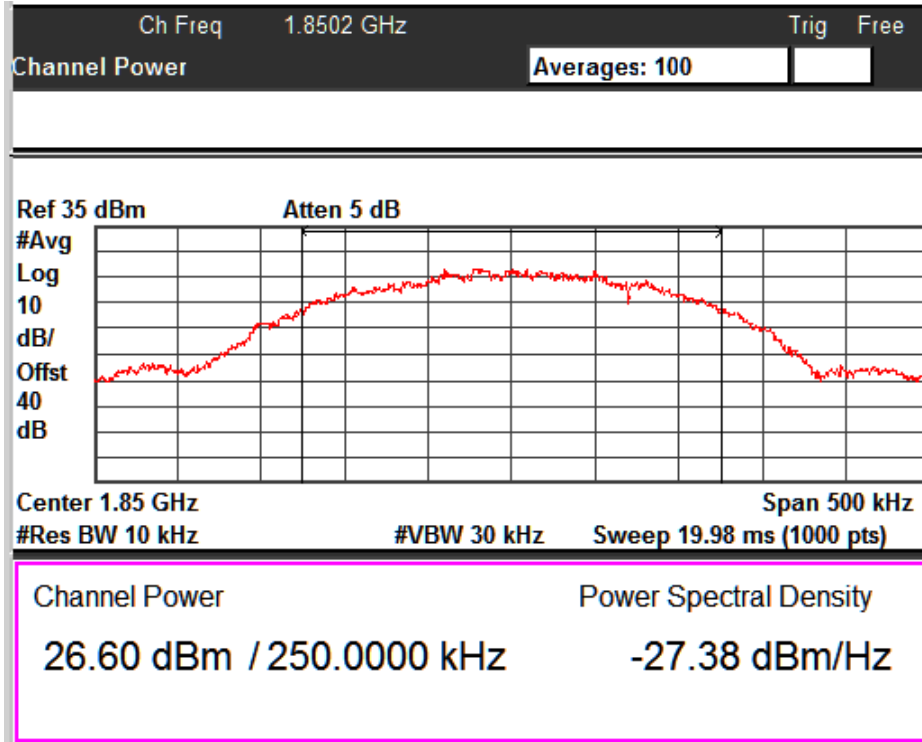
www.tuv.com

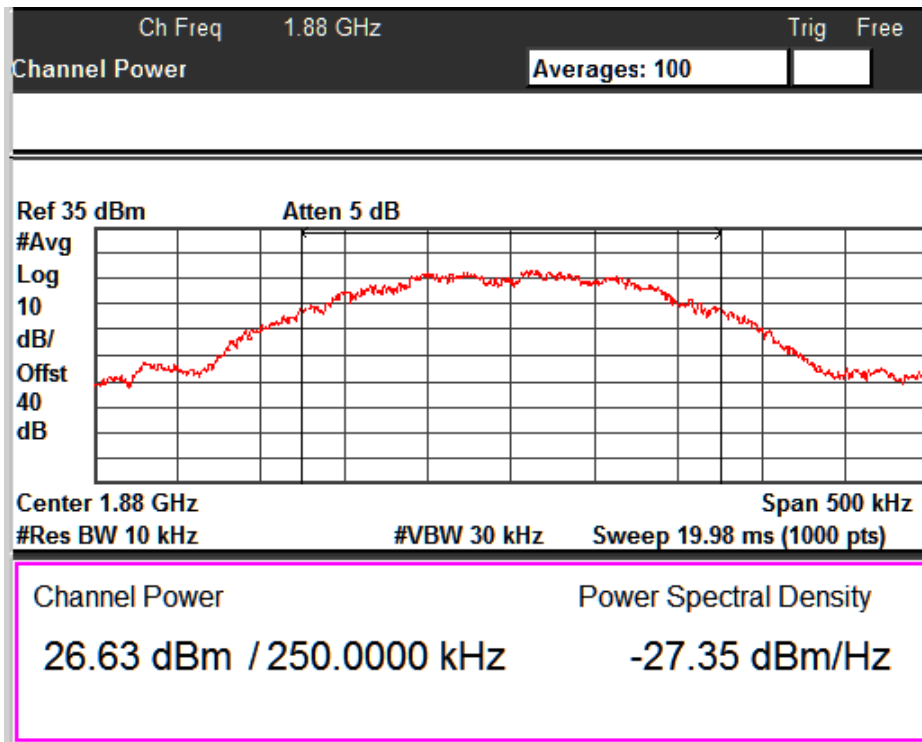

GSM_Voice _ Channel No. 512



GSM_Voice _ Channel No. 661

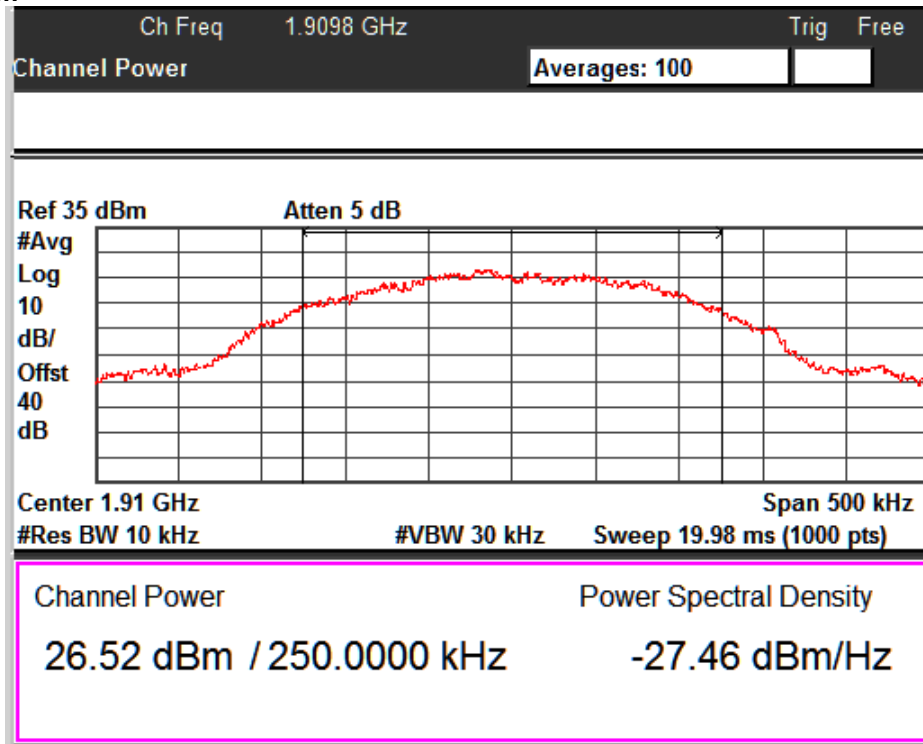

GSM_Voice_Channel No. 810

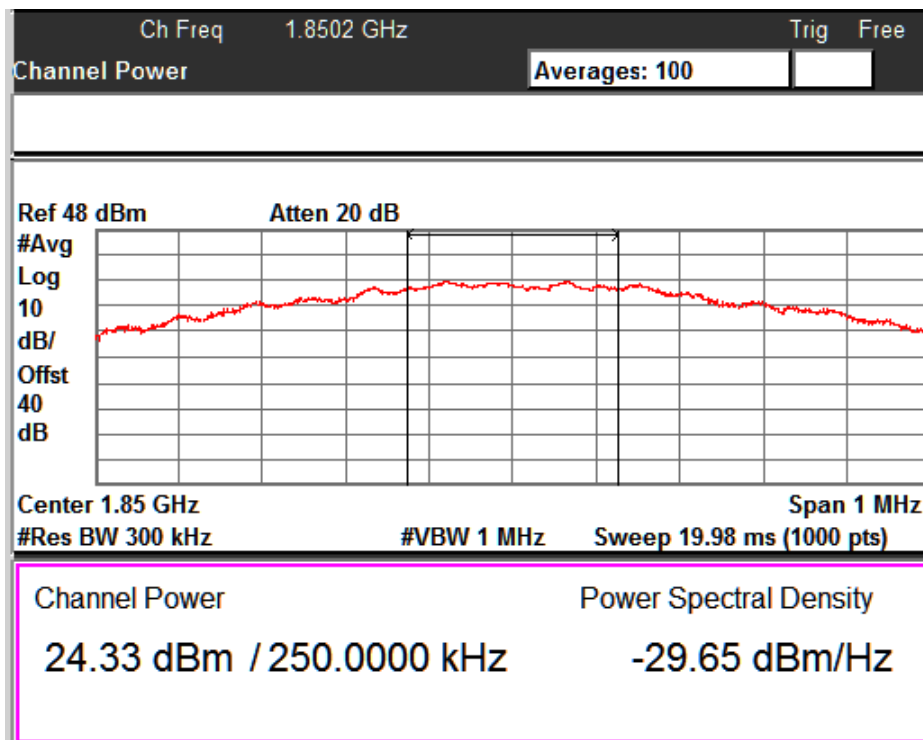

GSM_GPRS_Channel No. 512

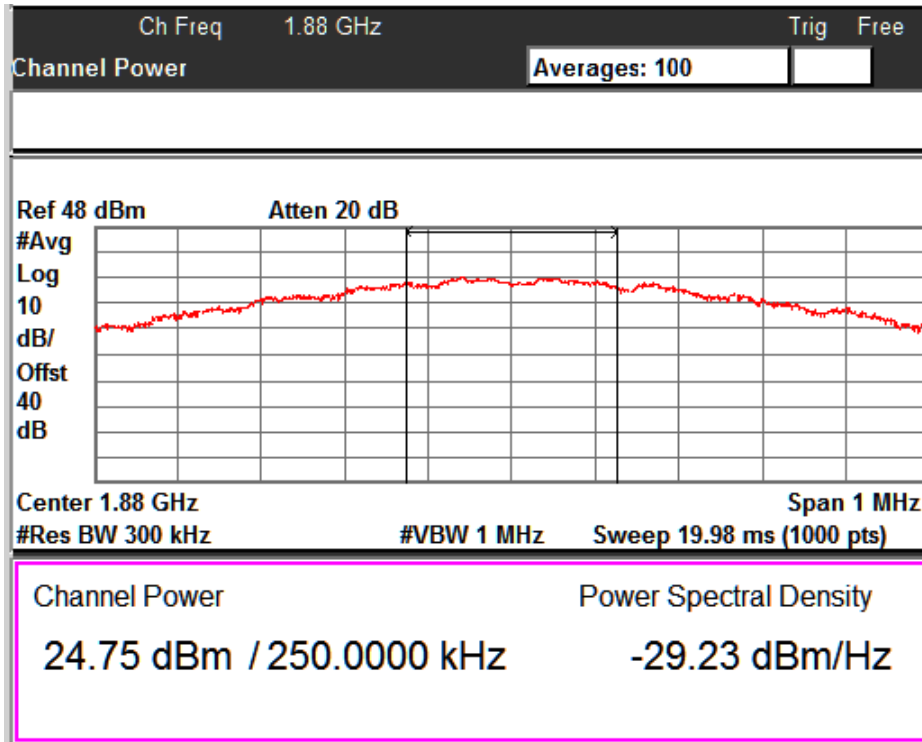

GSM_ GPRS _ Channel No. 661

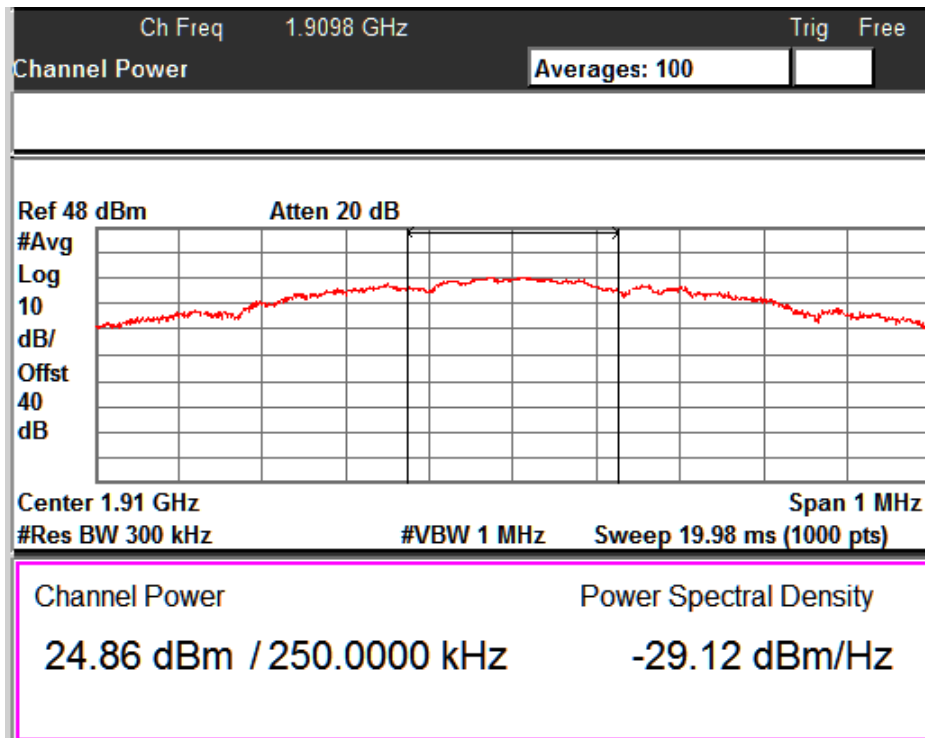

GSM_ GPRS _ Channel No. 810

www.tuv.com

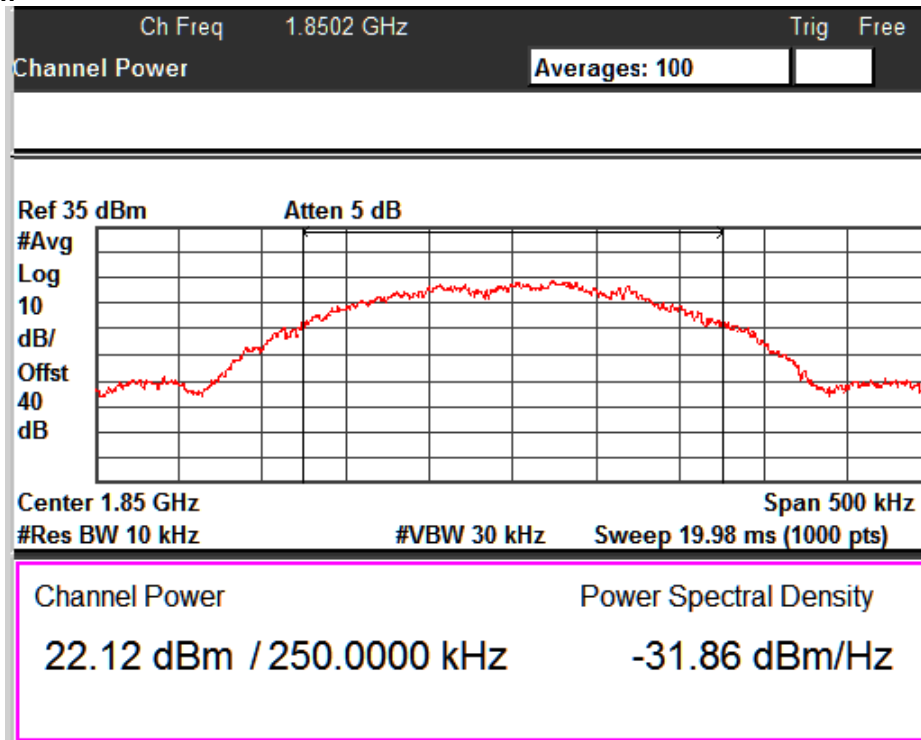

GSM_E-GPRS _ Channel No. 512

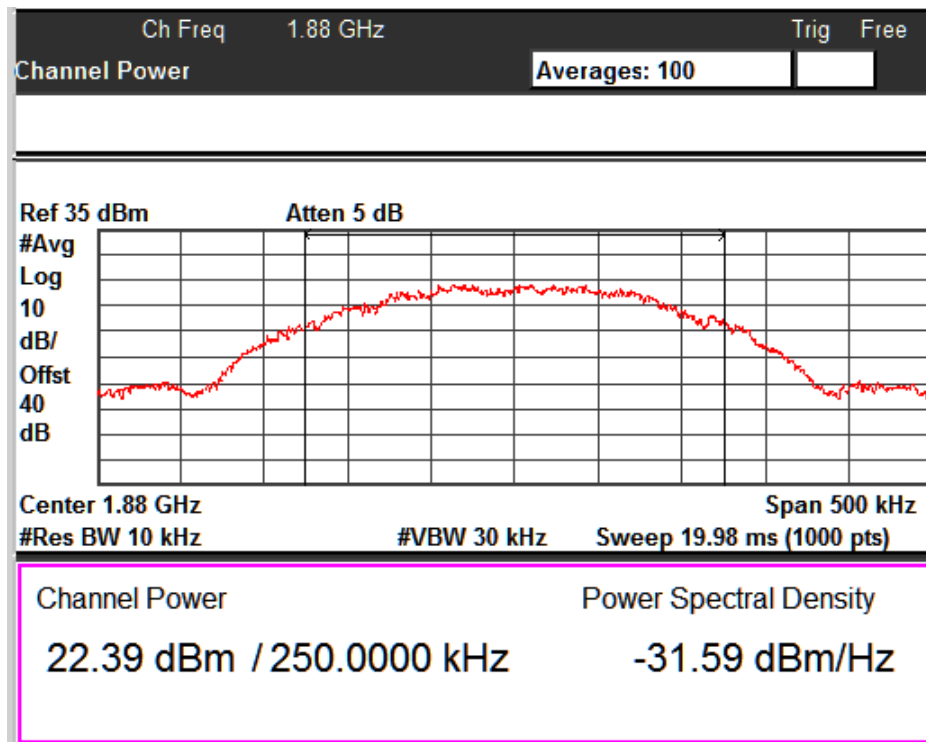

GSM_E-GPRS _ Channel No. 661

www.tuv.com

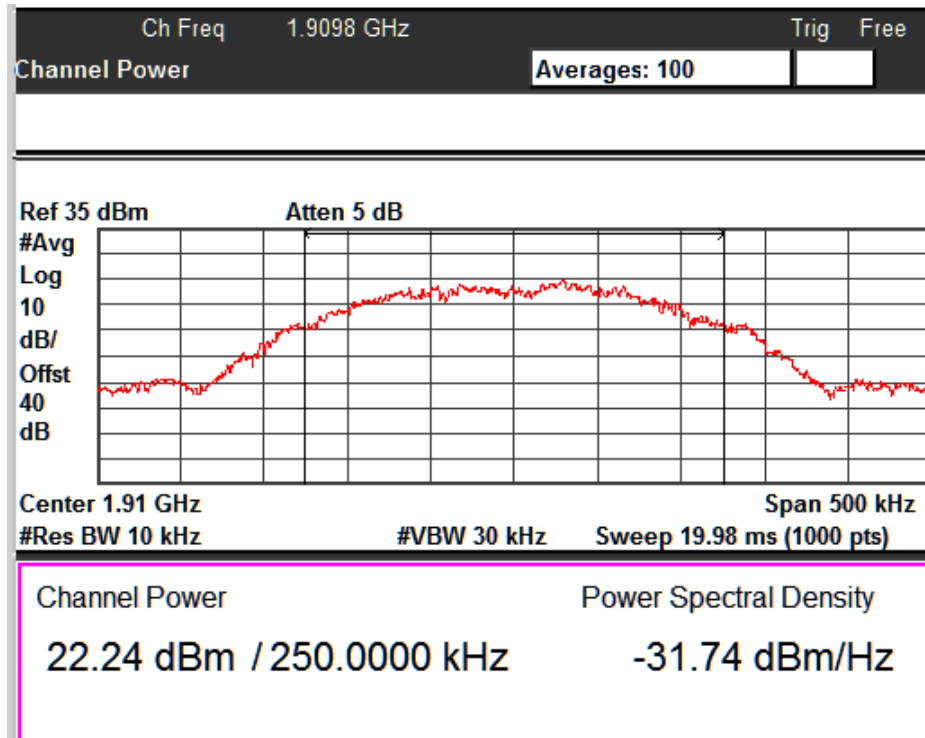

GSM_E-GPRS _ Channel No. 810

Peak -to- Average Ratio (PAPR) Test Results

Mode	Channel Number	Channel Frequency (MHz)	Peak Output Power (dBm)	Average Output Power (dBm)	PAPR (dB)	PAPR Limit (dB)
GSM 850	128	824.2	30.62	27.98	2.64	≤ 13
	190	836.6	30.74	27.93	2.81	≤ 13
	251	848.8	31.42	28.49	2.93	≤ 13
GPRS 850	128	824.2	30.62	29.99	0.63	≤ 13
	190	836.6	30.71	30.06	0.65	≤ 13
	251	848.8	31.34	30.59	0.75	≤ 13
E-GPRS 850	128	824.2	26.97	23.20	3.77	≤ 13
	190	836.6	27.24	23.34	3.90	≤ 13
	251	848.8	27.95	24.00	3.95	≤ 13
PCS 1900	512	1850.2	27.39	24.33	3.06	≤ 13
	661	1880.0	27.49	24.75	2.74	≤ 13
	810	1909.8	27.47	24.86	2.61	≤ 13
GPRS 1900	512	1850.2	27.37	26.60	0.77	≤ 13
	661	1880.0	27.33	26.63	0.70	≤ 13
	810	1909.8	27.31	26.52	0.79	≤ 13
E-GPRS 1900	512	1850.2	25.99	22.12	3.87	≤ 13
	661	1880.0	25.98	22.39	3.59	≤ 13
	810	1909.8	26.21	22.24	3.97	≤ 13

* PAPR – Peak to Average Power Ratio.

www.tuv.com

99% Occupied Bandwidth & 26dB Emission Bandwidth Result

Pass

Specification	FCC Part 2.1049 & RSS-Gen Issue 4 section 6.6
Measurement Bandwidth (RBW)	≥ OBW
Detector Function	Peak
Requirement	Reporting Only.

Test Setup:

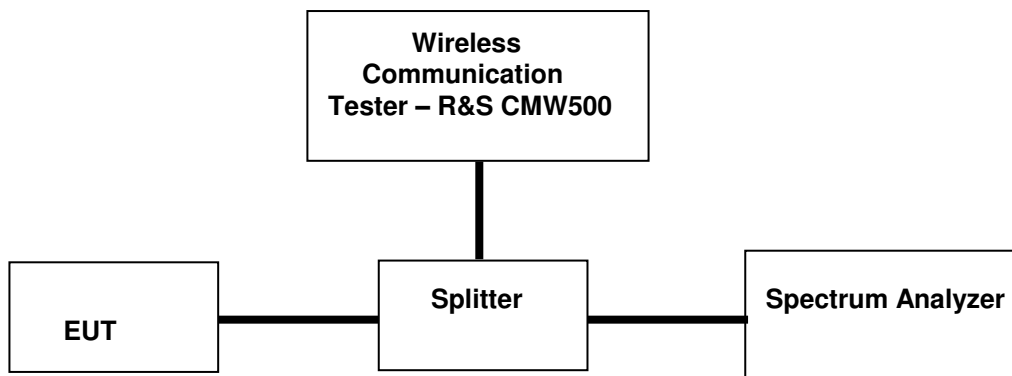

Note: For measurement of occupied bandwidth, section 4.2 in “971168 D01 Power Meas License Digital Systems v02r02” was used.

Test Results

Mode	Channel Number	Channel Frequency (MHz)	99% Occupied Bandwidth (kHz)	26dB Emission Bandwidth (kHz)
GSM 850	128	824.2	244.51	315.18
	190	836.6	245.15	319.53
	251	848.8	242.21	318.42
GPRS 850	128	824.2	249.01	317.19
	190	836.6	246.55	308.35
	251	848.8	246.54	320.32
E-GPRS 850	128	824.2	242.61	312.84
	190	836.6	244.73	310.52
	251	848.8	244.39	312.68
PCS 1900	512	1850.2	246.32	314.07
	661	1880.0	244.06	308.57
	810	1909.8	247.26	324.39
GPRS 1900	512	1850.2	245.80	315.58
	661	1880.0	245.91	312.44
	810	1909.8	247.96	311.71
E-GPRS 1900	512	1850.2	243.36	312.80
	661	1880.0	253.51	312.99
	810	1909.8	246.13	300.43

www.tuv.com

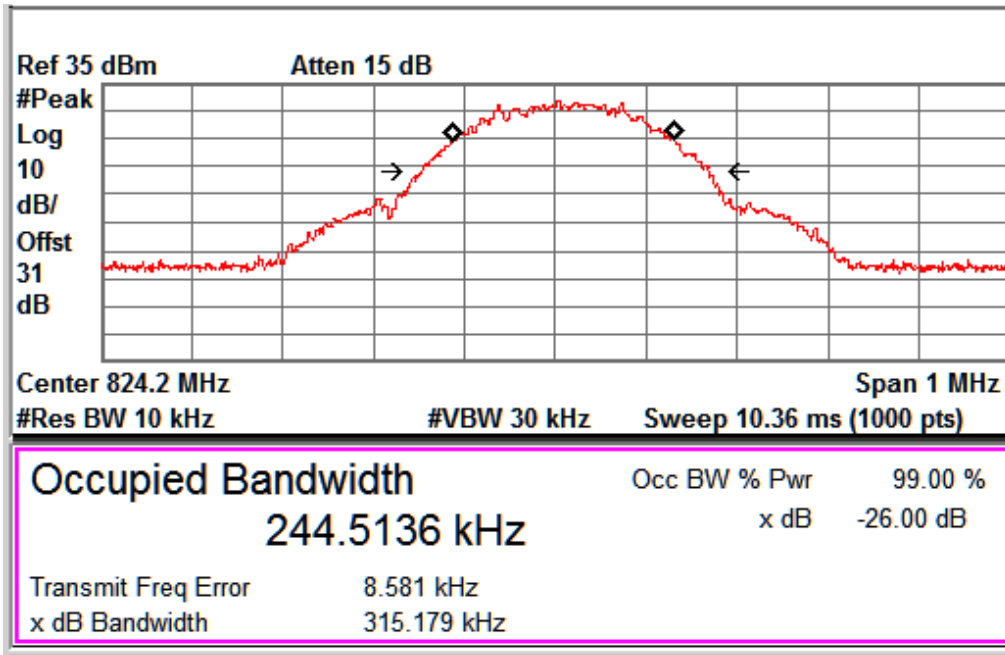

GSM_Voice_Channel No. 128

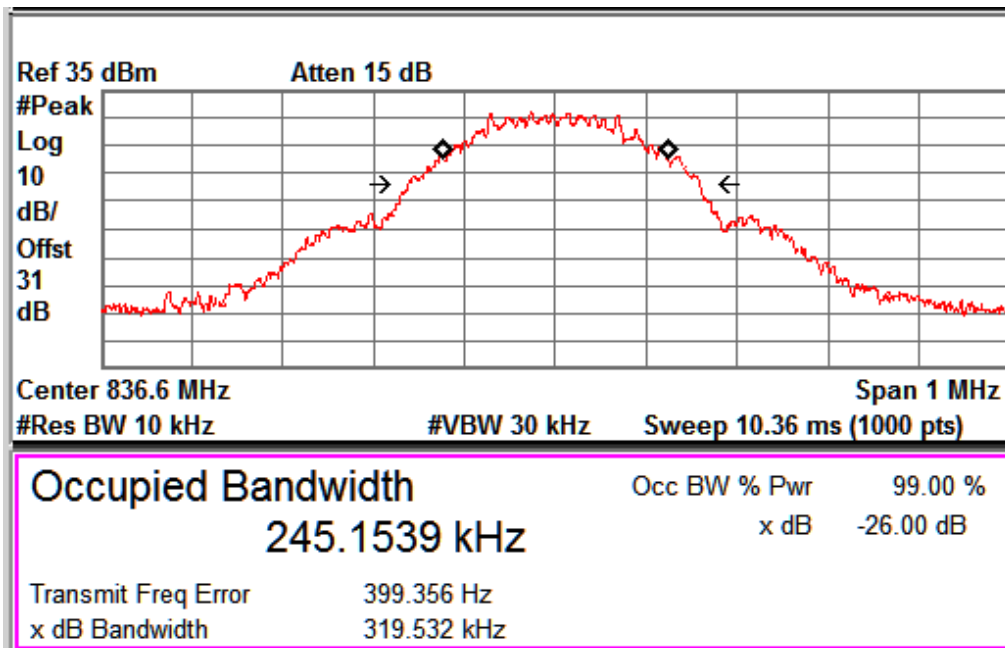

GSM_Voice_Channel No. 190

www.tuv.com

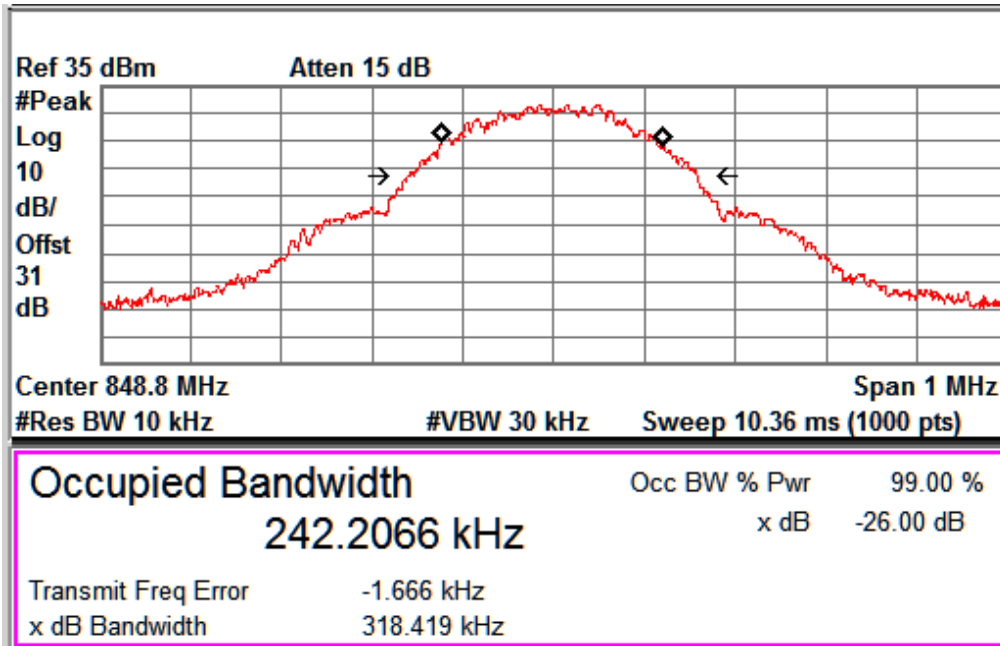

GSM_Voice_Channel No. 251

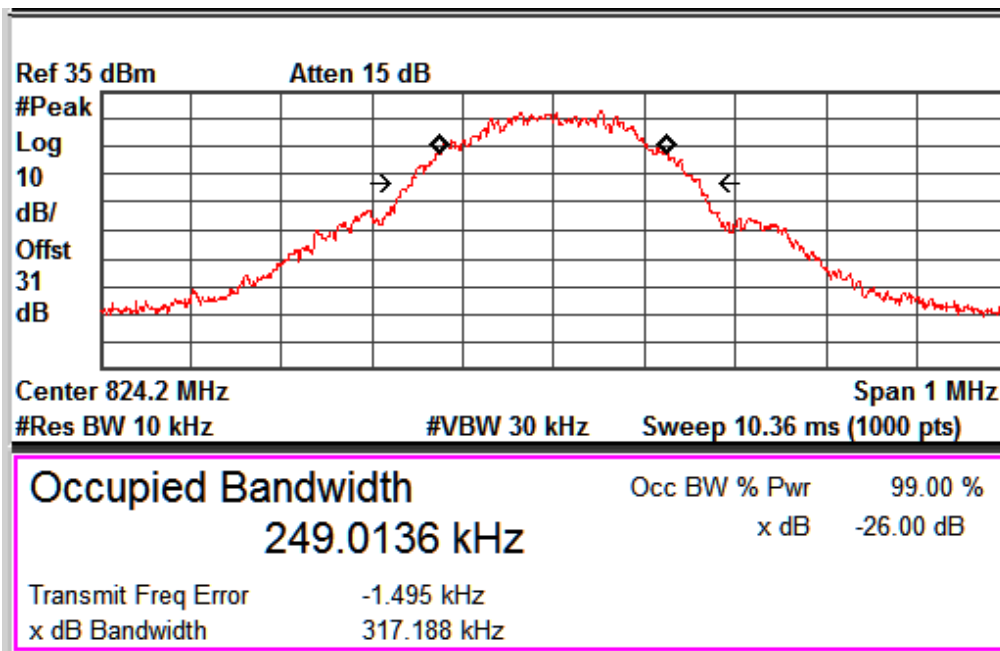

GSM_GPRS_Channel No. 128

www.tuv.com

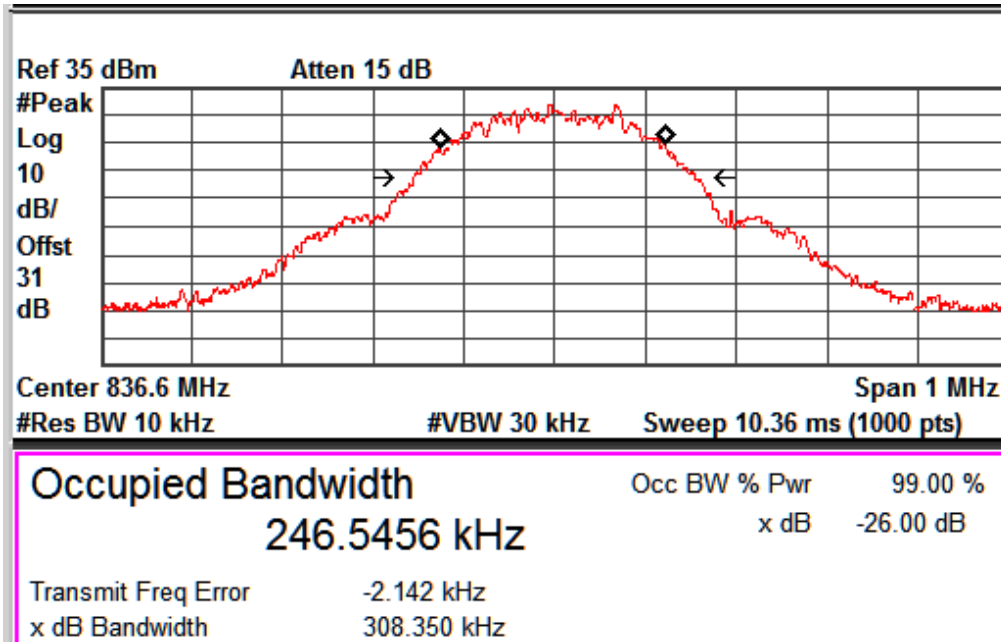

GSM_GPRS_Channel No. 190

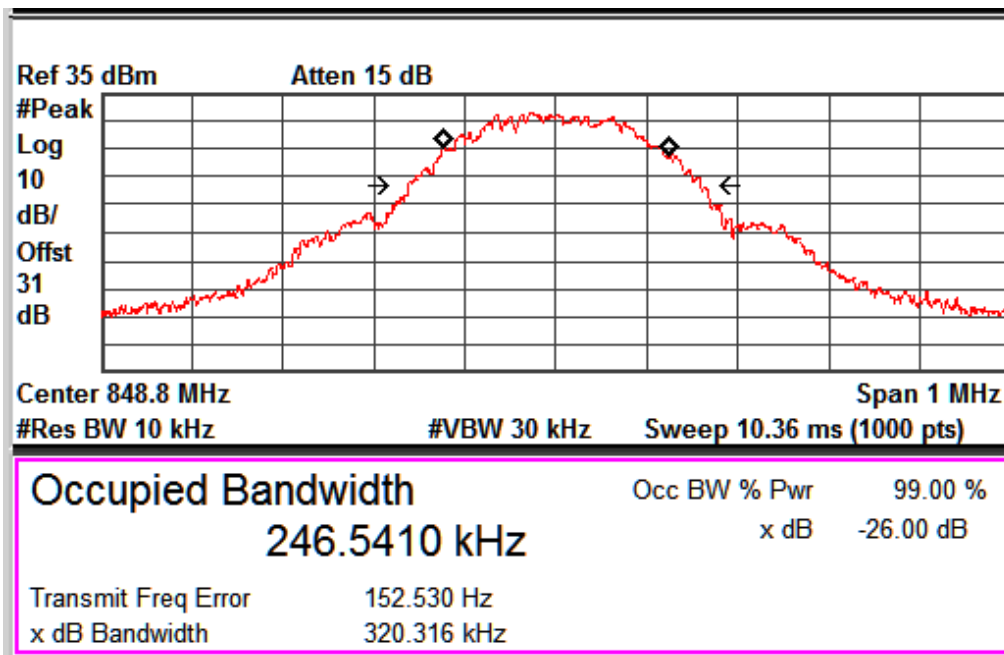

GSM_GPRS_Channel No. 251

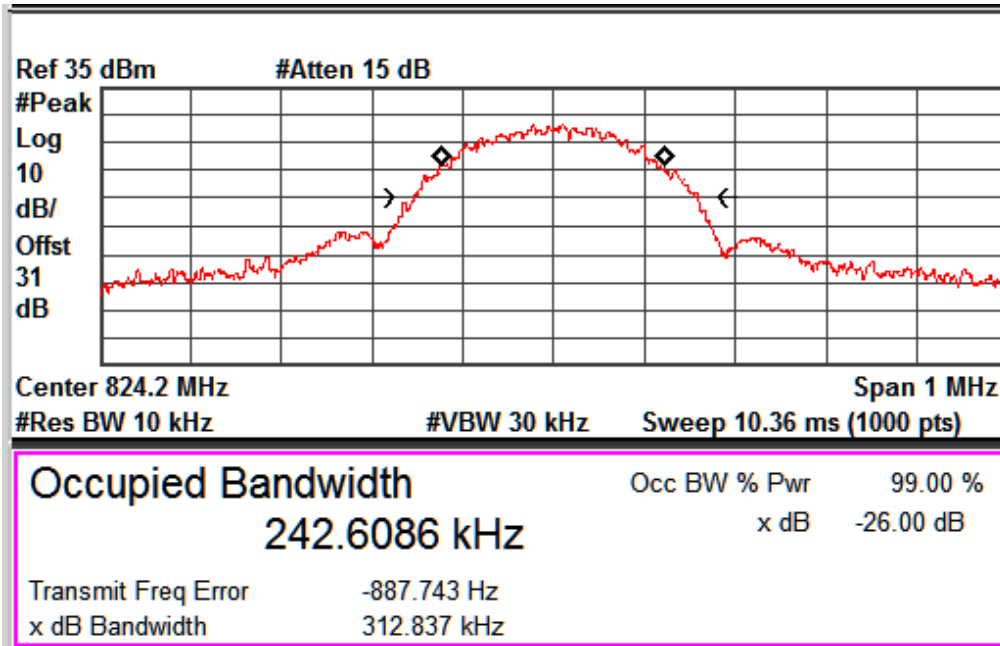

GSM_E-GPRS _ Channel No. 128

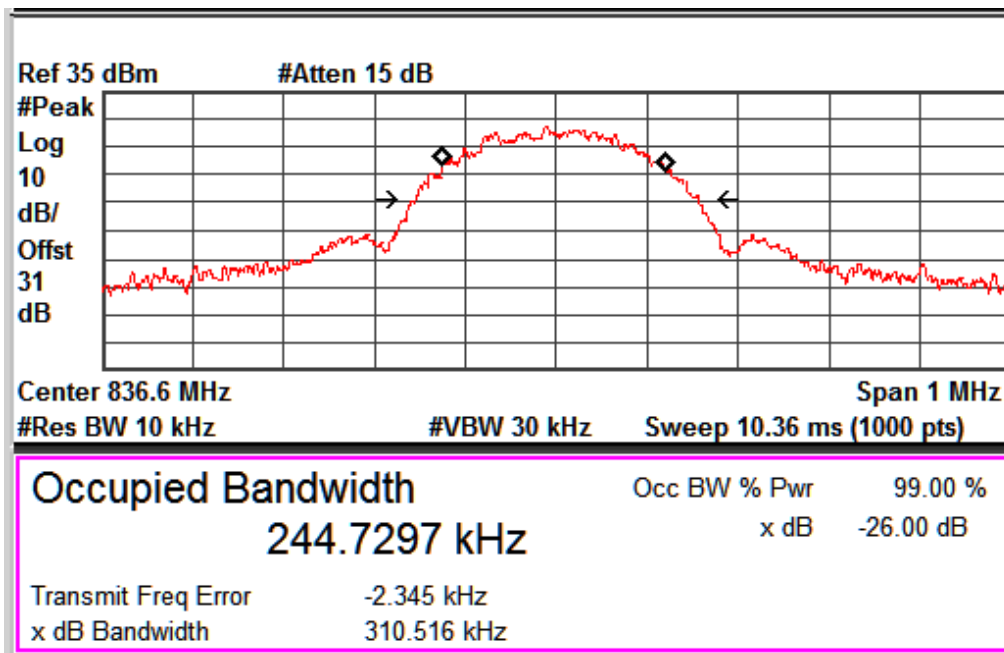

GSM_E-GPRS _ Channel No. 190

www.tuv.com

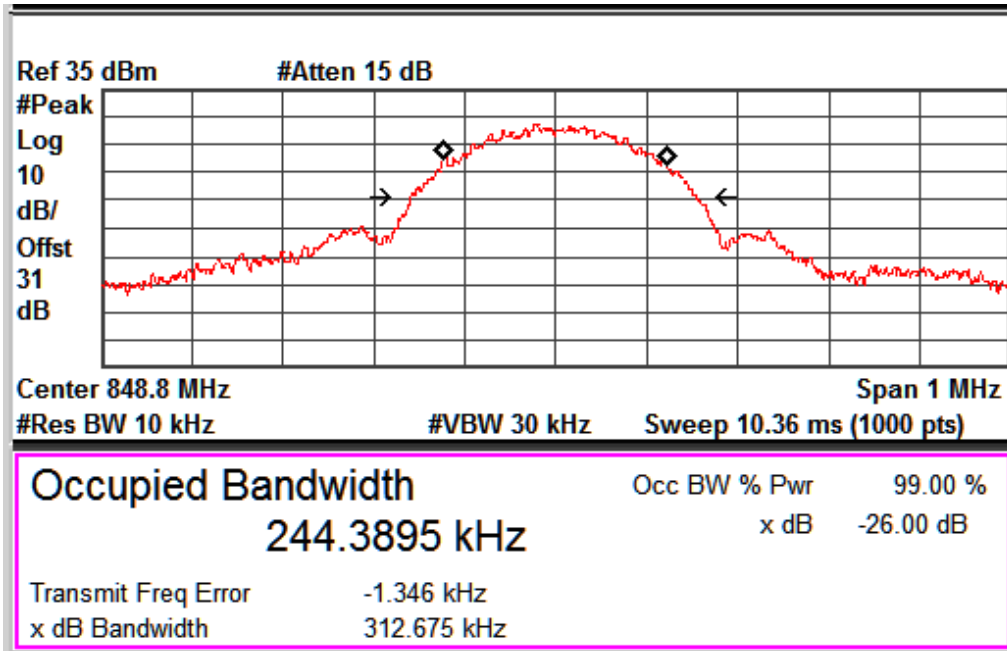

GSM_E-GPRS _ Channel No. 251

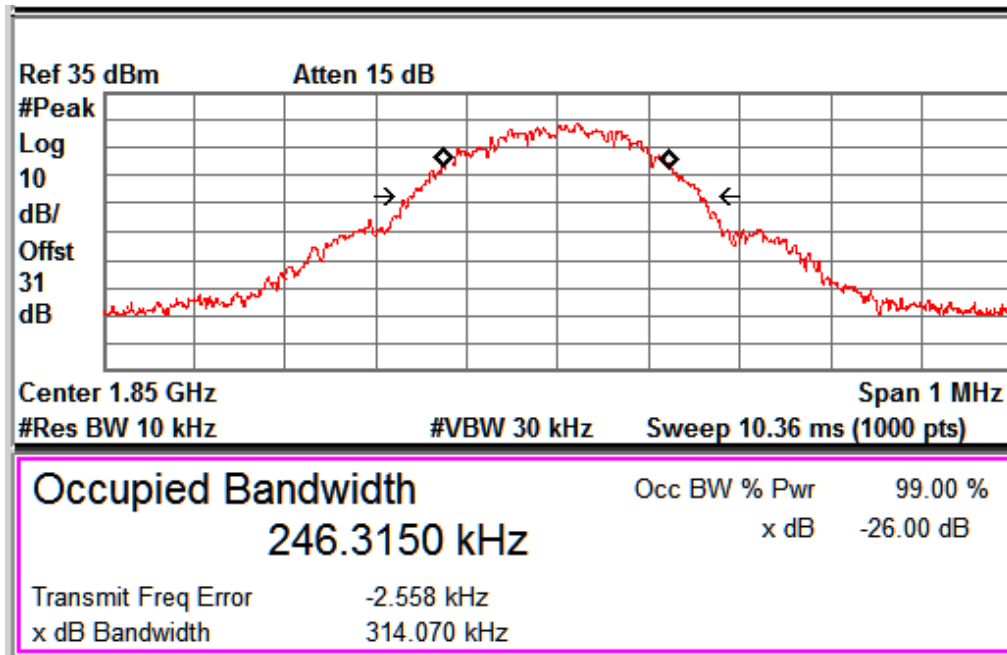

GSM_Voice _ Channel No. 512

www.tuv.com

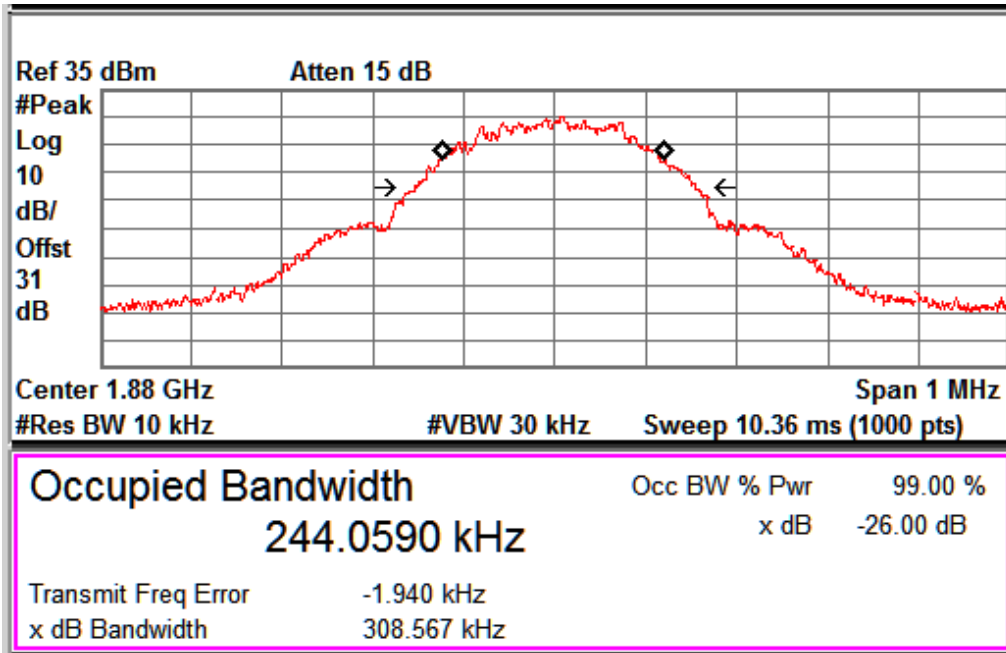

GSM_Voice_Channel No. 661

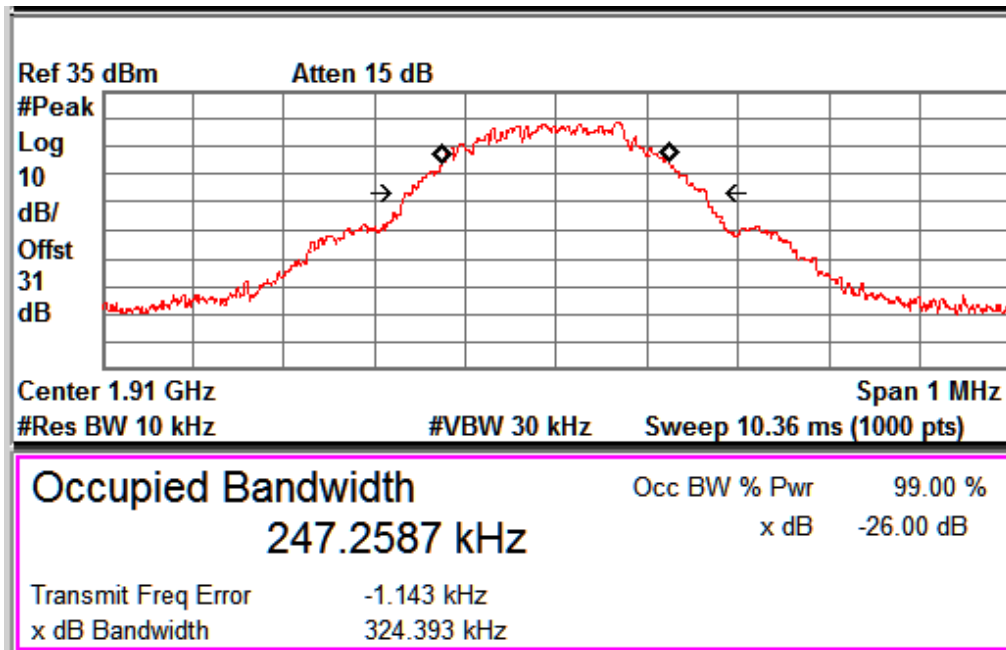

GSM_Voice_Channel No. 810

www.tuv.com

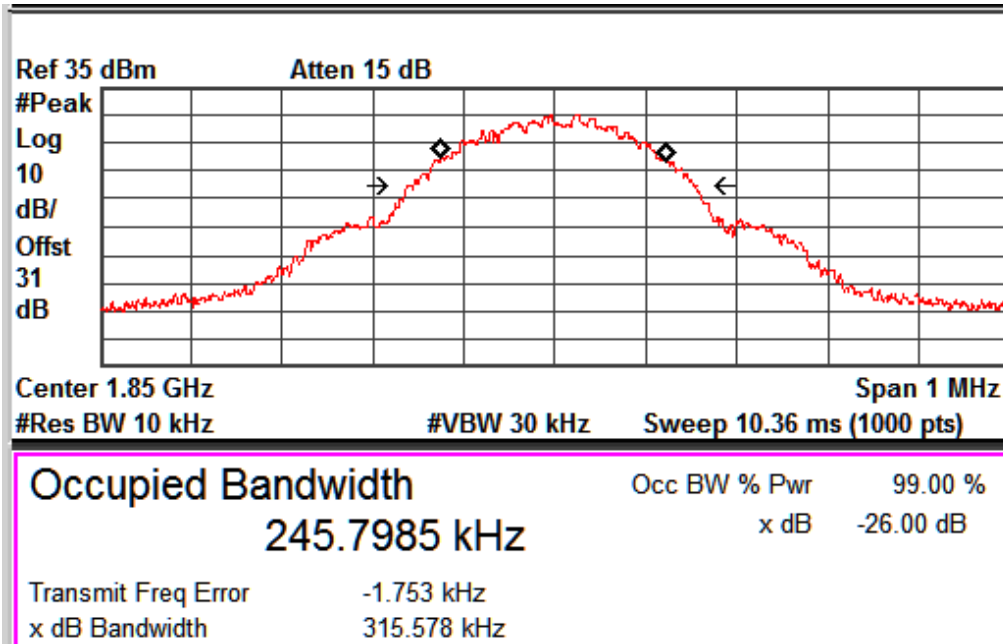

GSM_GPRS_Channel No. 512

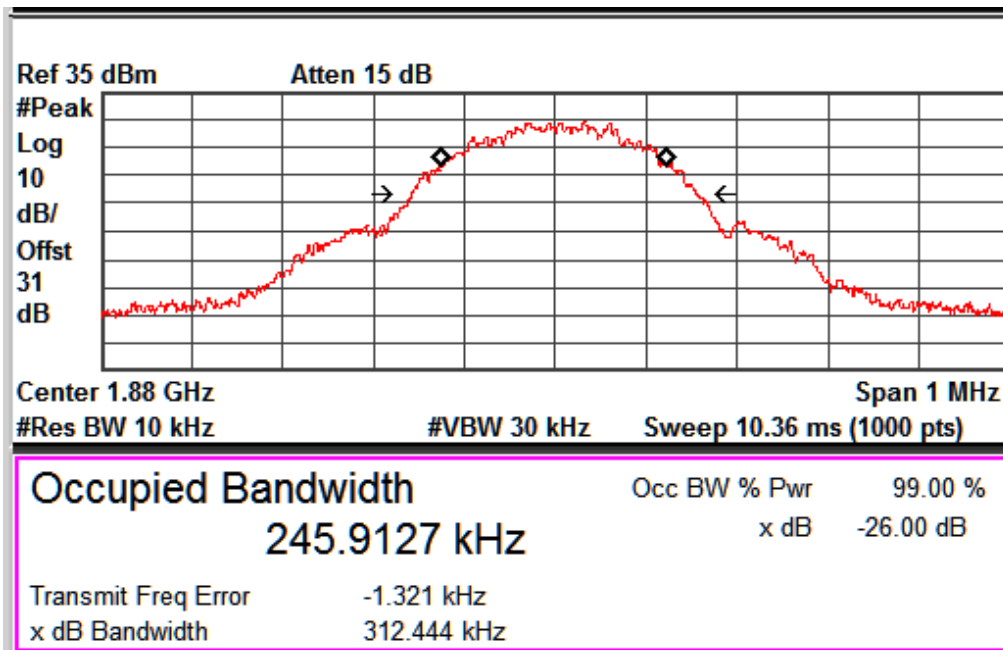

GSM_GPRS_Channel No. 661

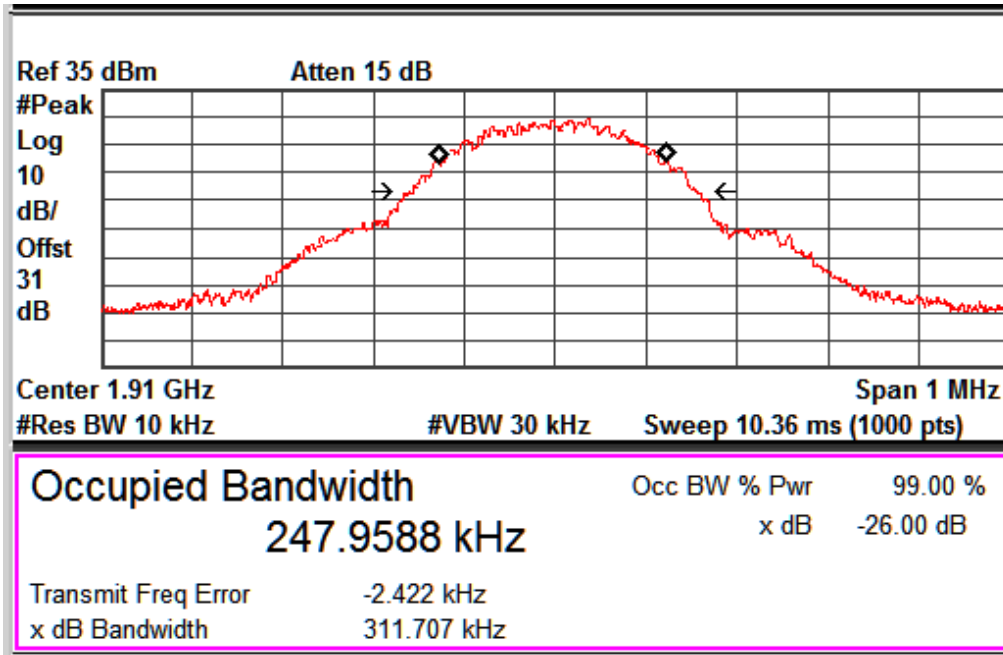
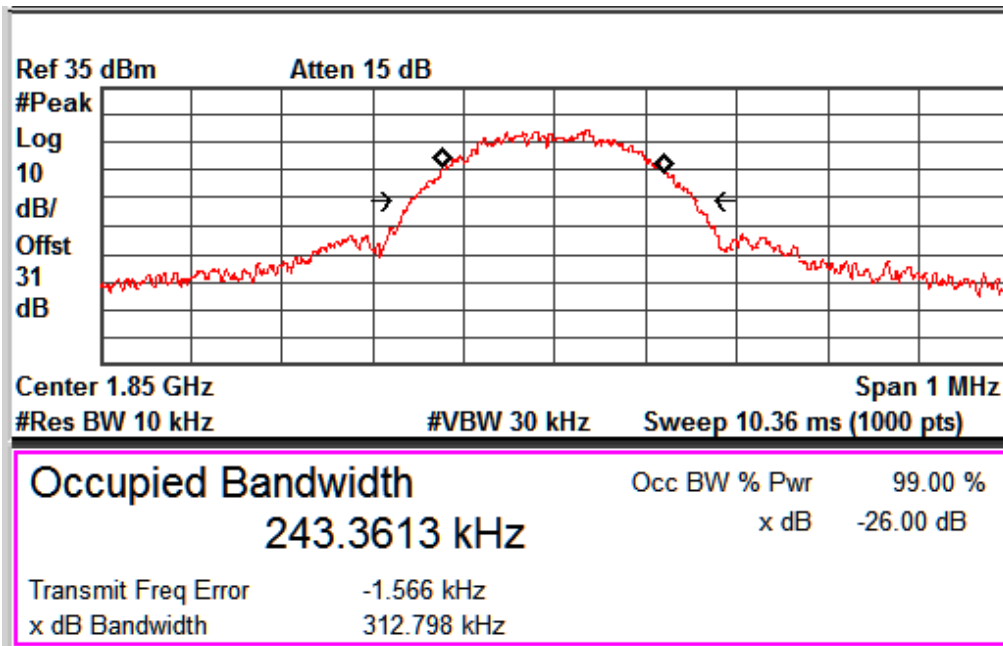
GSM_GPRS_Channel No. 810

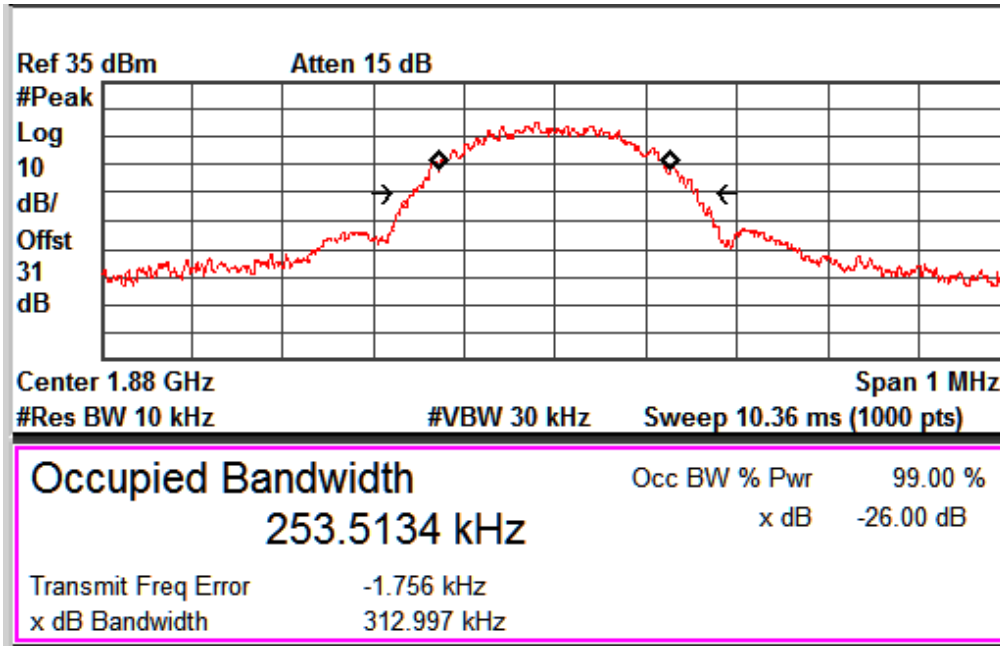
GSM_E-GPRS_Channel No. 512

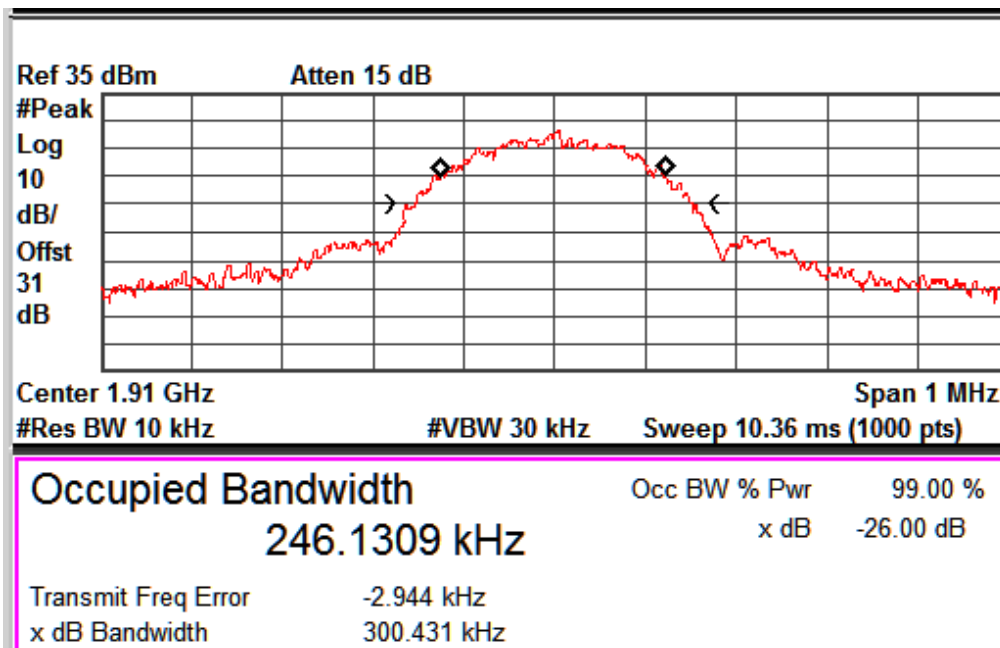

GSM_E-GPRS_Channel No. 661



GSM_E-GPRS_Channel No. 810

www.tuv.com

Band Edge Measurement Result

Pass

Specification FCC Part 2.1053(a), 22.917(a)(b), 24.238(a)(b) & RSS 132 Issue 3 section 5.5, RSS 133 Issue 6 section 6.5 (i)(ii)
 Measurement Bandwidth (RBW) 3kHz
 Detector Function Average
 Requirement Shall be attenuated below the transmitter power (P in watt) by at least $43+10 \log(P)$ dBm,

Test Setup:

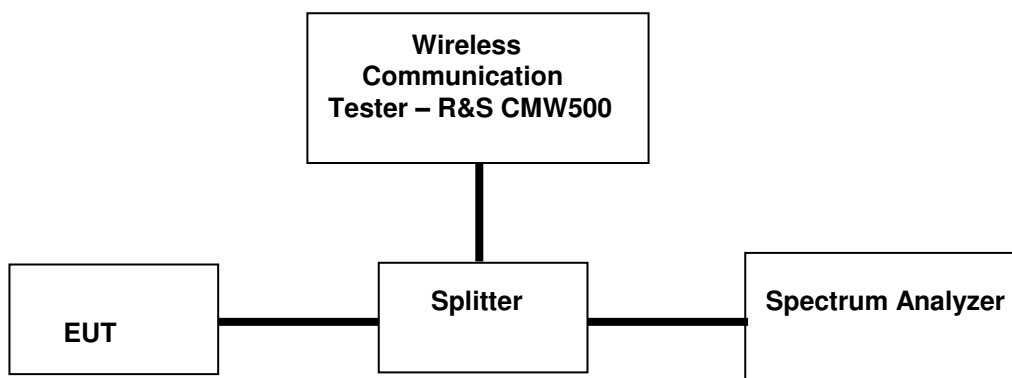

Note: For measurement of Conducted Spurious emission test, section 6.0 in “971168 D01 Power Meas License Digital Systems v02r02” was used.

Test Results:

Mode	Channel Number	Channel Frequency (MHz)	Band edge Frequency Range (MHz)	Band Edge Value (dBm)	Limit (dBm)
GSM 850	128	824.2	823 -824	-21.10	-13
	251	848.8	849 -850	-19.57	-13
GPRS 850	128	824.2	823 -824	-21.87	-13
	251	848.8	849 -850	-21.51	-13
E-GPRS 850	128	824.2	823 -824	-30.92	-13
	251	848.8	849 -850	-34.12	-13
PCS 1900	512	1850.2	1849 - 1850	-22.49	-13
	810	1909.8	1910 - 1911	-21.26	-13
GPRS 1900	512	1850.2	1849 - 1850	-25.6	-13
	810	1909.8	1910 - 1911	-24.74	-13
E-GPRS 1900	512	1850.2	1849 - 1850	-32.51	-13
	810	1909.8	1910 - 1911	-30.86	-13

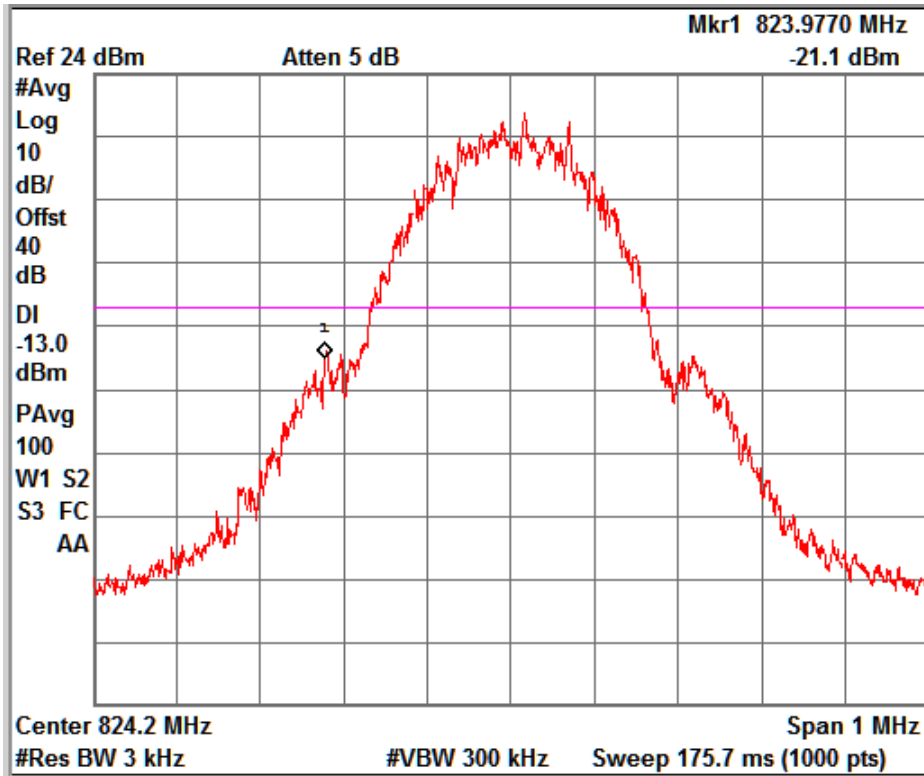

GSM_Voice_Channel No. 128

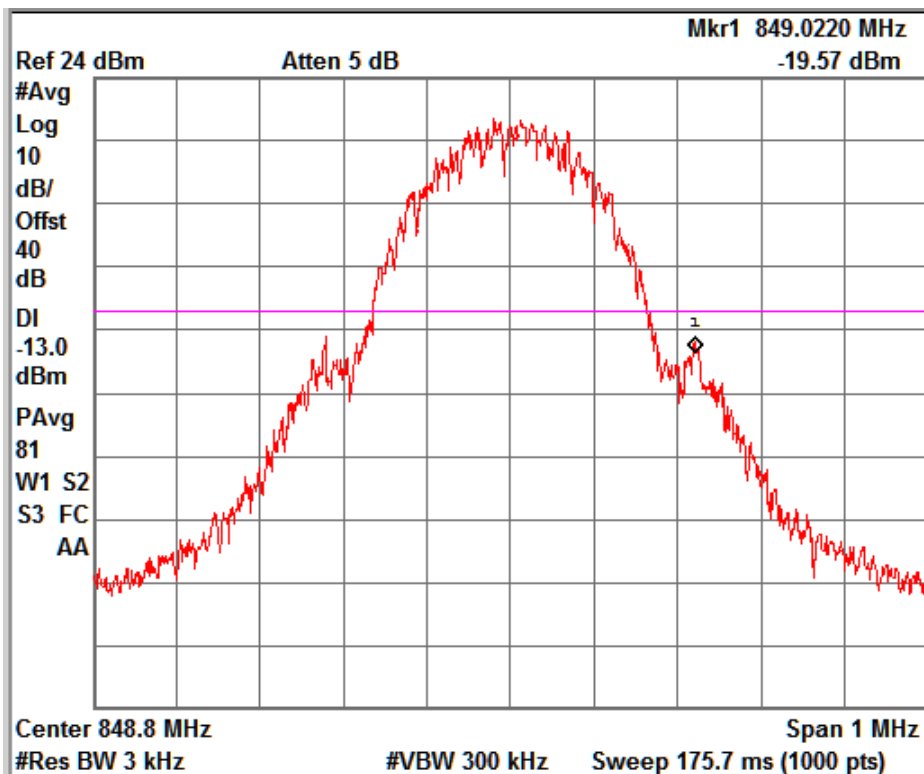

GSM_Voice_Channel No. 251

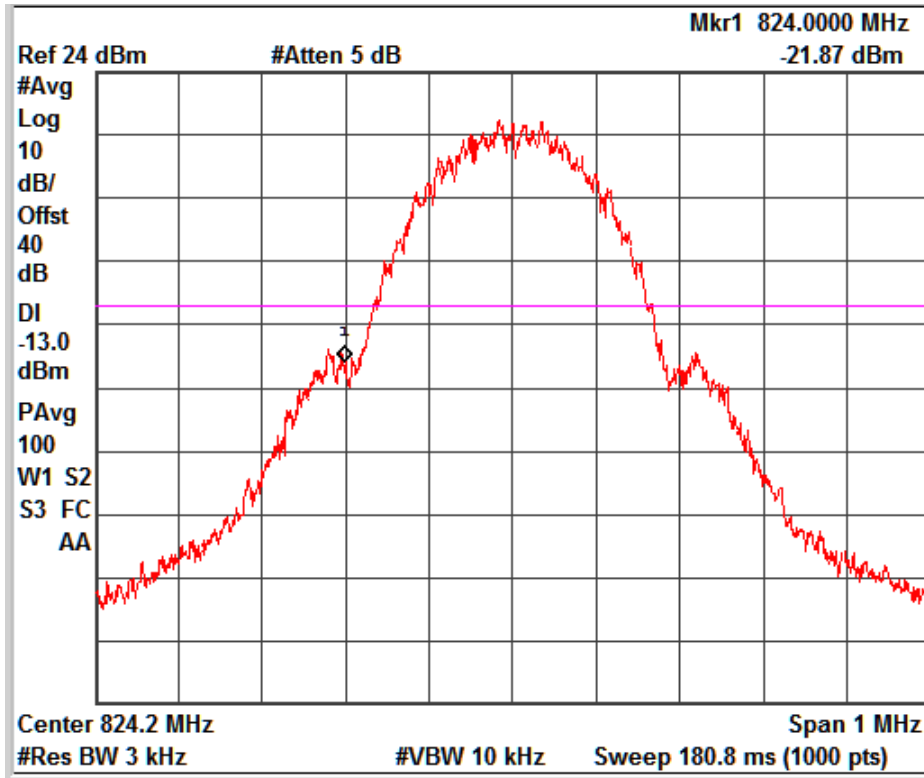

GSM_GPRS_Channel No. 128

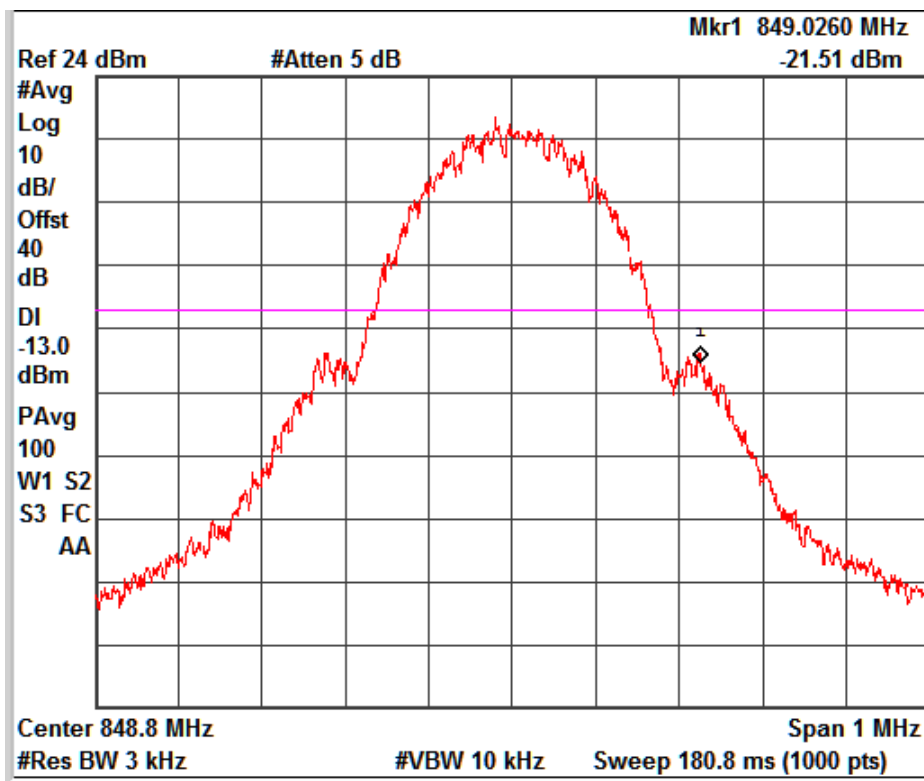

GSM_GPRS_Channel No. 251

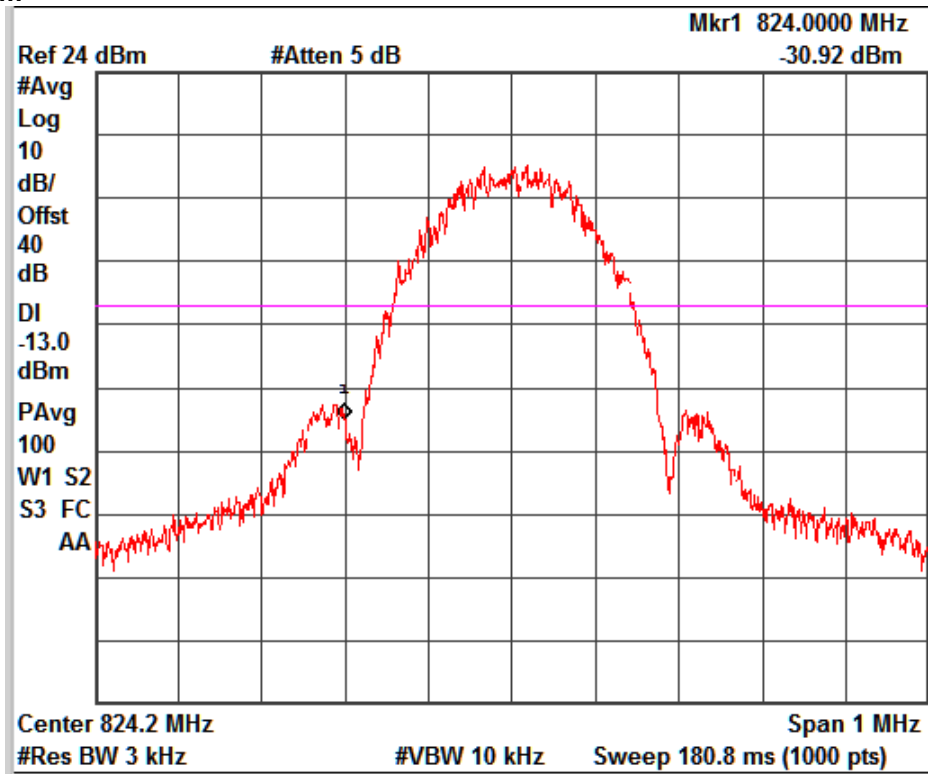

GSM_E-GPRS _ Channel No. 128

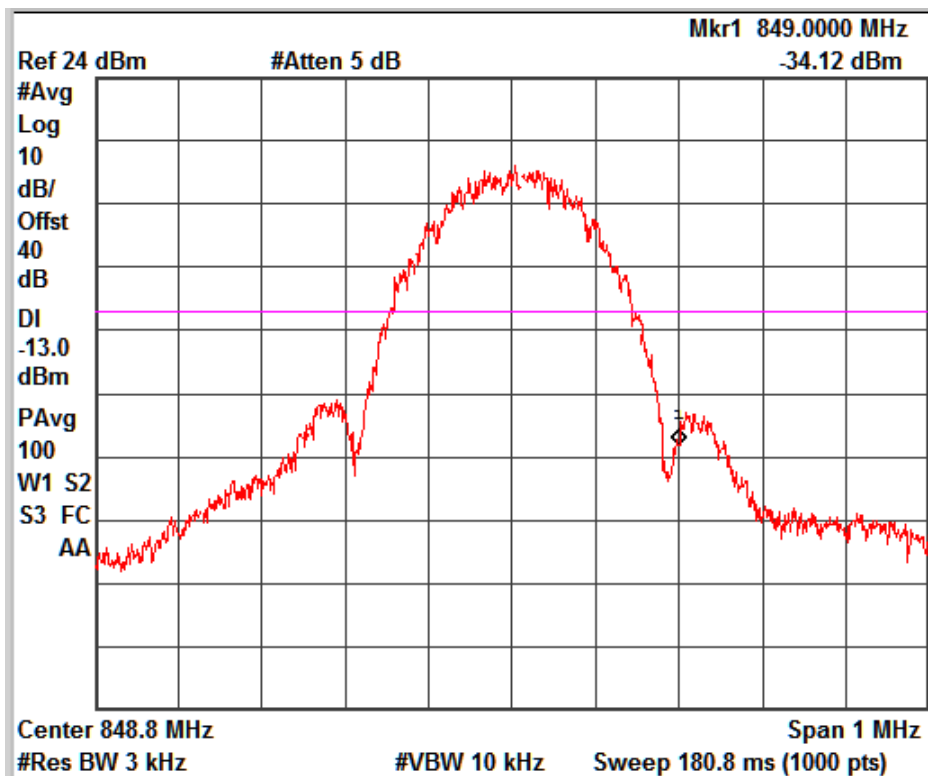

GSM_E-GPRS _ Channel No. 251

www.tuv.com

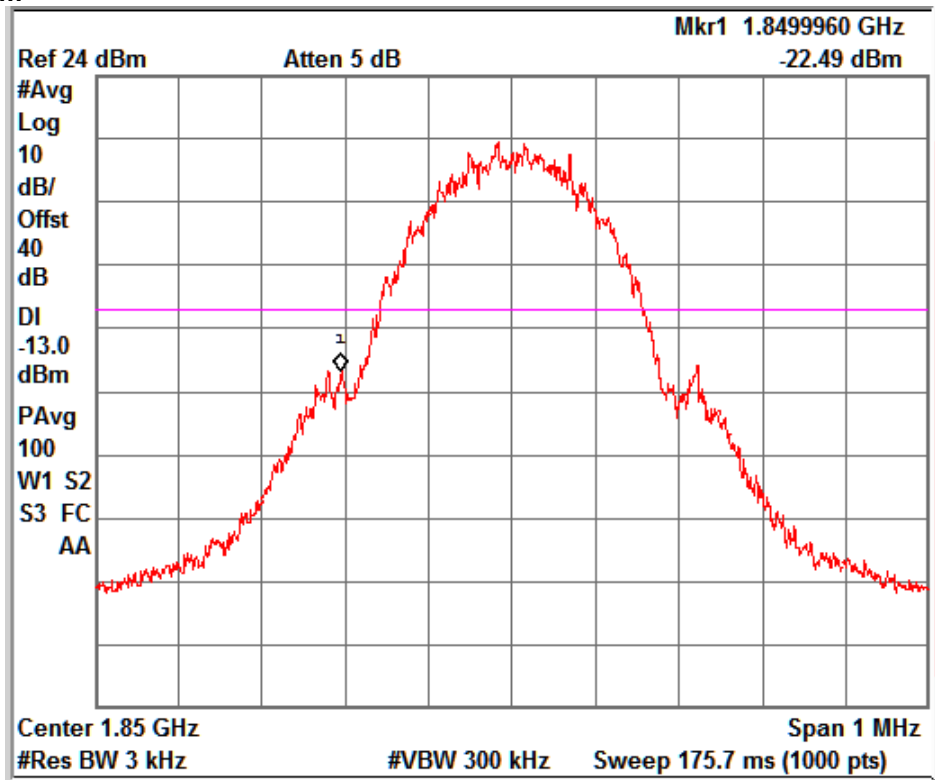

GSM_Voice_Channel No. 512

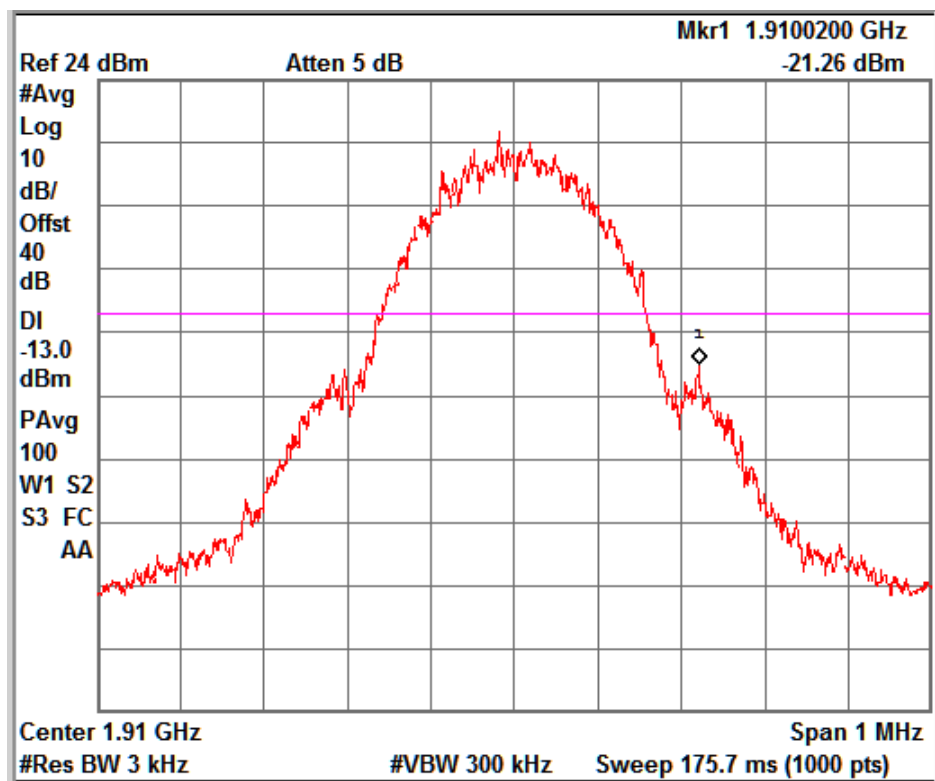

GSM_Voice_Channel No. 810

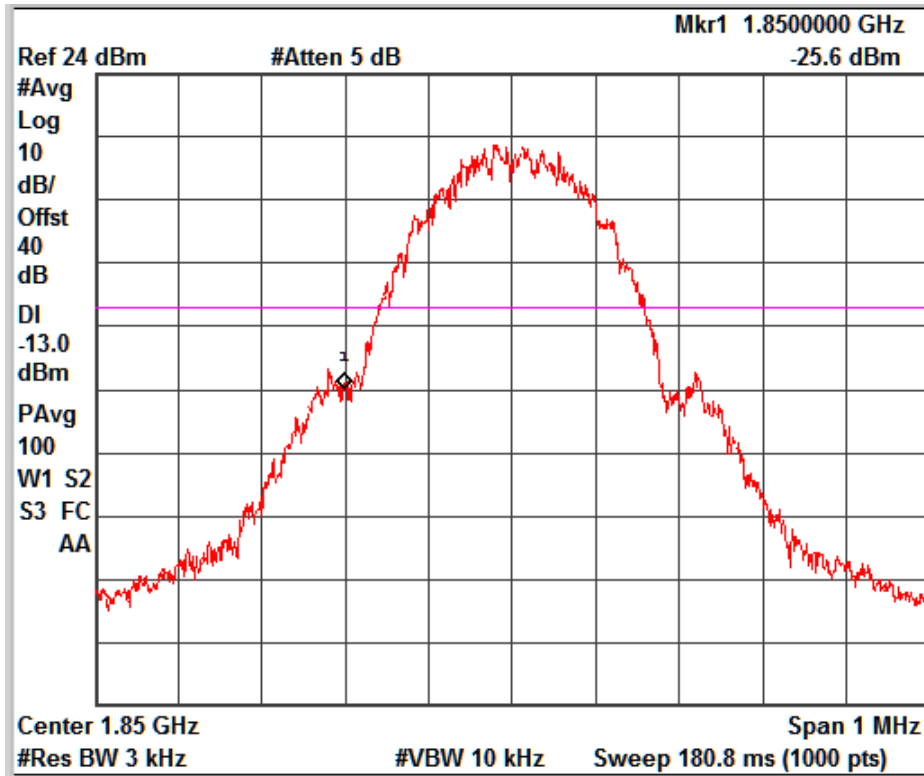

GSM_GPRS_Channel No. 512

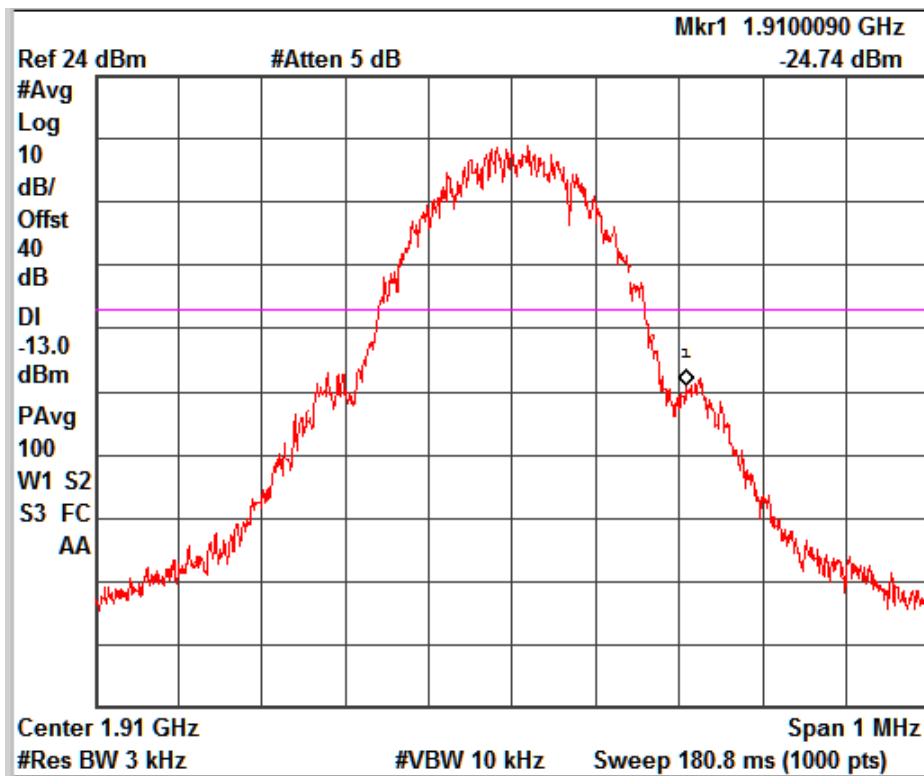

GSM_GPRS_Channel No. 810

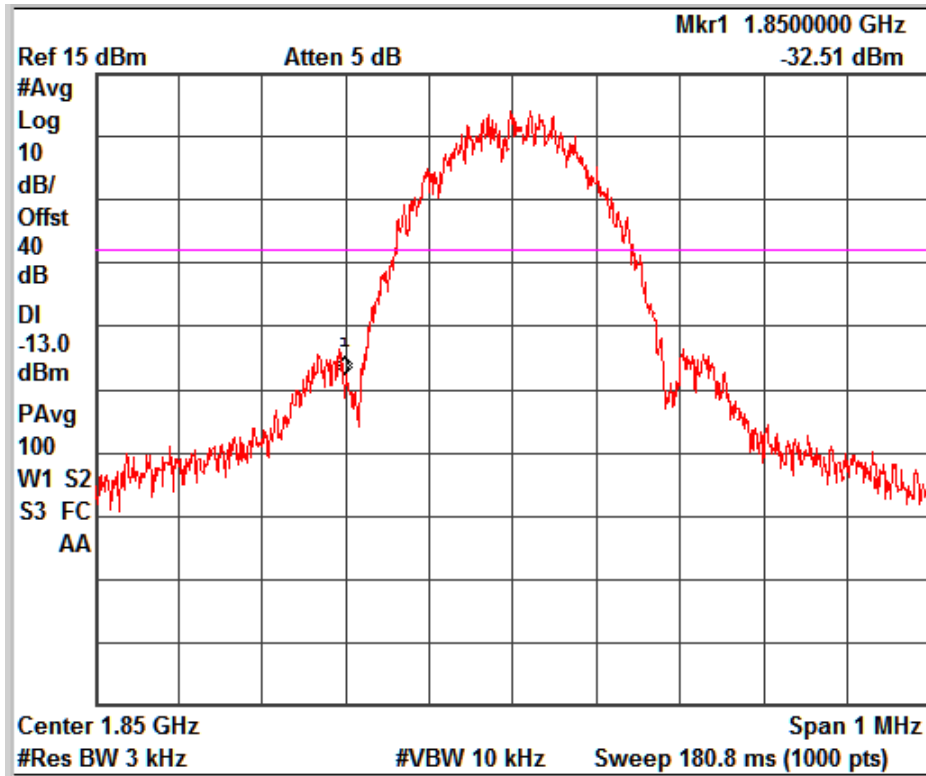

GSM_E-GPRS _ Channel No. 512

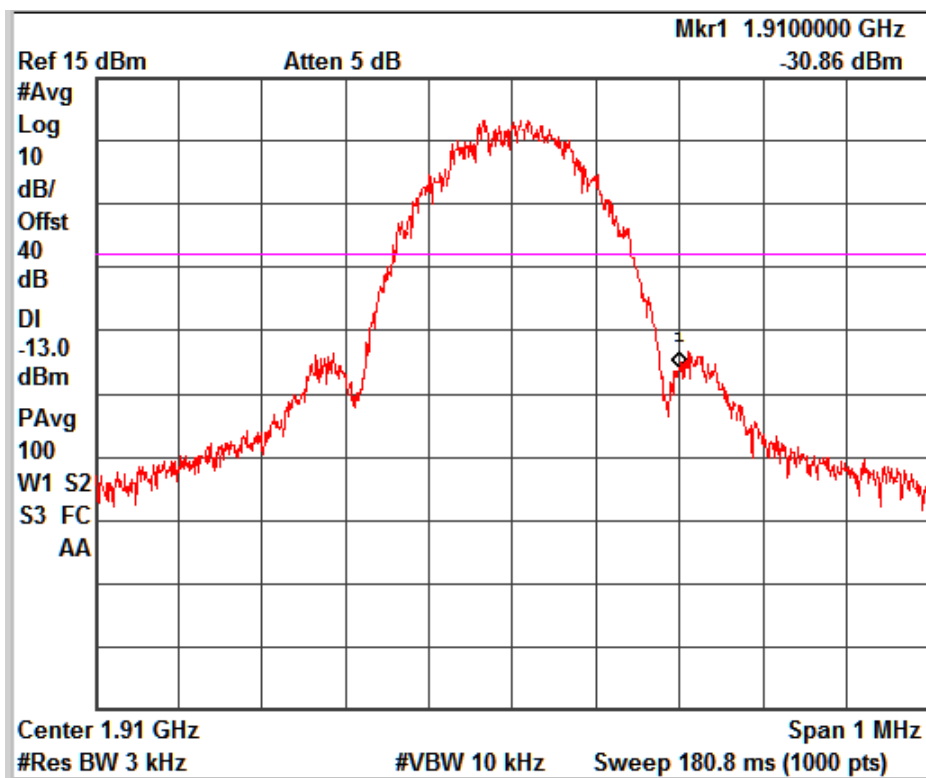

GSM_E-GPRS _ Channel No. 810

www.tuv.com

**Conducted Spurious Emission
Result**

Pass

Specification	FCC Part 2.1051, 22.917(a)(b) 24.238(a) (b) & RSS 132 Issue 3 section 5.5 , RSS 133 Issue 6 section 6.5
Measurement Bandwidth (RBW)	100 kHz/1MHz
Detector Function	Peak
Requirement	Shall be attenuated below the transmitter power (P in watt) by at least $43+10 \log(P)$ dBm,

Test Setup:

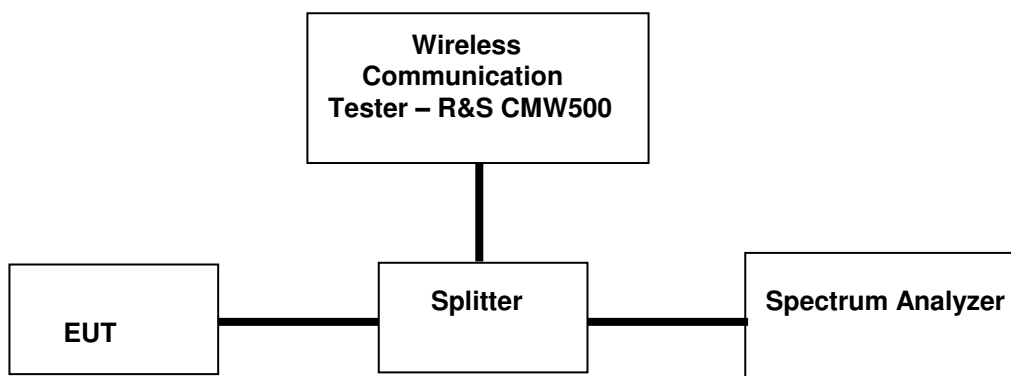

Note: For measurement of Conducted Spurious emission test, section 6.0 in “971168 D01 Power Meas License Digital Systems v02r02” was used.

www.tuv.com

Test Results

Remark: Limit for antenna port conducted spurious emission test is -13dBm

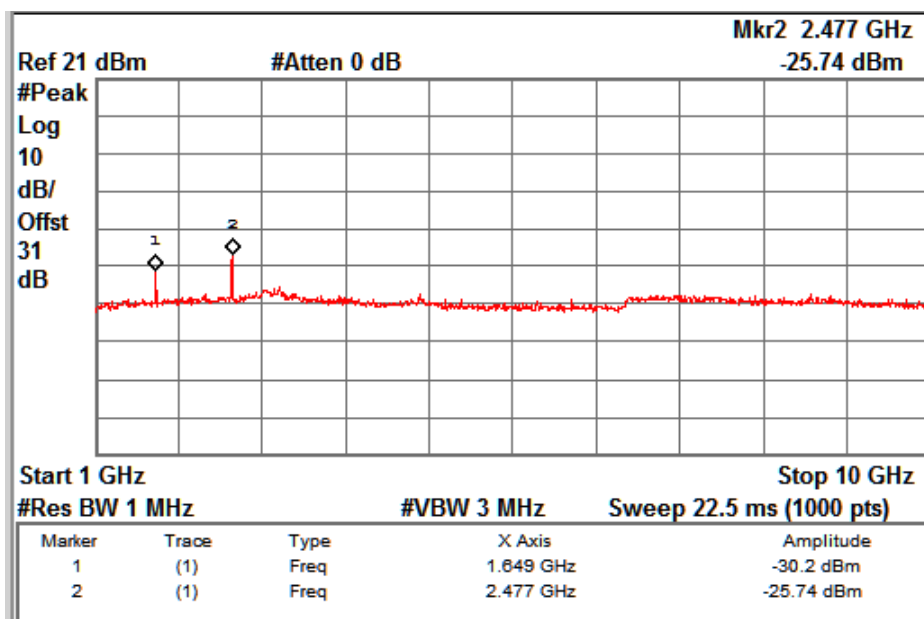
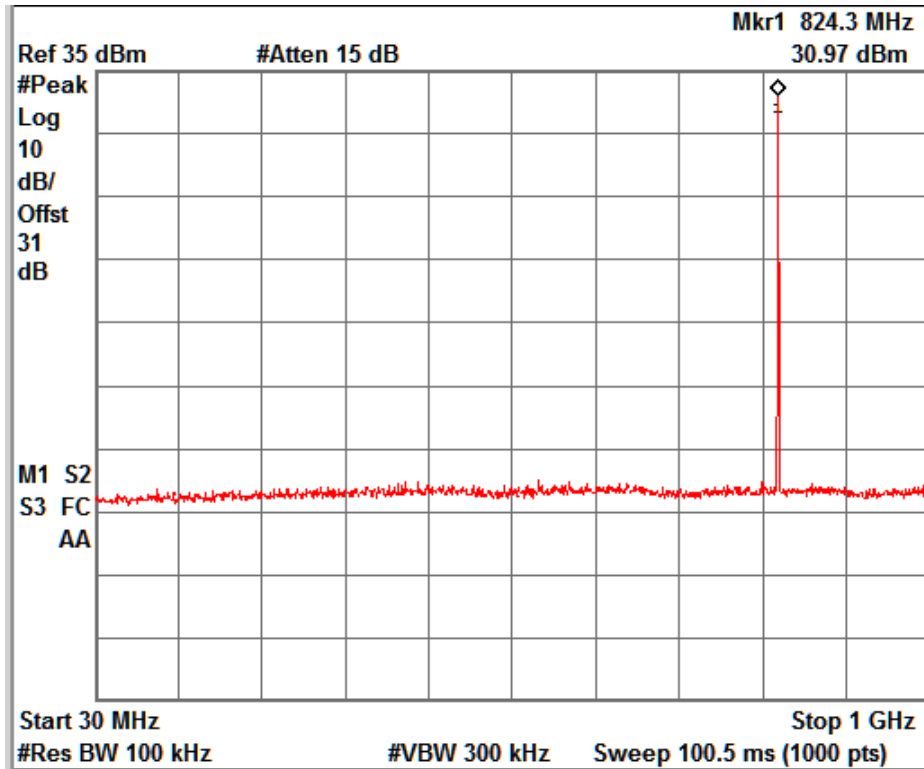

GSM_Voice_Channel No. 128

www.tuv.com

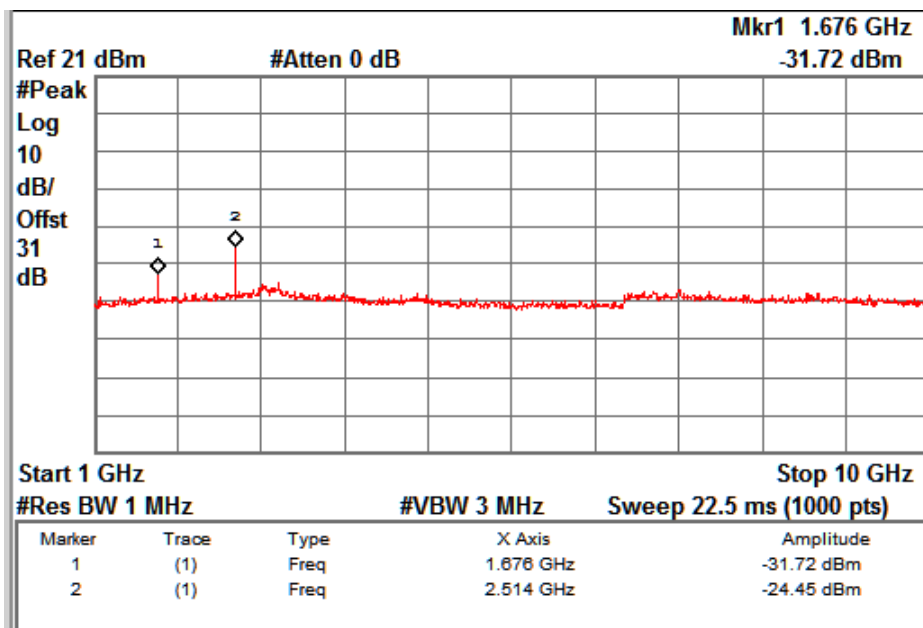
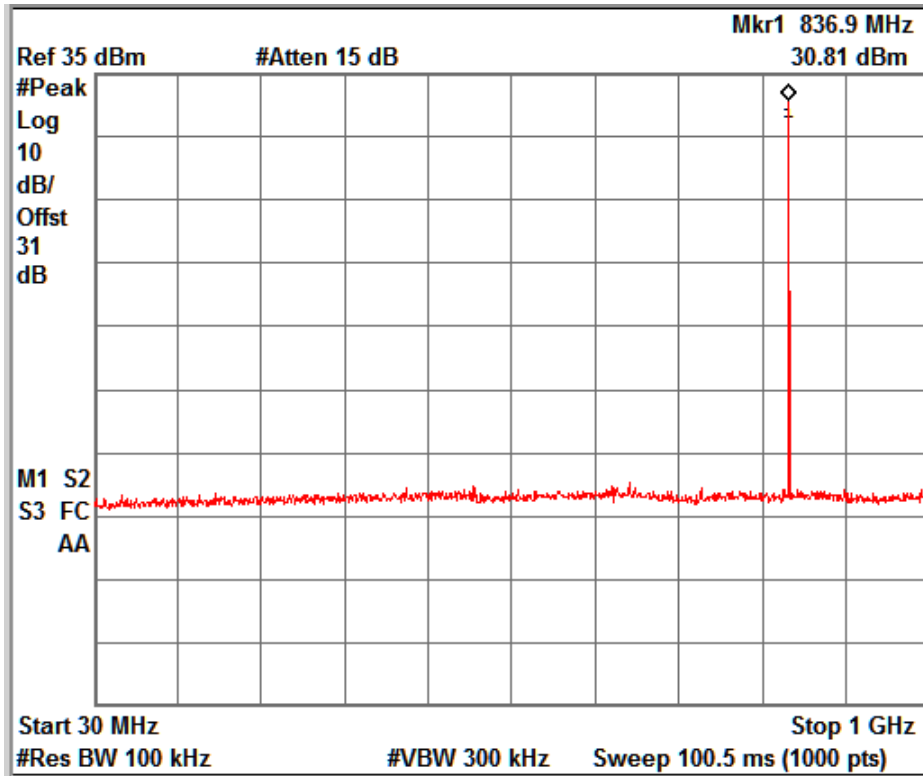

GSM_Voice _ Channel No. 190

www.tuv.com

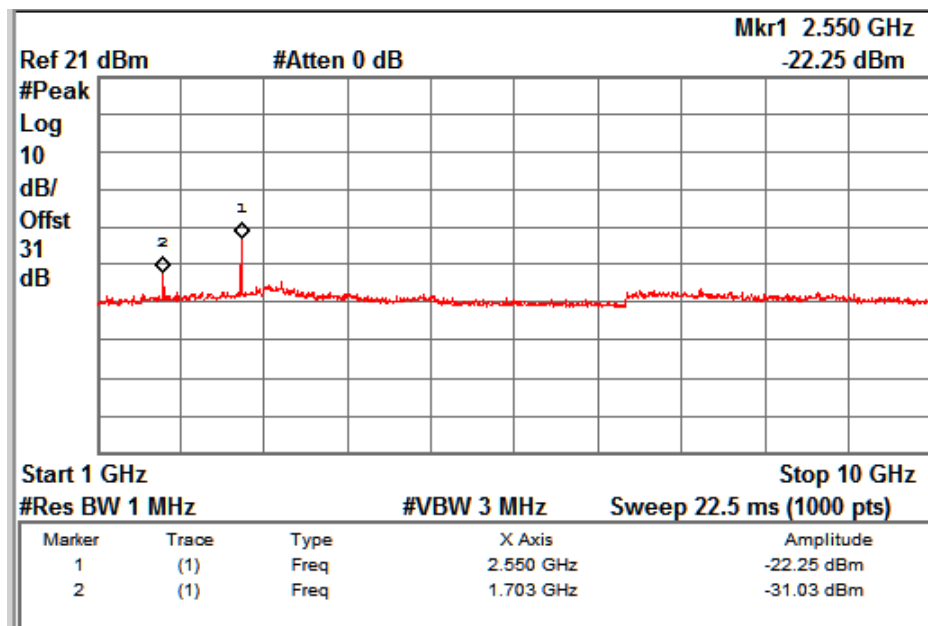
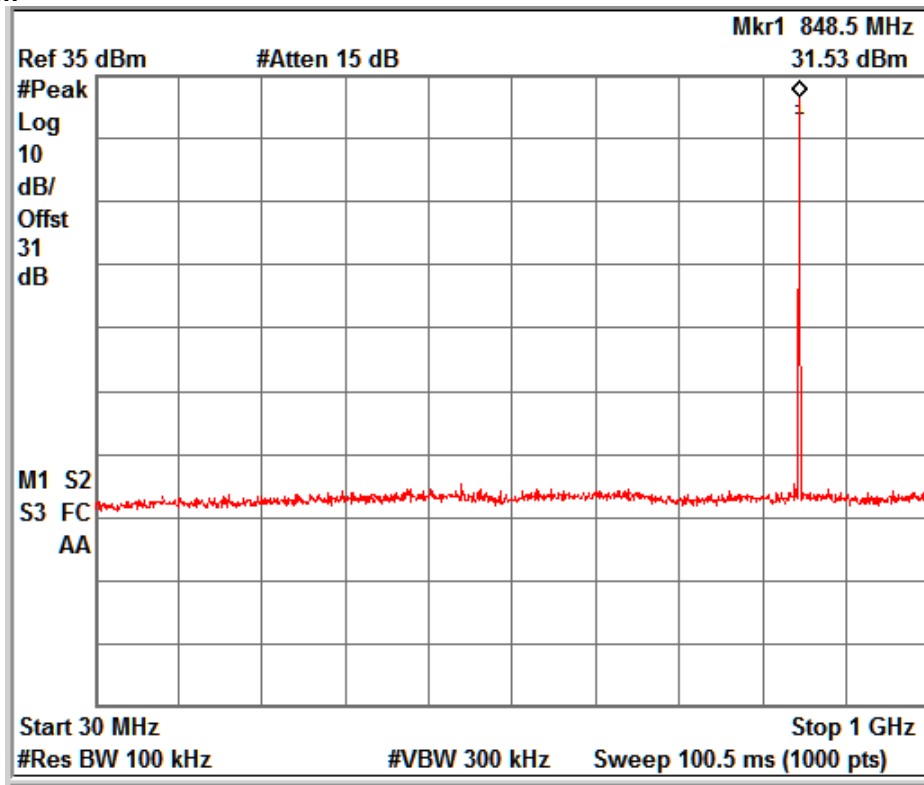

GSM_Voice_Channel No. 251

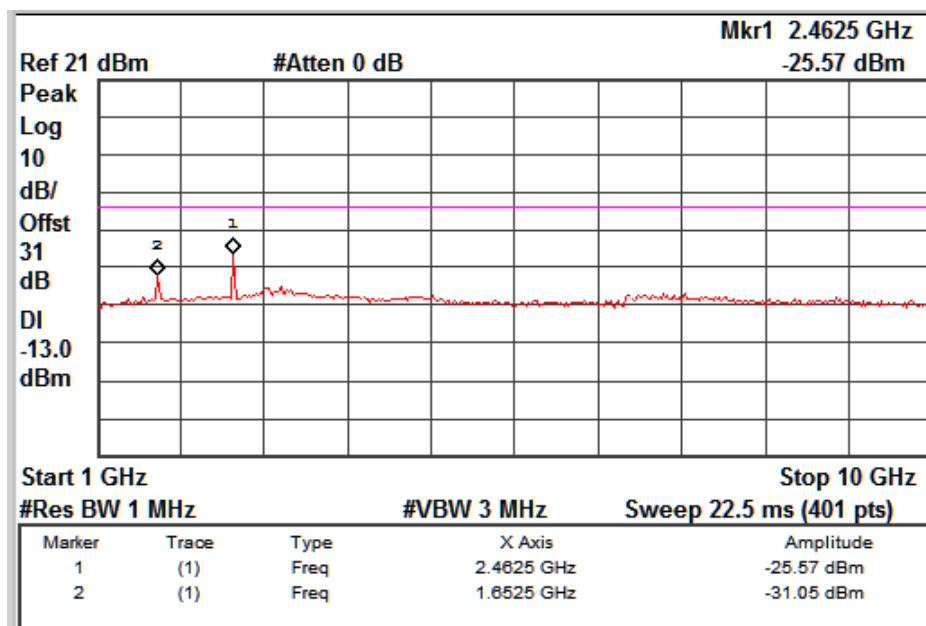
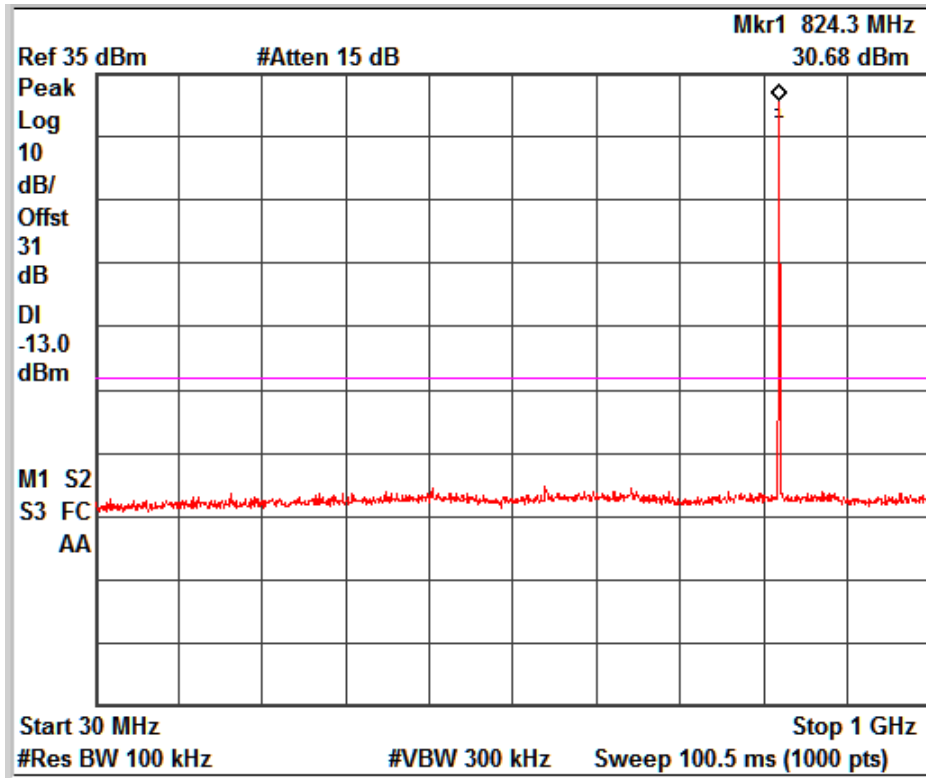

GSM_ GPRS _ Channel No. 128

www.tuv.com

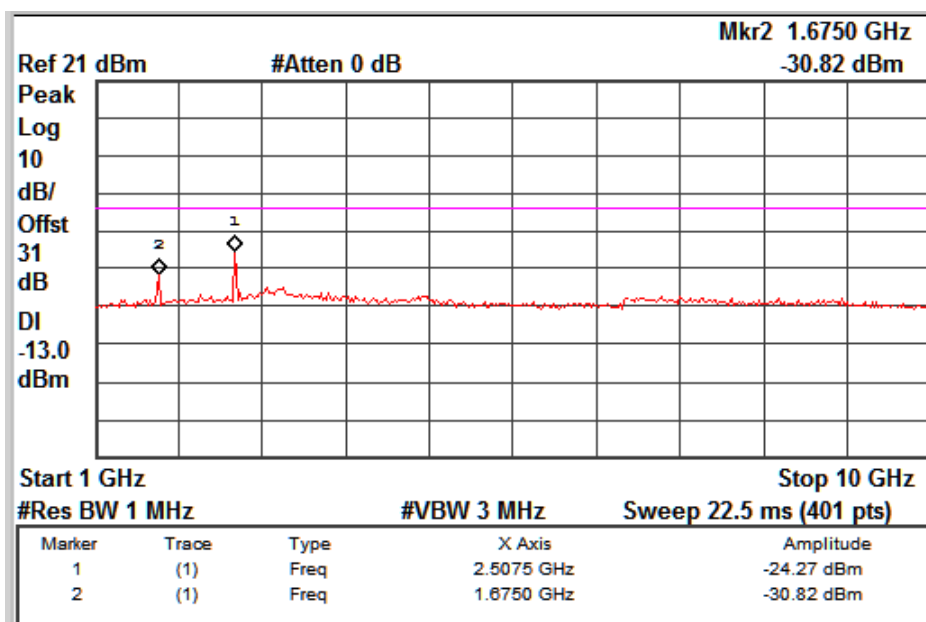
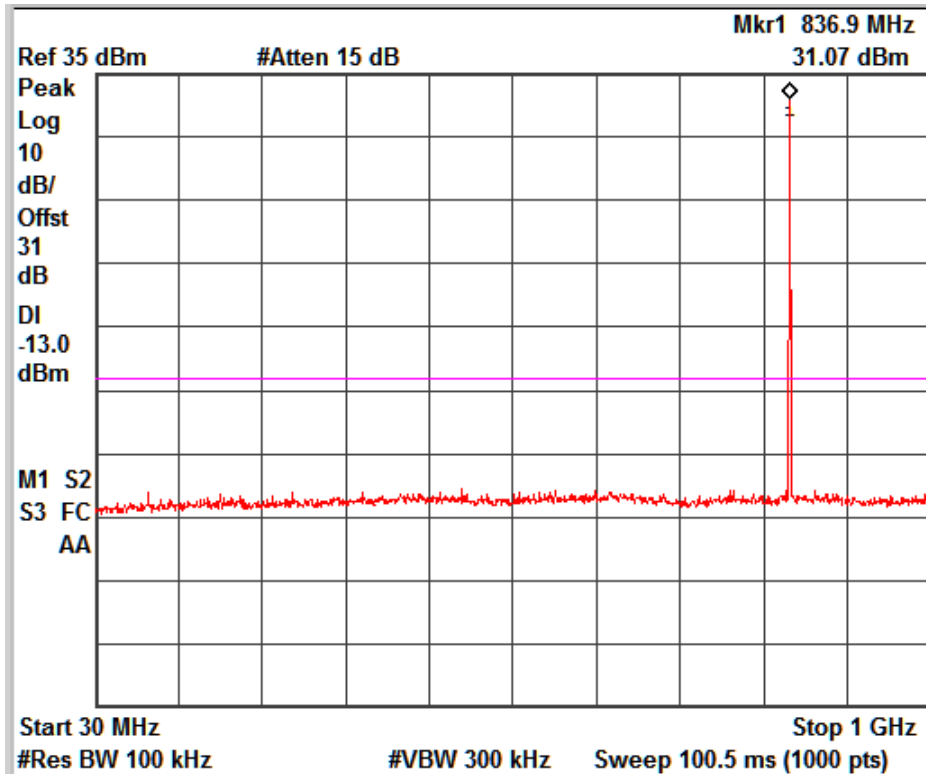

GSM_GPRS_Channel No. 190

www.tuv.com

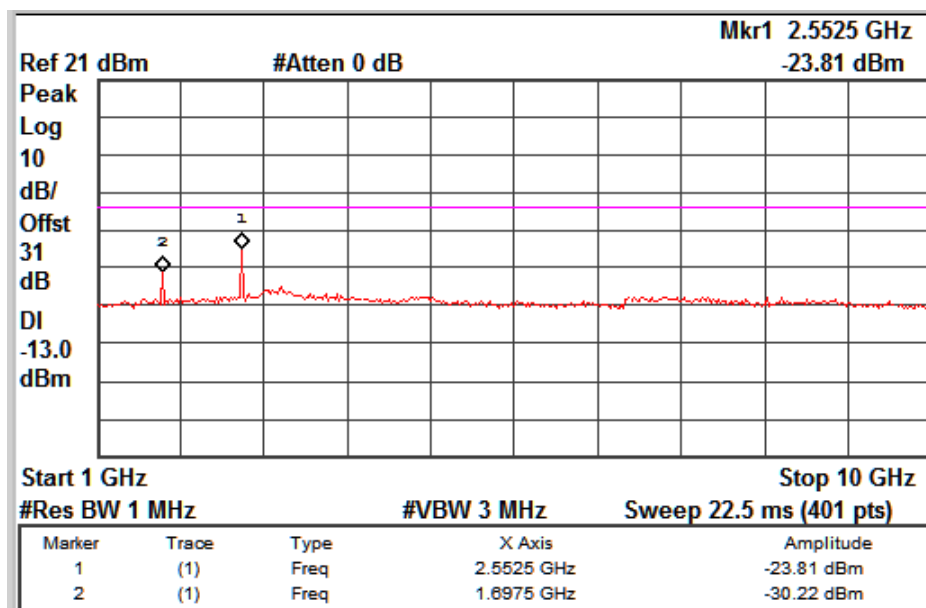
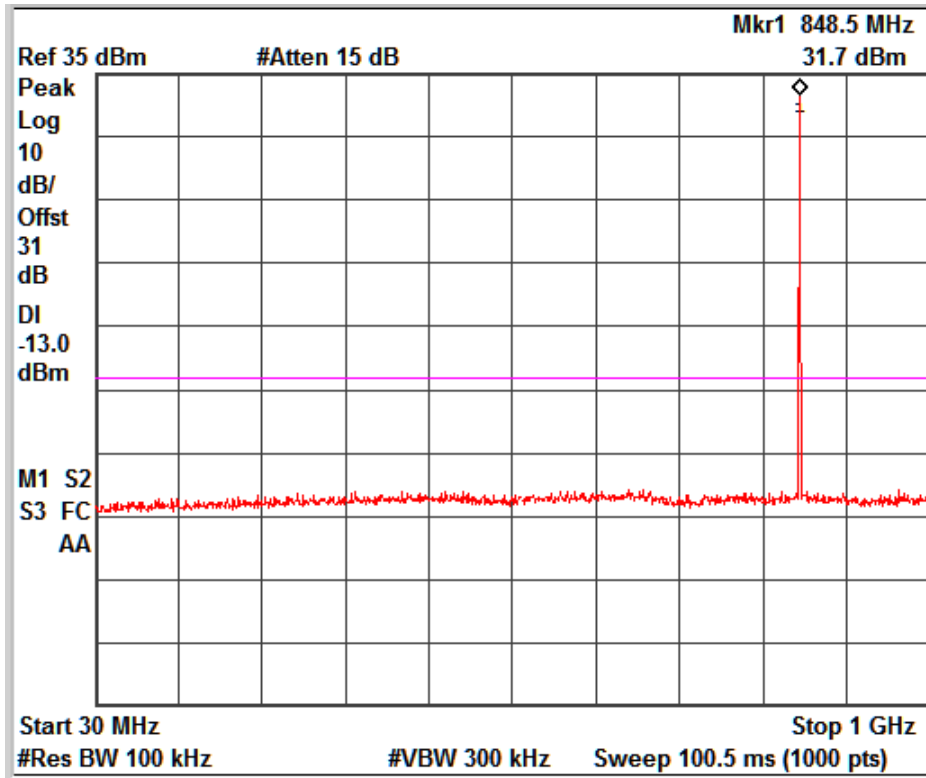

GSM_ GPRS _ Channel No. 251

www.tuv.com

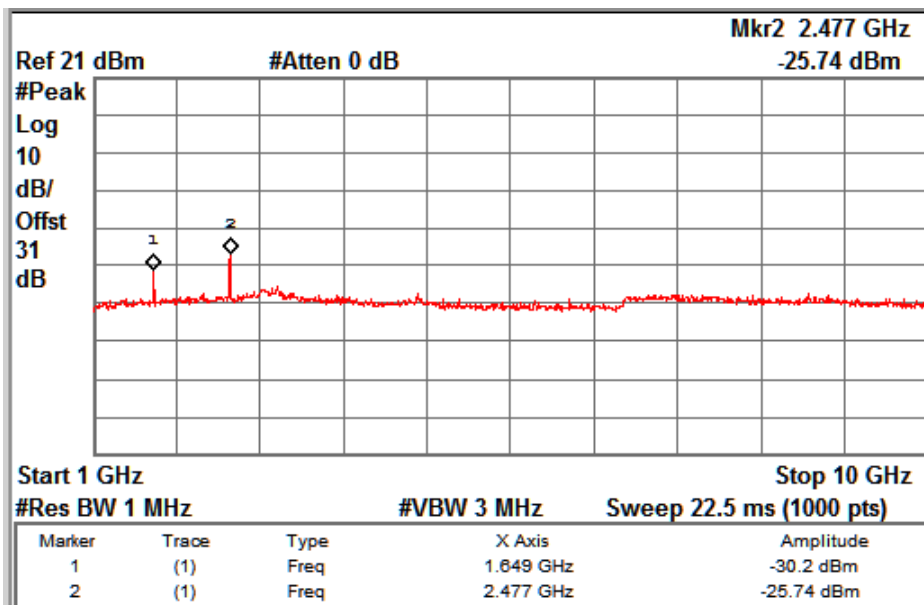
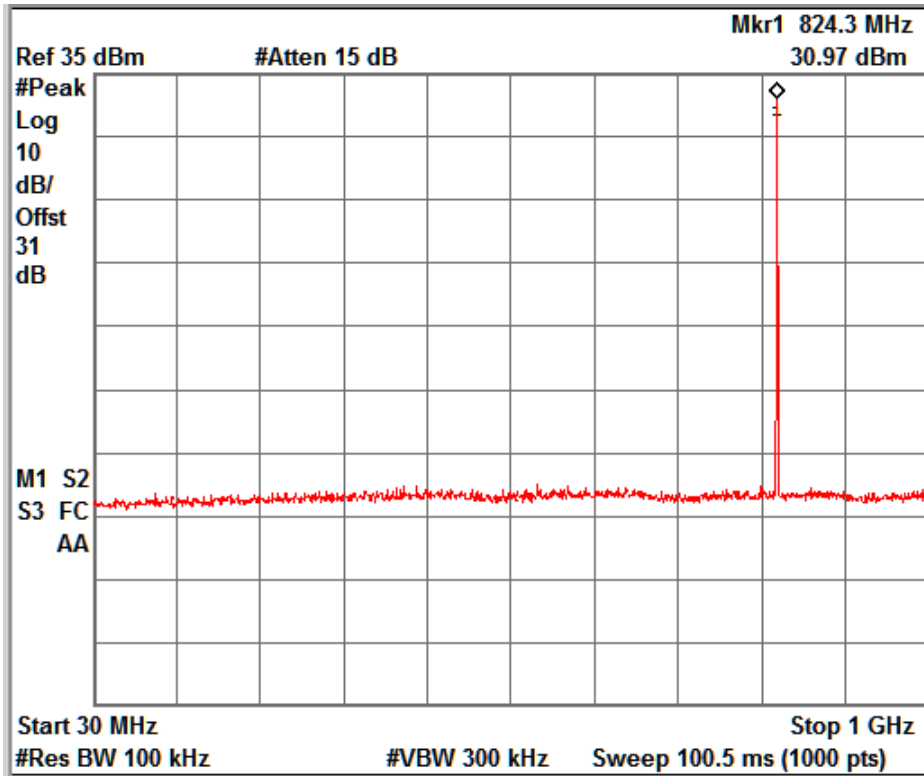

GSM_E-GPRS _ Channel No. 128

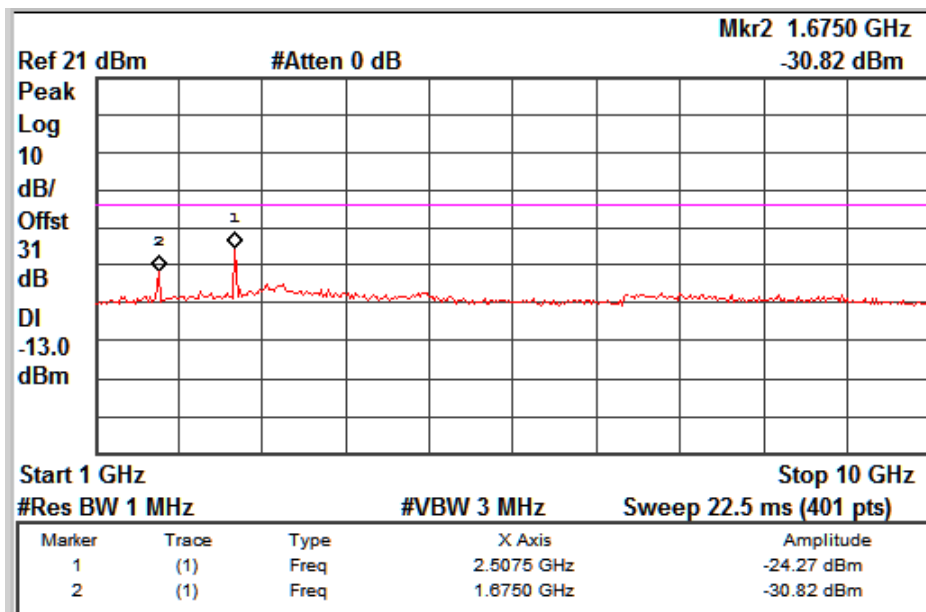
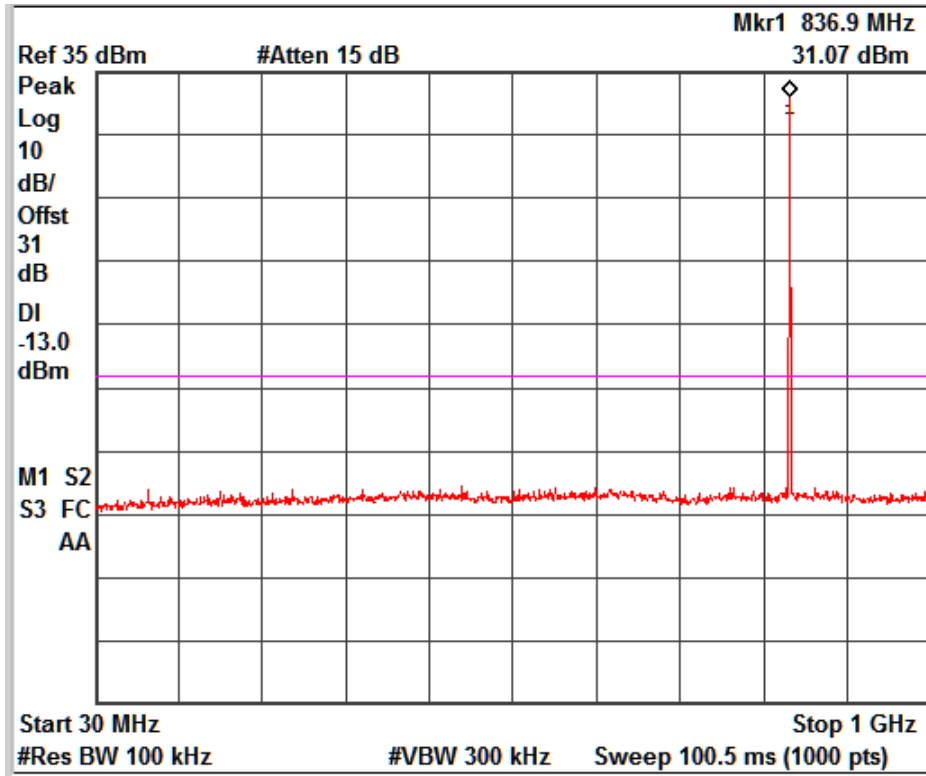

GSM_E-GPRS_Channel No. 190

www.tuv.com

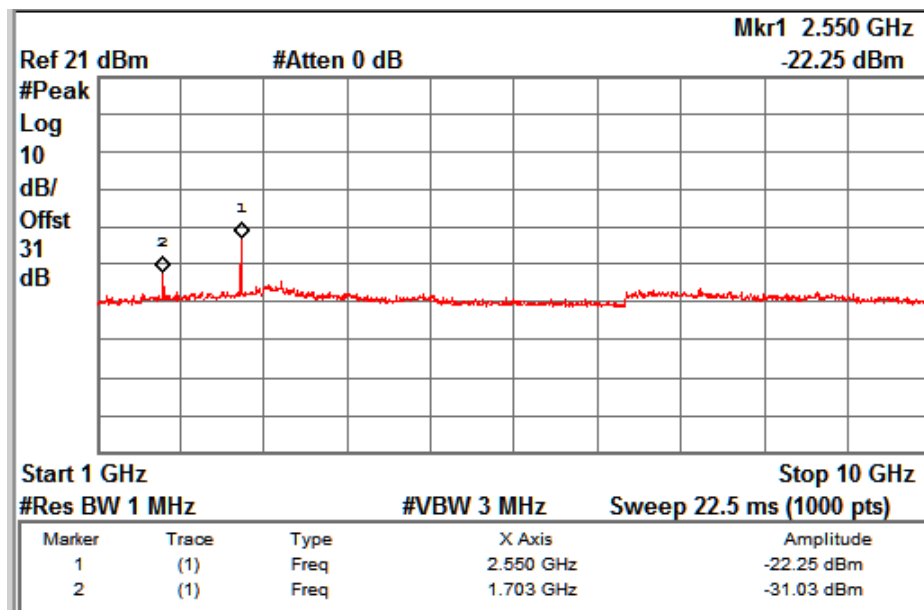
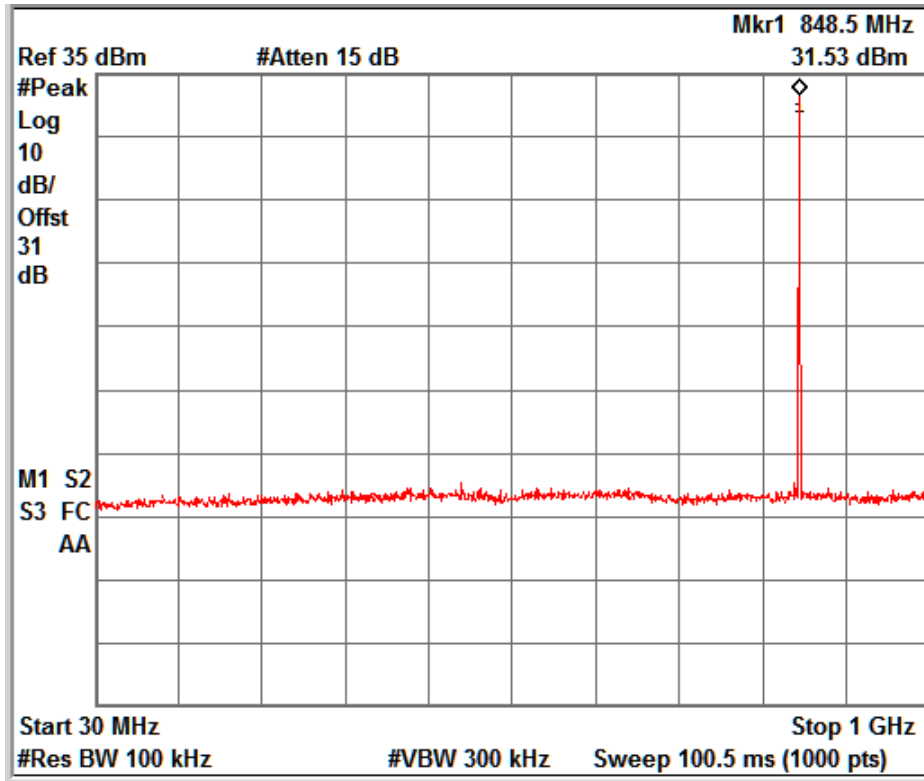

GSM_E-GPRS _ Channel No. 251

www.tuv.com

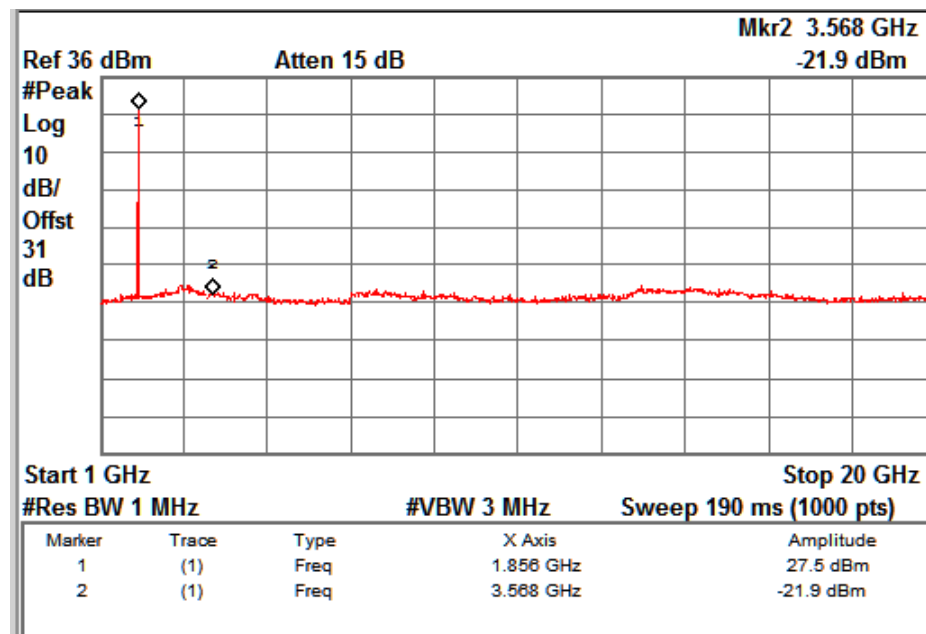
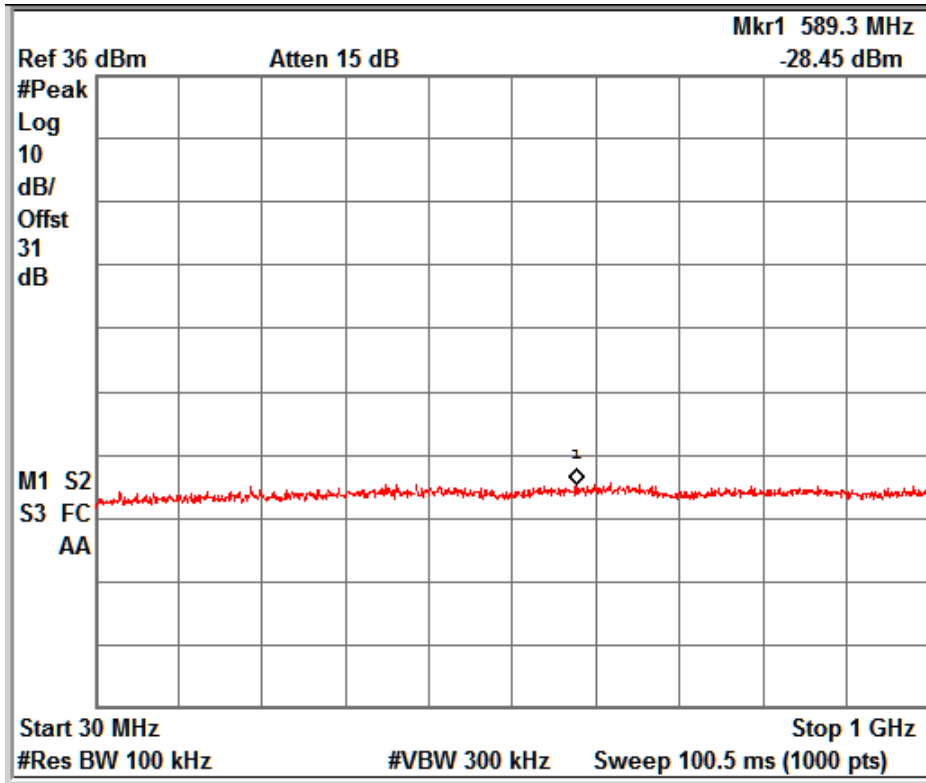

GSM_Voice_Channel No. 512

www.tuv.com

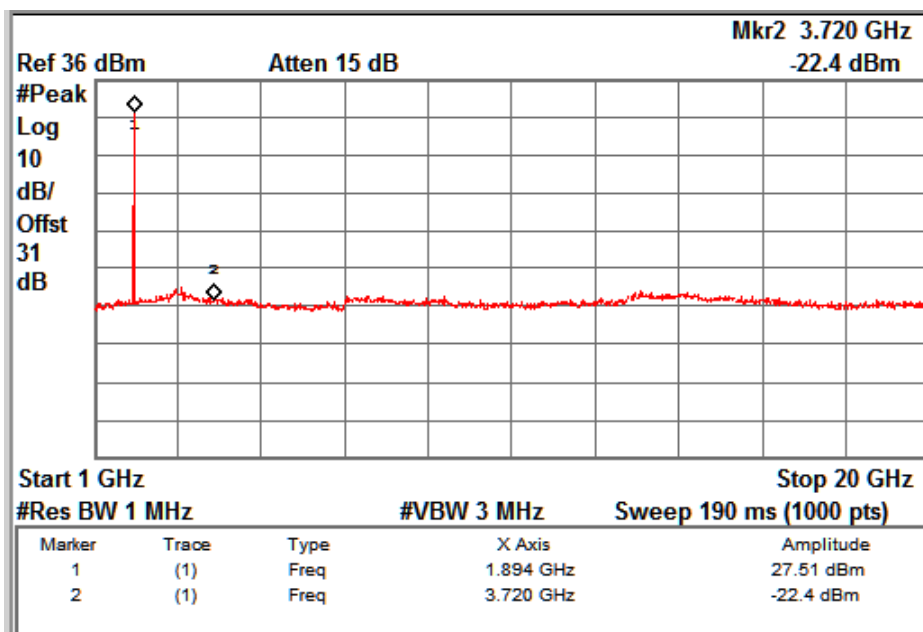
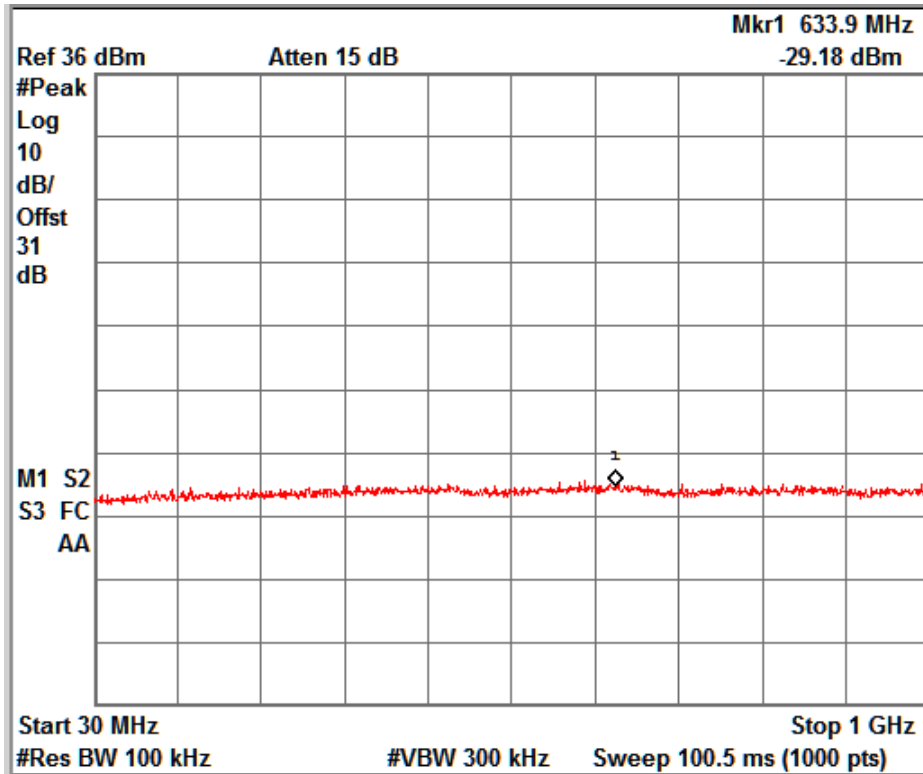

GSM_Voice _ Channel No. 661

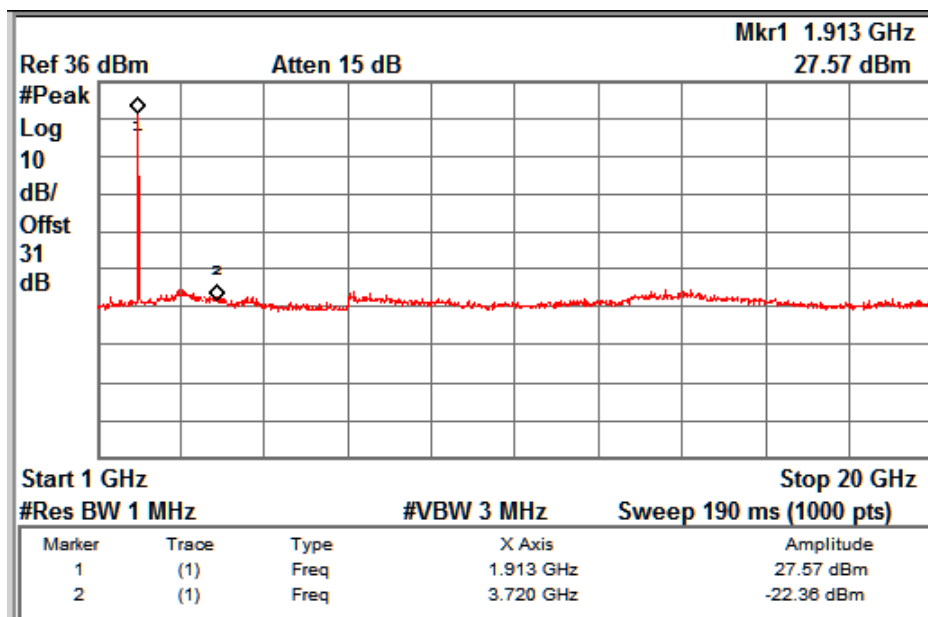
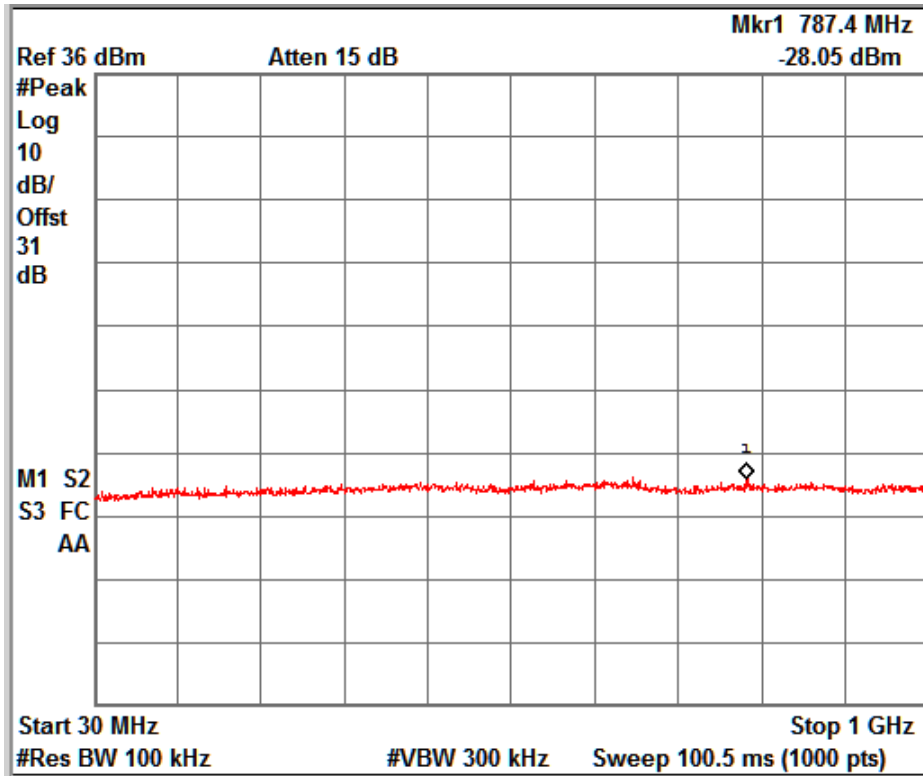

GSM_Voice_Channel No. 810

www.tuv.com

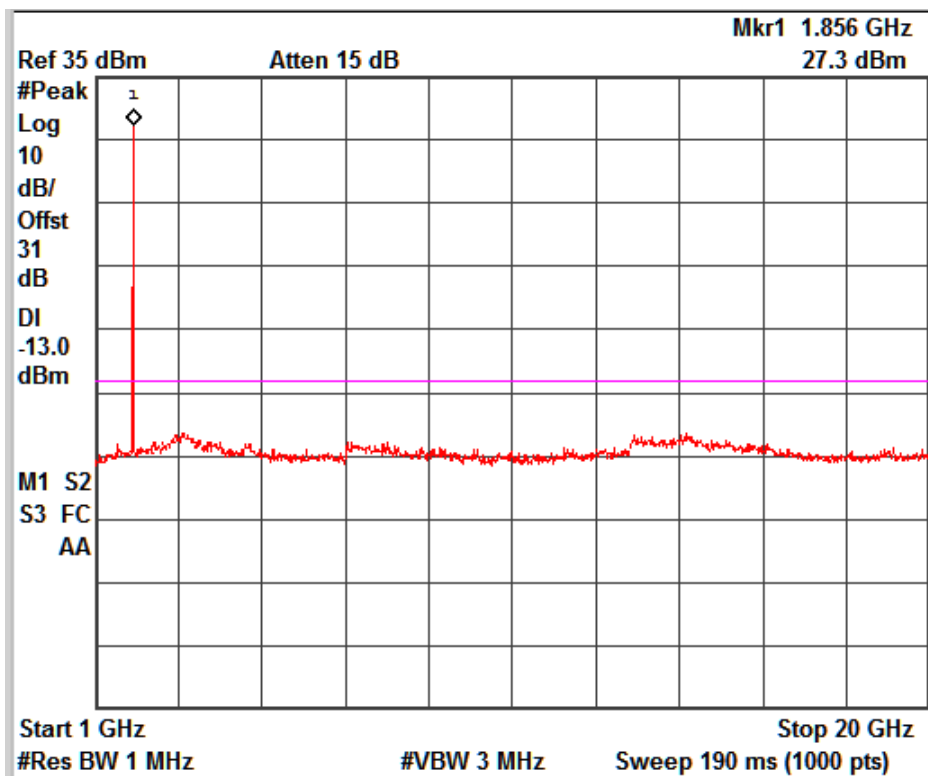
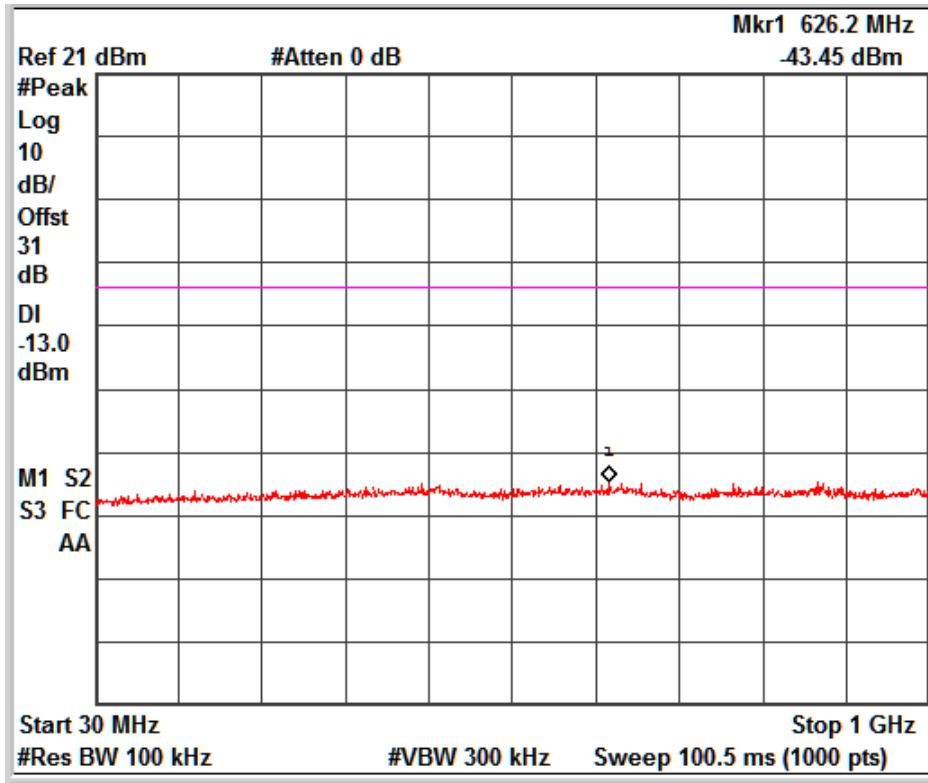

GSM_ GPRS _ Channel No. 512

www.tuv.com

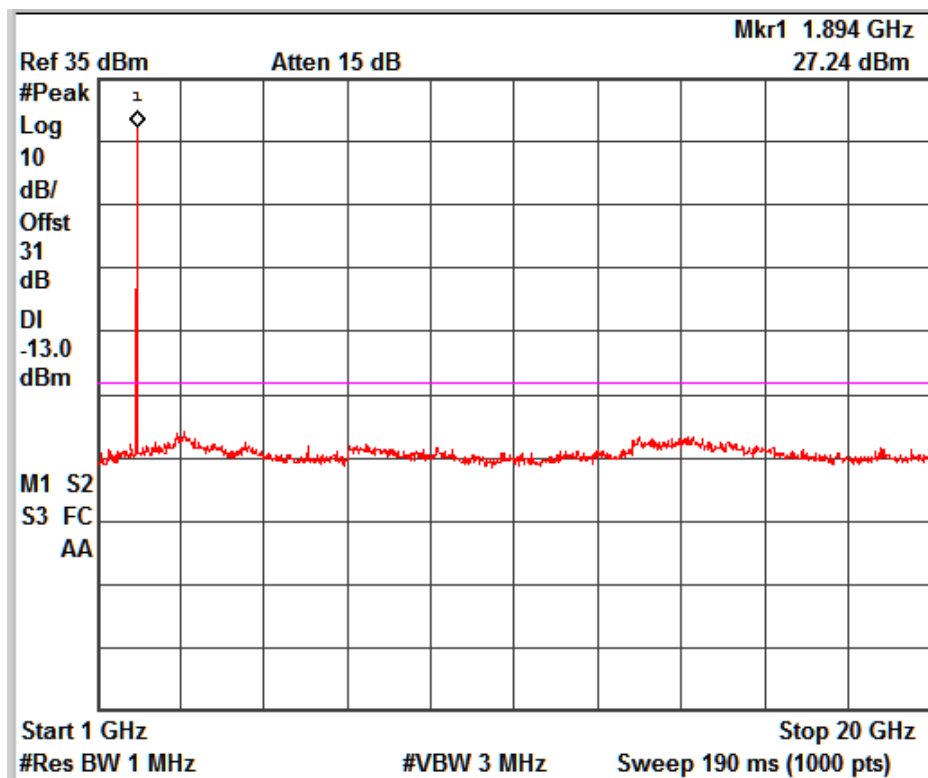
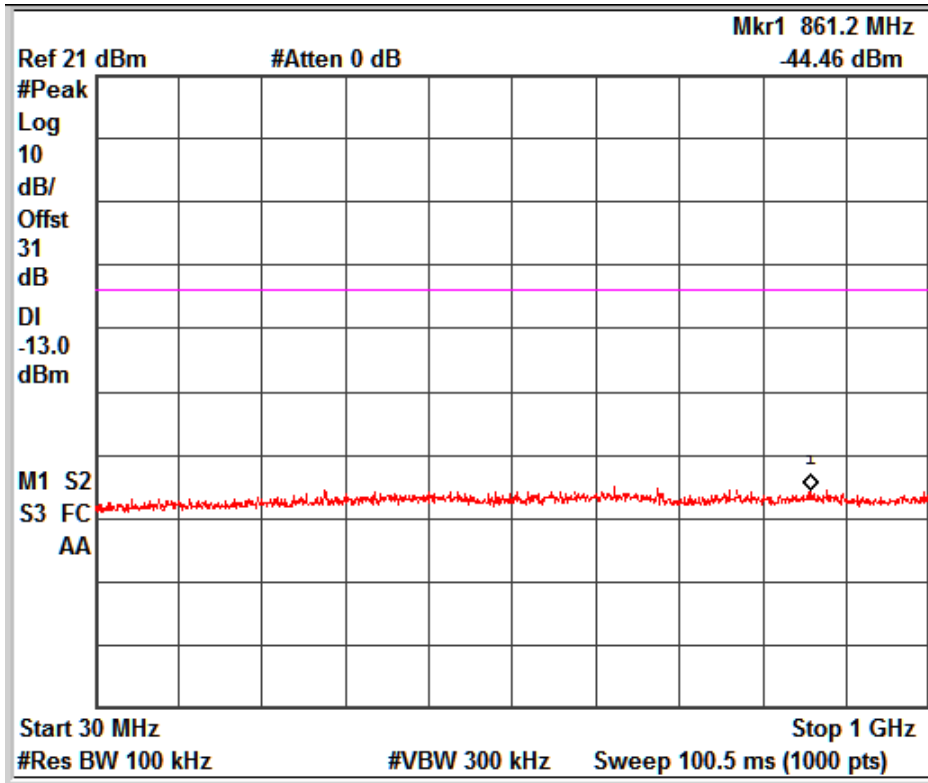

GSM_ GPRS _ Channel No. 661

www.tuv.com

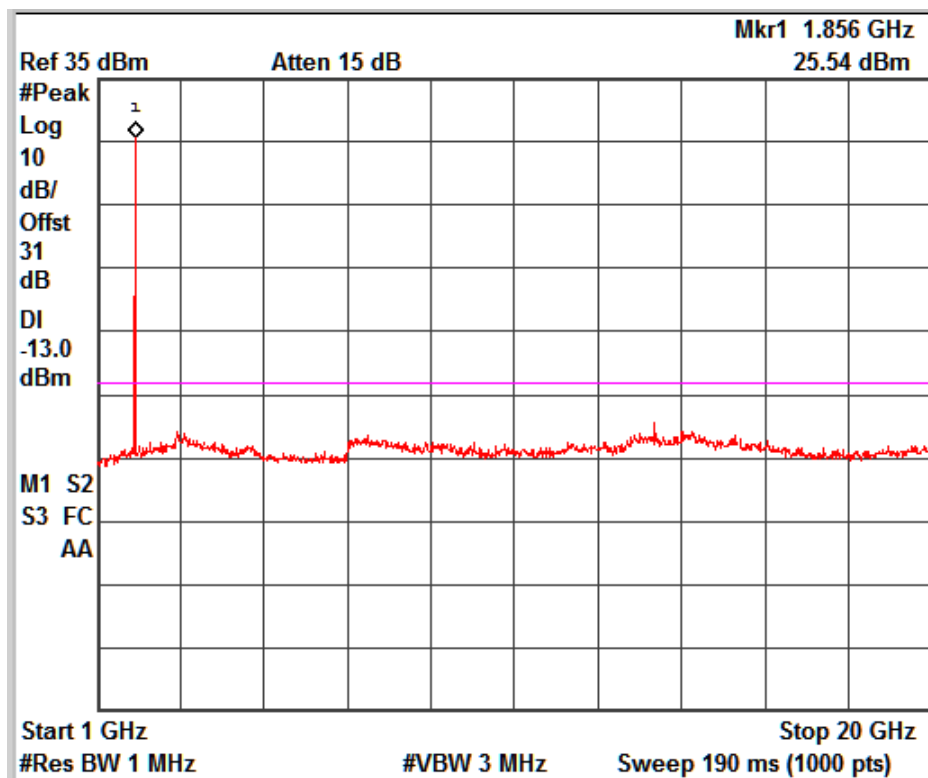
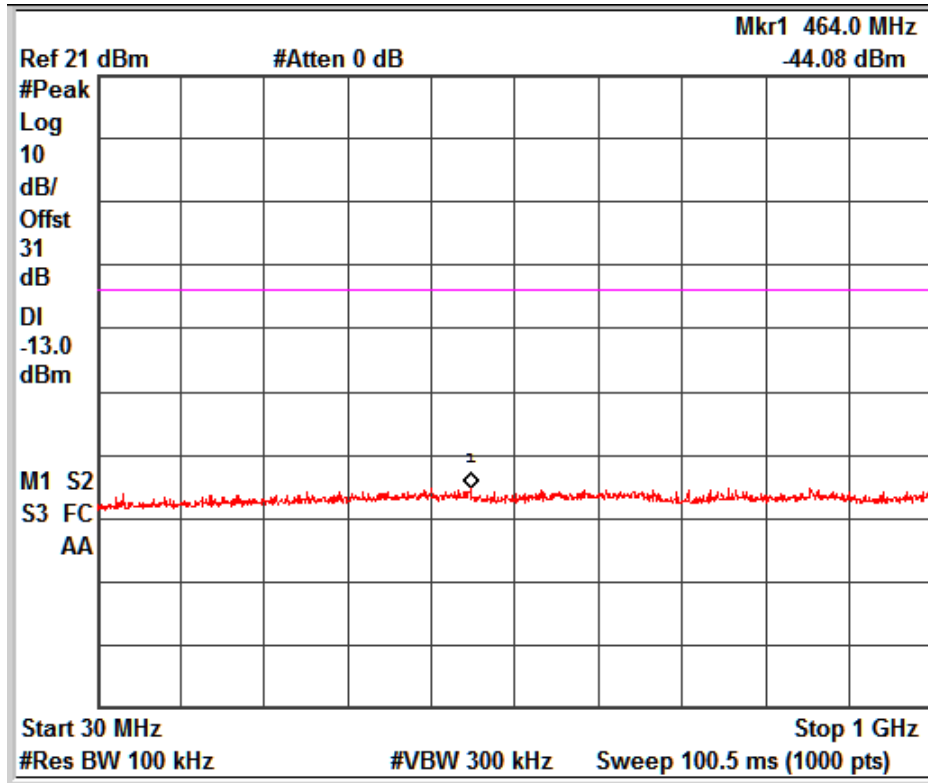

GSM_ GPRS _ Channel No. 810

www.tuv.com

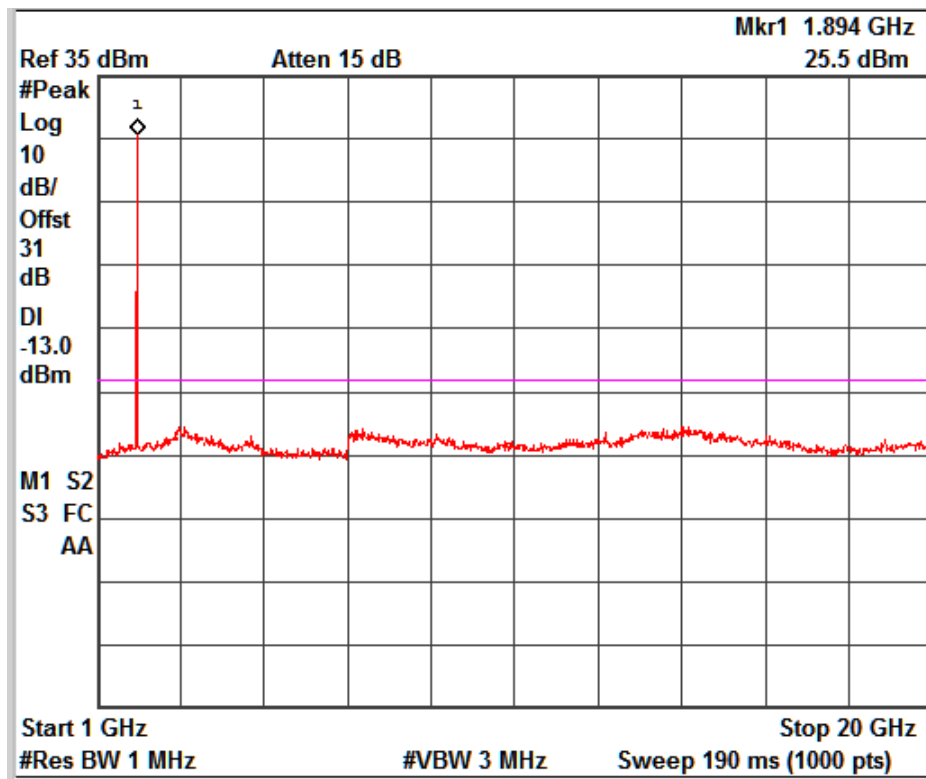
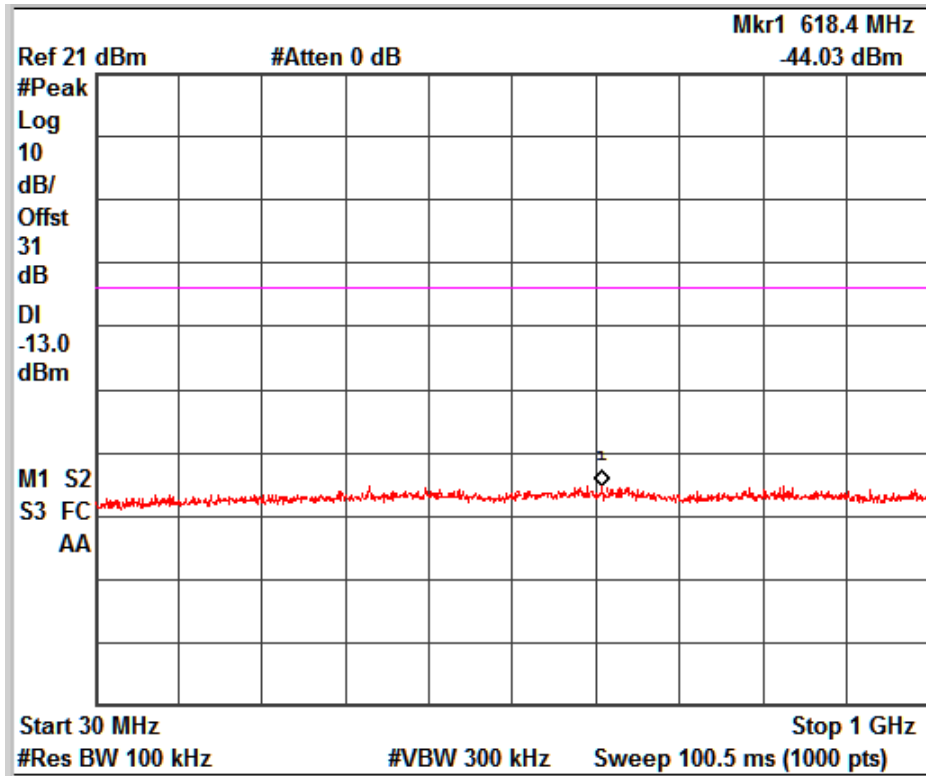

GSM_E-GPRS _ Channel No. 512

www.tuv.com

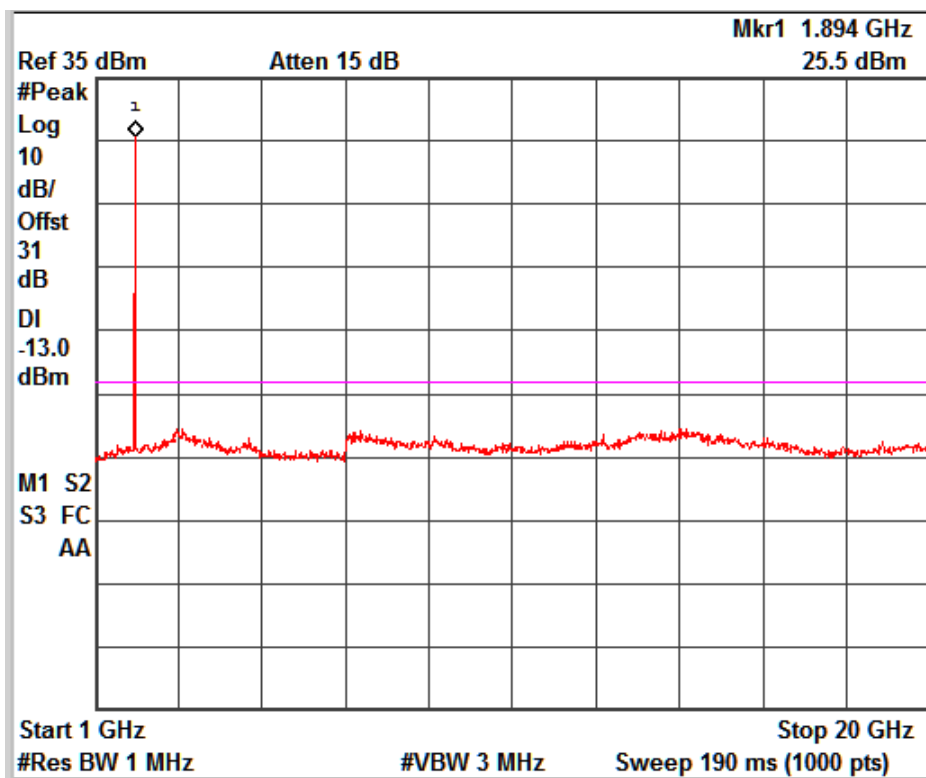
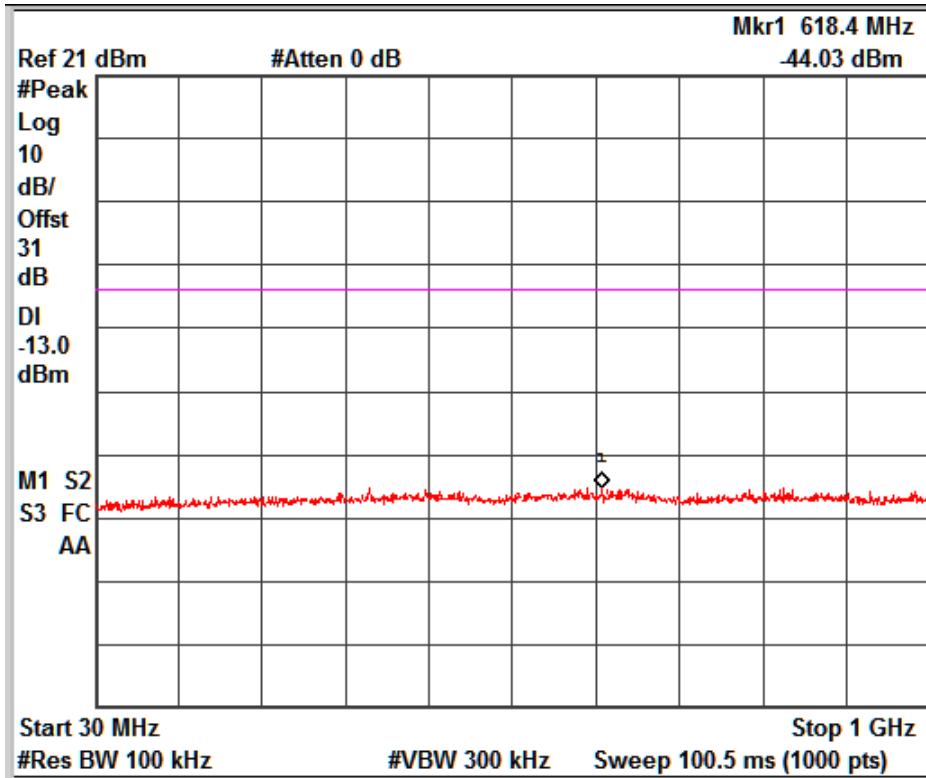

GSM_E-GPRS_Channel No. 661

www.tuv.com

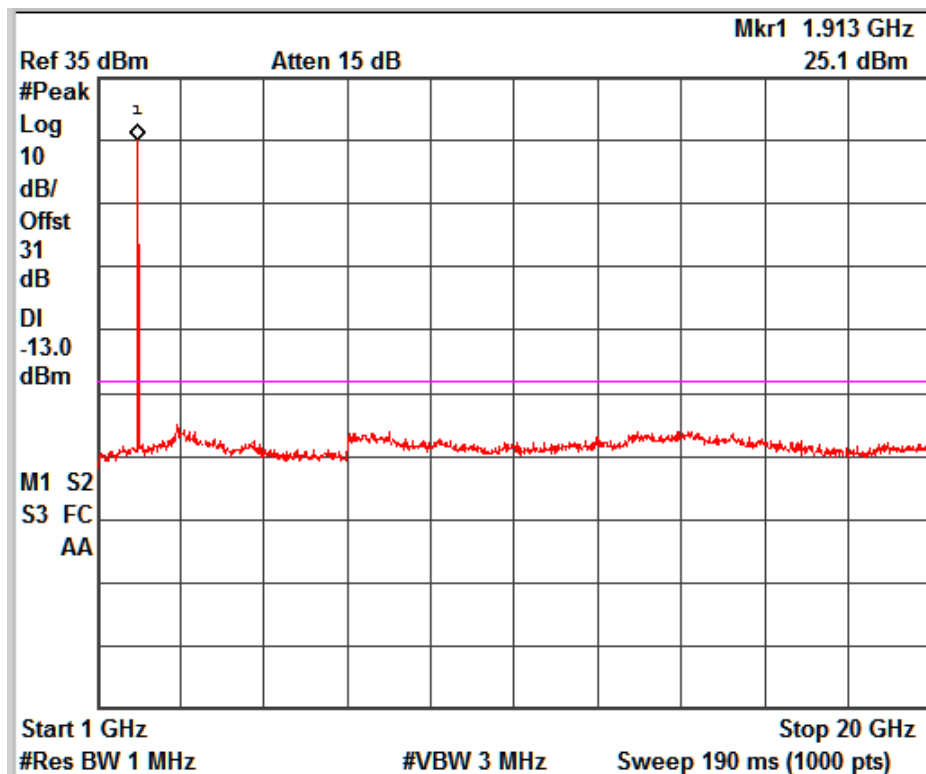
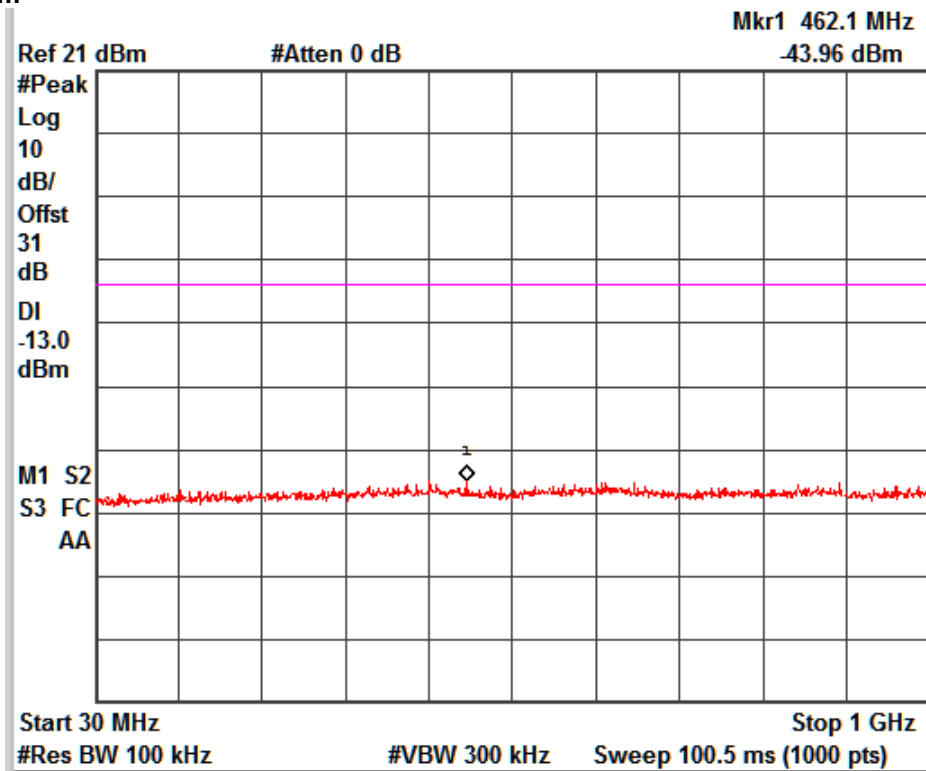

GSM_E-GPRS _ Channel No. 810

www.tuv.com
Frequency Stability
Result

Pass

Specification FCC Part 2.1055(a)(2), 22.355, 24.235 & RSS 132 Issue 3 section 5.3 ,
 RSS 133 Issue 6 section 6.3
 Requirement Frequency Stability shall be sufficient to ensure that the fundamental
 emission stay within the authorised frequency blok.

Test Setup:

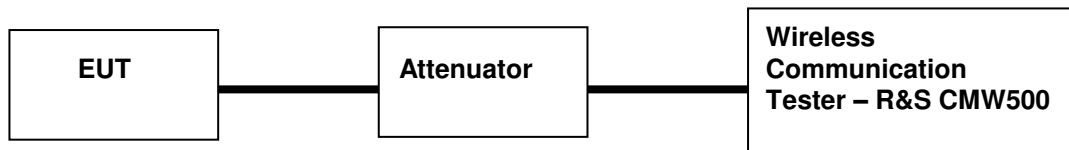

Note: For measurement of Frequency Stability test, section 9.0 in “971168 D01 Power Meas License Digital Systems v02r02” was used.

Frequency Stability on Voltage variation - GSM850					
Mode	Voltage (Vdc)	Nominal Frequency (MHz)	Maximum Frequency Error		Limit ±2.5ppm
			(Hz)	(ppm)	
Voice	3.7	836.6	9.2	0.0110	±2.5
	3.8	836.6	9.2	0.0110	±2.5
	3.9	836.6	9.1	0.0109	±2.5
	4.0	836.6	9.72	0.0116	±2.5
	4.1	836.6	15.8	0.0189	±2.5
	4.2	836.6	10.62	0.0127	±2.5
GPRS	3.7	836.6	14.08	0.0168	±2.5
	3.8	836.6	17.15	0.0205	±2.5
	3.9	836.6	14.53	0.0174	±2.5
	4.0	836.6	12.33	0.0147	±2.5
	4.1	836.6	12.4	0.0148	±2.5
	4.2	836.6	11.91	0.0142	±2.5
EGPRS	3.7	836.6	15.56	0.0186	±2.5
	3.8	836.6	17.08	0.0204	±2.5
	3.9	836.6	19.18	0.0229	±2.5
	4.0	836.6	17.31	0.0207	±2.5
	4.1	836.6	16.01	0.0191	±2.5
	4.2	836.6	15.3	0.0183	±2.5

Frequency Stability on Voltage variation – PCS 1900					
Mode	Voltage (Vdc)	Nominal Frequency (MHz)	Maximum Frequency Error		Limit ±2.5ppm
			(Hz)	(ppm)	
Voice	3.7	1880	18.05	0.0096	±2.5
	3.8	1880	19.66	0.0105	±2.5
	3.9	1880	17.21	0.0092	±2.5
	4.0	1880	21.57	0.0115	±2.5
	4.1	1880	16.18	0.0086	±2.5
	4.2	1880	20.08	0.0107	±2.5
GPRS	3.7	1880	30.38	0.0162	±2.5
	3.8	1880	31.7	0.0169	±2.5
	3.9	1880	32.71	0.0174	±2.5
	4.0	1880	30.74	0.0164	±2.5
	4.1	1880	28.02	0.0149	±2.5
	4.2	1880	26.7	0.0142	±2.5
EGPRS	3.7	1880	33.71	0.0179	±2.5
	3.8	1880	34.58	0.0184	±2.5
	3.9	1880	33.93	0.0180	±2.5
	4.0	1880	34.55	0.0184	±2.5
	4.1	1880	32.16	0.0171	±2.5
	4.2	1880	31.32	0.0167	±2.5

Frequency Stability on Temperature variation – GSM 850								
Mode	Temperature (°C)	Maximum Frequency Error (Hz)			Maximum Frequency Error (ppm)			Limit (ppm)
		Channel 128	Channel 190	Channel 251	Channel 128	Channel 190	Channel 251	
Voice	-30	-16.08	-14.69	-16.4	-0.0195	-0.0176	-0.0193	2.5
	-20	-15.49	-12.14	-11.39	-0.0188	-0.0145	-0.0134	2.5
	-10	-17.89	-10.01	-13.69	-0.0217	-0.0120	-0.0161	2.5
	0	-14.19	-11.51	10.32	-0.0172	-0.0138	0.0122	2.5
	10	-9.83	7.43	9.62	-0.0119	0.0089	0.0113	2.5
	20	7.62	14.79	13.46	0.0092	0.0177	0.0159	2.5
	30	9.34	8.11	9.81	0.0113	0.0097	0.0116	2.5
	40	9.94	8.27	-10.69	0.0121	0.0099	-0.0126	2.5
	50	8.72	7.75	8.81	0.0106	0.0093	0.0104	2.5
GPRS	-30	12.62	10.46	14.14	0.0153	0.0125	0.0167	2.5
	-20	16.51	13.46	12.19	0.0200	0.0161	0.0144	2.5
	-10	19.6	17.56	9.88	0.0238	0.0210	0.0116	2.5
	0	16.41	16.41	14.58	0.0199	0.0196	0.0172	2.5
	10	15.63	16.34	22.79	0.0190	0.0195	0.0268	2.5
	20	13.54	15.43	20.95	0.0164	0.0184	0.0247	2.5
	30	22.34	18.41	19.14	0.0271	0.0220	0.0225	2.5
	40	22.51	17.5	18.24	0.0273	0.0209	0.0215	2.5
	50	22.41	23.18	17.51	0.0272	0.0277	0.0206	2.5
EGPRS	-30	18.98	19.92	19.79	0.0230	0.0238	0.0233	2.5
	-20	19.43	16.42	16.48	0.0236	0.0196	0.0194	2.5
	-10	20.28	17.98	14.11	0.0246	0.0215	0.0166	2.5
	0	16.41	15.22	17.43	0.0199	0.0182	0.0205	2.5
	10	13.17	14.3	19.63	0.0160	0.0171	0.0231	2.5
	20	16.27	18.73	25.76	0.0197	0.0224	0.0303	2.5
	30	19.21	15.16	18.01	0.0233	0.0181	0.0212	2.5
	40	21.95	14.11	18.79	0.0266	0.0169	0.0221	2.5
	50	20.24	19.92	18.08	0.0246	0.0238	0.0213	2.5

Channel 128 -> 824.2 MHz
Channel 190-> 836.6 MHz
Channel 251-> 848.8 MHz

Frequency Stability on Temperature variation – PCS 1900								
Mode	Temperature (°C)	Maximum Frequency Error (Hz)			Maximum Frequency Error (ppm)			Limit (ppm)
		Channel 512	Channel 661	Channel 810	Channel 512	Channel 661	Channel 810	
Voice	-30	25.09	17.34	27.31	0.0136	0.0092	0.0143	2.5
	-20	24.18	19.81	24.66	0.0131	0.0105	0.0129	2.5
	-10	23.15	25.18	22.57	0.0125	0.0134	0.0118	2.5
	0	25.17	24.42	18.45	0.0136	0.0130	0.0097	2.5
	10	29.57	22.54	17.85	0.0160	0.0120	0.0093	2.5
	20	13.24	16.66	14.63	0.0072	0.0089	0.0077	2.5
	30	21.05	18.54	19.82	0.0114	0.0099	0.0104	2.5
	40	9.78	13.2	14.66	0.0053	0.0070	0.0077	2.5
	50	22.02	21.37	23.92	0.0119	0.0114	0.0125	2.5
GPRS	-30	36.57	25.31	27.31	0.0198	0.0135	0.0143	2.5
	-20	32.41	29.62	31.42	0.0175	0.0158	0.0165	2.5
	-10	32.03	38.29	35.48	0.0173	0.0204	0.0186	2.5
	0	33.14	34.41	31.84	0.0179	0.0183	0.0167	2.5
	10	36.13	31.12	28.06	0.0195	0.0166	0.0147	2.5
	20	25.47	28.99	26.22	0.0138	0.0154	0.0137	2.5
	30	34.12	28.24	21.16	0.0184	0.0150	0.0111	2.5
	40	35.35	24.96	20.02	0.0191	0.0133	0.0105	2.5
	50	35.16	36.74	20.7	0.0190	0.0195	0.0108	2.5
EGPRS	-30	40.52	39.19	33.71	0.0219	0.0208	0.0177	2.5
	-20	36.17	38.18	37.16	0.0195	0.0203	0.0195	2.5
	-10	34.35	39.4	40.07	0.0186	0.0210	0.0210	2.5
	0	31.56	37.16	37.41	0.0171	0.0198	0.0196	2.5
	10	28.96	38.81	36.55	0.0157	0.0206	0.0191	2.5
	20	28.06	35.04	33.43	0.0152	0.0186	0.0175	2.5
	30	24.18	27.82	24.5	0.0131	0.0148	0.0128	2.5
	40	22.18	30.83	30.45	0.0120	0.0164	0.0159	2.5
	50	33.1	38.32	21.24	0.0179	0.0204	0.0111	2.5

Channel 512 -> 1850.2 MHz
Channel 661 -> 1880 MHz
Channel 810 -> 1909.8 MHz

www.tuv.com

RF Power (ERP/EIRP) – Radiated Mode Result

Pass

Specification FCC Part 2.1046, 22.913(a) (2) 24.232(c) & RSS 132 Issue 3 section 5.4, SRSP-503
 RSS 133 Issue 6 section 4.1/6.4, SRSP-510.5.1.2

Measurement Bandwidth (RBW) 100KHz/1MHz

Detector Function Peak

Requirement \leq GSM850 : 7 Watts (38.4dBm) for FCC & 11.5 Watts (40.60dBm) for IC
 GSM1900 : 2Watts (33dBm)

Note: For measurement of RF Output Power, Test performed as per ANSI/TIA-603-D-2010 Clause 2.2.17.

Test Results

Mode	Carrier Channel			Polarization	RF Power (dBm)	Limit (dBm)
	Channel	Channel No.	Channel Frequency (MHz)			
GSM 850	Low	128	824.2	Vertical	24.69	38.4
				Horizontal	22.39	38.4
	Mid	190	836.6	Vertical	24.59	38.4
				Horizontal	22.25	38.4
	High	251	848.8	Vertical	26.00	38.4
				Horizontal	21.72	38.4
GPRS 850	Low	128	824.2	Vertical	17.67	38.4
				Horizontal	23.50	38.4
	Mid	190	836.6	Vertical	17.53	38.4
				Horizontal	22.46	38.4
	High	251	848.8	Vertical	17.33	38.4
				Horizontal	20.90	38.4
E-GPRS 850	Low	128	824.2	Vertical	13.08	38.4
				Horizontal	20.62	38.4
	Mid	190	836.6	Vertical	13.86	38.4
				Horizontal	19.49	38.4
	High	251	848.8	Vertical	13.54	38.4
				Horizontal	17.48	38.4
PCS 1900	Low	512	1850.2	Vertical	24.39	33
				Horizontal	27.45	33
	Mid	661	1880	Vertical	24.16	33
				Horizontal	27.22	33
	High	810	1909.8	Vertical	24.62	33
				Horizontal	27.24	33
GPRS 1900	Low	512	1850.2	Vertical	25.16	33
				Horizontal	24.67	33
	Mid	661	1880	Vertical	24.14	33
				Horizontal	24.67	33
	High	810	1909.8	Vertical	26.53	33
				Horizontal	24.89	33
E-GPRS 1900	Low	512	1850.2	Vertical	25.83	33
				Horizontal	24.27	33
	Mid	661	1880	Vertical	24.19	33
				Horizontal	24.89	33
	High	810	1909.8	Vertical	26.51	33
				Horizontal	24.94	33

www.tuv.com

**Field Strength of Spurious Radiation
Result**

Pass

Specification	FCC Part 2.1053(a), 22.917(a)(b), 24.238(a)(b) & RSS 132 Issue 3 section 5.5, RSS 133 Issue 6 section 6.5
Measurement Bandwidth (RBW)	100KHz/1MHz
Detector Function	Peak
Requirement	Shall be attenuated below the transmitter power (P in watt) by at least $43+10 \log(P)$ dBm,

Note: For measurement of RF Output Power, Test performed as per ANSI/TIA-603-D-2010 Clause 2.2.12.

Test Results

Test Results below 1GHz

Worst case test results are reported for 1GB RAM Variant.

Polarization	Frequency (MHz)	Emission (dBm)	Limit (dBm)	Margin (dB)
Vertical	98.38	-57.05	-13	-44.05
	210.71	-58.68	-13	-45.68
Horizontal	97.6	-58.72	-13	-45.72
	213.03	-55.78	-13	-42.78

Worst case test results are reported for 2GB RAM Variant.

Polarization	Frequency (MHz)	Emission (dBm)	Limit (dBm)	Margin (dB)
Vertical	100.91	-56.84	-13	-43.84
	211.64	-57.28	-13	-44.28
Horizontal	99.27	-55.29	-13	-42.29
	210.15	-56.29	-13	-43.29

Test Result above 1GHz

Mode	Channel	Channel Frequency (MHz)	Polarization	Frequency (MHz)	Emission (dBm)	Limit (dBm)	Margin (dB)
GSM 850_Call	Low	824.2	Vertical	1648.7	-52.68	-13	-39.68
			Horizontal	1648.5	-48.97	-13	-35.97
			Vertical	2472.7	-39.29	-13	-26.29
			Horizontal	2472.7	-42.3	-13	-29.3
			Vertical	3316	-52.84	-13	-39.84
			Horizontal	3283.5	-52.51	-13	-39.51
	Mid	836.6	Vertical	1673.4	-53.06	-13	-40.06
			Horizontal	1673.1	-50.14	-13	-37.14
			Vertical	2509.7	-37.92	-13	-24.92
			Horizontal	2509.6	-42.2	-13	-29.2
	High	848.8	Vertical	1697.7	-52.67	-13	-39.67
			Horizontal	1697.9	-50.87	-13	-37.87
Vertical			2546.3	-39.21	-13	-26.21	
Horizontal			2546.3	-43.37	-13	-30.37	
PCS 1900	Low	1850.2	Vertical	3700.4	-42.43	-13	-29.43
			Horizontal	3700.5	-41.14	-13	-28.14
			Vertical	5550.5	-37.44	-13	-24.44
			Horizontal	5550.5	-29.28	-13	-16.28
	Mid	1880	Vertical	3759.9	-41.64	-13	-28.64
			Horizontal	3760	-41.4	-13	-28.4
			Vertical	5640	-32	-13	-19
			Horizontal	5639.9	-29.97	-13	-16.97
	High	1909.8	Vertical	7520.5	-35.39	-13	-22.39
			Horizontal	7514	-34.98	-13	-21.98
			Vertical	3819.7	-41.83	-13	-28.83
			Horizontal	3819.5	-40.87	-13	-27.87
GPRS 850	Low	824.2	Vertical	5729.2	-33.71	-13	-20.71
			Horizontal	5729.5	-31.6	-13	-18.6
			Vertical	1648.2	-52.59	-13	-39.59
			Horizontal	1648.5	-51.28	-13	-38.28
			Vertical	2472.7	-40.9	-13	-27.9
			Horizontal	2472.6	-42.64	-13	-29.64
	Mid	836.6	Vertical	3315.3	-52.17	-13	-39.17
			Horizontal	3299.8	-52.36	-13	-39.36
	Mid	836.6	Vertical	1673.1	-51.84	-13	-38.84
			Horizontal	1673.3	-51.37	-13	-38.37
			Vertical	2509.9	-39.92	-13	-26.92
			Horizontal	2509.6	-42.02	-13	-29.02
			Vertical	3346.4	-51.84	-13	-38.84

www.tuv.com

	High	848.8	Vertical	1697.8	-51	-13	-38
			Horizontal	1697.5	-50.16	-13	-37.16
			Vertical	2546.4	-40.16	-13	-27.16
			Horizontal	2546.2	-42.55	-13	-29.55
GPRS 1900	Low	1850.2	Vertical	3700.6	-42.94	-13	-29.94
			Horizontal	3700.4	-40.66	-13	-27.66
			Vertical	5550.9	-31.27	-13	-18.27
			Horizontal	5550.6	-30.33	-13	-17.33
	Mid	1880	Vertical	3760.3	-41.92	-13	-28.92
			Horizontal	3759.9	-40.6	-13	-27.6
			Vertical	5640.3	-31.2	-13	-18.2
			Horizontal	5639.7	-30.54	-13	-17.54
	High	1909.8	Vertical	7505	-35.37	-13	-22.37
			Horizontal	7527.9	-35.8	-13	-22.8
			Vertical	3819.7	-41.88	-13	-28.88
			Horizontal	3778.3	-47.55	-13	-34.55
EGPRS 850	Low	824.2	Vertical	5729.7	-34.48	-13	-21.48
			Horizontal	5729.3	-32.56	-13	-19.56
			Vertical	1650.1	-55.85	-13	-42.85
			Horizontal	1652.1	-56.07	-13	-43.07
	Mid	836.6	Vertical	2472.6	-47.29	-13	-34.29
			Horizontal	2472.6	-48.63	-13	-35.63
			Vertical	1673.1	-55.66	-13	-42.66
			Horizontal	1673	-55.85	-13	-42.85
High	848.8	Vertical	2509.9	-44.75	-13	-31.75	
		Horizontal	2509.9	-46.75	-13	-33.75	
		Vertical	1697.4	-56.44	-13	-43.44	
		Horizontal	1697.6	-56.48	-13	-43.48	
EGPRS 1900	Mid	1880	Vertical	2546.4	-44.6	-13	-31.6
			Horizontal	2546.4	-46.96	-13	-33.96
			Vertical	3760	-45.36	-13	-32.36
			Horizontal	3760	-42.44	-13	-29.44
			Vertical	5640.3	-37.69	-13	-24.69
			Horizontal	5640.2	-36.24	-13	-23.24
			Vertical	7524.1	-36.12	-13	-23.12
			Horizontal	7525.6	-37.06	-13	-24.06

END OF TEST REPORT