



# SAR TEST REPORT

**REPORT NO.:** SA990819C03B

**MODEL NO.:** CC61

**FCC ID:** YY3-017LRBT

**RECEIVED:** Aug. 19, 2010

**TESTED:** Sep. 07, 2010 ~ Feb. 26, 2011

**ISSUED:** Oct. 27, 2011

**APPLICANT:** HANDHELD GROUP AB

**ADDRESS:** Kinnegatan 17 A,S-531 33 Lidkoping,Sweden

**ISSUED BY:** Bureau Veritas Consumer Products Services (H.K.)  
Ltd., Taoyuan Branch

**LAB ADDRESS:** No. 47, 14th Ling, Chia Pau Vil., Lin Kou Dist., New  
Taipei City, Taiwan ( R.O.C )

**TEST LOCATION:** No. 19, Hwa Ya 2nd Rd, Wen Hwa Tsuen, Kwei  
Shan Hsiang, Taoyuan Hsien 333, Taiwan, R.O.C.

This test report consists of 41 pages in total except Appendix. It may be duplicated completely for legal use with the approval of the applicant. It should not be reproduced except in full, without the written approval of our laboratory. The client should not use it to claim product certification, approval or endorsement by TAF or any government agency. The test results in the report only apply to the tested sample.





## TABLE OF CONTENTS

RELEASE CONTROL RECORD.....	3
1. CERTIFICATION .....	4
2. GENERAL INFORMATION .....	5
2.1 GENERAL DESCRIPTION OF EUT.....	5
2.2 SAR MEASUREMENT CONDITIONS FOR 3G DEVICE.....	7
2.3 CONDUCTED POWER TABLE.....	9
2.4 GENERAL DESCRIPTION OF APPLIED STANDARDS.....	13
2.5 GENERAL INFORMATION OF THE SAR SYSTEM .....	14
2.6 TEST EQUIPMENT .....	18
2.7 GENERAL DESCRIPTION OF THE SPATIAL PEAK SAR EVALUATION .....	19
3. DESCRIPTION OF SUPPORT UNITS.....	22
4. DESCRIPTION OF ANTENNA LOCATION.....	23
5. RECIPES FOR TISSUE SIMULATING LIQUIDS .....	24
5. SYSTEM VALIDATION.....	29
5.1 TEST PROCEDURE .....	29
5.2 VALIDATION RESULTS .....	31
5.3 SYSTEM VALIDATION UNCERTAINTIES .....	32
6. TEST RESULTS .....	33
6.1 TEST PROCEDURES.....	33
6.2 DESCRIPTION OF TEST CONDITION.....	34
6.3 MEASURED SAR RESULT .....	35
6.4 POWER DRIFT TABLE .....	37
6.5 NO SIMULTANEOUS SAR JUSTIFICATION .....	38
6.6 SAR LIMITS .....	40
7. INFORMATION ON THE TESTING LABORATORIES.....	41
APPENDIX A: TEST CONFIGURATIONS AND TEST DATA	
APPENDIX B: ADT SAR MEASUREMENT SYSTEM	
APPENDIX C: PHOTOGRAPHS OF SYSTEM VALIDATION	
APPENDIX D: SYSTEM CERTIFICATE & CALIBRATION	



## RELEASE CONTROL RECORD

ISSUE NO.	REASON FOR CHANGE	DATE ISSUED
Original release	N/A	Oct. 27, 2011



## 1. CERTIFICATION

**PRODUCT:** 7 inch Handheld Tablet PC

**MODEL:** CC61

**BRAND:** Handheld

**APPLICANT:** Handheld Group AB

**TESTED:** Sep. 07, 2010 ~ Feb. 26, 2011

**TEST SAMPLE:** ENGINEERING SAMPLE

**STANDARDS: FCC Part 2 (Section 2.1093)**

**FCC OET Bulletin 65, Supplement C (01-01)**

**RSS-102 Issue 4 (2010-03)**

The above equipment (model: CC61) has been tested by **Bureau Veritas Consumer Products Services (H.K.) Ltd., Taoyuan Branch**, and found compliance with the requirement of the above standards. The test record, data evaluation & Equipment Under Test (EUT) configurations represented herein are true and accurate accounts of the measurements of the sample's EMC characteristics under the conditions specified in this report.

PREPARED BY : Andrea Hsia, DATE : Oct. 27, 2011  
Andrea Hsia / Specialist

APPROVED BY : Gary Chang, DATE : Oct. 27, 2011  
Gary Chang / Technical Manager

## 2. GENERAL INFORMATION

### 2.1 GENERAL DESCRIPTION OF EUT

<b>EUT</b>	7 inch Handheld Tablet PC	
<b>MODEL NO.</b>	CC61	
<b>FCC ID</b>	YY3-017LRBT	
<b>NOMINAL VOLTAGE</b>	12Vdc (adapter) 7.4Vdc (Battery)	
<b>MODULATION TYPE</b>	<b>WLAN</b>	CCK, DQPSK, DBPSK for DSSS 64QAM, 16QAM, QPSK, BPSK for OFDM
	<b>GPRS, E-GPRS</b>	GMSK, 8PSK
	<b>CDMA</b>	QPSK, OQPSK, HPSK
	<b>WCDMA</b>	BPSK
<b>FREQUENCY RANGE</b>	<b>WLAN</b>	2412 ~ 2462MHz
	<b>GPRS, E-GPRS</b>	824.2MHz ~ 848.8MHz 1850.2MHz ~ 1909.8MHz
	<b>CDMA</b>	824.7MHz ~ 848.31MHz 1851.25MHz ~ 1908.75MHz
	<b>WCDMA</b>	826.4MHz ~ 846.6MHz 1852.4MHz ~ 1907.6MHz
<b>MAXIMUM SAR (1g)</b>	<b>850Band</b>	0.157W/kg
	<b>1900Band</b>	0.306W/kg
	<b>WLAN</b>	0.529W/kg
<b>ANTENNA TYPE</b>	Printed PCB antenna with 3.1dBi gain (for WLAN) Printed PCB antenna with -4.688dBi gain (for 850Band) Printed PCB antenna with 2.2288dBi gain (for 1900Band)	
<b>I/O PORTS</b>	Refer to user's manual	
<b>DATA CABLE</b>	NA	
<b>ACCESSORY DEVICES</b>	Adapter, Battery	

#### NOTE:

1. This report is issued as a duplicate report of BV ADT report no.: SA990819C03. The differences compared with original report are listing as below.

\*\*Changed model, FCC ID.

\*\*Removed Bluetooth module.

2. The EUT was powered by the following adapter & battery:

<b>ADAPTER</b>	
<b>BRAND:</b>	EDAC
<b>MODEL:</b>	EA1050C-120
<b>INPUT:</b>	100-240Vac, 50/60Hz, 1.8A
<b>OUTPUT:</b>	12Vdc, 4.16A
<b>POWER LINE:</b>	AC: 1.8m non-shielded cable with one core DC: 1.8m shielded cable without core

<b>BATTERY</b>	
<b>RATING:</b>	7.4Vdc 2S1P, 2600mAh



3. The EUT provides one completed transmitter and one receiver.

<b>MODULATION MODE</b>	<b>TX FUNCTION</b>
<b>802.11b</b>	1TX
<b>802.11g</b>	1TX
<b>802.11n (20MHz)</b>	1TX
<b>802.11n (40MHz)</b>	1TX

4. The EUT has no voice function.  
5. Hardware version: I983S  
6. Software version: V3.0.1.6  
7. The above EUT information was declared by manufacturer and for more detailed features description, please refer to the manufacturer's specifications or User's Manual.



## 2.2 SAR MEASUREMENT CONDITIONS FOR 3G DEVICE

The following procedures were followed according to FCC “SAR Measurement Procedures 3G Devices”, Oct. 2007.

### ➤ Output Power Verification

#### 1x EV-Do data device

Maximum output power is verified on the High, Middle and Low channels according to procedures in section 3.1.2.3.4 of 3GPP2 C.S0033-0/TIA-866 for Rev. 0 and section 4.3.4 of 3GPP2 C.S0033-A for Rev. A. For Rev. A, maximum output power for both Subtype 0/1 and Subtype 2 Physical Layer configurations should be measured. The device operating configurations under TAP/ETAP should be documented in the test report; including power control, code channel and RF channel output power levels. The measurement results should be tabulated in the SAR report with any measurement difficulties and equipment limitations clearly identified.

#### Release 5 HSDPA Data Devices

Maximum output power is verified on the High, Middle and Low channels according to the Release 5 procedures described in section 5.2 of 3GPP TS 34.121, using an FRC with H-set 1 and a 12.2 kbps RMC with TPC (transmit power control) set to all “1’s”. When HSDPA is active output power is measured according requirements for HS-DPCCH Sub-test 1 - 4.28 Results for all applicable physical channel configurations (DPCCH, DPDCH<sub>n</sub> and spreading codes, HS-DPCCH etc.), with and without HSDPA active, should be tabulated in the SAR report. All configurations that are not supported by the DUT or cannot be measured due to technical or equipment limitations should be clearly identified in the SAR report.

#### Release 6 HSPA Data Devices

Maximum output power is verified on the High, Middle and Low channels according to Release 6 procedures in section 5.2 of 3GPP TS 34.121, using the appropriate RMC, FRC and E-DCH configurations. When E-DCH is not active, TPC (transmit power control) is set to all “1’s”; otherwise, inner loop power control with power control algorithm 2 is required to maintain E-TFCI requirements. When HSPA is active output power for the applicable HSPA modes should be measured for E-DCH Sub-test 1 - 5.38 Results for all applicable physical channel configurations (DPCCH, DPDCH and spreading codes, HS-DPCCH, E-DPCCH, E-DPDCH<sub>k</sub>) should be tabulated in the SAR report. All configurations that are not supported by the DUT or cannot be measured due to technical or equipment limitations should be clearly identified



## ➤ **Body SAR Measurements**

### **1x EV-Do data device**

SAR is measured using FTAP/RTAP and FETAP/RETAP respectively for Rev. 0 and Rev. A devices. The AT is tested with a Reverse Data Channel rate of 153.6 kbps in Subtype 0/1 Physical Layer configurations; and a Reverse Data Channel payload size of 4096 bits and Termination Target of 16 slots in Subtype 2 Physical Layer configurations. Both FTAP and FETAP are configured with a Forward Traffic Channel data rate corresponding to the 2-slot version of 307.2 kbps with the ACK Channel transmitting in all slots. AT power control should be in “All Bits Up” conditions for TAP/ETAP.

Body SAR is measured using Subtype 0/1 Physical Layer configurations for Rev. 0. SAR for Subtype 2 Physical layer configurations is not required for Rev. A when the maximum average output of each RF channels is less than that measured in Subtype 0/1 Physical layer configurations. Otherwise, SAR is measured on the maximum output channel for Rev. A using the exposure configuration that results in the highest SAR for that RF channels in Rev. 0.<sup>17</sup> Head SAR is required for Ev-Do devices that support operations next to the ear; for example, with VOIP, using Subtype 2 Physical Layer configurations according to the required handset configurations

For Ev-Do devices that also support 1x RTT voice and/or data operations, SAR is not required for 1x RTT when the maximum average output of each channel is less than  $\frac{1}{4}$  dB higher than that measured in Subtype 0/1 Physical Layer configurations for Rev. 0. Otherwise, the ‘Body SAR Measurements’ procedures in the ‘CDMA 2000 1x Handsets’ section should be applied.

### **Release 5 HSDPA Data Devices /Release 6 HSPA Data Devices**

SAR for body exposure configurations in voice and data modes is measured using a 12.2 kbps RMC with TPC bits configured to all “1’s”. SAR for other spreading codes and multiple DPDCH<sub>n</sub>, when supported by the DUT, are not required when the maximum average output of each RF channel, for each spreading code and DPDCH<sub>n</sub> configuration, are less than  $\frac{1}{4}$  dB higher than those measured in 12.2 kbps RMC. Otherwise, SAR is measured on the maximum output channel with an applicable RMC configuration for the corresponding spreading code or DPDCH<sub>n</sub> using the exposure configuration that results in the highest SAR with 12.2 kbps RMC.<sup>23</sup> When more than 2 DPDCH<sub>n</sub> are supported by the DUT, it may be necessary to configure additional DPDCH<sub>n</sub> for a DUT using FTM (Factory Test Mode) or other chipset based test approaches with parameters similar to those used in 384 kbps and 768 kbps RMC

Body SAR for HSDPA is measured using an FRC with H-Set 1 in Sub-test 1 and a 12.2 kbps RMC configured in Test Loop Mode 1, using the highest body SAR configuration in 12.2 kbps RMC without HSDPA

Body SAR is also measured for HSPA when the maximum average output of each RF channel with HSPA active is at least  $\frac{1}{4}$  dB higher than that measured without HSPA using 12.2 kbps RMC or the maximum SAR for 12.2 kbps RMC is above 75% of the SAR limit. Body SAR for HSPA is measured with E-DCH Sub-test 5, using H-Set 1 and QPSK for FRC and a 12.2 kbps RMC configured in Test Loop Mode 1 with power control algorithm 2, according to the highest body SAR configuration in 12.2 kbps RMC without HSPA.



## 2.3 CONDUCTED POWER TABLE

### CDMA 850

#### 1 x RTT

CDMA 2000 CONDUCTED POWER											
CHAN.	FREQ. (MHz)	CDMA 2000	RAW VALUE (dBm)				CORR. FACTOR (dB)	OUTPUT POWER (dBm)			
		RC	SO2	SO55	TDSO SO32 (FCH)	TDSO SO32 (FCH+S CH)		SO2	SO55	TDSO SO32 (FCH)	TDSO SO32 (FCH+S CH)
1013	824.70	RC1	-0.91	-0.82	-	-	23.90	22.99	23.08	-	-
		RC3	-0.75	-0.65	-0.67	-0.69	23.90	23.15	23.25	23.23	23.21
384	836.52	RC1	-0.46	-0.35	-	-	23.90	23.44	23.55	-	-
		RC3	-0.40	-0.32	-0.39	-0.41	23.90	23.50	23.58	23.51	23.49
777	848.31	RC1	-0.80	-0.76	-	-	23.90	23.10	23.14	-	-
		RC3	-0.78	-0.62	-0.68	-0.64	23.90	23.12	23.28	23.22	23.26

#### EV-DO Rev. 0

FTAP rate	RTAP Rate	Channel	f(MHz)	Conducted power (dBm)
307.2k	153.6 kbps	1013	824.7	23.21
		384	836.52	23.44
		7	848.31	23.32

#### EV-DO Rev. A

FETAP-Traffic Format	RETAP-Data Payload Size	Channel	f(MHz)	Conducted power (dBm)
307.2k, QPSK/ACK channel is transmitted at all the slots	4096	1013	824.7	23.02
		384	836.52	23.38
		7	848.31	23.24

1x RTT (TDSO / SO32) will be tested, since 1x RTT power is higher than EV-DO Rev.0  
 EV-DO Rev.0 will be tested and EV-DO Rev. A will not. Since the maximum average output power of EV-DO Rev. A is less than EVDO Rev. 0

## CDMA 1900

### 1 x RTT

CHAN.	FREQ. (MHz)	CDMA 2000	RAW VALUE (dBm)				CORR. FACTOR (dB)	OUTPUT POWER (dBm)			
			RC	SO2	SO55	TDSO SO32 (FCH)		TDSO SO32 (FCH+S CH)	SO2	SO55	TDSO SO32 (FCH)
25	1851.25	RC1	-0.22	-0.12	-	-	24.10	23.88	23.98	-	-
		RC3	-0.09	-0.01	-0.11	-0.23	24.10	24.01	24.09	23.99	23.87
600	1880.00	RC1	0.15	0.17	-	-	24.10	24.25	24.27	-	-
		RC3	0.24	0.31	0.29	0.21	24.10	24.34	24.41	24.39	24.31
1175	1908.75	RC1	-0.65	-0.63	-	-	24.10	23.45	23.47	-	-
		RC3	-0.51	-0.41	-0.46	-0.59	24.10	23.59	23.69	23.64	23.51

### EV-DO Rev. 0

FTAP rate	RTAP Rate	Channel	f(MHz)	Conducted power (dBm)
307.2k	153.6 kbps	25	1851.25	23.80
		600	1880.00	24.20
		1175	1908.75	23.40

### EV-DO Rev. A

FETAP-Traffic Format	RETAP-Data Payload Size	Channel	f(MHz)	Conducted power (dBm)
307.2k, QPSK/ACK channel is transmitted at all the slots	4096	25	1851.25	23.50
		600	1880.00	23.70
		1175	1908.75	22.90

1x RTT (TDSO / SO32) will be tested, since 1x RTT power is higher than EV-DO Rev.0  
 EV-DO Rev.0 will be tested and EV-DO Rev. A will not. Since the maximum average output power of EV-DO Rev. A is less than EVDO Rev. 0

## WCDMA 850 / 1900 MHz

### WCDMA

Mode	Channel	Frequency (MHz)	Conducted power (dBm)
WCDMA 850	4132	826.4	24.34
	4182	836.4	24.39
	4233	846.6	24.16
WCDMA1900	9262	1852.4	24.12
	9400	1880	24.33
	9538	1907.6	24.06

### HSDPA

Mode	Channel	Frequency (MHz)	Conducted power (dBm)			
			H-set 1			
			SUBTEST 1	SUBTEST 2	SUBTEST 3	SUBTEST 4
HSDPA 850	4132	826.4	23.97	23.26	23.76	23.71
	4182	836.4	24.04	23.75	23.34	23.55
	4233	846.6	23.87	23.05	23.80	23.51
HSDPA 1900	9262	1852.4	23.94	23.49	23.30	23.32
	9400	1880	24.20	24.05	24.07	24.01
	9538	1907.6	23.76	23.23	23.12	23.11

### HSUPA

Mode	Channel	Frequency (MHz)	Conducted power (dBm)				
			H-set 1				
			SUBTEST 1	SUBTEST 2	SUBTEST 3	SUBTEST 4	SUBTEST 5
HSUPA 850	4132	826.4	23.02	22.60	22.32	23.98	23.38
	4182	836.4	23.48	22.90	22.85	23.80	23.32
	4233	846.6	24.15	22.75	23.32	23.11	23.24
HSUPA 1900	9262	1852.4	23.19	21.83	21.43	22.43	22.81
	9400	1880	22.73	22.32	22.55	23.05	23.04
	9538	1907.6	22.93	21.57	21.80	23.22	21.45

Conducted power of HSDPA and HSUPA mode is not higher 1/4dB than that measured without HSPA using 12.2kbps RMC. Max SAR value of each mode of P 35/36 is less than 0.75 % of SAR limit. Therefore, only WCDMA-RMC will be tested, HSDPA and HSUPA are not required.

### GPRS / EGPRS 850 MHz

Conducted power table (dBm)					
CHANNEL	Frequency (MHz)	GPRS		EGPRS	
		Time slot 1	Time slot 2	Time slot 1	Time slot 2
128	824.2	32.1	31.8	27.6	27.5
190	836.6	32.1	31.9	27.7	27.6
251	848.8	32.1	31.8	27.6	27.6

### GPRS / EGPRS 1900 MHz

Conducted power table (dBm)					
CHANNEL	Frequency (MHz)	GPRS		EGPRS	
		Time slot 1	Time slot 2	Time slot 1	Time slot 2
512	1850.2	29.1	29	25.8	25.8
661	1880	28.9	28.8	25.6	25.6
810	1909.8	28.8	28.7	25.5	25.5

### Wi-Fi 2.4GHz

Conducted power table (dBm)						
CHANNEL	802.11b		802.11g		802.11n (20MHz)	
	PEAK	AVG	PEAK	AVG	PEAK	AVG
CH1: 2412MHz	17.7	15.0	23.5	14.2	23.0	13.3
CH6: 2437MHz	18.3	15.5	23.4	14.1	22.7	13.0
CH11: 2462MHz	18.1	15.3	23.4	13.9	22.0	13.0

Conducted power table (dBm)		
CHANNEL	802.11n (40MHz)	
	PEAK	AVG
CH1: 2422MHz	20.0	11.0
CH4: 2437MHz	20.2	11.2
CH7: 2452MHz	20.2	11.2

SAR is not required for 802.11g / 11n 20MHz / 11 n 40MHz channels when the maximum average output power is less than ¼ dB higher than that measured on the corresponding 802.11b channels



## **2.4 GENERAL DESCRIPTION OF APPLIED STANDARDS**

According to the specifications of the manufacturer, this product must comply with the requirements of the following standards:

**FCC Part 2 (2.1093)**

**FCC OET Bulletin 65, Supplement C (01- 01)**

**RSS-102 Issue 4 (2010-03)**

**IEEE 1528-2003**

All test items have been performed and recorded as per the above standards.



## 2.5 GENERAL INFORMATION OF THE SAR SYSTEM

DASY4 (**Software 4.7 Build 80**) consists of high precision robot, probe alignment sensor, phantom, robot controller, controlled measurement server and near-field probe. The robot includes six axes that can move to the precision position of the DASY4 software defined. The DASY4 software can define the area that is detected by the probe. The robot is connected to controlled box. Controlled measurement server is connected to the controlled robot box. The DAE includes amplifier, signal multiplexing, AD converter, offset measurement and surface detection. It is connected to the Electro-optical coupler (ECO). The ECO performs the conversion from the optical into digital electric signal of the DAE and transfers data to the PC.

### EX3DV3 ISOTROPIC E-FIELD PROBE

<b>CONSTRUCTION</b>	Symmetrical design with triangular core Built-in shielding against static charges PEEK enclosure material (resistant to organic solvents, e.g., DGBE)
<b>FREQUENCY</b>	10 MHz to > 6 GHz Linearity: $\pm 0.2$ dB (30 MHz to 6 GHz)
<b>DIRECTIVITY</b>	$\pm 0.3$ dB in HSL (rotation around probe axis) $\pm 0.5$ dB in tissue material (rotation normal to probe axis)
<b>DYNAMIC RANGE</b>	10 $\mu$ W/g to > 100 mW/g Linearity: $\pm 0.2$ dB (noise: typically < 1 $\mu$ W/g)
<b>DIMENSIONS</b>	Overall length: 330 mm (Tip: 20 mm) Tip diameter: 2.5 mm (Body: 12 mm) Typical distance from probe tip to dipole centers: 1 mm
<b>APPLICATION</b>	High precision dosimetric measurements in any exposure scenario (e.g., very strong gradient fields). Only probe which enables compliance testing for frequencies up to 6 GHz with precision of better 30%.

#### NOTE

1. The Probe parameters have been calibrated by the SPEAG. Please reference "APPENDIX D" for the Calibration Certification Report.
2. For frequencies above 800MHz, calibration in a rectangular wave-guide is used, because wave-guide size is manageable.
3. For frequencies below 800MHz, temperature transfer calibration is used because the wave-guide size becomes relatively large.



## EX3DV4 ISOTROPIC E-FIELD PROBE

<b>CONSTRUCTION</b>	Symmetrical design with triangular core Built-in shielding against static charges PEEK enclosure material (resistant to organic solvents, e.g., DGBE)
<b>FREQUENCY</b>	10 MHz to > 6 GHz Linearity: $\pm 0.2$ dB (30 MHz to 6 GHz)
<b>DIRECTIVITY</b>	$\pm 0.3$ dB in HSL (rotation around probe axis) $\pm 0.5$ dB in tissue material (rotation normal to probe axis)
<b>DYNAMIC RANGE</b>	10 $\mu$ W/g to > 100 mW/g Linearity: $\pm 0.2$ dB (noise: typically < 1 $\mu$ W/g)
<b>DIMENSIONS</b>	Overall length: 330 mm (Tip: 20 mm) Tip diameter: 2.5 mm (Body: 12 mm) Typical distance from probe tip to dipole centers: 1 mm
<b>APPLICATION</b>	High precision dosimetric measurements in any exposure scenario (e.g., very strong gradient fields). Only probe which enables compliance testing for frequencies up to 6 GHz with precision of better 30%.

### NOTE

1. The Probe parameters have been calibrated by the SPEAG. Please reference "APPENDIX D" for the Calibration Certification Report.
2. For frequencies above 800MHz, calibration in a rectangular wave-guide is used, because wave-guide size is manageable.
3. For frequencies below 800MHz, temperature transfer calibration is used because the wave-guide size becomes relatively large.



## TWIN SAM V4.0

### CONSTRUCTION

The shell corresponds to the specifications of the Specific Anthropomorphic Mannequin (SAM) phantom defined in IEEE 1528-2003, EN 62209-1 and IEC 62209. It enables the dosimetric evaluation of left and right hand phone usage as well as body mounted usage at the flat phantom region. A cover prevents evaporation of the liquid. Reference markings on the phantom allow the complete setup of all predefined phantom positions and measurement grids by manually teaching three points with the robot.

### SHELL THICKNESS

$2 \pm 0.2\text{mm}$

### FILLING VOLUME

Approx. 25liters

### DIMENSIONS

Height: 810mm; Length: 1000mm; Width: 500mm

## SYSTEM VALIDATION KITS:

### CONSTRUCTION

Symmetrical dipole with 1/4 balun enables measurement of feedpoint impedance with NWA matched for use near flat phantoms filled with brain simulating solutions. Includes distance holder and tripod adaptor

### CALIBRATION

Calibrated SAR value for specified position and input power at the flat phantom in brain simulating solutions

### FREQUENCY

835, 1900, 2450MHz

### RETURN LOSS

> 20dB at specified validation position

### POWER CAPABILITY

> 100W ( $f < 1\text{GHz}$ ); > 40W ( $f > 1\text{GHz}$ )

### OPTIONS

Dipoles for other frequencies or solutions and other calibration conditions upon request



## DEVICE HOLDER FOR SAM TWIN PHANTOM

### CONSTRUCTION

The device holder for the mobile phone device is designed to cope with different positions given in the standard. It has two scales for the device rotation (with respect to the body axis) and the device inclination (with respect to the line between the ear reference points). The rotation centers for both scales is the ear reference point (ERP). Thus the device needs no repositioning when changing the angles. The holder has been made out of low-loss POM material having the following dielectric parameters: relative permittivity  $\epsilon_r = 3$  and loss tangent  $\tan \delta = 0.02$ . The amount of dielectric material has been reduced in the closest vicinity of the device, since measurements have suggested that the influence of the clamp on the test results could thus be lowered. The device holder for the portable device makes up of the polyethylene foam. The dielectric parameters of material close to the dielectric parameters of the air.

## DATA ACQUISITION ELECTRONICS

### CONSTRUCTION

The data acquisition electronics (DAE3) consists of a highly sensitive electrometer grade preamplifier with auto-zeroing, a channel and gain-switching multiplex, a fast 16 bit AD converter and a command decoder and control logic unit. Transmission to the measurement server is accomplished through an optical downlink for data and status information as well as an optical uplink for commands and the clock. The mechanical probe is mounting device includes two different sensor systems for frontal and sideways probe contacts. They are used for mechanical surface detection and probe collision detection. The input impedance of the DAE3 box is 200M $\Omega$ ; the inputs are symmetrical and floating. Common mode rejection is above 80 dB.



A D T

## 2.6 TEST EQUIPMENT

### FOR SAR MEASUREMENT

ITEM	NAME	BRAND	TYPE	SERIES NO.	DATE OF CALIBRATION	DUE DATE OF CALIBRATION
1	ELI 4.0 Phantom	S & P	QDOVA001BA	1039	NA	NA
2	Signal Generator	Agilent	E8257C	MY43320668	Feb. 23, 2010	Feb. 22, 2011
3	Signal Generator	Anritsu	68247B	984703	May 31, 2010	May 30, 2011
4	E-Field Probe	S & P	EX3DV3	3504	Jan. 26, 2010	Jan. 25, 2011
5	E-Field Probe	S & P	EX3DV4	3650	Jan. 24, 2011	Jan. 23, 2012
6	DAE	S & P	DAE 4	861	Jan. 22, 2010	Jan. 21, 2011
7	DAE	S & P	DAE 4	579	Sep. 20, 2010	Sep. 19, 2011
8	Robot Positioner	Staubli Unimation	NA	NA	NA	NA
9	Validation Dipole	S & P	D835V2	4d021	Apr. 29, 2010	Apr. 28, 2011
10			D1900V2	5d022	Jan. 26, 2011	Jan. 25, 2012
11			D2450V2	737	Feb. 19, 2010	Feb. 18, 2011

**NOTE:** Before starting, all test equipment shall be warmed up for 30min.

### FOR TISSUE PROPERTY

ITEM	NAME	BRAND	TYPE	SERIES NO.	DATE OF CALIBRATION	DUE DATE OF CALIBRATION
1	Network Analyzer	Agilent	E8358A	US41480538	Dec. 03, 2009	Dec. 03, 2010
2	Network Analyzer	Agilent	E5071C	MY46104190	Apr. 06, 2010	Apr. 05, 2011
3	Dielectric Probe	Agilent	85070D	US01440176	NA	NA

**NOTE:**

1. Before starting, all test equipment shall be warmed up for 30min.
2. The tolerance ( $k=1$ ) specified by Agilent for general dielectric measurements, deriving from inaccuracies in the calibration data, analyzer drift, and random errors, are usually  $\pm 2.5\%$  and  $\pm 5\%$  for measured permittivity and conductivity, respectively. However, the tolerances for the conductivity is smaller for material with large loss tangents, i.e., less than  $\pm 2.5\%$  ( $k=1$ ). It can be substantially smaller if more accurate methods are applied

## 2.7 GENERAL DESCRIPTION OF THE SPATIAL PEAK SAR EVALUATION

The DASY4 post-processing software (SEMCAD) automatically executes the following procedures to calculate the field units from the micro-volt readings at the probe connector. The parameters used in the evaluation are stored in the configuration modules of the software:

Probe parameters:	- Sensitivity	Norm <sub>i</sub> , a <sub>i0</sub> , a <sub>i1</sub> , a <sub>i2</sub>
	- Conversion factor	ConvF <sub>i</sub>
	- Diode compression point	dcp <sub>i</sub>
Device parameters:	- Frequency	F
	- Crest factor	Cf
Media parameters:	- Conductivity	
	- Density	

The first step of the evaluation is a linearization of the filtered input signal to account for the compression characteristics of the detector diode. The compensation depends on the input signal, the diode type and the DC-transmission factor from the diode to the evaluation electronics. If the exciting field is pulsed, the crest factor of the signal must be known to correctly compensate for peak power. The formula for each channel can be given as:

$$V_i = U_i + U_i^2 \cdot \frac{cf}{dcp_i}$$

V <sub>i</sub>	=compensated signal of channel i	(i = x, y, z)
U <sub>i</sub>	=input signal of channel I	(i = x, y, z)
Cf	=crest factor of exciting field	(DASY parameter)
dcp <sub>i</sub>	=diode compression point	(DASY parameter)

From the compensated input signals the primary field data for each channel can be evaluated:

$$\text{E-field probes: } E_i = \sqrt{\frac{V_i}{\text{Norm}_i \cdot \text{ConvF}}}$$

$$\text{H-field probes: } H_i = \sqrt{V_i} \cdot \frac{a_{i0} + a_{i1}f + a_{i2}f^2}{f}$$

- $V_i$  = compensated signal of channel I (i = x, y, z)  
 $\text{Norm}_i$  = sensor sensitivity of channel i  $\mu\text{V}/(\text{V/m})^2$  for E-field Probes (i = x, y, z)  
 $\text{ConvF}$  = sensitivity enhancement in solution  
 $a_{ij}$  = sensor sensitivity factors for H-field probes  
 $f$  = carrier frequency [GHz]  
 $E_i$  = electric field strength of channel i in V/m  
 $H_i$  = magnetic field strength of channel i in A/m

The RSS value of the field components gives the total field strength (Hermitian magnitude):

$$E_{tot} = \sqrt{E_x^2 + E_y^2 + E_z^2}$$

The primary field data are used to calculate the derived field units.

$$SAR = E_{tot}^2 \cdot \frac{\sigma}{\rho \cdot 1'000}$$

- $SAR$  = local specific absorption rate in mW/g  
 $E_{tot}$  = total field strength in V/m  
 $\sigma$  = conductivity in [mho/m] or [Siemens/m]  
 $\rho$  = equivalent tissue density in g/cm<sup>3</sup>



Note that the density is set to 1, to account for actual head tissue density rather than the density of the tissue simulating liquid. The entire evaluation of the spatial peak values is performed within the Post-processing engine (SEMCAD). The system always gives the maximum values for the 1g and 10g cubes. The algorithm to find the cube with highest averaged SAR is divided into the following stages:

1. The extraction of the measured data (grid and values) from the Zoom Scan
2. The calculation of the SAR value at every measurement point based on all stored data (A/D values and measurement parameters)
3. The generation of a high-resolution mesh within the measured volume
4. The interpolation of all measured values from the measurement grid to the high-resolution grid
5. The extrapolation of the entire 3-D field distribution to the phantom surface over the distance from sensor to surface
6. The calculation of the averaged SAR within masses of 1g and 10g.

The probe is calibrated at the center of the dipole sensors that is located 1 to 2.7mm away from the probe tip. During measurements, the probe stops shortly above the phantom surface, depending on the probe and the surface detecting system. Both distances are included as parameters in the probe configuration file. The software always knows exactly how far away the measured point is from the surface. As the probe cannot directly measure at the surface, the values between the deepest measured point and the surface must be extrapolated. The angle between the probe axis and the surface normal line is less than 30 degree.



The maximum search is automatically performed after each area scan measurement. It is based on splines in two or three dimensions. The procedure can find the maximum for most SAR distributions even with relatively large grid spacing. After the area scanning measurement, the probe is automatically moved to a position at the interpolated maximum. The following scan can directly use this position for reference, e.g., for a finer resolution grid or the cube evaluations. The 1g and 10g peak evaluations are only available for the predefined cube 7 x 7 x 7 scans. The routines are verified and optimized for the grid dimensions used in these cube measurements. The measured volume of 30 x 30 x 30mm contains about 30g of tissue. The first procedure is an extrapolation (incl. boundary correction) to get the points between the lowest measured plane and the surface. The next step uses 3D interpolation to get all points within the measured volume in a 1mm grid (42875 points). In the last step, a 1g cube is placed numerically into the volume and its averaged SAR is calculated. This cube is the moved around until the highest averaged SAR is found. If the highest SAR is found at the edge of the measured volume, the system will issue a warning: higher SAR values might be found outside of the measured volume. In that case the cube measurement can be repeated, using the new interpolated maximum as the center.

### 3. DESCRIPTION OF SUPPORT UNITS

NO.	PRODUCT	BRAND	MODEL NO.	SERIAL NO.
1	Universal Radio Communication Tester	R&S	CMU200	104484

NO.	SIGNAL CABLE DESCRIPTION OF THE ABOVE SUPPORT UNITS
1	NA

**NOTE:** All power cords of the above support units are non shielded (1.8m).

#### 4. DESCRIPTION OF ANTENNA LOCATION

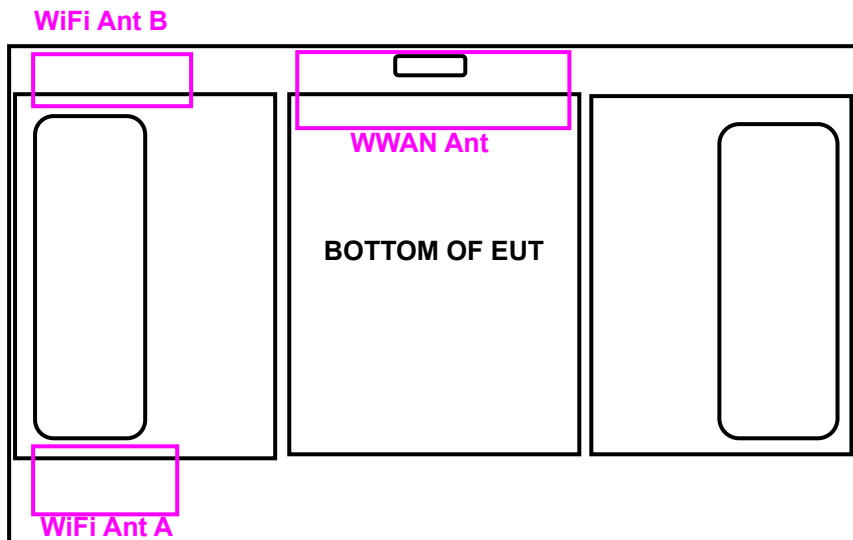

## 5. RECIPES FOR TISSUE SIMULATING LIQUIDS

For the measurement of the field distribution inside the SAM phantom, the phantom must be filled with 25 liters of tissue simulation liquid.

The following are some common ingredients :

- **WATER-** Deionized water (pure H<sub>2</sub>O), resistivity  $\geq 16$  M - as basis for the liquid
- **SUGAR-** Refined sugar in crystals, as available in food shops - to reduce relative permittivity
- **SALT-** Pure NaCl - to increase conductivity
- **CELLULOSE-** Hydroxyethyl-cellulose, medium viscosity (75-125mPa.s, 2% in water, 20\_C),  
CAS # 54290 - to increase viscosity and to keep sugar in solution
- **PRESERVATIVE-** Preventol D-7 Bayer AG, D-51368 Leverkusen, CAS # 55965-84-9 - to prevent the spread of bacteria and molds
- **DGMBE-** Diethylenglycol-monobuthyl ether (DGMBE), Fluka Chemie GmbH, CAS # 112-34-5 - to reduce relative permittivity

### THE RECIPES FOR 835MHz SIMULATING LIQUID TABLE

INGREDIENT	MUSCLE SIMULATING LIQUID 835MHz (MSL-835)
Water	50.07%
Cellulose	NA
Salt	0.94%
Preventtol D-7	0.09%
Sugar	48.2%



### THE RECIPES FOR 1900MHz SIMULATING LIQUID TABLE

INGREDIENT	MUSCLE SIMULATING LIQUID 1900MHz (MSL-1900)
Water	70.16%
DGMBE	29.44%
Salt	00.39%
Dielectric Parameters at 22	f= 1900MHz $\epsilon = 53.3 \pm 5\%$ $\sigma = 1.52 \pm 5\% \text{ S/m}$

### THE RECIPES FOR 2450MHz SIMULATING LIQUID TABLE

INGREDIENT	BODY SIMULATING LIQUID 2450MHz (MSL-2450)
Water	69.83%
DGMBE	30.17%
Dielectric Parameters at 22	f= 2450MHz $\epsilon = 52.7 \pm 5\%$ $\sigma = 1.95 \pm 5\% \text{ S/m}$

Testing the liquids using the Agilent Network Analyzer E8358A and Agilent Dielectric Probe Kit 85070D. The testing procedure is following as

1. Turn Network Analyzer on and allow at least 30min. warm up.
2. Mount dielectric probe kit so that interconnecting cable to Network Analyzer will not be moved during measurements or calibration.
3. Pour de-ionized water and measure water temperature ( $\pm 1^\circ$ ).
4. Set water temperature in Agilent-Software (Calibration Setup).
5. Perform calibration.
6. Validate calibration with dielectric material of known properties (e.g. polished ceramic slab with  $>8\text{mm}$  thickness  $\epsilon' = 10.0$ ,  $\epsilon'' = 0.0$ ). If measured parameters do not fit within tolerance, repeat calibration ( $\pm 0.2$  for  $\epsilon'$ :  $\pm 0.1$  for  $\epsilon''$ ).
7. Conductivity can be calculated from  $\epsilon''$  by  $\sigma = \omega \epsilon_0 \epsilon'' = \epsilon'' f [\text{GHz}] / 18$ .
8. Measure liquid shortly after calibration. Repeat calibration every hour.
9. Stir the liquid to be measured. Take a sample ( $\sim 50\text{ml}$ ) with a syringe from the center of the liquid container.
10. Pour the liquid into a small glass flask. Hold the syringe at the bottom of the flask to avoid air bubbles.
11. Put the dielectric probe in the glass flask. Check that there are no air bubbles in front of the opening in the dielectric probe kit.
12. Perform measurements.
13. Adjust medium parameters in DASY4 for the frequencies necessary for the measurements ('Setup Config', select medium (e.g. Brain 900MHz) and press 'Option'-button.
14. Select the current medium for the frequency of the validation (e.g. Setup Medium Brain 900MHz).



**FOR BAND SIMULATING LIQUID**

<b>LIQUID TYPE</b>		MSL-835			
<b>SIMULATING LIQUID TEMP.</b>		22.8			
<b>TEST DATE</b>		Sep. 07, 2010			
<b>TESTED BY</b>		Sam Onn			
<b>FREQ. (MHz)</b>	<b>LIQUID PARAMETER</b>	<b>STANDARD VALUE</b>	<b>MEASUREMENT VALUE</b>	<b>ERROR PERCENTAGE (%)</b>	<b>LIMIT( % )</b>
835.00	Permittivity ( )	55.20	55.8	1.09	±5
836.40		55.20	55.7	0.91	
836.52		55.20	55.6	0.72	
836.60		55.20	55.5	0.54	
835.00	Conductivity ( ) S/m	0.97	0.96	-1.03	
836.40		0.97	0.98	1.03	
836.52		0.97	0.98	1.03	
836.60		0.97	0.99	2.06	

<b>LIQUID TYPE</b>		MSL-835			
<b>SIMULATING LIQUID TEMP.</b>		21.1			
<b>TEST DATE</b>		Feb. 26, 2011			
<b>TESTED BY</b>		Sam Onn			
<b>FREQ. (MHz)</b>	<b>LIQUID PARAMETER</b>	<b>STANDARD VALUE</b>	<b>MEASUREMENT VALUE</b>	<b>ERROR PERCENTAGE (%)</b>	<b>LIMIT( % )</b>
835.00	Permittivity ( )	55.20	56.06	1.56	±5
836.40		55.20	56.05	1.54	
836.52		55.20	56.05	1.54	
836.60		55.20	56.04	1.52	
835.00	Conductivity ( ) S/m	0.97	0.98	1.03	
836.40		0.97	0.98	1.03	
836.52		0.97	0.98	1.03	
836.60		0.97	0.98	1.03	



<b>LIQUID TYPE</b>		MSL-1900			
<b>SIMULATING LIQUID TEMP.</b>		21.3			
<b>TEST DATE</b>		Feb. 26, 2011			
<b>TESTED BY</b>		Sam Onn			
<b>FREQ. (MHz)</b>	<b>LIQUID PARAMETER</b>	<b>STANDARD VALUE</b>	<b>MEASUREMENT VALUE</b>	<b>ERROR PERCENTAGE (%)</b>	<b>LIMIT(%)</b>
1880.00	Permittivity	53.30	55.13	3.43	±5
1900.00	( )	53.30	54.92	3.04	
1880.00	Conductivity	1.52	1.56	2.63	
1900.00	( ) S/m	1.52	1.57	3.29	

<b>LIQUID TYPE</b>		MSL-2450			
<b>SIMULATING LIQUID TEMP.</b>		22.8			
<b>TEST DATE</b>		Sep. 09, 2010			
<b>TESTED BY</b>		Sam Onn			
<b>FREQ. (MHz)</b>	<b>LIQUID PARAMETER</b>	<b>STANDARD VALUE</b>	<b>MEASUREMENT VALUE</b>	<b>ERROR PERCENTAGE (%)</b>	<b>LIMIT(%)</b>
2437	Permittivity	52.7	53.7	1.90	±5
2450	( )	52.7	53.6	1.71	
2437	Conductivity	1.94	1.97	1.55	
2450	( ) S/m	1.95	1.98	1.54	

## 5. SYSTEM VALIDATION

The system validation was performed in the flat phantom with equipment listed in the following table. Since the SAR value is calculated from the measured electric field, dielectric constant and conductivity of the body tissue and the SAR is proportional to the square of the electric field. So, the SAR value will be also proportional to the RF power input to the system validation dipole under the same test environment. In our system validation test, 250mW RF input power was used.

### 5.1 TEST PROCEDURE

Before the system performance check, we need only to tell the system which components (probe, medium, and device) are used for the system performance check; the system will take care of all parameters. The dipole must be placed beneath the flat section of the SAM Twin Phantom with the correct distance holder in place. The distance holder should touch the phantom surface with a light pressure at the reference marking (little cross) and be oriented parallel to the long side of the phantom. Accurate positioning is not necessary, since the system will search for the peak SAR location, except that the dipole arms should be parallel to the surface. The device holder for mobile phones can be left in place but should be rotated away from the dipole.

1. The "Power Reference Measurement" and "Power Drift Measurement" jobs are located at the beginning and end of the batch process. They measure the field drift at one single point in the liquid over the complete procedure. The indicated drift is mainly the variation of the amplifier output power. If it is too high (above  $\pm 0.1$  dB), the system performance check should be repeated; some amplifiers have very high drift during warm-up. A stable amplifier gives drift results in the DASY system below  $\pm 0.02$ dB.
2. The "Surface Check" job tests the optical surface detection system of the DASY system by repeatedly detecting the surface with the optical and mechanical surface detector and comparing the results. The output gives the detecting heights of both systems, the difference between the two systems and the standard deviation of the detection repeatability. Air bubbles or refraction in the liquid due to separation of the sugar-water mixture gives poor repeatability (above  $\pm 0.1$ mm). In that case it is better to abort the system performance check and stir the liquid.

3. The "Area Scan" job measures the SAR above the dipole on a plane parallel to the surface. It is used to locate the approximate location of the peak SAR. The proposed scan uses large grid spacing for faster measurement; due to the symmetric field, the peak detection is reliable. If a finer graphic is desired, the grid spacing can be reduced. Grid spacing and orientation have no influence on the SAR result.
4. The "Zoom Scan" job measures the field in a volume around the peak SAR value assessed in the previous "Area Scan" job (for more information see the application note on SAR evaluation).

About the validation dipole positioning uncertainty, the constant and low loss dielectric spacer is used to establish the correct distance between the top surface of the dipole and the bottom surface of the phantom, the error component introduced by the uncertainty of the distance between the liquid (i.e., phantom shell) and the validation dipole in the DASY4 system is less than  $\pm 0.1\text{mm}$ .

$$SAR_{tolerance} [\%] = 100 \times \left( \frac{(a + d)^2}{a^2} - 1 \right)$$

As the closest distance is 10mm, the resulting tolerance  $SAR_{tolerance}[\%]$  is <2%.

## 5.2 VALIDATION RESULTS

SYSTEM VALIDATION TEST OF SIMULATING LIQUID					
FREQUENCY (MHz)	REQUIRED SAR (mW/g)	MEASURED SAR (mW/g)	DEVIATION (%)	SEPARATION DISTANCE	TESTED DATE
MSL 850	2.52 (1g)	2.55	1.19	15mm	Sep. 07, 2010
MSL 850	2.52 (1g)	2.43	-3.57	15mm	Feb. 26, 2011
MSL 1900	10.40 (1g)	9.89	-4.90	10mm	Feb. 26, 2011
MSL 2450	13.10 (1g)	12.80	-2.29	10mm	Sep. 09, 2010
<b>TESTED BY</b>	Sam Onn				

**NOTE:** Please see Appendix for the photo of system validation test.

### 5.3 SYSTEM VALIDATION UNCERTAINTIES

In the table below, the system validation uncertainty with respect to the analytically assessed SAR value of a dipole source as given in the IEEE 1528 standard is given. This uncertainty is smaller than the expected uncertainty for mobile phone measurements due to the simplified setup and the symmetric field distribution.

Error Description	Tolerance (±%)	Probability Distribution	Divisor	(C <sub>i</sub> )		Standard Uncertainty (±%)		(V <sub>i</sub> )
				(1g)	(10g)	(1g)	(10g)	
<b>Measurement System</b>								
Probe Calibration	5.50	Normal	1	1	1	5.50	5.50	
Axial Isotropy	0.25	Rectangular	3	0.7	0.7	0.10	0.10	
Hemispherical Isotropy	1.30	Rectangular	3	0.7	0.7	0.53	0.53	
Boundary effects	1.00	Rectangular	3	1	1	0.58	0.58	
Linearity	0.30	Rectangular	3	1	1	0.17	0.17	
System Detection Limits	1.00	Rectangular	3	1	1	0.58	0.58	
Readout Electronics	0.30	Normal	1	1	1	0.30	0.30	
Response Time	0.80	Rectangular	3	1	1	0.46	0.46	
Integration Time	2.60	Rectangular	3	1	1	1.50	1.50	
RF Ambient Noise	3.00	Rectangular	3	1	1	1.73	1.73	9
RF Ambient Reflections	3.00	Rectangular	3	1	1	1.73	1.73	9
Probe Positioner	0.40	Rectangular	3	1	1	0.23	0.23	
Probe Positioning	2.90	Rectangular	3	1	1	1.67	1.67	
Max. SAR Eval.	1.00	Rectangular	3	1	1	0.58	0.58	
<b>Test sample related</b>								
Sample positioning	1.90	Normal	1	1	1	1.90	1.90	4
Device holder uncertainty	2.80	Normal	1	1	1	2.80	2.80	4
Output power variation-SAR drift measurement	2.05	Rectangular	3	1	1	1.18	1.18	1
<b>Dipole Related</b>								
Dipole Axis to Liquid Distance	1.60	Rectangular	3	1	1	0.92	0.92	4
Input Power Drift	3.71	Rectangular	3	1	1	2.14	2.14	1
<b>Phantom and Tissue parameters</b>								
Phantom Uncertainty	4.00	Rectangular	3	1	1	2.31	2.31	
Liquid Conductivity (target)	5.00	Rectangular	3	0.64	0.43	1.85	1.24	
Liquid Conductivity (measurement)	2.63	Normal	1	0.64	0.43	1.68	1.13	9
Liquid Permittivity (target)	5.00	Rectangular	3	0.6	0.49	1.73	1.41	
Liquid Permittivity (measurement)	1.90	Normal	1	0.6	0.49	1.14	0.93	9
<b>Combined Standard Uncertainty</b>						<b>8.78</b>	<b>8.50</b>	
<b>Coverage Factor for 95%</b>						<b>Kp=2</b>		
<b>Expanded Uncertainty (K=2)</b>						<b>17.57</b>	<b>17.00</b>	

**NOTE:** About the system validation uncertainty assessment, please reference the section 7.



## 6. TEST RESULTS

### 6.1 TEST PROCEDURES

The EUT makes a call to the communication simulator station. Establish the simulation communication configuration rather the actual communication. Then the EUT could continuous the transmission mode. Adjust the PCL of the base station could controlled the EUT to transmitted the maximum output power. The base station also could control the transmission channel. The SAR value was calculated via the 3D spline interpolation algorithm that has been implemented in the software of DASY4 SAR measurement system manufactured and calibrated by SPEAG. According to the IEEE 1528 / EN 62209-1, the recommended procedure for assessing the peak spatial-average SAR value consists of the following steps:

- Power reference measurement
- Verification of the power reference measurement
- Area scan
- Zoom scan
- Power reference measurement

The area scan was performed for the highest spatial SAR location. The zoom scan was performed for SAR value averaged over 1g and 10g spatial volumes.

In the zoom scan, the distance between the measurement point at the probe sensor location (geometric center behind the probe tip) and the phantom surface is 2mm and maintained at a constant distance of  $\pm 0.5$ mm during a zoom scan to determine peak SAR locations. The distance is 2mm between the first measurement point and the bottom surface of the phantom.



The measurement time is 0.5s at each point of the zoom scan. The probe boundary effect compensation shall be applied during the SAR test. Because of the tip of the probe to the Phantom surface separated distances are longer than half a tip probe diameter.

In the area scan, the separation distance is 2mm between the each measurement point and the phantom surface. The scan size shall be included the transmission portion of the EUT. The measurement time is the same as the zoom scan. At last the reference power drift shall be less than  $\pm 5\%$ .

## 6.2 DESCRIPTION OF TEST CONDITION

TEST DATE	TISSUE TYPE / FREQ.	TEMPERATURE (°C)		HUMIDITY (%RH)	TESTED BY
		AIRBENT	LIQUID		
Sep. 07, 2010	MSL 850	23.0	22.8	60	Sam Onn
Feb. 26, 2011	MSL 850	22.3	21.1	58	Sam Onn
Feb. 26, 2011	MSL 1900	22.6	21.3	56	Sam Onn
Sep. 09, 2010	MSL 2450	23.0	22.8	60	Sam Onn

### 6.3 MEASURED SAR RESULT

BODY		
EUT	Bottom	Edge
<b>GPRS 850 TS1</b>		
CH 190: 836.6MHz	0.088	0.015
<b>GPRS 850 TS2</b>		
CH 190: 836.6MHz	<b>0.157</b>	0.023
<b>E-GPRS 850 TS1</b>		
CH 190: 836.6MHz	0.036	0.00739
<b>E-GPRS 850 TS2</b>		
CH 190: 836.6MHz	0.064	0.011
<b>WCDMA 850</b>		
CH 4182: 836.4MHz	0.068	0.00986
<b>CDMA 850</b>		
CH 384: 836.52MHz	0.075	0.0092
<b>EVDO850_Rev.0</b>		
CH 384: 836.52MHz	0.081	0.012

**NOTE:**

1. Please see the Appendix A for the data.
2. The variation of the EUT conducted power measured before and after SAR testing should not over 5%.
3. Distance between EUT and phantom is 0mm for test of body position.
4. Per DA-02-1438A1, when 1-g SAR for the middle channel is less than 0.8 W/kg, testing for the other channels is not required

BODY		
EUT	Bottom	Edge
<b>GPRS 1900 TS1</b>		
CH 661: 1880.00MHz	0.125	0.00482
<b>GPRS 1900 TS2</b>		
CH 661: 1880.00MHz	0.249	0.011
<b>E-GPRS 1900 TS1</b>		
CH 661: 1880.00MHz	0.057	0.00288
<b>E-GPRS 1900 TS2</b>		
CH 661: 1880.00MHz	0.112	0.00654
<b>WCDMA 1900</b>		
CH 9400: 1880.00MHz	0.295	0.015
<b>CDMA 1900</b>		
CH 600: 1880.00MHz	<b>0.306</b>	0.013
<b>EVDO1900_Rev.0</b>		
CH 600: 1880.00MHz	0.306	0.013

**NOTE:**

1. Please see the Appendix A for the data.
2. The variation of the EUT conducted power measured before and after SAR testing should not over 5%.
3. Distance between EUT and phantom is 0mm for test of body position.
4. Per DA-02-1438A1, when 1-g SAR for the middle channel is less than 0.8 W/kg, testing for the other channels is not required

BODY		
EUT	Bottom	Edge
<b>11b-ANTA</b>		
CH 6: 2437MHz	0.090	0.026
<b>11b-ANTB</b>		
CH 6: 2437MHz	0.053	<b>0.529</b>

**NOTE:**

1. In this testing, the limit for General Population Spatial Peak averaged over 1g, **1.6 W/kg**, is applied.
2. Please see the Appendix A for the data.
3. The variation of the EUT conducted power measured before and after SAR testing should not over 5%.
4. SAR is not required for 802.11g / 11n 20MHz / 11 n 40MHz channels when the maximum average output power is less than ¼ dB higher than that measured on the corresponding 802.11b channels
5. Per KDB 447498, when 1-g SAR for the highest output channel is less than 0.8 W/kg, where the transmission band corresponding to all channels is ≤ 100 MHz, testing for the other channels is not required

#### 6.4 POWER DRIFT TABLE

Test Mode	Communication Mode	Test Channel	Test Frequency	Power (dBm)		Power Drift (%)
				Begin	After	
1	GPRS850 TS1	190	836.6MHz	32.10	32.05	-1.14
2	GPRS850 TS2	190	836.6MHz	31.90	31.83	-1.60
3	E-GPRS850 TS1	190	836.6MHz	27.70	27.63	-1.60
4	E-GPRS850 TS2	190	836.6MHz	27.60	27.54	-1.37
5	WCDMA850	4182	836.4MHz	24.39	24.21	-4.06
6	CDMA850	384	836.52MHz	23.58	23.38	-4.50
7	EVDO850 Rev.0	384	836.52MHz	23.44	23.29	-3.39
8	GPRS850 TS1	190	836.6MHz	32.10	32.04	-1.37
9	GPRS850 TS2	190	836.6MHz	31.90	31.82	-1.83
10	E-GPRS850 TS1	190	836.6MHz	27.70	27.63	-1.60
11	E-GPRS850 TS2	190	836.6MHz	27.60	27.52	-1.83
12	WCDMA850	4182	836.4MHz	24.39	24.25	-3.17
13	CDMA850	384	836.52MHz	23.58	23.35	-3.84
14	EVDO850 Rev.0	384	836.52MHz	23.44	23.35	-2.05
15	GPRS1900 TS1	661	1880.00MHz	28.90	28.85	-1.14
16	GPRS1900 TS2	661	1880.00MHz	28.80	28.74	-1.37
17	E-GPRS1900 TS1	661	1880.00MHz	25.60	25.52	-1.83
18	E-GPRS1900 TS2	661	1880.00MHz	25.60	25.53	-1.60
19	WCDMA1900	9400	1880.00MHz	24.33	24.21	-2.73
20	CDMA1900	600	1880.00MHz	24.41	24.23	-4.06
21	EVDO1900 Rev.0	600	1880.00MHz	24.20	24.14	-1.37
22	GPRS1900 TS1	661	1880.00MHz	28.90	28.82	-1.83
23	GPRS1900 TS2	661	1880.00MHz	28.80	28.73	-1.60
24	E-GPRS1900 TS1	661	1880.00MHz	25.60	25.54	-1.37
25	E-GPRS1900 TS2	661	1880.00MHz	25.60	25.53	-1.60
26	WCDMA1900	9400	1880.00MHz	24.33	24.15	-4.06
27	CDMA1900	600	1880.00MHz	24.41	24.28	-2.95
28	EVDO1900 Rev.0	600	1880.00MHz	24.20	24.12	-1.83
29	11b	6	2437MHz	15.50	15.44	-1.37
30	11b	6	2437MHz	15.50	15.45	-1.14
31	11b	6	2437MHz	15.50	15.41	-2.05
32	11b	6	2437MHz	15.50	15.43	-1.60

## 6.5 NO SIMULTANEOUS SAR JUSTIFICATION

Follow KDB 616217 D03 SAR Supp Note and Netbook Laptop v01 to confirm simultaneous SAR is required or not. Separation between TX antenna pair is > 5cm and  $\Sigma$  1-g SAR is less than 1.6 W/kg. Therefore, simultaneous SAR is not required.

### Antenna Separation distance (cm)

	WWAN	Wi-Fi ANT A	Wi-Fi ANT B
WWAN		0.5	15
Wi-Fi ANT A	0.5		13
Wi-Fi ANT B	15	13	

Note :

1. WWAN and Wi-Fi Antenna A can not work at the same time
2. Please refer to "OpDes-Antenna\_YY3-01120709267" for antenna separation distance

### $\Sigma$ of the highest measured 1-g SAR for each portable transmitter at Bottom position

WWAN 850	WLAN 2.4GHz	SAR sum of each tx	
(W/kg)	(W/kg)	(W/kg)	
GPRS	0.157	0.09	0.247
EGPRS	0.064	0.09	0.154
WCDMA	0.068	0.09	0.158
CDMA	0.075	0.09	0.165
EVDO Rev.0	0.081	0.09	0.171

WWAN 1900	WLAN 2.4GHz	SAR sum of each tx	
(W/kg)	(W/kg)	(W/kg)	
GPRS	0.249	0.09	0.339
EGPRS	0.112	0.09	0.202
WCDMA	0.295	0.09	0.385
CDMA	0.306	0.09	0.396
EVDO Rev.0	0.306	0.09	0.396



**$\Sigma$  of the highest measured 1-g SAR for each portable transmitter at Edge position**

<b>WWAN 850</b>		<b>WLAN 2.4GHz</b>	<b>SAR sum of each tx</b>
<b>(W/kg)</b>		<b>(W/kg)</b>	<b>(W/kg)</b>
GPRS	0.023	0.529	0.552
EGPRS	0.011	0.529	0.54
WCDMA	0.00986	0.529	0.53886
CDMA	0.0092	0.529	0.5382
EVDO Rev.0	0.012	0.529	0.541

<b>WWAN1900</b>		<b>WLAN 2.4GHz</b>	<b>SAR sum of each tx</b>
<b>(W/kg)</b>		<b>(W/kg)</b>	<b>(W/kg)</b>
GPRS	0.011	0.529	0.54
EGPRS	0.00654	0.529	0.53554
WCDMA	0.015	0.529	0.544
CDMA	0.013	0.529	0.542
EVDO Rev.0	0.013	0.529	0.542



## 6.6 SAR LIMITS

HUMAN EXPOSURE	SAR (W/kg)	
	(GENERAL POPULATION / UNCONTROLLED EXPOSURE ENVIRONMENT)	(OCCUPATIONAL / CONTROLLED EXPOSURE ENVIRONMENT)
Spatial Peak (averaged over 1 g)	1.6	8.0

**NOTE:** This limits accord to 47 CFR 2.1093 – Safety Limit.





## 7. INFORMATION ON THE TESTING LABORATORIES

We, Bureau Veritas Consumer Products Services (H.K.) Ltd., Taoyuan Branch, were founded in 1988 to provide our best service in EMC, Radio, Telecom and Safety consultation. Our laboratories are accredited and approved according to ISO/IEC 17025.

Copies of accreditation and authorization certificates of our laboratories obtained from approval agencies can be downloaded from our web site:

[www.adt.com.tw/index.5.phtml](http://www.adt.com.tw/index.5.phtml). If you have any comments, please feel free to contact us at the following:

**Linko EMC/RF Lab:**

Tel: 886-2-26052180

Fax: 886-2-26051924

**Hsin Chu EMC/RF Lab:**

Tel: 886-3-5935343

Fax: 886-3-5935342

**Hwa Ya EMC/RF/Safety/Telecom Lab:**

Tel: 886-3-3183232

Fax: 886-3-3185050

**Web Site:** [www.adt.com.tw](http://www.adt.com.tw)

The address and road map of all our labs can be found in our web site also.

---END---



香港商立德國際商品試驗有限公司桃園分公司

Bureau Veritas Consumer Products Services (H.K.) Ltd., Taoyuan Branch

**APPENDIX A: TEST DATA**

**Product Name:7 Rugged Tablet PC; Model Number:Algiz 7**

**Liquid Level Photo**

**Tissue MSL850MHz D=150mm**

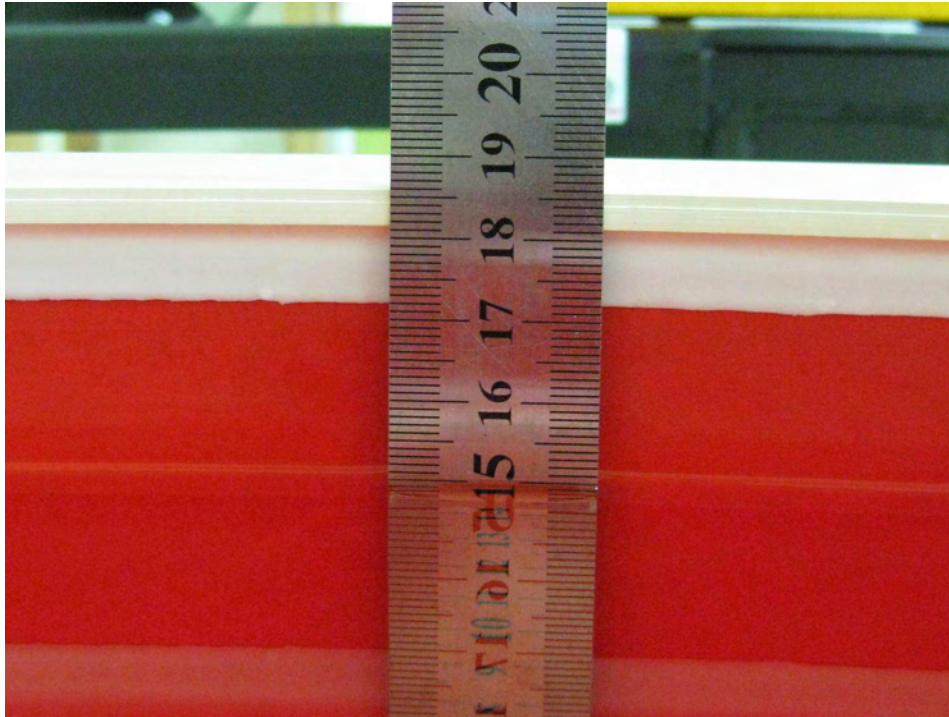

**Tissue 1900MHz D=150mm**

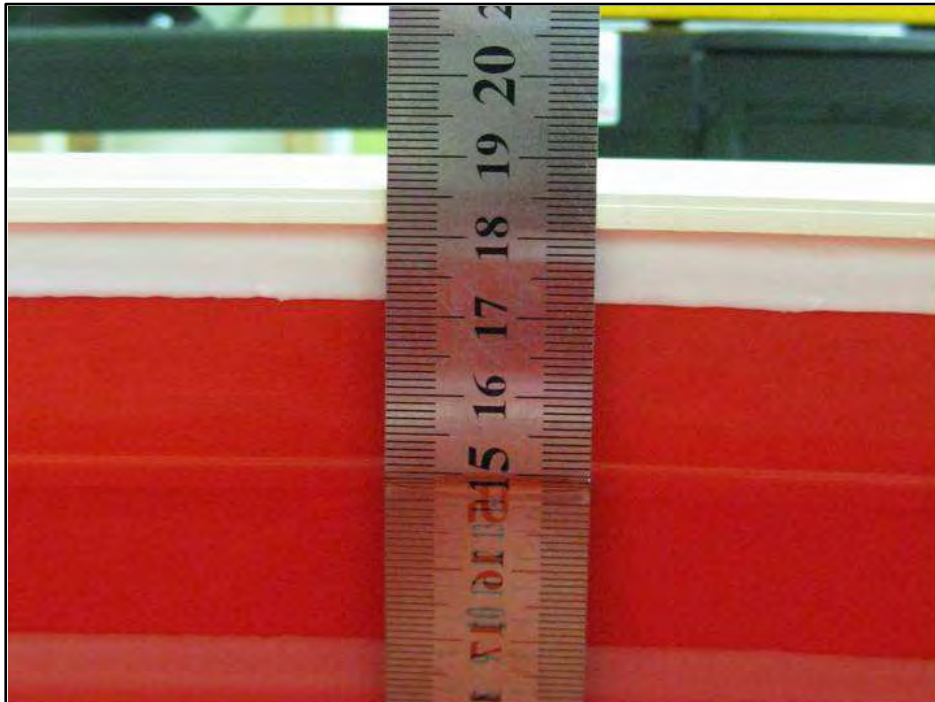

## M01-Bottom-GPRS850 TS1

### DUT: 7 Rugged Table PC ; Type: Algiz7

Communication System: GPRS 850 ; Frequency: 836.6 MHz ; Duty Cycle: 1:8.3 ; Modulation type: GMSK  
Medium: MSL835 Medium parameters used:  $f = 836.6 \text{ MHz}$ ;  $\sigma = 0.99 \text{ mho/m}$ ;  $\epsilon_r = 55.5$ ;  $\rho = 1000 \text{ kg/m}^3$   
Phantom section: Flat Section ; Separation distance : 0 mm (The Bottom side of the EUT to the Phantom)

#### DASY4 Configuration:

- Probe: EX3DV3 - SN3504 ; ConvF(9.83, 9.83, 9.83) ; Calibrated: 2010/1/26
- Sensor-Surface: 2mm (Mechanical Surface Detection)
- Electronics: DAE4 Sn861 ; Calibrated: 2010/1/22
- Phantom: Flat Phantom ELI4.0 ; Type: QDOVA001BB ; Serial: SN:1039
- Measurement SW: DASY4, V4.7 Build 80 ; Postprocessing SW: SEMCAD, V1.8 Build 186

### Mid Channel 190/Area Scan (11x15x1): Measurement grid: dx=15mm, dy=15mm

Maximum value of SAR (measured) = 0.099 mW/g

### Mid Channel 190/Zoom Scan (7x7x7)/Cube 0: Measurement grid: dx=5mm, dy=5mm, dz=5mm

Reference Value = 5.96 V/m; Power Drift = -0.096 dB

Peak SAR (extrapolated) = 0.112 W/kg

SAR(1 g) = **0.088 mW/g**; SAR(10 g) = 0.070 mW/g

Maximum value of SAR (measured) = 0.101 mW/g

### Mid Channel 190/Zoom Scan (7x7x7)/Cube 1: Measurement grid: dx=5mm, dy=5mm, dz=5mm

Reference Value = 5.96 V/m; Power Drift = -0.096 dB

Peak SAR (extrapolated) = 0.104 W/kg

SAR(1 g) = 0.079 mW/g; SAR(10 g) = 0.061 mW/g

Maximum value of SAR (measured) = 0.092 mW/g

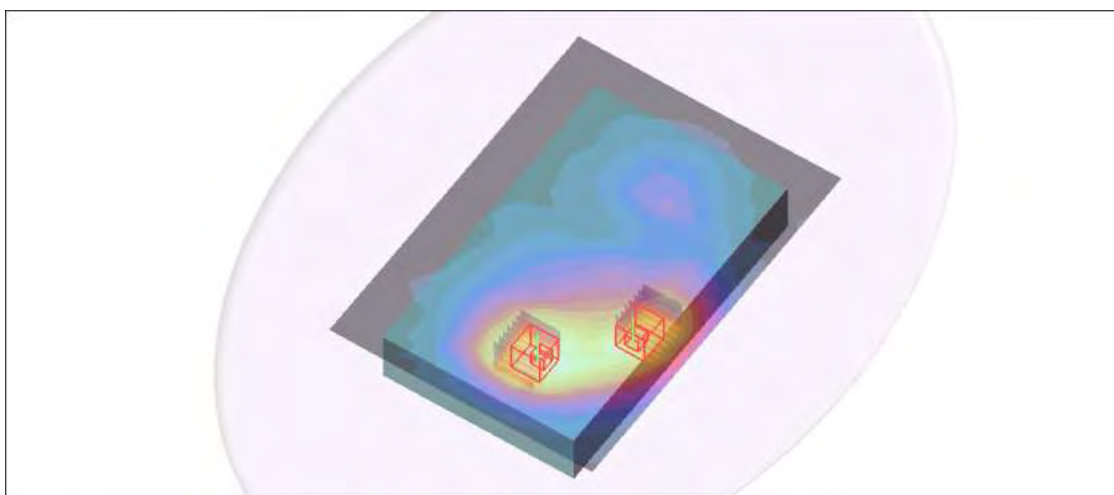
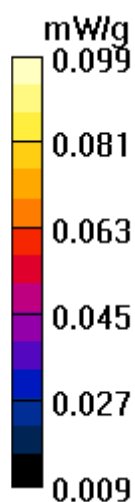

## M02-Bottom-GPRS850 TS2

### DUT: 7 Rugged Table PC ; Type: Algiz7

Communication System: GPRS 850 ; Frequency: 836.6 MHz ; Duty Cycle: 1:4 ; Modulation type: GMSK  
Medium: MSL835 Medium parameters used:  $f = 836.6$  MHz;  $\sigma = 0.99$  mho/m;  $\epsilon_r = 55.5$ ;  $\rho = 1000$  kg/m<sup>3</sup>  
Phantom section: Flat Section ; Separation distance : 0 mm (The Bottom side of the EUT to the Phantom)

#### DASY4 Configuration:

- Probe: EX3DV3 - SN3504 ; ConvF(9.83, 9.83, 9.83) ; Calibrated: 2010/1/26
- Sensor-Surface: 2mm (Mechanical Surface Detection)
- Electronics: DAE4 Sn861 ; Calibrated: 2010/1/22
- Phantom: Flat Phantom ELI4.0 ; Type: QDOVA001BB ; Serial: SN:1039
- Measurement SW: DASY4, V4.7 Build 80 ; Postprocessing SW: SEMCAD, V1.8 Build 186

### Mid Channel 190/Area Scan (11x15x1): Measurement grid: dx=15mm, dy=15mm

Maximum value of SAR (measured) = 0.179 mW/g

### Mid Channel 190/Zoom Scan (7x7x7)/Cube 0: Measurement grid: dx=5mm, dy=5mm, dz=5mm

Reference Value = 7.88 V/m; Power Drift = -0.144 dB

Peak SAR (extrapolated) = 0.201 W/kg

SAR(1 g) = **0.157 mW/g**; SAR(10 g) = 0.122 mW/g

Maximum value of SAR (measured) = 0.183 mW/g

### Mid Channel 190/Zoom Scan (7x7x7)/Cube 1: Measurement grid: dx=5mm, dy=5mm, dz=5mm

Reference Value = 7.88 V/m; Power Drift = -0.144 dB

Peak SAR (extrapolated) = 0.386 W/kg

SAR(1 g) = 0.155 mW/g; SAR(10 g) = 0.079 mW/g

Maximum value of SAR (measured) = 0.168 mW/g

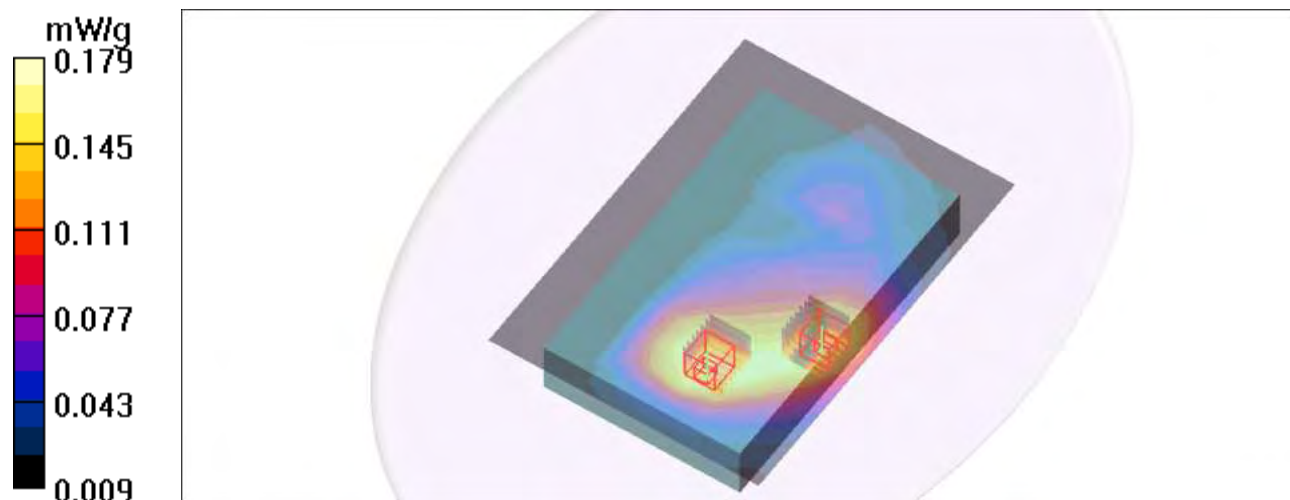

### M03-Bottom-E-GPRS850 TS1

#### DUT: 7 Rugged Table PC ; Type: Algiz7

Communication System: E-GPRS 850 ; Frequency: 836.6 MHz ; Duty Cycle: 1:8.3 ; Modulation type: 8PSK  
Medium: MSL835 Medium parameters used:  $f = 836.6$  MHz;  $\sigma = 0.99$  mho/m;  $\epsilon_r = 55.5$ ;  $\rho = 1000$  kg/m<sup>3</sup>  
Phantom section: Flat Section ; Separation distance : 0 mm (The Bottom side of the EUT to the Phantom)

#### DASY4 Configuration:

- Probe: EX3DV3 - SN3504 ; ConvF(9.83, 9.83, 9.83) ; Calibrated: 2010/1/26
- Sensor-Surface: 2mm (Mechanical Surface Detection)
- Electronics: DAE4 Sn861 ; Calibrated: 2010/1/22
- Phantom: Flat Phantom ELI4.0 ; Type: QDOVA001BB ; Serial: SN:1039
- Measurement SW: DASY4, V4.7 Build 80 ; Postprocessing SW: SEMCAD, V1.8 Build 186

**Mid Channel 190/Area Scan (11x15x1):** Measurement grid: dx=15mm, dy=15mm  
Maximum value of SAR (measured) = 0.040 mW/g

**Mid Channel 190/Zoom Scan (7x7x7)/Cube 0:** Measurement grid: dx=5mm, dy=5mm, dz=5mm  
Reference Value = 3.76 V/m; Power Drift = 0.106 dB  
Peak SAR (extrapolated) = 0.044 W/kg

**SAR(1 g) = 0.036 mW/g; SAR(10 g) = 0.029 mW/g**

**Mid Channel 190/Zoom Scan (7x7x7)/Cube 1:** Measurement grid: dx=5mm, dy=5mm, dz=5mm  
Reference Value = 3.76 V/m; Power Drift = 0.106 dB  
Peak SAR (extrapolated) = 0.042 W/kg  
**SAR(1 g) = 0.032 mW/g; SAR(10 g) = 0.026 mW/g**  
Maximum value of SAR (measured) = 0.037 mW/g

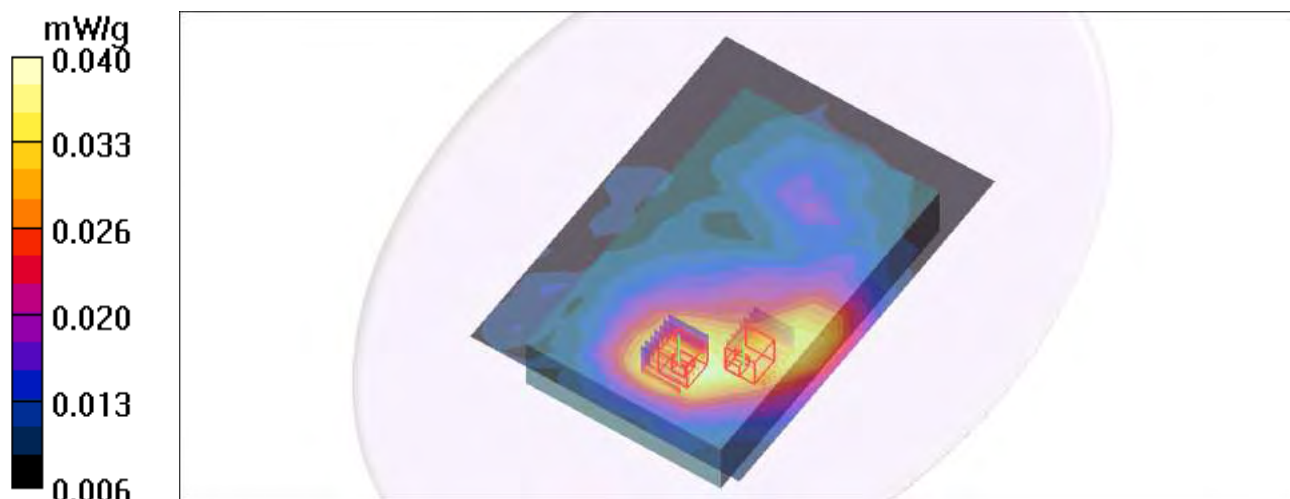

## M04-Bottom-E-GPRS850 TS2

### DUT: 7 Rugged Table PC ; Type: Algiz7

Communication System: E-GPRS 850 ; Frequency: 836.6 MHz ; Duty Cycle: 1:4 ; Modulation type: 8PSK  
Medium: MSL835 Medium parameters used:  $f = 836.6$  MHz;  $\sigma = 0.99$  mho/m;  $\epsilon_r = 55.5$ ;  $\rho = 1000$  kg/m<sup>3</sup>  
Phantom section: Flat Section ; Separation distance : 0 mm (The Bottom side of the EUT to the Phantom)

#### DASY4 Configuration:

- Probe: EX3DV3 - SN3504 ; ConvF(9.83, 9.83, 9.83) ; Calibrated: 2010/1/26
- Sensor-Surface: 2mm (Mechanical Surface Detection)
- Electronics: DAE4 Sn861 ; Calibrated: 2010/1/22
- Phantom: Flat Phantom ELI4.0 ; Type: QDOVA001BB ; Serial: SN:1039
- Measurement SW: DASY4, V4.7 Build 80 ; Postprocessing SW: SEMCAD, V1.8 Build 186

### Mid Channel 190/Area Scan (11x15x1): Measurement grid: dx=15mm, dy=15mm

Maximum value of SAR (measured) = 0.072 mW/g

### Mid Channel 190/Zoom Scan (7x7x7)/Cube 0: Measurement grid: dx=5mm, dy=5mm, dz=5mm

Reference Value = 5.40 V/m; Power Drift = -0.179 dB

Peak SAR (extrapolated) = 0.082 W/kg

SAR(1 g) = **0.064 mW/g**; SAR(10 g) = **0.049 mW/g**

Maximum value of SAR (measured) = 0.075 mW/g

### Mid Channel 190/Zoom Scan (7x7x7)/Cube 1: Measurement grid: dx=5mm, dy=5mm, dz=5mm

Reference Value = 5.40 V/m; Power Drift = -0.179 dB

Peak SAR (extrapolated) = 0.110 W/kg

SAR(1 g) = **0.060 mW/g**; SAR(10 g) = **0.036 mW/g**

Maximum value of SAR (measured) = 0.067 mW/g

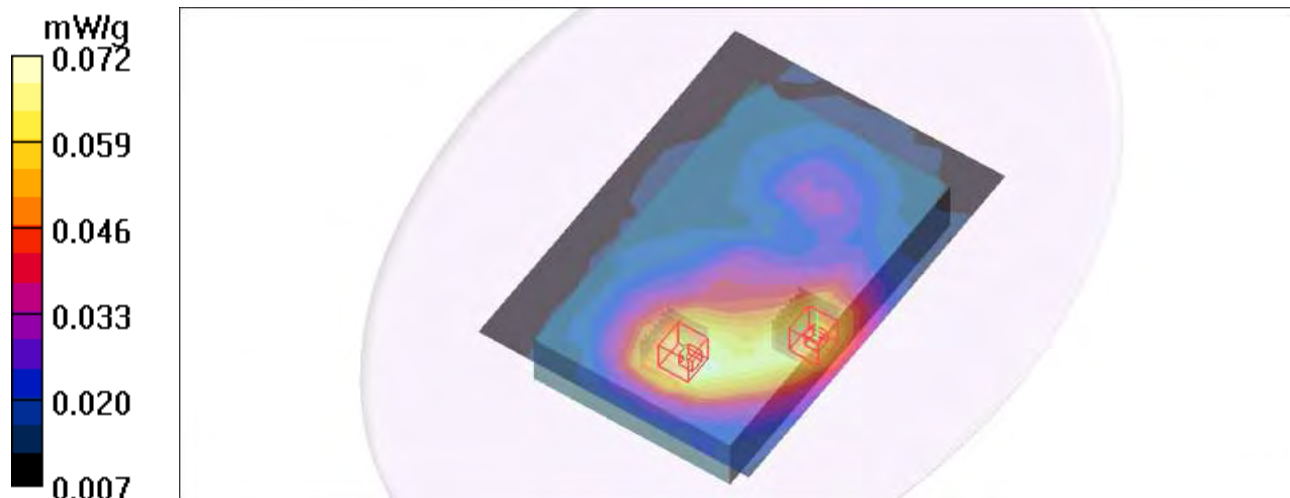

## M05--Bottom WCDMA850-Ch4182

Communication System: WCDMA850 ; Frequency: 836.4 MHz ; Duty Cycle: 1:1 ; Modulation type: BPSK

Medium: MSL835 Medium parameters used:  $f = 836.4$  MHz;  $\sigma = 0.98$  mho/m;  $\epsilon_r = 56.05$ ;  $\rho = 1000$  kg/m<sup>3</sup>

Phantom section: Flat Section ; Separation distance : 0 mm (The bottom side of the EUT to the Phantom)

DASY4 Configuration:

- Probe: EX3DV4 - SN3650; ConvF(9.12, 9.12, 9.12); Calibrated: 2011/1/24
- Sensor-Surface: 2mm (Mechanical Surface Detection)
- Electronics: DAE3 Sn579; Calibrated: 2010/9/20
- Phantom: Flat Phantom ELI4.0; Type: QDOVA001BA; Serial: SN:1039
- Measurement SW: DASY4, Version 4.7 (80); SEMCAD X Version 14.4.2 (2595)

**Mid Channel 4182/Area Scan (11x15x1):** Measurement grid: dx=15mm, dy=15mm

Maximum value of SAR (measured) = 0.081 mW/g

**Mid Channel 4182/Zoom Scan (7x7x7)/Cube 0:** Measurement grid: dx=5mm, dy=5mm, dz=5mm

Reference Value = 7.192 V/m; Power Drift = -0.12 dB

Peak SAR (extrapolated) = 0.091 W/kg

**SAR(1 g) = 0.068 mW/g; SAR(10 g) = 0.052 mW/g**

**Mid Channel 4182/Zoom Scan (7x7x7)/Cube 1:** Measurement grid: dx=5mm, dy=5mm, dz=5mm

Reference Value = 7.192 V/m; Power Drift = -0.12 dB

Peak SAR (extrapolated) = 0.086 W/kg

**SAR(1 g) = 0.066 mW/g; SAR(10 g) = 0.050 mW/g**

Maximum value of SAR (measured) = 0.078 mW/g

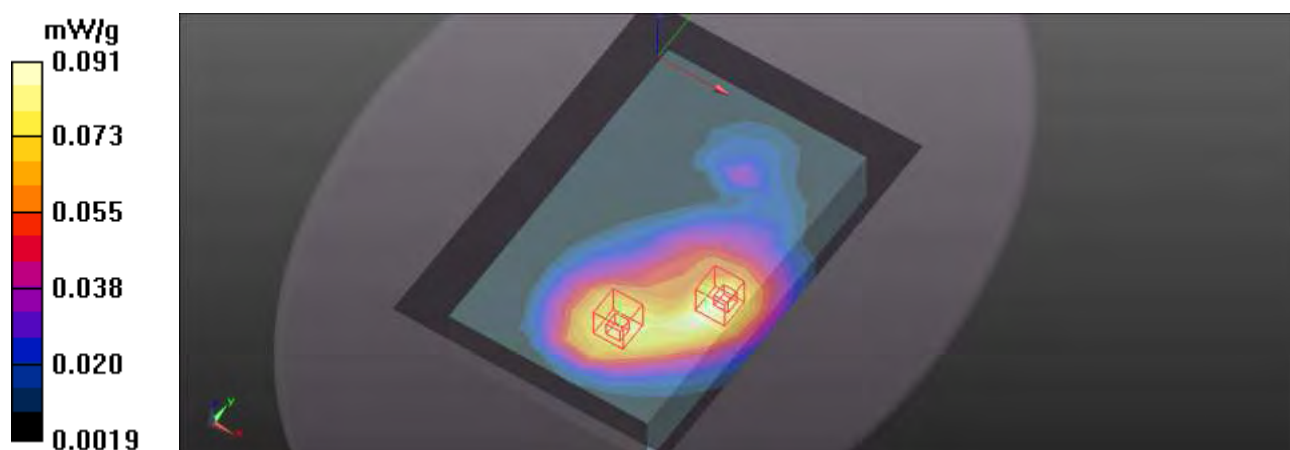

## M06--Bottom CDMA850-Ch384

Communication System: CDMA850 ; Frequency: 836.52 MHz ; Duty Cycle: 1:1 ; Modulation type: OQPSK

Medium: MSL835 Medium parameters used:  $f = 836.52 \text{ MHz}$ ;  $\sigma = 0.98 \text{ mho/m}$ ;  $\epsilon_r = 56.05$ ;  $\rho = 1000 \text{ kg/m}^3$

Phantom section: Flat Section ; Separation distance : 0 mm (The bottom side of the EUT to the Phantom)

DASY4 Configuration:

- Probe: EX3DV4 - SN3650; ConvF(9.12, 9.12, 9.12); Calibrated: 2011/1/24
- Sensor-Surface: 2mm (Mechanical Surface Detection)
- Electronics: DAE3 Sn579; Calibrated: 2010/9/20
- Phantom: Flat Phantom ELI4.0; Type: QDOVA001BA; Serial: SN:1039
- Measurement SW: DASY4, Version 4.7 (80); SEMCAD X Version 14.4.2 (2595)

**Mid Channel 384/Area Scan (11x15x1):** Measurement grid:  $dx=15\text{mm}$ ,  $dy=15\text{mm}$

Maximum value of SAR (measured) = 0.084 mW/g

**Mid Channel 384/Zoom Scan (7x7x7)/Cube 0:** Measurement grid:  $dx=5\text{mm}$ ,  $dy=5\text{mm}$ ,  $dz=5\text{mm}$

Reference Value = 7.853 V/m; Power Drift = 0.16 dB

Peak SAR (extrapolated) = 0.095 W/kg

**SAR(1 g) = 0.075 mW/g; SAR(10 g) = 0.058 mW/g**

Maximum value of SAR (measured) = 0.086 mW/g

**Mid Channel 384/Zoom Scan (7x7x7)/Cube 1:** Measurement grid:  $dx=5\text{mm}$ ,  $dy=5\text{mm}$ ,  $dz=5\text{mm}$

Reference Value = 7.853 V/m; Power Drift = 0.16 dB

Peak SAR (extrapolated) = 0.091 W/kg

**SAR(1 g) = 0.069 mW/g; SAR(10 g) = 0.053 mW/g**

Maximum value of SAR (measured) = 0.084 mW/g

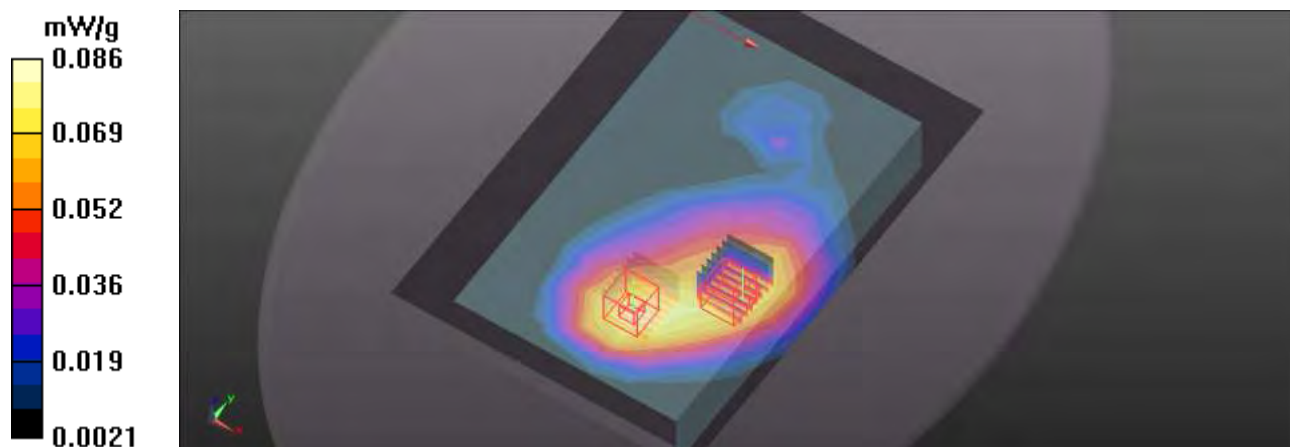



## M07-Bottom-EVDO850\_Rev.0-Ch384

### DUT: 7 Rugged Table PC ; Type: Algiz7

Communication System: EVDO 850 ; Frequency: 836.52 MHz ; Duty Cycle: 1:1 ; Modulation type: HPSK  
Medium: MSL835 Medium parameters used:  $f = 836.52$  MHz;  $\sigma = 0.98$  mho/m;  $\epsilon_r = 55.6$ ;  $\rho = 1000$  kg/m<sup>3</sup>  
Phantom section: Flat Section ; Separation distance : 0 mm (The Bottom side of the EUT to the Phantom)

#### DASY4 Configuration:

- Probe: EX3DV3 - SN3504 ; ConvF(9.83, 9.83, 9.83) ; Calibrated: 2010/1/26
- Sensor-Surface: 2mm (Mechanical Surface Detection)
- Electronics: DAE4 Sn861 ; Calibrated: 2010/1/22
- Phantom: Flat Phantom ELI4.0 ; Type: QDOVA001BB ; Serial: SN:1039
- Measurement SW: DASY4, V4.7 Build 80 ; Postprocessing SW: SEMCAD, V1.8 Build 186

### Mid Channel 384/Area Scan (11x15x1): Measurement grid: dx=15mm, dy=15mm

Maximum value of SAR (measured) = 0.097 mW/g

### Mid Channel 384/Zoom Scan (7x7x7)/Cube 0: Measurement grid: dx=5mm, dy=5mm, dz=5mm

Reference Value = 6.38 V/m; Power Drift = -0.160 dB

Peak SAR (extrapolated) = 0.103 W/kg

SAR(1 g) = **0.081 mW/g**; SAR(10 g) = 0.063 mW/g

Maximum value of SAR (measured) = 0.094 mW/g

### Mid Channel 384/Zoom Scan (7x7x7)/Cube 1: Measurement grid: dx=5mm, dy=5mm, dz=5mm

Reference Value = 6.38 V/m; Power Drift = -0.160 dB

Peak SAR (extrapolated) = 0.098 W/kg

SAR(1 g) = 0.074 mW/g; SAR(10 g) = 0.056 mW/g

Maximum value of SAR (measured) = 0.088 mW/g

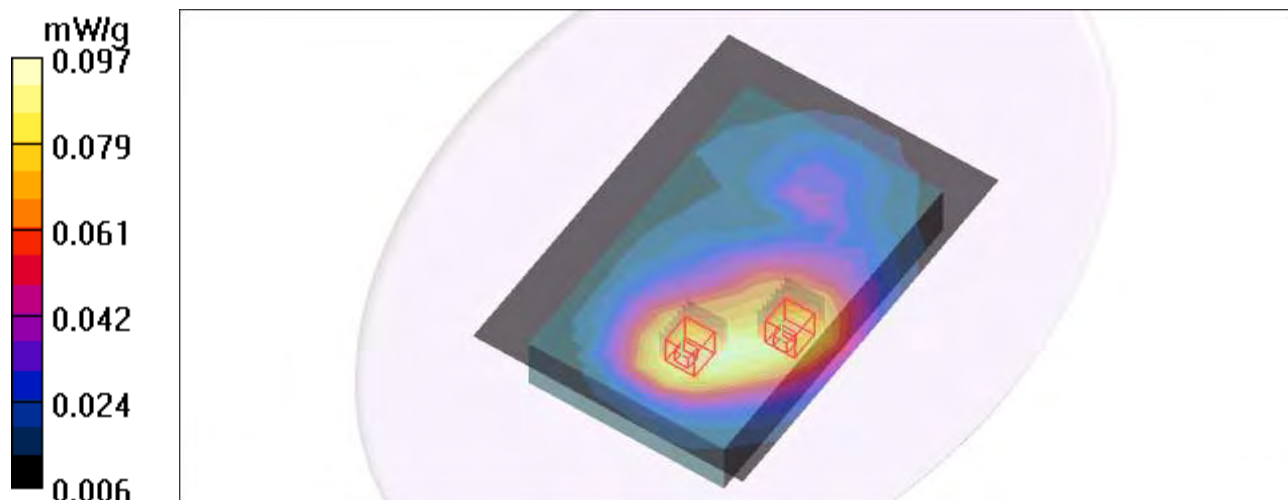

## M08-Edge-GPRS850 TS1

### DUT: 7 Rugged Table PC ; Type: Algiz7

Communication System: GPRS 850 ; Frequency: 836.6 MHz ; Duty Cycle: 1:8.3 ; Modulation type: GMSK  
Medium: MSL835 Medium parameters used:  $f = 836.6$  MHz;  $\sigma = 0.99$  mho/m;  $\epsilon_r = 55.5$ ;  $\rho = 1000$  kg/m<sup>3</sup>  
Phantom section: Flat Section ; Separation distance : 0 mm (The edge side of the EUT to the Phantom)

#### DASY4 Configuration:

- Probe: EX3DV3 - SN3504 ; ConvF(9.83, 9.83, 9.83) ; Calibrated: 2010/1/26
- Sensor-Surface: 2mm (Mechanical Surface Detection)
- Electronics: DAE4 Sn861 ; Calibrated: 2010/1/22
- Phantom: Flat Phantom ELI4.0 ; Type: QDOVA001BB ; Serial: SN:1039
- Measurement SW: DASY4, V4.7 Build 80 ; Postprocessing SW: SEMCAD, V1.8 Build 186

### Mid Channel 190/Area Scan (7x16x1): Measurement grid: dx=15 mm, dy=15mm

Maximum value of SAR (measured) = 0.012 mW/g

### Mid Channel 190/Zoom Scan (7x7x7)/Cube 0: Measurement grid: dx=5mm, dy=5mm, dz=5mm

Reference Value = 2.95 V/m; Power Drift = 0.165 dB

Peak SAR (extrapolated) = 0.020 W/kg

SAR(1 g) = **0.015 mW/g**; SAR(10 g) = **0.010 mW/g**

Maximum value of SAR (measured) = 0.017 mW/g

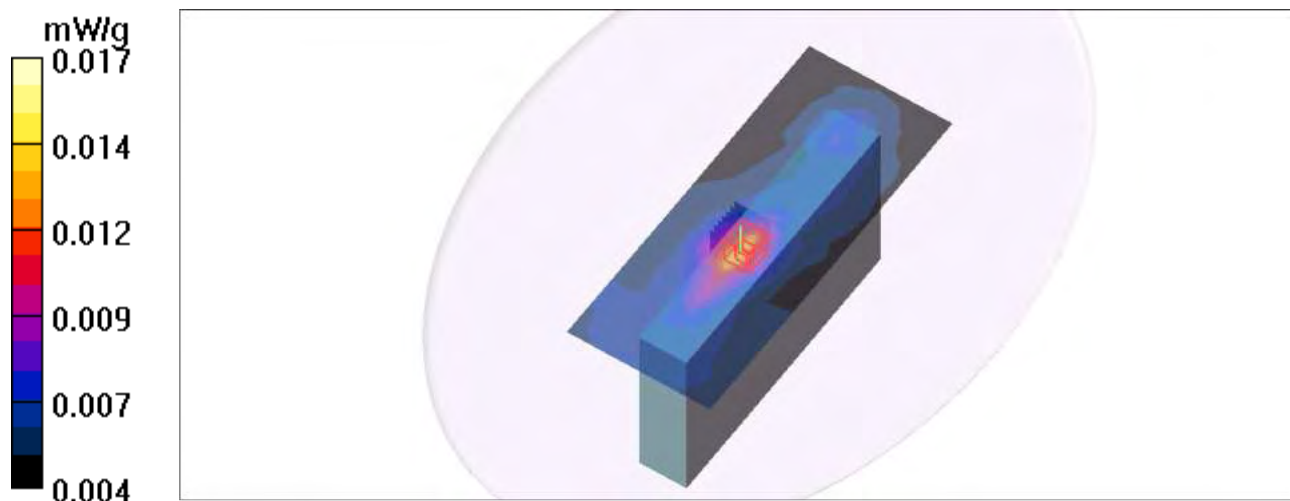

## M09-Edge-GPRS850 TS2

### DUT: 7 Rugged Table PC ; Type: Algiz7

Communication System: GPRS 850 ; Frequency: 836.6 MHz ; Duty Cycle: 1:4 ; Modulation type: GMSK  
Medium: MSL835 Medium parameters used:  $f = 836.6$  MHz;  $\sigma = 0.99$  mho/m;  $\epsilon_r = 55.5$ ;  $\rho = 1000$  kg/m<sup>3</sup>  
Phantom section: Flat Section ; Separation distance : 0 mm (The edge side of the EUT to the Phantom)

#### DASY4 Configuration:

- Probe: EX3DV3 - SN3504 ; ConvF(9.83, 9.83, 9.83) ; Calibrated: 2010/1/26
- Sensor-Surface: 2mm (Mechanical Surface Detection)
- Electronics: DAE4 Sn861 ; Calibrated: 2010/1/22
- Phantom: Flat Phantom ELI4.0 ; Type: QDOVA001BB ; Serial: SN:1039
- Measurement SW: DASY4, V4.7 Build 80 ; Postprocessing SW: SEMCAD, V1.8 Build 186

### Mid Channel 190/Area Scan (7x16x1): Measurement grid: dx=15 mm, dy=15mm

Maximum value of SAR (measured) = 0.025 mW/g

### Mid Channel 190/Zoom Scan (7x7x7)/Cube 0: Measurement grid: dx=5mm, dy=5mm, dz=5mm

Reference Value = 4.41 V/m; Power Drift = -0.080 dB

Peak SAR (extrapolated) = 0.057 W/kg

SAR(1 g) = **0.023** mW/g; SAR(10 g) = 0.011 mW/g

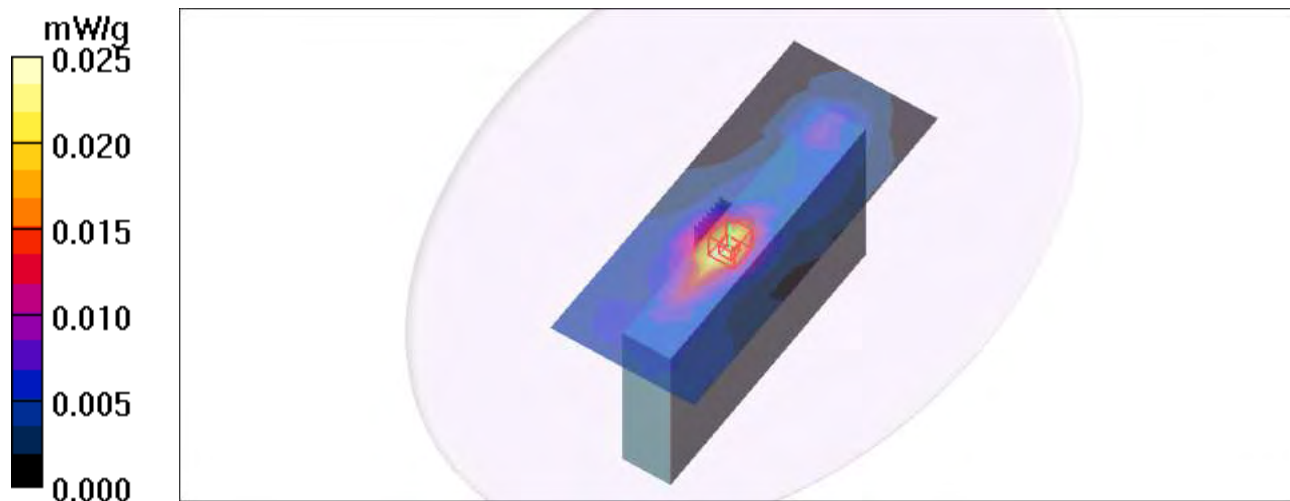

## M10-Edge-E-GPRS850 TS1

### DUT: 7 Rugged Table PC ; Type: Algiz7

Communication System: E-GPRS 850 ; Frequency: 836.6 MHz ; Duty Cycle: 1:8.3 ; Modulation type: 8PSK  
Medium: MSL835 Medium parameters used:  $f = 836.6$  MHz;  $\sigma = 0.99$  mho/m;  $\epsilon_r = 55.5$ ;  $\rho = 1000$  kg/m<sup>3</sup>  
Phantom section: Flat Section ; Separation distance : 0 mm (The edge side of the EUT to the Phantom)

#### DASY4 Configuration:

- Probe: EX3DV3 - SN3504 ; ConvF(9.83, 9.83, 9.83) ; Calibrated: 2010/1/26
- Sensor-Surface: 2mm (Mechanical Surface Detection)
- Electronics: DAE4 Sn861 ; Calibrated: 2010/1/22
- Phantom: Flat Phantom ELI4.0 ; Type: QDOVA001BB ; Serial: SN:1039
- Measurement SW: DASY4, V4.7 Build 80 ; Postprocessing SW: SEMCAD, V1.8 Build 186

### Mid Channel 190/Area Scan (7x16x1): Measurement grid: dx=15 mm, dy=15mm

Maximum value of SAR (measured) = 0.005 mW/g

### Mid Channel 190/Zoom Scan (7x7x7)/Cube 0: Measurement grid: dx=5mm, dy=5mm, dz=5mm

Reference Value = 2.43 V/m; Power Drift = 0.170 dB

Peak SAR (extrapolated) = 0.010 W/kg

SAR(1 g) = **0.00739 mW/g**; SAR(10 g) = **0.00647 mW/g**

Maximum value of SAR (measured) = 0.008 mW/g

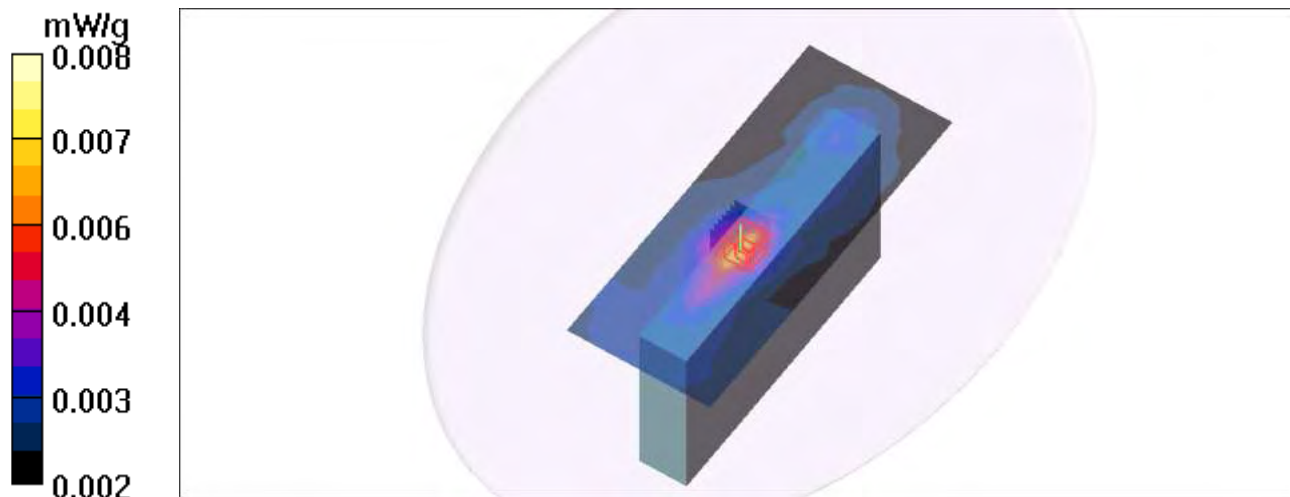

## M11-Edge-E-GPRS850 TS2

### DUT: 7 Rugged Table PC ; Type: Algiz7

Communication System: E-GPRS 850 ; Frequency: 836.6 MHz ; Duty Cycle: 1:4 ; Modulation type: 8PSK  
Medium: MSL835 Medium parameters used:  $f = 836.6$  MHz;  $\sigma = 0.99$  mho/m;  $\epsilon_r = 55.5$ ;  $\rho = 1000$  kg/m<sup>3</sup>  
Phantom section: Flat Section ; Separation distance : 0 mm (The edge side of the EUT to the Phantom)

#### DASY4 Configuration:

- Probe: EX3DV3 - SN3504 ; ConvF(9.83, 9.83, 9.83) ; Calibrated: 2010/1/26
- Sensor-Surface: 2mm (Mechanical Surface Detection)
- Electronics: DAE4 Sn861 ; Calibrated: 2010/1/22
- Phantom: Flat Phantom ELI4.0 ; Type: QDOVA001BB ; Serial: SN:1039
- Measurement SW: DASY4, V4.7 Build 80 ; Postprocessing SW: SEMCAD, V1.8 Build 186

### Mid Channel 190/Area Scan (7x16x1): Measurement grid: dx=15 mm, dy=15mm

Maximum value of SAR (measured) = 0.012 mW/g

### Mid Channel 190/Zoom Scan (7x7x7)/Cube 0: Measurement grid: dx=5mm, dy=5mm, dz=5mm

Reference Value = 3.13 V/m; Power Drift = -0.186 dB

Peak SAR (extrapolated) = 0.024 W/kg

SAR(1 g) = **0.011 mW/g**; SAR(10 g) = **0.00827 mW/g**

Maximum value of SAR (measured) = 0.013 mW/g

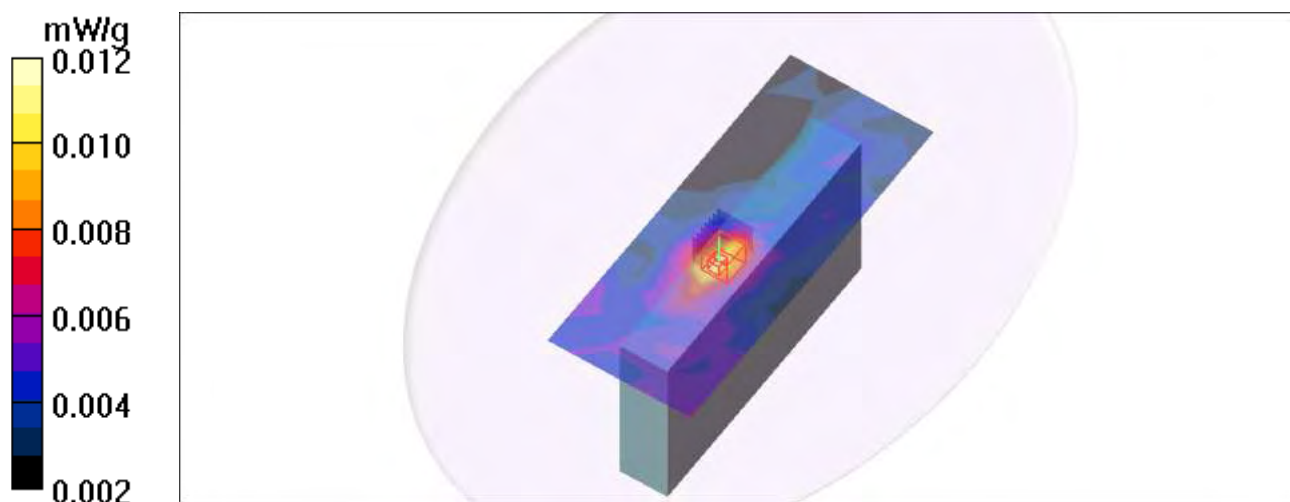

## M12- Edge WCDMA850-Ch4182

Communication System: WCDMA850 ; Frequency: 836.4 MHz ; Duty Cycle: 1:1 ; Modulation type: BPSK

Medium: MSL835 Medium parameters used:  $f = 836.4$  MHz;  $\sigma = 0.98$  mho/m;  $\epsilon_r = 56.05$ ;  $\rho = 1000$  kg/m<sup>3</sup>

Phantom section: Flat Section ; Separation distance : 0 mm (The edge side of the EUT to the Phantom)

DASY4 Configuration:

- Probe: EX3DV4 - SN3650; ConvF(9.12, 9.12, 9.12); Calibrated: 2011/1/24
- Sensor-Surface: 2mm (Mechanical Surface Detection)
- Electronics: DAE3 Sn579; Calibrated: 2010/9/20
- Phantom: Flat Phantom ELI4.0; Type: QDOVA001BA; Serial: SN:1039
- Measurement SW: DASY4, Version 4.7 (80); SEMCAD X Version 14.4.2 (2595)

**Mid Channel 4182/Area Scan (7x16x1):** Measurement grid: dx=15mm, dy=15mm

Maximum value of SAR (measured) = 0.012 mW/g

**Mid Channel 4182/Zoom Scan (7x7x7)/Cube 0:** Measurement grid: dx=5mm, dy=5mm, dz=5mm

Reference Value = 4.526 V/m; Power Drift = -0.11 dB

Peak SAR (extrapolated) = 0.013 W/kg

**SAR(1 g) = 0.00986 mW/g; SAR(10 g) = 0.0083 mW/g**

Maximum value of SAR (measured) = 0.012 mW/g

**Mid Channel 4182/Zoom Scan (7x7x7)/Cube 1:** Measurement grid: dx=5mm, dy=5mm, dz=5mm

Reference Value = 4.526 V/m; Power Drift = -0.11 dB

Peak SAR (extrapolated) = 0.00922 W/kg

**SAR(1 g) = 0.00741 mW/g; SAR(10 g) = 0.00624 mW/g**

Maximum value of SAR (measured) = 0.00913 mW/g

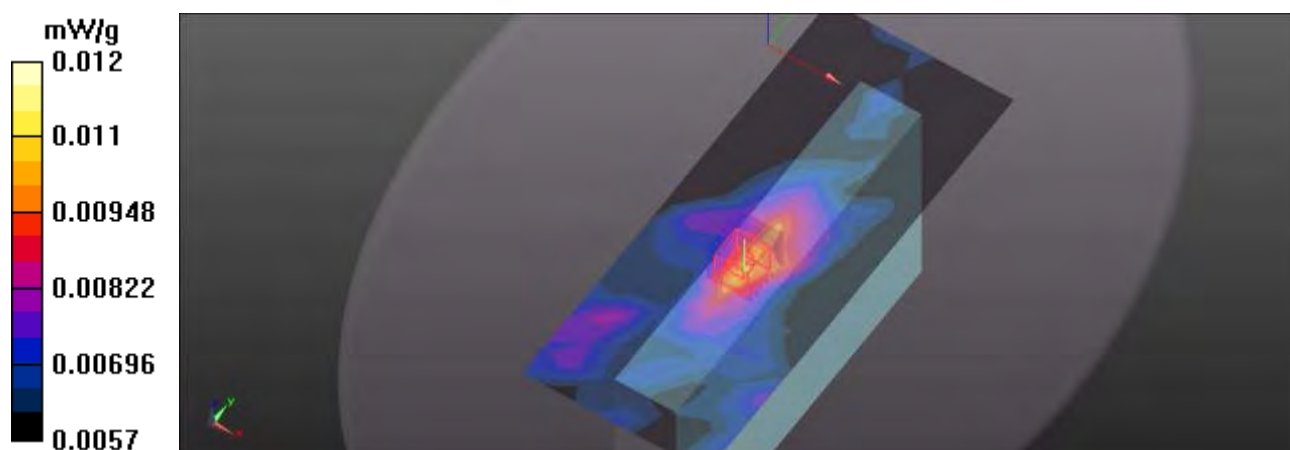

### M13- Edge CDMA850-Ch384

Communication System: CDMA850 ; Frequency: 836.52 MHz ; Duty Cycle: 1:1 ; Modulation type: OQPSK

Medium: MSL835 Medium parameters used:  $f = 836.52$  MHz;  $\sigma = 0.98$  mho/m;  $\epsilon_r = 56.05$ ;  $\rho = 1000$  kg/m<sup>3</sup>

Phantom section: Flat Section ; Separation distance : 0 mm (The edge side of the EUT to the Phantom)

DASY4 Configuration:

- Probe: EX3DV4 - SN3650; ConvF(9.12, 9.12, 9.12); Calibrated: 2011/1/24
- Sensor-Surface: 2mm (Mechanical Surface Detection)
- Electronics: DAE3 Sn579; Calibrated: 2010/9/20
- Phantom: Flat Phantom ELI4.0; Type: QDOVA001BA; Serial: SN:1039
- Measurement SW: DASY4, Version 4.7 (80); SEMCAD X Version 14.4.2 (2595)

**Mid Channel 384/Area Scan (7x16x1):** Measurement grid: dx=15mm, dy=15mm

Maximum value of SAR (measured) = 0.0096 mW/g

**Mid Channel 384/Zoom Scan (7x7x7)/Cube 0:** Measurement grid: dx=5mm, dy=5mm, dz=5mm

Reference Value = 4.248 V/m; Power Drift = 0.14 dB

Peak SAR (extrapolated) = 0.014 W/kg

**SAR(1 g) = 0.0092 mW/g; SAR(10 g) = 0.0082 mW/g**

Maximum value of SAR (measured) = 0.012 mW/g

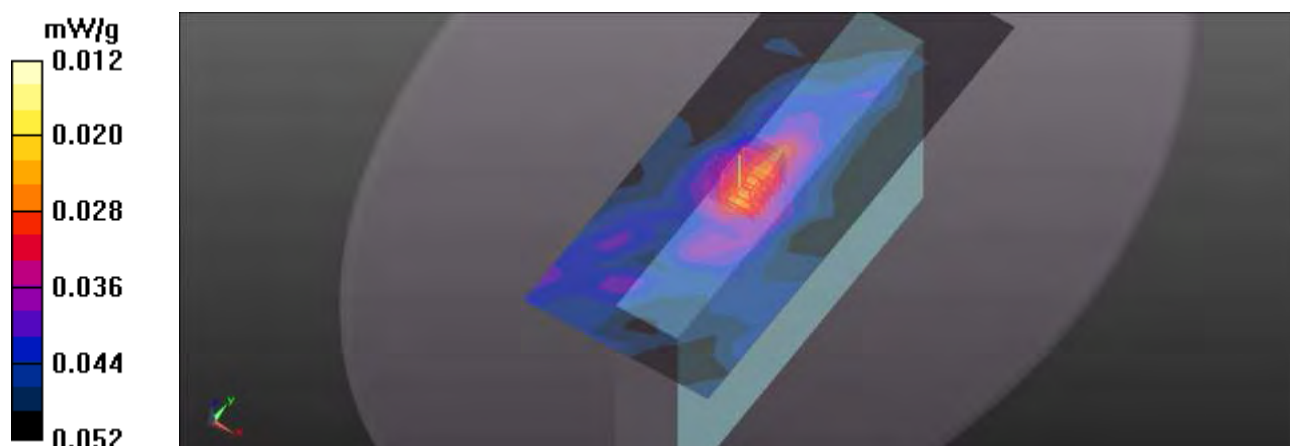

## M14-Edge-EVDO850\_Rev.0-Ch384

### DUT: 7 Rugged Table PC ; Type: Algiz7

Communication System: EVDO 850 ; Frequency: 836.52 MHz ; Duty Cycle: 1:1 ; Modulation type: HPSK  
Medium: MSL835 Medium parameters used:  $f = 836.52$  MHz;  $\sigma = 0.98$  mho/m;  $\epsilon_r = 55.6$ ;  $\rho = 1000$  kg/m<sup>3</sup>  
Phantom section: Flat Section ; Separation distance : 0 mm (The edge side of the EUT to the Phantom)

#### DASY4 Configuration:

- Probe: EX3DV3 - SN3504 ; ConvF(9.83, 9.83, 9.83) ; Calibrated: 2010/1/26
- Sensor-Surface: 2mm (Mechanical Surface Detection)
- Electronics: DAE4 Sn861 ; Calibrated: 2010/1/22
- Phantom: Flat Phantom ELI4.0 ; Type: QDOVA001BB ; Serial: SN:1039
- Measurement SW: DASY4, V4.7 Build 80 ; Postprocessing SW: SEMCAD, V1.8 Build 186

### Mid Channel 384/Area Scan (7x16x1): Measurement grid: dx=15 mm, dy=15mm

Maximum value of SAR (measured) = 0.012 mW/g

### Mid Channel 384/Zoom Scan (7x7x7)/Cube 0: Measurement grid: dx=5mm, dy=5mm, dz=5mm

Reference Value = 3.74 V/m; Power Drift = 0.140 dB

Peak SAR (extrapolated) = 0.018 W/kg

SAR(1 g) = **0.012 mW/g**; SAR(10 g) = 0.010 mW/g

Maximum value of SAR (measured) = 0.015 mW/g

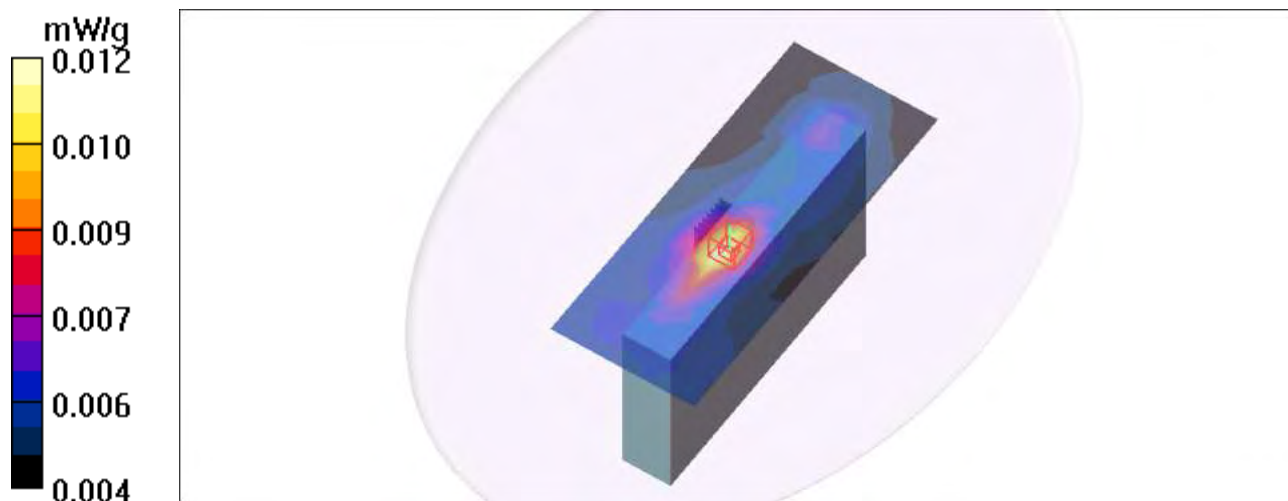



## M15- Bottom GPRS1900 TS1-Ch661

Communication System: GPRS1900 ; Frequency: 1880 MHz ; Duty Cycle: 1:8.30042 ; Modulation type: GMSK / UL 1 time slot

Medium: MSL1900 Medium parameters used:  $f = 1880$  MHz;  $\sigma = 1.56$  mho/m;  $\epsilon_r = 55.13$ ;  $\rho = 1000$  kg/m<sup>3</sup>

Phantom section: Flat Section ; Separation distance : 0 mm (The bottom side of the EUT to the Phantom)

DASY4 Configuration:

- Probe: EX3DV4 - SN3650; ConvF(7.52, 7.52, 7.52); Calibrated: 2011/1/24
- Sensor-Surface: 2mm (Mechanical Surface Detection)
- Electronics: DAE3 Sn579; Calibrated: 2010/9/20
- Phantom: ELI 4.0; Type: QDOVA001BA;Serial: 1039
- Measurement SW: DASY4, Version 4.7 (80); SEMCAD X Version 14.4.2 (2595)

**Flat-Section MSL/Flat Section 0mm/Area Scan (14x19x1):** Measurement grid: dx=15mm, dy=15mm

Maximum value of SAR (measured) = 0.156 mW/g

**Flat-Section MSL/Flat Section 0mm/Zoom Scan (5x5x7)/Cube 0:** Measurement grid: dx=8mm, dy=8mm, dz=5mm

Reference Value = 3.322 V/m; Power Drift = -0.01 dB

Peak SAR (extrapolated) = 0.203 W/kg

**SAR(1 g) = 0.125 mW/g; SAR(10 g) = 0.076 mW/g**

Maximum value of SAR (measured) = 0.164 mW/g

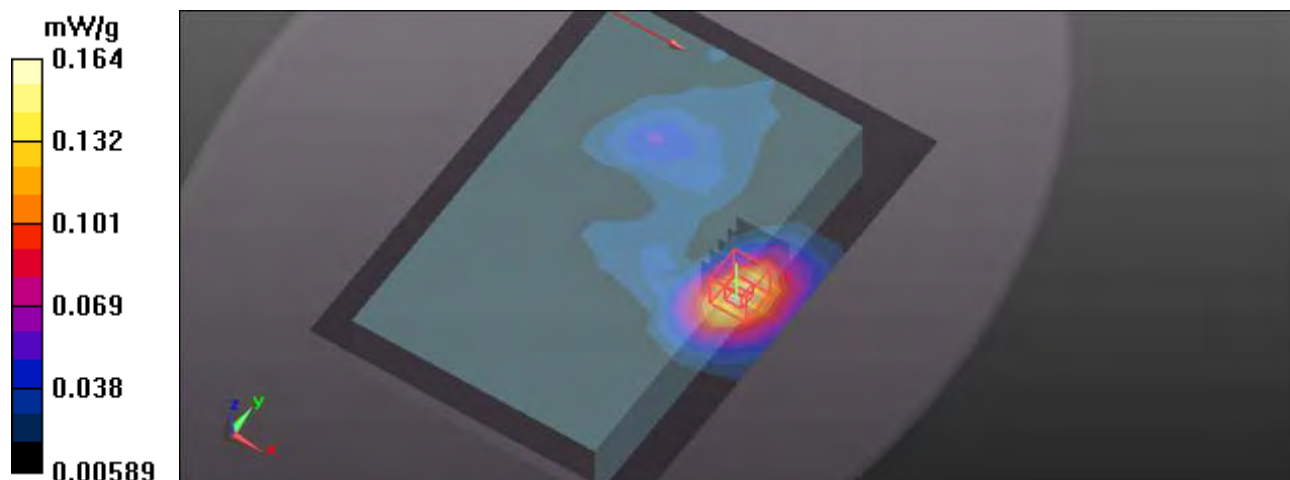

## M16- Bottom GRPS1900 TS2-Ch661

Communication System: GPRS 1900 ; Frequency: 1880 MHz ; Duty Cycle: 1:4.00037 ; Modulation type: GMSK / UL 2 time slots

Medium: MSL1900 Medium parameters used:  $f = 1880$  MHz;  $\sigma = 1.56$  mho/m;  $\epsilon_r = 55.13$ ;  $\rho = 1000$  kg/m<sup>3</sup>

Phantom section: Flat Section ; Separation distance : 0 mm (The bottom side of the EUT to the Phantom)

DASY4 Configuration:

- Probe: EX3DV4 - SN3650; ConvF(7.52, 7.52, 7.52); Calibrated: 2011/1/24
- Sensor-Surface: 2mm (Mechanical Surface Detection)
- Electronics: DAE3 Sn579; Calibrated: 2010/9/20
- Phantom: ELI 4.0; Type: QDOVA001BA; Serial: 1039
- Measurement SW: DASY4, Version 4.7 (80); SEMCAD X Version 14.4.2 (2595)

**Flat-Section MSL/Flat Section 0mm/Area Scan (14x19x1):** Measurement grid: dx=15mm, dy=15mm

Maximum value of SAR (measured) = 0.329 mW/g

**Flat-Section MSL/Flat Section 0mm/Zoom Scan (5x5x7)/Cube 0:** Measurement grid: dx=8mm, dy=8mm, dz=5mm

Reference Value = 4.399 V/m; Power Drift = -0.13 dB

Peak SAR (extrapolated) = 0.407 W/kg

**SAR(1 g) = 0.249 mW/g; SAR(10 g) = 0.149 mW/g**

Maximum value of SAR (measured) = 0.330 mW/g

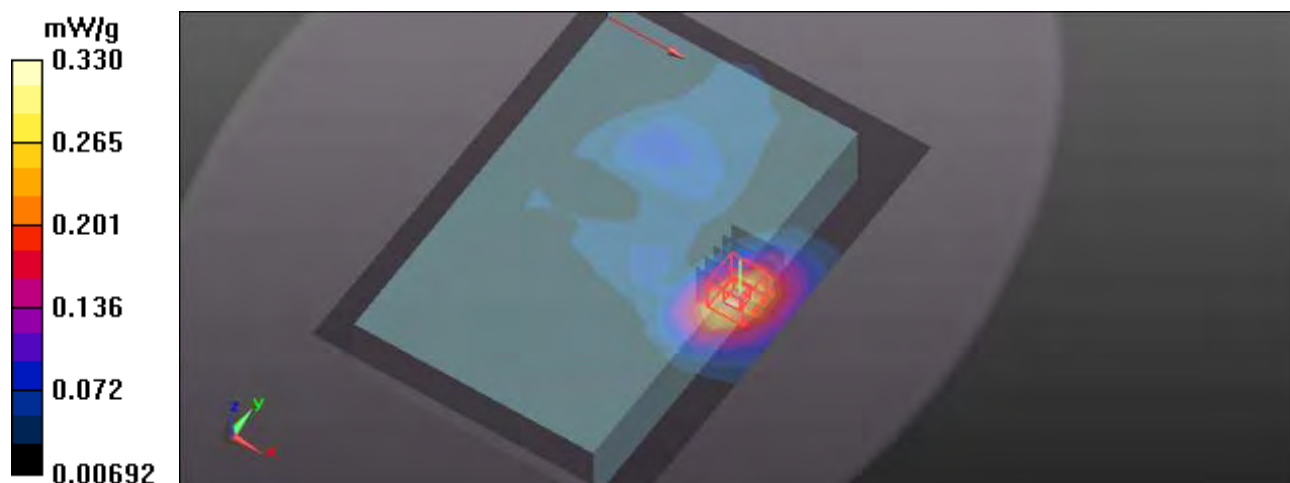

## M17- Bottom E-GPRS1900 TS1-Ch661

Communication System: E-GPRS 1900 ; Frequency: 1880 MHz ; Duty Cycle: 1:8.30042 ; Modulation type: 8PSK / UL 1 time slot

Medium: MSL1900 Medium parameters used:  $f = 1880$  MHz;  $\sigma = 1.56$  mho/m;  $\epsilon_r = 55.13$ ;  $\rho = 1000$  kg/m<sup>3</sup>

Phantom section: Flat Section ; Separation distance : 0 mm (The bottom side of the EUT to the Phantom)

DASY4 Configuration:

- Probe: EX3DV4 - SN3650; ConvF(7.52, 7.52, 7.52); Calibrated: 2011/1/24
- Sensor-Surface: 2mm (Mechanical Surface Detection)
- Electronics: DAE3 Sn579; Calibrated: 2010/9/20
- Phantom: ELI 4.0; Type: QDOVA001BA; Serial: 1039
- Measurement SW: DASY4, Version 4.7 (80); SEMCAD X Version 14.4.2 (2595)

**Flat-Section MSL/Flat Section 0mm/Area Scan (14x19x1):** Measurement grid: dx=15mm, dy=15mm

Maximum value of SAR (measured) = 0.073 mW/g

**Flat-Section MSL/Flat Section 0mm/Zoom Scan (5x5x7)/Cube 0:** Measurement grid: dx=8mm, dy=8mm, dz=5mm

Reference Value = 1.075 V/m; Power Drift = 0.17 dB

Peak SAR (extrapolated) = 0.093 W/kg

**SAR(1 g) = 0.057 mW/g; SAR(10 g) = 0.035 mW/g**

Maximum value of SAR (measured) = 0.074 mW/g

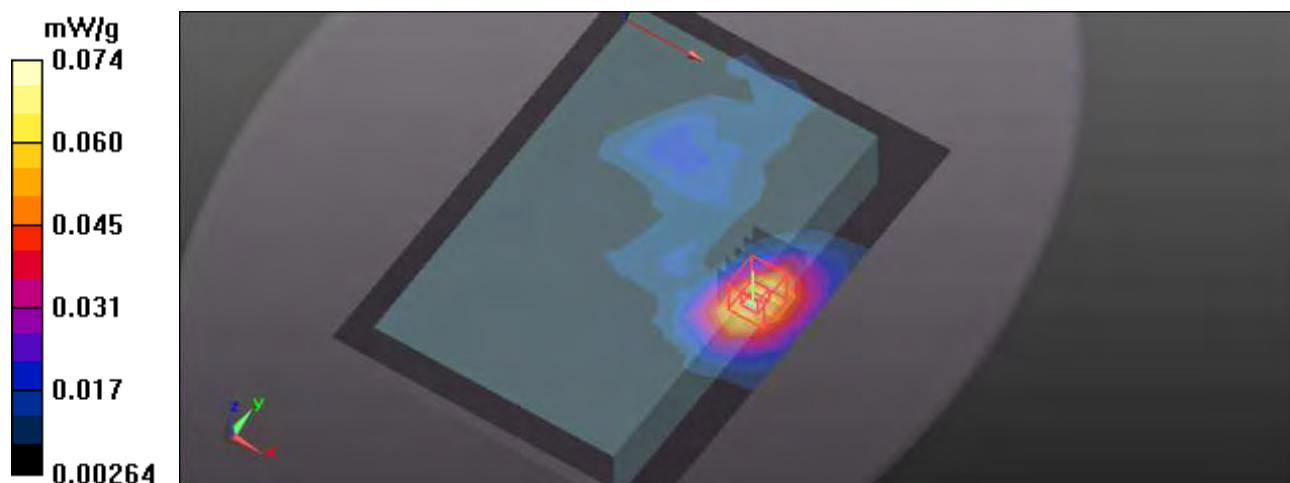

## M118- Bottom E-GRPS1900 TS2-Ch661

Communication System: E-GPRS 1900 ; Frequency: 1880 MHz ; Duty Cycle: 1:4.00037 ; Modulation type: 8PSK / UL 2 time slots

Medium: MSL1900 Medium parameters used:  $f = 1880$  MHz;  $\sigma = 1.56$  mho/m;  $\epsilon_r = 55.13$ ;  $\rho = 1000$  kg/m<sup>3</sup>

Phantom section: Flat Section ; Separation distance :0 mm (The bottom side of the EUT to the Phantom)

DASY4 Configuration:

- Probe: EX3DV4 - SN3650; ConvF(7.52, 7.52, 7.52); Calibrated: 2011/1/24
- Sensor-Surface: 2mm (Mechanical Surface Detection)
- Electronics: DAE3 Sn579; Calibrated: 2010/9/20
- Phantom: ELI 4.0; Type: QDOVA001BA;Serial: 1039
- Measurement SW: DASY4, Version 4.7 (80); SEMCAD X Version 14.4.2 (2595)

**Flat-Section MSL/Flat Section 0mm/Area Scan (14x19x1):** Measurement grid: dx=15mm, dy=15mm

Maximum value of SAR (measured) = 0.146 mW/g

**Flat-Section MSL/Flat Section 0mm/Zoom Scan (5x5x7)/Cube 0:** Measurement grid: dx=8mm, dy=8mm, dz=5mm

Reference Value = 3.231 V/m; Power Drift = -0.16 dB

Peak SAR (extrapolated) = 0.183 W/kg

**SAR(1 g) = 0.112 mW/g; SAR(10 g) = 0.067 mW/g**

Maximum value of SAR (measured) = 0.148 mW/g

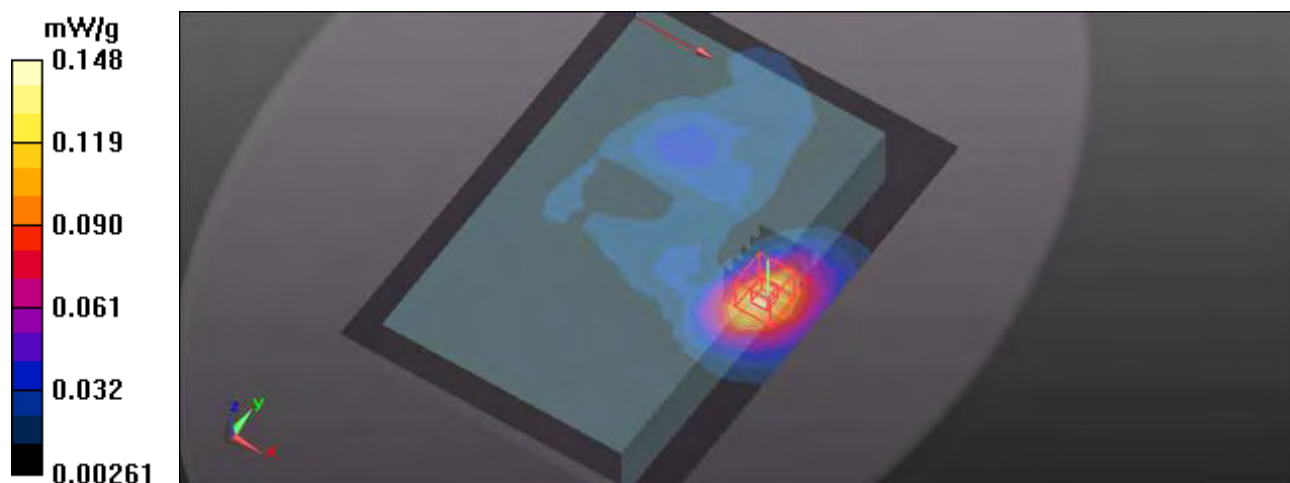

## M19- Bottom WCDMA1900-Ch9400

Communication System: WCDMA1900 ; Frequency: 1880 MHz ; Duty Cycle: 1:1 ; Modulation type: BPSK

Medium: MSL1900 Medium parameters used:  $f = 1880$  MHz;  $\sigma = 1.56$  mho/m;  $\epsilon_r = 55.13$ ;  $\rho = 1000$  kg/m<sup>3</sup>

Phantom section: Flat Section ; Separation distance : 0 mm (The bottom side of the EUT to the Phantom)

DASY4 Configuration:

- Probe: EX3DV4 - SN3650; ConvF(7.52, 7.52, 7.52); Calibrated: 2011/1/24
- Sensor-Surface: 2mm (Mechanical Surface Detection)
- Electronics: DAE3 Sn579; Calibrated: 2010/9/20
- Phantom: ELI 4.0; Type: QDOVA001BA; Serial: 1039
- Measurement SW: DASY4, Version 4.7 (80); SEMCAD X Version 14.4.2 (2595)

**Flat-Section MSL/Flat Section 0mm/Area Scan (14x19x1):** Measurement grid: dx=15mm, dy=15mm

Maximum value of SAR (measured) = 0.335 mW/g

**Flat-Section MSL/Flat Section 0mm/Zoom Scan (7x7x7)/Cube 0:** Measurement grid: dx=5mm, dy=5mm, dz=5mm

Reference Value = 5.136 V/m; Power Drift = -0.01 dB

Peak SAR (extrapolated) = 0.849 W/kg

**SAR(1 g) = 0.295 mW/g; SAR(10 g) = 0.164 mW/g**

Maximum value of SAR (measured) = 0.462 mW/g

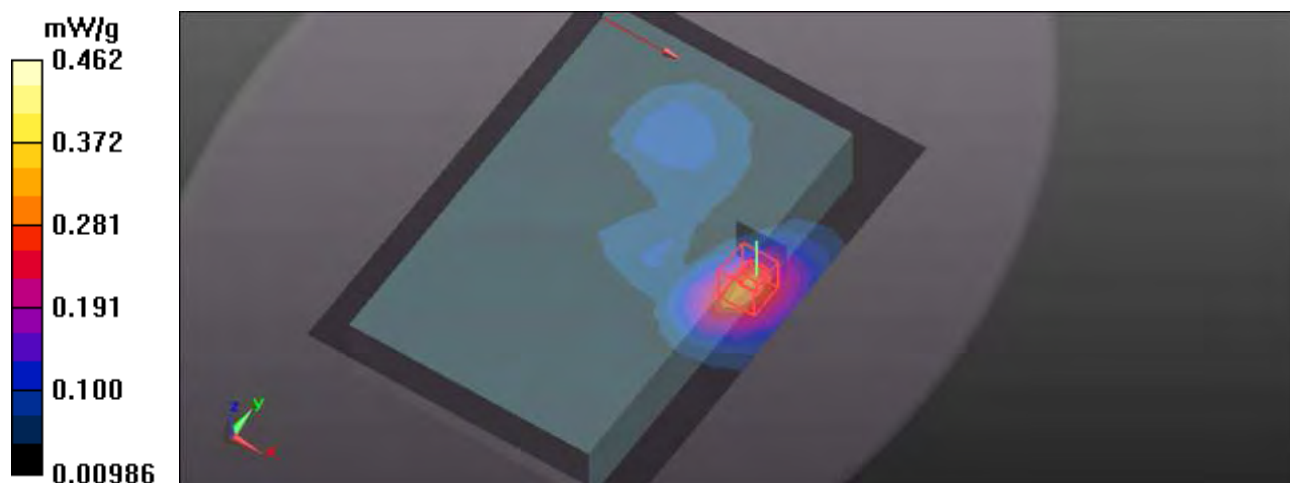

## M20-Bottom CDMA1900-Ch600

Communication System: CDMA ; Frequency: 1880 MHz ; Duty Cycle: 1:1 ; Modulation type: OQPSK  
Medium: MSL1900 Medium parameters used:  $f = 1880$  MHz;  $\sigma = 1.56$  mho/m;  $\epsilon_r = 55.13$ ;  $\rho = 1000$  kg/m<sup>3</sup>

Phantom section: Flat Section ; Separation distance : 0 mm (The bottom side of the EUT to the Phantom)

DASY4 Configuration:

- Probe: EX3DV4 - SN3650; ConvF(7.52, 7.52, 7.52); Calibrated: 2011/1/24
- Sensor-Surface: 2mm (Mechanical Surface Detection)
- Electronics: DAE3 Sn579; Calibrated: 2010/9/20
- Phantom: ELI 4.0; Type: QDOVA001BA;Serial: 1039
- Measurement SW: DASY4, Version 4.7 (80); SEMCAD X Version 14.4.2 (2595)

**Flat-Section MSL/Flat Section 0mm/Area Scan (14x19x1):** Measurement grid: dx=15mm, dy=15mm

Maximum value of SAR (measured) = 0.406 mW/g

**Flat-Section MSL/Flat Section 0mm/Zoom Scan (5x5x7)/Cube 0:** Measurement grid: dx=8mm, dy=8mm, dz=5mm

Reference Value = 4.818 V/m; Power Drift = 0.12 dB

Peak SAR (extrapolated) = 0.497 W/kg

**SAR(1 g) = 0.306 mW/g; SAR(10 g) = 0.184 mW/g**

Maximum value of SAR (measured) = 0.399 mW/g

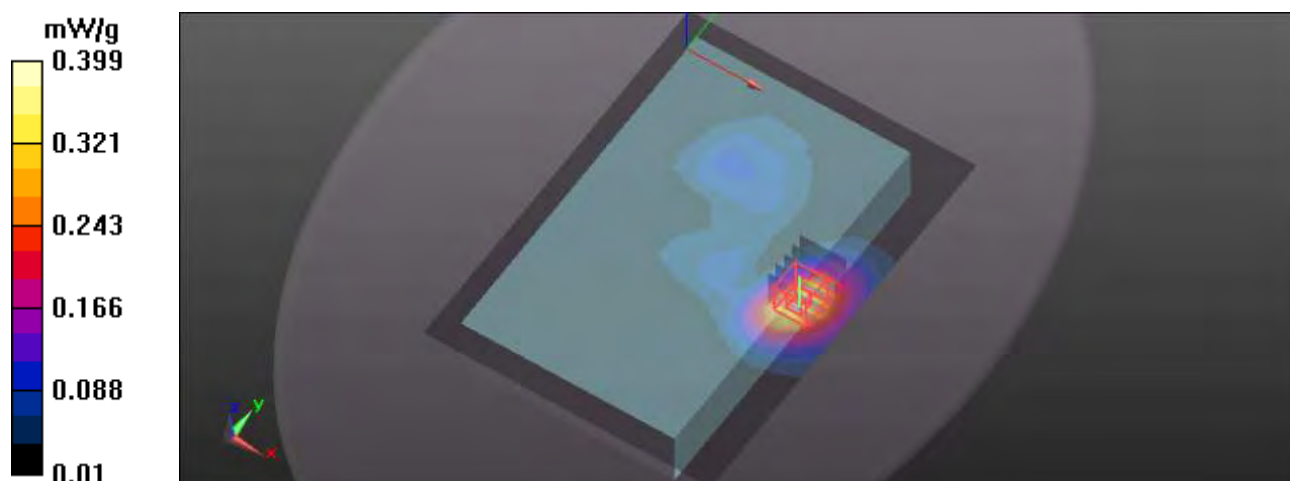

## M21- Bottom EVDO1900\_Rev.0-Ch600

Communication System: CDMA ; Frequency: 1880 MHz ; Duty Cycle: 1:1 ; Modulation type: HPSK  
Medium: MSL1900 Medium parameters used:  $f = 1880$  MHz;  $\sigma = 1.56$  mho/m;  $\epsilon_r = 55.13$ ;  $\rho = 1000$  kg/m<sup>3</sup>

Phantom section: Flat Section ; Separation distance : 0 mm (The bottom side of the EUT to the Phantom)

DASY4 Configuration:

- Probe: EX3DV4 - SN3650; ConvF(7.52, 7.52, 7.52); Calibrated: 2011/1/24
- Sensor-Surface: 2mm (Mechanical Surface Detection)
- Electronics: DAE3 Sn579; Calibrated: 2010/9/20
- Phantom: ELI 4.0; Type: QDOVA001BA;Serial: 1039
- Measurement SW: DASY4, Version 4.7 (80); SEMCAD X Version 14.4.2 (2595)

**Flat-Section MSL/Flat Section 0mm/Area Scan (14x19x1):** Measurement grid: dx=15mm, dy=15mm

Maximum value of SAR (measured) = 0.408 mW/g

**Flat-Section MSL/Flat Section 0mm/Zoom Scan (5x5x7)/Cube 0:** Measurement grid: dx=8mm, dy=8mm, dz=5mm

Reference Value = 4.625 V/m; Power Drift = 0.15 dB

Peak SAR (extrapolated) = 0.503 W/kg

**SAR(1 g) = 0.306 mW/g; SAR(10 g) = 0.183 mW/g**

Maximum value of SAR (measured) = 0.398 mW/g

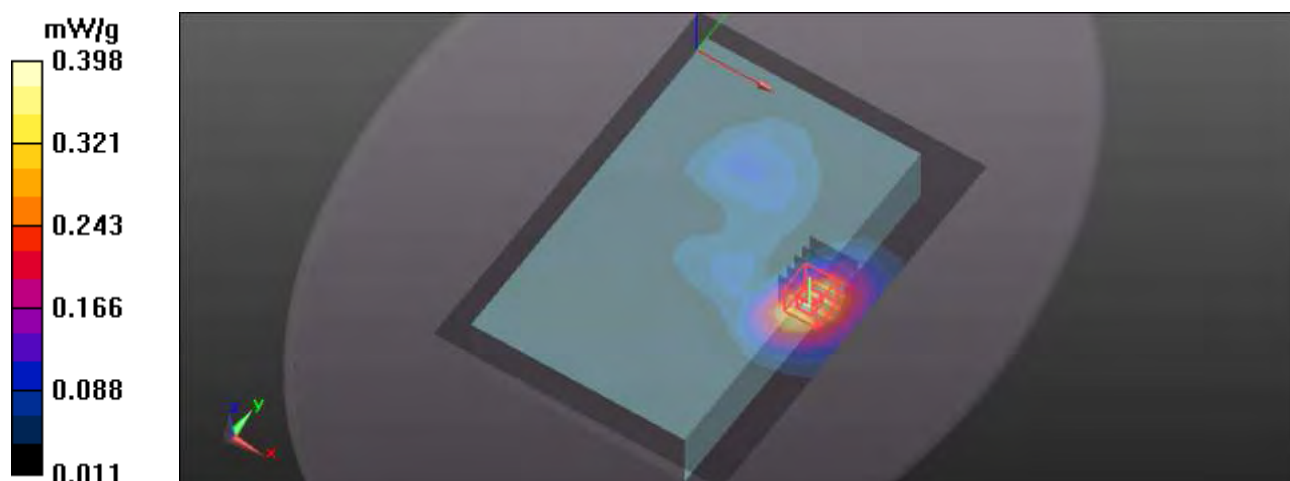

## M22-Edge GPRS1900 TS1-Ch661

Communication System: GPRS 1900 ; Frequency: 1880 MHz ; Duty Cycle: 1:1 ; Modulation type: GMSK / UL 1 time slot

Medium: MSL1900 Medium parameters used:  $f = 1880$  MHz;  $\sigma = 1.56$  mho/m;  $\epsilon_r = 55.13$ ;  $\rho = 1000$  kg/m<sup>3</sup>

Phantom section: Flat Section ; Separation distance : 0 mm (The edge side of the EUT to the Phantom)

DASY4 Configuration:

- Probe: EX3DV4 - SN3650; ConvF(7.52, 7.52, 7.52); Calibrated: 2011/1/24
- Sensor-Surface: 2mm (Mechanical Surface Detection)
- Electronics: DAE3 Sn579; Calibrated: 2010/9/20
- Phantom: ELI 4.0; Type: QDOVA001BA;Serial: 1039
- Measurement SW: DASY4, Version 4.7 (80); SEMCAD X Version 14.4.2 (2595)

**Flat-Section MSL/Flat Section 0mm/Area Scan (8x19x1):** Measurement grid: dx=15mm, dy=15mm

Maximum value of SAR (measured) = 0.00833 mW/g

**Flat-Section MSL/Flat Section 0mm/Zoom Scan (5x5x7)/Cube 0:** Measurement grid: dx=8mm, dy=8mm, dz=5mm

Reference Value = 0 V/m; Power Drift = 0.10 dB

Peak SAR (extrapolated) = 0.012 W/kg

**SAR(1 g) = 0.00482 mW/g; SAR(10 g) = 0.00273 mW/g**

Maximum value of SAR (measured) = 0.00752 mW/g

**Flat-Section MSL/Flat Section 0mm/Zoom Scan (5x5x7)/Cube 1:** Measurement grid: dx=8mm, dy=8mm, dz=5mm

Reference Value = 0 V/m; Power Drift = 0.10 dB

Peak SAR (extrapolated) = 0.00615 W/kg

**SAR(1 g) = 0.00358 mW/g; SAR(10 g) = 0.00245 mW/g**

Maximum value of SAR (measured) = 0.00521 mW/g

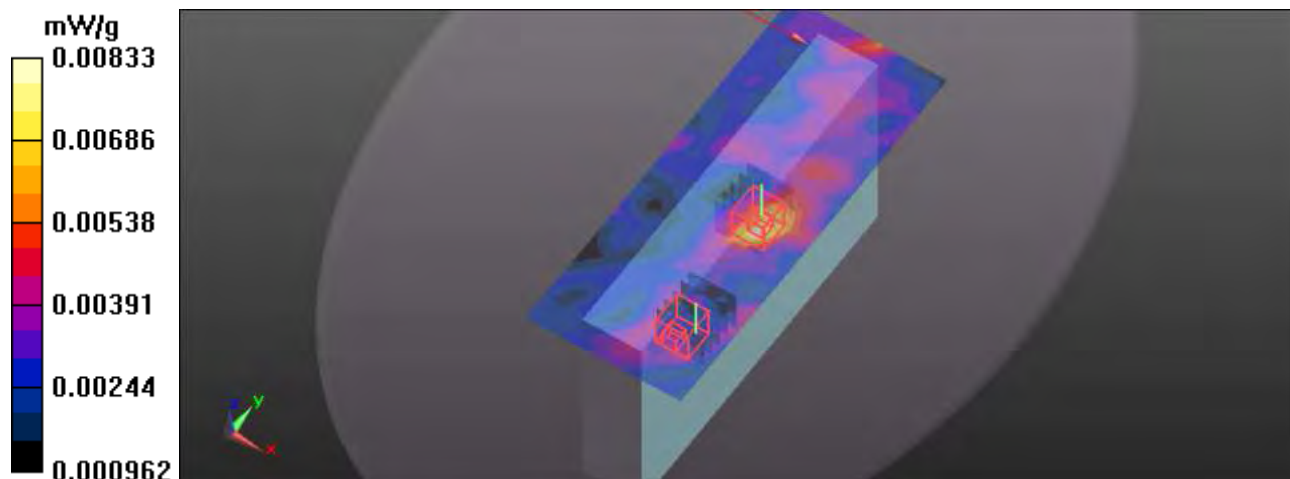



### M23- Edge GPRS1900 TS2-Ch661

Communication System: GPRS 1900 ; Frequency: 1880 MHz ; Duty Cycle: 1:1 ; Modulation type: GMSK / UL 2 time slots

Medium: MSL1900 Medium parameters used:  $f = 1880$  MHz;  $\sigma = 1.56$  mho/m;  $\epsilon_r = 55.13$ ;  $\rho = 1000$  kg/m<sup>3</sup>

Phantom section: Flat Section ; Separation distance : 0 mm (The edge side of the EUT to the Phantom)

DASY4 Configuration:

- Probe: EX3DV4 - SN3650; ConvF(7.52, 7.52, 7.52); Calibrated: 2011/1/24
- Sensor-Surface: 2mm (Mechanical Surface Detection)
- Electronics: DAE3 Sn579; Calibrated: 2010/9/20
- Phantom: ELI 4.0; Type: QDOVA001BA; Serial: 1039
- Measurement SW: DASY4, Version 4.7 (80); SEMCAD X Version 14.4.2 (2595)

**Flat-Section MSL/Flat Section 0mm/Area Scan (8x19x1):** Measurement grid: dx=15mm, dy=15mm

Maximum value of SAR (measured) = 0.013 mW/g

**Flat-Section MSL/Flat Section 0mm/Zoom Scan (5x5x7)/Cube 0:** Measurement grid: dx=8mm, dy=8mm, dz=5mm

Reference Value = 0.710 V/m; Power Drift = -0.13 dB

Peak SAR (extrapolated) = 0.038 W/kg

**SAR(1 g) = 0.011 mW/g; SAR(10 g) = 0.00701 mW/g**

Maximum value of SAR (measured) = 0.014 mW/g

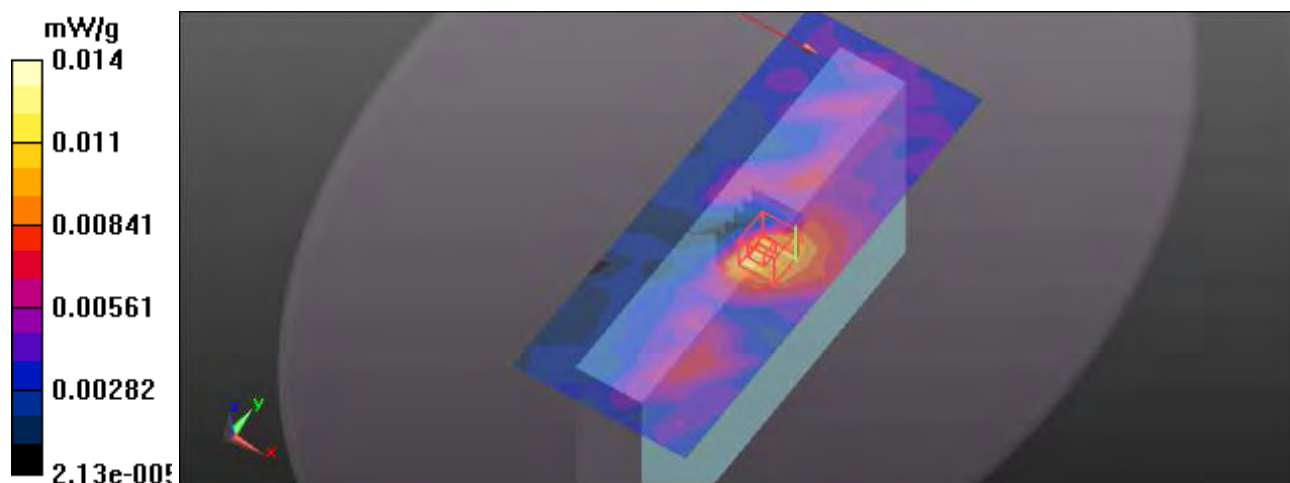

## M24- Edge E-GPRS1900 TS1-Ch661

Communication System: E-GPRS1900 ; Frequency: 1880 MHz ; Duty Cycle: 1:1 ; Modulation type: 8PSK / UL 1 time slot

Medium: MSL1900 Medium parameters used:  $f = 1880$  MHz;  $\sigma = 1.56$  mho/m;  $\epsilon_r = 55.13$ ;  $\rho = 1000$  kg/m<sup>3</sup>

Phantom section: Flat Section ; Separation distance : 0 mm (The edge side of the EUT to the Phantom)

DASY4 Configuration:

- Probe: EX3DV4 - SN3650; ConvF(7.52, 7.52, 7.52); Calibrated: 2011/1/24
- Sensor-Surface: 2mm (Mechanical Surface Detection)
- Electronics: DAE3 Sn579; Calibrated: 2010/9/20
- Phantom: ELI 4.0; Type: QDOVA001BA;Serial: 1039
- Measurement SW: DASY4, Version 4.7 (80); SEMCAD X Version 14.4.2 (2595)

**Flat-Section MSL/Flat Section 0mm/Area Scan (8x19x1):** Measurement grid: dx=15mm, dy=15mm

Maximum value of SAR (measured) = 0.00579 mW/g

**Flat-Section MSL/Flat Section 0mm/Zoom Scan (5x5x7)/Cube 0:** Measurement grid: dx=8mm, dy=8mm, dz=5mm

Reference Value = 0.648 V/m; Power Drift = -0.13 dB

Peak SAR (extrapolated) = 0.00496 W/kg

**SAR(1 g) = 0.00283 mW/g; SAR(10 g) = 0.00204 mW/g**

Maximum value of SAR (measured) = 0.00395 mW/g

**Flat-Section MSL/Flat Section 0mm/Zoom Scan (5x5x7)/Cube 1:** Measurement grid: dx=8mm, dy=8mm, dz=5mm

Reference Value = 0.648 V/m; Power Drift = -0.13 dB

Peak SAR (extrapolated) = 0.00508 W/kg

**SAR(1 g) = 0.00288 mW/g; SAR(10 g) = 0.00208 mW/g**

Maximum value of SAR (measured) = 0.00382 mW/g

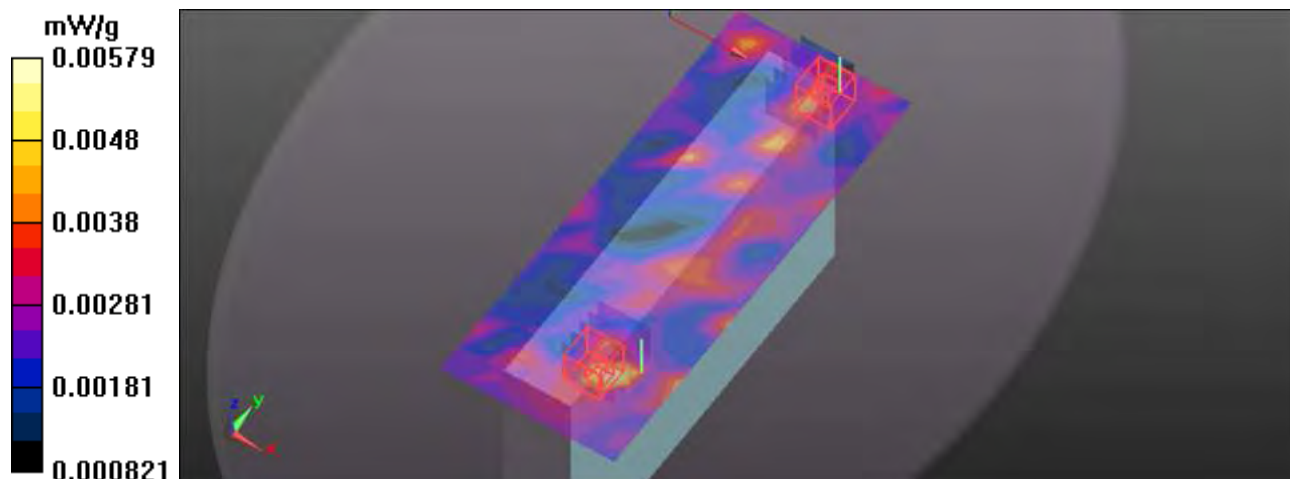

## M25- Edge E-GPRS1900 TS2-Ch661

Communication System: E-GPRS 1900 ; Frequency: 1880 MHz ; Duty Cycle: 1:1 ; Modulation type: 8PSK / UL 2 time slots

Medium: MSL1900 Medium parameters used:  $f = 1880$  MHz;  $\sigma = 1.56$  mho/m;  $\epsilon_r = 55.13$ ;  $\rho = 1000$  kg/m<sup>3</sup>

Phantom section: Flat Section ; Separation distance : 0 mm (The edge side of the EUT to the Phantom)

DASY4 Configuration:

- Probe: EX3DV4 - SN3650; ConvF(7.52, 7.52, 7.52); Calibrated: 2011/1/24
- Sensor-Surface: 2mm (Mechanical Surface Detection)
- Electronics: DAE3 Sn579; Calibrated: 2010/9/20
- Phantom: ELI 4.0; Type: QDOVA001BA;Serial: 1039
- Measurement SW: DASY4, Version 4.7 (80); SEMCAD X Version 14.4.2 (2595)

**Flat-Section MSL/Flat Section 0mm/Area Scan (9x19x1):** Measurement grid: dx=15mm, dy=15mm

Maximum value of SAR (measured) = 0.00573 mW/g

**Flat-Section MSL/Flat Section 0mm/Zoom Scan (5x5x7)/Cube 0:** Measurement grid: dx=8mm, dy=8mm, dz=5mm

Reference Value = 0.617 V/m; Power Drift = -0.18 dB

Peak SAR (extrapolated) = 0.012 W/kg

**SAR(1 g) = 0.00654 mW/g; SAR(10 g) = 0.00376 mW/g**

Maximum value of SAR (measured) = 0.00713 mW/g

**Flat-Section MSL/Flat Section 0mm/Zoom Scan (5x5x7)/Cube 1:** Measurement grid: dx=8mm, dy=8mm, dz=5mm

Reference Value = 0.617 V/m; Power Drift = -0.18 dB

Peak SAR (extrapolated) = 0.011 W/kg

**SAR(1 g) = 0.00351 mW/g; SAR(10 g) = 0.00232 mW/g**

Maximum value of SAR (measured) = 0.00475 mW/g

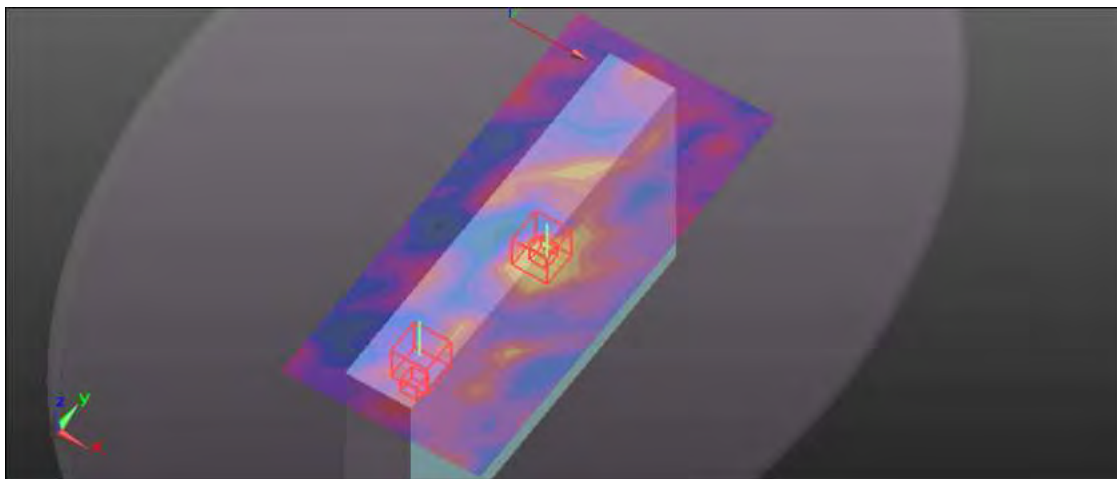
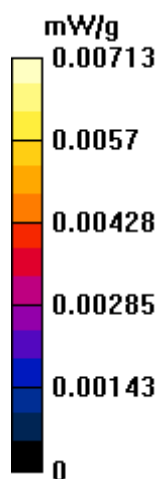

## M26- Edge WCDMA1900-Ch9400

Communication System: WCDMA1900 ; Frequency: 1880 MHz ; Duty Cycle: 1:1 ; Modulation type: BPSK

Medium: MSL1900 Medium parameters used:  $f = 1880$  MHz;  $\sigma = 1.56$  mho/m;  $\epsilon_r = 55.13$ ;  $\rho = 1000$  kg/m<sup>3</sup>

Phantom section: Flat Section ; Separation distance : 0 mm (The edge side of the EUT to the Phantom)

DASY4 Configuration:

- Probe: EX3DV4 - SN3650; ConvF(7.52, 7.52, 7.52); Calibrated: 2011/1/24
- Sensor-Surface: 2mm (Mechanical Surface Detection)
- Electronics: DAE3 Sn579; Calibrated: 2010/9/20
- Phantom: ELI 4.0; Type: QDOVA001BA;Serial: 1039
- Measurement SW: DASY4, Version 4.7 (80); SEMCAD X Version 14.4.2 (2595)

**Flat-Section MSL/Flat Section 0mm/Area Scan (8x19x1):** Measurement grid: dx=15mm, dy=15mm

Maximum value of SAR (measured) = 0.017 mW/g

**Flat-Section MSL/Flat Section 0mm/Zoom Scan (5x5x7)/Cube 0:** Measurement grid: dx=8mm, dy=8mm, dz=5mm

Reference Value = 0.898 V/m; Power Drift = -0.14 dB

Peak SAR (extrapolated) = 0.024 W/kg

**SAR(1 g) = 0.015 mW/g; SAR(10 g) = 0.00929 mW/g**

Maximum value of SAR (measured) = 0.019 mW/g

**Flat-Section MSL/Flat Section 0mm/Zoom Scan (5x5x7)/Cube 1:** Measurement grid: dx=8mm, dy=8mm, dz=5mm

Reference Value = 0.898 V/m; Power Drift = -0.14 dB

Peak SAR (extrapolated) = 0.044 W/kg

**SAR(1 g) = 0.011 mW/g; SAR(10 g) = 0.0053 mW/g**

Maximum value of SAR (measured) = 0.015 mW/g

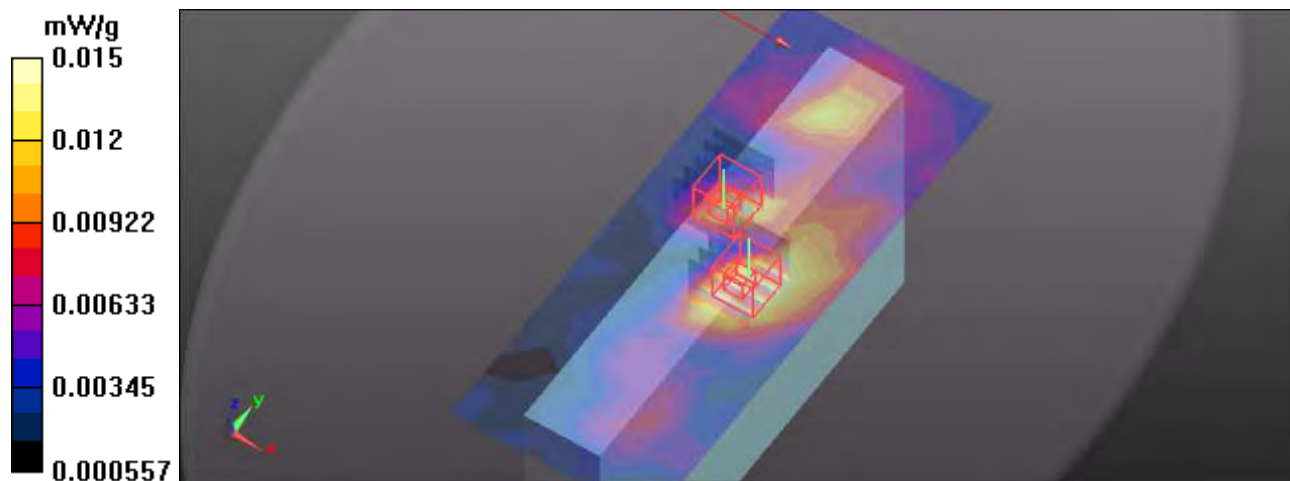

## M27- Edge CDMA1900-Ch600

Communication System: CDMA ; Frequency: 1880 MHz ; Duty Cycle: 1:1 ; Modulation type: OQPSK  
 Medium: MSL1900 Medium parameters used:  $f = 1880 \text{ MHz}$ ;  $\sigma = 1.56 \text{ mho/m}$ ;  $\epsilon_r = 55.13$ ;  $\rho = 1000 \text{ kg/m}^3$

Phantom section: Flat Section ; Separation distance : 0 mm (The edge side of the EUT to the Phantom)

DASY4 Configuration:

- Probe: EX3DV4 - SN3650; ConvF(7.52, 7.52, 7.52); Calibrated: 2011/1/24
- Sensor-Surface: 2mm (Mechanical Surface Detection)
- Electronics: DAE3 Sn579; Calibrated: 2010/9/20
- Phantom: ELI 4.0; Type: QDOVA001BA;Serial: 1039
- Measurement SW: DASY4, Version 4.7 (80); SEMCAD X Version 14.4.2 (2595)

**Flat-Section MSL/Flat Section 0mm/Area Scan (10x19x1):** Measurement grid:  $dx=15\text{mm}$ ,  $dy=15\text{mm}$

Maximum value of SAR (measured) = 0.016 mW/g

**Flat-Section MSL/Flat Section 0mm/Zoom Scan (5x5x7)/Cube 0:** Measurement grid:  $dx=8\text{mm}$ ,  $dy=8\text{mm}$ ,  $dz=5\text{mm}$

Reference Value = 1.528 V/m; Power Drift = 0.16 dB

Peak SAR (extrapolated) = 0.016 W/kg

**SAR(1 g) = 0.00969 mW/g; SAR(10 g) = 0.00579 mW/g**

Maximum value of SAR (measured) = 0.013 mW/g

**Flat-Section MSL/Flat Section 0mm/Zoom Scan (5x5x7)/Cube 1:** Measurement grid:  $dx=8\text{mm}$ ,  $dy=8\text{mm}$ ,  $dz=5\text{mm}$

Reference Value = 1.528 V/m; Power Drift = 0.16 dB

Peak SAR (extrapolated) = 0.022 W/kg

**SAR(1 g) = 0.013 mW/g; SAR(10 g) = 0.00753 mW/g**

Maximum value of SAR (measured) = 0.017 mW/g

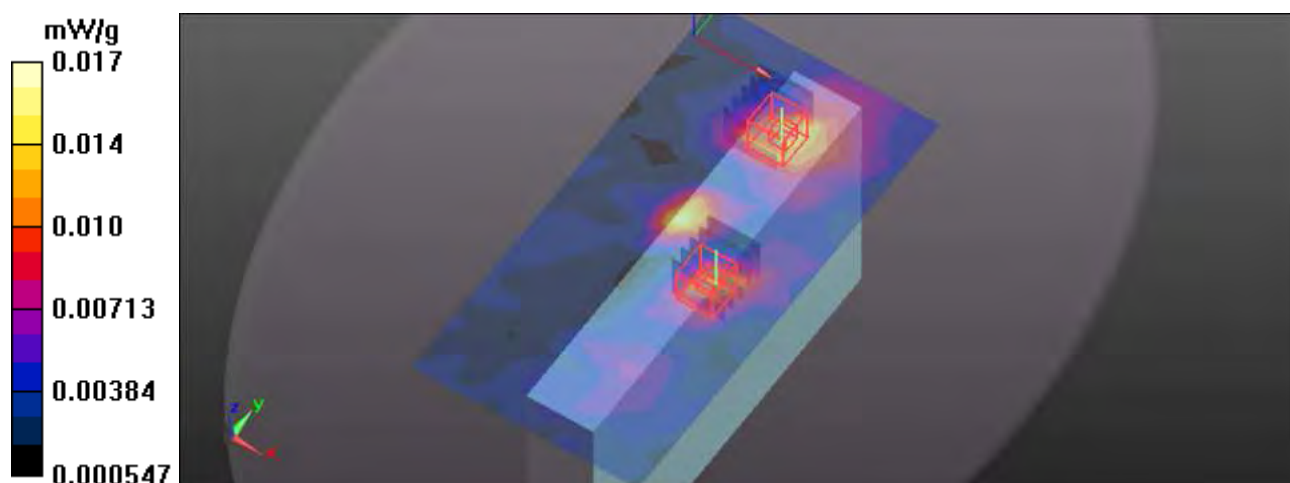

## M28- Edge EVDO1900\_Rev.0-Ch600

Communication System: CDMA ; Frequency: 1880 MHz ; Duty Cycle: 1:1 ; Modulation type: HPSK  
 Medium: MSL1900 Medium parameters used:  $f = 1880 \text{ MHz}$ ;  $\sigma = 1.56 \text{ mho/m}$ ;  $\epsilon_r = 55.13$ ;  $\rho = 1000 \text{ kg/m}^3$

Phantom section: Flat Section ; Separation distance : 0 mm (The edge side of the EUT to the Phantom)

DASY4 Configuration:

- Probe: EX3DV4 - SN3650; ConvF(7.52, 7.52, 7.52); Calibrated: 2011/1/24
- Sensor-Surface: 2mm (Mechanical Surface Detection)
- Electronics: DAE3 Sn579; Calibrated: 2010/9/20
- Phantom: ELI 4.0; Type: QDOVA001BA;Serial: 1039
- Measurement SW: DASY4, Version 4.7 (80); SEMCAD X Version 14.4.2 (2595)

**Flat-Section MSL/Flat Section 0mm/Area Scan (8x19x1):** Measurement grid:  $dx=15\text{mm}$ ,  $dy=15\text{mm}$

Maximum value of SAR (measured) = 0.016 mW/g

**Flat-Section MSL/Flat Section 0mm/Zoom Scan (5x5x7)/Cube 0:** Measurement grid:  $dx=8\text{mm}$ ,  $dy=8\text{mm}$ ,  $dz=5\text{mm}$

Reference Value = 1.320 V/m; Power Drift = 0.10 dB

Peak SAR (extrapolated) = 0.048 W/kg

**SAR(1 g) = 0.013 mW/g; SAR(10 g) = 0.00594 mW/g**

**Flat-Section MSL/Flat Section 0mm/Zoom Scan (5x5x7)/Cube 1:** Measurement grid:  $dx=8\text{mm}$ ,  $dy=8\text{mm}$ ,  $dz=5\text{mm}$

Reference Value = 1.320 V/m; Power Drift = 0.10 dB

Peak SAR (extrapolated) = 0.023 W/kg

**SAR(1 g) = 0.013 mW/g; SAR(10 g) = 0.00789 mW/g**

Maximum value of SAR (measured) = 0.017 mW/g

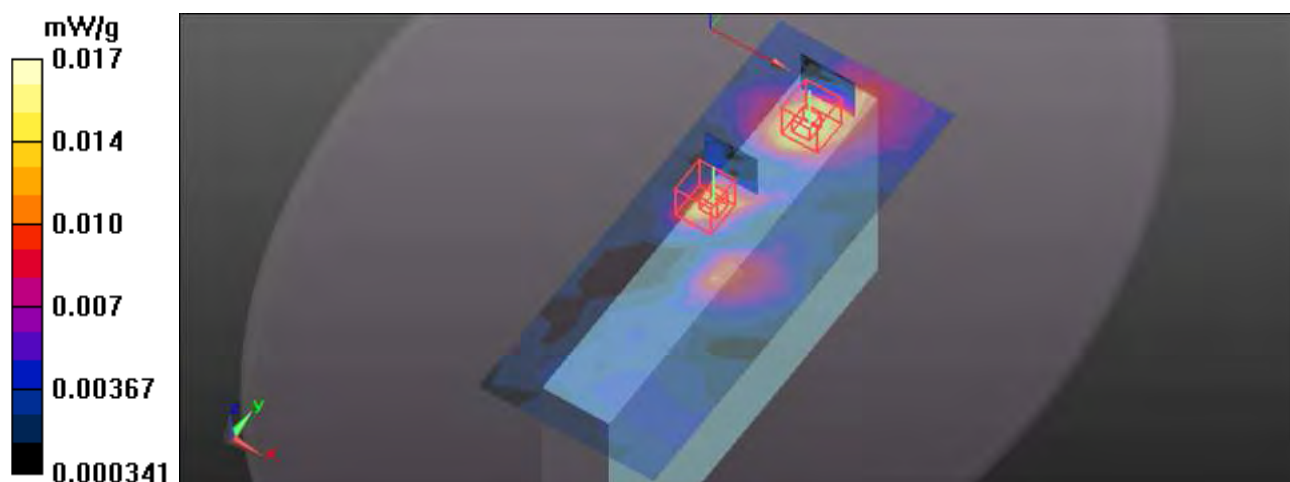

Test Laboratory: Bureau Veritas ADT

## System Validation Check-MSL 835MHz

**DUT: Dipole 850 MHz ; Type: D835V2 ; Serial: 4d021 ; Test Frequency: 835 MHz**

Communication System: CW ; Frequency: 835 MHz; Duty Cycle: 1:1; Modulation type: CW

Medium: MSL835; Medium parameters used:  $f = 835 \text{ MHz}$ ;  $\sigma = 0.96 \text{ mho/m}$ ;  $\epsilon_r = 55.8$ ;  $\rho = 1000 \text{ kg/m}^3$  ; Liquid level : 150 mm

Phantom section: Flat Section ; Separation distance : 15 mm (The feetpoint of the dipole to the Phantom) Air temp. : 23 degrees ; Liquid temp. : 22.8 degrees

DASY4 Configuration:

- Probe: EX3DV3 - SN3504 ; ConvF(9.83, 9.83, 9.83) ; Calibrated: 2010/1/26
- Sensor-Surface: 3mm (Mechanical Surface Detection)
- Electronics: DAE4 Sn861; Calibrated: 2010/1/22
- Phantom: Flat Phantom ELI4.0 ; Type: QDOVA001BB ; Serial: SN:1039
- Measurement SW: DASY4, V4.7 Build 80; Postprocessing SW: SEMCAD, V1.8 Build 186

**d=15mm, Pin=250mW/Area Scan (7x9x1):** Measurement grid:  $dx=15\text{mm}$ ,  $dy=15\text{mm}$   
Maximum value of SAR (measured) = 2.74 mW/g

**d=15mm, Pin=250mW/Zoom Scan (7x7x7) (7x7x7)/Cube 0:** Measurement grid:  $dx=5\text{mm}$ ,  $dy=5\text{mm}$ ,  $dz=5\text{mm}$

Reference Value = 51.7 V/m; Power Drift = -0.030 dB

Peak SAR (extrapolated) = 3.81 W/kg

**SAR(1 g) = 2.55 mW/g; SAR(10 g) = 1.68 mW/g**

Maximum value of SAR (measured) = 2.97 mW/g

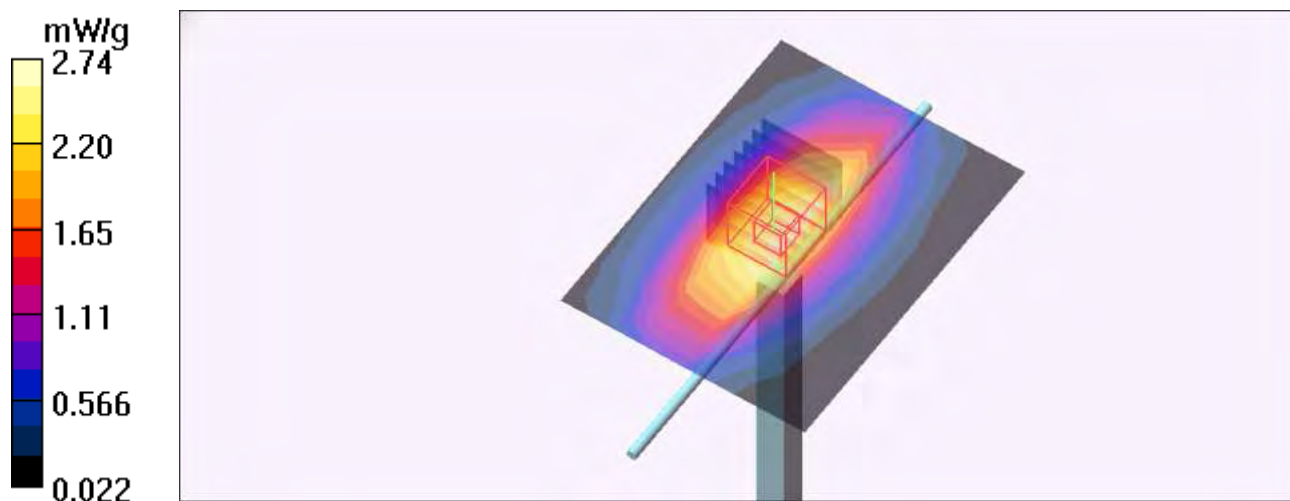

## System Performance Check-D835V2-MSL835 MHz

**DUT: Dipole 835 MHz ; Type: D835V2 ; Serial: D835V2 - SN:4d021 ; Test Frequency: 835 MHz**

Communication System: CW ; Frequency: 835 MHz; Duty Cycle: 1:1; Modulation type: CW  
 Medium: MSL835; Medium parameters used:  $f = 835 \text{ MHz}$ ;  $\sigma = 0.98 \text{ mho/m}$ ;  $\epsilon_r = 56.06$ ;  $\rho = 1000 \text{ kg/m}^3$  ; Liquid level : 150 mm

Phantom section: Flat Section ; Separation distance : 15 mm (The feet point of the dipole to the Phantom) Air temp. : 22.3 degrees ; Liquid temp. : 21.1 degrees

DASY4 Configuration:

- Probe: EX3DV4 - SN3650; ConvF(9.12, 9.12, 9.12); Calibrated: 2011/1/24
- Sensor-Surface: 2mm (Mechanical Surface Detection)
- Electronics: DAE3 Sn579; Calibrated: 2010/9/20
- Phantom: Flat Phantom ELI4.0; Type: QDOVA001BA; Serial: SN:1039
- Measurement SW: DASY4, Version 4.7 (80); SEMCAD X Version 14.4.2 (2595)

**d=15mm, Pin=250mW/Area Scan (7x9x1):** Measurement grid: dx=15mm, dy=15mm  
 Maximum value of SAR (measured) = 3.039 mW/g

**d=15mm, Pin=250mW/Zoom Scan (7x7x7)/Cube 0:** Measurement grid: dx=5mm, dy=5mm, dz=5mm

Reference Value = 55.126 V/m; Power Drift = -0.07 dB

Peak SAR (extrapolated) = 3.680 W/kg

**SAR(1 g) = 2.43 mW/g; SAR(10 g) = 1.58 mW/g**

Maximum value of SAR (measured) = 3.108 mW/g

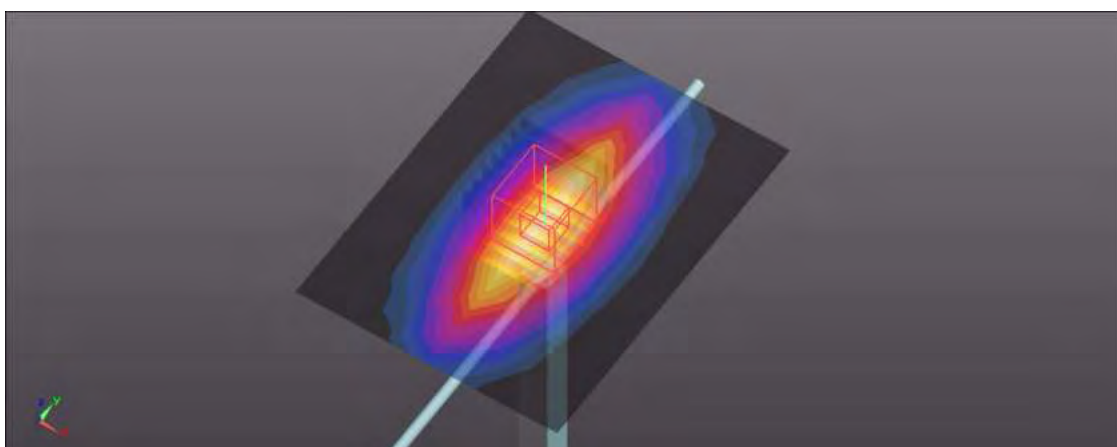
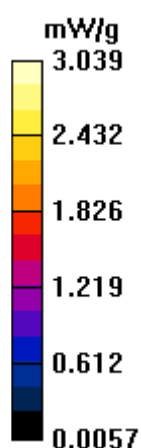



### System Performance Check-D1900V2-MSL1900 MHz

**DUT: Dipole 1900 MHz ; Type: D1900V2 ; Serial: D1900V2 - SN:5d022 ; Test Frequency: 1900 MHz**

Communication System: CW ; Frequency: 1900 MHz; Duty Cycle: 1:1; Modulation type: CW  
 Medium: MSL1900; Medium parameters used:  $f = 1900$  MHz;  $\sigma = 1.57$  mho/m;  $\epsilon_r = 54.92$ ;  $\rho = 1000$  kg/m<sup>3</sup> ; Liquid level : 150 mm  
 Phantom section: Flat Section ; Separation distance : 10 mm (The feet point of the dipole to the Phantom) Air temp. : 22.6 degrees ; Liquid temp. : 21.3 degrees

#### DASY4 Configuration:

- Probe: EX3DV4 - SN3650; ConvF(7.52, 7.52, 7.52); Calibrated: 2011/1/24
- Sensor-Surface: 2mm (Mechanical Surface Detection)
- Electronics: DAE3 Sn579; Calibrated: 2010/9/20
- Phantom: Flat Phantom ELI4.0; Type: QDOVA001BA; Serial: SN:1039
- Measurement SW: DASY4, Version 4.7 (80); SEMCAD X Version 14.4.2 (2595)

**d=10mm, Pin=250mW/Area Scan (7x7x1):** Measurement grid: dx=15mm, dy=15mm  
 Maximum value of SAR (measured) = 14.371 mW/g

**d=10mm, Pin=250mW/Zoom Scan (7x7x7)/Cube 0:** Measurement grid: dx=5mm, dy=5mm, dz=5mm

Reference Value = 98.945 V/m; Power Drift = 0.014 dB

Peak SAR (extrapolated) = 18.461 W/kg

**SAR(1 g) = 9.89 mW/g; SAR(10 g) = 5.19 mW/g**

Maximum value of SAR (measured) = 14.328 mW/g

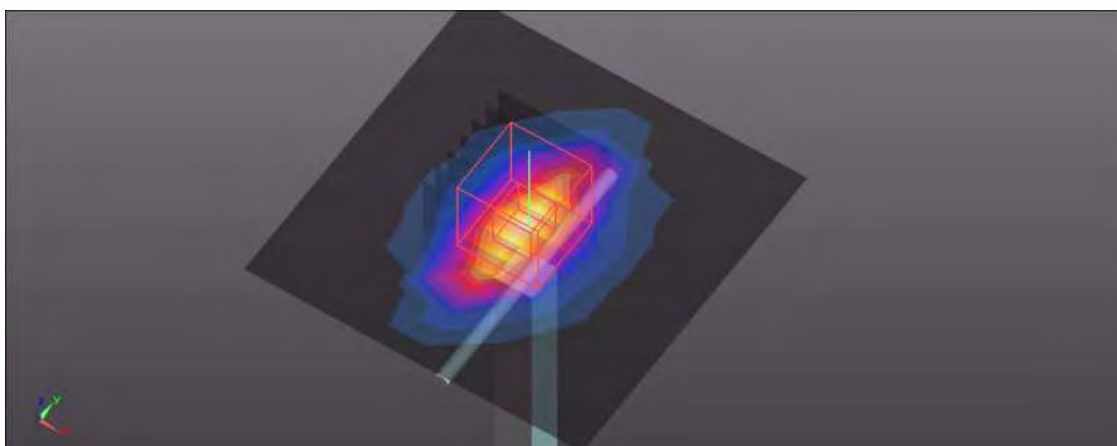
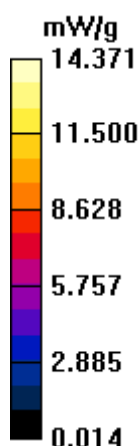



香港商立德國際商品試驗有限公司桃園分公司

Bureau Veritas Consumer Products Services (H.K.) Ltd., Taoyuan Branch

**APPENDIX A: TEST DATA**

**Product Name:7 Rugged Tablet PC; Model Number:Algiz 7**

**Liquid Level Photo**

**Tissue MSL2450MHz D=150mm**

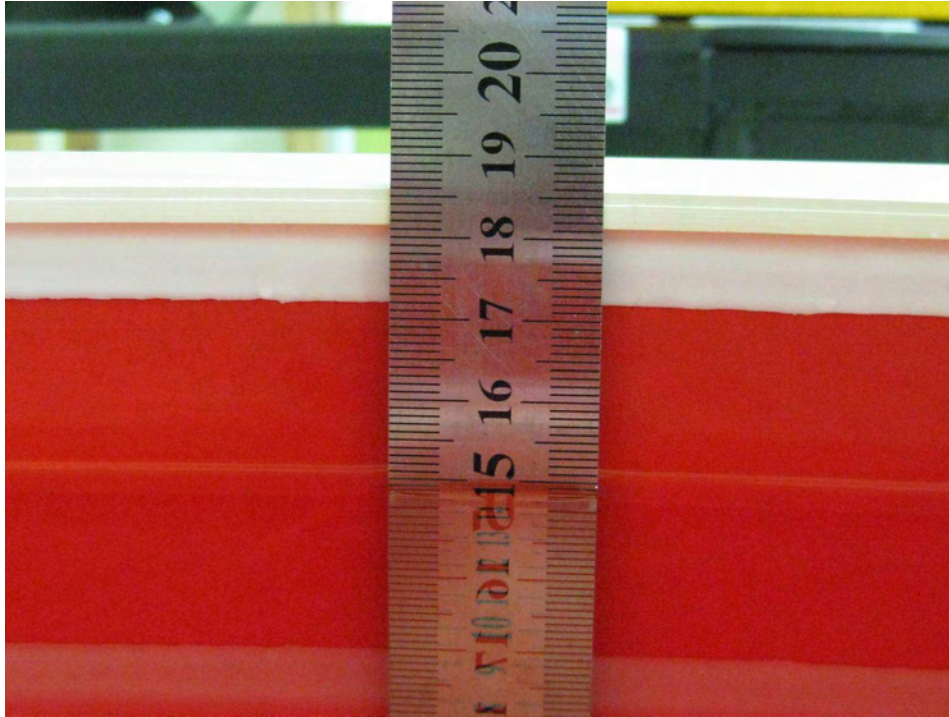

Test Laboratory: Bureau Veritas ADT

## M29-Bottom-11B-ANT A

### DUT: 7 Rugged Table PC ; Type: Algiz7

Communication System: 802.11b ; Frequency: 2437 MHz ; Duty Cycle: 1:1 ; Modulation type: DBPSK  
Medium: MSL2450 Medium parameters used:  $f = 2437$  MHz;  $\sigma = 1.97$  mho/m;  $\epsilon_r = 53.7$ ;  $\rho = 1000$  kg/m<sup>3</sup>  
Phantom section: Flat Section ; Separation distance : 0 mm (The bottom side of the EUT to the Phantom)

#### DASY4 Configuration:

- Probe: EX3DV3 - SN3504 ; ConvF(7.91, 7.91, 7.91) ; Calibrated: 2010/1/26
- Sensor-Surface: 2mm (Mechanical Surface Detection)
- Electronics: DAE4 Sn861 ; Calibrated: 2010/1/22
- Phantom: Flat Phantom ELI4.0 ; Type: QDOVA001BB ; Serial: SN:1039
- Measurement SW: DASY4, V4.7 Build 80 ; Postprocessing SW: SEMCAD, V1.8 Build 186

### Mid Channel 6/Area Scan (15x18x1): Measurement grid: dx=15mm, dy=15mm

Maximum value of SAR (measured) = 0.107 mW/g

### Mid Channel 6/Zoom Scan (7x7x7)/Cube 0: Measurement grid: dx=5mm, dy=5mm, dz=5mm

Reference Value = 3.83 V/m; Power Drift = -0.185 dB

Peak SAR (extrapolated) = 0.153 W/kg

SAR(1 g) = **0.090 mW/g**; SAR(10 g) = 0.059 mW/g

Maximum value of SAR (measured) = 0.119 mW/g

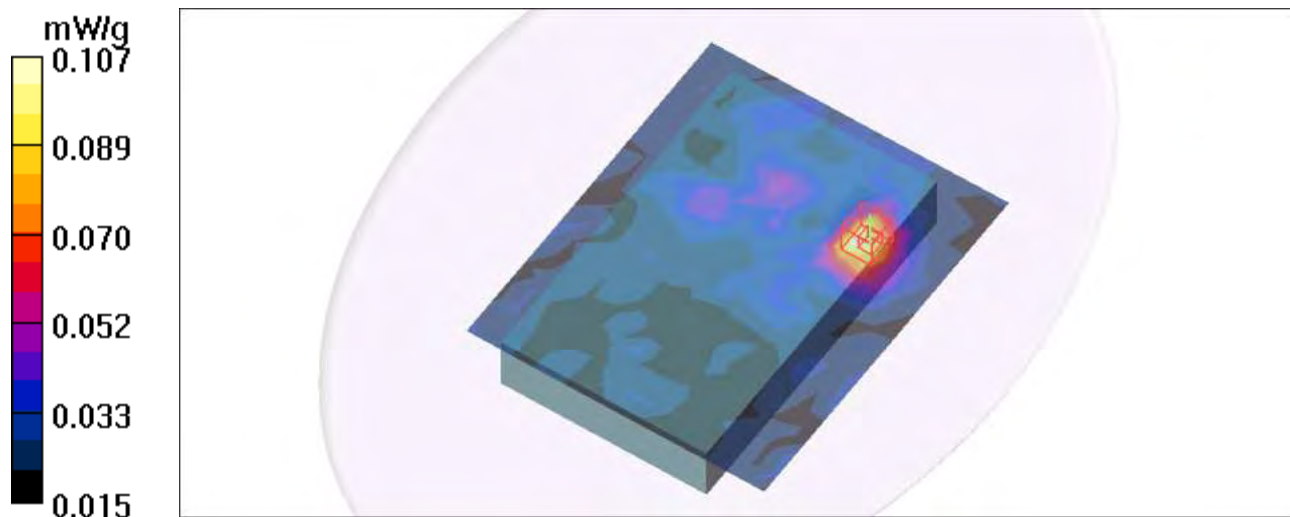

Test Laboratory: Bureau Veritas ADT

**M30-Bottom-11B-ANT B****DUT: 7 Rugged Table PC ; Type: Algiz7**

Communication System: 802.11b ; Frequency: 2437 MHz ; Duty Cycle: 1:1 ; Modulation type: DBPSK  
Medium: MSL2450 Medium parameters used:  $f = 2437$  MHz;  $\sigma = 1.97$  mho/m;  $\epsilon_r = 53.7$ ;  $\rho = 1000$  kg/m<sup>3</sup>  
Phantom section: Flat Section ; Separation distance : 0 mm (The bottom side of the EUT to the Phantom)

DASY4 Configuration:

- Probe: EX3DV3 - SN3504 ; ConvF(7.91, 7.91, 7.91) ; Calibrated: 2010/1/26
- Sensor-Surface: 2mm (Mechanical Surface Detection)
- Electronics: DAE4 Sn861 ; Calibrated: 2010/1/22
- Phantom: Flat Phantom ELI4.0 ; Type: QDOVA001BB ; Serial: SN:1039
- Measurement SW: DASY4, V4.7 Build 80 ; Postprocessing SW: SEMCAD, V1.8 Build 186

**Mid Channel 6/Area Scan (15x18x1):** Measurement grid: dx=15mm, dy=15mm

Maximum value of SAR (measured) = 0.061 mW/g

**Mid Channel 6/Zoom Scan (7x7x7)/Cube 0:** Measurement grid: dx=5mm, dy=5mm, dz=5mm

Reference Value = 3.25 V/m; Power Drift = -0.125 dB

Peak SAR (extrapolated) = 0.084 W/kg

**SAR(1 g) = 0.053 mW/g; SAR(10 g) = 0.039 mW/g**

Maximum value of SAR (measured) = 0.068 mW/g

**Mid Channel 6/Zoom Scan (7x7x7)/Cube 1:** Measurement grid: dx=5mm, dy=5mm, dz=5mm

Reference Value = 3.25 V/m; Power Drift = -0.125 dB

Peak SAR (extrapolated) = 0.071 W/kg

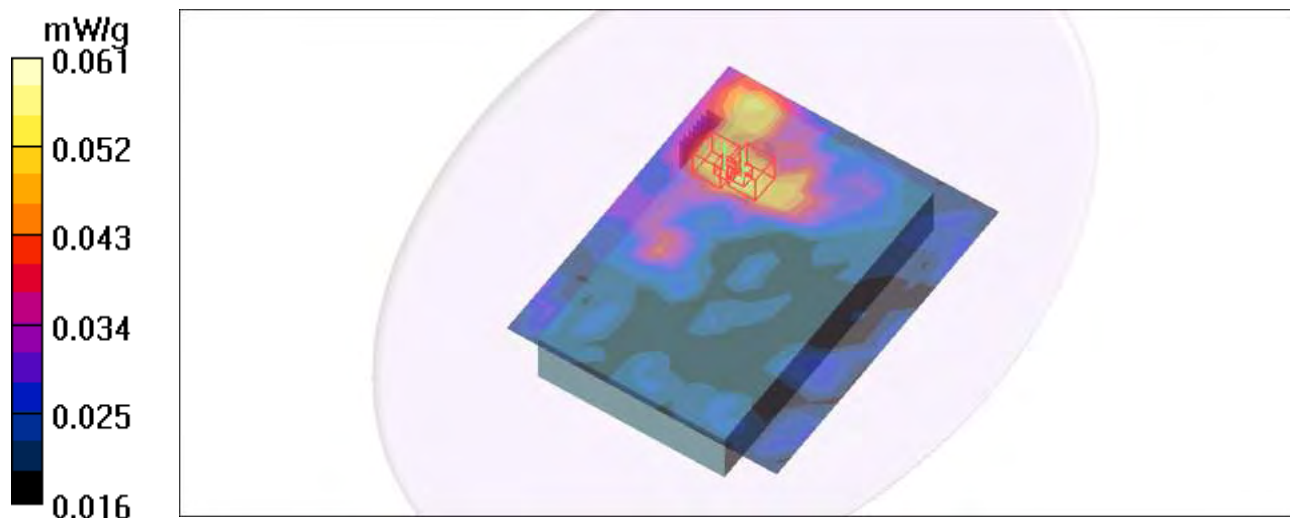
**SAR(1 g) = 0.047 mW/g; SAR(10 g) = 0.035 mW/g**

Test Laboratory: Bureau Veritas ADT

## M31-Edge-11B-ANT A

### DUT: 7 Rugged Table PC ; Type: Algiz7

Communication System: 802.11b ; Frequency: 2437 MHz ; Duty Cycle: 1:1 ; Modulation type: DBPSK  
Medium: MSL2450 Medium parameters used:  $f = 2437$  MHz;  $\sigma = 1.97$  mho/m;  $\epsilon_r = 53.7$ ;  $\rho = 1000$  kg/m<sup>3</sup>  
Phantom section: Flat Section ; Separation distance : 0 mm (The edge side of the EUT to the Phantom)

#### DASY4 Configuration:

- Probe: EX3DV3 - SN3504 ; ConvF(7.91, 7.91, 7.91) ; Calibrated: 2010/1/26
- Sensor-Surface: 2mm (Mechanical Surface Detection)
- Electronics: DAE4 Sn861 ; Calibrated: 2010/1/22
- Phantom: Flat Phantom ELI4.0 ; Type: QDOVA001BB ; Serial: SN:1039
- Measurement SW: DASY4, V4.7 Build 80 ; Postprocessing SW: SEMCAD, V1.8 Build 186

### Mid Channel 6/Area Scan (9x21x1): Measurement grid: dx=15mm, dy=15mm

Maximum value of SAR (measured) = 0.021 mW/g

### Mid Channel 6/Zoom Scan (7x7x7)/Cube 0: Measurement grid: dx=5mm, dy=5mm, dz=5mm

Reference Value = 2.52 V/m; Power Drift = 0.168 dB

Peak SAR (extrapolated) = 0.055 W/kg

SAR(1 g) = **0.026 mW/g**; SAR(10 g) = 0.017 mW/g

Maximum value of SAR (measured) = 0.038 mW/g

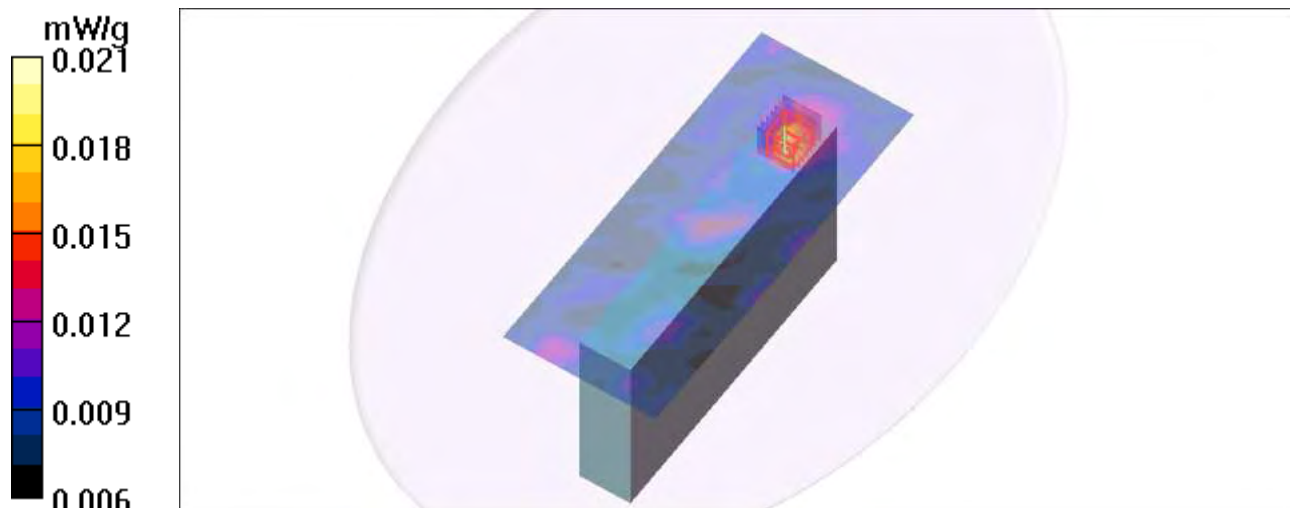

Test Laboratory: Bureau Veritas ADT

## M32-Edge-11B-ANT B

### DUT: 7 Rugged Table PC ; Type: Algiz7

Communication System: 802.11b ; Frequency: 2437 MHz ; Duty Cycle: 1:1 ; Modulation type: DBPSK  
Medium: MSL2450 Medium parameters used:  $f = 2437$  MHz;  $\sigma = 1.97$  mho/m;  $\epsilon_r = 53.7$ ;  $\rho = 1000$  kg/m<sup>3</sup>  
Phantom section: Flat Section ; Separation distance : 0 mm (The edge side of the EUT to the Phantom)

### DASY4 Configuration:

- Probe: EX3DV3 - SN3504 ; ConvF(7.91, 7.91, 7.91) ; Calibrated: 2010/1/26
- Sensor-Surface: 2mm (Mechanical Surface Detection)
- Electronics: DAE4 Sn861 ; Calibrated: 2010/1/22
- Phantom: Flat Phantom ELI4.0 ; Type: QDOVA001BB ; Serial: SN:1039
- Measurement SW: DASY4, V4.7 Build 80 ; Postprocessing SW: SEMCAD, V1.8 Build 186

### Mid Channel 6/Area Scan (9x21x1): Measurement grid: dx=15mm, dy=15mm

Maximum value of SAR (measured) = 0.772 mW/g

### Mid Channel 6/Zoom Scan (7x7x7)/Cube 0: Measurement grid: dx=5mm, dy=5mm, dz=5mm

Reference Value = 9.38 V/m; Power Drift = -0.180 dB

Peak SAR (extrapolated) = 1.17 W/kg

SAR(1 g) = **0.529** mW/g; SAR(10 g) = 0.256 mW/g

Maximum value of SAR (measured) = 0.819 mW/g

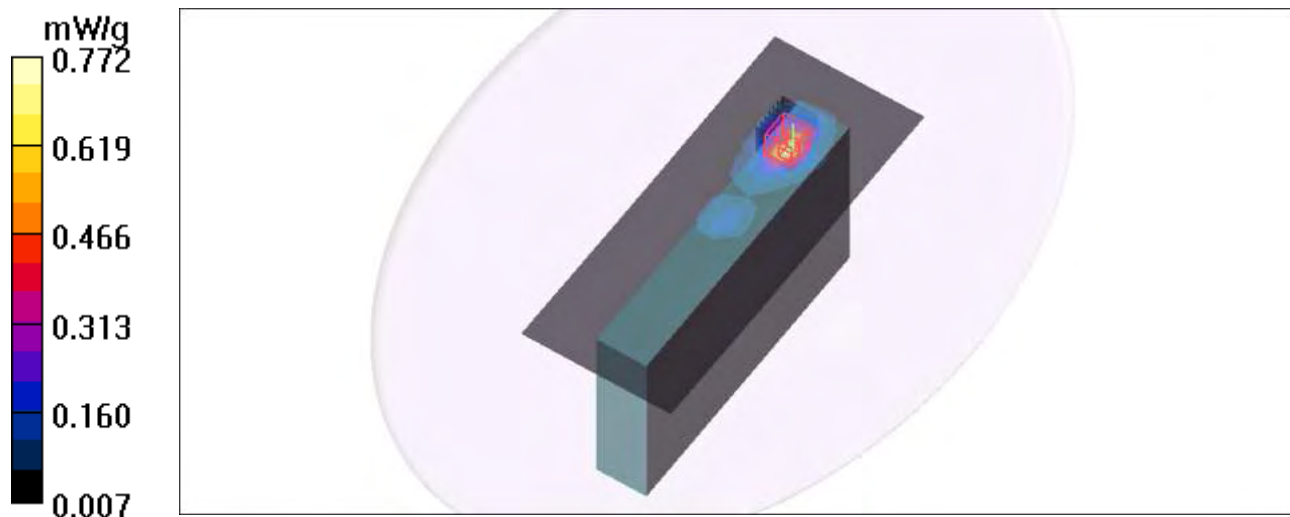

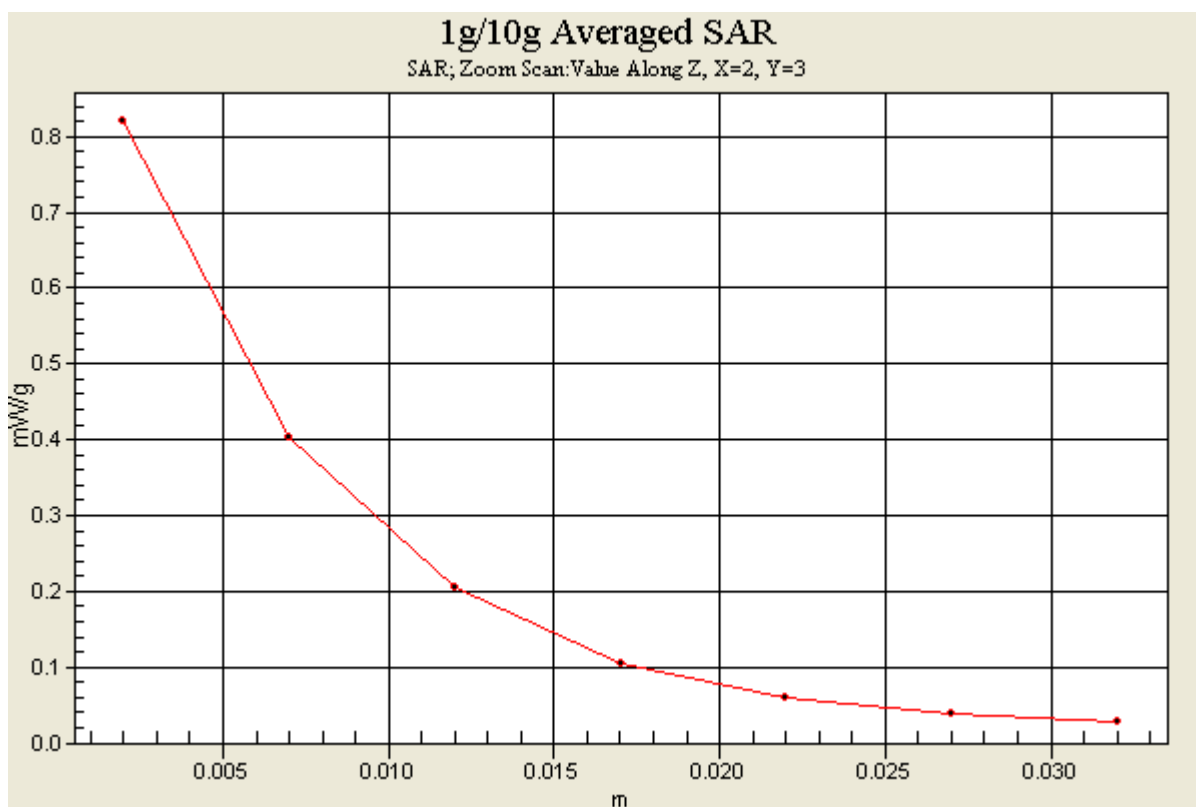

Test Laboratory: Bureau Veritas ADT

## System Validation Check-MSL 2450MHz

**DUT: Dipole 2450 MHz ; Type: D2450V2 ; Serial: 737 ; Test Frequency: 2450 MHz**

Communication System: CW ; Frequency: 2450 MHz; Duty Cycle: 1:1; Modulation type: CW

Medium: MSL2450; Medium parameters used:  $f = 2450 \text{ MHz}$ ;  $\sigma = 1.98 \text{ mho/m}$ ;  $\epsilon_r = 53.6$ ;  $\rho = 1000 \text{ kg/m}^3$  ;

Liquid level : 150 mm

Phantom section: Flat Section ; Separation distance : 10 mm (The feetpoint of the dipole to the Phantom) Air temp. : 23 degrees ; Liquid temp. : 22.8 degrees

DASY4 Configuration:

- Probe: EX3DV3 - SN3504 ; ConvF(7.91, 7.91, 7.91) ; Calibrated: 2010/1/26
- Sensor-Surface: 3mm (Mechanical Surface Detection)
- Electronics: DAE4 Sn861; Calibrated: 2010/1/22
- Phantom: Flat Phantom ELI4.0; Type: QDOVA001BB; Serial: SN:1036
- Measurement SW: DASY4, V4.7 Build 80; Postprocessing SW: SEMCAD, V1.8 Build 186

**d=10mm, Pin=250mW/Area Scan (5x7x1):** Measurement grid: dx=15mm, dy=15mm

Maximum value of SAR (measured) = 17.0 mW/g

**d=10mm, Pin=250mW/Zoom Scan (7x7x7)/Cube 0:** Measurement grid: dx=5mm, dy=5mm, dz=5mm

Reference Value = 83.3 V/m; Power Drift = -0.128 dB

Peak SAR (extrapolated) = 26.9 W/kg

**SAR(1 g) = 12.8 mW/g; SAR(10 g) = 5.85 mW/g**

Maximum value of SAR (measured) = 17.1 mW/g

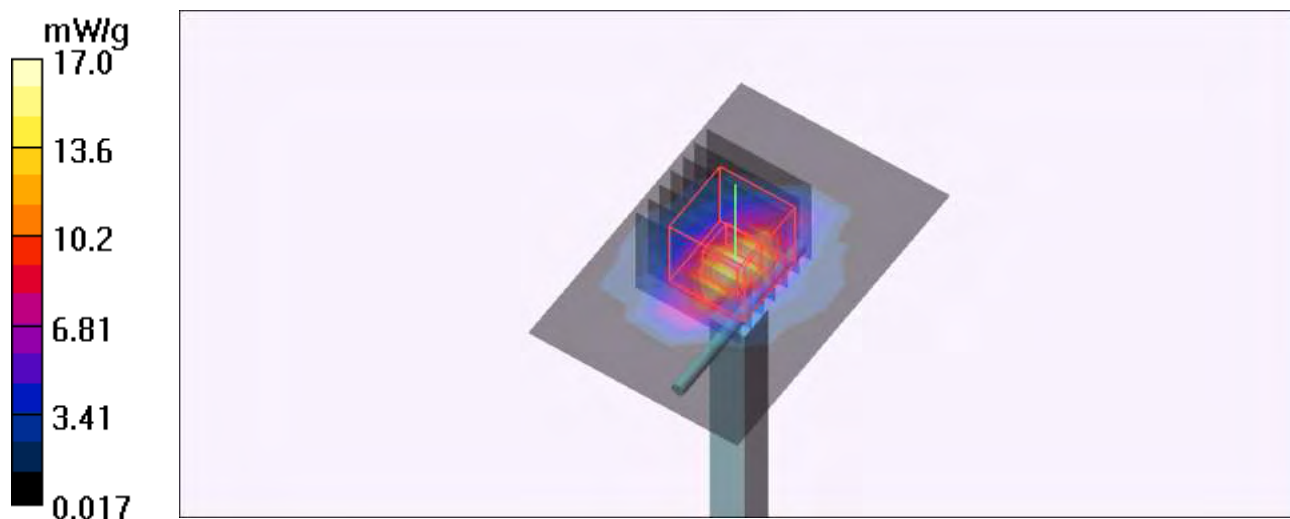



## APPENDIX B: BV ADT SAR MEASUREMENT SYSTEM



## APPENDIX C: PHOTOGRAPHS OF SYSTEM VALIDATION

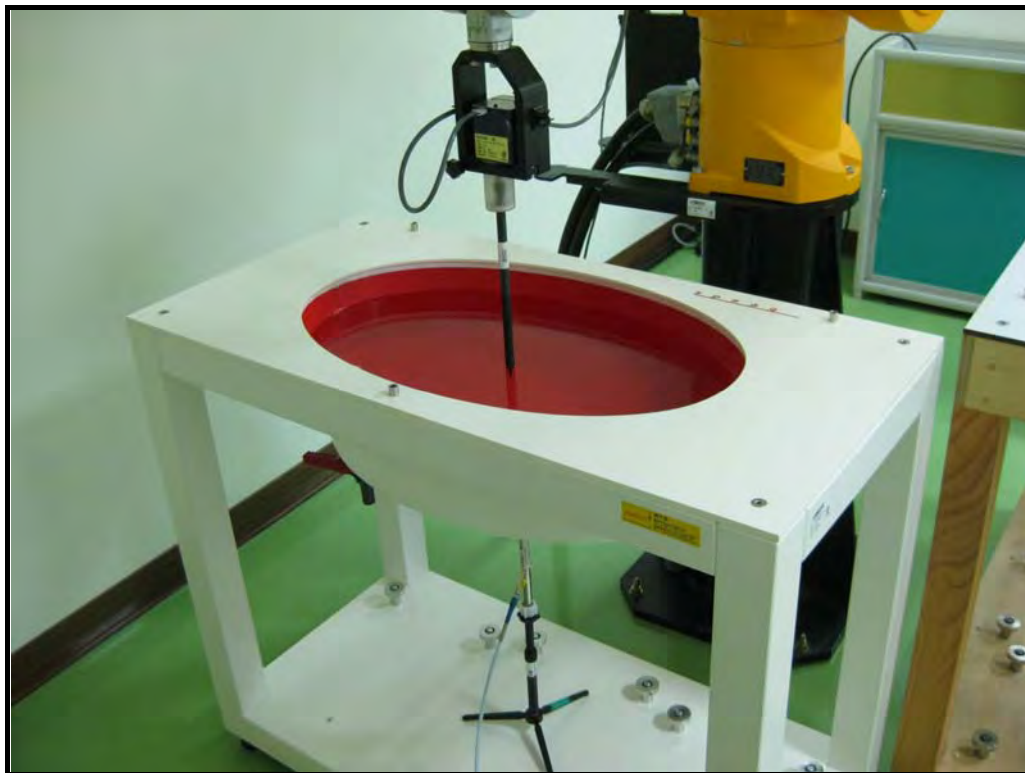



## APPENDIX D: SYSTEM CERTIFICATE & CALIBRATION

### D1: PHANTOM

Zeughausstrasse 43, 8004 Zurich, Switzerland  
 Phone +41 1 245 9700, Fax +41 1 245 9779  
 info@speag.com, http://www.speag.com

### Certificate of Conformity / First Article Inspection

Item	Oval Flat Phantom ELI 4.0
Type No	QD OVA 001 B
Series No	1003 and higher
Manufacturer	SPEAG Zeughausstrasse 43 CH-8004 Zürich Switzerland

#### Tests

Complete tests were made on the prototype units QD OVA 001 AA 1001, QD OVA 001 AB 1002, pre-series units QD OVA 001 BA 1003-1005 as well as on the series units QD OVA 001 BB, 1006 ff.

Test	Requirement	Details	Units tested
Dimensions	Compliant with the standard IEC 62209 – 2 [1] requirements	Dimensions of bottom for 300 MHz – 6 GHz: longitudinal = 600 mm (max. dimension) width = 400 mm (min dimension) depth = 190 mm Shape: ellipse	Prototypes, Samples
Material thickness	Compliant with the standard IEC 62209 – 2 [1] requirements	Bottom plate: 2.0mm +/- 0.2mm	Prototypes, All items
Material parameters	Dielectric parameters for required frequencies	300 MHz – 6 GHz Rel. permittivity = 4 +/-1, Loss tangent ≤ 0.05	Material sample
Material resistivity	The material has been tested to be compatible with the liquids defined in the standards if handled and cleaned according to the instructions. Observe Technical Note for material compatibility.	DEGMBE based simulating liquids	Equivalent phantoms, Material sample
Sagging	Compliant with the requirements according to the standard. Sagging of the flat section when filled with tissue simulating liquid	< 1% typical < 0.8% if filled with 155mm of HSL900 and without DUT below	Prototypes, Sample testing

#### Standards

- [1] IEC 62209 – 2, Draft Version 0.9, "Evaluation of Human Exposure to Radio Frequency Fields from Handheld and Body-Mounted Wireless Communication Devices in the Frequency Range of 30 MHz to 6 GHz: Human models, Instrumentation and Procedures Part 2: Procedure to determine the Specific Absorption Rate (SAR) for ... including accessories and multiple transmitters", December 2004

#### Conformity

Based on the sample tests above, we certify that this item is in compliance with the standard [1].

Date 07.07.2005

Signature / Stamp

**s p e a g**

Schmid & Partner Engineering AG  
 Zeughausstrasse 43, 8004 Zurich, Switzerland  
 Phone +41 1-245-9700, Fax +41 1-245-9779  
 info@speag.com, http://www.speag.com



## D2: DOSIMETRIC E-FIELD PROBE



Accredited by the Swiss Accreditation Service (SAS)  
The Swiss Accreditation Service is one of the signatories to the EA  
Multilateral Agreement for the recognition of calibration certificates

Accreditation No.: **SCS 108**

Client **BV-ADT (Auden)**

Certificate No: **EX3-3504\_Jan10**

## CALIBRATION CERTIFICATE

Object **EX3DV3 - SN:3504**

Calibration procedure(s) **QA CAL-01.v6, QA CAL-14.v3, QA CAL-23.v3 and QA CAL-25.v2  
Calibration procedure for dosimetric E-field probes**

Calibration date: **January 26, 2010**

This calibration certificate documents the traceability to national standards, which realize the physical units of measurements (SI).  
The measurements and the uncertainties with confidence probability are given on the following pages and are part of the certificate.

All calibrations have been conducted in the closed laboratory facility: environment temperature ( $22 \pm 3$ )°C and humidity < 70%.

Calibration Equipment used (M&TE critical for calibration)

Primary Standards	ID #	Cal Date (Certificate No.)	Scheduled Calibration
Power meter E4419B	GB41293874	1-Apr-09 (No. 217-01030)	Apr-10
Power sensor E4412A	MY41495277	1-Apr-09 (No. 217-01030)	Apr-10
Power sensor E4412A	MY41498087	1-Apr-09 (No. 217-01030)	Apr-10
Reference 3 dB Attenuator	SN: S5054 (3c)	31-Mar-09 (No. 217-01026)	Mar-10
Reference 20 dB Attenuator	SN: S5086 (20b)	31-Mar-09 (No. 217-01028)	Mar-10
Reference 30 dB Attenuator	SN: S5129 (30b)	31-Mar-09 (No. 217-01027)	Mar-10
Reference Probe ES3DV2	SN: 3013	30-Dec-09 (No. ES3-3013_Dec09)	Dec-10
DAE4	SN: 660	29-Sep-09 (No. DAE4-660_Sep09)	Sep-10
Secondary Standards	ID #	Check Date (in house)	Scheduled Check
RF generator HP 8648C	US3642U01700	4-Aug-99 (in house check Oct-09)	In house check: Oct-11
Network Analyzer HP 8753E	US37390585	18-Oct-01 (in house check Oct-09)	In house check: Oct10

	Name	Function	Signature
Calibrated by:	<b>Katja Pokovic</b>	<b>Technical Manager</b>	
Approved by:	<b>Fin Bornholt</b>	<b>R&amp;D Director</b>	

Issued: January 26, 2010

This calibration certificate shall not be reproduced except in full without written approval of the laboratory.



Accredited by the Swiss Accreditation Service (SAS)  
The Swiss Accreditation Service is one of the signatories to the EA  
Multilateral Agreement for the recognition of calibration certificates

Accreditation No.: **SCS 108**

### Glossary:

TSL	tissue simulating liquid
NORM <sub>x,y,z</sub>	sensitivity in free space
ConvF	sensitivity in TSL / NORM <sub>x,y,z</sub>
DCP	diode compression point
CF	crest factor (1/duty_cycle) of the RF signal
A, B, C	modulation dependent linearization parameters
Polarization $\varphi$	$\varphi$ rotation around probe axis
Polarization $\vartheta$	$\vartheta$ rotation around an axis that is in the plane normal to probe axis (at measurement center), i.e., $\vartheta = 0$ is normal to probe axis

### Calibration is Performed According to the Following Standards:

- IEEE Std 1528-2003, "IEEE Recommended Practice for Determining the Peak Spatial-Averaged Specific Absorption Rate (SAR) in the Human Head from Wireless Communications Devices: Measurement Techniques", December 2003
- IEC 62209-1, "Procedure to measure the Specific Absorption Rate (SAR) for hand-held devices used in close proximity to the ear (frequency range of 300 MHz to 3 GHz)", February 2005

### Methods Applied and Interpretation of Parameters:

- NORM<sub>x,y,z</sub>**: Assessed for E-field polarization  $\vartheta = 0$  ( $f \leq 900$  MHz in TEM-cell;  $f > 1800$  MHz: R22 waveguide). NORM<sub>x,y,z</sub> are only intermediate values, i.e., the uncertainties of NORM<sub>x,y,z</sub> does not effect the  $E^2$ -field uncertainty inside TSL (see below *ConvF*).
- NORM(f)<sub>x,y,z</sub>** = NORM<sub>x,y,z</sub> \* frequency\_response (see Frequency Response Chart). This linearization is implemented in DASY4 software versions later than 4.2. The uncertainty of the frequency response is included in the stated uncertainty of *ConvF*.
- DCP<sub>x,y,z</sub>**: DCP are numerical linearization parameters assessed based on the data of power sweep with CW signal (no uncertainty required). DCP does not depend on frequency nor media.
- A<sub>x,y,z</sub>; B<sub>x,y,z</sub>; C<sub>x,y,z</sub>; VR<sub>x,y,z</sub>**: A, B, C are numerical linearization parameters assessed based on the data of power sweep for specific modulation signal. The parameters do not depend on frequency nor media. VR is the maximum calibration range expressed in RMS voltage across the diode.
- ConvF and Boundary Effect Parameters**: Assessed in flat phantom using E-field (or Temperature Transfer Standard for  $f \leq 800$  MHz) and inside waveguide using analytical field distributions based on power measurements for  $f > 800$  MHz. The same setups are used for assessment of the parameters applied for boundary compensation (alpha, depth) of which typical uncertainty values are given. These parameters are used in DASY4 software to improve probe accuracy close to the boundary. The sensitivity in TSL corresponds to NORM<sub>x,y,z</sub> \* ConvF whereby the uncertainty corresponds to that given for ConvF. A frequency dependent ConvF is used in DASY version 4.4 and higher which allows extending the validity from  $\pm 50$  MHz to  $\pm 100$  MHz.
- Spherical isotropy (3D deviation from isotropy)**: in a field of low gradients realized using a flat phantom exposed by a patch antenna.
- Sensor Offset**: The sensor offset corresponds to the offset of virtual measurement center from the probe tip (on probe axis). No tolerance required.

# Probe EX3DV3

## SN:3504

Manufactured:	December 15, 2003
Last calibrated:	January 21, 2009
Recalibrated:	January 26, 2010

Calibrated for DASY Systems

(Note: non-compatible with DASY2 system!)



**DASY - Parameters of Probe: EX3DV3 SN:3504****Basic Calibration Parameters**

	Sensor X	Sensor Y	Sensor Z	Unc (k=2)
Norm ( $\mu\text{V}/(\text{V}/\text{m})^2$ ) <sup>A</sup>	0.59	0.62	0.62	$\pm 10.1\%$
DCP (mV) <sup>B</sup>	97.9	95.0	98.0	

**Modulation Calibration Parameters**

UID	Communication System Name	PAR		A dB	B dBuV	C	VR mV	Unc <sup>E</sup> (k=2)
10000	CW	0.00	X	0.00	0.00	1.00	300	$\pm 1.5\%$
			Y	0.00	0.00	1.00	300	
			Z	0.00	0.00	1.00	300	

The reported uncertainty of measurement is stated as the standard uncertainty of measurement multiplied by the coverage factor  $k=2$ , which for a normal distribution corresponds to a coverage probability of approximately 95%.

<sup>A</sup> The uncertainties of NormX,Y,Z do not affect the  $E^2$ -field uncertainty inside TSL. (see Pages 5 and 6).

<sup>B</sup> Numerical linearization parameter: uncertainty not required.

<sup>E</sup> Uncertainty is determined using the maximum deviation from linear response applying recatangular distribution and is expressed for the square of the field value.

## DASY - Parameters of Probe: EX3DV3 SN:3504

### Calibration Parameter Determined in Head Tissue Simulating Media

f [MHz]	Validity [MHz] <sup>c</sup>	Permittivity	Conductivity	ConvF X	ConvF Y	ConvF Z	Alpha	Depth Unc (k=2)
900	± 50 / ± 100	41.5 ± 5%	0.97 ± 5%	9.80	9.80	9.80	0.48	0.73 ± 11.0%
1750	± 50 / ± 100	40.1 ± 5%	1.37 ± 5%	8.70	8.70	8.70	0.50	0.67 ± 11.0%
1950	± 50 / ± 100	40.0 ± 5%	1.40 ± 5%	8.20	8.20	8.20	0.38	0.75 ± 11.0%
2450	± 50 / ± 100	39.2 ± 5%	1.80 ± 5%	7.77	7.77	7.77	0.21	1.06 ± 11.0%
2600	± 50 / ± 100	39.0 ± 5%	1.96 ± 5%	7.79	7.79	7.79	0.22	1.16 ± 11.0%
5200	± 50 / ± 100	36.0 ± 5%	4.66 ± 5%	4.87	4.87	4.87	0.45	1.70 ± 13.1%
5300	± 50 / ± 100	35.9 ± 5%	4.76 ± 5%	4.62	4.62	4.62	0.45	1.70 ± 13.1%
5500	± 50 / ± 100	35.6 ± 5%	4.96 ± 5%	4.51	4.51	4.51	0.50	1.70 ± 13.1%
5600	± 50 / ± 100	35.5 ± 5%	5.07 ± 5%	4.25	4.25	4.25	0.55	1.70 ± 13.1%
5800	± 50 / ± 100	35.3 ± 5%	5.27 ± 5%	4.53	4.53	4.53	0.50	1.70 ± 13.1%

<sup>c</sup> The validity of ± 100 MHz only applies for DASY v4.4 and higher (see Page 2). The uncertainty is the RSS of the ConvF uncertainty at calibration frequency and the uncertainty for the indicated frequency band.

## DASY - Parameters of Probe: EX3DV3 SN:3504

### Calibration Parameter Determined in Body Tissue Simulating Media

f [MHz]	Validity [MHz] <sup>c</sup>	Permittivity	Conductivity	ConvF X	ConvF Y	ConvF Z	Alpha	Depth Unc (k=2)
900	± 50 / ± 100	55.0 ± 5%	1.05 ± 5%	9.83	9.83	9.83	0.44	0.76 ± 11.0%
1750	± 50 / ± 100	53.4 ± 5%	1.49 ± 5%	8.64	8.64	8.64	0.44	0.74 ± 11.0%
1950	± 50 / ± 100	53.3 ± 5%	1.52 ± 5%	8.52	8.52	8.52	0.39	0.79 ± 11.0%
2450	± 50 / ± 100	52.7 ± 5%	1.95 ± 5%	7.91	7.91	7.91	0.32	0.86 ± 11.0%
2600	± 50 / ± 100	52.5 ± 5%	2.16 ± 5%	7.80	7.80	7.80	0.27	0.90 ± 11.0%
5200	± 50 / ± 100	49.0 ± 5%	5.30 ± 5%	4.45	4.45	4.45	0.50	1.80 ± 13.1%
5300	± 50 / ± 100	48.5 ± 5%	5.42 ± 5%	4.18	4.18	4.18	0.55	1.80 ± 13.1%
5500	± 50 / ± 100	48.6 ± 5%	5.65 ± 5%	3.91	3.91	3.91	0.60	1.80 ± 13.1%
5600	± 50 / ± 100	48.5 ± 5%	5.77 ± 5%	3.70	3.70	3.70	0.65	1.80 ± 13.1%
5800	± 50 / ± 100	48.2 ± 5%	6.00 ± 5%	3.95	3.95	3.95	0.60	1.75 ± 13.1%

<sup>c</sup> The validity of ± 100 MHz only applies for DASY v4.4 and higher (see Page 2). The uncertainty is the RSS of the ConvF uncertainty at calibration frequency and the uncertainty for the indicated frequency band.

# Frequency Response of E-Field

(TEM-Cell:ifi110 EXX, Waveguide: R22)

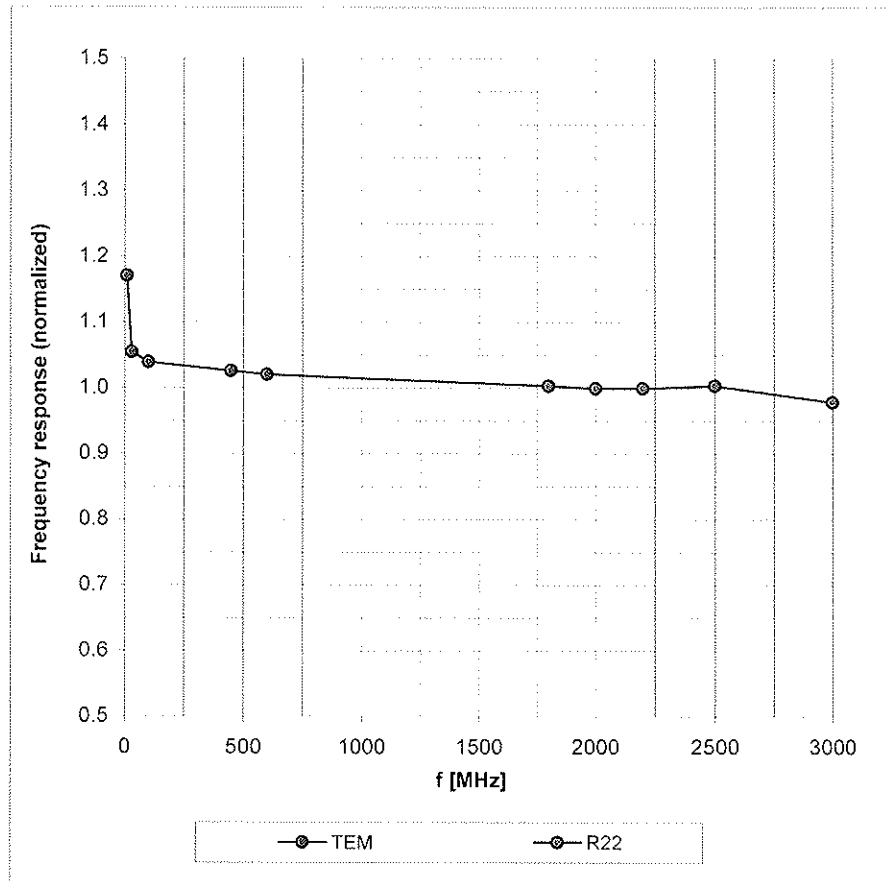

Uncertainty of Frequency Response of E-field:  $\pm 6.3\%$  (k=2)

### Receiving Pattern ( $\phi$ ), $\vartheta = 0^\circ$

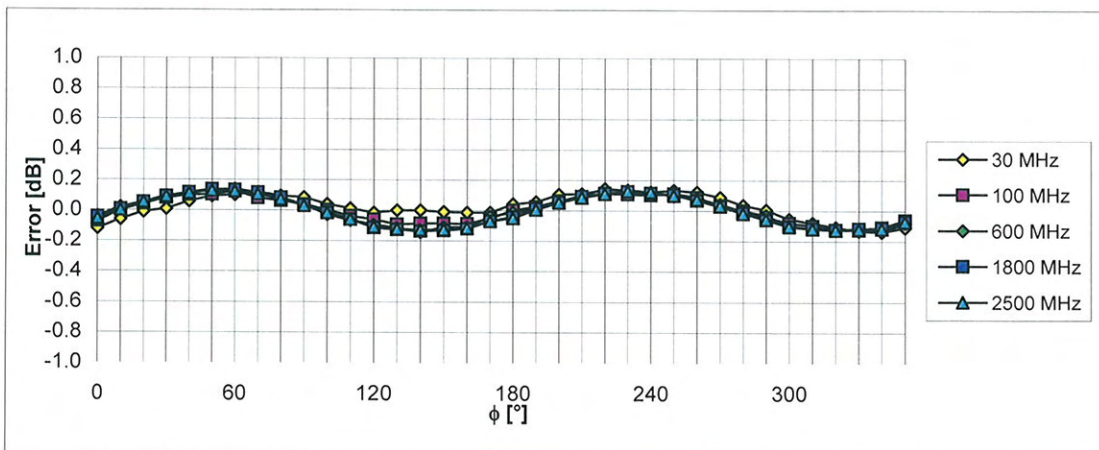
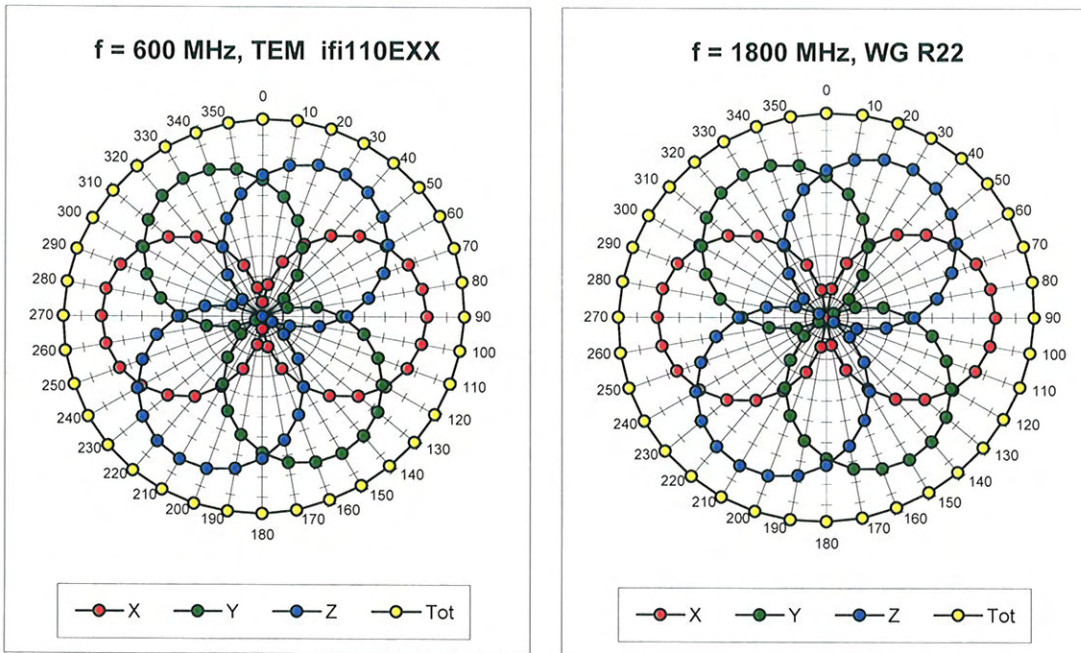

### Dynamic Range $f(SAR_{head})$ (Waveguide R22, $f = 1800$ MHz)

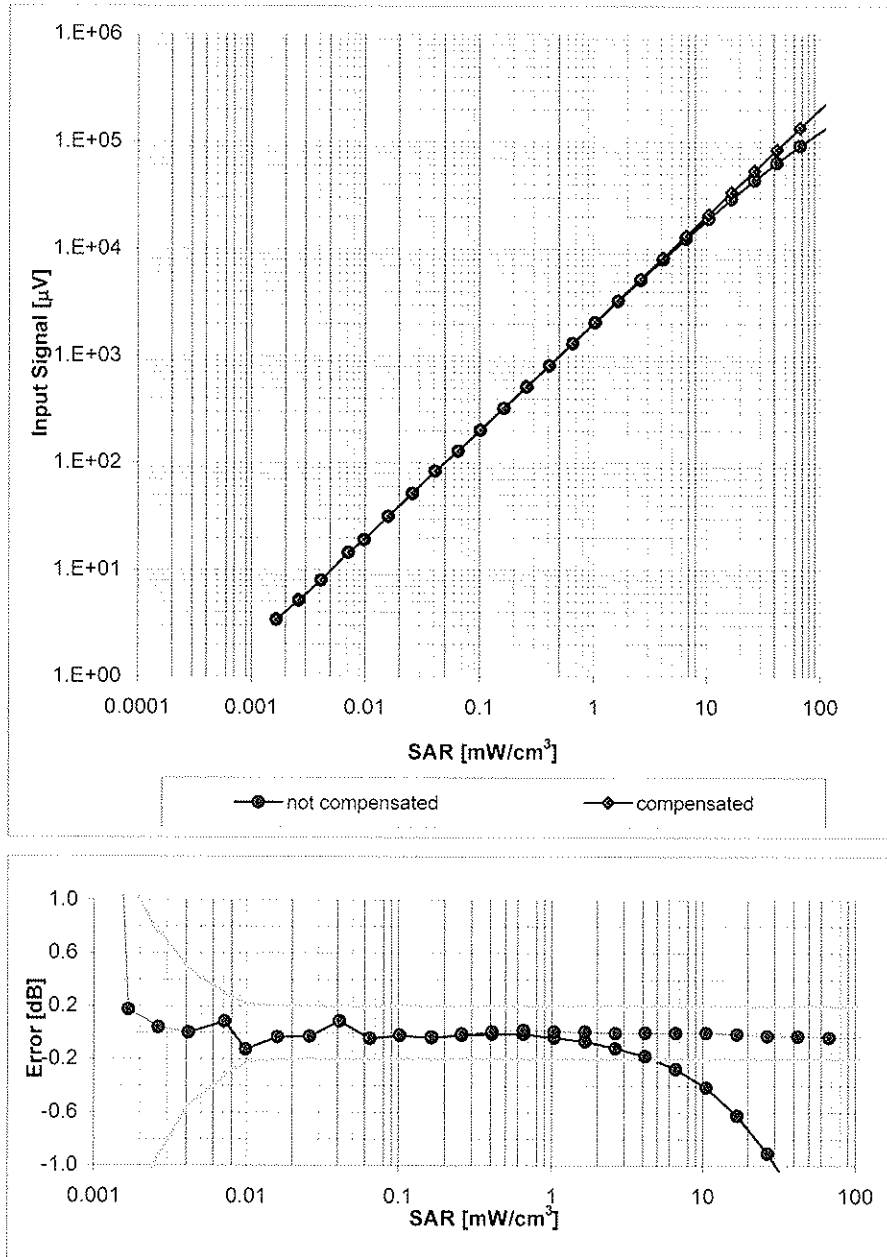

Uncertainty of Linearity Assessment:  $\pm 0.6\%$  ( $k=2$ )

### Conversion Factor Assessment

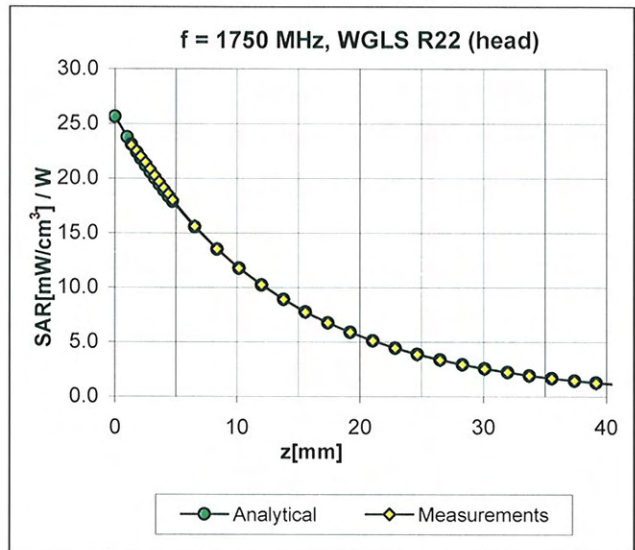
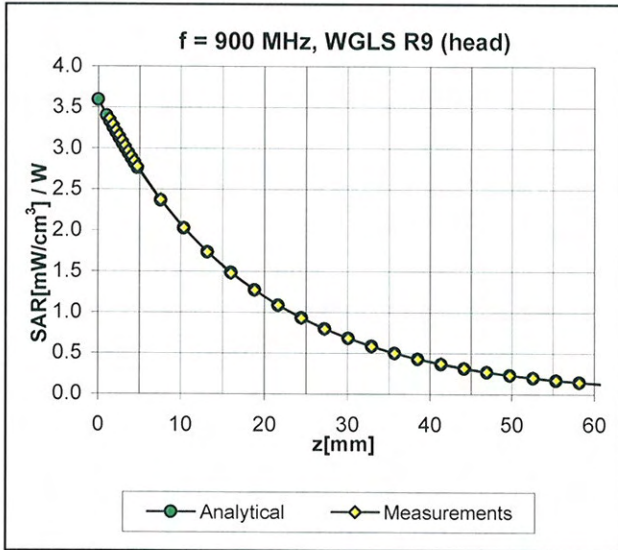

### Deviation from Isotropy in HSL

Error ( $\phi$ ,  $\vartheta$ ), f = 900 MHz

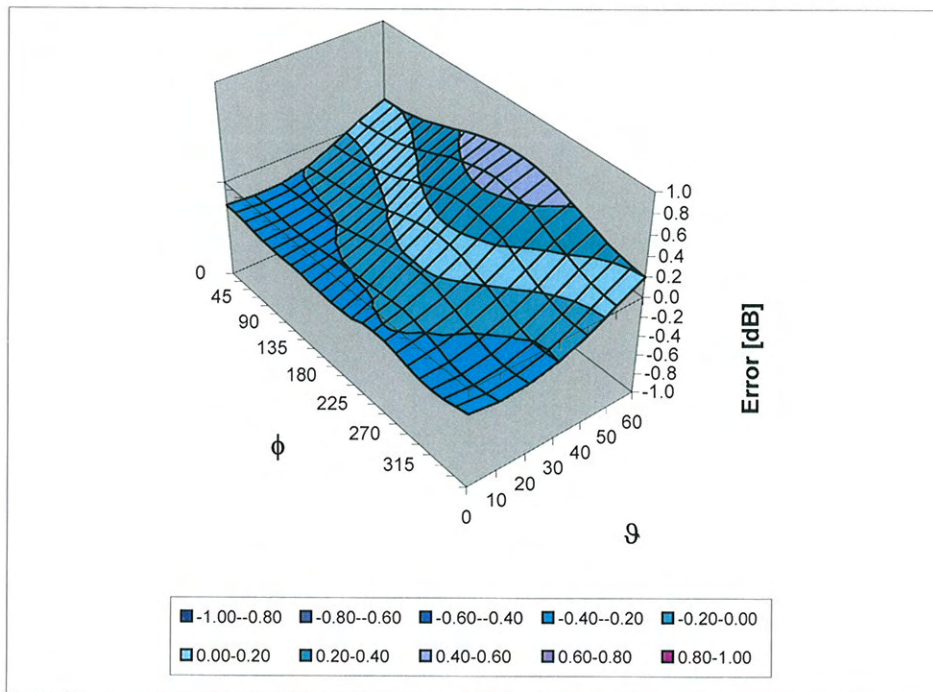

Uncertainty of Spherical Isotropy Assessment:  $\pm 2.6\%$  (k=2)

## Other Probe Parameters

Sensor Arrangement	Triangular
Connector Angle (°)	Not applicable
Mechanical Surface Detection Mode	enabled
Optical Surface Detection Mode	disabled
Probe Overall Length	337 mm
Probe Body Diameter	10 mm
Tip Length	9 mm
Tip Diameter	2.5 mm
Probe Tip to Sensor X Calibration Point	1 mm
Probe Tip to Sensor Y Calibration Point	1 mm
Probe Tip to Sensor Z Calibration Point	1 mm
Recommended Measurement Distance from Surface	2 mm





Accredited by the Swiss Accreditation Service (SAS)  
The Swiss Accreditation Service is one of the signatories to the EA  
Multilateral Agreement for the recognition of calibration certificates

Accreditation No.: **SCS 108**

Client **B.V. ADT (Auden)**

Certificate No: **EX3-3650\_Jan11**

## CALIBRATION CERTIFICATE

Object **EX3DV4 - SN:3650**

Calibration procedure(s) **QA CAL-01.v7, QA CAL-14.v3, QA CAL-23.v4 and QA CAL-25.v3  
Calibration procedure for dosimetric E-field probes**

Calibration date: **January 24, 2011**

This calibration certificate documents the traceability to national standards, which realize the physical units of measurements (SI).  
The measurements and the uncertainties with confidence probability are given on the following pages and are part of the certificate.

All calibrations have been conducted in the closed laboratory facility: environment temperature (22 ± 3)°C and humidity < 70%.

Calibration Equipment used (M&TE critical for calibration)

Primary Standards	ID #	Cal Date (Certificate No.)	Scheduled Calibration
Power meter E4419B	GB41293874	1-Apr-10 (No. 217-01136)	Apr-11
Power sensor E4412A	MY41495277	1-Apr-10 (No. 217-01136)	Apr-11
Power sensor E4412A	MY41498087	1-Apr-10 (No. 217-01136)	Apr-11
Reference 3 dB Attenuator	SN: S5054 (3c)	30-Mar-10 (No. 217-01159)	Mar-11
Reference 20 dB Attenuator	SN: S5086 (20b)	30-Mar-10 (No. 217-01161)	Mar-11
Reference 30 dB Attenuator	SN: S5129 (30b)	30-Mar-10 (No. 217-01160)	Mar-11
Reference Probe ES3DV2	SN: 3013	29-Dec-10 (No. ES3-3013_Dec10)	Dec-11
DAE4	SN: 660	20-Apr-10 (No. DAE4-660_Apr10)	Apr-11
Secondary Standards	ID #	Check Date (in house)	Scheduled Check
RF generator HP 8648C	US3642U01700	4-Aug-99 (in house check Oct-09)	In house check: Oct-11
Network Analyzer HP 8753E	US37390585	18-Oct-01 (in house check Oct-10)	In house check: Oct-11

Calibrated by: **Katja Pokovic**      Name      Function  
**Technical Manager**

Approved by: **Fin Bomholt**      Name      Function  
**R&D Director**

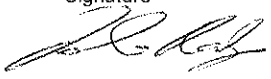
Signature  
  

Issued: January 25, 2011

This calibration certificate shall not be reproduced except in full without written approval of the laboratory.



Accredited by the Swiss Accreditation Service (SAS)

The Swiss Accreditation Service is one of the signatories to the EA  
Multilateral Agreement for the recognition of calibration certificates

Accreditation No.: **SCS 108**

### Glossary:

TSL	tissue simulating liquid
NORM <sub>x,y,z</sub>	sensitivity in free space
ConvF	sensitivity in TSL / NORM <sub>x,y,z</sub>
DCP	diode compression point
CF	crest factor (1/duty_cycle) of the RF signal
A, B, C	modulation dependent linearization parameters
Polarization $\varphi$	$\varphi$ rotation around probe axis
Polarization $\vartheta$	$\vartheta$ rotation around an axis that is in the plane normal to probe axis (at measurement center), i.e., $\vartheta = 0$ is normal to probe axis

### Calibration is Performed According to the Following Standards:

- IEEE Std 1528-2003, "IEEE Recommended Practice for Determining the Peak Spatial-Averaged Specific Absorption Rate (SAR) in the Human Head from Wireless Communications Devices: Measurement Techniques", December 2003
- IEC 62209-1, "Procedure to measure the Specific Absorption Rate (SAR) for hand-held devices used in close proximity to the ear (frequency range of 300 MHz to 3 GHz)", February 2005

### Methods Applied and Interpretation of Parameters:

- NORM<sub>x,y,z</sub>**: Assessed for E-field polarization  $\vartheta = 0$  ( $f \leq 900$  MHz in TEM-cell;  $f > 1800$  MHz: R22 waveguide). NORM<sub>x,y,z</sub> are only intermediate values, i.e., the uncertainties of NORM<sub>x,y,z</sub> does not effect the  $E^2$ -field uncertainty inside TSL (see below *ConvF*).
- NORM(f)<sub>x,y,z</sub>** = NORM<sub>x,y,z</sub> \* *frequency\_response* (see Frequency Response Chart). This linearization is implemented in DASY4 software versions later than 4.2. The uncertainty of the frequency response is included in the stated uncertainty of *ConvF*.
- DCP<sub>x,y,z</sub>**: DCP are numerical linearization parameters assessed based on the data of power sweep with CW signal (no uncertainty required). DCP does not depend on frequency nor media.
- A<sub>x,y,z</sub>; B<sub>x,y,z</sub>; C<sub>x,y,z</sub>; VR<sub>x,y,z</sub>**: A, B, C are numerical linearization parameters assessed based on the data of power sweep for specific modulation signal. The parameters do not depend on frequency nor media. VR is the maximum calibration range expressed in RMS voltage across the diode.
- ConvF and Boundary Effect Parameters**: Assessed in flat phantom using E-field (or Temperature Transfer Standard for  $f \leq 800$  MHz) and inside waveguide using analytical field distributions based on power measurements for  $f > 800$  MHz. The same setups are used for assessment of the parameters applied for boundary compensation (alpha, depth) of which typical uncertainty values are given. These parameters are used in DASY4 software to improve probe accuracy close to the boundary. The sensitivity in TSL corresponds to NORM<sub>x,y,z</sub> \* ConvF whereby the uncertainty corresponds to that given for ConvF. A frequency dependent ConvF is used in DASY version 4.4 and higher which allows extending the validity from  $\pm 50$  MHz to  $\pm 100$  MHz.
- Spherical isotropy (3D deviation from isotropy)**: in a field of low gradients realized using a flat phantom exposed by a patch antenna.
- Sensor Offset**: The sensor offset corresponds to the offset of virtual measurement center from the probe tip (on probe axis). No tolerance required.

# Probe EX3DV4

## SN:3650

Manufactured:	March 18, 2008
Last calibrated:	July 5, 2008
Recalibrated:	January 24, 2011

Calibrated for DASYS/EASY Systems

(Note: non-compatible with DASYS2 system!)

**DASY/EASY - Parameters of Probe: EX3DV4 SN:3650****Basic Calibration Parameters**

	Sensor X	Sensor Y	Sensor Z	Unc (k=2)
Norm ( $\mu\text{V}/(\text{V}/\text{m})^2$ ) <sup>A</sup>	0.45	0.40	0.49	$\pm 10.1\%$
DCP (mV) <sup>B</sup>	93.4	96.5	95.5	

**Modulation Calibration Parameters**

UID	Communication System Name	PAR		A dB	B dBuV	C	VR mV	Unc <sup>E</sup> (k=2)
10000	CW	0.00	X	0.00	0.00	1.00	137.0	$\pm 3.4\%$
			Y	0.00	0.00	1.00	141.2	
			Z	0.00	0.00	1.00	144.7	

The reported uncertainty of measurement is stated as the standard uncertainty of measurement multiplied by the coverage factor  $k=2$ , which for a normal distribution corresponds to a coverage probability of approximately 95%.

<sup>A</sup> The uncertainties of NormX,Y,Z do not affect the  $E^2$ -field uncertainty inside TSL (see Pages 5 and 6).

<sup>B</sup> Numerical linearization parameter: uncertainty not required.

<sup>E</sup> Uncertainty is determined using the maximum deviation from linear response applying recatangular distribution and is expressed for the square of the field value.

## DASY/EASY - Parameters of Probe: EX3DV4 SN:3650

### Calibration Parameter Determined in Head Tissue Simulating Media

f [MHz]	Validity [MHz] <sup>c</sup>	Permittivity	Conductivity	ConvF X	ConvF Y	ConvF Z	Alpha	Depth Unc (k=2)
750	± 50 / ± 100	41.9 ± 5%	0.89 ± 5%	9.46	9.46	9.46	0.43	0.72 ± 11.0%
835	± 50 / ± 100	41.5 ± 5%	0.90 ± 5%	8.95	8.95	8.95	0.55	0.67 ± 11.0%
1450	± 50 / ± 100	40.5 ± 5%	1.20 ± 5%	8.86	8.86	8.86	0.78	0.64 ± 11.0%
1750	± 50 / ± 100	40.1 ± 5%	1.37 ± 5%	8.17	8.17	8.17	0.75	0.60 ± 11.0%
1950	± 50 / ± 100	40.0 ± 5%	1.40 ± 5%	7.57	7.57	7.57	0.57	0.66 ± 11.0%
2450	± 50 / ± 100	39.2 ± 5%	1.80 ± 5%	7.10	7.10	7.10	0.36	0.88 ± 11.0%
2600	± 50 / ± 100	39.0 ± 5%	1.96 ± 5%	6.93	6.93	6.93	0.38	0.88 ± 11.0%
5200	± 50 / ± 100	36.0 ± 5%	4.66 ± 5%	4.69	4.69	4.69	0.40	1.80 ± 13.1%
5300	± 50 / ± 100	35.9 ± 5%	4.76 ± 5%	4.33	4.33	4.33	0.45	1.80 ± 13.1%
5500	± 50 / ± 100	35.6 ± 5%	4.96 ± 5%	4.42	4.42	4.42	0.45	1.80 ± 13.1%
5600	± 50 / ± 100	35.5 ± 5%	5.07 ± 5%	3.96	3.96	3.96	0.60	1.80 ± 13.1%
5800	± 50 / ± 100	35.3 ± 5%	5.27 ± 5%	4.27	4.27	4.27	0.45	1.80 ± 13.1%

<sup>c</sup> The validity of ± 100 MHz only applies for DASY v4.4 and higher (see Page 2). The uncertainty is the RSS of the ConvF uncertainty at calibration frequency and the uncertainty for the indicated frequency band.

## DASY/EASY - Parameters of Probe: EX3DV4 SN:3650

### Calibration Parameter Determined in Body Tissue Simulating Media

f [MHz]	Validity [MHz] <sup>c</sup>	Permittivity	Conductivity	ConvF X	ConvF Y	ConvF Z	Alpha	Depth Unc (k=2)
750	± 50 / ± 100	55.5 ± 5%	0.96 ± 5%	9.25	9.25	9.25	0.53	0.71 ± 11.0%
835	± 50 / ± 100	55.2 ± 5%	0.97 ± 5%	9.12	9.12	9.12	0.36	0.88 ± 11.0%
1450	± 50 / ± 100	54.0 ± 5%	1.30 ± 5%	7.97	7.97	7.97	0.71	0.63 ± 11.0%
1750	± 50 / ± 100	53.4 ± 5%	1.49 ± 5%	7.46	7.46	7.46	0.78	0.61 ± 11.0%
1950	± 50 / ± 100	53.3 ± 5%	1.52 ± 5%	7.52	7.52	7.52	0.79	0.59 ± 11.0%
2450	± 50 / ± 100	52.7 ± 5%	1.95 ± 5%	7.05	7.05	7.05	0.54	0.74 ± 11.0%
2600	± 50 / ± 100	52.5 ± 5%	2.16 ± 5%	6.92	6.92	6.92	0.45	0.80 ± 11.0%
5200	± 50 / ± 100	49.0 ± 5%	5.30 ± 5%	4.25	4.25	4.25	0.50	1.90 ± 13.1%
5300	± 50 / ± 100	48.9 ± 5%	5.42 ± 5%	3.96	3.96	3.96	0.50	1.90 ± 13.1%
5500	± 50 / ± 100	48.6 ± 5%	5.65 ± 5%	3.76	3.76	3.76	0.55	1.90 ± 13.1%
5600	± 50 / ± 100	48.5 ± 5%	5.77 ± 5%	3.55	3.55	3.55	0.58	1.90 ± 13.1%
5800	± 50 / ± 100	48.2 ± 5%	6.00 ± 5%	3.86	3.86	3.86	0.60	1.90 ± 13.1%

<sup>c</sup> The validity of ± 100 MHz only applies for DASY v4.4 and higher (see Page 2). The uncertainty is the RSS of the ConvF uncertainty at calibration frequency and the uncertainty for the indicated frequency band.

### Frequency Response of E-Field

(TEM-Cell:ifi110 EXX, Waveguide: R22)

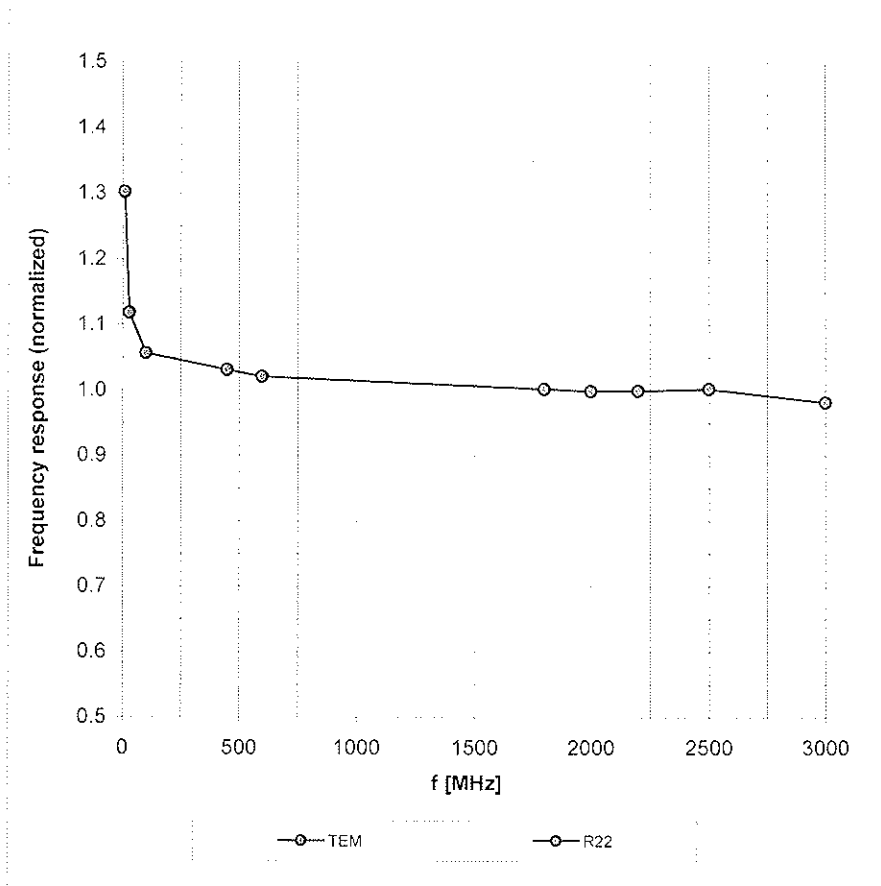

Uncertainty of Frequency Response of E-field:  $\pm 6.3\%$  (k=2)

### Receiving Pattern ( $\phi$ ), $\vartheta = 0^\circ$

f = 600 MHz, TEM ifi110EXX

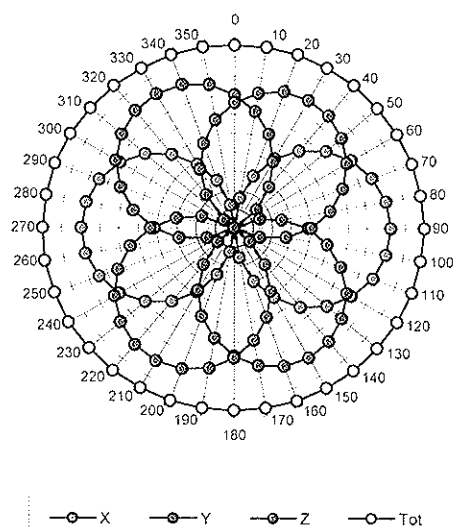

f = 1800 MHz, WG R22

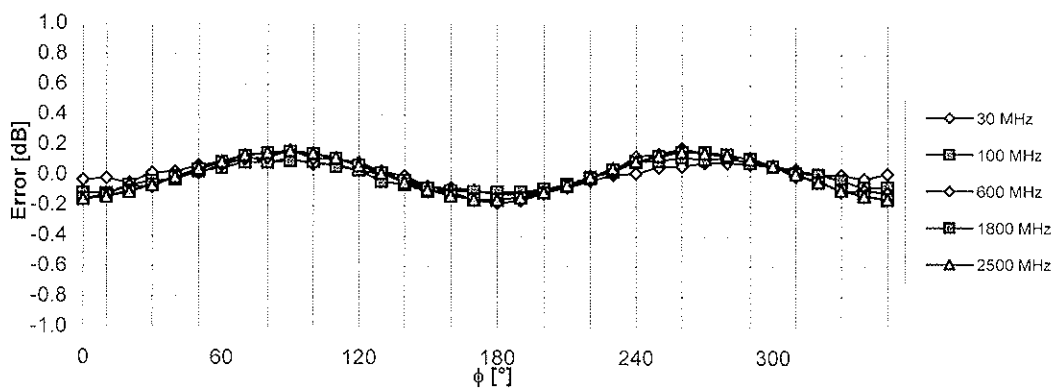
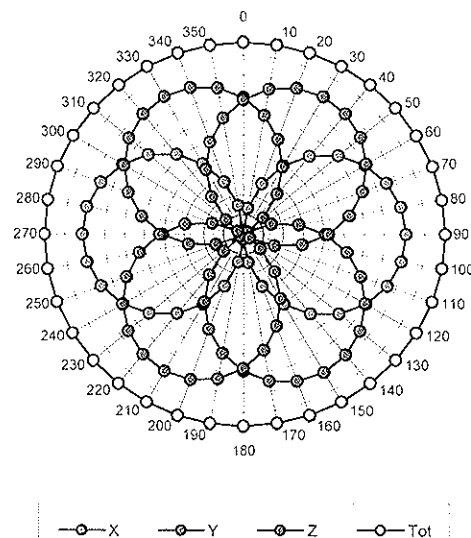

Uncertainty of Axial Isotropy Assessment:  $\pm 0.5\%$  ( $k=2$ )



### Dynamic Range f(SAR<sub>head</sub>)

(TEM cell, f = 900 MHz)

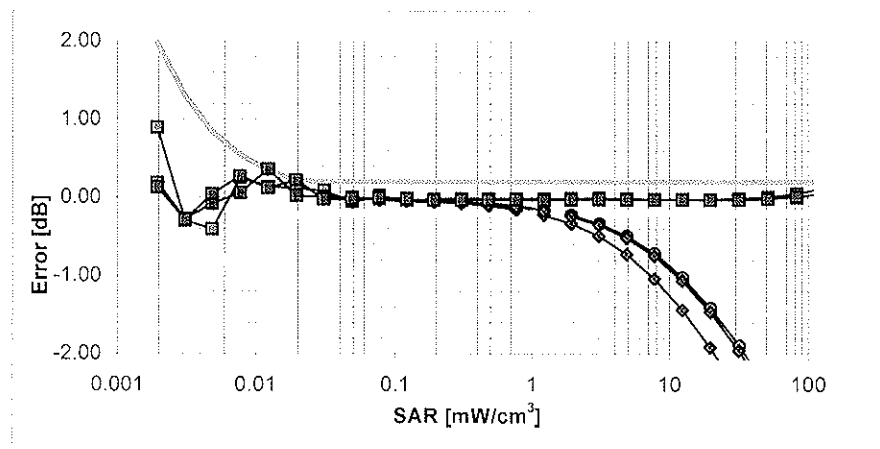
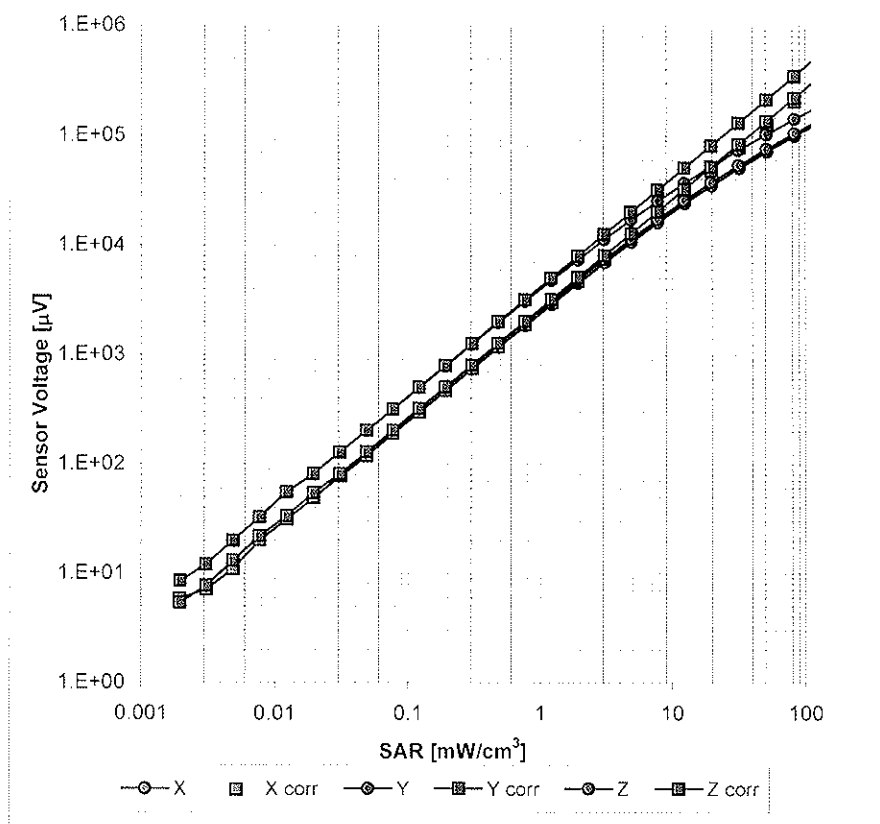

Uncertainty of Linearity Assessment: ± 0.6% (k=2)

### Conversion Factor Assessment

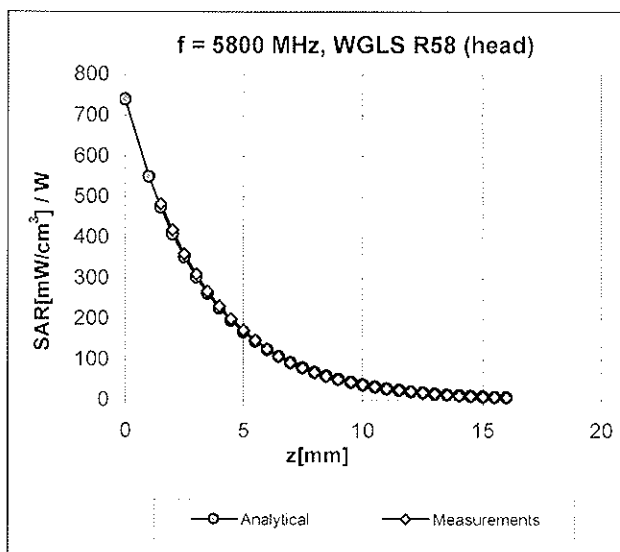
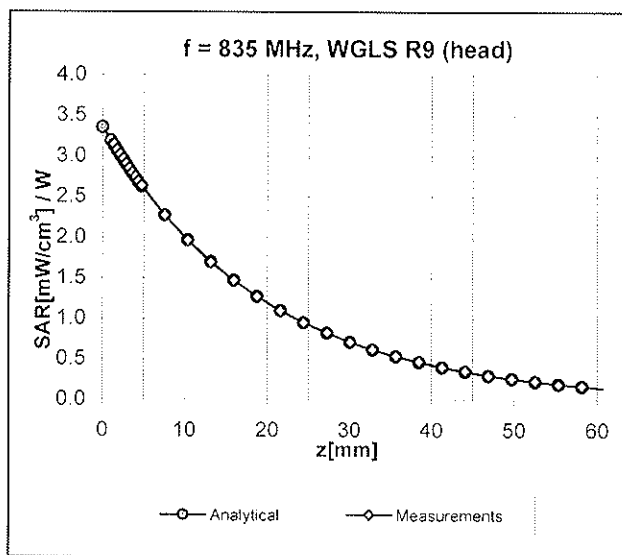

### Deviation from Isotropy in HSL

Error ( $\phi, \vartheta$ ), f = 900 MHz

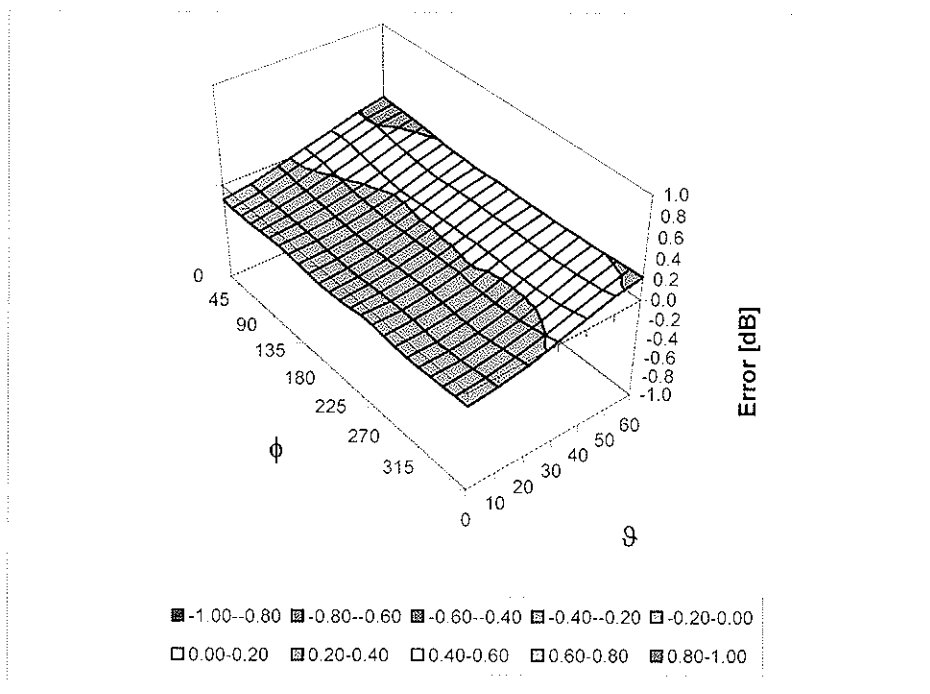

Uncertainty of Spherical Isotropy Assessment:  $\pm 2.6\%$  (k=2)

## Other Probe Parameters

Sensor Arrangement	Triangular
Connector Angle (°)	Not applicable
Mechanical Surface Detection Mode	enabled
Optical Surface Detection Mode	disabled
Probe Overall Length	337 mm
Probe Body Diameter	10 mm
Tip Length	9 mm
Tip Diameter	2.5 mm
Probe Tip to Sensor X Calibration Point	1 mm
Probe Tip to Sensor Y Calibration Point	1 mm
Probe Tip to Sensor Z Calibration Point	1 mm
Recommended Measurement Distance from Surface	2 mm



**D3: DAE**

## IMPORTANT NOTICE

### USAGE OF THE DAE 4

The DAE unit is a delicate, high precision instrument and requires careful treatment by the user. There are no serviceable parts inside the DAE. Special attention shall be given to the following points:

**Battery Exchange:** The battery cover of the DAE4 unit is closed using a screw, over tightening the screw may cause the threads inside the DAE to wear out.

**Shipping of the DAE:** Before shipping the DAE to SPEAG for calibration, remove the batteries and pack the DAE in an antistatic bag. This antistatic bag shall then be packed into a larger box or container which protects the DAE from impacts during transportation. The package shall be marked to indicate that a fragile instrument is inside.

**E-Stop Failures:** Touch detection may be malfunctioning due to broken magnets in the E-stop. Rough handling of the E-stop may lead to damage of these magnets. Touch and collision errors are often caused by dust and dirt accumulated in the E-stop. To prevent E-stop failure, the customer shall always mount the probe to the DAE carefully and keep the DAE unit in a non-dusty environment if not used for measurements.

**Repair:** Minor repairs are performed at no extra cost during the annual calibration. However, SPEAG reserves the right to charge for any repair especially if rough unprofessional handling caused the defect.

**DASY Configuration Files:** Since the exact values of the DAE input resistances, as measured during the calibration procedure of a DAE unit, are not used by the DASY software, a nominal value of 200 MOhm is given in the corresponding configuration file.

**Important Note:**

**Warranty and calibration is void if the DAE unit is disassembled partly or fully by the Customer.**

**Important Note:**

**Never attempt to grease or oil the E-stop assembly. Cleaning and readjusting of the E-stop assembly is allowed by certified SPEAG personnel only and is part of the annual calibration procedure.**

**Important Note:**

**To prevent damage of the DAE probe connector pins, use great care when installing the probe to the DAE. Carefully connect the probe with the connector notch oriented in the mating position. Avoid any rotational movement of the probe body versus the DAE while turning the locking nut of the connector. The same care shall be used when disconnecting the probe from the DAE.**



Accredited by the Swiss Accreditation Service (SAS)  
The Swiss Accreditation Service is one of the signatories to the EA  
Multilateral Agreement for the recognition of calibration certificates

Accreditation No.: **SCS 108**

Client **BV - ADT (Auden)**

Certificate No: **DAE4-861\_Jan10**

**CALIBRATION CERTIFICATE**

Object **DAE4 - SD 000 D04 BJ - SN: 861**

Calibration procedure(s) **QA CAL-06.v12  
Calibration procedure for the data acquisition electronics (DAE)**

Calibration date: **January 22, 2010**

This calibration certificate documents the traceability to national standards, which realize the physical units of measurements (SI).  
The measurements and the uncertainties with confidence probability are given on the following pages and are part of the certificate.

All calibrations have been conducted in the closed laboratory facility: environment temperature (22 ± 3)°C and humidity < 70%.

Calibration Equipment used (M&TE critical for calibration)

Primary Standards	ID #	Cal Date (Certificate No.)	Scheduled Calibration
Keithley Multimeter Type 2001	SN: 0810278	1-Oct-09 (No: 9055)	Oct-10
Secondary Standards	ID #	Check Date (in house)	Scheduled Check
Calibrator Box V1.1	SE UMS 006 AB 1004	05-Jun-09 (in house check)	In house check: Jun-10

Calibrated by: **Name: Andrea Guntli, Function: Technician, Signature: [Handwritten Signature]**

Approved by: **Name: Fin Bomholt, Function: R&D Director, Signature: [Handwritten Signature]**

Issued: January 22, 2010

This calibration certificate shall not be reproduced except in full without written approval of the laboratory.



Accredited by the Swiss Accreditation Service (SAS)  
The Swiss Accreditation Service is one of the signatories to the EA  
Multilateral Agreement for the recognition of calibration certificates

Accreditation No.: **SCS 108**

## Glossary

DAE data acquisition electronics  
Connector angle information used in DASY system to align probe sensor X to the robot coordinate system.

## Methods Applied and Interpretation of Parameters

- *DC Voltage Measurement*: Calibration Factor assessed for use in DASY system by comparison with a calibrated instrument traceable to national standards. The figure given corresponds to the full scale range of the voltmeter in the respective range.
- *Connector angle*: The angle of the connector is assessed measuring the angle mechanically by a tool inserted. Uncertainty is not required.
- The following parameters as documented in the Appendix contain technical information as a result from the performance test and require no uncertainty.
  - *DC Voltage Measurement Linearity*: Verification of the Linearity at +10% and -10% of the nominal calibration voltage. Influence of offset voltage is included in this measurement.
  - *Common mode sensitivity*: Influence of a positive or negative common mode voltage on the differential measurement.
  - *Channel separation*: Influence of a voltage on the neighbor channels not subject to an input voltage.
  - *AD Converter Values with inputs shorted*: Values on the internal AD converter corresponding to zero input voltage
  - *Input Offset Measurement*: Output voltage and statistical results over a large number of zero voltage measurements.
  - *Input Offset Current*: Typical value for information; Maximum channel input offset current, not considering the input resistance.
  - *Input resistance*: DAE input resistance at the connector, during internal auto-zeroing and during measurement.
  - *Low Battery Alarm Voltage*: Typical value for information. Below this voltage, a battery alarm signal is generated.
  - *Power consumption*: Typical value for information. Supply currents in various operating modes.

## DC Voltage Measurement

A/D - Converter Resolution nominal

High Range: 1LSB = 6.1 $\mu$ V, full range = -100...+300 mV

Low Range: 1LSB = 61nV, full range = -1.....+3mV

DASY measurement parameters: Auto Zero Time: 3 sec; Measuring time: 3 sec

Calibration Factors	X	Y	Z
High Range	404.395 $\pm$ 0.1% (k=2)	404.784 $\pm$ 0.1% (k=2)	405.737 $\pm$ 0.1% (k=2)
Low Range	4.01182 $\pm$ 0.7% (k=2)	3.98893 $\pm$ 0.7% (k=2)	4.01269 $\pm$ 0.7% (k=2)

## Connector Angle

Connector Angle to be used in DASY system	123.0 $^{\circ}$ $\pm$ 1 $^{\circ}$
---	-------------------------------------



## Appendix

### 1. DC Voltage Linearity

High Range		Reading ( $\mu\text{V}$ )	Difference ( $\mu\text{V}$ )	Error (%)
Channel X	+ Input	200003.4	-2.33	-0.00
Channel X	+ Input	19997.73	-1.97	-0.01
Channel X	- Input	-19999.33	1.07	-0.01
Channel Y	+ Input	200002.5	-2.16	-0.00
Channel Y	+ Input	19995.17	-4.43	-0.02
Channel Y	- Input	-20000.88	-0.58	0.00
Channel Z	+ Input	199999.9	-3.99	-0.00
Channel Z	+ Input	19995.97	-3.43	-0.02
Channel Z	- Input	-20002.39	0.01	0.01

Low Range		Reading ( $\mu\text{V}$ )	Difference ( $\mu\text{V}$ )	Error (%)
Channel X	+ Input	1999.9	-0.34	-0.02
Channel X	+ Input	199.26	-0.64	-0.32
Channel X	- Input	-200.72	-0.82	0.41
Channel Y	+ Input	1999.2	-0.72	-0.04
Channel Y	+ Input	198.82	-1.18	-0.59
Channel Y	- Input	-201.63	-1.83	0.92
Channel Z	+ Input	2001.1	1.22	0.06
Channel Z	+ Input	197.99	-2.01	-1.01
Channel Z	- Input	-201.59	-1.79	0.89

### 2. Common mode sensitivity

DASY measurement parameters: Auto Zero Time: 3 sec; Measuring time: 3 sec

	Common mode Input Voltage (mV)	High Range Average Reading ( $\mu\text{V}$ )	Low Range Average Reading ( $\mu\text{V}$ )
Channel X	200	5.69	4.19
	- 200	-2.41	-3.99
Channel Y	200	1.24	1.40
	- 200	-2.43	-2.38
Channel Z	200	-9.16	-9.25
	- 200	8.58	8.07

### 3. Channel separation

DASY measurement parameters: Auto Zero Time: 3 sec; Measuring time: 3 sec

	Input Voltage (mV)	Channel X ( $\mu\text{V}$ )	Channel Y ( $\mu\text{V}$ )	Channel Z ( $\mu\text{V}$ )
Channel X	200	-	2.32	1.39
Channel Y	200	1.89	-	4.20
Channel Z	200	1.32	0.19	-

#### 4. AD-Converter Values with inputs shorted

DASY measurement parameters: Auto Zero Time: 3 sec; Measuring time: 3 sec

	High Range (LSB)	Low Range (LSB)
Channel X	15980	16853
Channel Y	16068	14547
Channel Z	16038	17866

#### 5. Input Offset Measurement

DASY measurement parameters: Auto Zero Time: 3 sec; Measuring time: 3 sec

Input 10M $\Omega$

	Average ( $\mu$ V)	min. Offset ( $\mu$ V)	max. Offset ( $\mu$ V)	Std. Deviation ( $\mu$ V)
Channel X	0.16	-1.64	1.60	0.66
Channel Y	-0.58	-2.29	0.44	0.49
Channel Z	-1.24	-3.18	0.50	0.68

#### 6. Input Offset Current

Nominal Input circuitry offset current on all channels: <25fA

#### 7. Input Resistance

	Zeroing (MOhm)	Measuring (MOhm)
Channel X	0.1999	199.8
Channel Y	0.2000	201.8
Channel Z	0.1999	199.7

#### 8. Low Battery Alarm Voltage (verified during pre test)

Typical values	Alarm Level (VDC)
Supply (+ Vcc)	+7.9
Supply (- Vcc)	-7.6

#### 9. Power Consumption (verified during pre test)

Typical values	Switched off (mA)	Stand by (mA)	Transmitting (mA)
Supply (+ Vcc)	+0.0	+6	+14
Supply (- Vcc)	-0.01	-8	-9