



FCC TEST REPORT (PART 22)

REPORT NO.: RF990819C03B-1

MODEL NO.: CC61

FCC ID: YY3-017LRBT

RECEIVED: Aug. 19, 2010

TESTED: Sep. 07 ~ Oct. 18, 2010

ISSUED: Oct. 27, 2011

APPLICANT: HANDHELD GROUP AB

ADDRESS: Kinnegatan 17 A,S-531 33 Lidkoping,Sweden

ISSUED BY: Bureau Veritas Consumer Products Services
(H.K.) Ltd., Taoyuan Branch

LAB ADDRESS: No. 47, 14th Ling, Chia Pau Vil., Lin Kou Dist.,
New Taipei City, Taiwan (R.O.C)

TEST LOCATION: No. 19, Hwa Ya 2nd Rd, Wen Hwa Tsuen, Kwei
Shan Hsiang, Taoyuan Hsien 333, Taiwan, R.O.C.

This test report consists of 94 pages in total. It may be duplicated completely for legal use with the approval of the applicant. It should not be reproduced except in full, without the written approval of our laboratory. The client should not use it to claim product endorsement by TAF or any government agencies. The test results in the report only apply to the tested sample.





TABLE OF CONTENTS

RELEASE CONTROL RECORD	4
1 CERTIFICATION	5
2 SUMMARY OF TEST RESULTS	6
2.1 MEASUREMENT UNCERTAINTY	6
3 GENERAL INFORMATION.....	7
3.1 GENERAL DESCRIPTION OF EUT.....	7
3.2 DESCRIPTION OF TEST MODES.....	8
3.2.1 CONFIGURATION OF SYSTEM UNDER TEST	9
3.2.2 TEST MODE APPLICABILITY AND TESTED CHANNEL DETAIL.....	10
3.3 GENERAL DESCRIPTION OF APPLIED STANDARDS	16
3.4 DESCRIPTION OF SUPPORT UNITS	16
4 TEST TYPES AND RESULTS.....	17
4.1 OUTPUT POWER MEASUREMENT	17
4.1.1 LIMITS OF OUTPUT POWER MEASUREMENT.....	17
4.1.2 TEST INSTRUMENTS	18
4.1.3 TEST PROCEDURES.....	19
4.1.4 TEST SETUP	20
4.1.5 EUT OPERATING CONDITIONS.....	20
4.1.6 TEST RESULTS	21
4.2 FREQUENCY STABILITY MEASUREMENT	29
4.2.1 LIMITS OF FREQUENCY STABILITY MEASUREMENT.....	29
4.2.2 TEST INSTRUMENTS	29
4.2.3 TEST PROCEDURE	30
4.2.4 TEST SETUP	30
4.2.5 TEST RESULTS	31
4.3 OCCUPIED BANDWIDTH MEASUREMENT.....	34
4.3.1 LIMITS OF OCCUPIED BANDWIDTH MEASUREMENT.....	34
4.3.2 TEST INSTRUMENTS	34
4.3.3 TEST SETUP	34
4.3.4 TEST PROCEDURES.....	35
4.3.5 EUT OPERATING CONDITION	35
4.3.6 TEST RESULTS	36
4.4 BAND EDGE MEASUREMENT	44
4.4.1 LIMITS OF BAND EDGE MEASUREMENT.....	44
4.4.2 TEST INSTRUMENTS	44
4.4.3 TEST SETUP	44
4.4.4 TEST PROCEDURES.....	45
4.4.5 EUT OPERATING CONDITION	45
4.4.6 TEST RESULTS	46
4.5 CONDUCTED SPURIOUS EMISSIONS.....	54
4.5.1 LIMITS OF CONDUCTED SPURIOUS EMISSIONS MEASUREMENT.....	54
4.5.2 TEST INSTRUMENTS	54
4.5.3 TEST PROCEDURE	55
4.5.4 TEST SETUP	55
4.5.5 EUT OPERATING CONDITIONS.....	55
4.5.6 TEST RESULTS	56
4.6 RADIATED EMISSION MEASUREMENT (BELOW 1GHZ).....	74
4.6.1 LIMITS OF RADIATED EMISSION MEASUREMENT.....	74
4.6.2 TEST INSTRUMENTS	74
4.6.3 TEST PROCEDURES.....	75



A D T

4.6.4	DEVIATION FROM TEST STANDARD	75
4.6.5	TEST SETUP	76
4.6.6	EUT OPERATING CONDITIONS	76
4.6.7	TEST RESULTS	77
4.7	RADIATED EMISSION MEASUREMENT (ABOVE 1GHZ).....	80
4.7.1	LIMITS OF RADIATED EMISSION MEASUREMENT	80
4.7.2	TEST INSTRUMENTS	80
4.7.3	TEST PROCEDURES	81
4.7.4	DEVIATION FROM TEST STANDARD	81
4.7.5	TEST SETUP	82
4.7.6	EUT OPERATING CONDITIONS	82
4.7.7	TEST RESULTS	83
5	PHOTOGRAPHS OF THE TEST CONFIGURATION.....	92
6	INFORMATION ON THE TESTING LABORATORIES	93
7	APPENDIX A – MODIFICATIONS RECORDERS FOR ENGINEERING CHANGES TO THE EUT BY THE LAB.....	94



RELEASE CONTROL RECORD

ISSUE NO.	REASON FOR CHANGE	DATE ISSUED
Original release	N/A	Oct. 27, 2011



1 CERTIFICATION

PRODUCT: 7 inch Handheld Tablet PC

MODEL: CC61

BRAND: Handheld

APPLICANT: HANDHELD GROUP AB

TESTED: Sep. 07 ~ Oct. 18, 2010

TEST SAMPLE: ENGINEERING SAMPLE

STANDARDS: FCC Part 22, Subpart H
ANSI C63.4-2003

The above equipment (model: CC61) has been tested by **Bureau Veritas Consumer Products Services (H.K.) Ltd., Taoyuan Branch**, and found compliance with the requirement of the above standards. The test record, data evaluation & Equipment Under Test (EUT) configurations represented herein are true and accurate accounts of the measurements of the sample's EMC characteristics under the conditions specified in this report.

PREPARED BY : Andrea Hsia, DATE : Oct. 27, 2011
Andrea Hsia / Specialist

APPROVED BY : Gary Chang, DATE : Oct. 27, 2011
Gary Chang / Technical Manager

2 SUMMARY OF TEST RESULTS

The EUT has been tested according to the following specifications:

APPLIED STANDARD: FCC Part 22 & Part 2			
STANDARD SECTION	TEST TYPE AND LIMIT	RESULT	REMARK
2.1046 22.913 (a)	Maximum Peak Output Power Limit: max. 7 watts e.r.p peak power	PASS	Meet the requirement of limit. Minimum passing margin is 23.5dBm at 824.2MHz.
2.1055	Frequency Stability AFC Freq. Error vs. Voltage AFC Freq. Error vs. Temperature Limit: max. ± 2.5 ppm	PASS	Meet the requirement of limit.
2.1049 (h)	Occupied Bandwidth	PASS	Meet the requirement of limit.
22.917	Band Edge Measurements	PASS	Meet the requirement of limit.
2.1051 22.917	Conducted Spurious Emissions	PASS	Meet the requirement of limit.
2.1053 22.917	Radiated Spurious Emissions	PASS	Meet the requirement of limit. Minimum passing margin is -12.9dB at 2509.8MHz.

2.1 MEASUREMENT UNCERTAINTY

Where relevant, the following measurement uncertainty levels have been estimated for tests performed on the EUT as specified in CISPR 16-4-2:

MEASUREMENT	FREQUENCY	UNCERTAINTY
Conducted emissions	9kHz~30MHz	2.44 dB
Radiated emissions	30MHz ~ 200MHz	3.34 dB
	200MHz ~1000MHz	3.35 dB
	1GHz ~ 18GHz	2.26 dB
	18GHz ~ 40GHz	1.94 dB

This uncertainty represents an expanded uncertainty expressed at approximately the 95% confidence level using a coverage factor of $k=2$.

3 GENERAL INFORMATION

3.1 GENERAL DESCRIPTION OF EUT

EUT	7 inch Handheld Tablet PC	
MODEL NO.	CC61	
FCC ID	YY3-017LRBT	
NOMINAL VOLTAGE	12Vdc (adapter) 7.4Vdc (Battery)	
MODULATION TYPE	GPRS, E-GPRS	GMSK, 8PSK
	CDMA	QPSK, OQPSK, HPSK
	WCDMA	BPSK
FREQUENCY RANGE	GPRS, E-GPRS	824.2MHz ~ 848.8MHz
	CDMA	824.7MHz ~ 848.31MHz
	WCDMA	826.4MHz ~ 846.6MHz
NUMBER OF CHANNEL	GPRS, E-GPRS	124
	CDMA	788
	WCDMA	102
MAX. ERP POWER	GPRS	0.2213Watt
	E-GPRS	0.0767Watt
	CDMA	0.0462Watt
	WCDMA	0.0335Watt
ANTENNA TYPE	Printed PCB antenna with -4.688dBi gain	
I/O PORTS	Refer to user's manual	
DATA CABLE	NA	
ACCESSORY DEVICES	Adapter, Battery	

NOTE:

- This report is issued as a duplicate report of BV ADT report no.: RF990819C03-2. The differences compared with original report are listing as below.

**Changed model, FCC ID.

**Removed Bluetooth module.

- The EUT was powered by the following adapter & battery:

ADAPTER	
BRAND:	EDAC
MODEL:	EA1050C-120
INPUT:	100-240Vac, 50/60Hz, 1.8A
OUTPUT:	12Vdc, 4.16A
POWER LINE:	AC: 1.8m non-shielded cable with one core DC: 1.8m shielded cable without core

BATTERY	
RATING:	7.4Vdc 2S1P, 2600mAh

- The EUT has no voice function.
- Hardware version: I983S.
- Software version: V3.0.1.6.
- The above EUT information was declared by manufacturer and for more detailed features description, please refer to the manufacturer's specifications or User's Manual.

3.2 DESCRIPTION OF TEST MODES

FOR GPRS & E-GPRS:

124 channels are provided to this EUT. Therefore, the low, middle and high channels are chosen for testing.

	CHANNEL	FREQUENCY	TX MODE
LOW	128	824.2 MHz	GPRS, E-GPRS
MIDDLE	190	836.6 MHz	GPRS, E-GPRS
HIGH	251	848.8 MHz	GPRS, E-GPRS

NOTE:

1. Below 1 GHz, the channel 128, 190, and 251 were pre-tested in chamber. The channel 251 was chosen for final test.
2. Above 1 GHz, the channel 128, 190, and 251 were tested individually.
3. The worst case for final test is chosen when the power control level set 5.
4. The channel space is 0.2MHz.
5. The EUT is a GPRS class 10 device (Multislot class: 10, Mobile Terminal B), which provide 2 up-link. After pre-tested both functions, found up-link with 1 time slot is worse, therefore, test results of output power, frequency stability, occupied bandwidth and band edge tests came out from this.
6. The EUT is an E-GPRS class 10 device (Multislot class: 10, Mobile Terminal B), which provide 2 up-link. After pre-tested both functions, found up-link with 1 time slot is worse, therefore, test results of output power, frequency stability, occupied bandwidth and band edge tests came out from this.
7. The EUT has GPRS & E-GPRS functions. After pre-testing, GPRS function is the worst case for all the emission tests.

FOR CDMA:

788 channels are provided to this EUT in the CDMA850 band. Therefore, the low, middle and high channels are chosen for testing.

	CHANNEL	FREQUENCY	TX MODE
LOW	1013	824.70 MHz	SO55
MIDDLE	384	836.52 MHz	SO55
HIGH	777	848.31 MHz	SO55

NOTE:

1. Below 1 GHz, the channel 1013, 384 and 777 were pre-tested in chamber. The channel 777 was the worst case and chosen for final test.
2. Above 1 GHz, the channel 1013, 384 and 777 were tested individually.
3. The channel space is 0.03MHz.
4. In this report, CDMA2000 (SO55) was the worst case for all test items, therefore, only the data was recorded in the following section.

FOR WCDMA:

102 channels are provided to this EUT. Therefore, the low, middle and high channels are chosen for testing.

	CHANNEL	FREQUENCY	TX MODE
LOW	4132	826.4 MHz	WCDMA
MIDDLE	4182	836.4 MHz	WCDMA
HIGH	4233	846.6 MHz	WCDMA

NOTE:

1. Below 1 GHz, the channel 4132, 4182 and 4233 were pre-tested in chamber. The channel 4233 was chosen for final test.
2. Above 1 GHz, the channel 4132, 4182 and 4233 were tested individually.
3. The channel space is 0.2MHz.
4. WCDMA-RMC mode has been chosen for the worst case to do the final test and record.

3.2.1 CONFIGURATION OF SYSTEM UNDER TEST

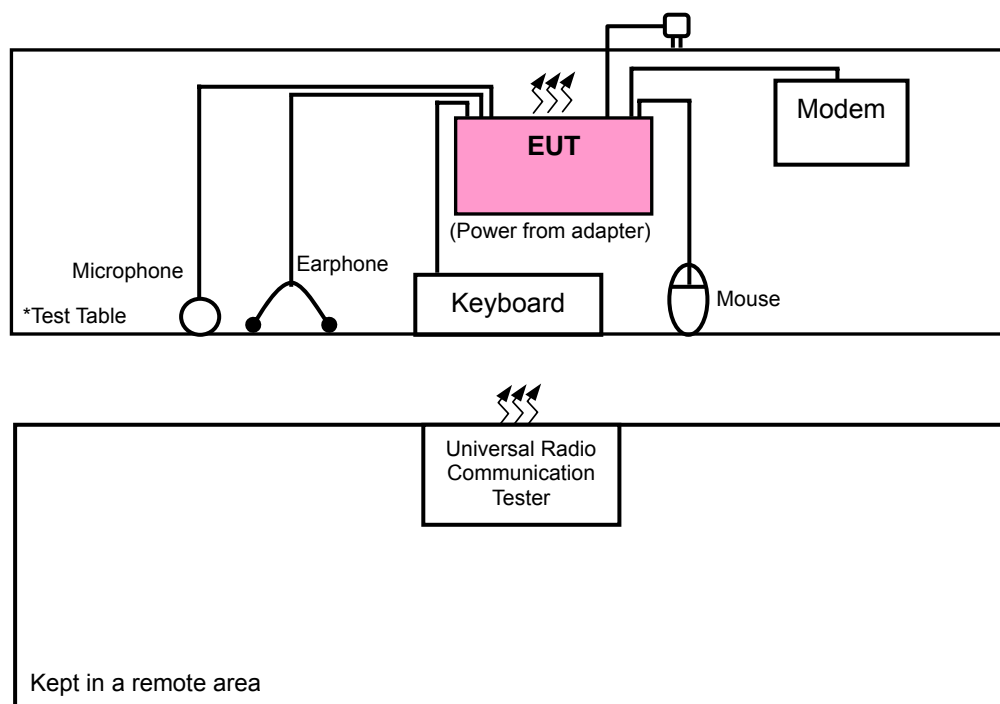

3.2.2 TEST MODE APPLICABILITY AND TESTED CHANNEL DETAIL FOR GPRS & E-GPRS:

EUT CONFIGURE MODE	APPLICABLE TO							DESCRIPTION
	OP	FS	OB	BE	CE	RE<1G	RE≥1G	
-	√	√	√	√	√	√	√	-

Where **OP**: Output power **FS**: Frequency stability
OB: Occupied bandwidth **BE**: Band edge
CE: Conducted spurious emissions **RE<1G**: Radiated emission below 1GHz
RE≥1G: Radiated emission above 1GHz

OUTPUT POWER MEASUREMENT:

- Pre-Scan has been conducted to determine the worst-case mode from all possible combinations between available modulations and antenna ports (if EUT with antenna diversity architecture).
- Following channel(s) was (were) selected for the final test as listed below.

AVAILABLE CHANNEL	TESTED CHANNEL	MODULATION TECHNOLOGY
128 to 251	128, 190, 251	GPRS, EGPRS

FREQUENCY STABILITY MEASUREMENT:

- Pre-Scan has been conducted to determine the worst-case mode from all possible combinations between available modulations and antenna ports (if EUT with antenna diversity architecture).
- Following channel(s) was (were) selected for the final test as listed below.

AVAILABLE CHANNEL	TESTED CHANNEL	MODULATION TECHNOLOGY
128 to 251	190	GPRS

OCCUPIED BANDWIDTH MEASUREMENT:

- This item includes all test value of each mode, but only includes spectrum plot of worst value of each mode.
- Pre-Scan has been conducted to determine the worst-case mode from all possible combinations between available modulations and antenna ports (if EUT with antenna diversity architecture).
- Following channel(s) was (were) selected for the final test as listed below.

AVAILABLE CHANNEL	TESTED CHANNEL	MODULATION TECHNOLOGY
128 to 251	128, 190, 251	GPRS, EGPRS

BAND EDGE MEASUREMENT:

- Pre-Scan has been conducted to determine the worst-case mode from all possible combinations between available modulations and antenna ports (if EUT with antenna diversity architecture).
- Following channel(s) was (were) selected for the final test as listed below.

AVAILABLE CHANNEL	TESTED CHANNEL	MODULATION TECHNOLOGY
128 to 251	128, 251	GPRS, EGPRS



CONDUCTED SPURIOUS EMISSIONS MEASUREMENT:

- Pre-Scan has been conducted to determine the worst-case mode from all possible combinations between available modulations and antenna ports (if EUT with antenna diversity architecture).
- Following channel(s) was (were) selected for the final test as listed below.

AVAILABLE CHANNEL	TESTED CHANNEL	MODULATION TECHNOLOGY
128 to 251	128, 190, 251	GPRS

RADIATED EMISSION MEASUREMENT (BELOW 1 GHz):

- Pre-Scan has been conducted to determine the worst-case mode from all possible combinations between available modulations, data rates, XYZ axis and antenna ports (if EUT with antenna diversity architecture).
- Following channel(s) was (were) selected for the final test as listed below.

AVAILABLE CHANNEL	TESTED CHANNEL	MODULATION TECHNOLOGY	AXIS
128 to 251	251	GPRS	Y

RADIATED EMISSION MEASUREMENT (ABOVE 1 GHz):

- Pre-Scan has been conducted to determine the worst-case mode from all possible combinations between available modulations, data rates, XYZ axis and antenna ports (if EUT with antenna diversity architecture).
- Following channel(s) was (were) selected for the final test as listed below.

AVAILABLE CHANNEL	TESTED CHANNEL	MODULATION TECHNOLOGY	AXIS
128 to 251	128, 190, 251	GPRS	Y

TEST CONDITION:

APPLICABLE TO	ENVIRONMENTAL CONDITIONS	INPUT POWER	TESTED BY
OP	23deg. C, 63%RH, 1008 hPa	120Vac, 60Hz	Mark Liao
FS	23deg. C, 63%RH, 1008 hPa	120Vac, 60Hz	Mark Liao
OB	23deg. C, 63%RH, 1008 hPa	120Vac, 60Hz	Mark Liao
EM	23deg. C, 63%RH, 1008 hPa	120Vac, 60Hz	Mark Liao
BE	23deg. C, 63%RH, 1008 hPa	120Vac, 60Hz	Mark Liao
CE	23deg. C, 63%RH, 1008 hPa	120Vac, 60Hz	Mark Liao
RE < 1G	23deg. C, 63%RH, 991 hPa	120Vac, 60Hz	Mark Liao
RE ≥ 1G	23deg. C, 63%RH, 991 hPa	120Vac, 60Hz	Mark Liao

FOR CDMA:

EUT CONFIGURE MODE	APPLICABLE TO							DESCRIPTION
	OP	FS	OB	BE	CE	RE<1G	RE≥1G	
-	√	√	√	√	√	√	√	-

Where **OP:** Output power **FS:** Frequency stability
OB: Occupied bandwidth **BE:** Band edge
CE: Conducted spurious emissions **RE<1G:** Radiated emission below 1GHz
RE≥1G: Radiated emission above 1GHz

OUTPUT POWER MEASUREMENT:

- Pre-Scan has been conducted to determine the worst-case mode from all possible combinations between available modulations and antenna ports (if EUT with antenna diversity architecture).
- Following channel(s) was (were) selected for the final test as listed below.

AVAILABLE CHANNEL	TESTED CHANNEL	MODULATION TECHNOLOGY
1013 to 777	1013, 384, 777	CDMA

FREQUENCY STABILITY MEASUREMENT:

- Pre-Scan has been conducted to determine the worst-case mode from all possible combinations between available modulations and antenna ports (if EUT with antenna diversity architecture).
- Following channel(s) was (were) selected for the final test as listed below.

AVAILABLE CHANNEL	TESTED CHANNEL	MODULATION TECHNOLOGY
1013 to 777	384	CDMA

OCCUPIED BANDWIDTH MEASUREMENT:

- This item includes all test value of each mode, but only includes spectrum plot of worst value of each mode.
- Pre-Scan has been conducted to determine the worst-case mode from all possible combinations between available modulations and antenna ports (if EUT with antenna diversity architecture).
- Following channel(s) was (were) selected for the final test as listed below.

AVAILABLE CHANNEL	TESTED CHANNEL	MODULATION TECHNOLOGY
1013 to 777	1013, 384, 777	CDMA

BAND EDGE MEASUREMENT:

- Pre-Scan has been conducted to determine the worst-case mode from all possible combinations between available modulations and antenna ports (if EUT with antenna diversity architecture).
- Following channel(s) was (were) selected for the final test as listed below.

AVAILABLE CHANNEL	TESTED CHANNEL	MODULATION TECHNOLOGY
1013 to 777	1013, 777	CDMA



CONDUCTED SPURIOUS EMISSIONS MEASUREMENT:

- Pre-Scan has been conducted to determine the worst-case mode from all possible combinations between available modulations and antenna ports (if EUT with antenna diversity architecture).
- Following channel(s) was (were) selected for the final test as listed below.

AVAILABLE CHANNEL	TESTED CHANNEL	MODULATION TECHNOLOGY
1013 to 777	1013, 384, 777	CDMA

RADIATED EMISSION MEASUREMENT (BELOW 1 GHz):

- Pre-Scan has been conducted to determine the worst-case mode from all possible combinations between available modulations, data rates, XYZ axis and antenna ports (if EUT with antenna diversity architecture).
- Following channel(s) was (were) selected for the final test as listed below.

AVAILABLE CHANNEL	TESTED CHANNEL	MODULATION TECHNOLOGY	AXIS
1013 to 777	777	CDMA	Y

RADIATED EMISSION MEASUREMENT (ABOVE 1 GHz):

- Pre-Scan has been conducted to determine the worst-case mode from all possible combinations between available modulations, data rates, XYZ axis and antenna ports (if EUT with antenna diversity architecture).
- Following channel(s) was (were) selected for the final test as listed below.

AVAILABLE CHANNEL	TESTED CHANNEL	MODULATION TECHNOLOGY	AXIS
1013 to 777	1013, 384, 777	CDMA	Y

TEST CONDITION:

APPLICABLE TO	ENVIRONMENTAL CONDITIONS	INPUT POWER (SYSTEM)	TESTED BY
OP	23deg. C, 63%RH, 1008 hPa	120Vac, 60Hz	Mark Liao
FS	23deg. C, 63%RH, 1008 hPa	120Vac, 60Hz	Mark Liao
OB	23deg. C, 63%RH, 1008 hPa	120Vac, 60Hz	Mark Liao
EM	23deg. C, 63%RH, 1008 hPa	120Vac, 60Hz	Mark Liao
BE	23deg. C, 63%RH, 1008 hPa	120Vac, 60Hz	Mark Liao
CE	23deg. C, 63%RH, 1008 hPa	120Vac, 60Hz	Mark Liao
RE < 1G	23deg. C, 63%RH, 991 hPa	120Vac, 60Hz	Mark Liao
RE ≥ 1G	23deg. C, 63%RH, 991 hPa	120Vac, 60Hz	Mark Liao

FOR WCDMA:

EUT CONFIGURE MODE	APPLICABLE TO							DESCRIPTION
	OP	FS	OB	BE	CE	RE<1G	RE≥1G	
-	√	√	√	√	√	√	√	-

Where **OP**: Output power **FS**: Frequency stability
OB: Occupied bandwidth **BE**: Band edge
CE: Conducted spurious emissions **RE<1G**: Radiated emission below 1GHz
RE≥1G: Radiated emission above 1GHz

OUTPUT POWER MEASUREMENT:

- Pre-Scan has been conducted to determine the worst-case mode from all possible combinations between available modulations and antenna ports (if EUT with antenna diversity architecture).
- Following channel(s) was (were) selected for the final test as listed below.

AVAILABLE CHANNEL	TESTED CHANNEL	MODULATION TECHNOLOGY
4132 to 4233	4132, 4182, 4233	WCDMA

FREQUENCY STABILITY MEASUREMENT:

- Pre-Scan has been conducted to determine the worst-case mode from all possible combinations between available modulations and antenna ports (if EUT with antenna diversity architecture).
- Following channel(s) was (were) selected for the final test as listed below.

AVAILABLE CHANNEL	TESTED CHANNEL	MODULATION TECHNOLOGY
4132 to 4233	4182	WCDMA

OCCUPIED BANDWIDTH MEASUREMENT:

- This item includes all test value of each mode, but only includes spectrum plot of worst value of each mode.
- Pre-Scan has been conducted to determine the worst-case mode from all possible combinations between available modulations and antenna ports (if EUT with antenna diversity architecture).
- Following channel(s) was (were) selected for the final test as listed below.

AVAILABLE CHANNEL	TESTED CHANNEL	MODULATION TECHNOLOGY
4132 to 4233	4132, 4182, 4233	WCDMA

BAND EDGE MEASUREMENT:

- Pre-Scan has been conducted to determine the worst-case mode from all possible combinations between available modulations and antenna ports (if EUT with antenna diversity architecture).
- Following channel(s) was (were) selected for the final test as listed below.

AVAILABLE CHANNEL	TESTED CHANNEL	MODULATION TECHNOLOGY
4132 to 4233	4132, 4233	WCDMA



CONDUCTED SPURIOUS EMISSIONS MEASUREMENT:

- Pre-Scan has been conducted to determine the worst-case mode from all possible combinations between available modulations and antenna ports (if EUT with antenna diversity architecture).
- Following channel(s) was (were) selected for the final test as listed below.

AVAILABLE CHANNEL	TESTED CHANNEL	MODULATION TECHNOLOGY
4132 to 4233	4132, 4182, 4233	WCDMA

RADIATED EMISSION MEASUREMENT (BELOW 1 GHz):

- Pre-Scan has been conducted to determine the worst-case mode from all possible combinations between available modulations, data rates, XYZ axis and antenna ports (if EUT with antenna diversity architecture).
- Following channel(s) was (were) selected for the final test as listed below.

AVAILABLE CHANNEL	TESTED CHANNEL	MODULATION TECHNOLOGY	AXIS
4132 to 4233	4233	WCDMA	Y

RADIATED EMISSION MEASUREMENT (ABOVE 1 GHz):

- Pre-Scan has been conducted to determine the worst-case mode from all possible combinations between available modulations, data rates, XYZ axis and antenna ports (if EUT with antenna diversity architecture).
- Following channel(s) was (were) selected for the final test as listed below.

AVAILABLE CHANNEL	TESTED CHANNEL	MODULATION TECHNOLOGY	AXIS
4132 to 4233	4132, 4182, 4233	WCDMA	Y

TEST CONDITION:

APPLICABLE TO	ENVIRONMENTAL CONDITIONS	INPUT POWER (SYSTEM)	TESTED BY
OP	23deg. C, 63%RH, 1008 hPa	120Vac, 60Hz	Mark Liao
FS	23deg. C, 63%RH, 1008 hPa	120Vac, 60Hz	Mark Liao
OB	23deg. C, 63%RH, 1008 hPa	120Vac, 60Hz	Mark Liao
EM	23deg. C, 63%RH, 1008 hPa	120Vac, 60Hz	Mark Liao
BE	23deg. C, 63%RH, 1008 hPa	120Vac, 60Hz	Mark Liao
CE	23deg. C, 63%RH, 1008 hPa	120Vac, 60Hz	Mark Liao
RE < 1G	23deg. C, 74%RH, 1008 hPa	120Vac, 60Hz	Mark Liao
RE ≥ 1G	23deg. C, 63%RH, 1008 hPa	120Vac, 60Hz	Mark Liao



3.3 GENERAL DESCRIPTION OF APPLIED STANDARDS

The EUT is a RF product. According to the specifications of the manufacturer, it must comply with the requirements of the following standards:

FCC 47 CFR Part 2

FCC 47 CFR Part 22

ANSI C63.4-2003

ANSI/TIA/EIA-603-C 2004

NOTE: All test items have been performed and recorded as per the above standards.

3.4 DESCRIPTION OF SUPPORT UNITS

The EUT has been tested as an independent unit together with other necessary accessories or support units. The following support units or accessories were used to form a representative test configuration during the tests.

NO.	PRODUCT	BRAND	MODEL NO.	SERIAL NO.	FCC ID
1	MOUSE	DELL	MO56U0	513001542	FCC DoC Approved
2	USB KEYBOARD	DELL	SK-8115	MY-0DJ325-716 19-857-0405	NA
3	MODEM	ACEEX	1414V/3	0401008270	IFAXDM1414
4	EARPHONE	PHILIPS	HL145	N/A	NA
5	MICROPHONE	Labtec	LVA7313	N/A	NA
6	UNIVERSAL RADIO COMMUNICATION TESTER	R&S	CMU200	104484	NA
7	NJZ-2000 (GPRS+WCDMA SIMULATOR)	JRC	NJZ-2000	ET00054	NA

NO.	SIGNAL CABLE DESCRIPTION OF THE ABOVE SUPPORT UNITS
1	1.8m foil shielded wire, USB Connector, w/o core.
2	1.8m foil shielded wire, USB Connector, w/o core.
3	1.2m braid shielded wire, DB25 & DB9 connector, w/o core.
4	1.2m shielded cable
5	1m wrapped shielded wire, terminated via drain wire, with 3.5 mm phone plug, w/o core.
6	NA
7	NA

NOTE 1: All power cords of the above support units are non shielded (1.8m).

NOTE 2: Item 6-7 acted as a communication partners to transfer data.



4 TEST TYPES AND RESULTS

4.1 OUTPUT POWER MEASUREMENT

4.1.1 LIMITS OF OUTPUT POWER MEASUREMENT

The radiated output power shall be according to the specific rule Part 22.913 (a) that “Mobile / Portable station are limited to 7 watts e.r.p”.



4.1.2 TEST INSTRUMENTS

DESCRIPTION & MANUFACTURER	MODEL NO.	SERIAL NO.	DATE OF CALIBRATION	DUE DATE OF CALIBRATION
Test Receiver ROHDE & SCHWARZ	ESIB7	100188	Dec. 21, 2009	Dec. 20, 2010
Spectrum Analyzer ROHDE & SCHWARZ	FSP40	100269	Dec. 31, 2009	Dec. 30, 2010
BILOG Antenna SCHWARZBECK	VULB9168	9168-160	Apr. 27, 2010	Apr. 26, 2011
HORN Antenna SCHWARZBECK	9120D	9120D-405	Feb. 03, 2010	Feb. 02, 2011
HORN Antenna SCHWARZBECK	BBHA 9170	BBHA9170243	Dec. 25, 2009	Dec. 24, 2010
Preamplifier Agilent	8447D	2944A10638	Dec. 21, 2009	Dec. 20, 2010
Preamplifier Agilent	8449B	3008A01964	Nov. 09, 2009	Nov. 08, 2010
RF signal cable HUBER+SUHNNER	SUCOFLEX 104	238141/4	May 14, 2010	May 13, 2011
RF signal cable HUBER+SUHNNER	SUCOFLEX 104	12738/6	May 14, 2010	May 13, 2011
Software ADT.	ADT_Radiated_ V7.6.15.9.2	NA	NA	NA
Antenna Tower inn-co GmbH	MA 4000	013303	NA	NA
Antenna Tower Controller inn-co GmbH	CO2000	017303	NA	NA
Turn Table ADT.	TT100.	TT93021703	NA	NA
Turn Table Controller ADT.	SC100.	SC93021703	NA	NA

- NOTE:**
1. The calibration interval of the above test instruments is 12 months and the calibrations are traceable to NML/ROC and NIST/USA.
 2. The test was performed in HwaYa Chamber 3.
 3. The horn antenna and HP preamplifier (model: 8449B) are used only for the measurement of emission frequency above 1GHz if tested.
 4. The FCC Site Registration No. is 988962.
 5. The IC Site Registration No. is IC 7450F-3.

4.1.3 TEST PROCEDURES

- a. The power was measured with R&S Spectrum Analyzer. All measurements were done at 3 channels, 128, 190 and 251 (GPRS & E-GPRS) / 1013, 384 and 777 (CDMA) / 4132, 4182 and 4233 (WCDMA) (low, middle and high operational frequency range.)
- b. The conducted output power used the power splitter via EUT RF power connector between simulation base station and spectrum analyzer. The path loss included the splitter loss, cable loss and 20dB pad loss. The spectrum set RB/VB 1MHz (GPRS & E-GPRS), 3MHz (CDMA) and 5MHz (WCDMA), then read peak power value and record to the test. (All transmitted path loss shall be considered in the test report data.)
- c. Substitution method is used for E.I.R.P measurement. In the semi-anechoic chamber, EUT placed on the 0.8m height of Turn Table, rotated the table around 360 degrees to search the maximum radiation power and receiver antenna shall be rotated vertical and horizontal polarization and moved height from 1m to 4m to find the maximum polar radiated power. The " Read Value " is the spectrum reading the maximum power value.
- d. The substitution horn antenna is substituted for EUT at the same position and signals generator export the CW signal to the substitution antenna via a tx cable . Rotated the Turn Table and moved receiving antenna to find the maximum radiation power. Adjust output power level of S.G to get a Value of spectrum reading equal to " Read Value " of step c. Record the power level of S.G
- e. $EIRP = \text{Output power level of S.G} - \text{TX cable loss} + \text{Antenna gain of substitution horn.}$
- f. E.R.P power can be calculated form E.I.R.P power by subtracting the gain of dipole,
 $E.R.P \text{ power} = E.I.P.R \text{ power} - 2.15\text{dBi.}$

4.1.4 TEST SETUP

EIRP POWER MEASUREMENT:

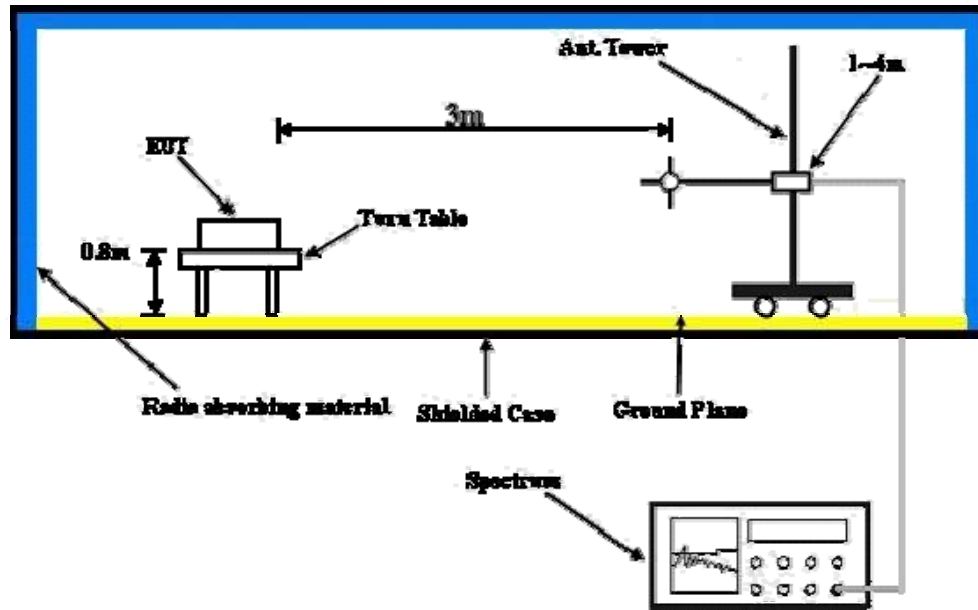

For the actual test configuration, please refer to the attached file (Test Setup Photo).

CONDUCTED POWER MEASUREMENT:

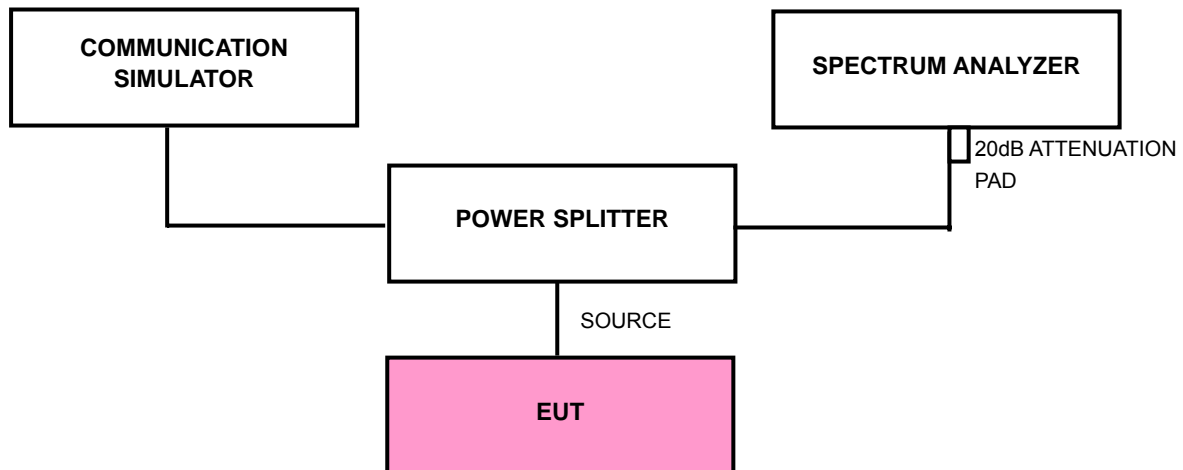

For the actual test configuration, please refer to the related item – Photographs of the Test Configuration.

4.1.5 EUT OPERATING CONDITIONS

- The EUT makes a call to the communication simulator.
- The communication simulator station system controlled an EUT to export maximum output power under transmission mode and specific channel frequency.

4.1.6 TEST RESULTS

FOR GPRS & E-GPRS:

FOR GPRS MODE (UP-LINK WITH 1 TIME SLOT)

CONDUCTED OUTPUT POWER					
CHANNEL NO.	FREQUENCY (MHz)	RAW VALUE (dBm)	CORRECTION FACTOR (dB)	OUTPUT POWER	
				dBm	Watt
128	824.2	8.20	23.90	32.10	1.6218
190	836.6	8.20	23.90	32.10	1.6218
251	848.8	8.20	23.90	32.10	1.6218

FOR E-GPRS MODE (UP-LINK WITH 1 TIME SLOT)

CONDUCTED OUTPUT POWER					
CHANNEL NO.	FREQUENCY (MHz)	RAW VALUE (dBm)	CORRECTION FACTOR (dB)	OUTPUT POWER	
				dBm	Watt
128	824.2	3.70	23.90	27.60	0.5754
190	836.6	3.80	23.90	27.70	0.5888
251	848.8	3.70	23.90	27.60	0.5754

- REMARKS:** 1. Output Power (dBm) = Raw Value (dBm) + Correction Factor (dB).
 2. Correction Factor (dB) = Power Splitter Loss (dB) + Cable Loss (dB) + 20dB Pad.

FOR GPRS MODE (UP-LINK WITH 1 TIME SLOT)

ERP POWER					
CHANNEL NO.	FREQUENCY (MHz)	S.G VALUE (dBm)	CORRECTION FACTOR (dB)	OUTPUT POWER	
				dBm	Watt
128	824.2	32.1	-8.6	23.5	0.2213
190	836.6	32.1	-8.6	23.5	0.2213
251	848.8	32.1	-8.7	23.4	0.2163

FOR E-GPRS MODE (UP-LINK WITH 1 TIME SLOT)

ERP POWER					
CHANNEL NO.	FREQUENCY (MHz)	S.G VALUE (dBm)	CORRECTION FACTOR (dB)	OUTPUT POWER	
				dBm	Watt
128	824.2	27.1	-8.6	18.5	0.0700
190	836.6	27.5	-8.6	18.9	0.0767
251	848.8	27.3	-8.7	18.6	0.0716

- REMARKS:** 1. Output Power (dBm) = S.G Value (dBm) + Correction Factor (dB).
 2. Correction Factor (dB) = Substitution Antenna Gain (dB) + Cable Loss (dB).

FOR CDMA:

WORST CASE CONDUCTED POWER OF 1x EV-DO								
CHANNEL	FREQ. (MHz)	Rev. A	Rev. 0	CORR. FACTOR (dB)	Rev. A		Rev. 0	
					OUTPUT POWER			
		RAW VALUE (dBm)			dBm	Watt	dBm	Watt
1013	824.70	-0.9	-0.7	23.90	23.02	0.2004	23.21	0.2094
384	836.52	-0.5	-0.5	23.90	23.38	0.2178	23.44	0.2208
777	848.31	-0.7	-0.6	23.90	23.24	0.2109	23.32	0.2148

CDMA 2000 CONDUCTED POWER											
CHAN.	FREQ. (MHz)	CDMA 2000	RAW VALUE (dBm)				CORR. FACTOR (dB)	OUTPUT POWER (dBm)			
			RC	SO2	SO55	TDSO SO32 (FCH)		TDSO SO32 (FCH+S CH)	SO2	SO55	TDSO SO32 (FCH)
		1013	824.70	RC1	-0.91	-0.82		-	-	23.90	22.99
RC3	-0.75			-0.65	-0.67	-0.69	23.90	23.15	23.25	23.23	23.21
384	836.52	RC1	-0.46	-0.35	-	-	23.90	23.44	23.55	-	-
		RC3	-0.40	-0.32	-0.39	-0.41	23.90	23.50	23.58	23.51	23.49
777	848.31	RC1	-0.80	-0.76	-	-	23.90	23.10	23.14	-	-
		RC3	-0.78	-0.62	-0.68	-0.64	23.90	23.12	23.28	23.22	23.26

REMARKS: 1. Output Power (dBm) = Raw Value (dBm) + Correction Factor (dB).
 2. Correction Factor (dB) = Power Splitter Loss (dB) + Cable Loss (dB)+ 20dB Pad.

1xEV-DO MODE

ERP POWER (1x EV-DO)								
CHANNEL	FREQ. (MHz)	S.G. VALUE (dBm)		CORR. FACTOR (dB)	OUTPUT POWER			
					Rev. A		Rev. 0	
		Rev. A	Rev. 0		dBm	Watt	dBm	Watt
1013	824.70	24.0	24.5	-8.6	15.4	0.0343	15.9	0.0385
384	836.52	24.2	24.9	-8.6	15.6	0.0359	16.3	0.0422
777	848.31	23.1	23.9	-8.7	14.4	0.0272	15.2	0.0327

CDMA MODE

ERP POWER (SO55)					
CHANNEL NO.	FREQUENCY (MHz)	S.G. VALUE (dBm)	CORRECTION FACTOR (dB)	OUTPUT POWER	
				dBm	Watt
1013	824.70	25.1	-8.6	16.5	0.0442
384	836.52	25.3	-8.6	16.7	0.0462
777	848.31	24.4	-8.7	15.7	0.0367

REMARKS: 1. Output Power (dBm) = S.G Value (dBm) + Correction Factor (dB).
 2. Correction Factor (dB) = Substitution Antenna Gain (dB) + Cable Loss (dB).

**FOR WCDMA:
WCDMA-RMC MODE**

CONDUCTED OUTPUT POWER					
CHANNEL NO.	FREQUENCY (MHz)	RAW VALUE (dBm)	CORRECTION FACTOR (dB)	OUTPUT POWER	
				dBm	Watt
4132	826.4	0.44	23.90	24.34	0.2716
4182	836.4	0.49	23.90	24.39	0.2748
4233	846.6	0.26	23.90	24.16	0.2606

HSDPA MODE-R5 Subtest 1

CONDUCTED OUTPUT POWER					
CHANNEL NO.	FREQUENCY (MHz)	RAW VALUE (dBm)	CORRECTION FACTOR (dB)	OUTPUT POWER	
				dBm	Watt
4132	826.4	0.07	23.90	23.97	0.2495
4182	836.4	0.14	23.90	24.04	0.2535
4233	846.6	-0.03	23.90	23.87	0.2438

HSDPA MODE-R5 Subtest 2

CONDUCTED OUTPUT POWER					
CHANNEL NO.	FREQUENCY (MHz)	RAW VALUE (dBm)	CORRECTION FACTOR (dB)	OUTPUT POWER	
				dBm	Watt
4132	826.4	-0.64	23.90	23.26	0.2118
4182	836.4	-0.15	23.90	23.75	0.2371
4233	846.6	-0.85	23.90	23.05	0.2018

HSDPA MODE-R5 Subtest 3

CONDUCTED OUTPUT POWER					
CHANNEL NO.	FREQUENCY (MHz)	RAW VALUE (dBm)	CORRECTION FACTOR (dB)	OUTPUT POWER	
				dBm	Watt
4132	826.4	-0.14	23.90	23.76	0.2377
4182	836.4	-0.56	23.90	23.34	0.2158
4233	846.6	-0.10	23.90	23.80	0.2399

- REMARKS:** 1. Output Power (dBm) = Raw Value (dBm) + Correction Factor (dB).
2. Correction Factor (dB) = Power Splitter Loss (dB) + Cable Loss (dB)+ 20dB Pad.

HSDPA MODE-R5 Subtest 4

CONDUCTED OUTPUT POWER					
CHANNEL NO.	FREQUENCY (MHz)	RAW VALUE (dBm)	CORRECTION FACTOR (dB)	OUTPUT POWER	
				dBm	Watt
4132	826.4	-0.19	23.90	23.71	0.2350
4182	836.4	-0.35	23.90	23.55	0.2265
4233	846.6	-0.39	23.90	23.51	0.2244

HSUPA MODE-R6 Subtest 1

CONDUCTED OUTPUT POWER					
CHANNEL NO.	FREQUENCY (MHz)	RAW VALUE (dBm)	CORRECTION FACTOR (dB)	OUTPUT POWER	
				dBm	Watt
4132	826.4	-0.88	23.90	23.02	0.2004
4182	836.4	-0.42	23.90	23.48	0.2228
4233	846.6	0.25	23.90	24.15	0.2600

HSUPA MODE-R6 Subtest 2

CONDUCTED OUTPUT POWER					
CHANNEL NO.	FREQUENCY (MHz)	RAW VALUE (dBm)	CORRECTION FACTOR (dB)	OUTPUT POWER	
				dBm	Watt
4132	826.4	-1.30	23.90	22.60	0.1820
4182	836.4	-1.00	23.90	22.90	0.1950
4233	846.6	-1.15	23.90	22.75	0.1884

HSUPA MODE-R6 Subtest 3

CONDUCTED OUTPUT POWER					
CHANNEL NO.	FREQUENCY (MHz)	RAW VALUE (dBm)	CORRECTION FACTOR (dB)	OUTPUT POWER	
				dBm	Watt
4132	826.4	-1.58	23.90	22.32	0.1706
4182	836.4	-1.05	23.90	22.85	0.1928
4233	846.6	-0.58	23.90	23.32	0.2148

REMARKS: 1. Output Power (dBm) = Raw Value (dBm) + Correction Factor (dB).

2. Correction Factor (dB) = Power Splitter Loss (dB) + Cable Loss (dB)+ 20dB Pad.

HSUPA MODE-R6 Subtest 4

CONDUCTED OUTPUT POWER					
CHANNEL NO.	FREQUENCY (MHz)	RAW VALUE (dBm)	CORRECTION FACTOR (dB)	OUTPUT POWER	
				dBm	Watt
4132	826.4	0.08	23.90	23.98	0.2500
4182	836.4	-0.10	23.90	23.80	0.2399
4233	846.6	-0.79	23.90	23.11	0.2046

HSUPA MODE-R6 Subtest 5

CONDUCTED OUTPUT POWER					
CHANNEL NO.	FREQUENCY (MHz)	RAW VALUE (dBm)	CORRECTION FACTOR (dB)	OUTPUT POWER	
				dBm	Watt
4132	826.4	-0.52	23.90	23.38	0.2178
4182	836.4	-0.58	23.90	23.32	0.2148
4233	846.6	-0.66	23.90	23.24	0.2109

- REMARKS:** 1. Output Power (dBm) = Raw Value (dBm) + Correction Factor (dB).
 2. Correction Factor (dB) = Power Splitter Loss (dB) + Cable Loss (dB) + 20dB Pad.

WCDMA-RMC MODE

ERP POWER					
CHANNEL NO.	FREQUENCY (MHz)	S.G VALUE (dBm)	CORRECTION FACTOR (dB)	OUTPUT POWER	
				dBm	Watt
4132	826.4	23.9	-8.6	15.3	0.0335
4182	836.4	23.7	-8.6	15.1	0.0320
4233	846.6	23.3	-8.7	14.7	0.0292

REMARKS: 1. Output Power (dBm) = S.G Value (dBm) + Correction Factor (dB).
 2. Correction Factor (dB) = Substitution Antenna Gain (dB) + Cable Loss (dB).



4.2 FREQUENCY STABILITY MEASUREMENT

4.2.1 LIMITS OF FREQUENCY STABILITY MEASUREMENT

According to the FCC part 22.863 shall be tested the frequency stability. The rule is defined that "The frequency stability shall be sufficient to ensure that the fundamental emission stays within the authorized frequency block." The frequency error rate is according to the JTC standard that the frequency error rate shall be accurate to within 2.5ppm of the received frequency from the base station. The test extreme voltage is according to the 2.1055(d)(1) Vary primary supply voltage from 85 to 115 percent of the nominal value for other than hand carried battery equipment and the extreme temperature rule is comply with the 2.1055(a)(1) $-30 \sim 50$.

4.2.2 TEST INSTRUMENTS

DESCRIPTION & MANUFACTURER	MODEL NO.	SERIAL NO.	CALIBRATED UNTIL	CALIBRATED UNTIL
Spectrum Analyzer Agilent	E4446A	MY44360124	Feb. 05, 2010	Feb. 04, 2011
Hewlett Packard RF cable	8120-6192	01428251	NA	NA
RF cable	SUCOFLEX 104	257029	Sep. 11, 2010	Sep. 10, 2011
WIT Standard Temperature & Humidity Chamber	MHU-225AU	920409	May 06, 2010	May 05, 2011

NOTE: The calibration interval of the above test instruments is 12 months. And the calibrations are traceable to NML/ROC and NIST/USA.

4.2.3 TEST PROCEDURE

- a. Because of the measure the carrier frequency under the condition of the AFC lock, it shall be used the mobile station in the GPRS / CDMA / WCDMA link mode. This is accomplished with the use of the R&S CMU200 / JRC NJZ-2000 simulator station. The oven room could control the temperatures and humidity. The GPRS link channel is the 190, the CDMA link channel is the 384 and the WCDMA link channel is the 4182.
- b. Power must be removed when changing from one temperature to another or one voltage to another voltage. Power warm up is at least 15 min and power applied should perform before recording frequency error.
- c. EUT is connected the external power supply to control the AC input power. The various Volts from the minimum 93.5 Volts to 126.5 Volts. Each step shall be record the frequency error rate.
- d. The temperature range step is 10 degrees in this test items. All temperature levels shall be hold the ± 0.5 during the measurement testing.
- e. The each temperature step shall be at least 0.5 hours, consider the EUT could be test under the stability condition.

NOTE: The frequency error was recorded frequency error from the communication simulator.

4.2.4 TEST SETUP

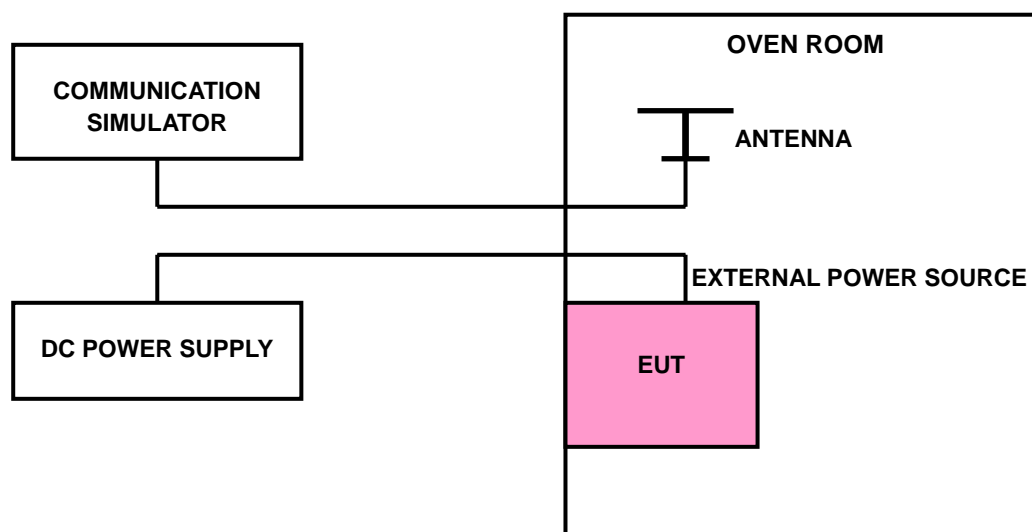

4.2.5 TEST RESULTS

FOR GPRS:

AFC FREQUENCY ERROR vs. VOLTAGE			
VOLTAGE (Volts)	FREQUENCY ERROR (Hz)	FREQUENCY ERROR (ppm)	LIMIT (ppm)
126.5	-37	-0.044	2.5
93.5	-31	-0.037	2.5

NOTE: The applicant defined the normal working voltage of the AC adapter is from 93.5Vac to 126.5Vac.

AFC FREQUENCY ERROR vs. TEMP.			
TEMP. ()	FREQUENCY ERROR (Hz)	FREQUENCY ERROR (ppm)	LIMIT (ppm)
50	-46	-0.055	2.5
40	-40	-0.048	2.5
30	-24	-0.029	2.5
20	-42	-0.050	2.5
10	-23	-0.027	2.5
0	-22	-0.026	2.5
-10	-11	-0.013	2.5
-20	-3	-0.004	2.5
-30	-8	-0.010	2.5

FOR CDMA:

AFC FREQUENCY ERROR vs. VOLTAGE			
VOLTAGE (Volts)	FREQUENCY ERROR (Hz)	FREQUENCY ERROR (ppm)	LIMIT (ppm)
126.5	-35	-0.042	2.5
93.5	-33	-0.039	2.5

NOTE: The applicant defined the normal working voltage of the AC adapter is from 93.5Vac to 126.5Vac.

AFC FREQUENCY ERROR vs. TEMP.			
TEMP. ()	FREQUENCY ERROR (Hz)	FREQUENCY ERROR (ppm)	LIMIT (ppm)
50	-41	-0.049	2.5
40	-38	-0.045	2.5
30	-20	-0.024	2.5
20	-37	-0.044	2.5
10	-18	-0.022	2.5
0	-20	-0.024	2.5
-10	-8	-0.010	2.5
-20	-5	-0.006	2.5
-30	-5	-0.006	2.5

FOR WCDMA:

AFC FREQUENCY ERROR vs. VOLTAGE			
VOLTAGE (Volts)	FREQUENCY ERROR (Hz)	FREQUENCY ERROR (ppm)	LIMIT (ppm)
126.5	-38	-0.045	2.5
93.5	-33	-0.039	2.5

NOTE: The applicant defined the normal working voltage of the AC adapter is from 93.5Vac to 126.5Vac.

AFC FREQUENCY ERROR vs. TEMP.			
TEMP. ()	FREQUENCY ERROR (Hz)	FREQUENCY ERROR (ppm)	LIMIT (ppm)
50	-43	-0.051	2.5
40	-41	-0.049	2.5
30	-23	-0.027	2.5
20	-43	-0.051	2.5
10	-47	-0.056	2.5
0	-25	-0.030	2.5
-10	-12	-0.014	2.5
-20	-8	-0.010	2.5
-30	-5	-0.006	2.5

4.3 OCCUPIED BANDWIDTH MEASUREMENT

4.3.1 LIMITS OF OCCUPIED BANDWIDTH MEASUREMENT

The width of a frequency band such that, below the lower and above the upper frequency limits, the mean powers emitted are each equal to a specified percentage 0.5 %of the totalmean power of a given emission.

4.3.2 TEST INSTRUMENTS

DESCRIPTION & MANUFACTURER	MODEL NO.	SERIAL NO.	DATE OF CALIBRATION	DUE DATE OF CALIBRATION
ROHDE & SCHWARZ Spectrum Analyzer	FSP40	100040	Jul. 09, 2010	Jul. 08, 2011
Mini-Circuits Power Splitter	ZN2PD-9G	NA	Jun. 25, 2010	Jun. 24, 2011
RF cable	SUCOFLEX 104	274403/4	Aug. 20, 2010	Aug. 19, 2011
RF cable	SUCOFLEX 104	250729/4	Aug. 19, 2010	Aug. 18, 2011
RF cable	SUCOFLEX 104	214377/4	Aug. 19, 2010	Aug. 18, 2011
JFW 20dB attenuation	50HF-020-SMA	NA	NA	NA

NOTE: The calibration interval of the above test instruments is 12 months. And the calibrations are traceable to NML/ROC and NIST/USA.

4.3.3 TEST SETUP

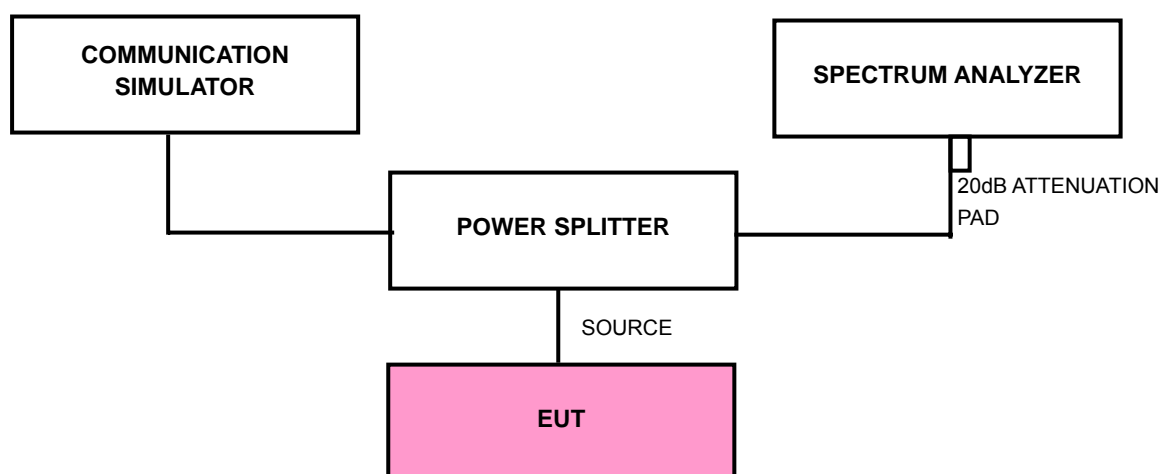

4.3.4 TEST PROCEDURES

- a. The EUT makes a call to the communication simulator. The power was measured with R&S Spectrum Analyzer. All measurements were done at 3 channels, 128, 190 and 251 (GPRS / E-GPRS) / 1013, 384 and 777 (CDMA) / 4132, 4182 and 4233 (WCDMA) (low, middle and high operational frequency range.)
- b. The conducted occupied bandwidth used the power splitter via EUT RF power connector between simulation base station and spectrum analyzer. This splitter loss and cable loss is the worst loss 23.9dB in the transmitted path track.
- c. The communication simulator station system controlled a EUT to export maximum output power under transmission mode and specific channel frequency. Use OBW measurement function of Spectrum analyzer to measure 99 % occupied bandwidth.

4.3.5 EUT OPERATING CONDITION

- a. The EUT makes a call to the communication simulator.
- b. The communication simulator station system controlled a EUT to export maximum and minimum output power under transmission mode and specific channel frequency.

4.3.6 TEST RESULTS

FOR GPRS & E-GPRS:

FOR GPRS MODE (UP-LINK WITH 1 TIME SLOT)

CHANNEL	FREQUENCY (MHz)	99% OCCUPIED BANDWIDTH (kHz)
128	824.2	244
190	836.6	244
251	848.8	248

CH 251

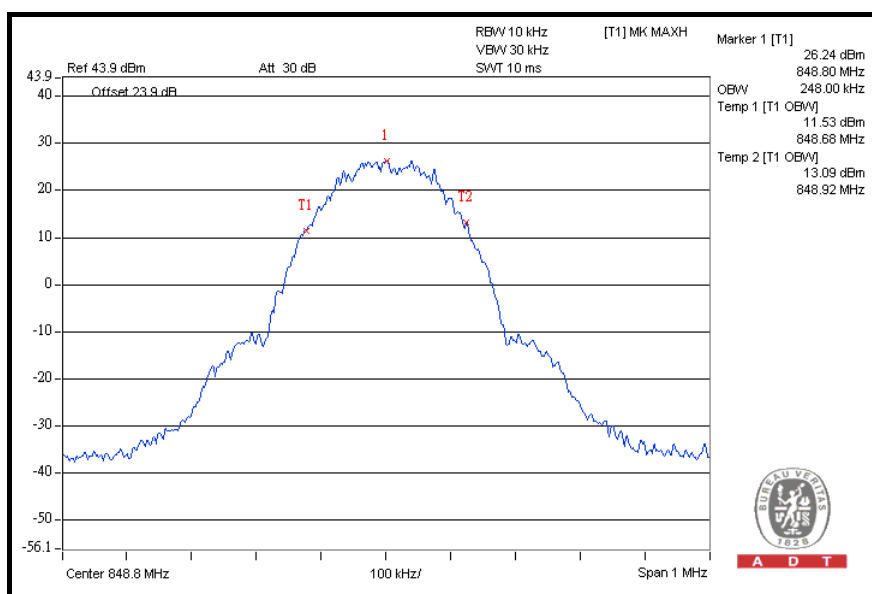

FOR E-GPRS MODE (UP-LINK WITH 1 TIME SLOT)

CHANNEL	FREQUENCY (MHz)	99% OCCUPIED BANDWIDTH (kHz)
128	824.2	246
190	836.6	242
251	848.8	252

CH 251

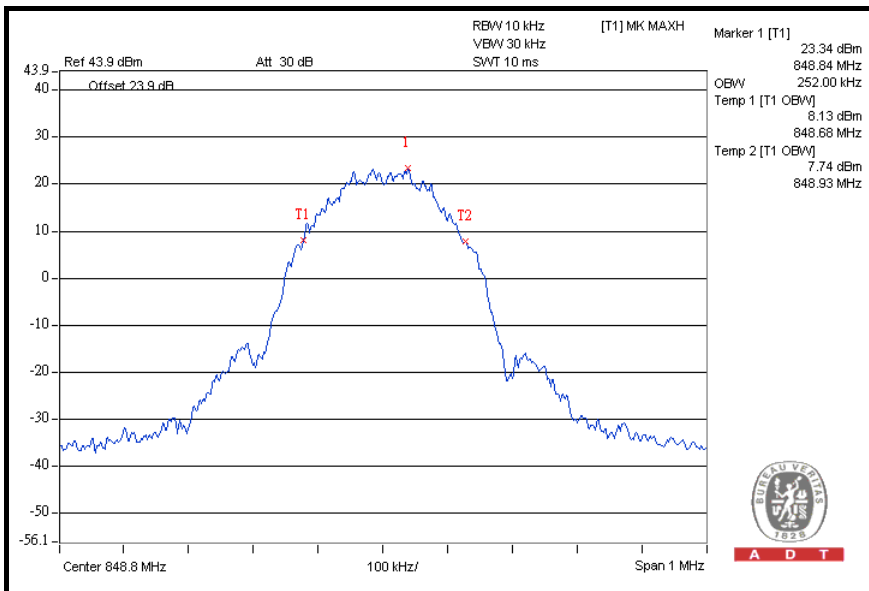

FOR CDMA

FOR SO55:

CHANNEL	FREQUENCY (MHz)	99% OCCUPIED BANDWIDTH (MHz)
1013	824.70	1.28
384	836.52	1.27
777	848.31	1.28

CH 777

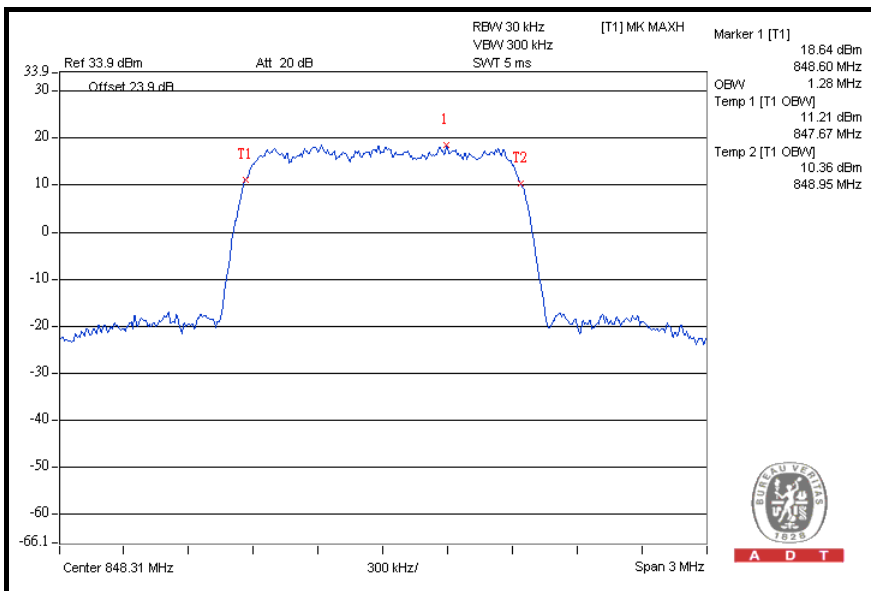

FOR EV-DO Rev. A:

CHANNEL	FREQUENCY (MHz)	99% OCCUPIED BANDWIDTH (MHz)
1013	824.70	1.28
384	836.52	1.27
777	848.31	1.28

CH 1013

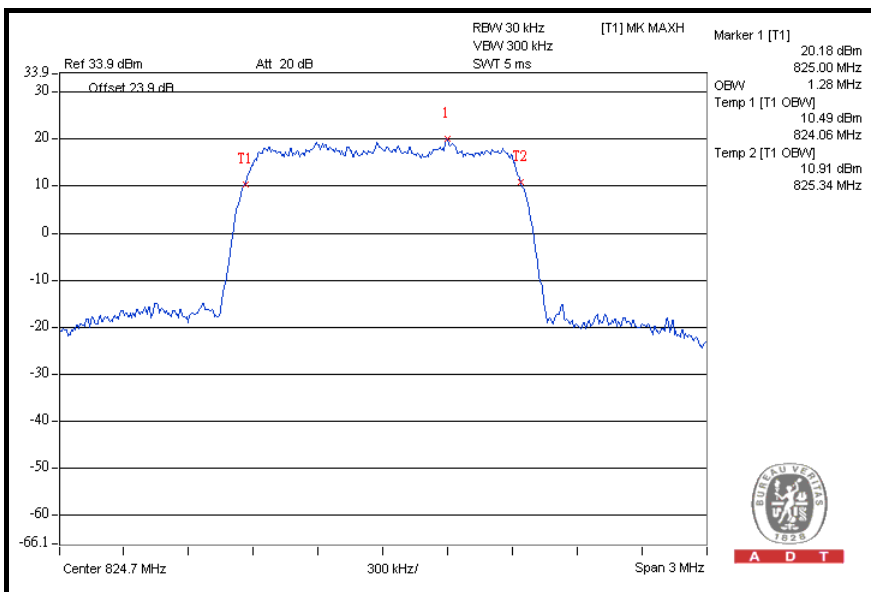

FOR EV-DO Rev. 0

CHANNEL	FREQUENCY (MHz)	99% OCCUPIED BANDWIDTH (MHz)
1013	824.70	1.28
384	836.52	1.27
777	848.31	1.28

CH 1013

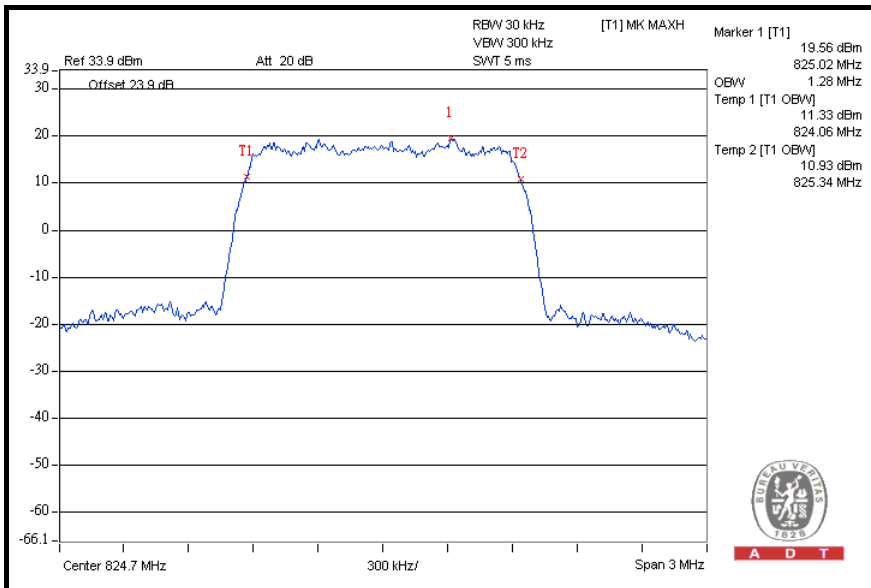

FOR WCDMA:

FOR WCDMA:

CHANNEL	FREQUENCY (MHz)	99% OCCUPIED BANDWIDTH (MHz)
4132	826.4	4.20
4182	836.4	4.18
4233	846.6	4.20

CH 4233

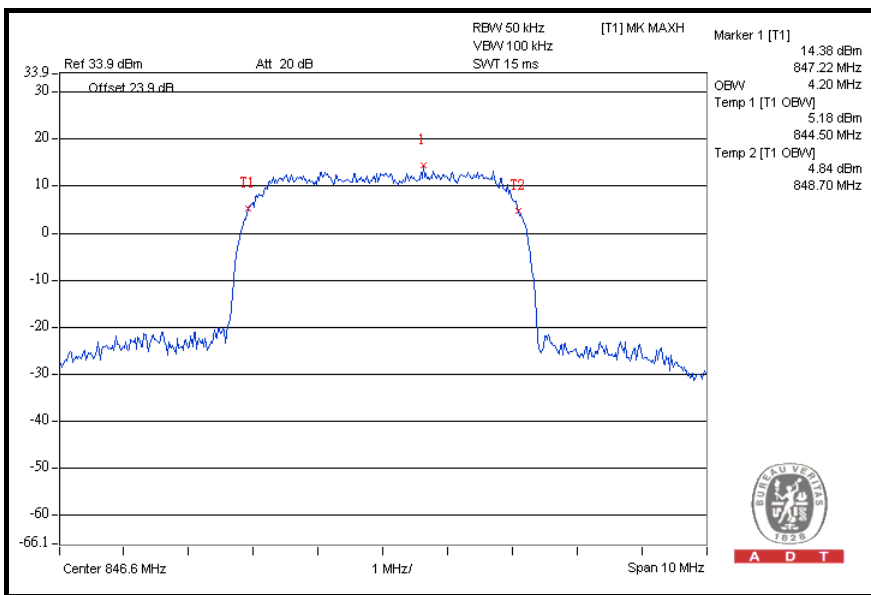

FOR HSDPA:

CHANNEL	FREQUENCY (MHz)	99% OCCUPIED BANDWIDTH (MHz)
4132	826.4	4.20
4182	836.4	4.18
4233	846.6	4.18

CH 4132

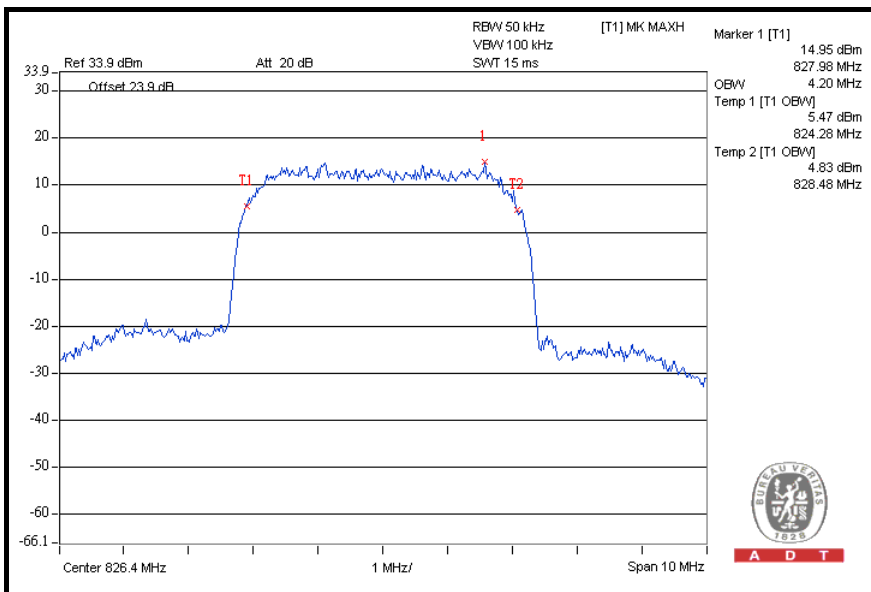

FOR HSUPA:

CHANNEL	FREQUENCY (MHz)	99% OCCUPIED BANDWIDTH (MHz)
4132	826.4	4.20
4182	836.4	4.20
4233	846.6	4.20

CH 4233

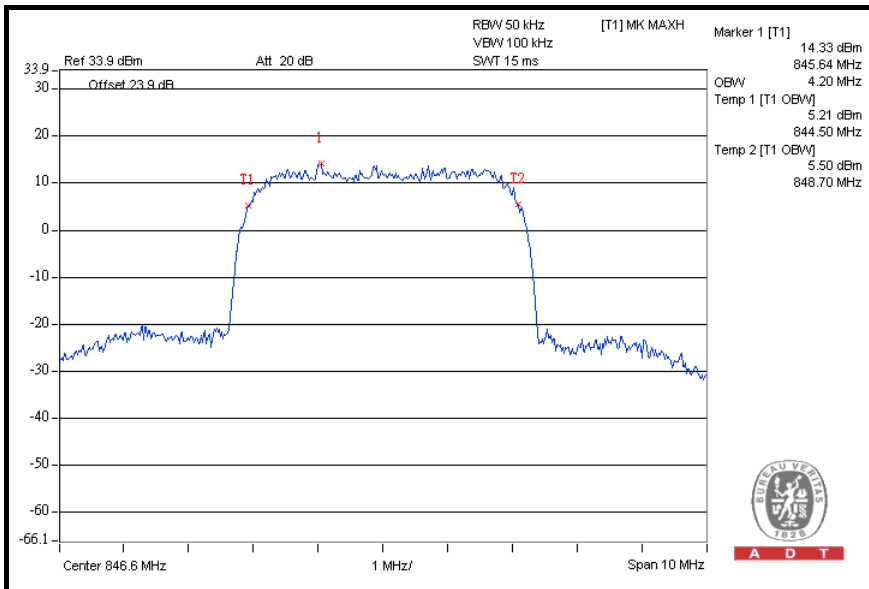

4.4 BAND EDGE MEASUREMENT

4.4.1 LIMITS OF BAND EDGE MEASUREMENT

According to FCC 22.917 specified that power of any emission outside of the authorized operating frequency ranges must be attenuated below the transmitting power (P) by a factor of at least $43 + 10 \log(P)$ dB. In the 1 MHz bands immediately outside and adjacent to the frequency block a resolution bandwidth of at least one percent of the emission bandwidth of the fundamental emission of the transmitter may be employed.

4.4.2 TEST INSTRUMENTS

DESCRIPTION & MANUFACTURER	MODEL NO.	SERIAL NO.	DATE OF CALIBRATION	DUE DATE OF CALIBRATION
ROHDE & SCHWARZ Spectrum Analyzer	FSP40	100040	Jul. 09, 2010	Jul. 08, 2011
Mini-Circuits Power Splitter	ZN2PD-9G	NA	Jun. 25, 2010	Jun. 24, 2011
RF cable	SUCOFLEX 104	274403/4	Aug. 20, 2010	Aug. 19, 2011
RF cable	SUCOFLEX 104	250729/4	Aug. 19, 2010	Aug. 18, 2011
RF cable	SUCOFLEX 104	214377/4	Aug. 19, 2010	Aug. 18, 2011
JFW 20dB attenuation	50HF-020-SMA	NA	NA	NA

NOTE: The calibration interval of the above test instruments is 12 months. And the calibrations are traceable to NML/ROC and NIST/USA.

4.4.3 TEST SETUP

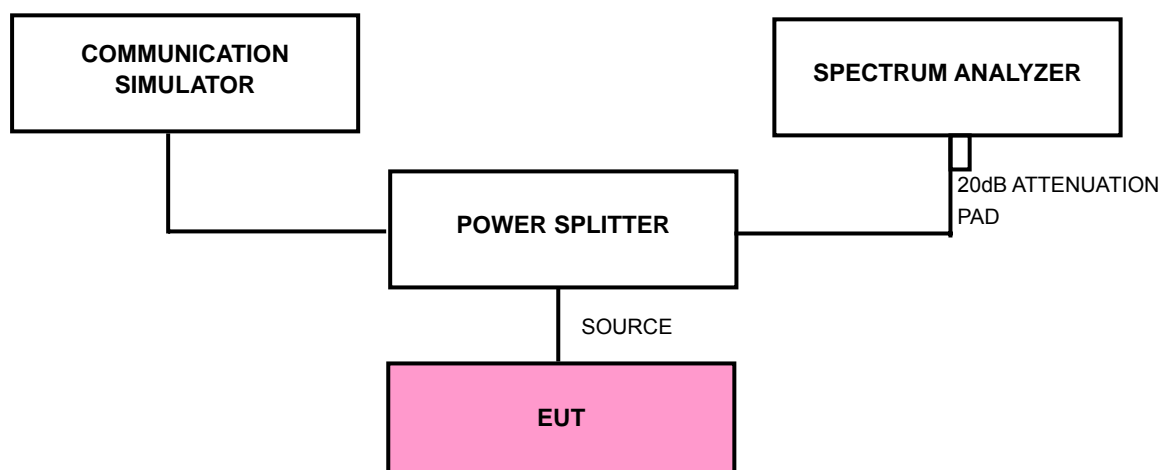

4.4.4 TEST PROCEDURES

- a. The EUT makes a call to the communication simulator. The power was measured with R&S Spectrum Analyzer. All measurements were done at 2 channels, 128 and 251 (GPRS/ E-GPRS) / 1013 and 777 (CDMA) / 4132 and 4233 (WCDMA) (low and high operational frequency range.)
- b. The band edge measurement used the power splitter via EUT RF power connector between simulation base station and spectrum analyzer. This splitter loss and cable loss is the worst loss 23.9dB in the transmitted path track.
- c. The center frequency of spectrum is the band edge frequency and span is 1.5 MHz. RB of the spectrum is 3kHz and VB of the spectrum is 10kHz (GPRS/ E-GPRS).
- d. The center frequency of spectrum is the band edge frequency and span is 3MHz. RB of the spectrum is 15kHz and VB of the spectrum is 15kHz (CDMA).
- e. The center frequency of spectrum is the band edge frequency and span is 10MHz. RB of the spectrum is 100kHz and VB of the spectrum is 300kHz (WCDMA).
- f. Record the max trace plot into the test report.

4.4.5 EUT OPERATING CONDITION

- a. The EUT makes a call to the communication simulator.
- b. The communication simulator station system controlled an EUT to export maximum output power under transmission mode and specific channel frequency.

4.4.6 TEST RESULTS

FOR GPRS / E-GPRS:

FOR GPRS MODE (UP-LINK WITH 1 TIME SLOT)

LOWER BAND EDGE

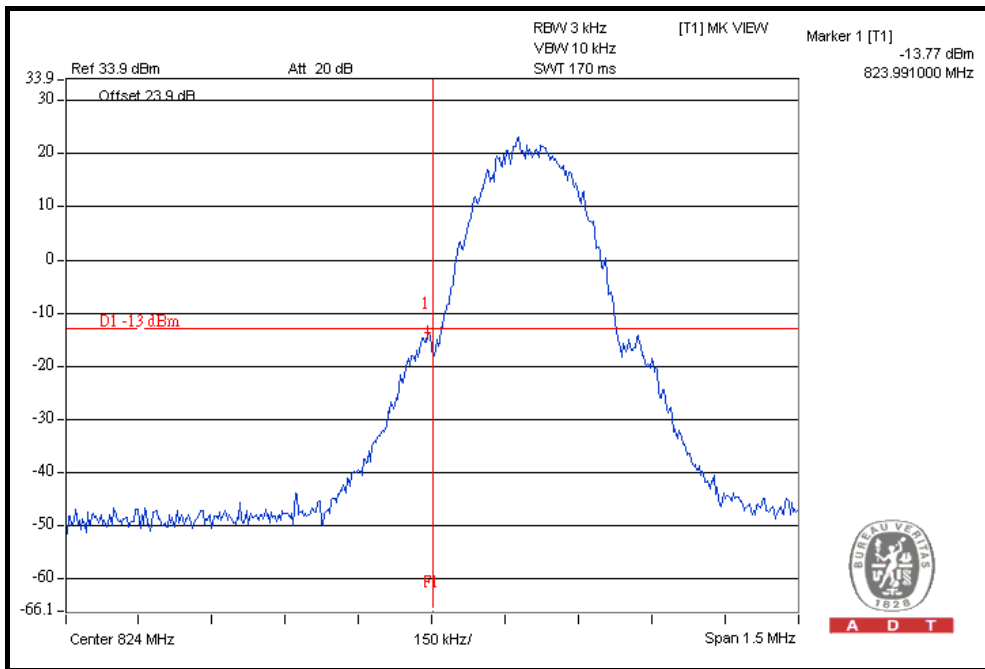

HIGHER BAND EDGE

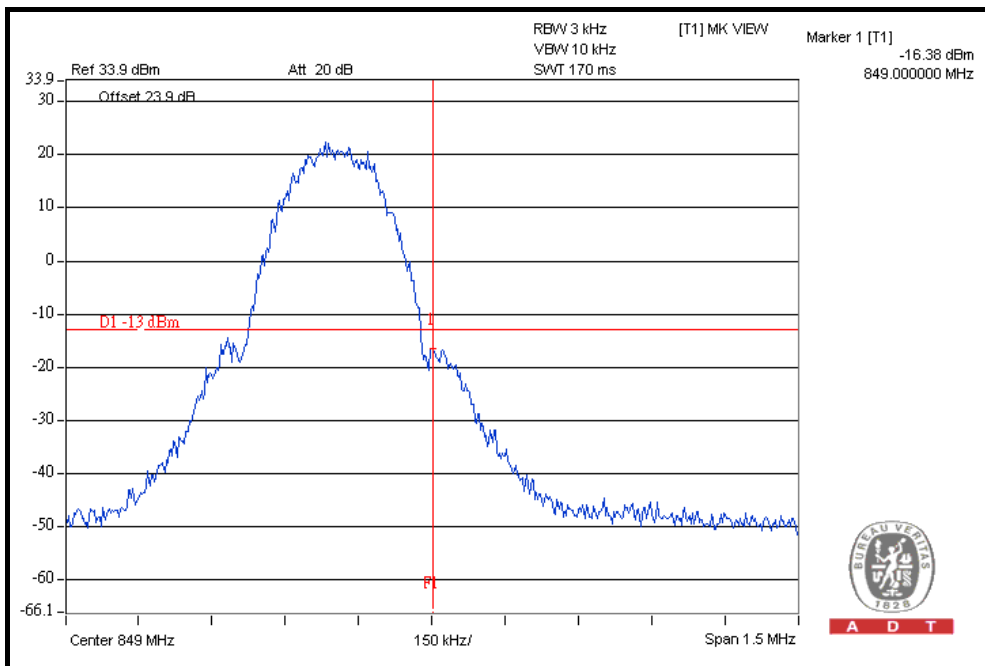



A D T

FOR E-GPRS MODE (UP-LINK WITH 1 TIME SLOT)

LOWER BAND EDGE

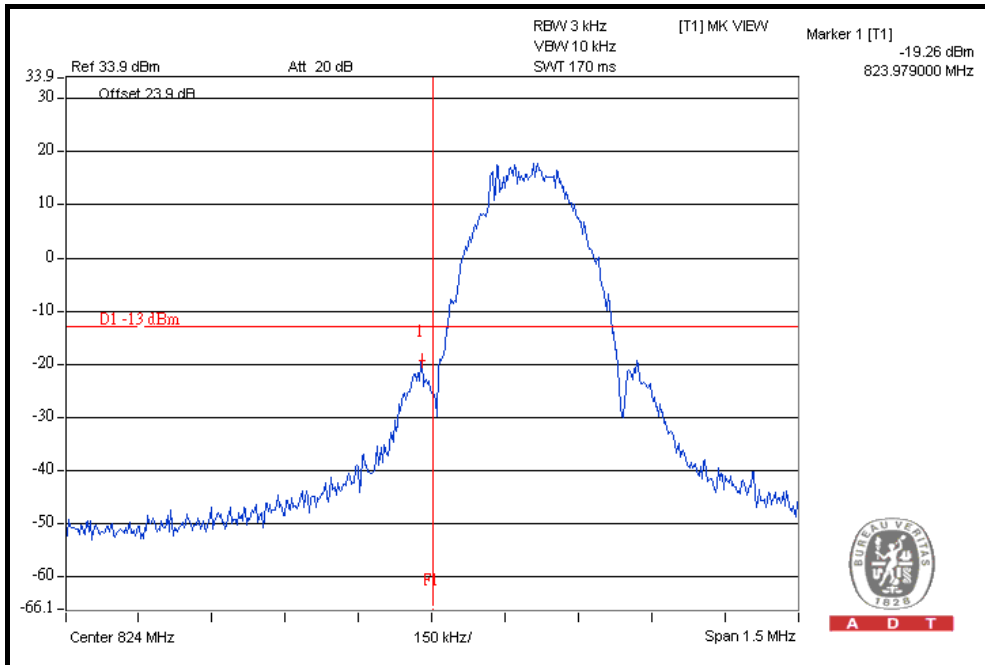

HIGHER BAND EDGE

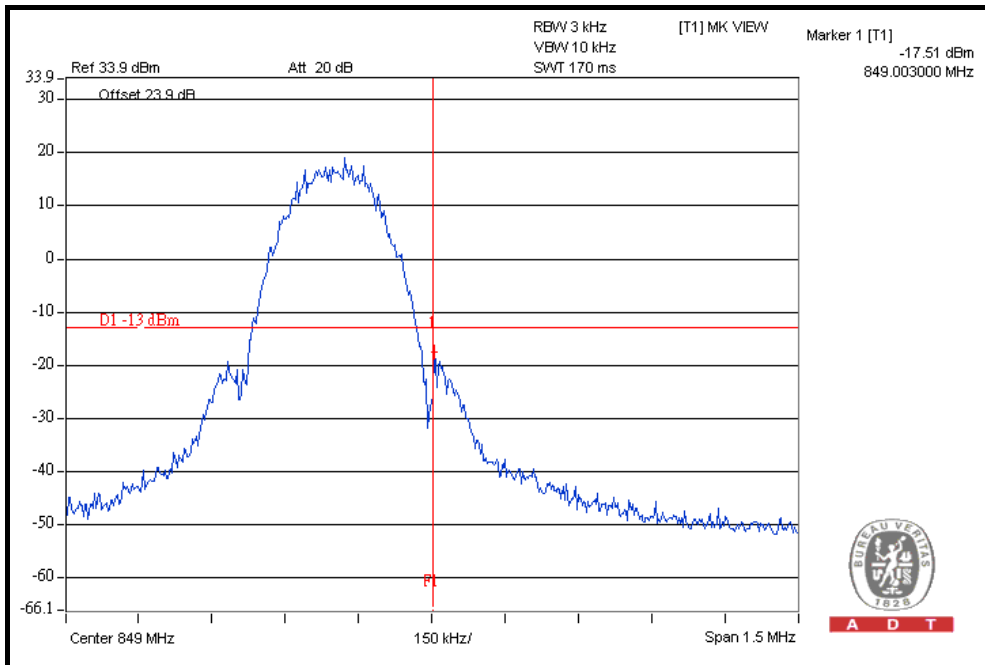



A D T

FOR CDMA:

FOR SO55:

LOWER BAND EDGE

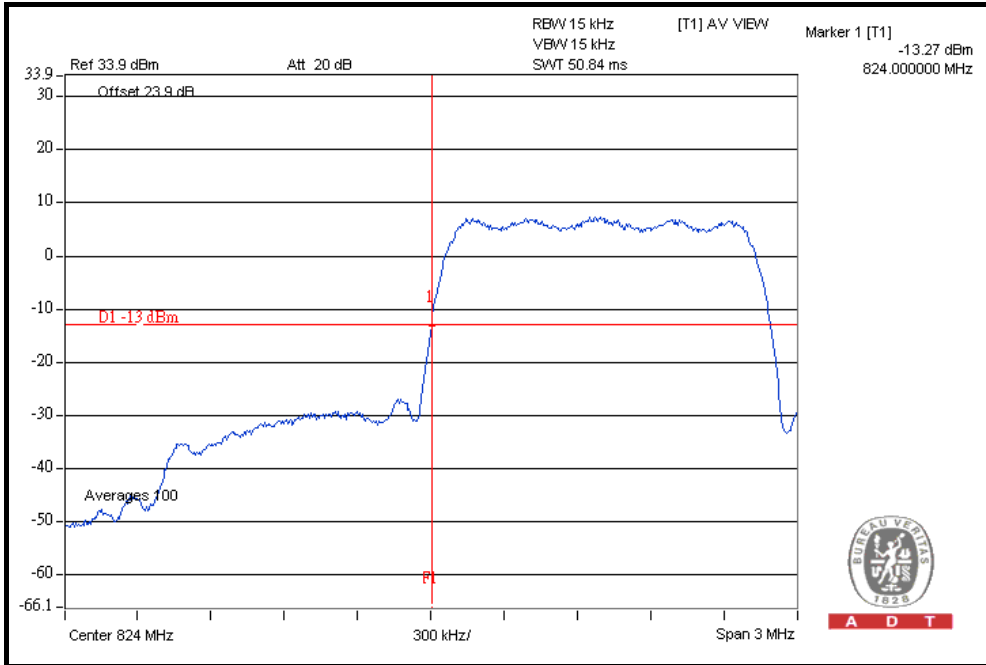

A D T

HIGHER BAND EDGE

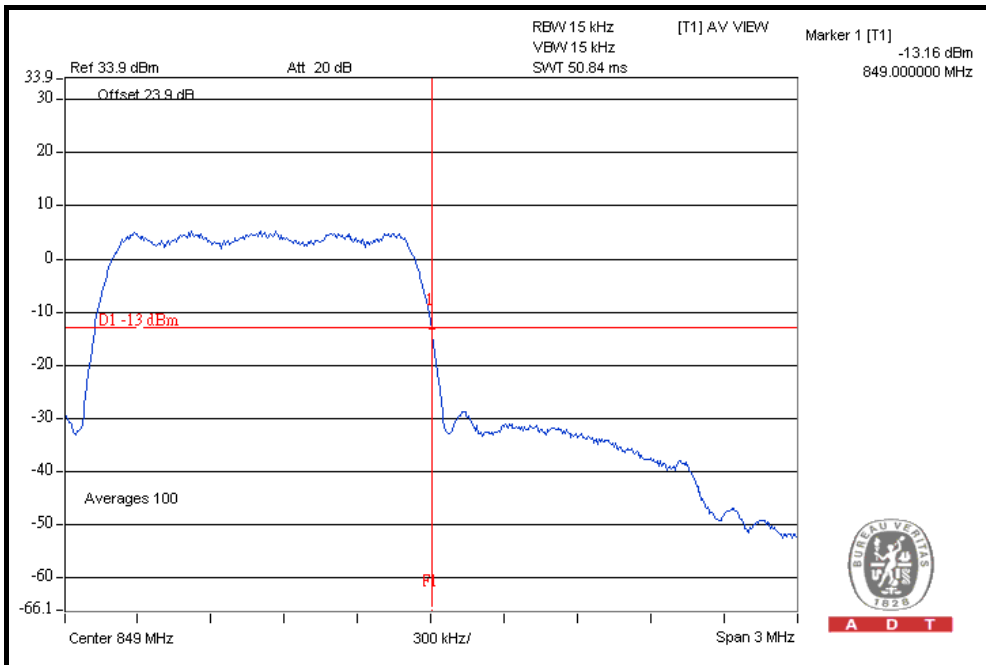

A D T



A D T

FOR EV-DO Rev. A: LOWER BAND EDGE

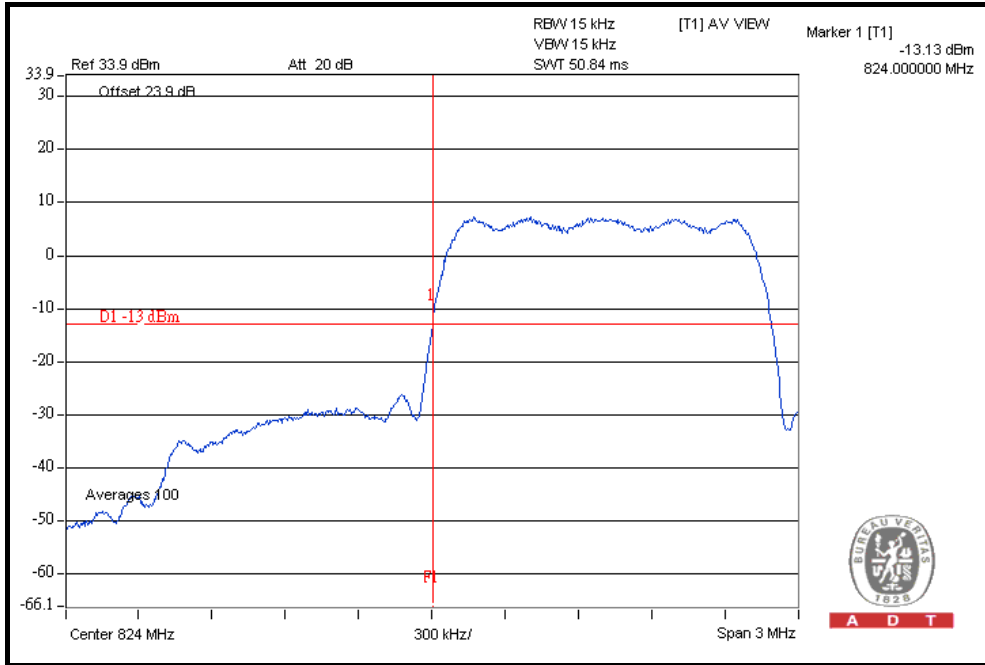

A D T

HIGHER BAND EDGE

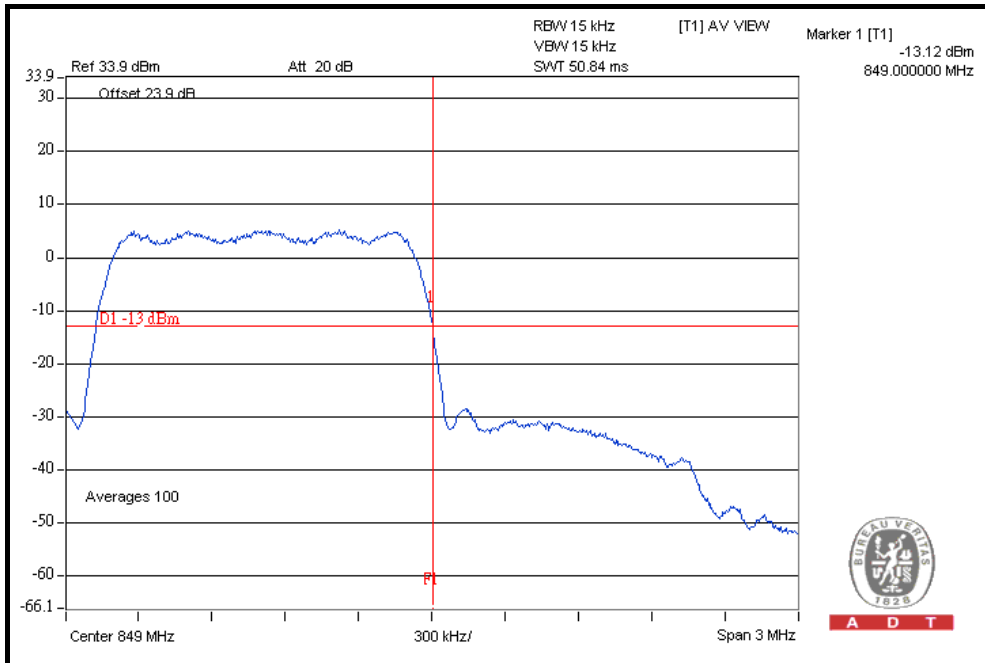

A D T



A D T

FOR EV-DO Rev. 0: LOWER BAND EDGE

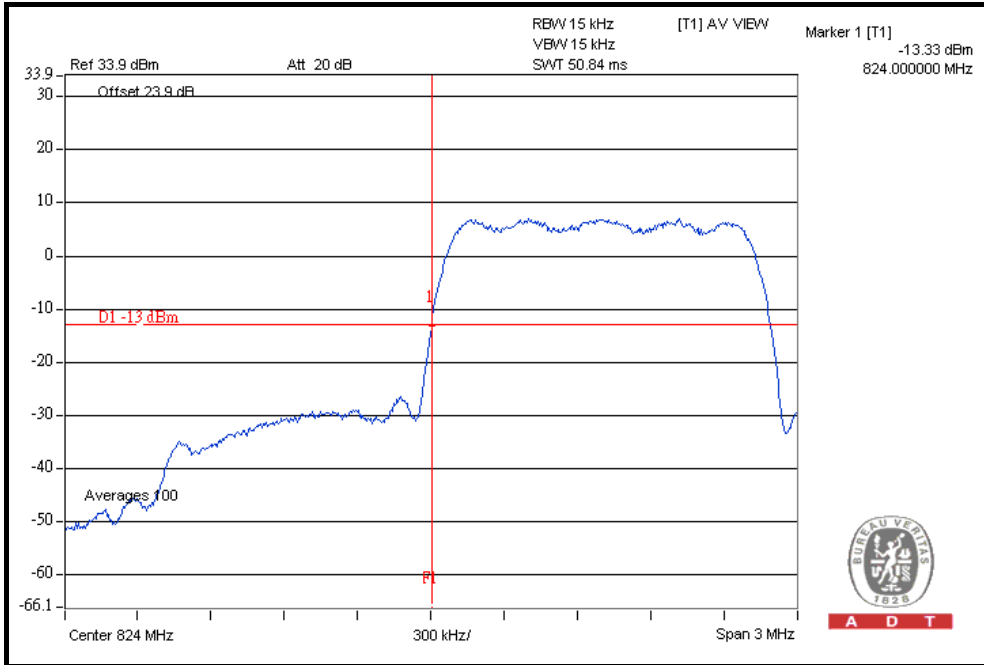

A D T

HIGHER BAND EDGE

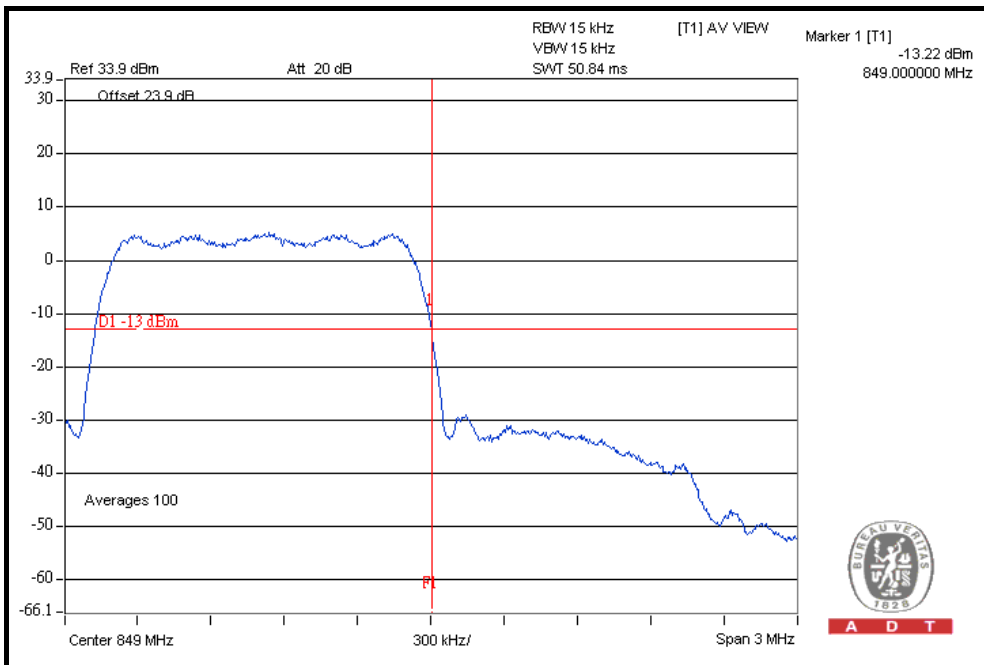

A D T



A D T

FOR WCDMA:

WCDMA-RMC MODE

LOWER BAND EDGE

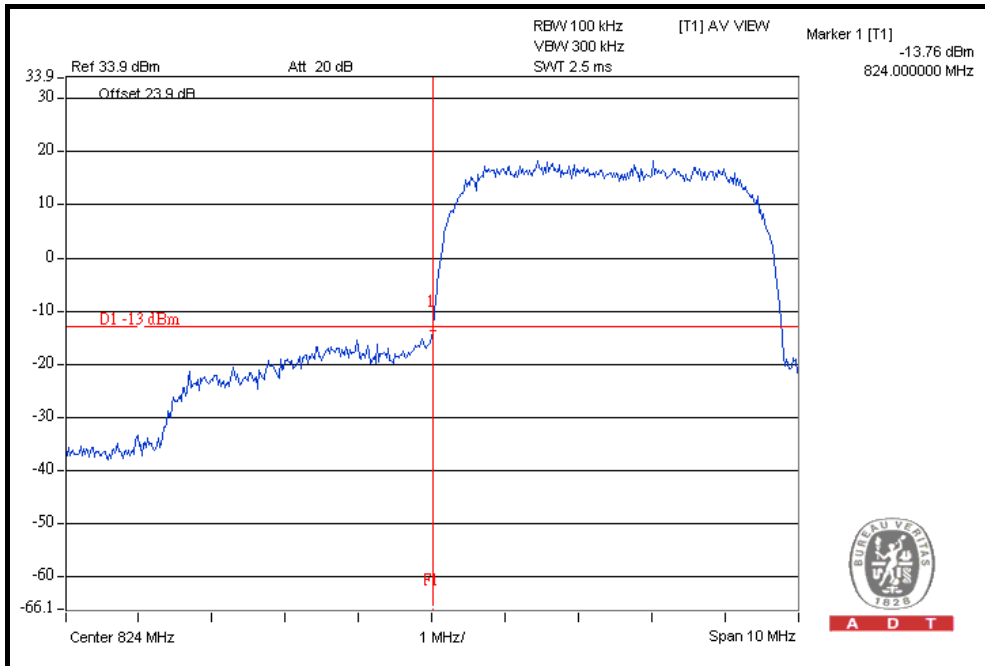

HIGHER BAND EDGE

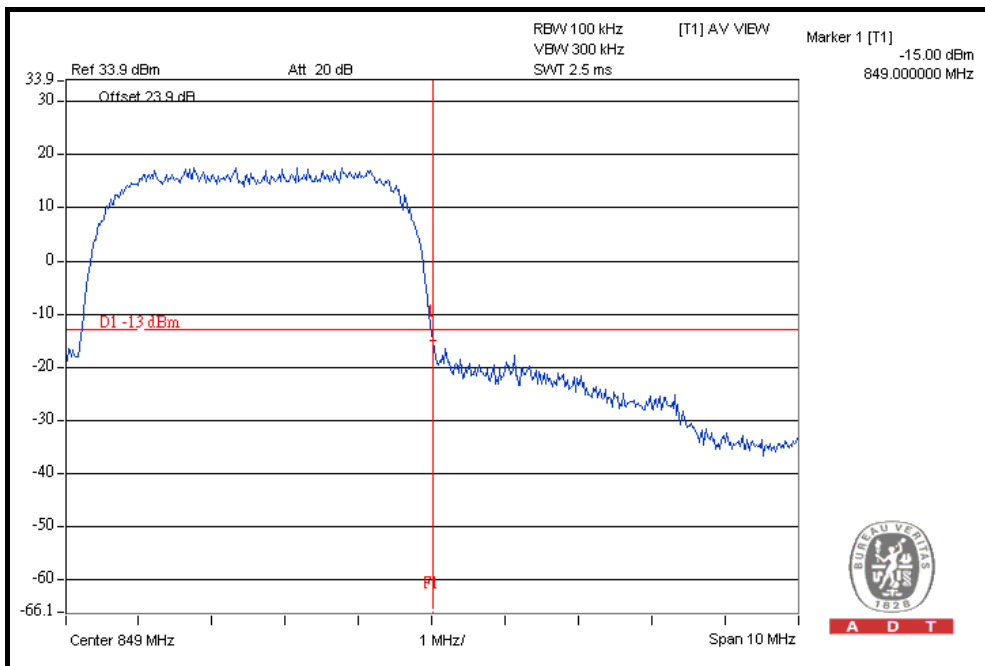



A D T

HSDPA MODE

LOWER BAND EDGE

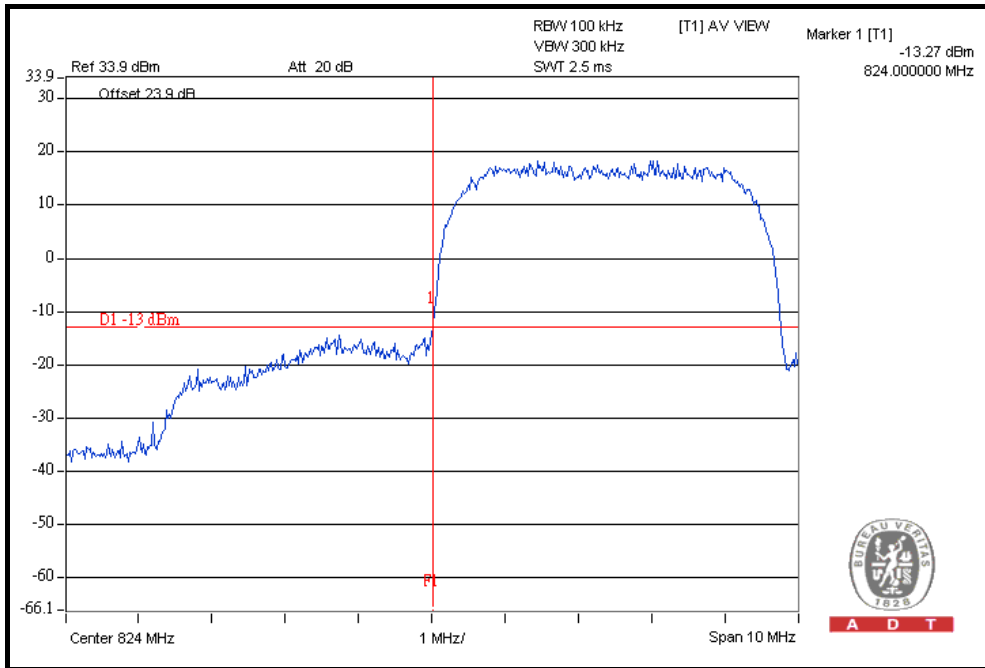

HIGHER BAND EDGE

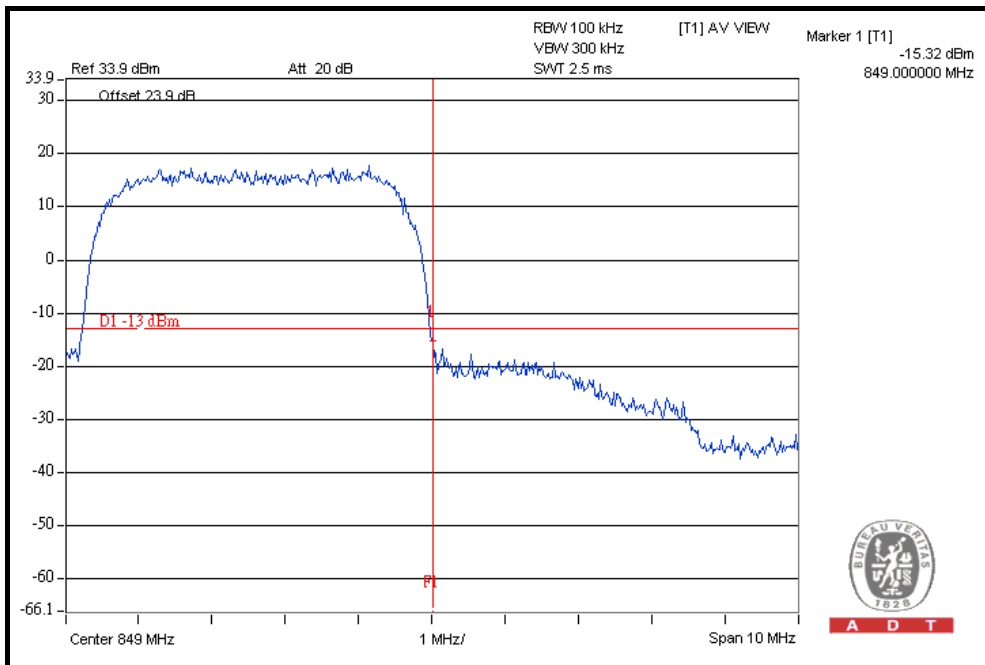



A D T

HSUPA MODE

LOWER BAND EDGE

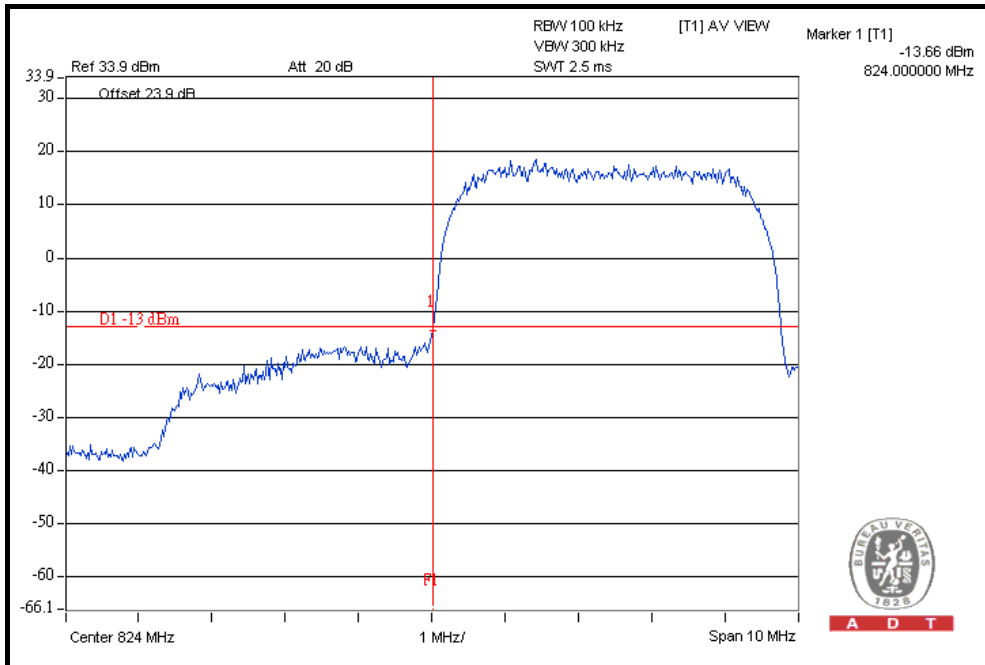

HIGHER BAND EDGE

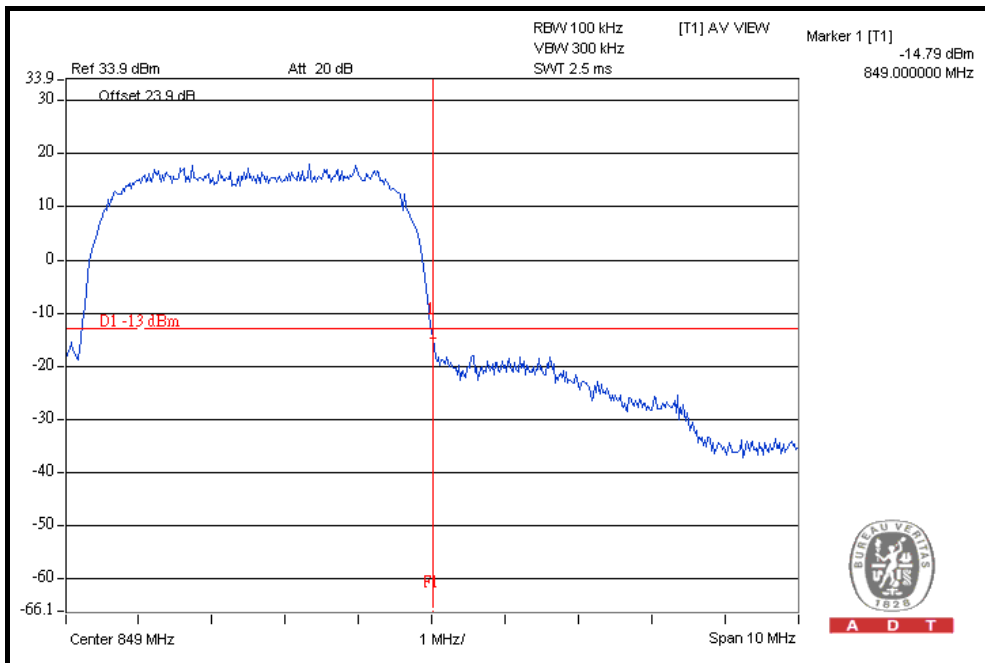



4.5 CONDUCTED SPURIOUS EMISSIONS

4.5.1 LIMITS OF CONDUCTED SPURIOUS EMISSIONS MEASUREMENT

In the FCC 22.917, On any frequency outside a licensee's frequency block within GPRS spectrum, the power of any emission shall be attenuated below the transmitter power (P) by at least $43 + 10 \log (P)$ dB. The emission limit equal to -13dBm .

4.5.2 TEST INSTRUMENTS

DESCRIPTION & MANUFACTURER	MODEL NO.	SERIAL NO.	DATE OF CALIBRATION	DUE DATE OF CALIBRATION
ROHDE & SCHWARZ Spectrum Analyzer	FSP40	100040	Jul. 09, 2010	Jul. 08, 2011
Wainwright Instruments Band Reject Filter	WRCG 824/849-810/ 863-60/9SS	SN1	Mar. 25, 2010	Mar. 24, 2011
WI Highpass filter	WHK1.5/15G-10ST	SN1	Mar. 30, 2010	Mar. 29, 2011
Mini-Circuits Power Splitter	ZN2PD-9G	NA	Jun. 25, 2010	Jun. 24, 2011
RF cable	SUCOFLEX 104	274403/4	Aug. 20, 2010	Aug. 19, 2011
RF cable	SUCOFLEX 104	250729/4	Aug. 19, 2010	Aug. 18, 2011
RF cable	SUCOFLEX 104	214377/4	Aug. 19, 2010	Aug. 18, 2011
JFW 20dB attenuation	50HF-020-SMA	NA	NA	NA

NOTE: The calibration interval of the above test instruments is 12 months. And the calibrations are traceable to NML/ROC and NIST/USA.

4.5.3 TEST PROCEDURE

- a. The EUT makes a phone call to the communication simulator. The power was measured with R&S Spectrum Analyzer. All measurements were done at 3 channels, 128, 190 and 251 (GPRS) / 1013, 384 and 777 (CDMA) / 4132, 4182 and 4233 (WCDMA) (low, middle and high operational frequency range.)
- b. The conducted spurious emission used the power splitter via EUT RF power connector between simulation base station and spectrum analyzer. This splitter loss and cable loss are the worst loss 23.9dB in the transmitted path track.
- c. When the spectrum scanned from 9kHz to 1GHz, it shall be connected to the band reject filter attenuated the carried frequency. The spectrum set RB=1MHz, VB=3MHz.
- d. When the spectrum scanned from 1GHz to 9GHz, it shall be connected to the high pass filter attenuated the carried frequency. The spectrum set RB=1MHz, VB=3MHz.

4.5.4 TEST SETUP

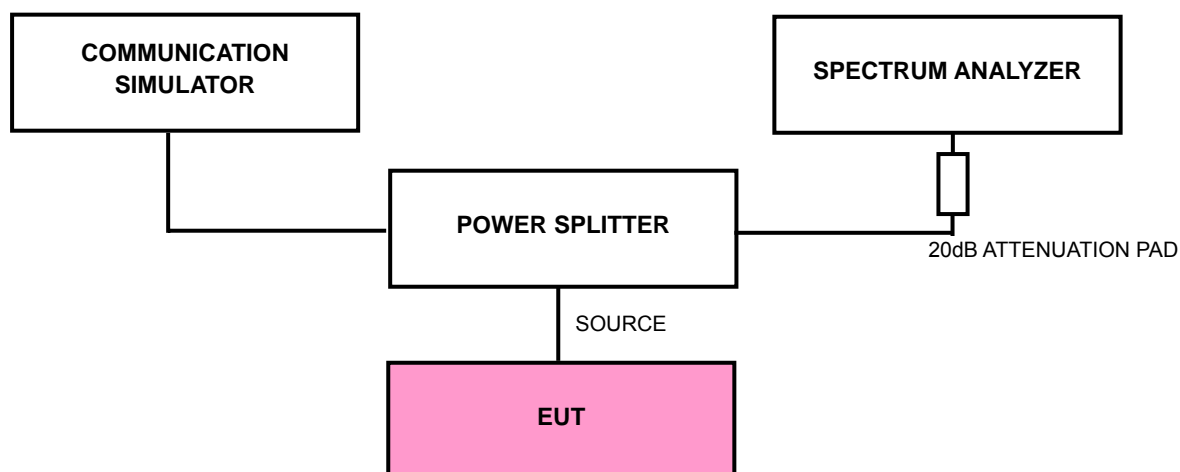

4.5.5 EUT OPERATING CONDITIONS

- a. The EUT makes a phone call to the communication simulator.
- b. The communication simulator station system controlled an EUT to export maximum output power under transmission mode and specific channel frequency.



A D T

4.5.6 TEST RESULTS

FOR GPRS:

CH 128: 9kHz ~ 1GHz

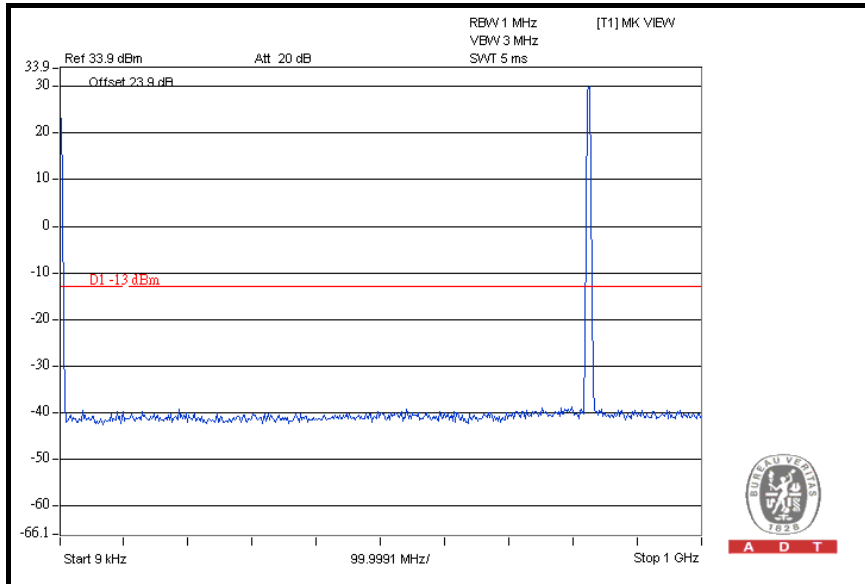

1GHz ~ 4GHz

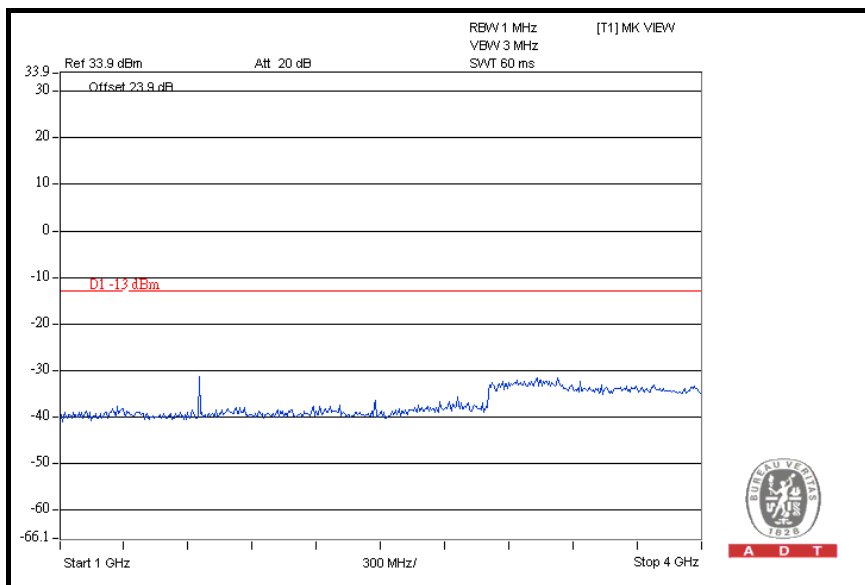



A D T

4GHz ~ 7GHz

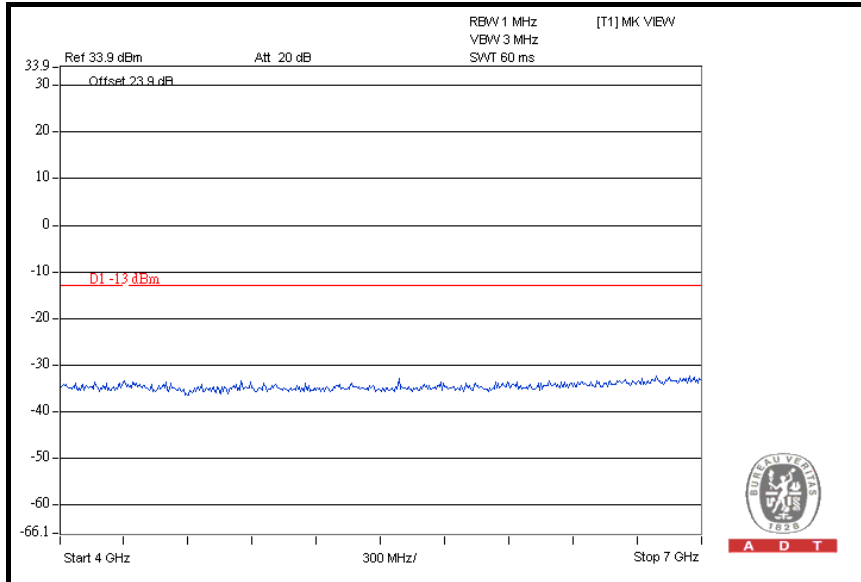

7GHz ~ 9GHz

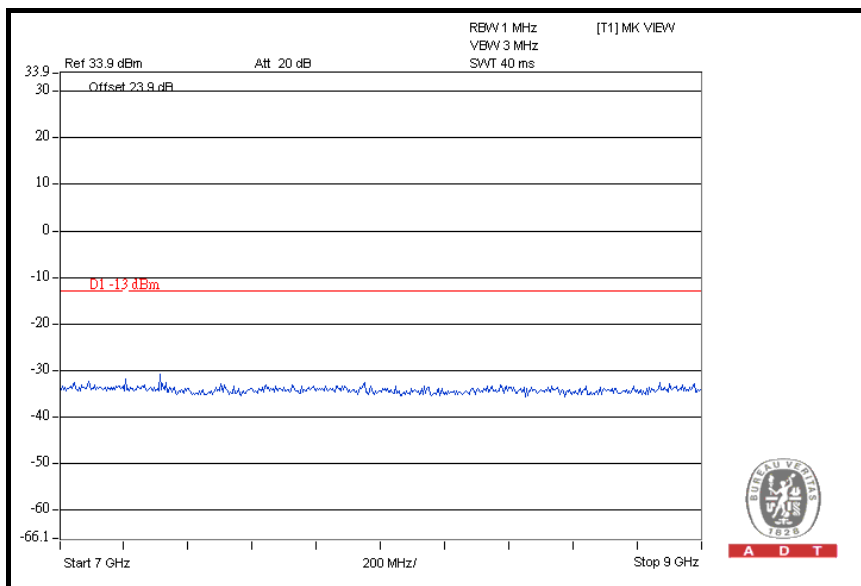



A D T

CH 190: 9kHz ~ 1GHz

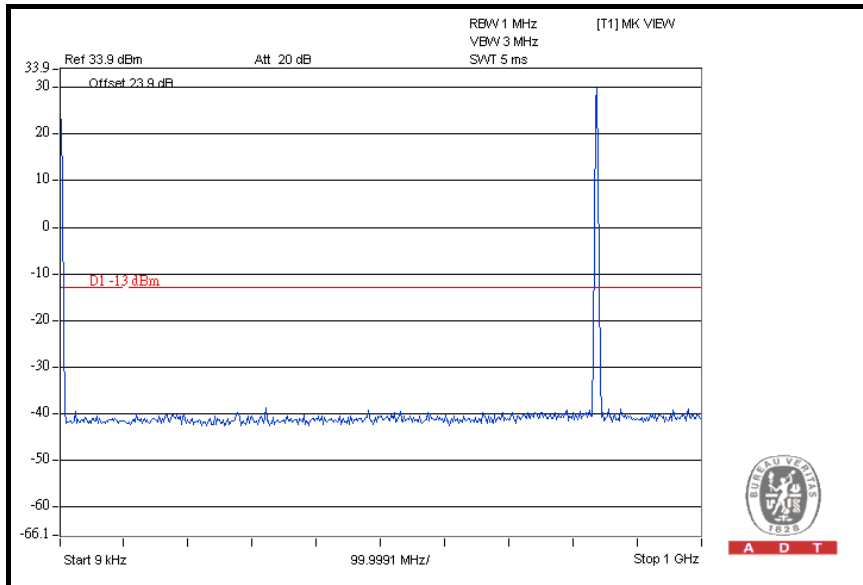

1GHz ~ 4GHz

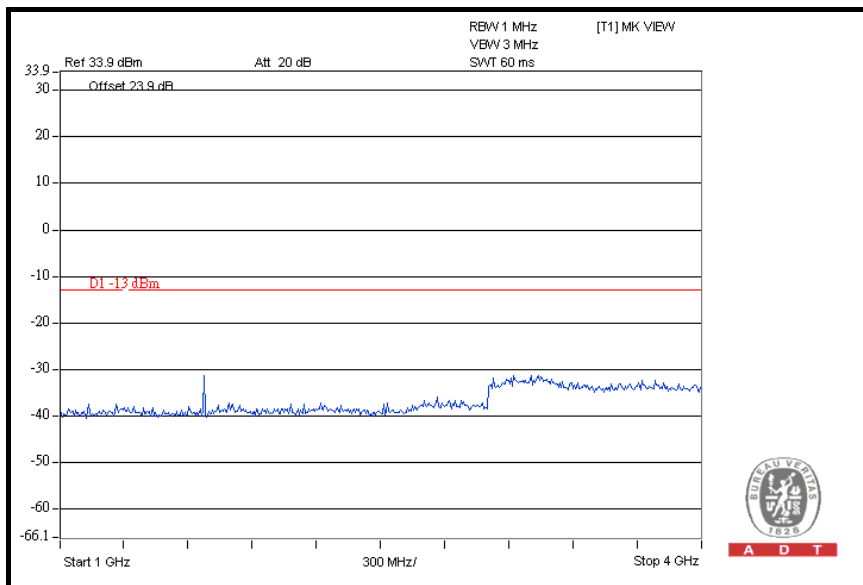



A D T

4GHz ~ 7GHz

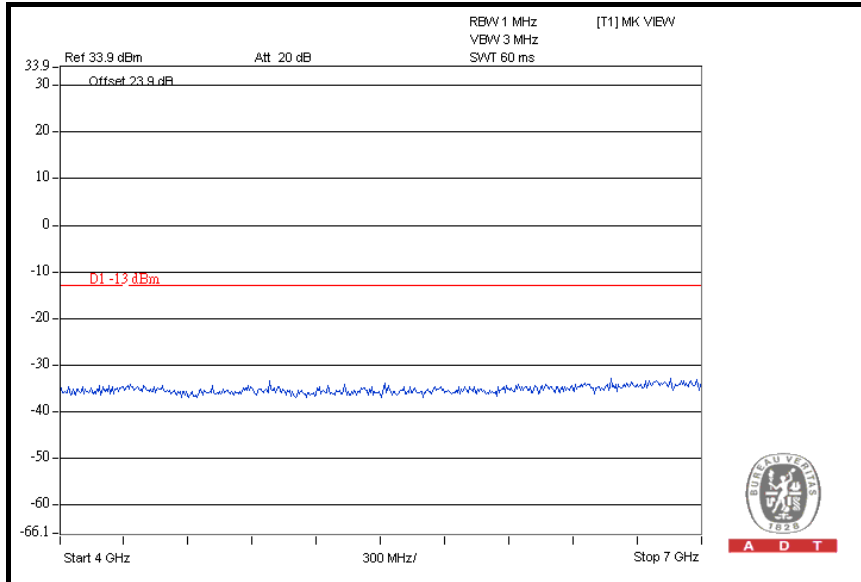

7GHz ~ 9GHz

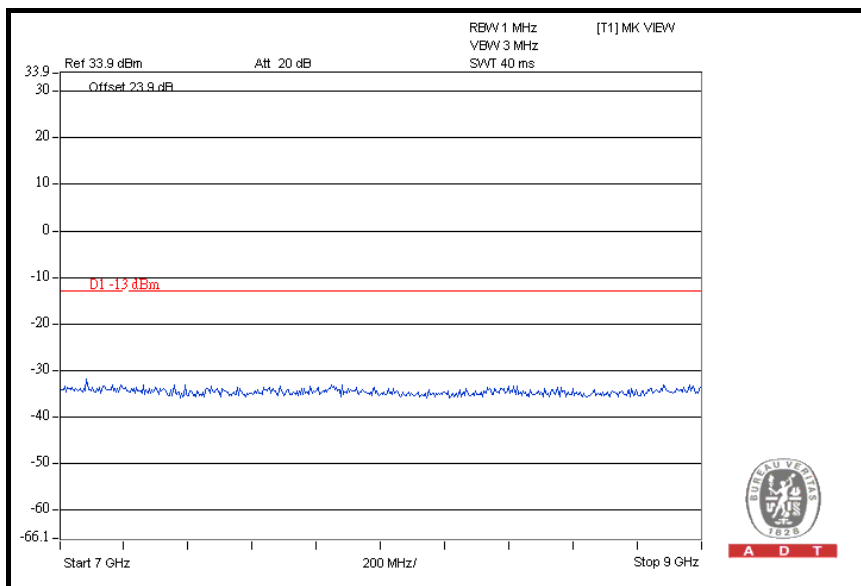



A D T

CH 251: 9kHz ~ 1GHz

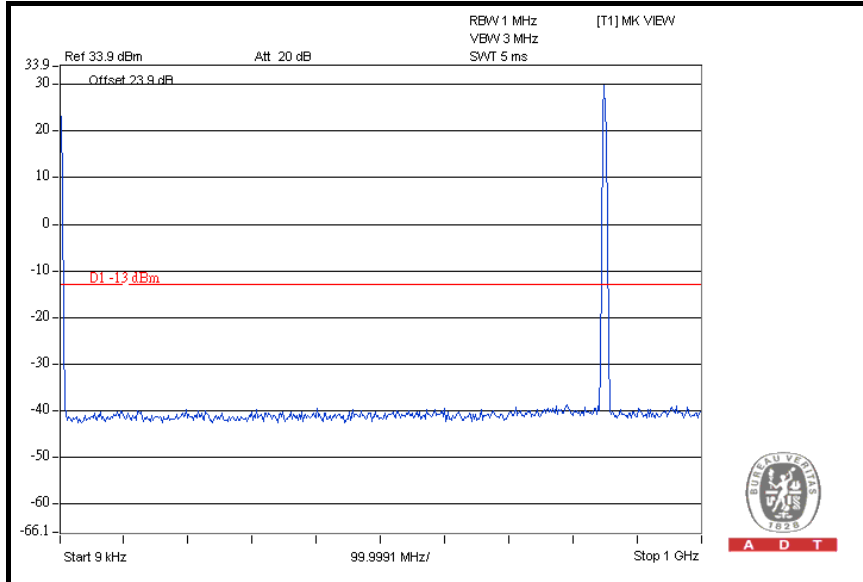

1GHz ~ 4GHz

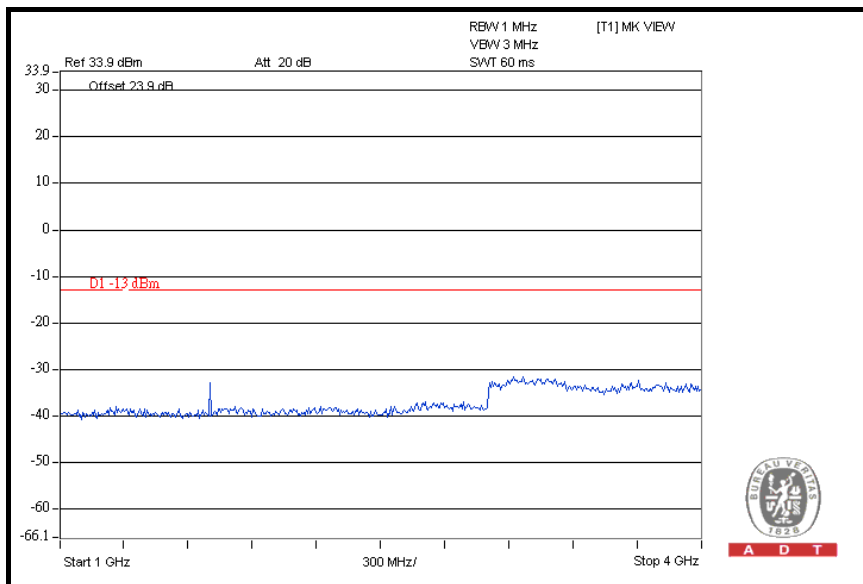



A D T

4GHz ~ 7GHz

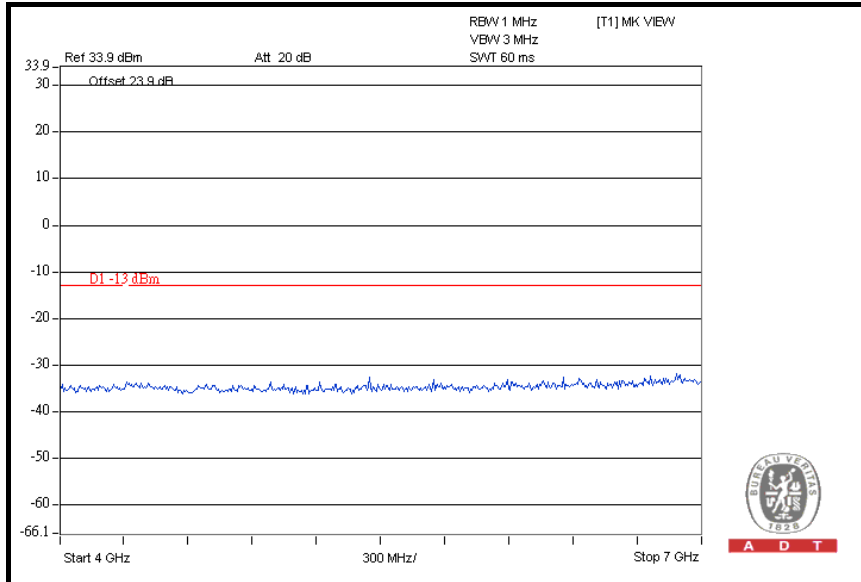

7GHz ~ 9GHz

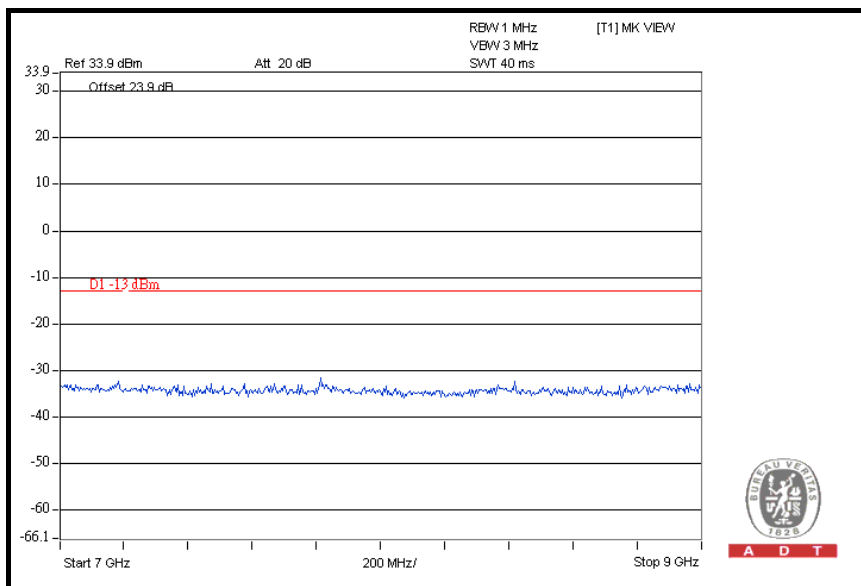

FOR CDMA:

CH 1013: 9kHz ~ 1GHz

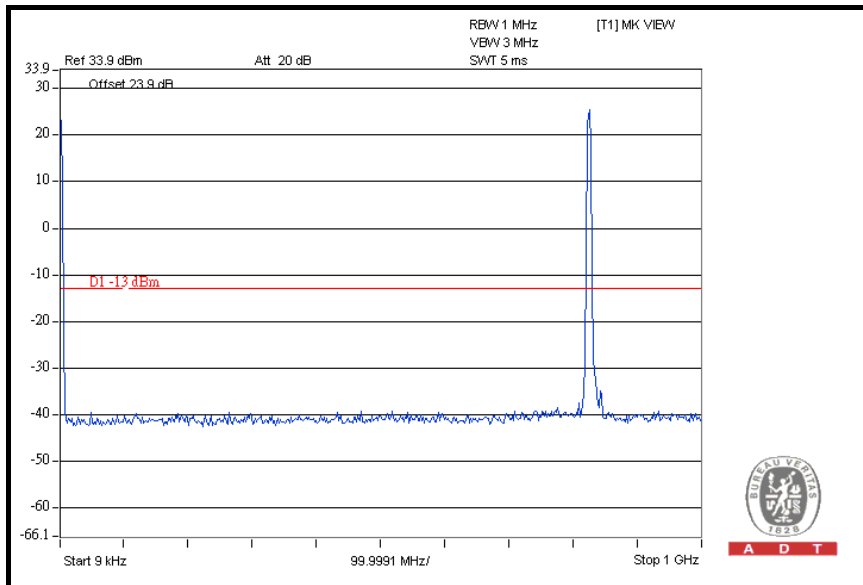

1GHz ~ 4GHz

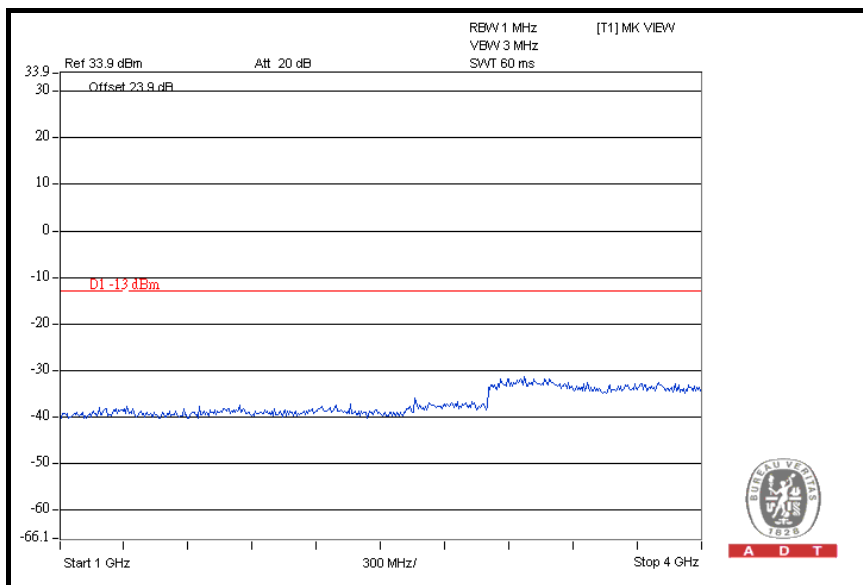



A D T

4GHz ~ 7GHz

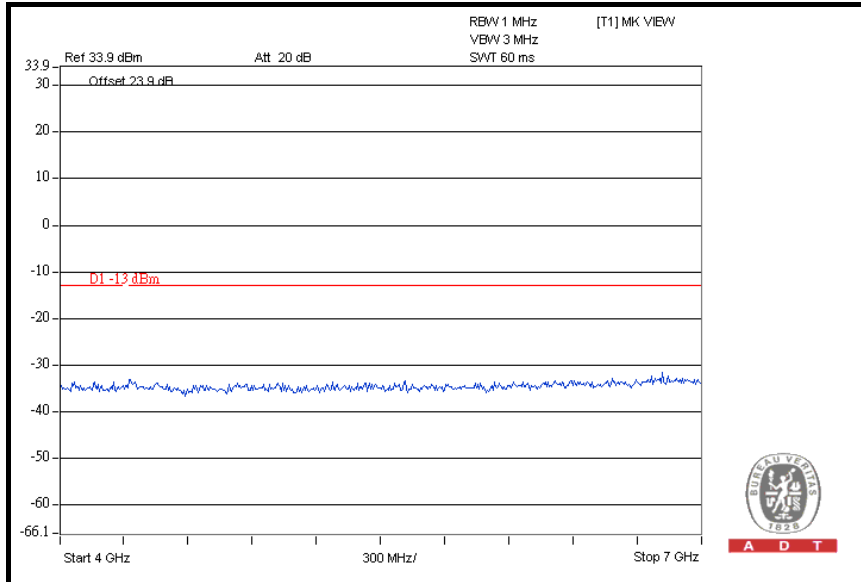

7GHz ~ 9GHz

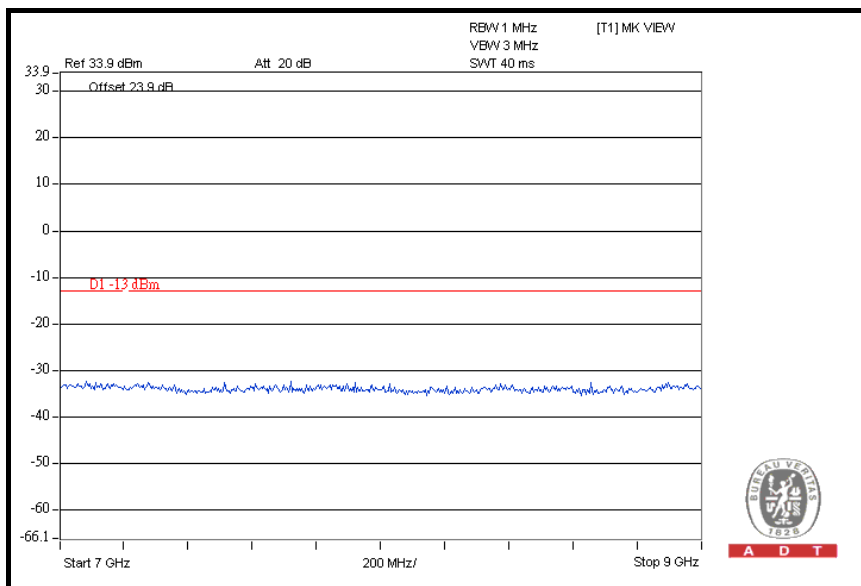



A D T

CH 384: 9kHz ~ 1GHz

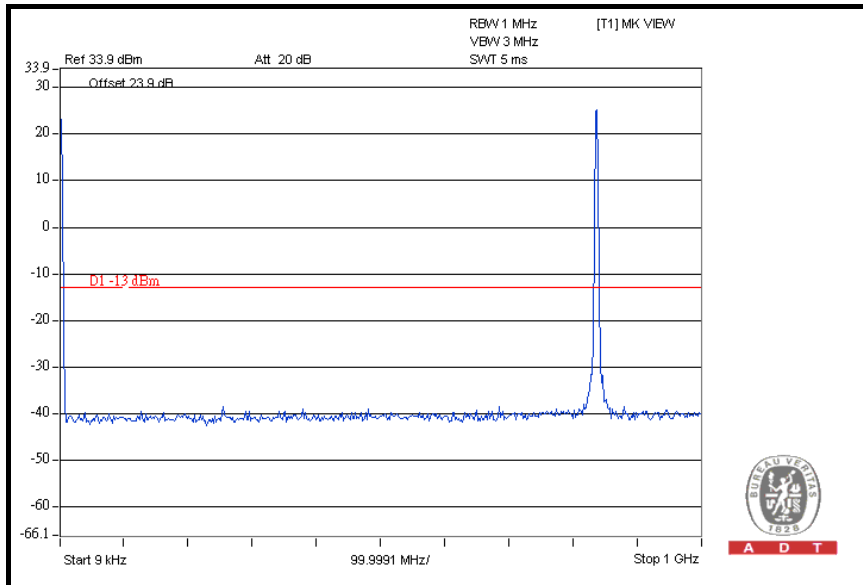

1GHz ~ 4GHz

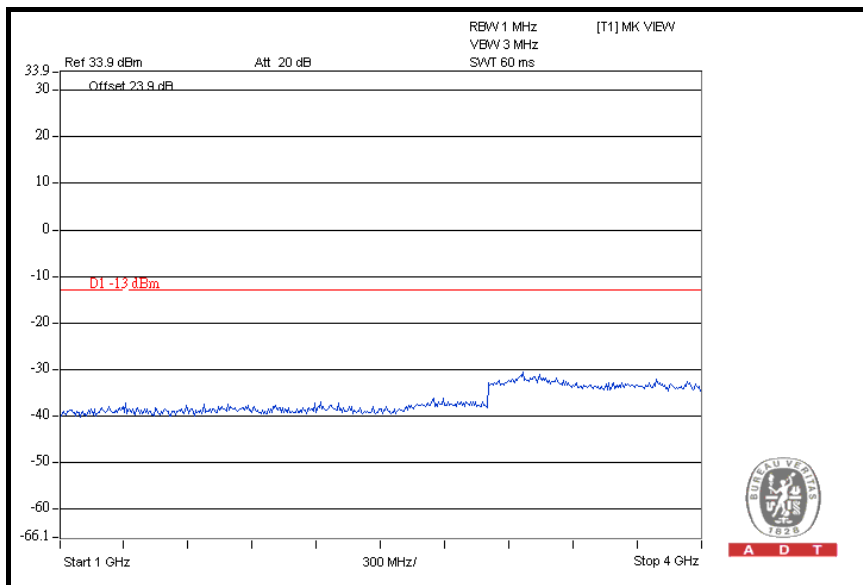



A D T

4GHz ~ 7GHz

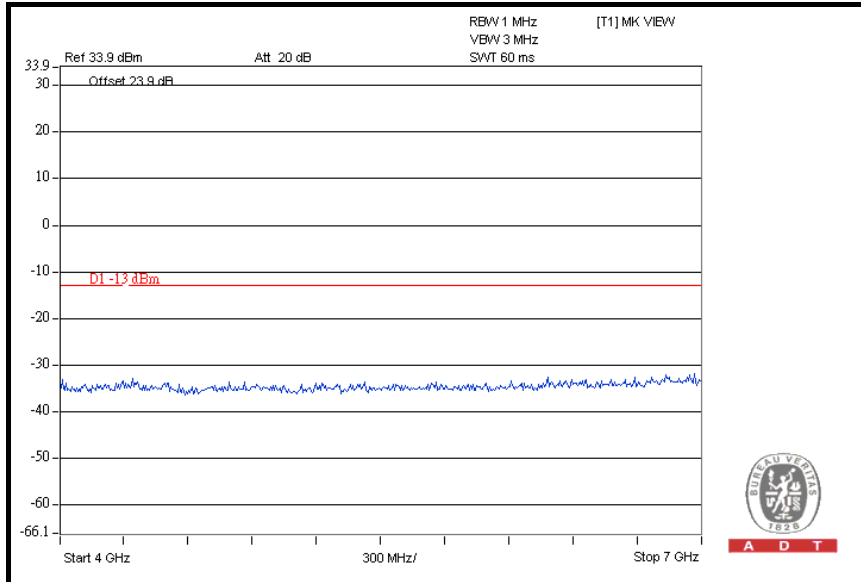

7GHz ~ 9GHz

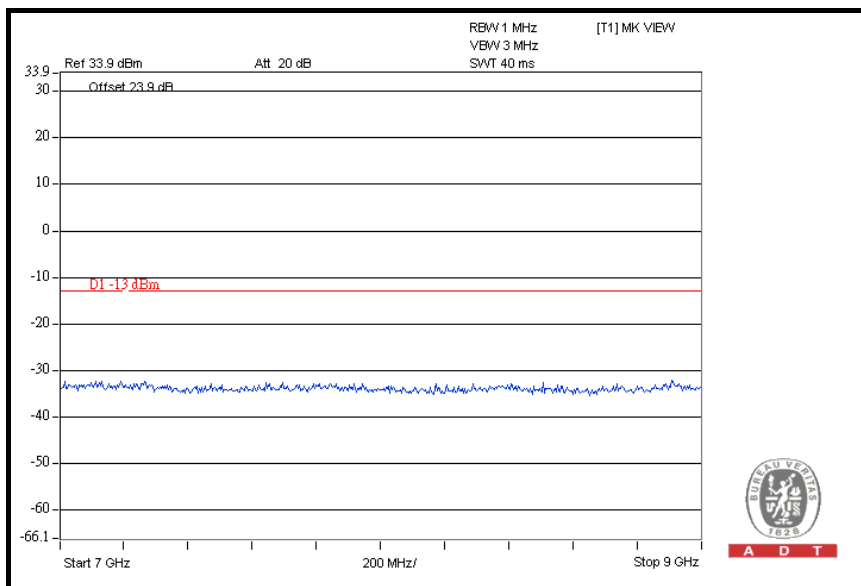

CH 777: 9kHz ~ 1GHz

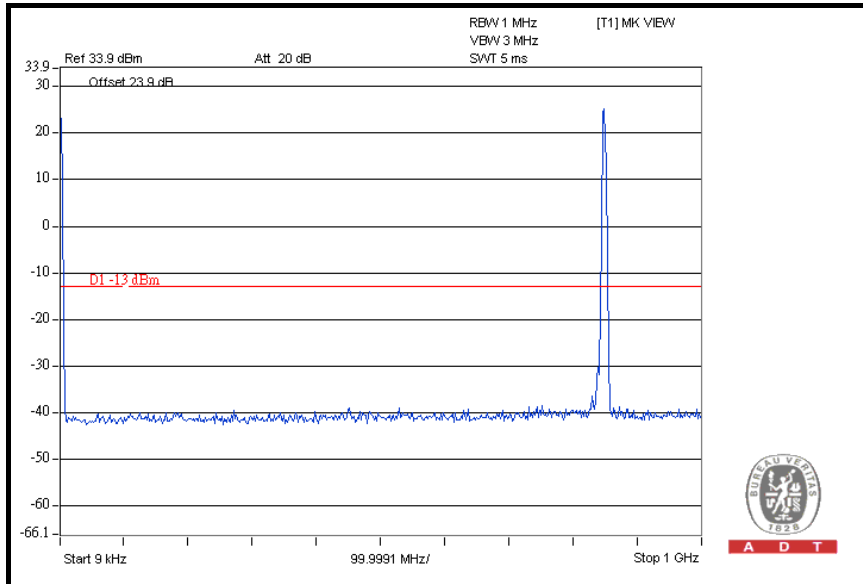

1GHz ~ 4GHz

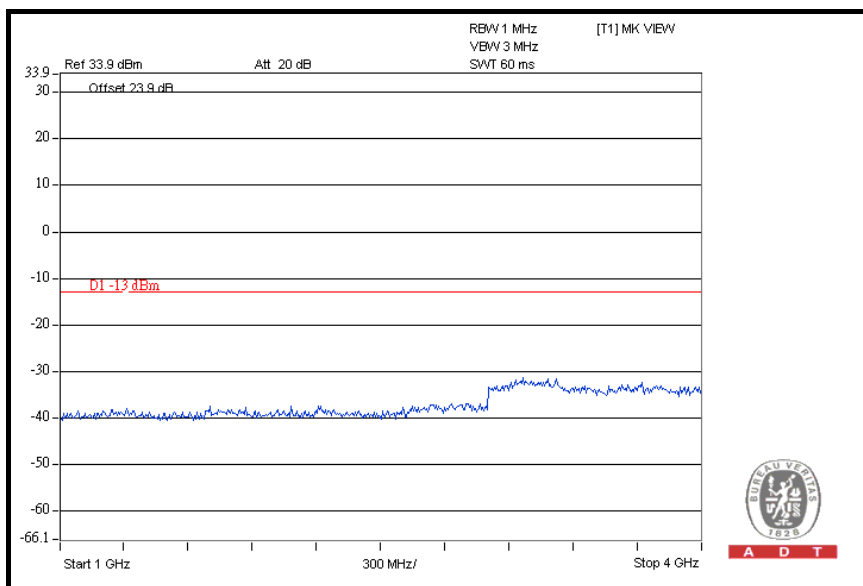



A D T

4GHz ~ 7GHz

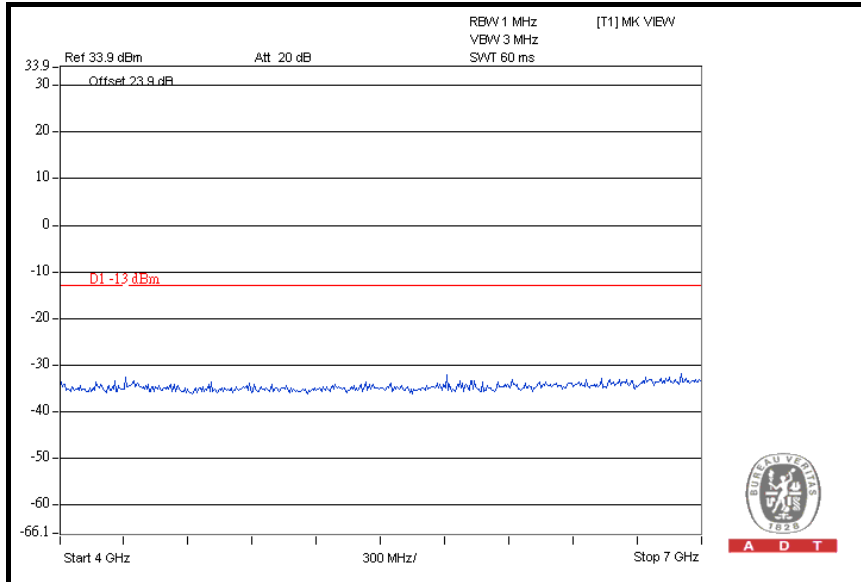

7GHz ~ 9GHz

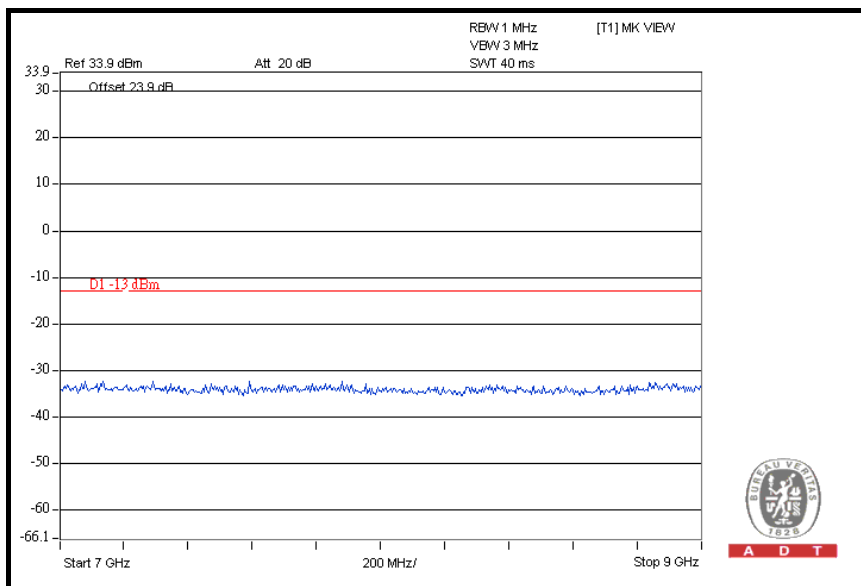

FOR WCDMA:

CH 4132: 9kHz ~ 1GHz

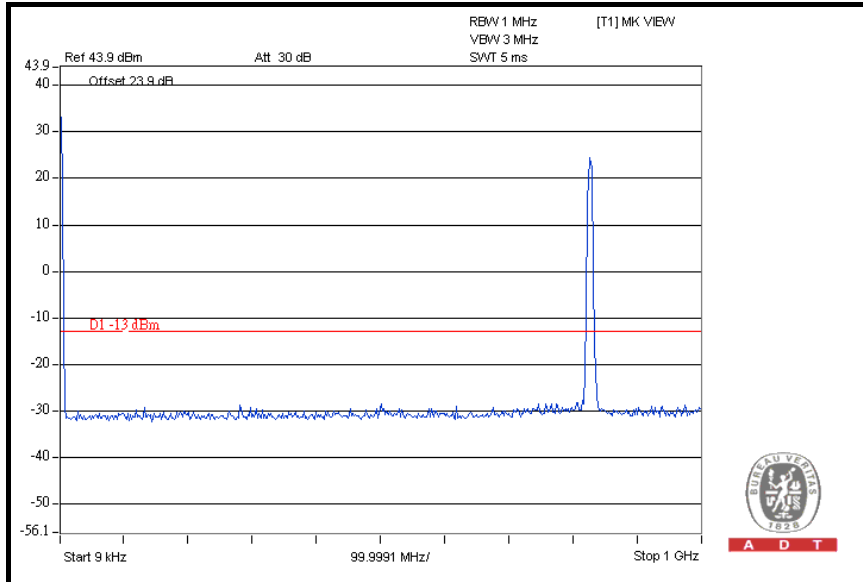

1GHz ~ 4GHz

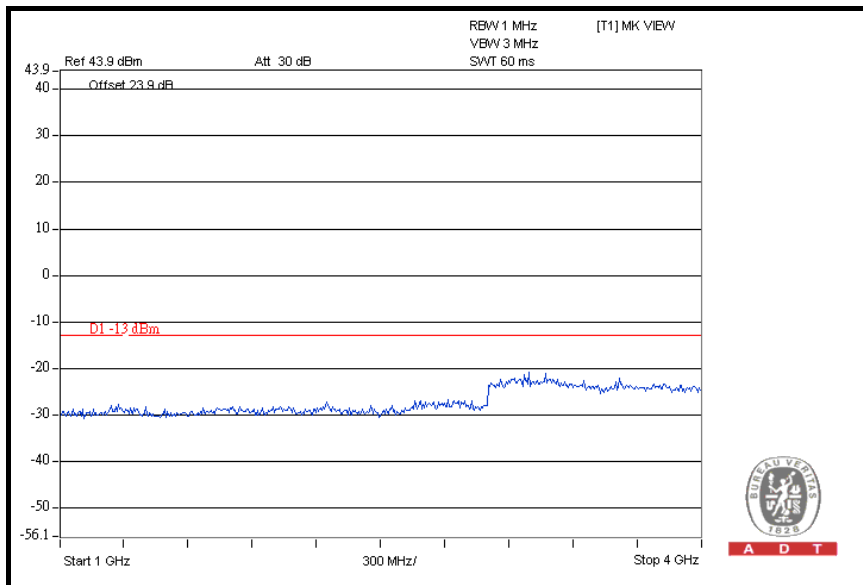



A D T

4GHz ~ 7GHz

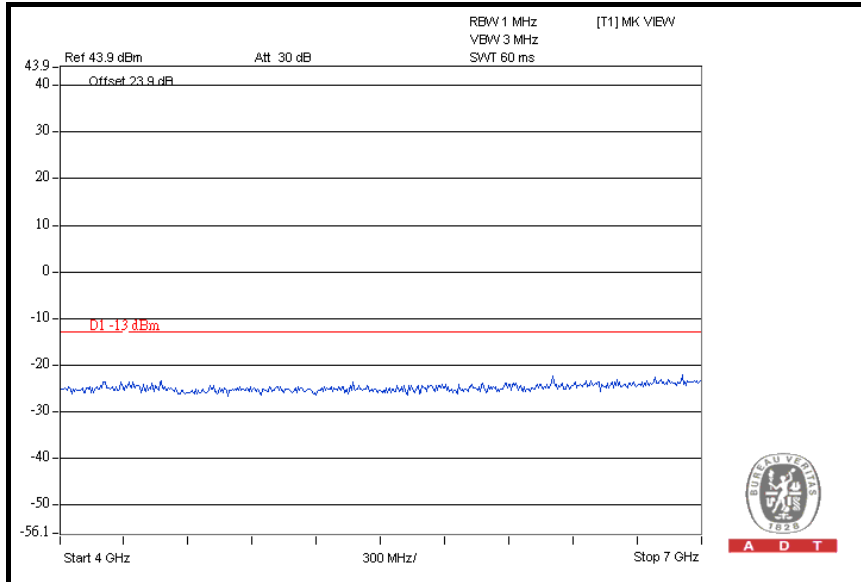

7GHz ~ 9GHz

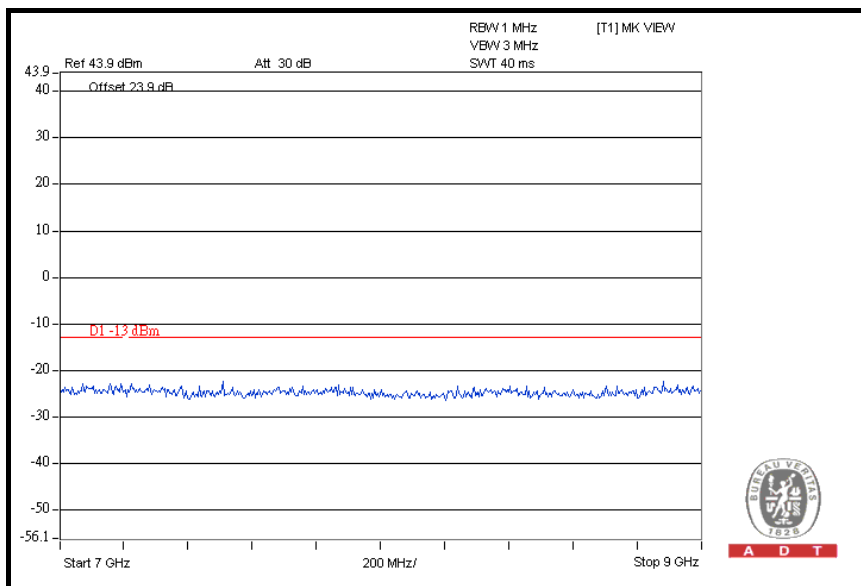

CH 4182: 9kHz ~ 1GHz

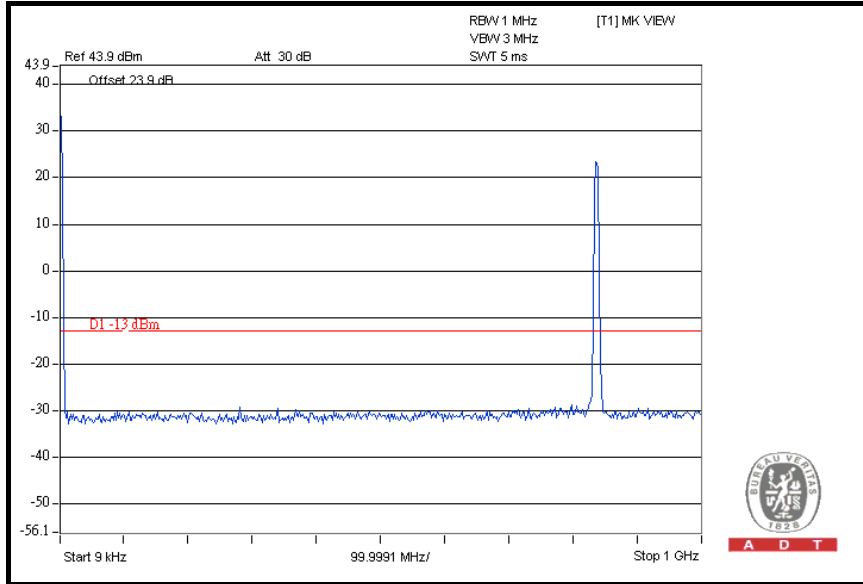

1GHz ~ 4GHz

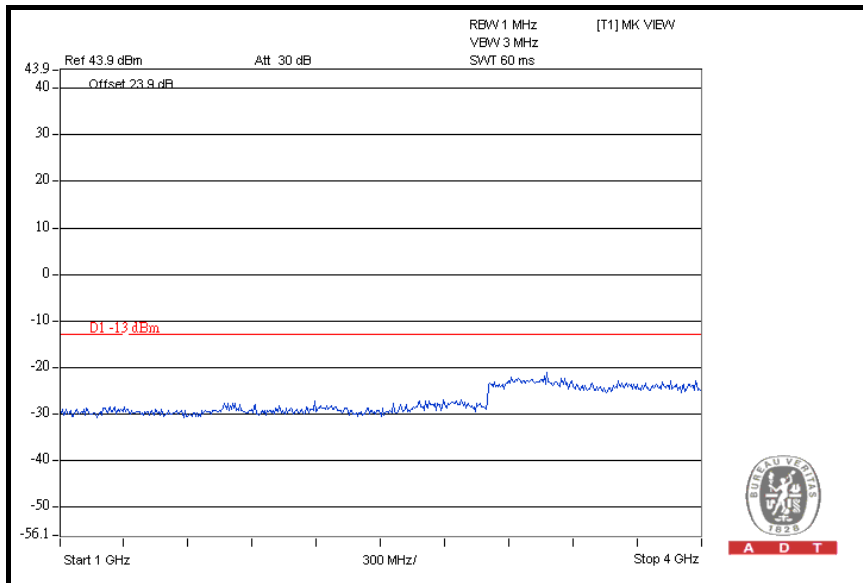



A D T

4GHz ~ 7GHz

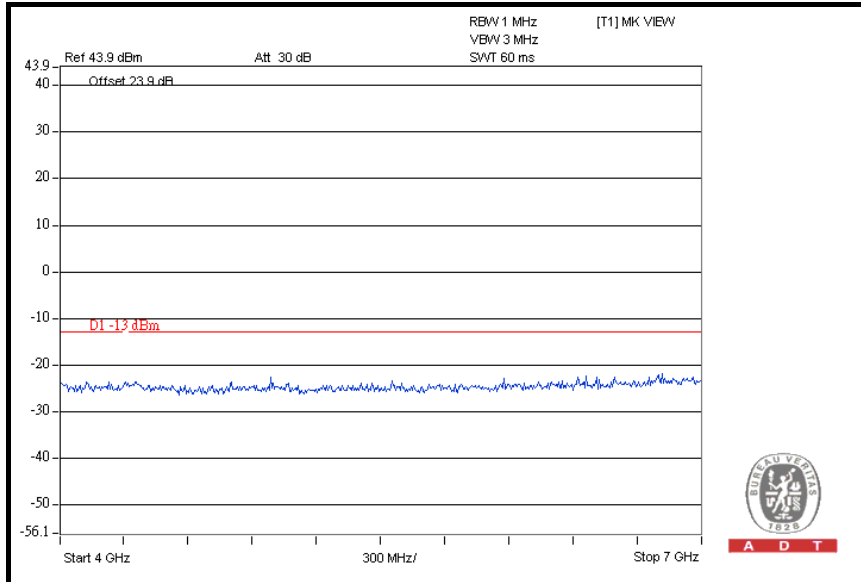

7GHz ~ 9GHz

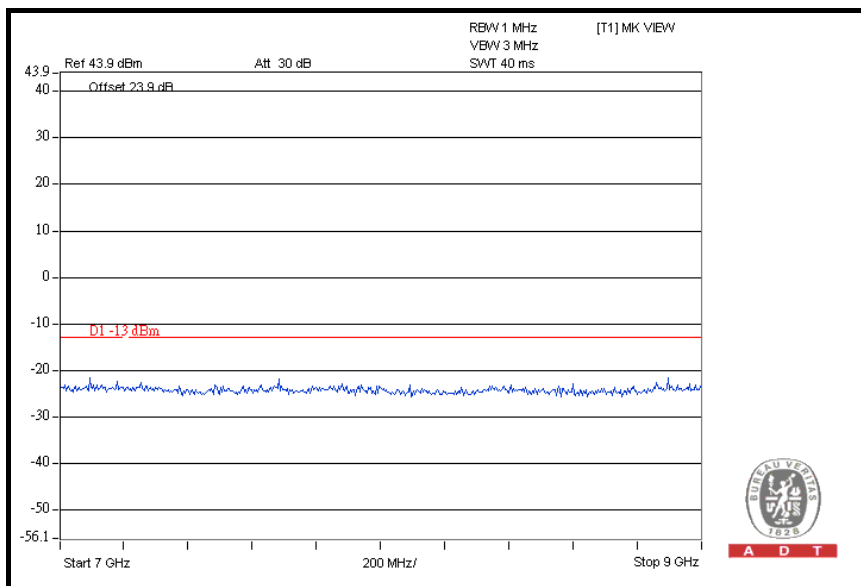



A D T

CH 4233: 9kHz ~ 1GHz

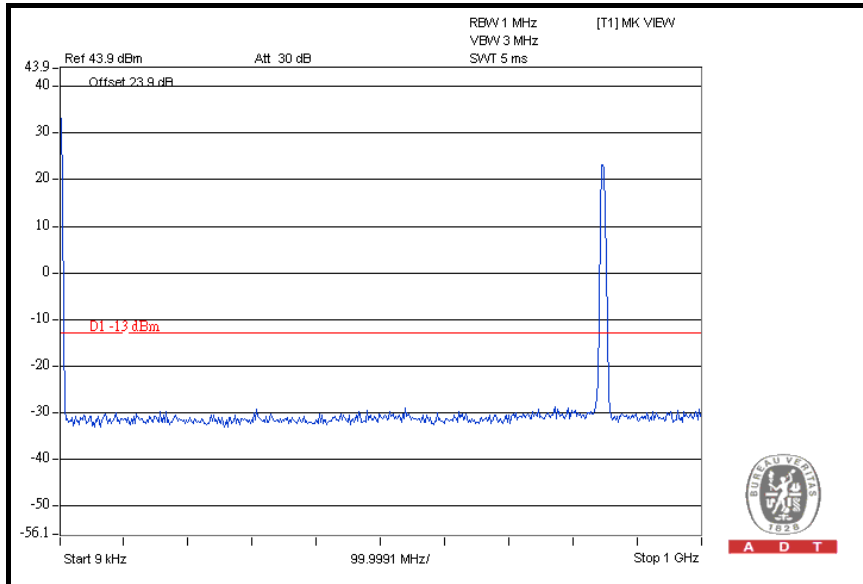

1GHz ~ 4GHz

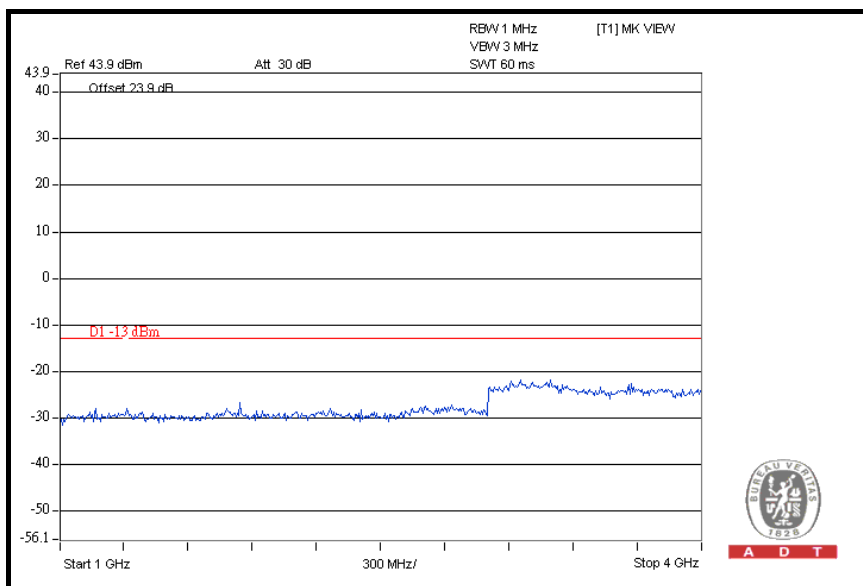



A D T

4GHz ~ 7GHz

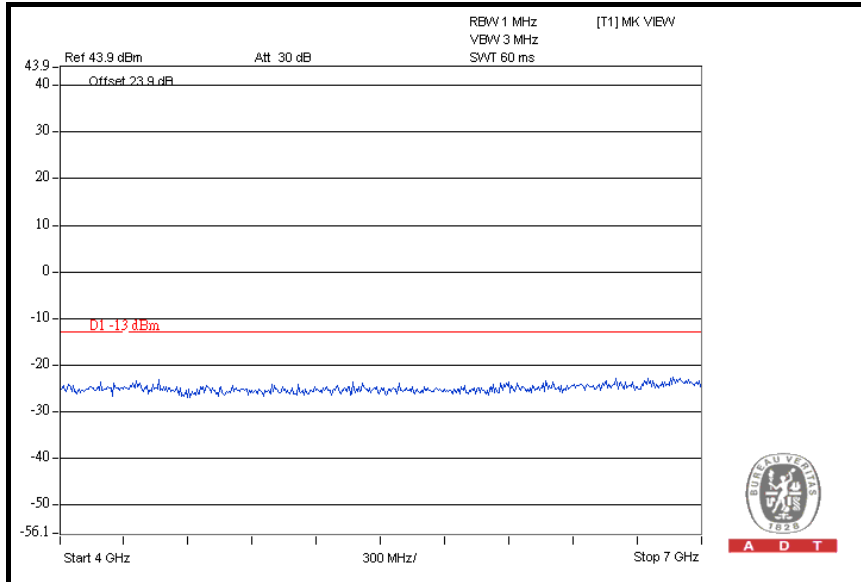

7GHz ~ 9GHz

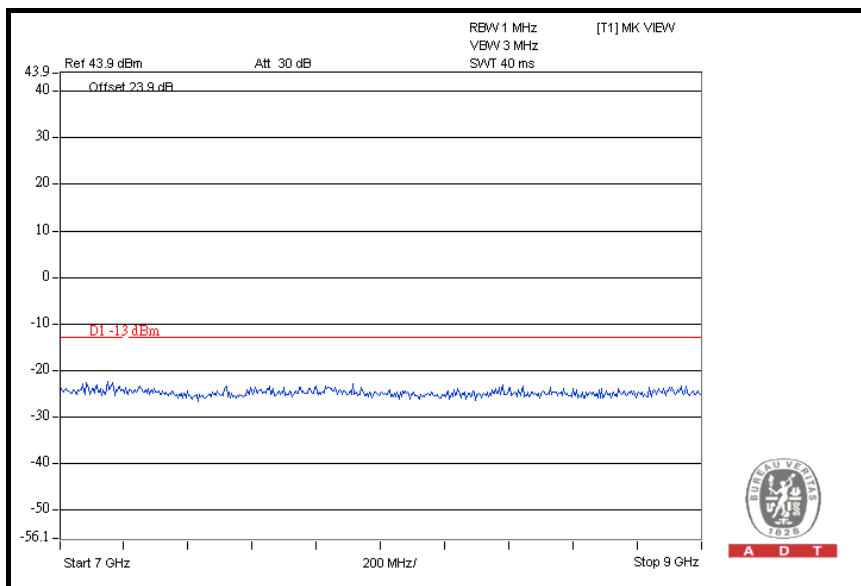



4.6 RADIATED EMISSION MEASUREMENT (BELOW 1GHz)

4.6.1 LIMITS OF RADIATED EMISSION MEASUREMENT

In the FCC 24.238(a), On any frequency outside a licensee's frequency block within USPCS spectrum, the power of any emission shall be attenuated below the transmitter power (P) by at least $43 + 10 \log (P)$ dB. The emission limit equal to -13 dBm. So the limit of emission is the same absolute specified line.

LIMIT (dBm)	EQUIVALENT FIELD STRENGTH AT 3m (dBuV/m) (NOTE)
-13	82.2

NOTE: The following formula is used to convert the equipment radiated power to field strength.

$$E = [1000000\sqrt{(30P)}] / 3 \text{ uV/m, where P is Watts.}$$

4.6.2 TEST INSTRUMENTS

Same as 4.1.2.

4.6.3 TEST PROCEDURES

- a. The EUT was placed on the top of a rotating table 0.8 meters above the ground at a 3 meters semi-anechoic chamber. The table was rotated 360 degrees to determine the position of the highest radiation.
- b. The EUT was set 3 meters away from the interference-receiving antenna, which was mounted on the top of a variable-height antenna tower.
- c. The antenna is a broadband antenna, and its height is varied from one meter to four meters above the ground to determine the maximum value of the field strength. Both horizontal and vertical polarizations of the antenna are set to make the measurement.
- d. For each suspected emission, the EUT was arranged to its worst case and then the antenna was tuned to heights from 1 meter to 4 meters and the rotatable table was turned from 0 degrees to 360 degrees to find the maximum reading.
- e. The test-receiver system was set to Peak Detect Function and Specified Bandwidth with Maximum Hold Mode.
- f. If the emission level of the EUT in peak mode was lower than the limit specified, then testing could be stopped and the peak values of the EUT would be reported. Otherwise the emissions would be re-tested one by one using peak, quasi-peak or average method as specified and then reported in a data sheet.

NOTE: The resolution bandwidth of spectrum analyzer is 1 MHz and the video bandwidth is 3 MHz.

4.6.4 DEVIATION FROM TEST STANDARD

No deviation

4.6.5 TEST SETUP

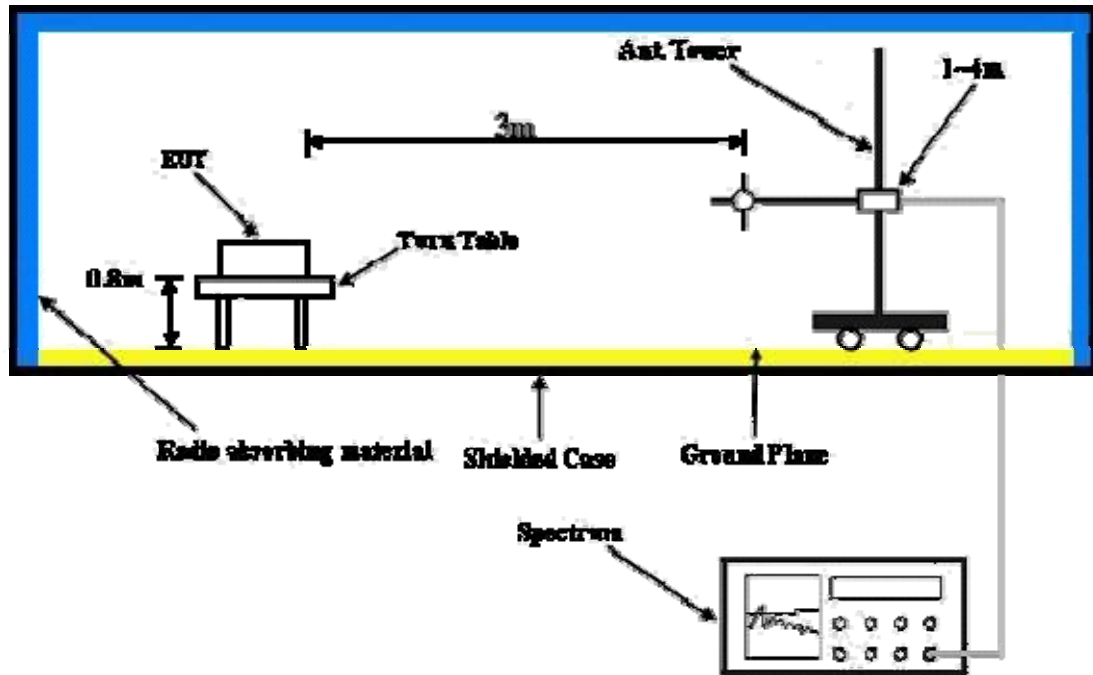

For the actual test configuration, please refer to the attached file (Test Setup Photo).

4.6.6 EUT OPERATING CONDITIONS

- a. The EUT makes a call to the communication simulator.
- b. The communication simulator station system controlled an EUT to export maximum output power under transmission mode and specific channel frequency.

4.6.7 TEST RESULTS

FOR GPRS:

MODE	TX channel 251	FREQUENCY RANGE	Below 1000 MHz
ENVIRONMENTAL CONDITIONS	20deg. C, 60%RH, 991hPa	INPUT POWER	120Vac, 60 Hz
TESTED BY	Kevin Liang		

ANTENNA POLARITY & TEST DISTANCE: HORIZONTAL AT 3 M								
No.	Freq. (MHz)	Emission Level (dBuV/m)	Limit (dBuV/m)	Margin (dB)	Antenna Height (m)	Table Angle (Degree)	Raw Value (dBuV)	Correction Factor (dB/m)
1	57.21	55.1	82.2	-27.2	4.00 H	343	41.6	13.5
2	358.52	53.2	82.2	-29.1	1.25 H	10	37.1	16.1
3	455.71	48.6	82.2	-33.7	2.00 H	199	29.9	18.7
4	630.66	47.7	82.2	-34.6	1.25 H	193	25.2	22.5
5	799.78	62.2	82.2	-20.1	1.00 H	10	37.6	24.6
6	889.20	53.2	82.2	-29.1	3.00 H	25	27.4	25.8
ANTENNA POLARITY & TEST DISTANCE: VERTICAL AT 3 M								
No.	Freq. (MHz)	Emission Level (dBuV/m)	Limit (dBuV/m)	Margin (dB)	Antenna Height (m)	Table Angle (Degree)	Raw Value (dBuV)	Correction Factor (dB/m)
1	57.21	65.3	82.2	-17.0	1.00 V	7	51.8	13.5
2	177.74	51.9	82.2	-30.4	1.25 V	280	39.4	12.5
3	335.19	48.5	82.2	-33.8	1.50 V	136	32.9	15.6
4	457.66	53.1	82.2	-29.2	1.50 V	259	34.4	18.7
5	628.72	46.7	82.2	-35.6	1.00 V	169	24.2	22.5
6	799.78	59.4	82.2	-22.9	2.00 V	241	34.8	24.6

NOTE:

1. Emission level (dBuV/m) = Raw Value (dBuV) + Correction Factor (dB).
2. Correction Factor (dB/m) = Antenna Factor (dB/m) + Cable Factor (dB).
3. The other emission levels were very low against the limit.
4. Margin value = Emission level – Limit value.
5. This is valid for all 3 channels.



FOR CDMA:

MODE	TX channel 777	FREQUENCY RANGE	Below 1000MHz
ENVIRONMENTAL CONDITIONS	20deg. C, 60%RH, 991hPa	INPUT POWER	120Vac, 60 Hz
TESTED BY	Kevin Liang		

ANTENNA POLARITY & TEST DISTANCE: HORIZONTAL AT 3 M								
NO.	FREQ. (MHz)	EMISSION LEVEL (dBuV/m)	LIMIT (dBuV/m)	MARGIN (dB)	ANTENNA HEIGHT (m)	TABLE ANGLE (Degree)	RAW VALUE (dBuV)	CORRECTION FACTOR (dB/m)
1	59.16	58.2	82.2	-24.1	4.00 H	235	45.0	13.2
2	317.70	52.2	82.2	-30.1	3.00 H	19	37.1	15.1
3	455.71	52.1	82.2	-30.2	1.50 H	295	33.4	18.7
4	630.66	47.9	82.2	-34.4	1.25 H	196	25.4	22.5
5	799.78	61.4	82.2	-20.9	1.00 H	10	36.8	24.6
6	898.92	50.8	82.2	-31.5	2.00 H	346	24.9	25.9

ANTENNA POLARITY & TEST DISTANCE: VERTICAL AT 3 M								
NO.	FREQ. (MHz)	EMISSION LEVEL (dBuV/m)	LIMIT (dBuV/m)	MARGIN (dB)	ANTENNA HEIGHT (m)	TABLE ANGLE (Degree)	RAW VALUE (dBuV)	CORRECTION FACTOR (dB/m)
1	61.10	67.8	82.2	-14.5	1.00 V	244	54.8	13.0
2	451.82	57.3	82.2	-25.0	1.25 V	31	38.7	18.6
3	628.72	46.5	82.2	-35.8	1.00 V	166	24.0	22.5
4	797.84	55.4	82.2	-26.9	2.00 V	262	30.8	24.6
5	898.92	51.6	82.2	-30.7	1.25 V	346	25.7	25.9
6	930.02	52.6	82.2	-29.7	1.00 V	346	26.2	26.4

NOTE:

1. Emission level (dBuV/m) = Raw Value (dBuV) + Correction Factor (dB).
2. Correction Factor (dB/m) = Antenna Factor (dB/m) + Cable Factor (dB).
3. The other emission levels were very low against the limit.
4. Margin value = Emission level – Limit value.
5. This is valid for all 3 channels.

FOR WCDMA:

MODE	TX channel 4233	FREQUENCY RANGE	Below 1000 MHz
ENVIRONMENTAL CONDITIONS	20deg. C, 60%RH, 991hPa	INPUT POWER	120Vac, 60 Hz
TESTED BY	Kevin Liang		

ANTENNA POLARITY & TEST DISTANCE: HORIZONTAL AT 3 M								
No.	Freq. (MHz)	Emission Level (dBuV/m)	Limit (dBuV/m)	Margin (dB)	Antenna Height (m)	Table Angle (Degree)	Raw Value (dBuV)	Correction Factor (dB/m)
1	61.10	56.4	82.2	-25.9	3.00 H	238	43.4	13.0
2	134.97	53.4	82.2	-28.9	1.25 H	262	39.8	13.6
3	358.52	52.6	82.2	-29.7	1.25 H	10	36.5	16.1
4	453.77	56.0	82.2	-26.3	2.00 H	202	37.4	18.6
5	630.66	46.9	82.2	-35.4	1.25 H	199	24.4	22.5
6	797.84	59.9	82.2	-22.4	1.00 H	10	35.3	24.6
ANTENNA POLARITY & TEST DISTANCE: VERTICAL AT 3 M								
No.	Freq. (MHz)	Emission Level (dBuV/m)	Limit (dBuV/m)	Margin (dB)	Antenna Height (m)	Table Angle (Degree)	Raw Value (dBuV)	Correction Factor (dB/m)
1	63.05	66.4	82.2	-15.9	1.50 V	253	53.6	12.8
2	354.63	49.3	82.2	-33.0	1.25 V	316	33.3	16.0
3	457.66	56.6	82.2	-25.7	1.25 V	250	37.9	18.7
4	630.66	46.3	82.2	-36.0	1.00 V	175	23.8	22.5
5	799.78	55.0	82.2	-27.3	1.00 V	241	30.4	24.6
6	900.86	51.2	82.2	-31.1	1.00 V	334	25.3	25.9

NOTE:

1. Emission level (dBuV/m) = Raw Value (dBuV) + Correction Factor (dB).
2. Correction Factor (dB/m) = Antenna Factor (dB/m) + Cable Factor (dB).
3. The other emission levels were very low against the limit.
4. Margin value = Emission level – Limit value.
5. This is valid for all 3 channels.



4.7 RADIATED EMISSION MEASUREMENT (ABOVE 1GHz)

4.7.1 LIMITS OF RADIATED EMISSION MEASUREMENT

In the FCC 22.917 (a), On any frequency outside a licensee's frequency block within GPRS spectrum, the power of any emission shall be attenuated below the transmitter power (P) by at least $43 + 10 \log (P)$ dB. The emission limit equal to -13dBm .

4.7.2 TEST INSTRUMENTS

Same as 4.1.2.

4.7.3 TEST PROCEDURES

- a. Substitution method is used for E.I.R.P measurement. In the semi-anechoic chamber, EUT placed on the 0.8m height of Turn Table, rotated the table around 360 degrees to search the maximum radiation power and receiver antenna shall be rotated vertical and horizontal polarization and moved height from 1m to 4m to find the maximum polar radiated power. The “ Read Value ” is the spectrum reading the maximum power value.
- b. The substitution horn antenna is substituted for EUT at the same position and signals generator export the CW signal to the substitution antenna via a TX cable. Rotated the Turn Table and moved receiving antenna to find the maximum radiation power. Adjust output power level of S.G to get a Value of spectrum reading equal to “ Read Value “ of step a. Record the power level of S.G
- c. $EIRP = \text{Output power level of S.G} - \text{TX cable loss} + \text{Antenna gain of substitution horn.}$
- d. E.R.P power can be calculated form E.I.R.P power by subtracting the gain of dipole, $E.R.P \text{ power} = E.I.P.R \text{ power} - 2.15\text{dBi.}$

NOTE: The resolution bandwidth and video bandwidth of test receiver/spectrum analyzer is 1MHz/3MHz.

4.7.4 DEVIATION FROM TEST STANDARD

No deviation

4.7.5 TEST SETUP

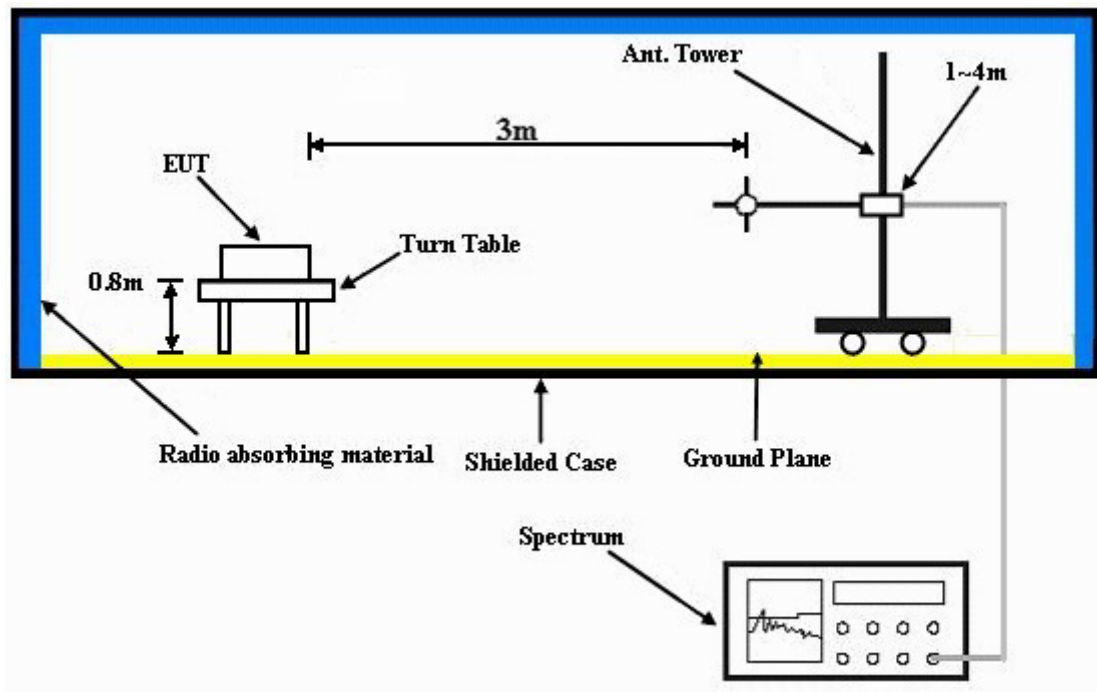

For the actual test configuration, please refer to the attached file (Test Setup Photo).

4.7.6 EUT OPERATING CONDITIONS

- The EUT makes a call to the communication simulator.
- The communication simulator station system controlled an EUT to export maximum output power under transmission mode and specific channel frequency.



4.7.7 TEST RESULTS

FOR GPRS BAND:

MODE	TX channel 128	FREQUENCY RANGE	Above 1000 MHz
INPUT POWER	120Vac, 60 Hz	ENVIRONMENTAL CONDITIONS	23deg. C, 63%RH, 991hPa
TESTED BY	Mark Liao		

ANTENNA POLARITY & TEST DISTANCE: HORIZONTAL AT 3 M						
No.	Freq. (MHz)	Emission Level (dBuV)	Limit (dBm)	S.G Power Value (dBm)	Correction Factor (dB)	Power Value (dBm)
1	1648.4	54.6	-13.0	-47.5	7.6	-39.9
2	2472.6	67.1	-13.0	-35.8	8.4	-27.4
3	3296.8	52.1	-13.0	-52.6	9.9	-42.7
ANTENNA POLARITY & TEST DISTANCE: VERTICAL AT 3 M						
No.	Freq. (MHz)	Emission Level (dBuV)	Limit (dBm)	S.G Power Value (dBm)	Correction Factor (dB)	Power Value (dBm)
1	1648.4	55.0	-13.0	-47.3	7.6	-39.7
2	2472.6	61.8	-13.0	-41.0	8.4	-32.6
3	3296.8	53.4	-13.0	-50.7	9.9	-40.8

NOTE: Power Value (dBum) = S.G Power Value (dBm) + Correction Factor (dB).



MODE	TX channel 190	FREQUENCY RANGE	Above 1000 MHz
INPUT POWER	120Vac, 60 Hz	ENVIRONMENTAL CONDITIONS	23deg. C, 63%RH, 991hPa
TESTED BY	Mark Liao		

ANTENNA POLARITY & TEST DISTANCE: HORIZONTAL AT 3 M						
No.	Freq. (MHz)	Emission Level (dBuV)	Limit (dBm)	S.G Power Value (dBm)	Correction Factor (dB)	Power Value (dBm)
1	1673.2	60.3	-13.0	-42.2	7.7	-34.5
2	2509.8	68.8	-13.0	-34.3	8.4	-25.9
3	3346.4	48.7	-13.0	-56.0	9.9	-46.1
ANTENNA POLARITY & TEST DISTANCE: VERTICAL AT 3 M						
No.	Freq. (MHz)	Emission Level (dBuV)	Limit (dBm)	S.G Power Value (dBm)	Correction Factor (dB)	Power Value (dBm)
1	1673.2	56.9	-13.0	-45.0	7.7	-37.3
2	2509.8	62.8	-13.0	-40.2	8.4	-31.8
3	3346.4	50.7	-13.0	-53.6	9.9	-43.7

NOTE: Power Value (dBum) = S.G Power Value (dBm) + Correction Factor (dB).



A D T

MODE	TX channel 251	FREQUENCY RANGE	Above 1000 MHz
INPUT POWER	120Vac, 60 Hz	ENVIRONMENTAL CONDITIONS	23deg. C, 63%RH, 991hPa
TESTED BY	Mark Liao		

ANTENNA POLARITY & TEST DISTANCE: HORIZONTAL AT 3 M						
No.	Freq. (MHz)	Emission Level (dBuV)	Limit (dBm)	S.G Power Value (dBm)	Correction Factor (dB)	Power Value (dBm)
1	1697.6	54.7	-13.0	-48.2	7.9	-40.3
2	2546.4	67.0	-13.0	-36.4	8.5	-27.9
3	3395.2	50.8	-13.0	-54.0	9.9	-44.1
ANTENNA POLARITY & TEST DISTANCE: VERTICAL AT 3 M						
No.	Freq. (MHz)	Emission Level (dBuV)	Limit (dBm)	S.G Power Value (dBm)	Correction Factor (dB)	Power Value (dBm)
1	1697.6	57.8	-13.0	-44.4	7.9	-36.5
2	2546.4	61.8	-13.0	-41.2	8.5	-32.7
3	3395.2	52.0	-13.0	-52.3	9.9	-42.4

NOTE: Power Value (dBum) = S.G Power Value (dBm) + Correction Factor (dB).



FOR CDMA BAND:

MODE	Channel 1013	FREQUENCY RANGE	Above 1000MHz
INPUT POWER	120Vac, 60 Hz	ENVIRONMENTAL CONDITIONS	23deg. C, 63%RH, 991hPa
TESTED BY	Mark Liao		

ANTENNA POLARITY & TEST DISTANCE: HORIZONTAL AT 3 m

NO.	FREQ. (MHz)	EMISSION LEVEL (dBuV)	LIMIT (dBm)	S.G POWER VALUE (dBm)	CORRECTION FACTOR (dB)	POWER VALUE (dBm)
1	1649.4	44.7	-13.0	-57.3	7.6	-49.7
2	2474.1	44.3	-13.0	-58.2	8.4	-49.8
3	3298.8	48.0	-13.0	-55.9	9.9	-46.0

ANTENNA POLARITY & TEST DISTANCE: VERTICAL AT 3 m

NO.	FREQ. (MHz)	EMISSION LEVEL (dBuV)	LIMIT (dBm)	S.G POWER VALUE (dBm)	CORRECTION FACTOR (dB)	POWER VALUE (dBm)
1	1649.4	45.8	-13.0	-56.5	7.6	-48.9
2	2474.1	42.8	-13.0	-60.8	8.4	-52.4
3	3298.8	49.1	-13.0	-55.7	9.9	-45.8

NOTE: Power Value (dBum) = S.G Power Value (dBm) + Correction Factor (dB).



MODE	Channel 384	FREQUENCY RANGE	Above 1000MHz
INPUT POWER	120Vac, 60 Hz	ENVIRONMENTAL CONDITIONS	23deg. C, 63%RH, 991hPa
TESTED BY	Mark Liao		

ANTENNA POLARITY & TEST DISTANCE: HORIZONTAL AT 3 m						
NO.	FREQ. (MHz)	EMISSION LEVEL (dBuV)	LIMIT (dBm)	S.G POWER VALUE (dBm)	CORRECTION FACTOR (dB)	POWER VALUE (dBm)
1	1673.04	44.1	-13.0	-57.5	7.7	-49.8
2	2509.56	43.8	-13.0	-58.8	8.4	-50.4
3	3346.08	48.7	-13.0	-56.1	9.9	-46.2
ANTENNA POLARITY & TEST DISTANCE: VERTICAL AT 3 m						
NO.	FREQ. (MHz)	EMISSION LEVEL (dBuV)	LIMIT (dBm)	S.G POWER VALUE (dBm)	CORRECTION FACTOR (dB)	POWER VALUE (dBm)
1	1673.04	47.7	-13.0	-55.1	7.7	-47.4
2	2509.56	42.1	-13.0	-60.6	8.4	-52.2
3	3346.08	48.1	-13.0	-56.8	9.9	-46.9

NOTE: Power Value (dBum) = S.G Power Value (dBm) + Correction Factor (dB).



MODE	Channel 777	FREQUENCY RANGE	Above 1000MHz
INPUT POWER	120Vac, 60 Hz	ENVIRONMENTAL CONDITIONS	23deg. C, 63%RH, 991hPa
TESTED BY	Mark Liao		

ANTENNA POLARITY & TEST DISTANCE: HORIZONTAL AT 3 m						
NO.	FREQ. (MHz)	EMISSION LEVEL (dBuV)	LIMIT (dBm)	S.G POWER VALUE (dBm)	CORRECTION FACTOR (dB)	POWER VALUE (dBm)
1	1696.62	48.8	-13.0	-53.4	7.9	-45.5
2	2544.93	42.6	-13.0	-60.6	8.5	-52.1
3	3393.24	48.5	-13.0	-56.2	9.9	-46.3
ANTENNA POLARITY & TEST DISTANCE: VERTICAL AT 3 m						
NO.	FREQ. (MHz)	EMISSION LEVEL (dBuV)	LIMIT (dBm)	S.G POWER VALUE (dBm)	CORRECTION FACTOR (dB)	POWER VALUE (dBm)
1	1696.62	49.5	-13.0	-52.8	7.9	-44.9
2	2544.93	41.3	-13.0	-61.9	8.5	-53.4
3	3393.24	48.4	-13.0	-55.7	9.9	-45.8

NOTE: Power Value (dBum) = S.G Power Value (dBm) + Correction Factor (dB).



FOR WCDMA BAND:

MODE	TX channel 4132	FREQUENCY RANGE	Above 1000 MHz
INPUT POWER	120Vac, 60 Hz	ENVIRONMENTAL CONDITIONS	23deg. C, 63%RH, 991hPa
TESTED BY	Mark Liao		

ANTENNA POLARITY & TEST DISTANCE: HORIZONTAL AT 3 M						
No.	Freq. (MHz)	Emission Level (dBuV)	Limit (dBm)	S.G Power Value (dBm)	Correction Factor (dB)	Power Value (dBm)
1	1652.8	42.2	-13.0	-60.3	7.6	-52.7
2	2479.2	39.8	-13.0	-62.7	8.4	-54.3
3	3305.6	46.8	-13.0	-57.5	9.9	-47.6
ANTENNA POLARITY & TEST DISTANCE: VERTICAL AT 3 M						
No.	Freq. (MHz)	Emission Level (dBuV)	Limit (dBm)	S.G Power Value (dBm)	Correction Factor (dB)	Power Value (dBm)
1	1652.8	44.8	-13.0	-57.2	7.6	-49.6
2	2479.2	40.8	-13.0	-61.9	8.4	-53.5
3	3305.6	46.6	-13.0	-57.3	9.9	-47.4

NOTE: Power Value (dBum) = S.G Power Value (dBm) + Correction Factor (dB).



MODE	TX channel 4182	FREQUENCY RANGE	Above 1000 MHz
INPUT POWER	120Vac, 60 Hz	ENVIRONMENTAL CONDITIONS	23deg. C, 63%RH, 991hPa
TESTED BY	Mark Liao		

ANTENNA POLARITY & TEST DISTANCE: HORIZONTAL AT 3 M						
No.	Freq. (MHz)	Emission Level (dBUV)	Limit (dBm)	S.G Power Value (dBm)	Correction Factor (dB)	Power Value (dBm)
1	1672.8	44.3	-13.0	-58.1	7.7	-50.4
2	2509.2	40.3	-13.0	-63.2	8.4	-54.8
3	3345.6	46.0	-13.0	-58.3	9.9	-48.4
ANTENNA POLARITY & TEST DISTANCE: VERTICAL AT 3 M						
No.	Freq. (MHz)	Emission Level (dBUV)	Limit (dBm)	S.G Power Value (dBm)	Correction Factor (dB)	Power Value (dBm)
1	1672.8	45.3	-13.0	-56.9	7.7	-49.2
2	2509.2	39.6	-13.0	-63.4	8.4	-55.0
3	3345.6	46.1	-13.0	-58.6	9.9	-48.7

NOTE: Power Value (dBum) = S.G Power Value (dBm) + Correction Factor (dB).



MODE	TX channel 4233	FREQUENCY RANGE	Above 1000 MHz
INPUT POWER	120Vac, 60 Hz	ENVIRONMENTAL CONDITIONS	23deg. C, 63%RH, 991hPa
TESTED BY	Mark Liao		

ANTENNA POLARITY & TEST DISTANCE: HORIZONTAL AT 3 M						
No.	Freq. (MHz)	Emission Level (dBuV)	Limit (dBm)	S.G Power Value (dBm)	Correction Factor (dB)	Power Value (dBm)
1	1693.2	42.5	-13.0	-59.7	7.9	-51.8
2	2539.8	40.2	-13.0	-62.6	8.5	-54.1
3	3386.4	46.5	-13.0	-58.1	9.9	-48.2
ANTENNA POLARITY & TEST DISTANCE: VERTICAL AT 3 M						
No.	Freq. (MHz)	Emission Level (dBuV)	Limit (dBm)	S.G Power Value (dBm)	Correction Factor (dB)	Power Value (dBm)
1	1693.2	45.0	-13.0	-57.9	7.9	-50.0
2	2539.8	41.2	-13.0	-61.5	8.5	-53.0
3	3386.4	46.8	-13.0	-57.6	9.9	-47.7

NOTE: Power Value (dBum) = S.G Power Value (dBm) + Correction Factor (dB).



5 PHOTOGRAPHS OF THE TEST CONFIGURATION

Please refer to the attached file (Test Setup Photo).



6 INFORMATION ON THE TESTING LABORATORIES

We, Bureau Veritas Consumer Products Services (H.K.) Ltd., Taoyuan Branch, were founded in 1988 to provide our best service in EMC, Radio, Telecom and Safety consultation. Our laboratories are accredited and approved according to ISO/IEC 17025.

Copies of accreditation and authorization certificates of our laboratories obtained from approval agencies can be downloaded from our web site:

www.adt.com.tw/index.5/phtml. If you have any comments, please feel free to contact us at the following:

Linko EMC/RF Lab:

Tel: 886-2-26052180

Fax: 886-2-26051924

Hsin Chu EMC/RF Lab:

Tel: 886-3-5935343

Fax: 886-3-5935342

Hwa Ya EMC/RF/Safety/Telecom Lab:

Tel: 886-3-3183232

Fax: 886-3-3185050

Web Site: www.adt.com.tw

The address and road map of all our labs can be found in our web site also.



7 APPENDIX A – MODIFICATIONS RECORDERS FOR ENGINEERING CHANGES TO THE EUT BY THE LAB

No any modifications are made to the EUT by the lab during the test.

---END---