



FCC TEST REPORT

Report No.: RF990819C03-1

MODEL NO.: Algiz7;Algiz7-XXX (X=A~Z , a~z , 0 ~9 , Blank or Slash)
(refer to item 3.1 for more detail)

FCC ID: YY3-01120709267

RECEIVED: Aug. 19, 2010

TESTED: Sep. 07 ~ Oct. 15, 2010

ISSUED: Feb. 08, 2011

APPLICANT: HHCS HANDHELD COMPUTER
SPECIALISTS AB

ADDRESS: Kinnegatan 17 A,S-531 33 Lidkoping,Sweden

ISSUED BY: Bureau Veritas Consumer Products Services
(H.K.) Ltd., Taoyuan Branch

LAB ADDRESS: No. 47, 14th Ling, Chia Pau Tsuen, Lin Kou
Hsiang, Taipei Hsien 244, Taiwan, R.O.C.

TEST LOCATION: No. 19, Hwa Ya 2nd Rd, Wen Hwa Tsuen,
Kwei Shan Hsiang, Taoyuan Hsien 333,
Taiwan, R.O.C.

This test report consists of 59 pages in total. It may be duplicated completely for legal use with the approval of the applicant. It should not be reproduced except in full, without the written approval of our laboratory. The client should not use it to claim product, certification, approval or endorsement by TAF, or any government agency. The test results in the report only apply to the tested sample.





Table of Contents

RELEASE CONTROL RECORD.....	4
1. CERTIFICATION.....	5
2. SUMMARY OF TEST RESULTS	6
2.1 MEASUREMENT UNCERTAINTY	6
3. GENERAL INFORMATION.....	7
3.1 GENERAL DESCRIPTION OF EUT.....	7
3.2 DESCRIPTION OF TEST MODES.....	8
3.2.1 CONFIGURATION OF SYSTEM UNDER TEST	8
3.2.2 TEST MODE APPLICABILITY AND TESTED CHANNEL DETAIL.....	9
3.3 GENERAL DESCRIPTION OF APPLIED STANDARDS	11
3.4 DESCRIPTION OF SUPPORT UNITS	11
4. TEST TYPES AND RESULTS	12
4.1 RADIATED EMISSION MEASUREMENT	12
4.1.1 LIMITS OF RADIATED EMISSION MEASUREMENT.....	12
4.1.2 TEST INSTRUMENTS	13
4.1.3 TEST PROCEDURES	14
4.1.4 DEVIATION FROM TEST STANDARD	14
4.1.5 TEST SETUP	15
4.1.6 EUT OPERATING CONDITIONS.....	15
4.1.7 TEST RESULTS	16
4.2 CONDUCTED EMISSION MEASUREMENT	23
4.2.1 LIMITS OF CONDUCTED EMISSION MEASUREMENT.....	23
4.2.2 TEST INSTRUMENTS	23
4.2.3 TEST PROCEDURES	24
4.2.4 DEVIATION FROM TEST STANDARD	24
4.2.5 TEST SETUP	25
4.2.6 EUT OPERATING CONDITIONS.....	25
4.2.7 TEST RESULTS	26
4.3 NUMBER OF HOPPING FREQUENCY USED.....	28
4.3.1 LIMIT OF HOPPING FREQUENCY USED	28
4.3.2 TEST INSTRUMENTS	28
4.3.3 TEST PROCEDURES	28
4.3.4 DEVIATION FROM TEST STANDARD	29
4.3.5 TEST SETUP	29
4.3.6 TEST RESULTS	29
4.4 DWELL TIME ON EACH CHANNEL	32
4.4.1 LIMIT OF DWELL TIME USED.....	32
4.4.2 TEST INSTRUMENTS	32
4.4.3 TEST PROCEDURES	32
4.4.4 DEVIATION FROM TEST STANDARD	32
4.4.5 TEST SETUP	33
4.4.6 TEST RESULTS	33
4.5 CHANNEL BANDWIDTH.....	41
4.5.1 LIMITS OF CHANNEL BANDWIDTH	41
4.5.2 TEST INSTRUMENTS	41
4.5.3 TEST PROCEDURE	41



A D T

4.5.4	DEVIATION FROM TEST STANDARD	41
4.5.5	TEST SETUP	41
4.5.6	EUT OPERATING CONDITION	42
4.5.7	TEST RESULTS	42
4.6	HOPPING CHANNEL SEPARATION	44
4.6.1	LIMIT OF HOPPING CHANNEL SEPARATION	44
4.6.2	TEST INSTRUMENTS	44
4.6.3	TEST PROCEDURES	44
4.6.4	DEVIATION FROM TEST STANDARD	44
4.6.5	TEST SETUP	44
4.6.6	TEST RESULTS	45
4.7	MAXIMUM OUTPUT POWER.....	47
4.7.1	LIMITS OF MAXIMUM OUTPUT POWER MEASUREMENT	47
4.7.2	TEST INSTRUMENTS	47
4.7.3	TEST PROCEDURES	47
4.7.4	DEVIATION FROM TEST STANDARD	47
4.7.5	TEST SETUP	47
4.7.6	EUT OPERATING CONDITION	48
4.7.7	TEST RESULTS	48
4.8	BAND EDGES MEASUREMENT	50
4.8.1	LIMITS OF BAND EDGES MEASUREMENT	50
4.8.2	TEST INSTRUMENTS	50
4.8.3	TEST PROCEDURE	50
4.8.4	DEVIATION FROM TEST STANDARD	50
4.8.5	EUT OPERATING CONDITION	50
4.8.6	TEST RESULTS	51
5.	PHOTOGRAPHS OF THE TEST CONFIGURATION.....	57
6.	INFORMATION ON THE TESTING LABORATORIES	58
7.	APPENDIX A - MODIFICATIONS RECORDERS FOR ENGINEERING CHANGES TO THE EUT BY THE LAB	59



RELEASE CONTROL RECORD

ISSUE NO.	REASON FOR CHANGE	DATE ISSUED
Original release	N/A	Feb. 08, 2011



1. CERTIFICATION

PRODUCT: 7 Rugged Tablet PC

MODEL: Algiz7;Algiz7-XXX (X=A~Z , a~z , 0 ~9 , Blank or Slash)
(refer to item 3.1 for more detail)

BRAND: Handheld

APPLICANT: HHCS HANDHELD COMPUTER SPECIALISTS AB

TESTED: Sep. 07 ~ Oct. 15, 2010

TEST SAMPLE: ENGINEERING SAMPLE

STANDARDS: FCC Part 15, Subpart C (Section 15.247),

ANSI C63.4-2003

ANSI C63.10-2009

The above equipment (Model: Algiz7) has been tested by **Bureau Veritas Consumer Products Services (H.K.) Ltd., Taoyuan Branch**, and found compliance with the requirement of the above standards. The test record, data evaluation & Equipment Under Test (EUT) configurations represented herein are true and accurate accounts of the measurements of the sample's EMC characteristics under the conditions specified in this report.

PREPARED BY :  , DATE : Feb. 08, 2011
Andrea Hsia / Specialist

APPROVED BY :  , DATE : Feb. 08, 2011
Gary Chang / Assistant Manager

2. SUMMARY OF TEST RESULTS

The EUT has been tested according to the following specifications:

APPLIED STANDARD: FCC Part 15, Subpart C			
STANDARD SECTION	TEST TYPE AND LIMIT	RESULT	REMARK
15.207	AC Power Conducted Emission	PASS	Meet the requirement of limit. Minimum passing margin is -14.55dB at 0.177MHz.
15.247(a)(1)(iii)	Number of Hopping Frequency Used Spec.: At least 15 channels	PASS	Meet the requirement of limit.
15.247(a)(1)(iii)	Dwell Time on Each Channel Spec.: Max. 0.4 second within 31.6 second	PASS	Meet the requirement of limit.
15.247(a)(1)	1. Hopping Channel Separation Spec. : Min. 25 kHz or $\frac{2}{3}$ *20 dB bandwidth, whichever is greater 2. Spectrum Bandwidth of a Frequency Hopping Sequence Spread Spectrum System	PASS	Meet the requirement of limit.
15.247(b)	Maximum Output Power Spec.: max. 21dBm	PASS	Meet the requirement of limit.
15.247(d)	Transmitter Radiated Emissions Spec.: Table 15.209	PASS	Meet the requirement of limit. Minimum passing margin is -1.8dB at 932.05MHz.
15.247(d)	Band Edge Measurement	PASS	Meet the requirement of limit.
15.203	Antenna Requirement	PASS	No antenna connector is used.

NOTE: If The Frequency Hopping System operating in 2400-2483.5MHz band and the output power less than 125mW. The hopping channel carrier frequencies separated by a minimum of 25kHz or two-thirds of the 20dB bandwidth of hopping channel whichever is greater.

2.1 MEASUREMENT UNCERTAINTY

Where relevant, the following measurement uncertainty levels have been estimated for tests performed on the EUT as specified in CISPR 16-4-2:

MEASUREMENT	FREQUENCY	UNCERTAINTY
Conducted emissions	9kHz~30MHz	2.44 dB
Radiated emissions	30MHz ~ 200MHz	3.34 dB
	200MHz ~1000MHz	3.35 dB
	1GHz ~ 18GHz	2.26 dB
	18GHz ~ 40GHz	1.94 dB

This uncertainty represents an expanded uncertainty expressed at approximately the 95% confidence level using a coverage factor of k=2.



3. GENERAL INFORMATION

3.1 GENERAL DESCRIPTION OF EUT

EUT	7 Rugged Tablet PC
MODEL NO.	Algiz7;Algiz7-XXX (X=A~Z , a~z , 0 ~9 , Blank or Slash)
FCC ID	YY3-01120709267
NOMINAL VOLTAGE	12Vdc (adapter) 7.4Vdc (Battery)
MODULATION TYPE	GFSK, $\pi/4$ -DQPSK, 8DPSK
MODULATION TECHNOLOGY	FHSS
TRANSFER RATE	1/2/3Mbps
FREQUENCY RANGE	2402 ~ 2480MHz
NUMBER OF CHANNEL	79
CHANNEL SPACING	1MHz
OUTPUT POWER	1.3mW
ANTENNA TYPE	Printed PCB antenna with 1.4dBi gain
I/O PORTS	Refer to user's manual
DATA CABLE	NA
ACCESSORY DEVICES	Adapter, Battery

NOTE:

1. The EUT is a 7 Rugged Tablet PC. The test data are separated into following test reports

	TEST STANDARD	REFERENCE REPORT
WLAN 802.11b/g/n	FCC Part 15, Subpart C	RF990819C03
BLUETOOTH	FCC Part 15, Subpart C	RF990819C03-1
GSM/ CDMA/ WCDMA 850	FCC Part 22	RF990819C03-2
GSM/ CDMA/ WCDMA 1900	FCC Part 24	RF990819C03-3

2. The EUT was powered by the following adapter & battery:

ADAPTER	
BRAND:	DVE
MODEL:	DSA-20P-10 US 120180
INPUT:	100-240Vac, 50/60Hz, 0.7A 40VA
OUTPUT:	12Vdc, 1.5A
POWER LINE:	AC: 1.8m non-shielded cable with one core DC: 1.8m shielded cable without core
BATTERY	
RATING:	7.4Vdc 2S1P, 2600mAh

3. The above EUT information was declared by the manufacturer and for more detailed features description, please refer to the manufacturer's specifications or User's Manual.

3.2 DESCRIPTION OF TEST MODES

79 channels are provided to this EUT:

CHANNEL	FREQ. (MHz)	CHANNEL	FREQ. (MHz)	CHANNEL	FREQ. (MHz)	CHANNEL	FREQ. (MHz)
0	2402	20	2422	40	2442	60	2462
1	2403	21	2423	41	2443	61	2463
2	2404	22	2424	42	2444	62	2464
3	2405	23	2425	43	2445	63	2465
4	2406	24	2426	44	2446	64	2466
5	2407	25	2427	45	2447	65	2467
6	2408	26	2428	46	2448	66	2468
7	2409	27	2429	47	2449	67	2469
8	2410	28	2430	48	2450	68	2470
9	2411	29	2431	49	2451	69	2471
10	2412	30	2432	50	2452	70	2472
11	2413	31	2433	51	2453	71	2473
12	2414	32	2434	52	2454	72	2474
13	2415	33	2435	53	2455	73	2475
14	2416	34	2436	54	2456	74	2476
15	2417	35	2437	55	2457	75	2477
16	2418	36	2438	56	2458	76	2478
17	2419	37	2439	57	2459	77	2479
18	2420	38	2440	58	2460	78	2480
19	2421	39	2441	59	2461		

3.2.1 CONFIGURATION OF SYSTEM UNDER TEST

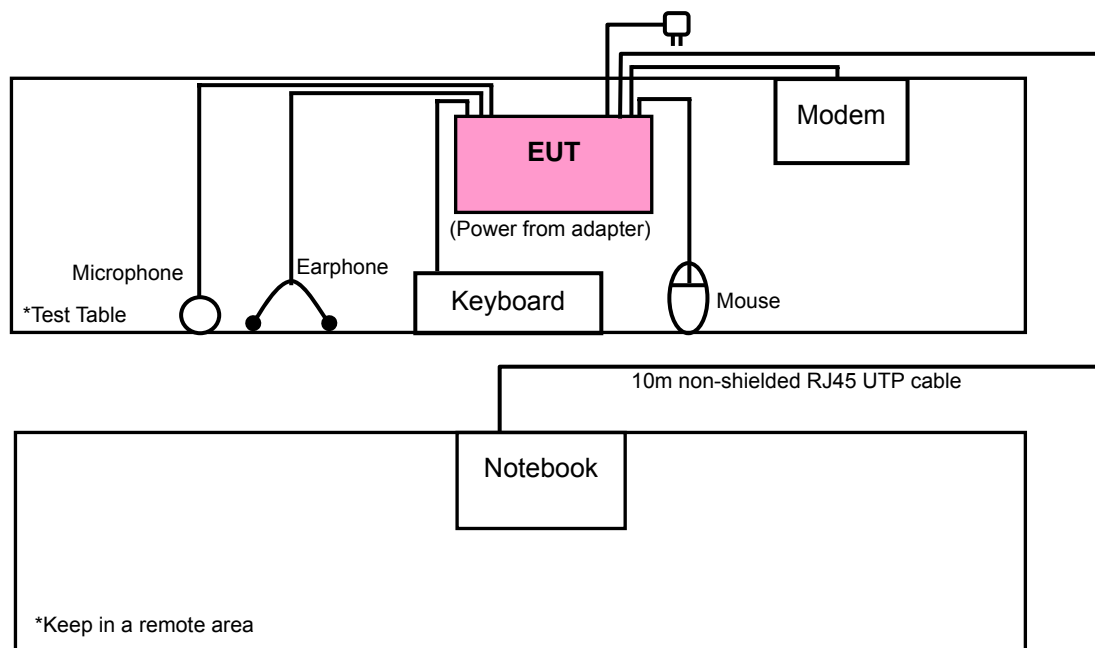



A D T

3.2.2 TEST MODE APPLICABILITY AND TESTED CHANNEL DETAIL

EUT CONFIGURE MODE	APPLICABLE TO				DESCRIPTION
	RE \geq 1G	RE $<$ 1G	PLC	APCM	
-	√	√	√	√	-

Where RE \geq 1G: Radiated Emission above 1GHz
PLC: Power Line Conducted Emission

RE $<$ 1G: Radiated Emission below 1GHz
APCM: Antenna Port Conducted Measurement

RADIATED EMISSION TEST (ABOVE 1 GHz):

- Pre-Scan has been conducted to determine the worst-case mode from all possible combinations between available modulations, XYZ axis, antenna ports (if EUT with antenna diversity architecture) and packet type.
- Following channel(s) was (were) selected for the final test as listed below.

AVAILABLE CHANNEL	TESTED CHANNEL	MODULATION TECHNOLOGY	MODULATION TYPE	PACKET TYPE	AXIS
0 to 78	0, 39, 78	FHSS	GFSK	DH5	Z
0 to 78	0, 39, 78	FHSS	8DPSK	DH5	Z

RADIATED EMISSION TEST (BELOW 1 GHz):

- Pre-Scan has been conducted to determine the worst-case mode from all possible combinations between available modulations, XYZ axis, antenna ports (if EUT with antenna diversity architecture) and packet type.
- Following channel(s) was (were) selected for the final test as listed below.

AVAILABLE CHANNEL	TESTED CHANNEL	MODULATION TECHNOLOGY	MODULATION TYPE	PACKET TYPE	AXIS
0 to 78	0	FHSS	GFSK	DH5	Z

POWER LINE CONDUCTED EMISSION TEST:

- Pre-Scan has been conducted to determine the worst-case mode from all possible combinations between available modulations, data rates and antenna ports (if EUT with antenna diversity architecture).
- Following channel(s) was (were) selected for the final test as listed below.

AVAILABLE CHANNEL	TESTED CHANNEL	MODULATION TECHNOLOGY	MODULATION TYPE	PACKET TYPE
0 to 78	0	FHSS	GFSK	DH5

ANTENNA PORT CONDUCTED MEASUREMENT:

- This item includes all test value of each mode, but only includes spectrum plot of worst value of each mode.
- Pre-Scan has been conducted to determine the worst-case mode from all possible combinations between available modulations, antenna ports (if EUT with antenna diversity architecture), and packet types.
- Following channel(s) was (were) selected for the final test as listed below.

AVAILABLE CHANNEL	TESTED CHANNEL	MODULATION TECHNOLOGY	MODULATION TYPE	PACKET TYPE
0 to 78	0, 39, 78	FHSS	GFSK	DH5
0 to 78	0, 39, 78	FHSS	8DPSK	DH5

TEST CONDITION:

APPLICABLE TO	ENVIRONMENTAL CONDITIONS	INPUT POWER	TESTED BY
RE \geq 1G	26deg. C, 66%RH, 1008 hPa	120Vac, 60Hz	Frank Wang
RE $<$ 1G	25deg. C, 66%RH, 1012 hPa	120Vac, 60Hz	Frank Wang
PLC	25deg. C, 60%RH, 1008 hPa	120Vac, 60Hz	Frank Wang
APCM	25deg. C, 65%RH, 1006 hPa	120Vac, 60Hz	David Huang

3.3 GENERAL DESCRIPTION OF APPLIED STANDARDS

The EUT is a RF Product. According to the specifications of the manufacturer, it must comply with the requirements of the following standards:

FCC Part 15, Subpart C. (15.247)

ANSI C63.4-2003

ANSI C63.10-2009

All test items have been performed and recorded as per the above standards.

NOTE: The EUT is also considered as a kind of computer peripheral, because the connection to computer is necessary for typical use. It has been verified to comply with the requirements of FCC Part 15, Subpart B, Class B (DoC). The test report has been issued separately.

3.4 DESCRIPTION OF SUPPORT UNITS

The EUT has been tested as an independent unit together with other necessary accessories or support units. The following support units or accessories were used to form a representative test configuration during the tests.

NO.	PRODUCT	BRAND	MODEL NO.	SERIAL NO.	FCC ID
1	MOUSE	DELL	MO56U0	513001542	FCC DoC Approved
2	USB KEYBOARD	DELL	SK-8115	MY-0DJ325-7161 9-857-0405	NA
3	MODEM	ACEEX	1414V/3	0401008270	IFAXDM1414
4	EARPHONE	PHILIPS	HL145	N/A	NA
5	MICROPHONE	Labtec	LVA7313	N/A	NA
6	NOTEBOOK	DELL	D820	21498926752	NA

NO.	SIGNAL CABLE DESCRIPTION OF THE ABOVE SUPPORT UNITS
1	1.8m foil shielded wire, USB Connector, w/o core.
2	1.8m foil shielded wire, USB Connector, w/o core.
3	1.2m braid shielded wire, DB25 & DB9 connector, w/o core.
4	1.2m shielded cable
5	1m wrapped shielded wire, terminated via drain wire, with 3.5 mm phone plug, w/o core.
6	10m RJ45 cable

NOTE:

1. All power cords of the above support units are non shielded (1.8m).
2. Items 6 acted as communication partner to transfer data.

4. TEST TYPES AND RESULTS

4.1 RADIATED EMISSION MEASUREMENT

4.1.1 LIMITS OF RADIATED EMISSION MEASUREMENT

Emissions radiated outside of the specified bands, shall be according to the general radiated limits in 15.209 as following:

FREQUENCIES (MHz)	FIELD STRENGTH (microvolts/meter)	MEASUREMENT DISTANCE (meters)
0.009 ~ 0.490	2400/F(kHz)	300
0.490 ~ 1.705	24000/F(kHz)	30
1.705 ~ 30.0	30	30
30 ~ 88	100	3
88 ~ 216	150	3
216 ~ 960	200	3
Above 960	500	3

NOTE:

1. The lower limit shall apply at the transition frequencies.
2. Emission level (dBuV/m) = 20 log Emission level (uV/m).
3. As shown in 15.35(b), for frequencies above 1000MHz, the field strength limits are based on average detector, however, the peak field strength of any emission shall not exceed the maximum permitted average limits, specified above by more than 20dB under any condition of modulation.

4.1.2 TEST INSTRUMENTS

DESCRIPTION & MANUFACTURER	MODEL NO.	SERIAL NO.	DATE OF CALIBRATION	DUE DATE OF CALIBRATION
Test Receiver ROHDE & SCHWARZ	ESIB7	100188	Dec. 21, 2009	Dec. 20, 2010
Spectrum Analyzer ROHDE & SCHWARZ	FSP40	100269	Dec. 31, 2009	Dec. 30, 2010
BILOG Antenna SCHWARZBECK	VULB9168	9168-160	Apr. 27, 2010	Apr. 26, 2011
HORN Antenna SCHWARZBECK	9120D	9120D-405	Feb. 03, 2010	Feb. 02, 2011
HORN Antenna SCHWARZBECK	BBHA 9170	BBHA9170243	Dec. 25, 2009	Dec. 24, 2010
Preamplifier Agilent	8447D	2944A10638	Dec. 21, 2009	Dec. 20, 2010
Preamplifier Agilent	8449B	3008A01964	Nov. 09, 2009	Nov. 08, 2010
RF signal cable HUBER+SUHNNER	SUCOFLEX 104	238141/4	May 14, 2010	May 13, 2011
RF signal cable HUBER+SUHNNER	SUCOFLEX 104	12738/6	May 14, 2010	May 13, 2011
Software ADT.	ADT_Radiated_ V7.6.15.9.2	NA	NA	NA
Antenna Tower inn-co GmbH	MA 4000	013303	NA	NA
Antenna Tower Controller inn-co GmbH	CO2000	017303	NA	NA
Turn Table ADT.	TT100.	TT93021703	NA	NA
Turn Table Controller ADT.	SC100.	SC93021703	NA	NA

- NOTE:**
1. The calibration interval of the above test instruments is 12 months and the calibrations are traceable to NML/ROC and NIST/USA.
 2. The test was performed in HwaYa Chamber 3.
 3. The horn antenna and HP preamplifier (model: 8449B) are used only for the measurement of emission frequency above 1GHz if tested.
 4. The FCC Site Registration No. is 988962.
 5. The IC Site Registration No. is IC 7450F-3.

4.1.3 TEST PROCEDURES

- a. The EUT was placed on the top of a rotating table 0.8 meters above the ground at a 3 meter semi-anechoic chamber. The table was rotated 360 degrees to determine the position of the highest radiation.
- b. The EUT was set 3 meters away from the interference-receiving antenna, which was mounted on the top of a variable-height antenna tower.
- c. The antenna is a broadband antenna, and its height is varied from one meter to four meters above the ground to determine the maximum value of the field strength. Both horizontal and vertical polarizations of the antenna are set to make the measurement.
- d. For each suspected emission, the EUT was arranged to its worst case and then the antenna was tuned to heights from 1 meter to 4 meters and the rotatable table was turned from 0 degrees to 360 degrees to find the maximum reading.
- e. The test-receiver system was set to Peak Detect Function and Specified Bandwidth with Maximum Hold Mode.
- f. If the emission level of the EUT in peak mode was lower than the limit specified, then testing could be stopped and the peak values of the EUT would be reported. Otherwise the emissions would be re-tested one by one using peak, quasi-peak or average method as specified and then reported in a data sheet.

NOTE:

1. The resolution bandwidth and video bandwidth of test receiver/spectrum analyzer is 120kHz for Quasi-peak detection at frequency below 1GHz.
2. The resolution bandwidth of test receiver/spectrum analyzer is 1 MHz and video bandwidth is 3MHz for Peak detection at frequency above 1GHz.
3. All modes of operation were investigated and the worst-case emissions are reported.

4.1.4 DEVIATION FROM TEST STANDARD

No deviation.

4.1.5 TEST SETUP

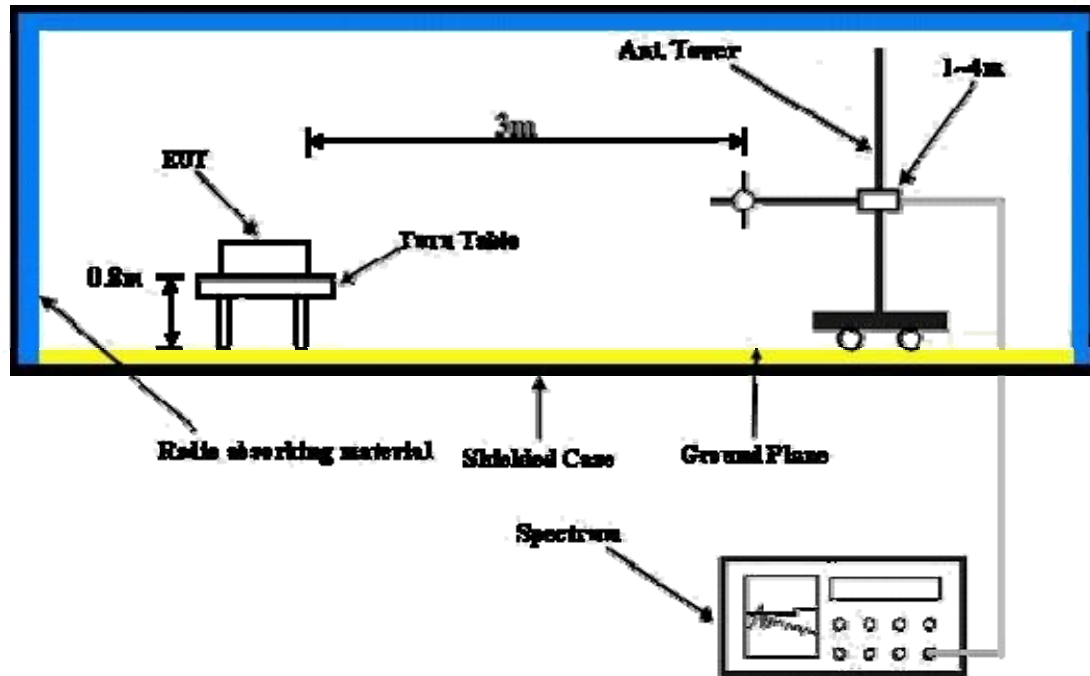

For the actual test configuration, please refer to the attached file (Test Setup Photo).

4.1.6 EUT OPERATING CONDITIONS

- Placed the EUT on the testing table.
- Prepared notebook system outside of testing area to act as a communication partners.
- The communication partner connected with EUT via a RJ45 UTP cable and run a test program (provided by manufacturer) to enable EUT under transmission condition continuously at specific channel frequency.
- The communication partner sent data to EUT by command "PING".



A D T

4.1.7 TEST RESULTS

GFSK

EUT TEST CONDITION		MEASUREMENT DETAIL	
CHANNEL	Channel 0	FREQUENCY RANGE	1 ~ 25GHz
INPUT POWER (SYSTEM)	120Vac, 60 Hz	DETECTOR FUNCTION	Peak (PK) Average (AV)
ENVIRONMENTAL CONDITIONS	26deg. C, 66%RH 1008 hPa	TESTED BY	Frank Wang

ANTENNA POLARITY & TEST DISTANCE: HORIZONTAL AT 3 M								
NO.	FREQ. (MHz)	EMISSION LEVEL (dBuV/m)	LIMIT (dBuV/m)	MARGIN (dB)	ANTENNA HEIGHT (m)	TABLE ANGLE (Degree)	RAW VALUE (dBuV)	CORRECTION FACTOR (dB/m)
1	2390.00	41.7 PK	74.0	-32.3	1.00 H	282	11.20	30.50
2	2390.00	29.5 AV	54.0	-24.5	1.00 H	282	-1.00	30.50
3	#2398.00	49.8 PK	71.9	-22.1	1.00 H	263	19.30	30.50
4	#2398.00	36.8 AV	41.8	-5.0	1.00 H	263	6.30	30.50
5	#2400.00	35.0 PK	71.9	-36.9	1.00 H	262	4.50	30.50
6	#2400.00	4.9 AV	41.8	-36.9	1.00 H	262	-25.60	30.50
7	*2402.00	91.9 PK			1.00 H	262	61.40	30.50
8	*2402.00	61.8 AV			1.00 H	262	31.30	30.50
9	4804.00	51.7 PK	74.0	-22.3	1.05 H	94	15.60	36.10
10	4804.00	21.6 AV	54.0	-32.4	1.05 H	94	-14.50	36.10

ANTENNA POLARITY & TEST DISTANCE: VERTICAL AT 3 M								
NO.	FREQ. (MHz)	EMISSION LEVEL (dBuV/m)	LIMIT (dBuV/m)	MARGIN (dB)	ANTENNA HEIGHT (m)	TABLE ANGLE (Degree)	RAW VALUE (dBuV)	CORRECTION FACTOR (dB/m)
1	2390.00	44.3 PK	74.0	-29.7	1.00 V	262	13.80	30.50
2	2390.00	30.1 AV	54.0	-23.9	1.00 V	262	-0.40	30.50
3	#2398.00	47.1 PK	73.5	-26.4	1.00 V	262	16.60	30.50
4	#2398.00	35.2 AV	43.4	-8.2	1.00 V	262	4.70	30.50
5	#2400.00	35.4 PK	73.5	-38.1	1.00 V	263	4.90	30.50
6	#2400.00	5.3 AV	43.4	-38.1	1.00 V	263	-25.20	30.50
7	*2402.00	93.5 PK			1.00 V	263	63.00	30.50
8	*2402.00	63.4 AV			1.00 V	263	32.90	30.50
9	4804.00	51.5 PK	74.0	-22.5	1.08 V	140	15.40	36.10
10	4804.00	21.4 AV	54.0	-32.6	1.08 V	140	-14.70	36.10

- REMARKS:**
1. Emission level (dBuV/m) = Raw Value (dBuV) + Correction Factor (dB/m).
 2. Correction Factor (dB/m) = Antenna Factor (dB/m) + Cable Factor (dB).
 3. The other emission levels were very low against the limit.
 4. Margin value = Emission level – Limit value.
 5. “ * “: Fundamental frequency.
 6. The DH5 packet was the worse case duty cycle for a transmit dwell time on a channel, based upon bluetooth theory the transmitter is on 0.625 * 5 per 296.25 ms per channel. Therefore, the duty cycle correlation factor be equal to: $20\log(3.125 / 100) = -30.1$ dB.
 7. Average value = peak reading + $20\log(\text{duty cycle})$.
 8. "#": The radiated frequency is out the restricted band.



A D T

EUT TEST CONDITION		MEASUREMENT DETAIL	
CHANNEL	Channel 39	FREQUENCY RANGE	1 ~ 25GHz
INPUT POWER (SYSTEM)	120Vac, 60 Hz	DETECTOR FUNCTION	Peak (PK) Average (AV)
ENVIRONMENTAL CONDITIONS	26deg. C, 66%RH 1008 hPa	TESTED BY	Frank Wang

ANTENNA POLARITY & TEST DISTANCE: HORIZONTAL AT 3 M								
NO.	FREQ. (MHz)	EMISSION LEVEL (dBuV/m)	LIMIT (dBuV/m)	MARGIN (dB)	ANTENNA HEIGHT (m)	TABLE ANGLE (Degree)	RAW VALUE (dBuV)	CORRECTION FACTOR (dB/m)
1	*2441.00	91.3 PK			1.03 H	156	60.60	30.70
2	*2441.00	61.2 AV			1.03 H	156	30.50	30.70
3	4882.00	51.0 PK	74.0	-23.0	1.13 H	29	14.80	36.20
4	4882.00	20.9 AV	54.0	-33.1	1.13 H	29	-15.30	36.20
ANTENNA POLARITY & TEST DISTANCE: VERTICAL AT 3 M								
NO.	FREQ. (MHz)	EMISSION LEVEL (dBuV/m)	LIMIT (dBuV/m)	MARGIN (dB)	ANTENNA HEIGHT (m)	TABLE ANGLE (Degree)	RAW VALUE (dBuV)	CORRECTION FACTOR (dB/m)
1	*2441.00	92.8 PK			1.00 V	263	62.10	30.70
2	*2441.00	62.7 AV			1.00 V	263	32.00	30.70
3	4882.00	52.0 PK	74.0	-22.0	1.03 V	70	15.80	36.20
4	4882.00	21.9 AV	54.0	-32.1	1.03 V	70	-14.30	36.20

- REMARKS:**
1. Emission level (dBuV/m) = Raw Value (dBuV) + Correction Factor (dB/m).
 2. Correction Factor (dB/m) = Antenna Factor (dB/m) + Cable Factor (dB).
 3. The other emission levels were very low against the limit.
 4. Margin value = Emission level – Limit value.
 5. “ * “: Fundamental frequency.
 6. The DH5 packet was the worse case duty cycle for a transmit dwell time on a channel, based upon bluetooth theory the transmitter is on 0.625 * 5 per 296.25 ms per channel. Therefore, the duty cycle correlation factor be equal to: $20\log(3.125 / 100) = -30.1$ dB.
 7. Average value = peak reading + $20\log(\text{duty cycle})$.



A D T

EUT TEST CONDITION		MEASUREMENT DETAIL	
CHANNEL	Channel 78	FREQUENCY RANGE	1 ~ 25GHz
INPUT POWER (SYSTEM)	120Vac, 60 Hz	DETECTOR FUNCTION	Peak (PK) Average (AV)
ENVIRONMENTAL CONDITIONS	26deg. C, 66%RH 1008 hPa	TESTED BY	Frank Wang

ANTENNA POLARITY & TEST DISTANCE: HORIZONTAL AT 3 M								
NO.	FREQ. (MHz)	EMISSION LEVEL (dBuV/m)	LIMIT (dBuV/m)	MARGIN (dB)	ANTENNA HEIGHT (m)	TABLE ANGLE (Degree)	RAW VALUE (dBuV)	CORRECTION FACTOR (dB/m)
1	*2480.00	91.0 PK			1.02 H	159	60.20	30.80
2	*2480.00	60.9 AV			1.02 H	159	30.10	30.80
3	2483.50	37.4 PK	74.0	-36.6	1.02 H	159	6.60	30.80
4	2483.50	7.3 AV	54.0	-46.7	1.02 H	159	-23.50	30.80
5	2485.50	46.7 PK	74.0	-27.3	1.02 H	159	15.90	30.80
6	2485.50	31.2 AV	54.0	-22.8	1.02 H	159	0.40	30.80
7	4960.00	50.3 PK	74.0	-23.7	1.11 H	29	13.90	36.40
8	4960.00	20.2 AV	54.0	-33.8	1.11 H	29	-16.20	36.40
ANTENNA POLARITY & TEST DISTANCE: VERTICAL AT 3 M								
NO.	FREQ. (MHz)	EMISSION LEVEL (dBuV/m)	LIMIT (dBuV/m)	MARGIN (dB)	ANTENNA HEIGHT (m)	TABLE ANGLE (Degree)	RAW VALUE (dBuV)	CORRECTION FACTOR (dB/m)
1	*2480.00	92.5 PK			1.00 V	262	61.70	30.80
2	*2480.00	62.4 AV			1.00 V	262	31.60	30.80
3	2483.50	38.8 PK	74.0	-35.2	1.00 V	262	8.00	30.80
4	2483.50	8.7 AV	54.0	-45.3	1.00 V	262	-22.10	30.80
5	2485.50	47.6 PK	74.0	-26.4	1.00 V	262	16.80	30.80
6	2485.50	31.4 AV	54.0	-22.6	1.00 V	262	0.60	30.80
7	4960.00	50.7 PK	74.0	-23.3	1.11 V	70	14.30	36.40
8	4960.00	20.6 AV	54.0	-33.4	1.11 V	70	-15.80	36.40

- REMARKS:**
- Emission level (dBuV/m) = Raw Value (dBuV) + Correction Factor (dB/m).
 - Correction Factor (dB/m) = Antenna Factor (dB/m) + Cable Factor (dB).
 - The other emission levels were very low against the limit.
 - Margin value = Emission level – Limit value.
 - * * *: Fundamental frequency.
 - The DH5 packet was the worse case duty cycle for a transmit dwell time on a channel, based upon bluetooth theory the transmitter is on 0.625 * 5 per 296.25 ms per channel. Therefore, the duty cycle correlation factor be equal to: $20\log(3.125 / 100) = -30.1$ dB.
 - Average value = peak reading + $20\log(\text{duty cycle})$.



A D T

8DPSK

EUT TEST CONDITION		MEASUREMENT DETAIL	
CHANNEL	Channel 0	FREQUENCY RANGE	1 ~ 25GHz
INPUT POWER (SYSTEM)	120Vac, 60 Hz	DETECTOR FUNCTION	Peak (PK) Average (AV)
ENVIRONMENTAL CONDITIONS	26deg. C, 66%RH 1008 hPa	TESTED BY	Frank Wang

ANTENNA POLARITY & TEST DISTANCE: HORIZONTAL AT 3 M								
NO.	FREQ. (MHz)	EMISSION LEVEL (dBuV/m)	LIMIT (dBuV/m)	MARGIN (dB)	ANTENNA HEIGHT (m)	TABLE ANGLE (Degree)	RAW VALUE (dBuV)	CORRECTION FACTOR (dB/m)
1	2390.00	39.4 PK	74.0	-34.6	1.06 H	192	8.90	30.50
2	2390.00	28.5 AV	54.0	-25.5	1.06 H	192	-2.00	30.50
3	#2398.00	43.8 PK	70.9	-27.1	1.06 H	192	13.30	30.50
4	#2398.00	32.6 AV	40.8	-8.2	1.06 H	192	2.10	30.50
5	#2400.00	39.2 PK	70.9	-31.7	1.06 H	192	8.70	30.50
6	#2400.00	9.1 AV	40.8	-31.7	1.06 H	192	-21.40	30.50
7	*2402.00	90.9 PK			1.06 H	192	60.40	30.50
8	*2402.00	60.8 AV			1.06 H	192	30.30	30.50
9	4804.00	51.3 PK	74.0	-22.7	1.02 H	31	15.20	36.10
10	4804.00	21.2 AV	54.0	-32.8	1.02 H	31	-14.90	36.10

ANTENNA POLARITY & TEST DISTANCE: VERTICAL AT 3 M								
NO.	FREQ. (MHz)	EMISSION LEVEL (dBuV/m)	LIMIT (dBuV/m)	MARGIN (dB)	ANTENNA HEIGHT (m)	TABLE ANGLE (Degree)	RAW VALUE (dBuV)	CORRECTION FACTOR (dB/m)
1	2390.00	45.2 PK	74.0	-28.8	1.00 V	262	14.70	30.50
2	2390.00	29.8 AV	54.0	-24.2	1.00 V	262	-0.70	30.50
3	#2398.00	46.6 PK	73.3	-26.7	1.00 V	263	16.10	30.50
4	#2398.00	35.1 AV	43.2	-8.1	1.00 V	263	4.60	30.50
5	#2400.00	39.9 PK	73.3	-33.4	1.00 V	262	9.40	30.50
6	#2400.00	9.8 AV	43.2	-33.4	1.00 V	262	-20.70	30.50
7	*2402.00	93.3 PK			1.00 V	262	62.80	30.50
8	*2402.00	63.2 AV			1.00 V	262	32.70	30.50
9	4804.00	51.0 PK	74.0	-23.0	1.00 V	158	14.90	36.10
10	4804.00	20.9 AV	54.0	-33.1	1.00 V	158	-15.20	36.10

- REMARKS:**
1. Emission level (dBuV/m) = Raw Value (dBuV) + Correction Factor (dB/m).
 2. Correction Factor (dB/m) = Antenna Factor (dB/m) + Cable Factor (dB).
 3. The other emission levels were very low against the limit.
 4. Margin value = Emission level – Limit value.
 5. “ * “: Fundamental frequency.
 6. The DH5 packet was the worse case duty cycle for a transmit dwell time on a channel, based upon bluetooth theory the transmitter is on 0.625 * 5 per 296.25 ms per channel. Therefore, the duty cycle correlation factor be equal to: $20\log(3.125 / 100) = -30.1$ dB.
 7. Average value = peak reading + $20\log(\text{duty cycle})$.
 8. "#":The radiated frequency is out the restricted band.



A D T

EUT TEST CONDITION		MEASUREMENT DETAIL	
CHANNEL	Channel 39	FREQUENCY RANGE	1 ~ 25GHz
INPUT POWER (SYSTEM)	120Vac, 60 Hz	DETECTOR FUNCTION	Peak (PK) Average (AV)
ENVIRONMENTAL CONDITIONS	26deg. C, 66%RH 1008 hPa	TESTED BY	Frank Wang

ANTENNA POLARITY & TEST DISTANCE: HORIZONTAL AT 3 M								
NO.	FREQ. (MHz)	EMISSION LEVEL (dBuV/m)	LIMIT (dBuV/m)	MARGIN (dB)	ANTENNA HEIGHT (m)	TABLE ANGLE (Degree)	RAW VALUE (dBuV)	CORRECTION FACTOR (dB/m)
1	*2441.00	92.7 PK			1.05 H	156	62.00	30.70
2	*2441.00	62.6 AV			1.05 H	156	31.90	30.70
3	4882.00	52.0 PK	74.0	-22.0	1.58 H	80	15.80	36.20
4	4882.00	21.9 AV	54.0	-32.1	1.58 H	80	-14.30	36.20
ANTENNA POLARITY & TEST DISTANCE: VERTICAL AT 3 M								
NO.	FREQ. (MHz)	EMISSION LEVEL (dBuV/m)	LIMIT (dBuV/m)	MARGIN (dB)	ANTENNA HEIGHT (m)	TABLE ANGLE (Degree)	RAW VALUE (dBuV)	CORRECTION FACTOR (dB/m)
1	*2441.00	94.1 PK			1.00 V	263	63.40	30.70
2	*2441.00	64.0 AV			1.00 V	263	33.30	30.70
3	4882.00	52.9 PK	74.0	-21.1	1.03 V	69	16.70	36.20
4	4882.00	22.8 AV	54.0	-31.2	1.03 V	69	-13.40	36.20

- REMARKS:**
1. Emission level (dBuV/m) = Raw Value (dBuV) + Correction Factor (dB/m).
 2. Correction Factor (dB/m) = Antenna Factor (dB/m) + Cable Factor (dB).
 3. The other emission levels were very low against the limit.
 4. Margin value = Emission level – Limit value.
 5. “ * “: Fundamental frequency.
 6. The DH5 packet was the worse case duty cycle for a transmit dwell time on a channel, based upon bluetooth theory the transmitter is on 0.625 * 5 per 296.25 ms per channel. Therefore, the duty cycle correlation factor be equal to: $20\log(3.125 / 100) = -30.1$ dB.
 7. Average value = peak reading + $20\log(\text{duty cycle})$.



A D T

EUT TEST CONDITION		MEASUREMENT DETAIL	
CHANNEL	Channel 78	FREQUENCY RANGE	1 ~ 25GHz
INPUT POWER (SYSTEM)	120Vac, 60 Hz	DETECTOR FUNCTION	Peak (PK) Average (AV)
ENVIRONMENTAL CONDITIONS	26deg. C, 66%RH 1008 hPa	TESTED BY	Frank Wang

ANTENNA POLARITY & TEST DISTANCE: HORIZONTAL AT 3 M								
NO.	FREQ. (MHz)	EMISSION LEVEL (dBuV/m)	LIMIT (dBuV/m)	MARGIN (dB)	ANTENNA HEIGHT (m)	TABLE ANGLE (Degree)	RAW VALUE (dBuV)	CORRECTION FACTOR (dB/m)
1	*2480.00	92.9 PK			1.02 H	157	62.10	30.80
2	*2480.00	62.8 AV			1.02 H	157	32.00	30.80
3	2483.50	38.2 PK	74.0	-35.8	1.01 H	156	7.40	30.80
4	2483.50	8.1 AV	54.0	-45.9	1.01 H	156	-22.70	30.80
5	2485.50	40.7 PK	74.0	-33.3	1.01 H	156	9.90	30.80
6	2485.50	31.3 AV	54.0	-22.7	1.01 H	156	0.50	30.80
7	4960.00	51.1 PK	74.0	-22.9	1.26 H	81	14.70	36.40
8	4960.00	21.0 AV	54.0	-33.0	1.26 H	81	-15.40	36.40
ANTENNA POLARITY & TEST DISTANCE: VERTICAL AT 3 M								
NO.	FREQ. (MHz)	EMISSION LEVEL (dBuV/m)	LIMIT (dBuV/m)	MARGIN (dB)	ANTENNA HEIGHT (m)	TABLE ANGLE (Degree)	RAW VALUE (dBuV)	CORRECTION FACTOR (dB/m)
1	*2480.00	94.2 PK			1.00 V	261	63.40	30.80
2	*2480.00	64.1 AV			1.00 V	261	33.30	30.80
3	2483.50	37.9 PK	74.0	-36.1	1.00 V	261	7.10	30.80
4	2483.50	7.8 AV	54.0	-46.2	1.00 V	261	-23.00	30.80
5	2485.50	46.8 PK	74.0	-27.2	1.00 V	261	16.00	30.80
6	2485.50	31.6 AV	54.0	-22.4	1.00 V	261	0.80	30.80
7	4960.00	51.5 PK	74.0	-22.5	1.00 V	69	15.10	36.40
8	4960.00	21.4 AV	54.0	-32.6	1.00 V	69	-15.00	36.40

- REMARKS:**
- Emission level (dBuV/m) = Raw Value (dBuV) + Correction Factor (dB/m).
 - Correction Factor (dB/m) = Antenna Factor (dB/m) + Cable Factor (dB).
 - The other emission levels were very low against the limit.
 - Margin value = Emission level – Limit value.
 - * * *: Fundamental frequency.
 - The DH5 packet was the worse case duty cycle for a transmit dwell time on a channel, based upon bluetooth theory the transmitter is on 0.625 * 5 per 296.25 ms per channel. Therefore, the duty cycle correlation factor be equal to: $20\log(3.125 / 100) = -30.1$ dB.
 - Average value = peak reading + $20\log(\text{duty cycle})$.



A D T

BELOW 1GHz WORST-CASE DATA : GFSK

EUT TEST CONDITION		MEASUREMENT DETAIL	
CHANNEL	Channel 0	FREQUENCY RANGE	Below 1000MHz
INPUT POWER (SYSTEM)	120Vac, 60 Hz	DETECTOR FUNCTION	Quasi-Peak
ENVIRONMENTAL CONDITIONS	25deg. C, 66%RH 1012 hPa	TESTED BY	Frank Wang

ANTENNA POLARITY & TEST DISTANCE: HORIZONTAL AT 3 M								
NO.	FREQ. (MHz)	EMISSION LEVEL (dBuV/m)	LIMIT (dBuV/m)	MARGIN (dB)	ANTENNA HEIGHT (m)	TABLE ANGLE (Degree)	RAW VALUE (dBuV)	CORRECTION FACTOR (dB/m)
1	84.34	36.1 QP	40.0	-3.9	2.00 H	136	27.20	8.90
2	171.83	40.8 QP	43.5	-2.7	1.75 H	76	27.70	13.10
3	768.73	42.5 QP	46.0	-3.5	1.00 H	37	18.20	24.30
4	796.28	41.8 QP	46.0	-4.2	1.78 H	330	17.20	24.60
5	830.95	41.9 QP	46.0	-4.1	1.75 H	37	16.90	25.00
6	935.94	40.7 QP	46.0	-5.3	1.25 H	52	14.20	26.50
ANTENNA POLARITY & TEST DISTANCE: VERTICAL AT 3 M								
NO.	FREQ. (MHz)	EMISSION LEVEL (dBuV/m)	LIMIT (dBuV/m)	MARGIN (dB)	ANTENNA HEIGHT (m)	TABLE ANGLE (Degree)	RAW VALUE (dBuV)	CORRECTION FACTOR (dB/m)
1	34.17	32.2 QP	40.0	-7.8	1.00 V	347	19.80	12.40
2	197.11	38.4 QP	43.5	-5.1	1.00 V	40	27.90	10.50
3	433.05	43.4 QP	46.0	-2.6	1.25 V	175	25.40	18.00
4	834.84	42.5 QP	46.0	-3.5	1.25 V	349	17.40	25.10
5	902.89	44.1 QP	46.0	-1.9	1.00 V	355	18.10	26.00
6	932.05	44.2 QP	46.0	-1.8	1.25 V	13	17.80	26.40

- REMARKS:**
1. Emission level (dBuV/m) = Raw Value (dBuV) + Correction Factor (dB/m).
 2. Correction Factor (dB/m) = Antenna Factor (dB/m) + Cable Factor (dB).
 3. The other emission levels were very low against the limit.
 4. Margin value = Emission level – Limit value.

4.2 CONDUCTED EMISSION MEASUREMENT

4.2.1 LIMITS OF CONDUCTED EMISSION MEASUREMENT

FREQUENCY OF EMISSION (MHz)	CONDUCTED LIMIT (dB μ V)	
	Quasi-peak	Average
0.15 ~ 0.5	66 to 56	56 to 46
0.5 ~ 5	56	46
5 ~ 30	60	50

- NOTE:**
1. The lower limit shall apply at the transition frequencies.
 2. The limit decreases in line with the logarithm of the frequency in the range of 0.15 to 0.50 MHz.
 3. All emanations from a class A/B digital device or system, including any network of conductors and apparatus connected thereto, shall not exceed the level of field strengths specified above.

4.2.2 TEST INSTRUMENTS

DESCRIPTION & MANUFACTURER	MODEL NO.	SERIAL NO.	DATE OF CALIBRATION	DUE DATE OF CALIBRATION
Test Receiver ROHDE & SCHWARZ	ESCS30	100289	Nov. 23, 2009	Nov. 22, 2010
RF signal cable Woken	5D-FB	Cable-HYCO2-01	Dec. 31, 2009	Dec. 30, 2010
LISN ROHDE & SCHWARZ	ESH2-Z5	100100	Dec. 25, 2009	Dec. 24, 2010
LISN ROHDE & SCHWARZ	ESH3-Z5	100311	Jul. 08, 2010	Jul. 07, 2011
V-LISN SCHWARZBECK	NNBL 8226-2	8226-142	Jul. 12, 2010	Jul. 11, 2011
Software ADT	ADT_Cond_ V7.3.7	NA	NA	NA

- NOTE:**
1. The calibration interval of the above test instruments is 12 months and the calibrations are traceable to NML/ROC and NIST/USA.
 2. The test was performed in HwaYa Shielded Room 2.
 3. The VCCI Site Registration No. is C-2047.

4.2.3 TEST PROCEDURES

- a. The EUT was placed 0.4 meters from the conducting wall of the shielded room with EUT being connected to the power mains through a line impedance stabilization network (LISN). Other support units were connected to the power mains through another LISN. The two LISNs provide 50 ohm/ 50uH of coupling impedance for the measuring instrument.
- b. Both lines of the power mains connected to the EUT were checked for maximum conducted interference.
- c. The frequency range from 150kHz to 30MHz was searched. Emission levels under (Limit - 20dB) was not recorded.

NOTE: All modes of operation were investigated and the worst-case emissions are reported.

4.2.4 DEVIATION FROM TEST STANDARD

No deviation

4.2.5 TEST SETUP

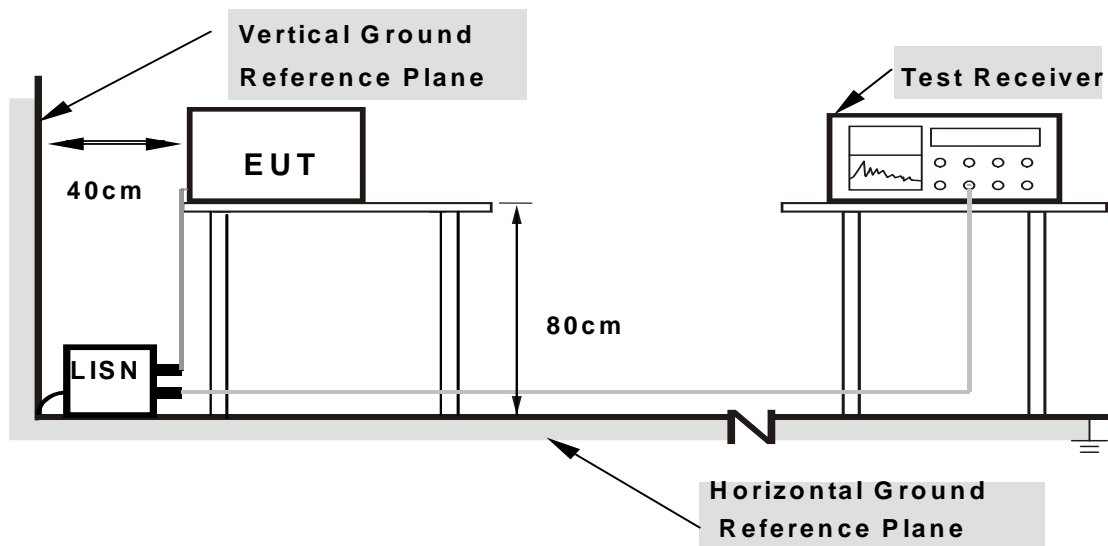

- Note: 1.Support units were connected to second LISN.**
2.Both of LISNs (AMN) are 80 cm from EUT and at least 80 from other units and other metal planes

For the actual test configuration, please refer to the attached file (Test Setup Photo).

4.2.6 EUT OPERATING CONDITIONS

Same as 4.1.6.

4.2.7 TEST RESULTS

CONDUCTED WORST CASE DATA: GFSK

PHASE	Line 1	6dB BANDWIDTH	9kHz
-------	--------	---------------	------

No	Freq. [MHz]	Corr. Factor (dB)	Reading Value		Emission Level		Limit		Margin	
			[dB (uV)]		[dB (uV)]		[dB (uV)]		(dB)	
			Q.P.	AV.	Q.P.	AV.	Q.P.	AV.	Q.P.	AV.
1	0.179	0.11	49.25	-	49.36	-	64.55	54.55	-15.18	-
2	0.236	0.11	42.11	-	42.22	-	62.24	52.24	-20.01	-
3	0.297	0.12	37.12	-	37.24	-	60.32	50.32	-23.08	-
4	0.888	0.17	32.81	-	32.98	-	56.00	46.00	-23.02	-
5	3.086	0.30	34.47	-	34.77	-	56.00	46.00	-21.23	-
6	19.324	1.44	34.05	-	35.49	-	60.00	50.00	-24.51	-

- REMARKS:**
1. Q.P. and AV. are abbreviations of quasi-peak and average individually.
 2. "-": The Quasi-peak reading value also meets average limit and measurement with the average detector is unnecessary.
 3. The emission levels of other frequencies were very low against the limit.
 4. Margin value = Emission level - Limit value
 5. Correction factor = Insertion loss + Cable loss
 6. Emission Level = Correction Factor + Reading Value.

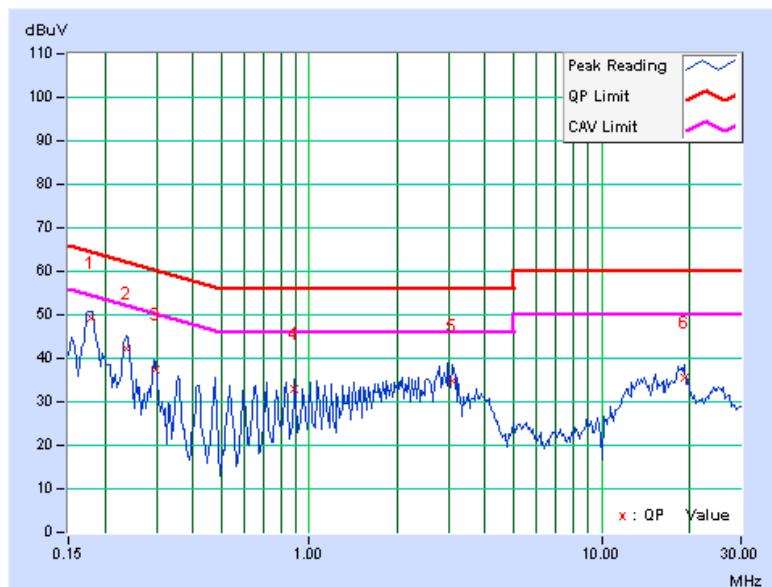

PHASE	Line 2	6dB BANDWIDTH	9kHz
-------	--------	---------------	------

No	Freq.	Corr.	Reading Value		Emission Level		Limit		Margin	
	[MHz]	Factor (dB)	[dB (uV)]		[dB (uV)]		[dB (uV)]		(dB)	
			Q.P.	AV.	Q.P.	AV.	Q.P.	AV.	Q.P.	AV.
1	0.177	0.10	49.96	-	50.06	-	64.61	54.61	-14.55	-
2	0.240	0.10	42.64	-	42.74	-	62.10	52.10	-19.36	-
3	0.295	0.11	36.77	-	36.88	-	60.40	50.40	-23.52	-
4	0.888	0.16	31.26	-	31.42	-	56.00	46.00	-24.58	-
5	3.023	0.28	31.56	-	31.84	-	56.00	46.00	-24.16	-
6	19.329	1.26	34.50	-	35.76	-	60.00	50.00	-24.24	-

- REMARKS:**
1. Q.P. and AV. are abbreviations of quasi-peak and average individually.
 2. "-": The Quasi-peak reading value also meets average limit and measurement with the average detector is unnecessary.
 3. The emission levels of other frequencies were very low against the limit.
 4. Margin value = Emission level - Limit value
 5. Correction factor = Insertion loss + Cable loss
 6. Emission Level = Correction Factor + Reading Value.

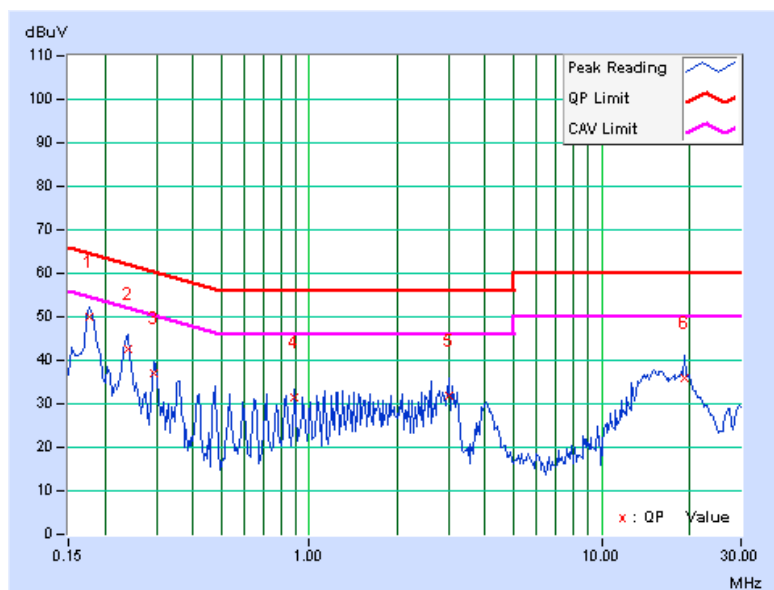

4.3 NUMBER OF HOPPING FREQUENCY USED

4.3.1 LIMIT OF HOPPING FREQUENCY USED

At least 15 channels frequencies, and should be equally spaced.

4.3.2 TEST INSTRUMENTS

DESCRIPTION & MANUFACTURER	MODEL NO.	SERIAL NO.	DATE OF CALIBRATION	DUE DATE OF CALIBRATION
R&S SPECTRUM ANALYZER	FSP40	100039	Jan. 11, 2010	Jan. 10, 2011

NOTE: The calibration interval of the above test instruments is 12 months and the calibrations are traceable to NML/ROC and NIST/USA.

4.3.3 TEST PROCEDURES

- a. Check the calibration of the measuring instrument (SA) using either an internal calibrator or a known signal from an external generator.
- b. Turn on the EUT and connect its antenna terminal to measurement via a low loss cable. Then set it to any one measured frequency within its operating range and make sure the instrument is operated in its linear range.
- c. Set the SA on MaxHold Mode, and then keep the EUT in hopping mode. Record all the signals from each channel until each one has been recorded.
- d. Set the SA on View mode and then plot the result on SA screen.
- e. Repeat above procedures until all frequencies measured were complete.

4.3.4 DEVIATION FROM TEST STANDARD

No deviation.

4.3.5 TEST SETUP

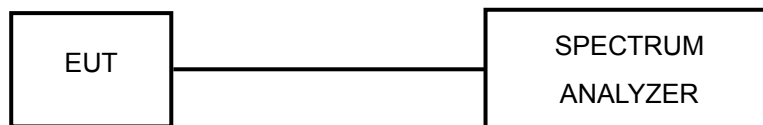

4.3.6 TEST RESULTS

There are 79 hopping frequencies in the hopping mode. Please refer to next two pages for the test result. On the plots, it shows that the hopping frequencies are equally spaced.



A D T

GFSK

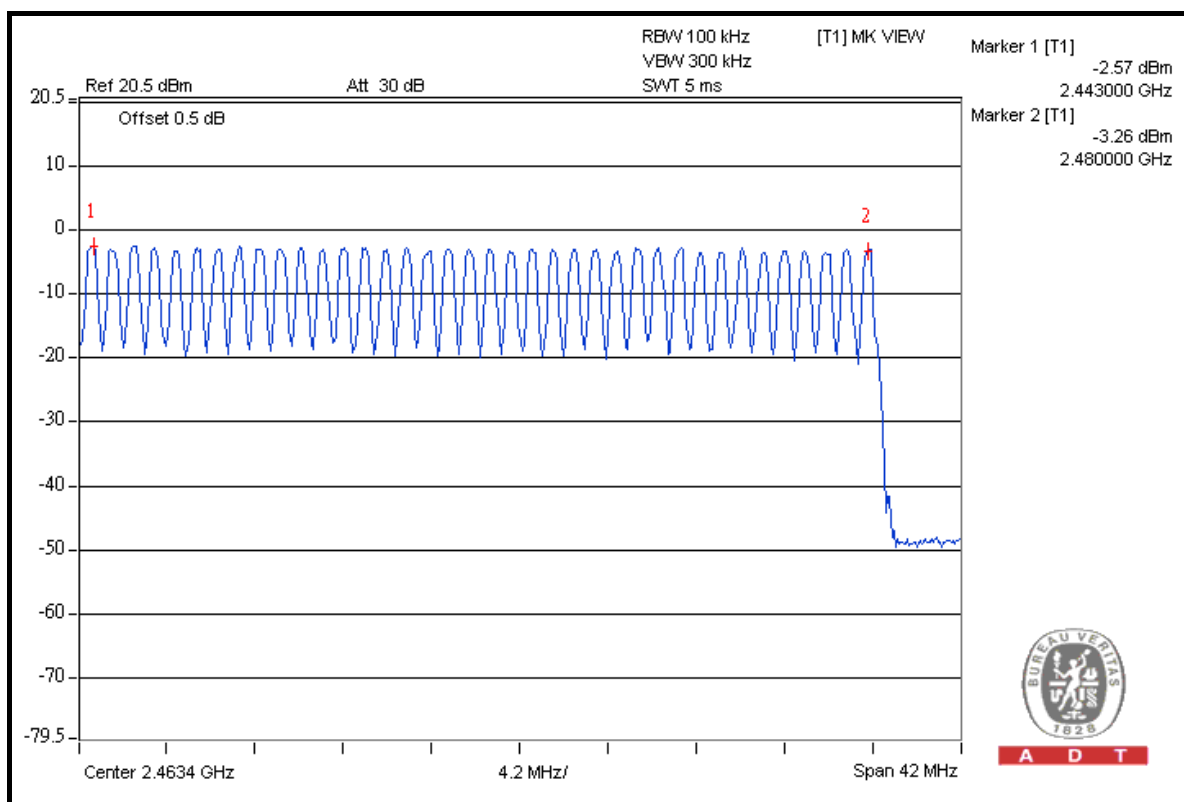
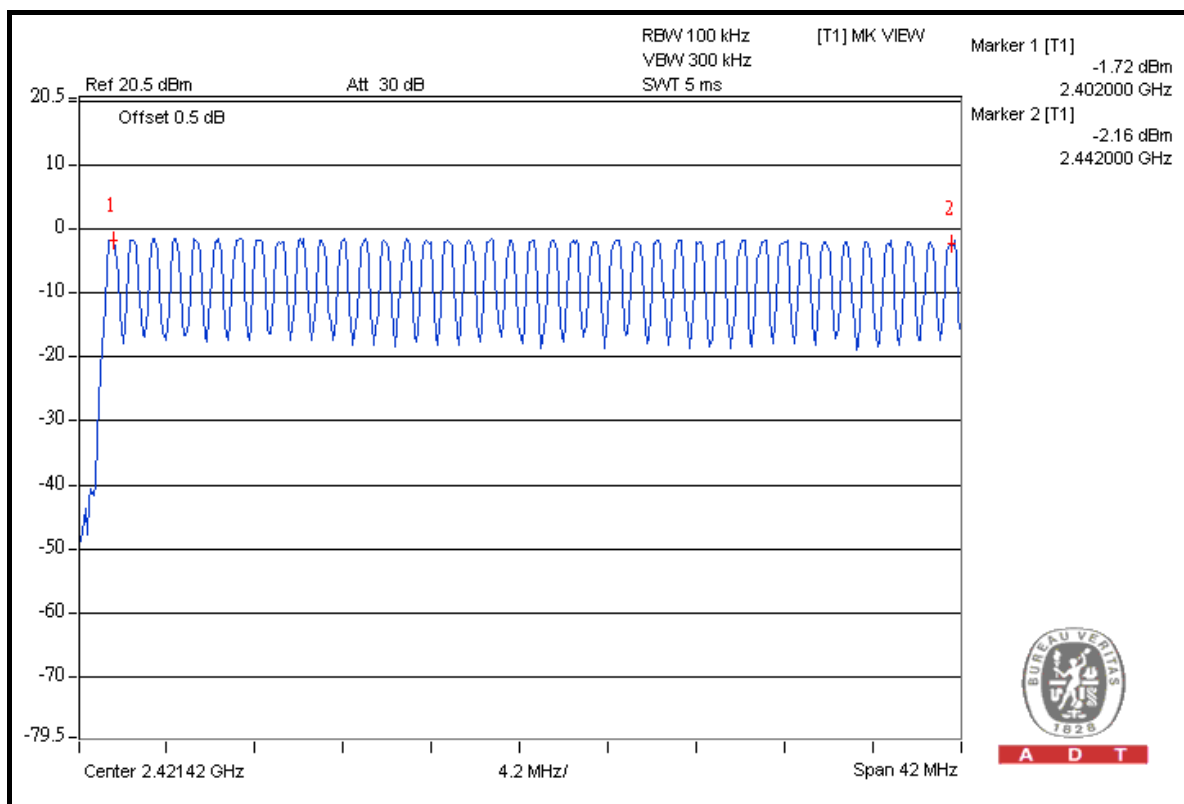



A D T

8DPSK

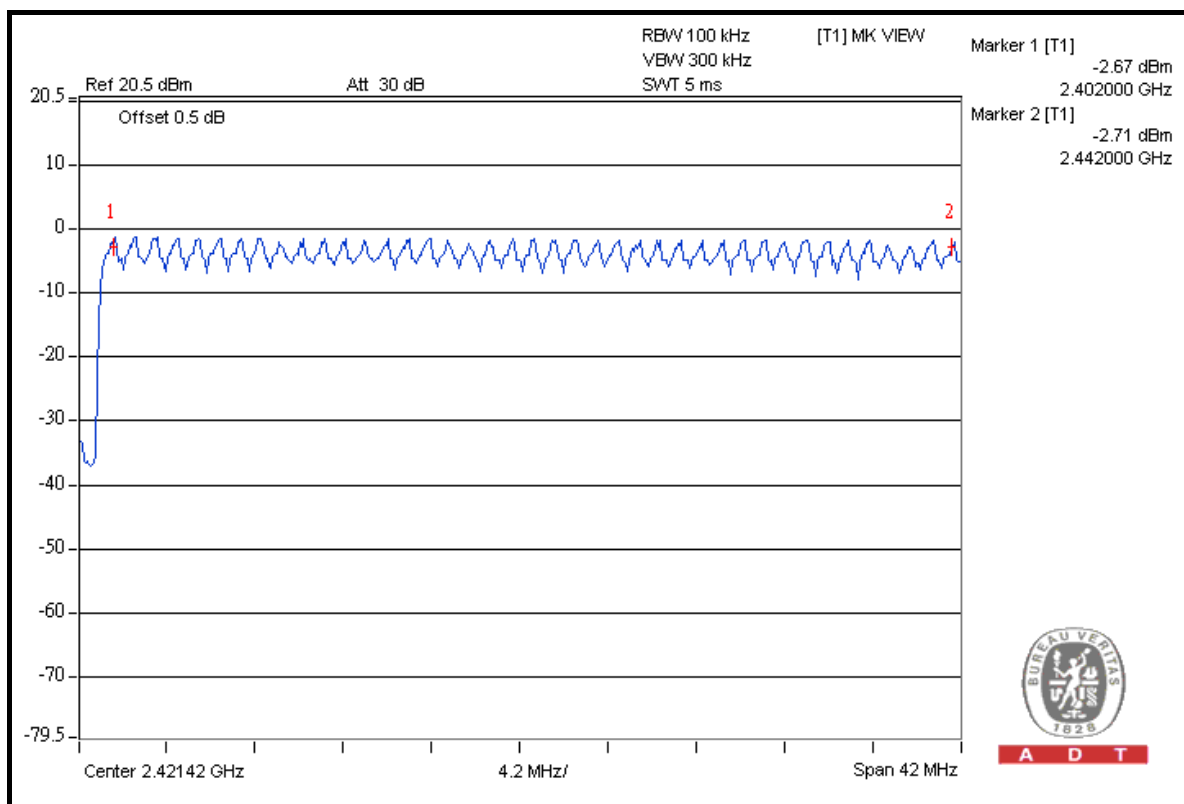

A D T

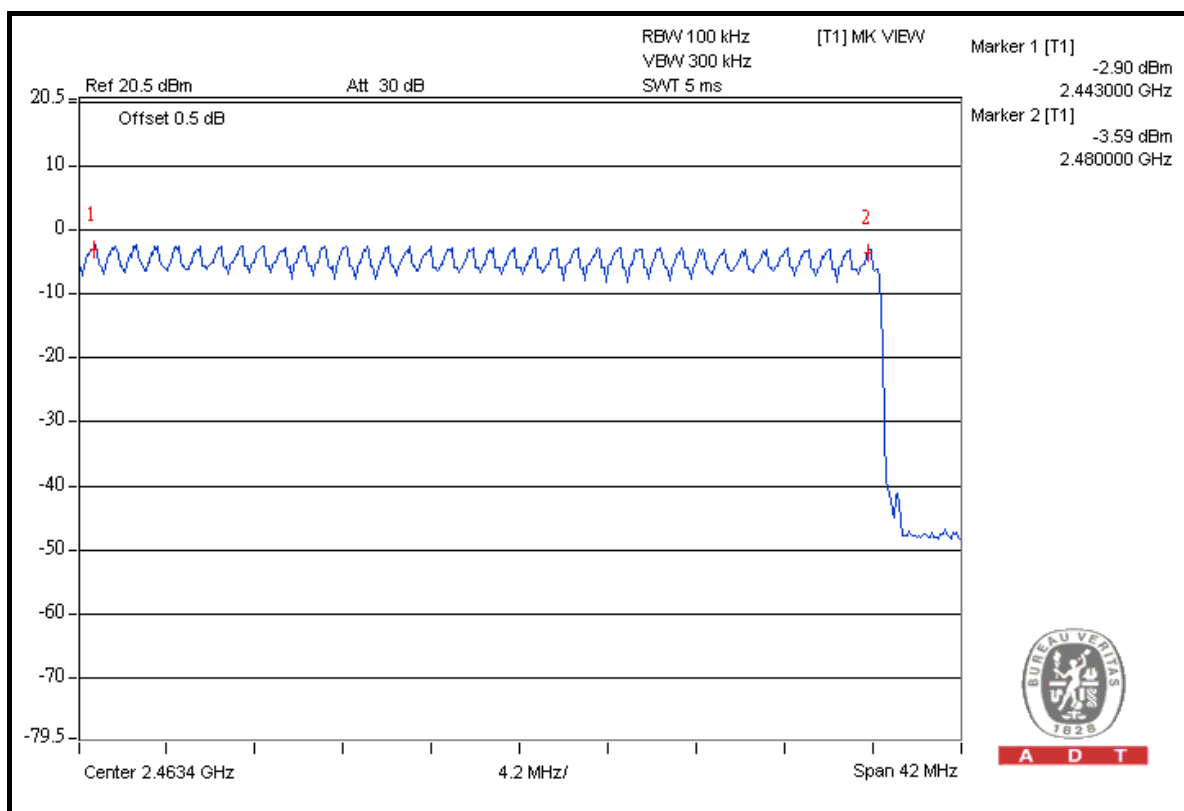

A D T

4.4 DWELL TIME ON EACH CHANNEL

4.4.1 LIMIT OF DWELL TIME USED

The average time of occupancy on any channel shall not be greater than 0.4 seconds within a period of 0.4 seconds multiplied by the number of hopping channels employed.

4.4.2 TEST INSTRUMENTS

DESCRIPTION & MANUFACTURER	MODEL NO.	SERIAL NO.	DATE OF CALIBRATION	DUE DATE OF CALIBRATION
R&S SPECTRUM ANALYZER	FSP40	100039	Jan. 11, 2010	Jan. 10, 2011

NOTE: The calibration interval of the above test instruments is 12 months and the calibrations are traceable to NML/ROC and NIST/USA.

4.4.3 TEST PROCEDURES

- a. Check the calibration of the measuring instrument (SA) using either an internal calibrator or a known signal from an external generator.
- b. Turn on the EUT and connect its antenna terminal to measurement via a low loss cable. Then set it to any one measured frequency within its operating range and make sure the instrument is operated in its linear range.
- c. Adjust the center frequency of SA on any frequency be measured and set SA to zero span mode. And then, set RBW and VBW of spectrum analyzer to proper value.
- d. Measure the time duration of one transmission on the measured frequency. And then plot the result with time difference of this time duration.
- e. Repeat above procedures until all different time-slot modes have been completed.

4.4.4 DEVIATION FROM TEST STANDARD

No deviation.

4.4.5 TEST SETUP

Same as 4.3.5.

4.4.6 TEST RESULTS

GFSK

Mode	Number of transmission in a 31.6 (79Hopping*0.4)	Length of transmission time (msec)	Result (msec)	Limit (msec)
DH1	50 (times / 5 sec) * 6.32 = 316.00 times	0.516	163.056	400
DH3	25 (times / 5 sec) * 6.32 = 158.00 times	1.770	279.660	400
DH5	17 (times / 5 sec) * 6.32 = 107.44 times	3.050	327.692	400

NOTE: Test plots of the transmitting time slot are shown on next 3 pages.



A D T

DH1

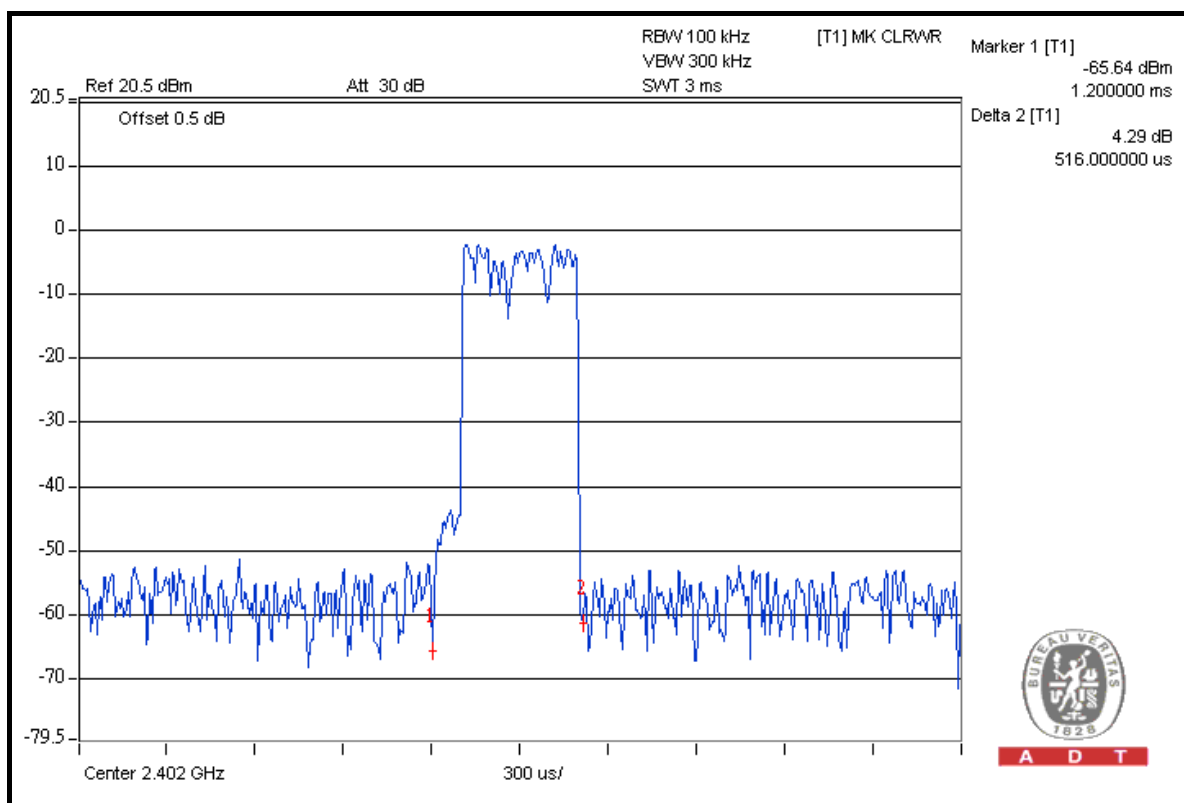
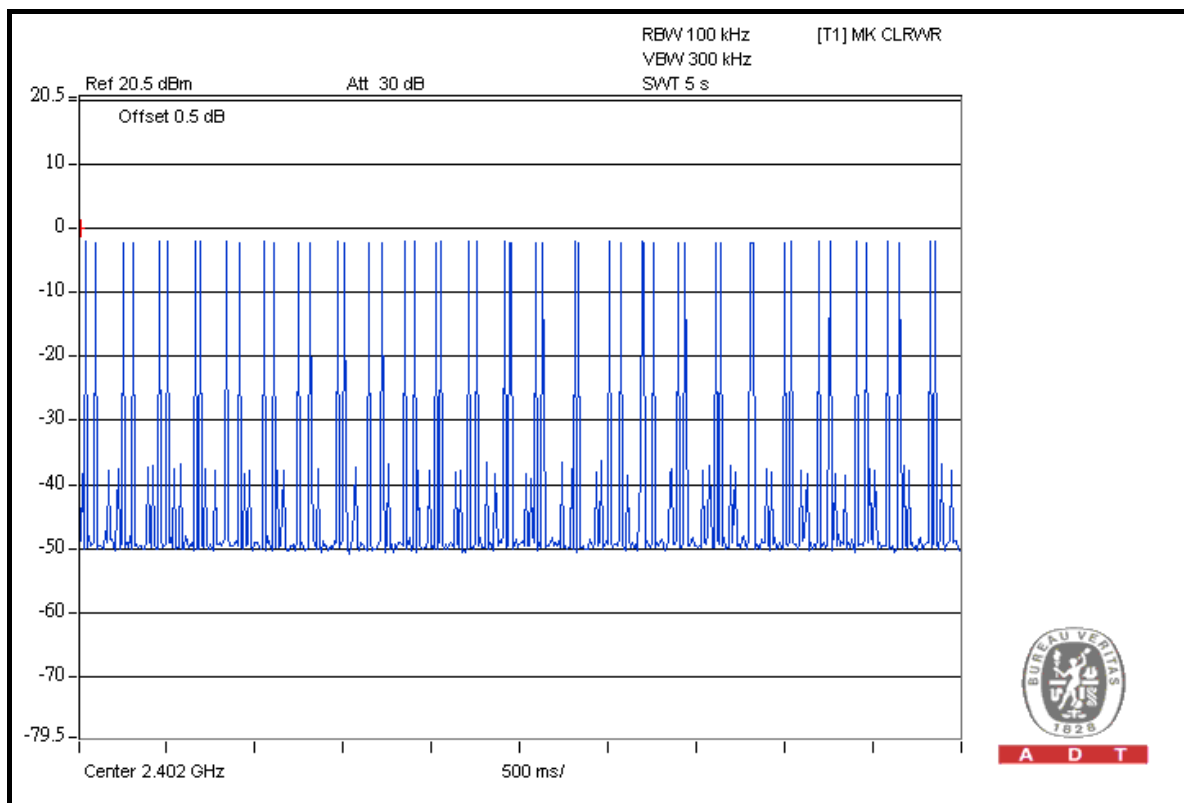



A D T

DH3

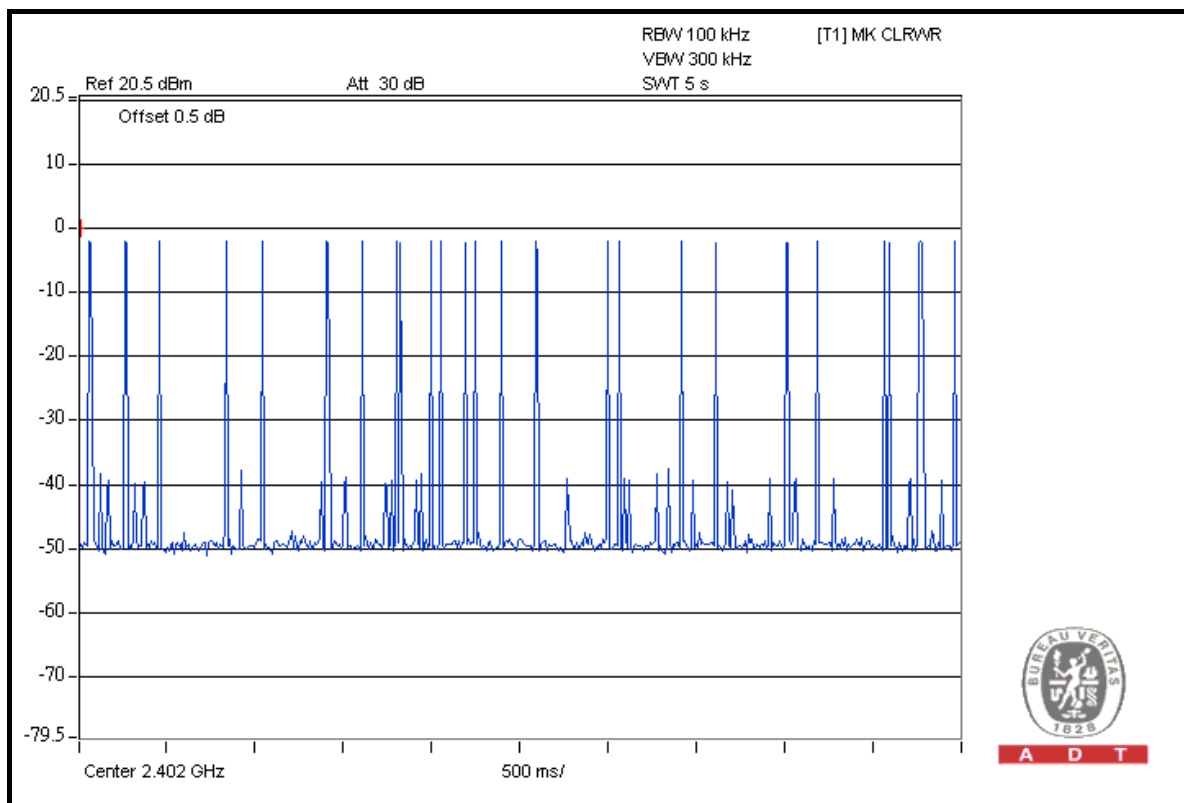

A D T

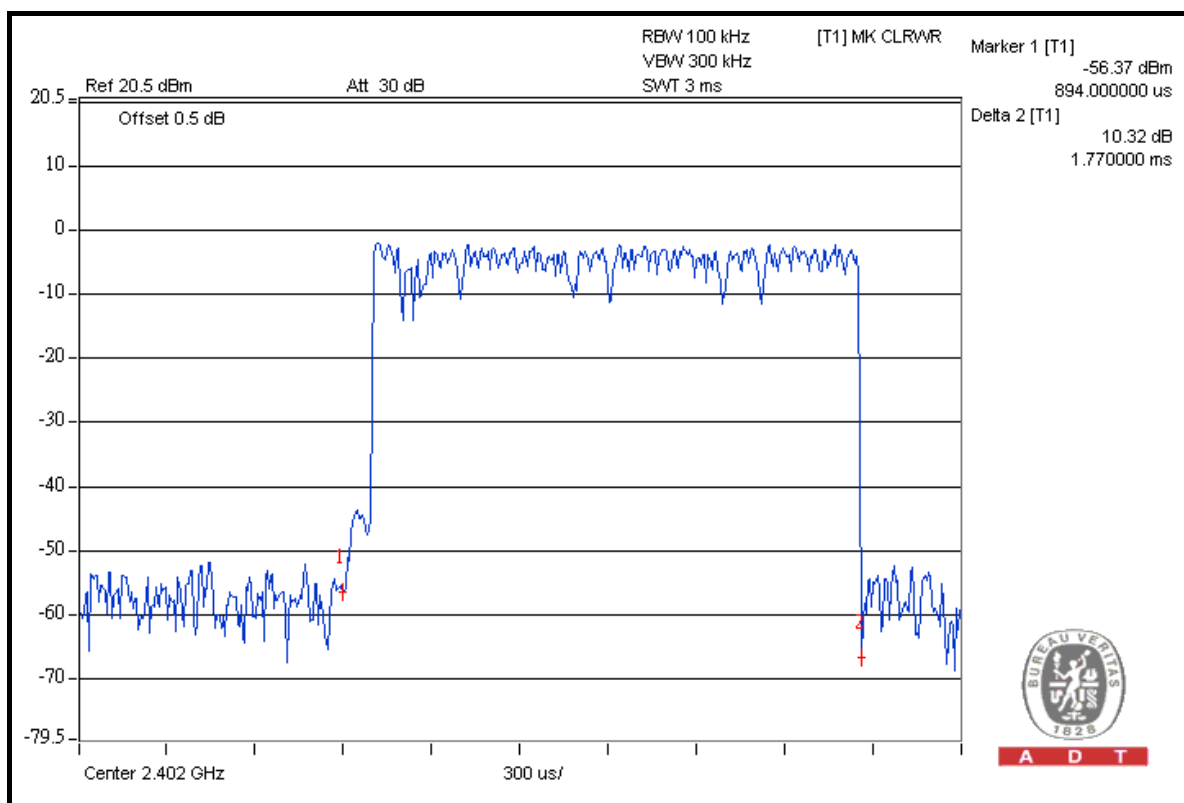

A D T



A D T

DH5

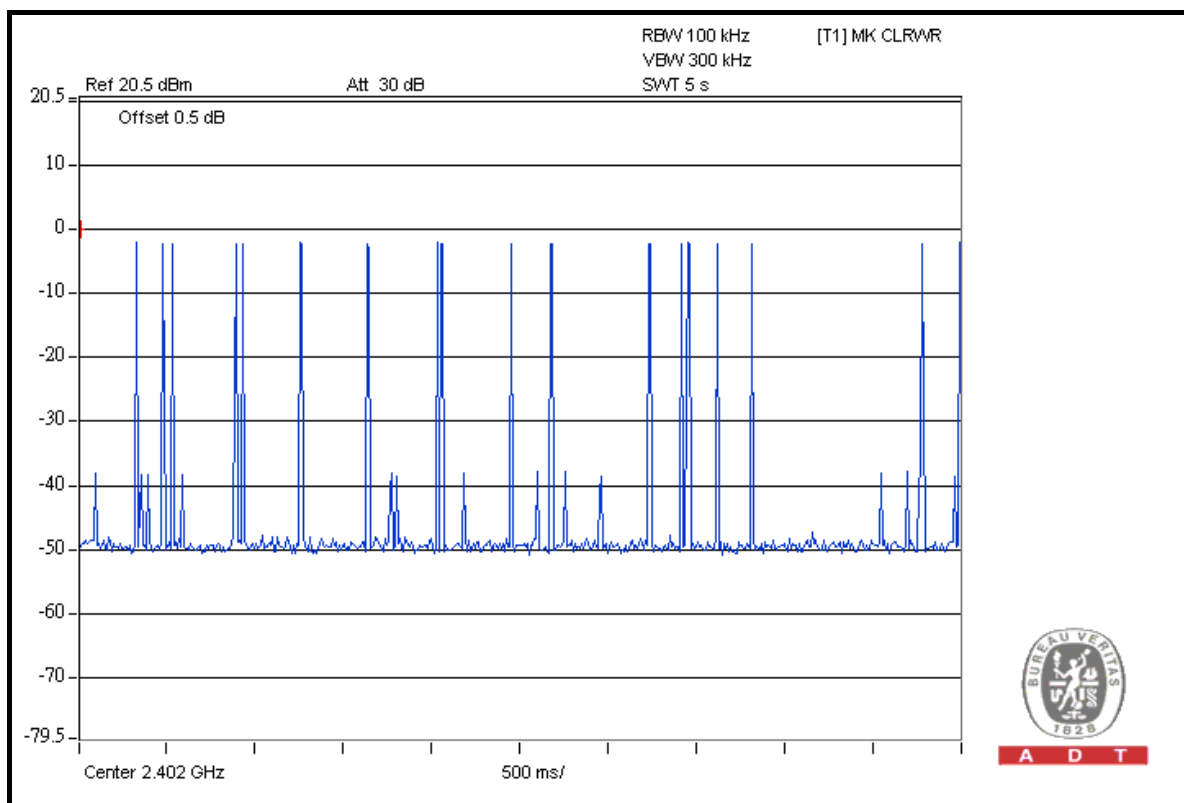

A D T

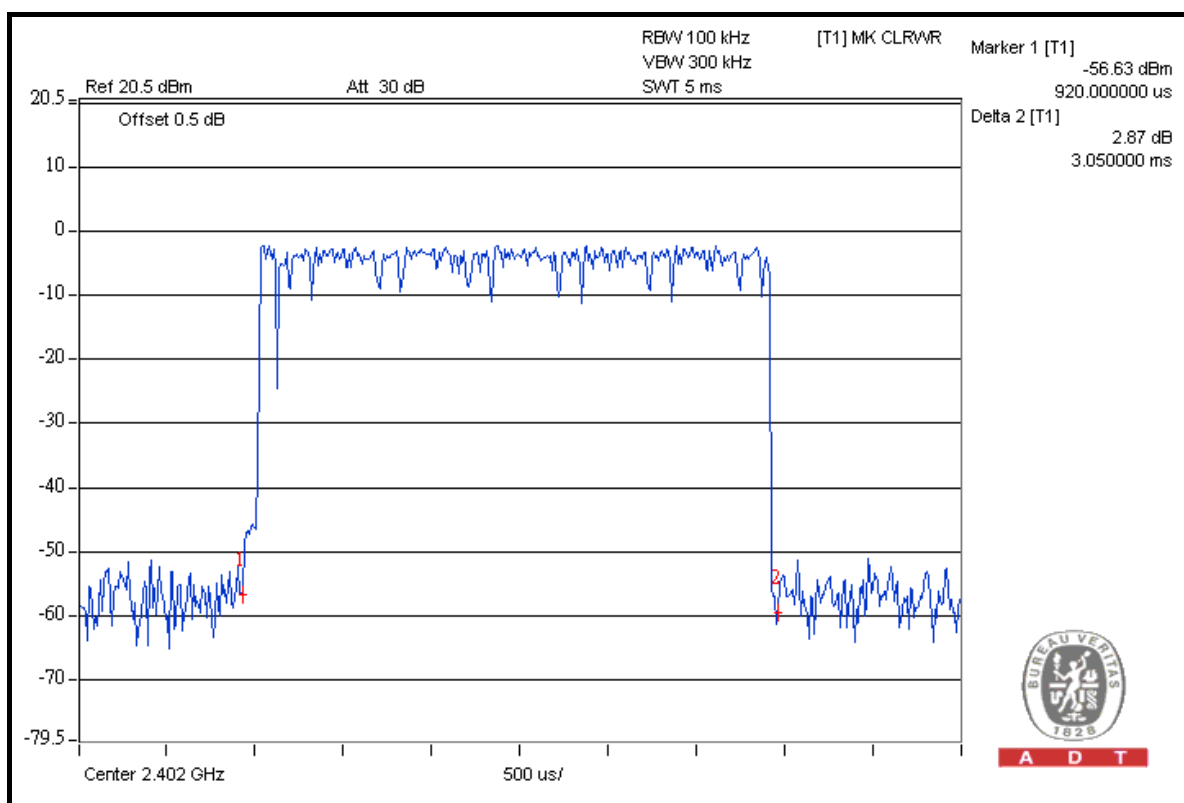

A D T



A D T

8DPSK

Mode	Number of transmission in a 31.6 (79Hopping*0.4)	Length of transmission time (msec)	Result (msec)	Limit (msec)
DH1	$50 \text{ (times / 5 sec)} * 6.32 = 316.00 \text{ times}$	0.498	157.368	400
DH3	$25 \text{ (times / 5 sec)} * 6.32 = 158.00 \text{ times}$	1.782	281.556	400
DH5	$16 \text{ (times / 5 sec)} * 6.32 = 101.12 \text{ times}$	2.980	301.338	400

NOTE: Test plots of the transmitting time slot are shown on next 3 pages.



A D T

DH1

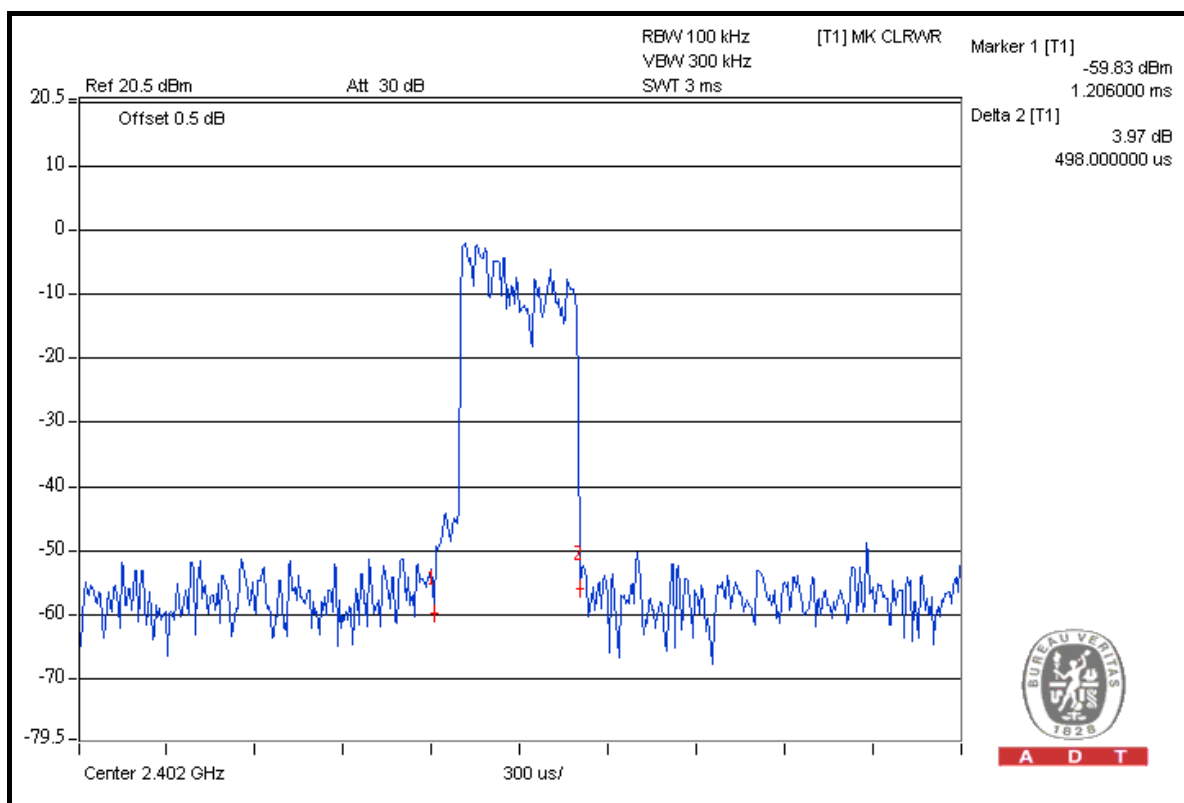
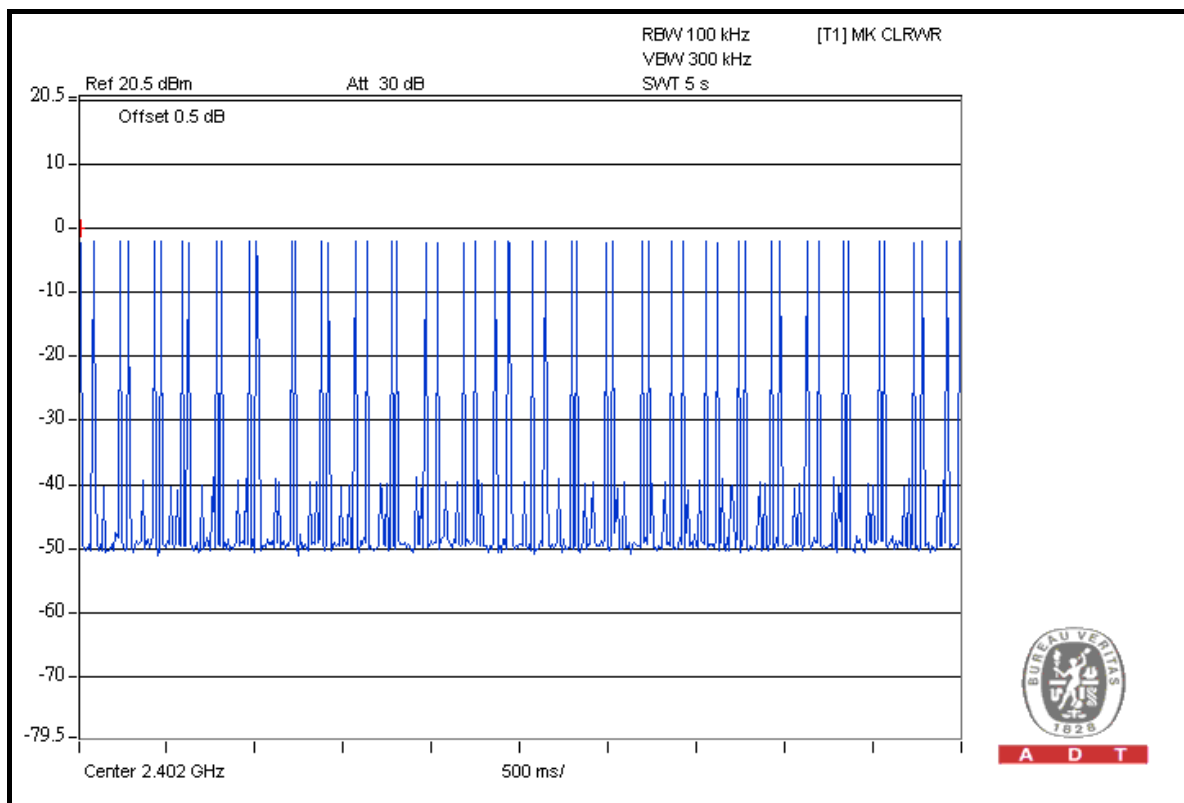



A D T

DH3

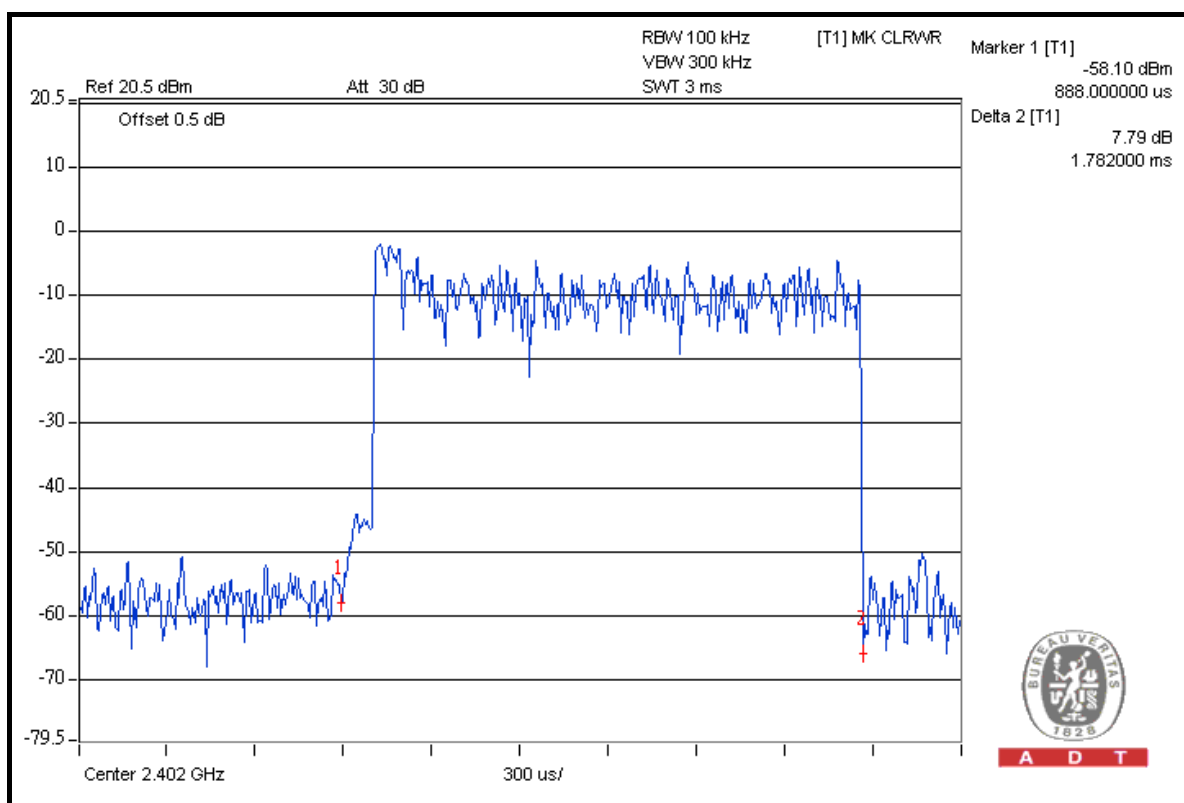
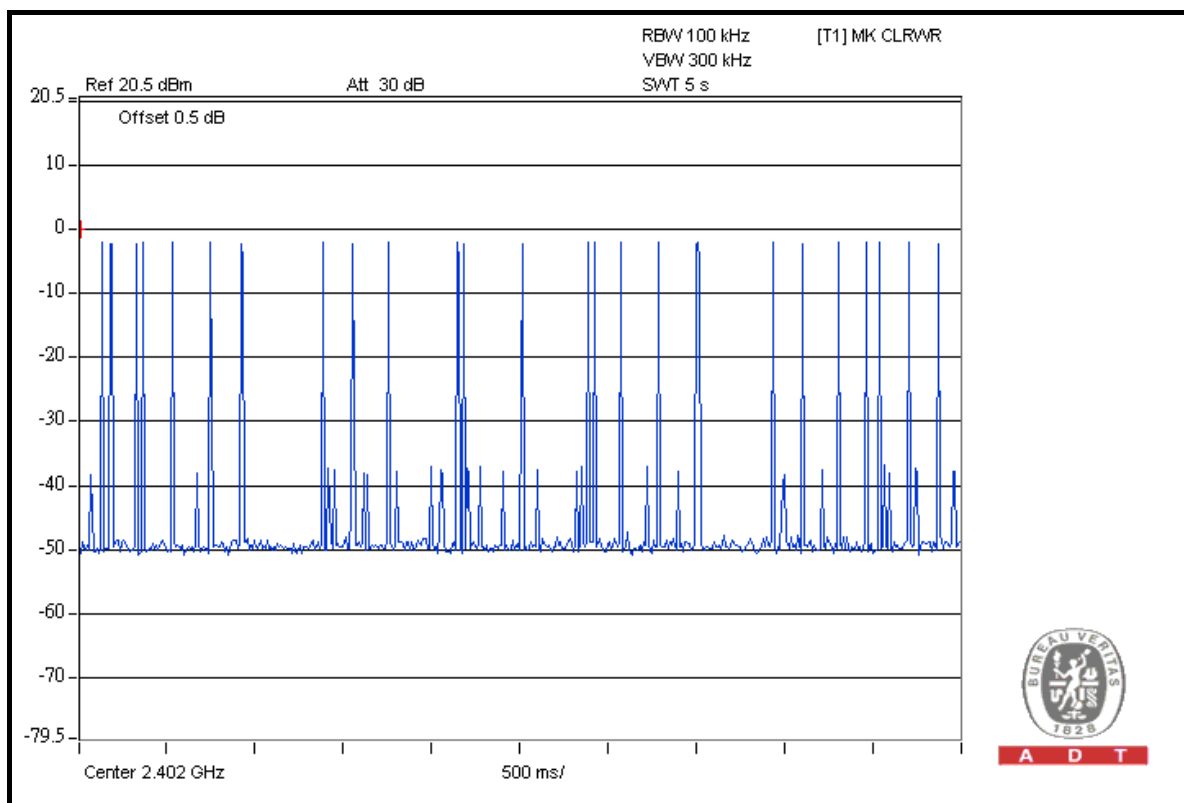



A D T

DH5

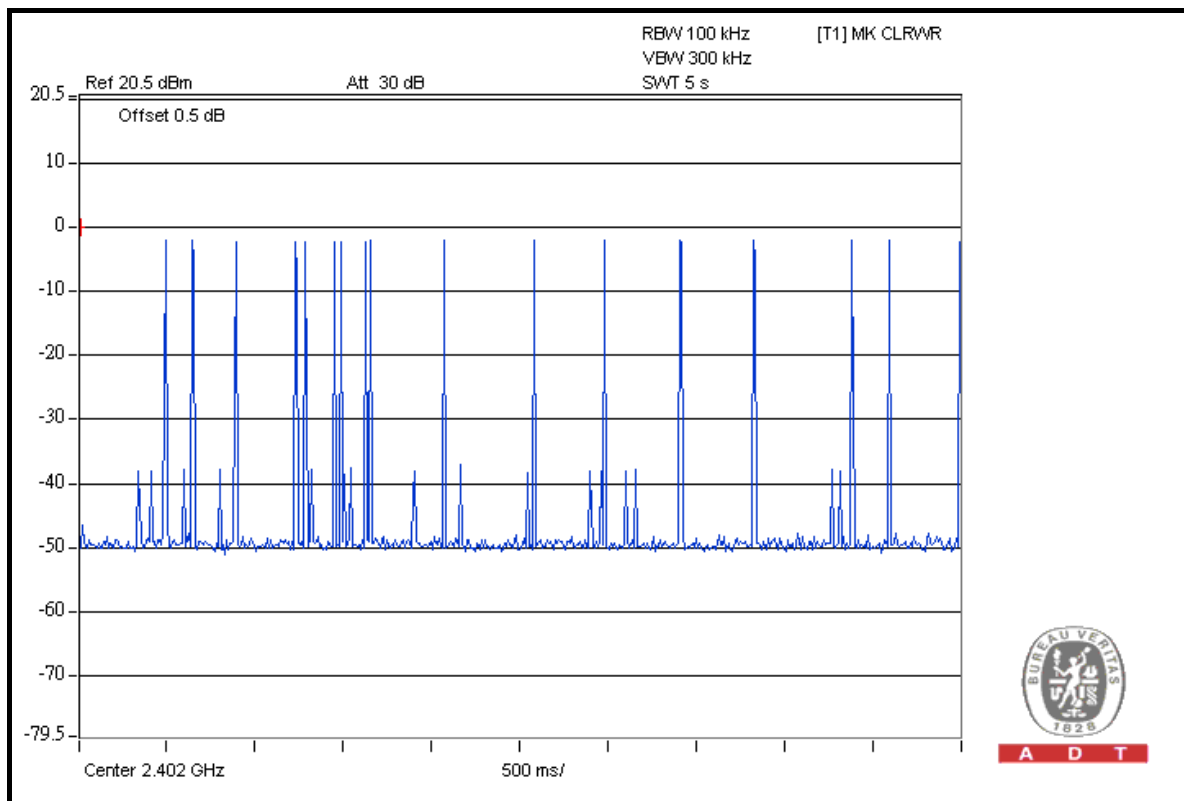

A D T

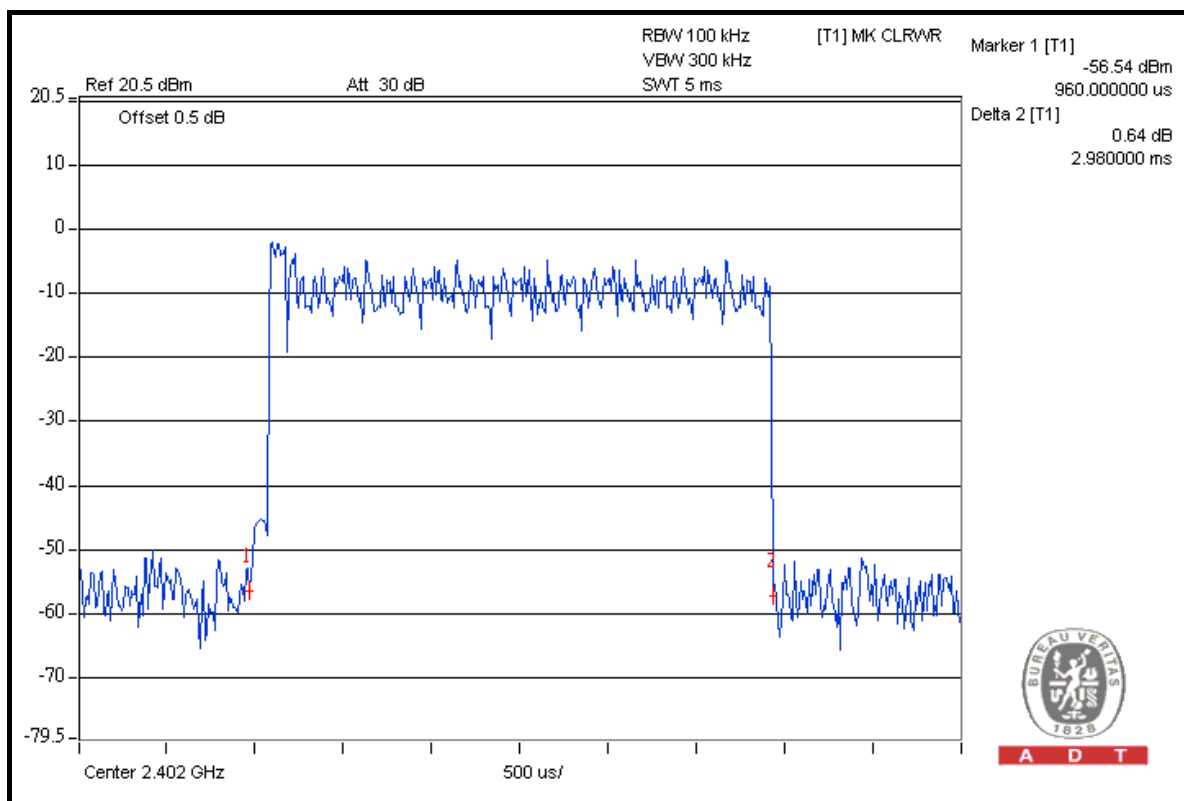

A D T

4.5 CHANNEL BANDWIDTH

4.5.1 LIMITS OF CHANNEL BANDWIDTH

For frequency hopping system operating in the 2400-2483.5MHz, If the 20dB bandwidth of hopping channel is greater than 25kHz, two-thirds 20dB bandwidth of hopping channel shall be a minimum limit for the hopping channel separation.

4.5.2 TEST INSTRUMENTS

DESCRIPTION & MANUFACTURER	MODEL NO.	SERIAL NO.	DATE OF CALIBRATION	DUE DATE OF CALIBRATION
R&S SPECTRUM ANALYZER	FSP40	100039	Jan. 11, 2010	Jan. 10, 2011

NOTE: The calibration interval of the above test instruments is 12 months and the calibrations are traceable to NML/ROC and NIST/USA.

4.5.3 TEST PROCEDURE

- a. Check the calibration of the measuring instrument using either an internal calibrator or a known signal from an external generator.
- b. Turn on the EUT and connect it to measurement instrument. Then set it to any one convenient frequency within its operating range. Set a reference level on the measuring instrument equal to the highest peak value.
- c. Measure the frequency difference of two frequencies that were attenuated 20dB from the reference level. Record the frequency difference as the emission bandwidth.
- d. Repeat above procedures until all frequencies measured were complete.

4.5.4 DEVIATION FROM TEST STANDARD

No deviation.

4.5.5 TEST SETUP

Same as 4.3.5.

4.5.6 EUT OPERATING CONDITION

The software provided by client enabled the EUT to transmit and receive data at lowest, middle and highest channel frequencies individually.

4.5.7 TEST RESULTS

GFSK

CHANNEL	CHANNEL FREQUENCY (MHz)	20dB BANDWIDTH (MHz)
0	2402	0.929
39	2441	0.930
78	2480	0.935

CH 78

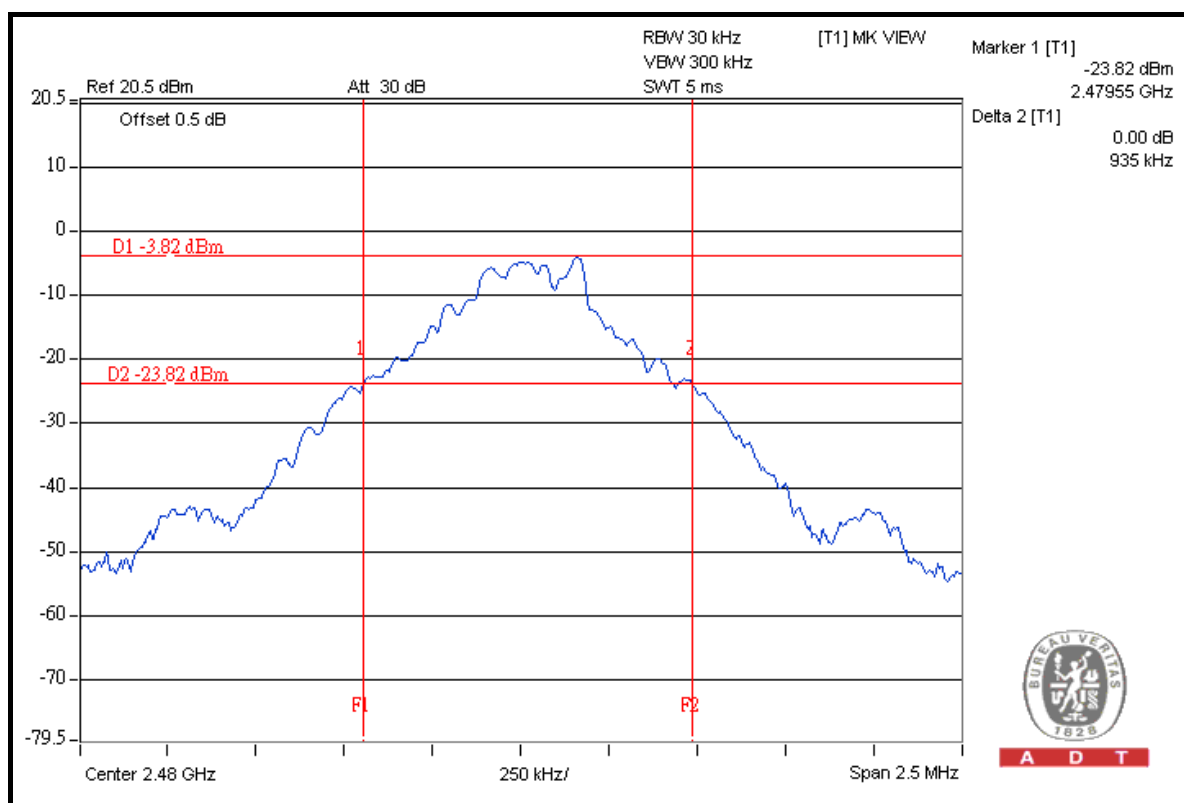



A D T

8DPSK

CHANNEL	CHANNEL FREQUENCY (MHz)	20dB BANDWIDTH (MHz)
0	2402	1.300
39	2441	1.300
78	2480	1.300

CH 0

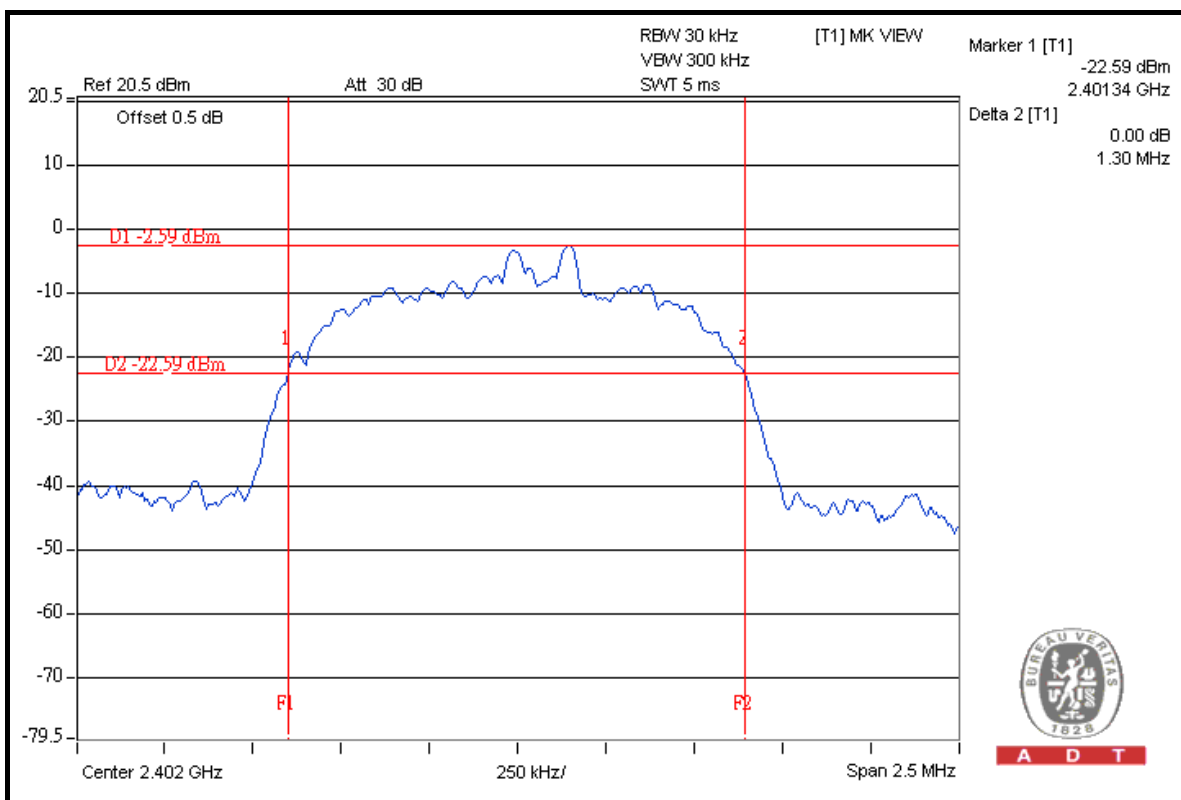

4.6 HOPPING CHANNEL SEPARATION

4.6.1 LIMIT OF HOPPING CHANNEL SEPARATION

At least 25kHz or two-third of 20dB hopping channel bandwidth (whichever is greater).

4.6.2 TEST INSTRUMENTS

DESCRIPTION & MANUFACTURER	MODEL NO.	SERIAL NO.	DATE OF CALIBRATION	DUE DATE OF CALIBRATION
R&S SPECTRUM ANALYZER	FSP40	100039	Jan. 11, 2010	Jan. 10, 2011

NOTE: The calibration interval of the above test instruments is 12 months and the calibrations are traceable to NML/ROC and NIST/USA.

4.6.3 TEST PROCEDURES

1. Check the calibration of the measuring instrument using either an internal calibrator or a known signal from an external generator.
2. Turn on the EUT and connect it to measurement instrument. Then set it to any one convenient frequency within its operating range.
3. By using the MaxHold function record the separation of two adjacent channels.
4. Measure the frequency difference of these two adjacent channels by SA MARK function. And then plot the result on SA screen.
5. Repeat above procedures until all frequencies measured were complete.

4.6.4 DEVIATION FROM TEST STANDARD

No deviation.

4.6.5 TEST SETUP

Same as 4.3.5.

4.6.6 TEST RESULTS

GFSK

CHANNEL	FREQUENCY (MHz)	ADJACENT CHANNEL SEPARATION (MHz)	20dB BANDWIDTH (MHz)	MINIMUM LIMIT (MHz)	PASS / FAIL
0	2402	1.000	0.929	0.619	PASS
39	2441	1.000	0.930	0.620	PASS
78	2480	1.000	0.935	0.623	PASS

NOTE: The minimum limit is two-third 20dB bandwidth. Test results please refer to next two pages.

CH 0

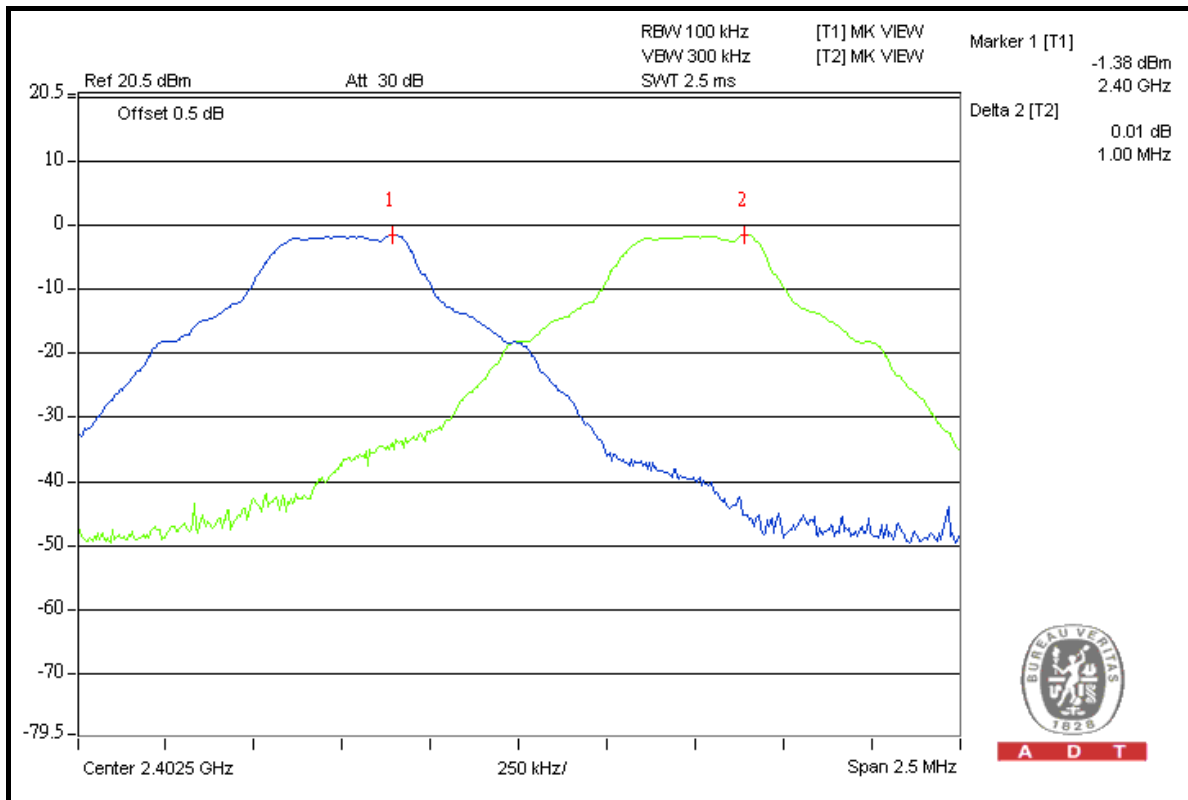



A D T

8DPSK

CHANNEL	FREQUENCY (MHz)	ADJACENT CHANNEL SEPARATION (MHz)	20dB BANDWIDTH (MHz)	MINIMUM LIMIT (MHz)	PASS / FAIL
0	2402	1.000	1.300	0.867	PASS
39	2441	1.000	1.300	0.867	PASS
78	2480	1.000	1.300	0.867	PASS

NOTE: The minimum limit is two-third 20dB bandwidth. Test results please refer to next two pages.

CH 0

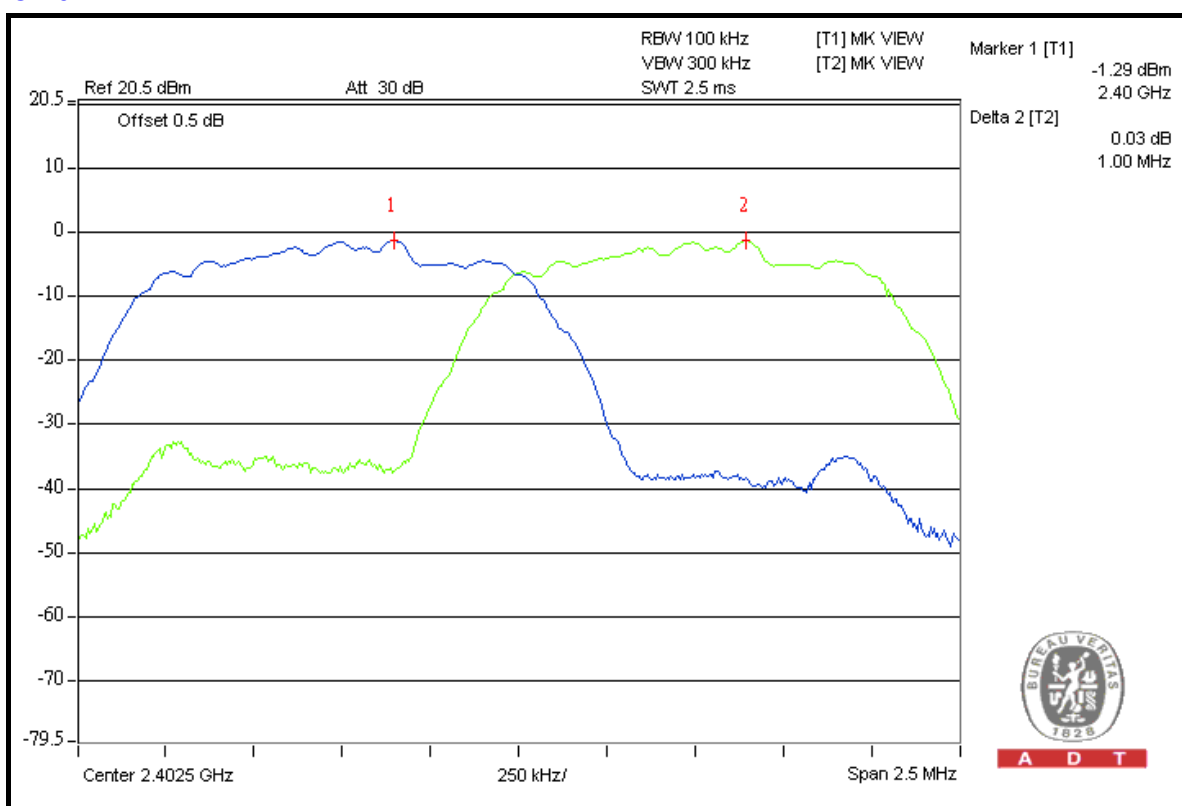

A D T

4.7 MAXIMUM OUTPUT POWER

4.7.1 LIMITS OF MAXIMUM OUTPUT POWER MEASUREMENT

The Maximum Peak Output Power Measurement is 125mW.

4.7.2 TEST INSTRUMENTS

DESCRIPTION & MANUFACTURER	MODEL NO.	SERIAL NO.	DATE OF CALIBRATION	DUE DATE OF CALIBRATION
R&S SPECTRUM ANALYZER	FSP40	100039	Jan. 11, 2010	Jan. 10, 2011

NOTE: The calibration interval of the above test instruments is 12 months and the calibrations are traceable to NML/ROC and NIST/USA.

4.7.3 TEST PROCEDURES

- a. Check the calibration of the measuring instrument using either an internal calibrator or a known signal from an external generator.
- b. Turn on the EUT and connect it to measurement instrument. Then set it to any one convenient frequency within its operating range. Set a reference level on the measuring instrument equal to the highest peak value.
- c. The center frequency of the spectrum analyzer is set to the fundamental frequency and using 3MHz RBW and 10 MHz VBW.
- d. Measure the captured power within the band and recording the plot.
- e. Repeat above procedures until all frequencies required were complete.

4.7.4 DEVIATION FROM TEST STANDARD

No deviation.

4.7.5 TEST SETUP

Same as 4.3.5.

4.7.6 EUT OPERATING CONDITION

The software provided by client enabled the EUT to transmit and receive data at lowest, middle and highest channel frequencies individually.

4.7.7 TEST RESULTS

GFSK

CHANNEL	CHANNEL FREQUENCY (MHz)	POWER OUTPUT (mW)	POWER OUTPUT (dBm)	POWER LIMIT (mW)	PASS/FAIL
0	2402	0.8	-0.9	125	PASS
39	2441	0.7	-1.4	125	PASS
78	2480	0.7	-1.9	125	PASS

CH 0

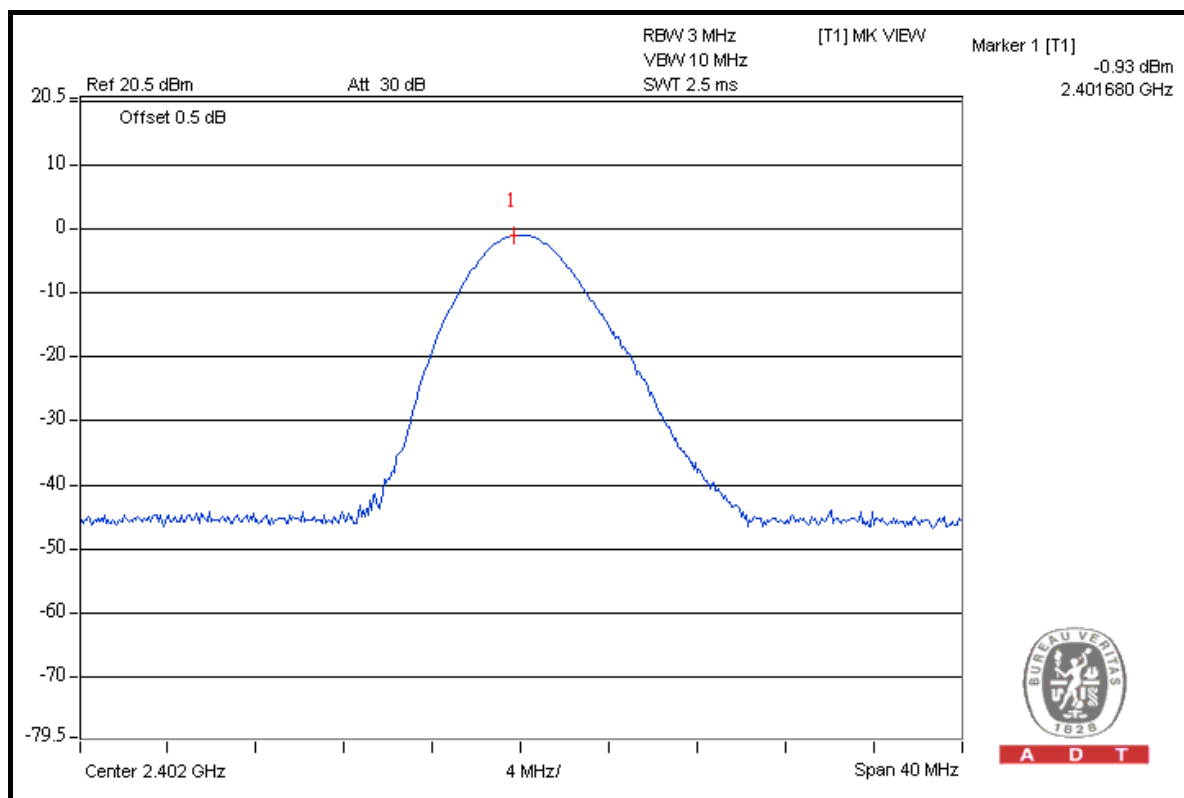



A D T

8DPSK

CHANNEL	CHANNEL FREQUENCY (MHz)	POWER OUTPUT (mW)	POWER OUTPUT (dBm)	POWER LIMIT (mW)	PASS/FAIL
0	2402	1.3	1.2	125	PASS
39	2441	1.2	0.8	125	PASS
78	2480	1.1	0.2	125	PASS

CH 0

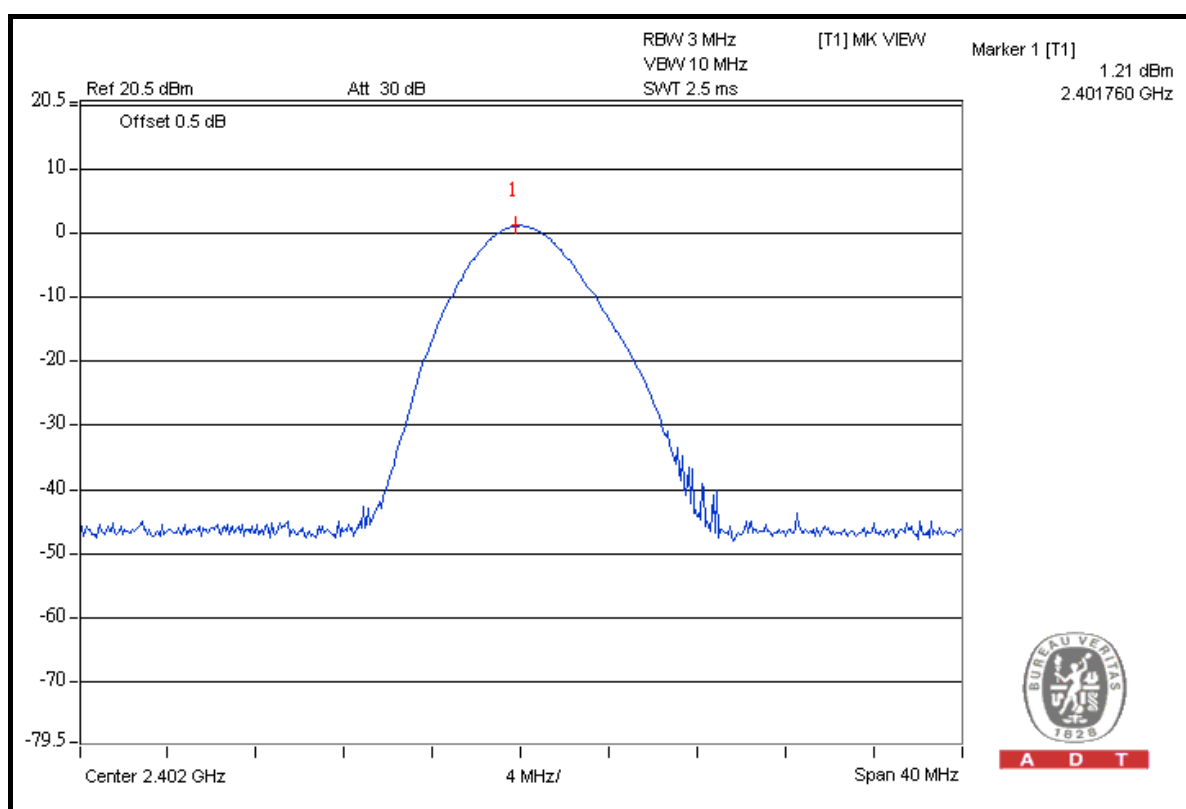

4.8 BAND EDGES MEASUREMENT

4.8.1 LIMITS OF BAND EDGES MEASUREMENT

Below -20dB of the highest emission level of operating band (in 100KHz RBW).

4.8.2 TEST INSTRUMENTS

DESCRIPTION & MANUFACTURER	MODEL NO.	SERIAL NO.	DATE OF CALIBRATION	DUE DATE OF CALIBRATION
R&S SPECTRUM ANALYZER	FSP40	100039	Jan. 11, 2010	Jan. 10, 2011

NOTE: The calibration interval of the above test instruments is 12 months and the calibrations are traceable to NML/ROC and NIST/USA.

4.8.3 TEST PROCEDURE

The transmitter output was connected to the spectrum analyzer via a low lose cable. Set both RBW and VBW of spectrum analyzer to 100 kHz with suitable frequency span including 100 MHz bandwidth from band edge. The band edges was measured and recorded.

4.8.4 DEVIATION FROM TEST STANDARD

No deviation.

4.8.5 EUT OPERATING CONDITION

The software provided by client enabled the EUT to transmit and receive data at lowest and highest channel frequencies individually.

4.8.6 TEST RESULTS

The spectrum plots are attached on the following images. D1 line indicates the highest level, D2 line indicates the 20dB offset below D1. It shows compliance with the requirement in part 15.247(d).

GFSK

RESTRICT BAND (2310 ~ 2390 MHz)

FREQUENCY (MHz)	FUNDAMENTAL EMISSION (dBuV/m)	DELTA (dB)	MAXIMUM FIELD STRENGTH IN RESTRICT BAND (dBuV/m)	LIMIT (dBuV/m)
2402.00 (PK)	93.5	45.78	47.72	74.00
2402.00 (AV)	-	-	17.62	54.00

RESTRICT BAND (2483.5 ~ 2500 MHz)

FREQUENCY (MHz)	FUNDAMENTAL EMISSION (dBuV/m)	DELTA (dB)	MAXIMUM FIELD STRENGTH IN RESTRICT BAND (dBuV/m)	LIMIT (dBuV/m)
2480.00 (PK)	92.50	44.71	47.79	74.00
2480.00 (AV)	-	-	17.69	54.00

NOTE:

1. Delta = Amplitude between the peak of the fundamental and the peak of the band edge emission. Please check following 2 pages.
2. Maximum field strength in restrict band (PK value) = Fundamental emission (PK value) – Delta.
3. Average value = Peak value + 20 Log (duty cycle) = Peak value – 30.1dB.
4. The DH5 packet was the worse case duty cycle for a transmit dwell time on a channel, based upon Bluetooth theory the transmitter is on 0.625 * 5 per 296.25 ms per channel. Therefore, the duty cycle correction factor be equal to: $20\log(3.125/100) = -30.1$ dB.



A D T

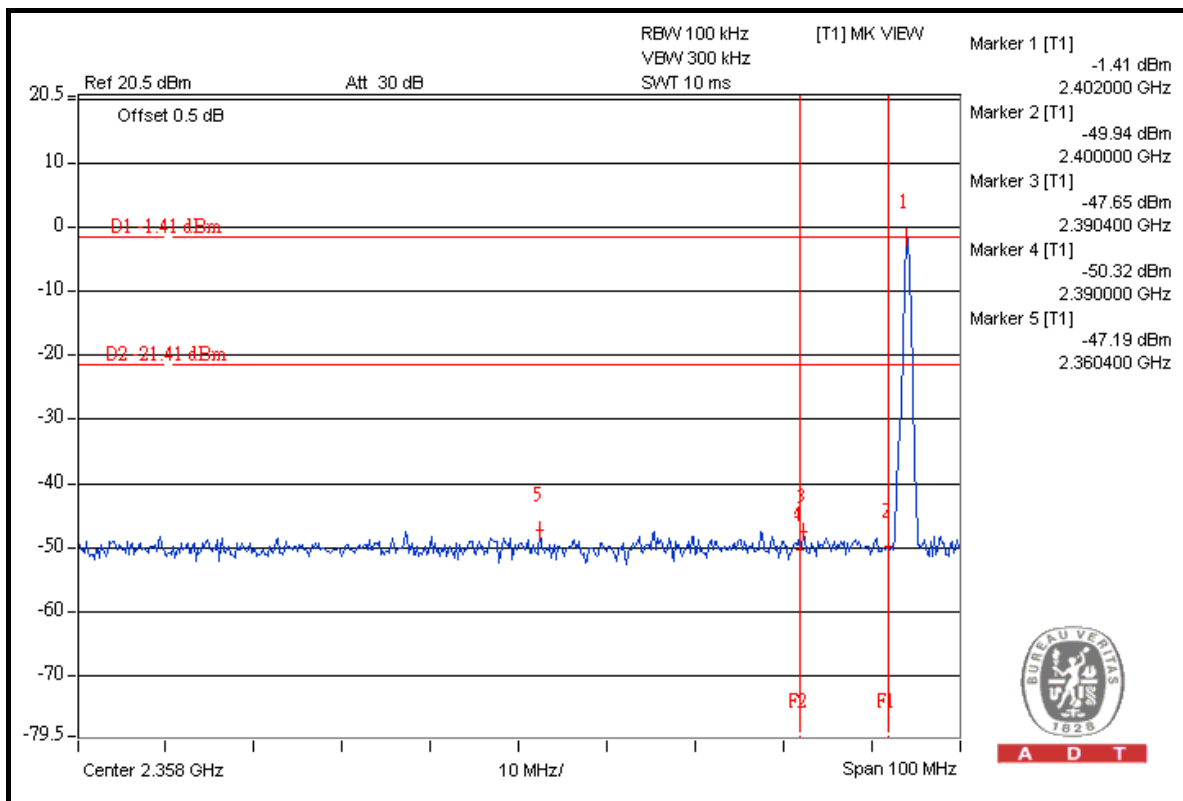

A D T

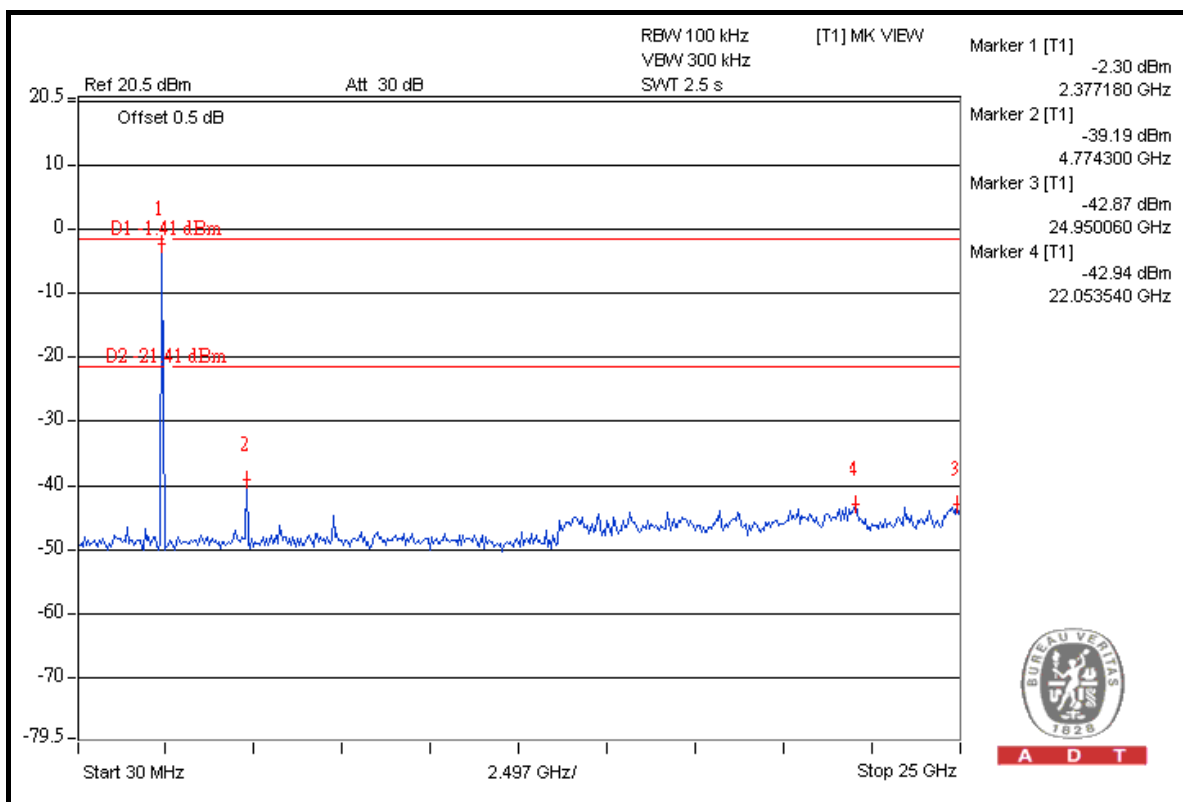

A D T



A D T

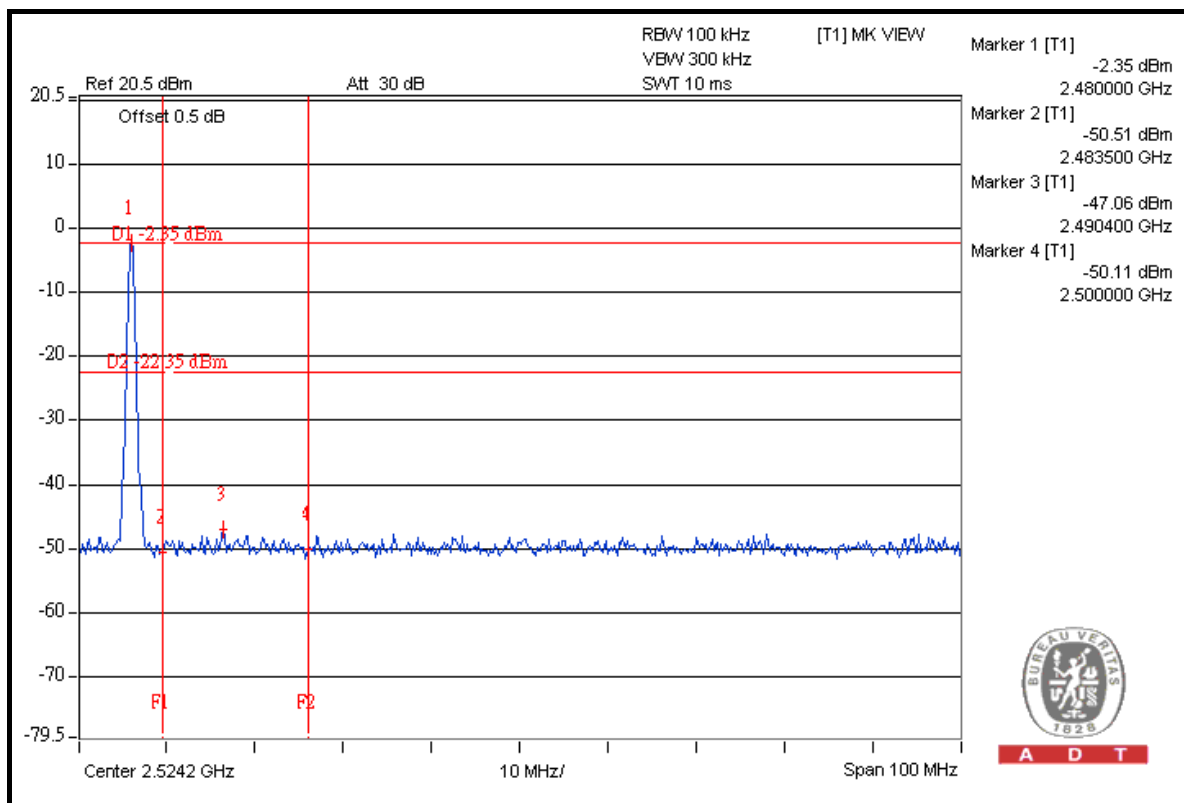

A D T

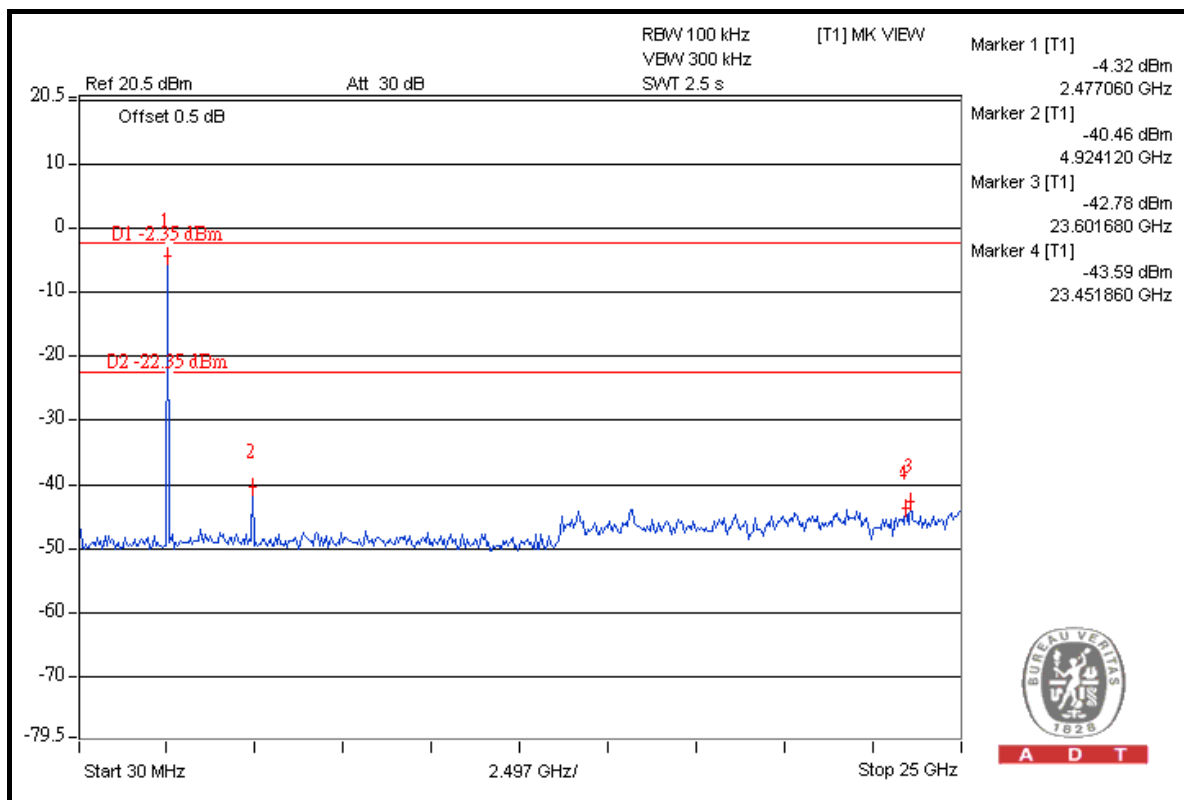

A D T

8DPSK

RESTRICT BAND (2310 ~ 2390 MHz)

FREQUENCY (MHz)	FUNDAMENTAL EMISSION (dBuV/m)	DELTA (dB)	MAXIMUM FIELD STRENGTH IN RESTRICT BAND (dBuV/m)	LIMIT (dBuV/m)
2402.00 (PK)	93.3	44.27	49.03	74.00
2402.00 (AV)	-	-	18.93	54.00

RESTRICT BAND (2483.5 ~ 2500 MHz)

FREQUENCY (MHz)	FUNDAMENTAL EMISSION (dBuV/m)	DELTA (dB)	MAXIMUM FIELD STRENGTH IN RESTRICT BAND (dBuV/m)	LIMIT (dBuV/m)
2480.00 (PK)	94.2	43.94	50.26	74.00
2480.00 (AV)	-	-	20.16	54.00

NOTE:

1. Delta = Amplitude between the peak of the fundamental and the peak of the band edge emission. Please check following 2 pages.
2. Maximum field strength in restrict band (PK value) = Fundamental emission (PK value) – Delta.
3. Average value = Peak value + 20 Log (duty cycle) = Peak value – 30.1dB.
4. The DH5 packet was the worse case duty cycle for a transmit dwell time on a channel, based upon Bluetooth theory the transmitter is on 0.625 * 5 per 296.25 ms per channel. Therefore, the duty cycle correction factor be equal to: $20\log(3.125/100) = -30.1$ dB.



A D T

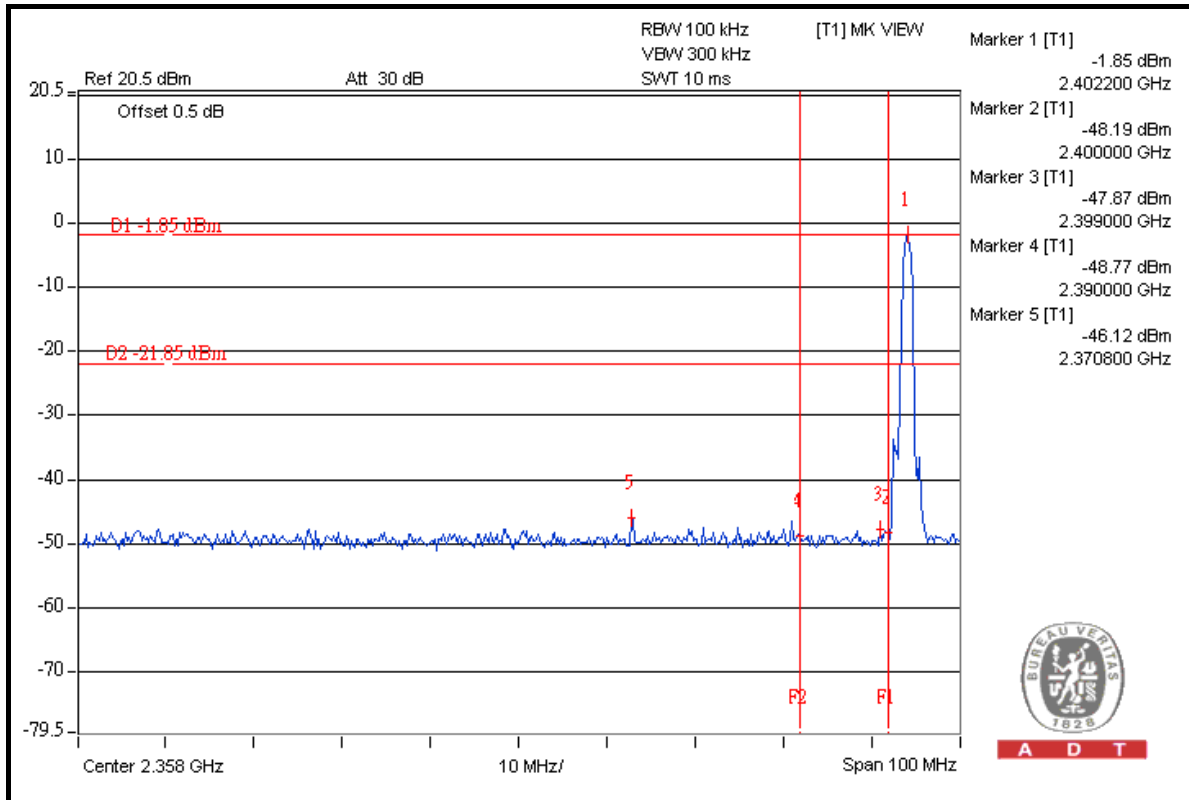

A D T

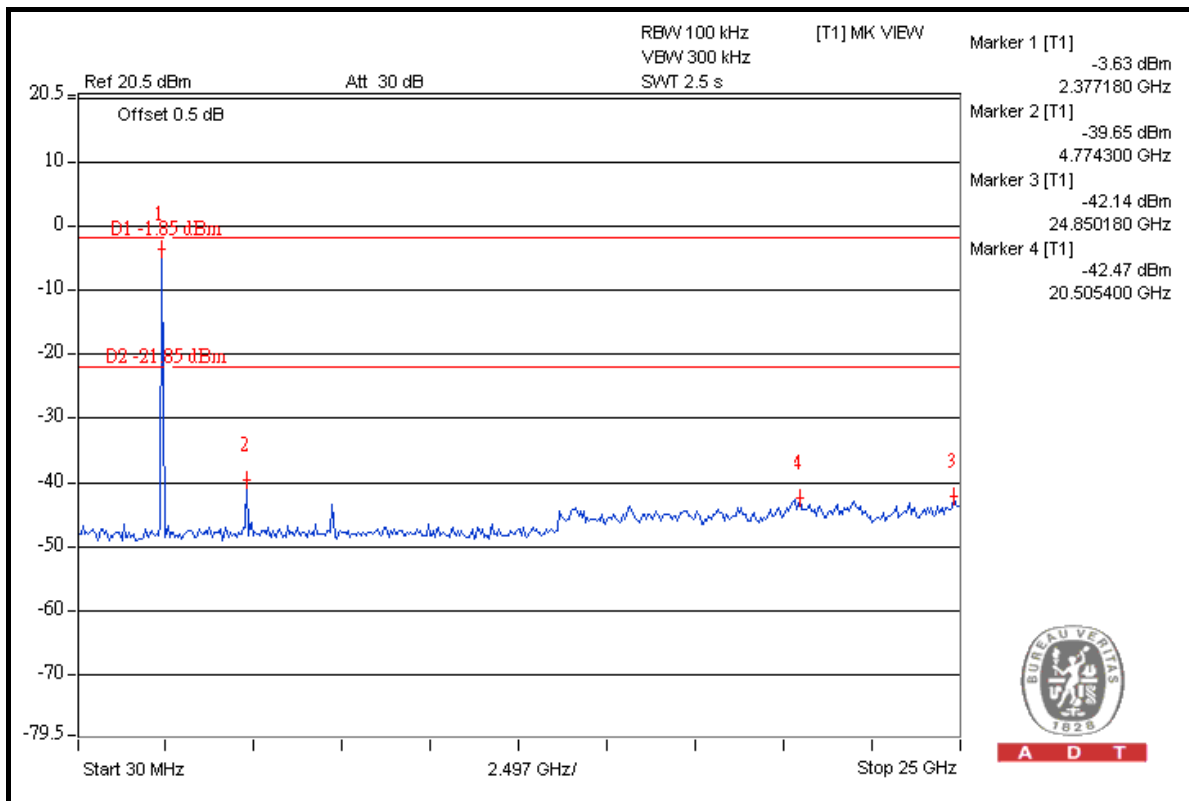

A D T



A D T

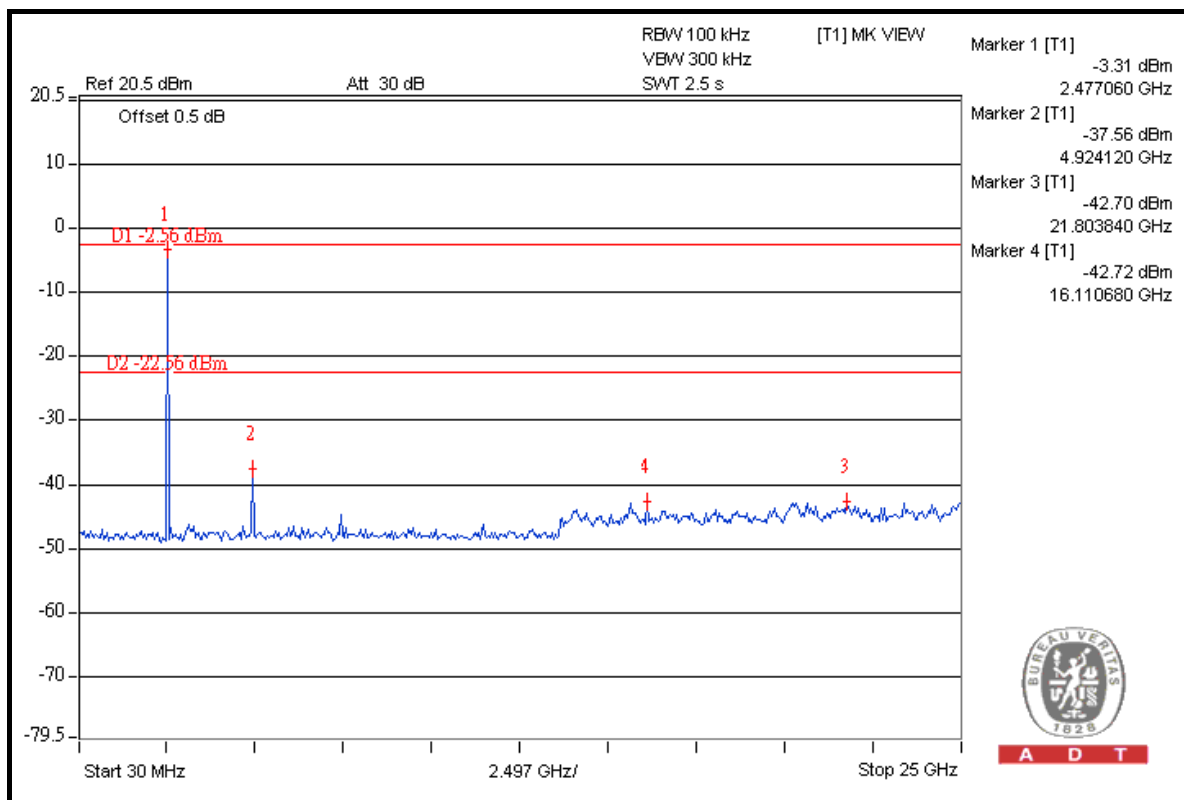
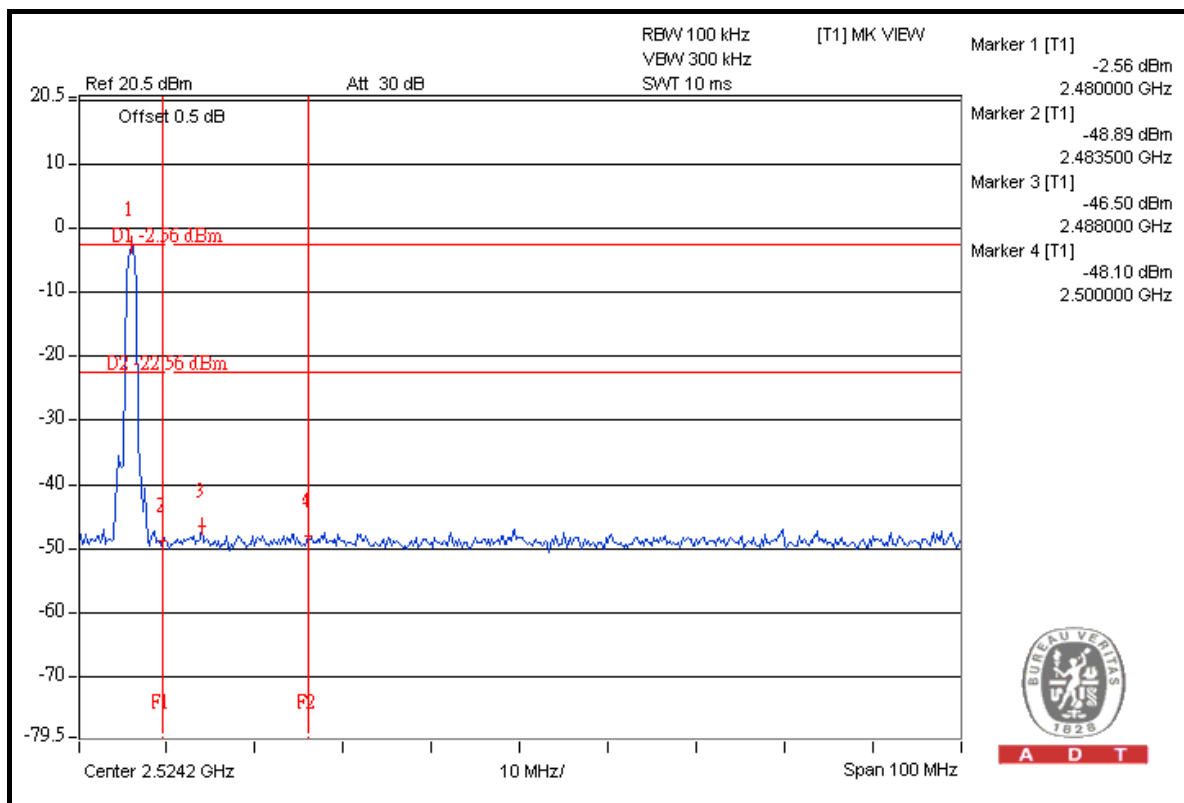

5. PHOTOGRAPHS OF THE TEST CONFIGURATION

Please refer to the attached file (Test Setup Photo).

6. INFORMATION ON THE TESTING LABORATORIES

We, Bureau Veritas Consumer Products Services (H.K.) Ltd., Taoyuan Branch, were founded in 1988 to provide our best service in EMC, Radio, Telecom and Safety consultation. Our laboratories are accredited and approved according to ISO/IEC 17025.

Copies of accreditation certificates of our laboratories obtained from approval agencies can be downloaded from our web site:

www.adt.com.tw/index.5/phtml. If you have any comments, please feel free to contact us at the following:

Linko EMC/RF Lab:

Tel: 886-2-26052180

Fax: 886-2-26051924

Hsin Chu EMC/RF Lab:

Tel: 886-3-5935343

Fax: 886-3-5935342

Hwa Ya EMC/RF/Safety Telecom Lab:

Tel: 886-3-3183232

Fax: 886-3-3185050

Web Site: www.adt.com.tw

The address and road map of all our labs can be found in our web site also.

7. APPENDIX A - MODIFICATIONS RECORDERS FOR ENGINEERING CHANGES TO THE EUT BY THE LAB

No any modifications are made to the EUT by the lab during the test.

--- END ---