



A D T

FCC TEST REPORT

(Part 24)

REPORT NO.: RF990819C03-3

MODEL NO.: Algiz7;Algiz7-XXX (X=A~Z , a~z , 0 ~9 , Blank or Slash)
(refer to item 3.1 for more detail)

FCC ID: YY3-01120709267

RECEIVED: Aug. 19, 2010

TESTED: Sep. 07 ~ Oct. 18, 2010

ISSUED: Feb. 08, 2011

APPLICANT: HHCS HANDHELD COMPUTER SPECIALISTS
AB

ADDRESS: Kinnegatan 17 A,S-531 33 Lidkoping,Sweden

ISSUED BY: Bureau Veritas Consumer Products Services
(H.K.) Ltd., Taoyuan Branch

LAB ADDRESS: No. 47, 14th Ling, Chia Pau Tsuen, Lin Kou
Hsiang, Taipei Hsien 244, Taiwan, R.O.C.

TEST LOCATION: No. 19, Hwa Ya 2nd Rd, Wen Hwa Tsuen, Kwei
Shan Hsiang, Taoyuan Hsien 333, Taiwan, R.O.C.

This test report consists of 92 pages in total. It may be duplicated completely for legal use with the approval of the applicant. It should not be reproduced except in full, without the written approval of our laboratory. The client should not use it to claim product endorsement by TAF or any government agencies. The test results in the report only apply to the tested sample.



TABLE OF CONTENTS

RELEASE CONTROL RECORD.....	4
1 CERTIFICATION	5
2 SUMMARY OF TEST RESULTS	6
2.1 MEASUREMENT UNCERTAINTY	6
3 GENERAL INFORMATION.....	7
3.1 GENERAL DESCRIPTION OF EUT	7
3.2 DESCRIPTION OF TEST MODES.....	9
3.2.1 CONFIGURATION OF SYSTEM UNDER TEST	10
3.2.2 TEST MODE APPLICABILITY AND TESTED CHANNEL DETAIL	11
3.3 GENERAL DESCRIPTION OF APPLIED STANDARDS	17
3.4 DESCRIPTION OF SUPPORT UNITS	17
4 TEST TYPES AND RESULTS	18
4.1 OUTPUT POWER MEASUREMENT	18
4.1.1 LIMITS OF OUTPUT POWER MEASUREMENT	18
4.1.2 TEST INSTRUMENTS.....	19
4.1.3 TEST PROCEDURES	20
4.1.4 TEST SETUP.....	21
4.1.5 EUT OPERATING CONDITIONS	21
4.1.6 TEST RESULTS	22
4.2 FREQUENCY STABILITY MEASUREMENT.....	30
4.2.1 LIMITS OF FREQUENCY STABILITY MEASUREMENT	30
4.2.2 TEST INSTRUMENTS.....	30
4.2.3 TEST PROCEDURE.....	31
4.2.4 TEST SETUP.....	31
4.2.5 TEST RESULTS	32
4.3 OCCUPIED BANDWIDTH MEASUREMENT	35
4.3.1 LIMITS OF OCCUPIED BANDWIDTH MEASUREMENT	35
4.3.2 TEST INSTRUMENTS.....	35
4.3.3 TEST SETUP.....	35
4.3.4 TEST PROCEDURES	36
4.3.5 EUT OPERATING CONDITION	36
4.3.6 TEST RESULTS	37
4.4 BAND EDGE MEASUREMENT.....	45
4.4.1 LIMITS OF BAND EDGE MEASUREMENT	45
4.4.2 TEST INSTRUMENTS.....	45
4.4.3 TEST SETUP.....	45
4.4.4 TEST PROCEDURES	46
4.4.5 EUT OPERATING CONDITION	46
4.4.6 TEST RESULTS	47
4.5 CONDUCTED SPURIOUS EMISSIONS	55
4.5.1 LIMITS OF CONDUCTED SPURIOUS EMISSIONS MEASUREMENT	55
4.5.2 TEST INSTRUMENTS.....	55
4.5.3 TEST PROCEDURE.....	56
4.5.4 TEST SETUP.....	56
4.5.5 EUT OPERATING CONDITIONS	56
4.5.6 TEST RESULTS	57
4.6 RADIATED EMISSION MEASUREMENT (BELOW 1GHz).....	72
4.6.1 LIMITS OF RADIATED EMISSION MEASUREMENT	72



A D T

4.6.2	TEST INSTRUMENTS.....	72
4.6.3	TEST PROCEDURES	73
4.6.4	DEVIATION FROM TEST STANDARD	73
4.6.5	TEST SETUP.....	74
4.6.6	EUT OPERATING CONDITIONS	74
4.6.7	TEST RESULTS	75
4.7	RADIATED EMISSION MEASUREMENT (ABOVE 1GHz)	78
4.7.1	LIMITS OF RADIATED EMISSION MEASUREMENT	78
4.7.2	TEST INSTRUMENTS.....	78
4.7.3	TEST PROCEDURES	79
4.7.4	DEVIATION FROM TEST STANDARD	79
4.7.5	TEST SETUP.....	80
4.7.6	EUT OPERATING CONDITIONS	80
4.7.7	TEST RESULTS	81
5	PHOTOGRAPHS OF THE TEST CONFIGURATION.....	90
6	INFORMATION ON THE TESTING LABORATORIES	91
7	APPENDIX A – MODIFICATIONS RECORDERS FOR ENGINEERING CHANGES TO THE EUT BY THE LAB	92



RELEASE CONTROL RECORD

ISSUE NO.	REASON FOR CHANGE	DATE ISSUED
Original release	N/A	Feb. 08, 2011



1 CERTIFICATION

PRODUCT: 7 Rugged Tablet PC

MODEL: Algiz7;Algiz7-XXX (X=A~Z , a~z , 0 ~9 , Blank or Slash)
(refer to item 3.1 for more detail)

BRAND: Handheld

APPLICANT: HHCS HANDHELD COMPUTER SPECIALISTS AB

TESTED: Sep. 07 ~ Oct. 18, 2010

TEST SAMPLE: ENGINEERING SAMPLE

TEST STANDARDS: **FCC Part 24, Subpart E**
ANSI C63.4-2003

The above equipment (model: Algiz7) has been tested by **Bureau Veritas Consumer Products Services (H.K.) Ltd., Taoyuan Branch**, and found compliance with the requirement of the above standards. The test record, data evaluation & Equipment Under Test (EUT) configurations represented herein are true and accurate accounts of the measurements of the sample's EMC characteristics under the conditions specified in this report.

PREPARED BY :  , DATE : Feb. 08, 2011
Andrea Hsia / Specialist

APPROVED BY :  , DATE : Feb. 08, 2011
Gary Chang / Assistant Manager

2 SUMMARY OF TEST RESULTS

The EUT has been tested according to the following specifications:

APPLIED STANDARD: FCC Part 24 & Part 2 / IC RSS-133			
STANDARD SECTION	TEST TYPE AND LIMIT	RESULT	REMARK
2.1046 24.232	Maximum Peak Output Power Limit: max. 2 watts e.i.r.p peak power	PASS	Meet the requirement of limit. Minimum passing margin is 33.00dBm at 1850.2MHz.
2.1055 24.235	Frequency Stability AFC Freq. Error vs. Voltage AFC Freq. Error vs. Temperature Limit: max. ± 2.5 ppm	PASS	Meet the requirement of limit.
2.1049 24.238(b)	Occupied Bandwidth	PASS	Meet the requirement of limit.
24.238(b)	Band Edge Measurements	PASS	Meet the requirement of limit.
2.1051 24.238	Conducted Spurious Emissions	PASS	Meet the requirement of limit.
2.1053 24.238	Radiated Spurious Emissions	PASS	Meet the requirement of limit. Minimum passing margin is -4.4dB at 3819.60MHz.

2.1 MEASUREMENT UNCERTAINTY

Where relevant, the following measurement uncertainty levels have been estimated for tests performed on the EUT as specified in CISPR 16-4-2:

MEASUREMENT	FREQUENCY	UNCERTAINTY
Conducted emissions	9kHz~30MHz	2.44 dB
Radiated emissions	30MHz ~ 200MHz	3.34 dB
	200MHz ~1000MHz	3.35 dB
	1GHz ~ 18GHz	2.26 dB
	18GHz ~ 40GHz	1.94 dB

This uncertainty represents an expanded uncertainty expressed at approximately the 95% confidence level using a coverage factor of $k=2$.



A D T

3 GENERAL INFORMATION

3.1 GENERAL DESCRIPTION OF EUT

EUT	7 Rugged Tablet PC	
MODEL NO.	Algiz7;Algiz7-XXX (X=A~Z , a~z , 0 ~9 , Blank or Slash)	
FCC ID	YY3-01120709267	
NOMINAL VOLTAGE	12Vdc (adapter) 7.4Vdc (Battery)	
MODULATION TYPE	GPRS, E-GPRS	GMSK, 8PSK
	CDMA	QPSK, OQPSK, HPSK
	WCDMA	BPSK
FREQUENCY RANGE	GPRS, E-GPRS	1850.2MHz ~ 1909.8MHz
	CDMA	1851.25MHz ~ 1908.75MHz
	WCDMA	1852.4MHz ~ 1907.6MHz
NUMBER OF CHANNEL	GPRS, E-GPRS	299
	CDMA	1151
	WCDMA	277
MAX. EIRP POWER	GPRS	1.9953Watt
	E-GPRS	0.8318Watt
	CDMA	0.7244Watt
	WCDMA	0.4467Watt
ANTENNA TYPE	Printed PCB antenna with 2.2288dBi gain	
I/O PORTS	Refer to user's manual	
DATA CABLE	NA	
ACCESSORY DEVICES	Adapter, Battery	

NOTE:

- The EUT is a 7 Rugged Tablet PC. The test data are separated into following test reports

	TEST STANDARD	REFERENCE REPORT
WLAN 802.11b/g/n	FCC Part 15, Subpart C	RF990819C03
BLUETOOTH	FCC Part 15, Subpart C	RF990819C03-1
GPRS/ CDMA/ WCDMA 850	FCC Part 22	RF990819C03-2
GPRS/ CDMA/ WCDMA 1900	FCC Part 24	RF990819C03-3

- The EUT was powered by the following adapter & battery:

ADAPTER	
BRAND:	EDAC
MODEL:	EA1050C-120
INPUT:	100-240Vac, 50/60Hz, 1.8A
OUTPUT:	12Vdc, 4.16A
POWER LINE:	AC: 1.8m non-shielded cable with one core DC: 1.8m shielded cable without core

BATTERY	
RATING:	7.4Vdc 2S1P, 2600mAh



A D T

3. The EUT has no voice function.
4. Hardware version: I983S
5. Software version: V3.0.1.6
6. The above EUT information was declared by manufacturer and for more detailed features description, please refer to the manufacturer's specifications or User's Manual.

3.2 DESCRIPTION OF TEST MODES

FOR GPRS & E-GPRS:

299 channels are provided to this EUT. Therefore, the low, middle and high channels are chosen for testing.

	CHANNEL	FREQUENCY	TX MODE
LOW	512	1850.2 MHz	GPRS, E-GPRS
MIDDLE	661	1880.0 MHz	GPRS, E-GPRS
HIGH	810	1909.8 MHz	GPRS, E-GPRS

NOTE:

1. Below 1 GHz, the channel 512, 661, and 810 were pre-tested in chamber. The channel 661 was chosen for final test.
2. Above 1 GHz, the channel 512, 661, and 810 were tested individually.
3. The worst case for final test is chosen when the power control level set 0.
4. The channel space is 0.2MHz.
5. The EUT is a GPRS class 10 device (Multislot class: 10, Mobile Terminal B), which provide 2 up-link. After pre-tested both functions, found up-link with 1 time slot is worse, therefore, test results of output power, frequency stability, occupied bandwidth and band edge tests came out from this.
6. The EUT is an E-GPRS class 10 device (Multislot class: 10, Mobile Terminal B), which provide 2 up-link. After pre-tested both functions, found up-link with 1 time slot is worse, therefore, test results of output power, frequency stability, occupied bandwidth and band edge tests came out from this.
7. The EUT has GPRS & E-GPRS functions. After pre-testing, GPRS function is the worst case for all the emission tests.

FOR CDMA:

1151 channels are provided to this EUT in the CDMA1900 band. Therefore, the low, middle and high channels are chosen for testing.

	CHANNEL	FREQUENCY	TX MODE
LOW	25	1851.25 MHz	SO55
MIDDLE	600	1880.00 MHz	SO55
HIGH	1175	1908.75 MHz	SO55

NOTE:

1. Below 1 GHz, the channel 25, 600 and 1175 were pre-tested in chamber. The channel 25 was the worst case and chosen for final test.
2. Above 1 GHz, the channel 25, 600 and 1175 were tested individually.
3. The channel space is 0.05MHz.
4. In this report, CDMA2000 (SO55) was the worst case for all test items, therefore, only the data was recorded in the following section.

FOR WCDMA:

277 channels are provided to this EUT. Therefore, the low, middle and high channels are chosen for testing.

	CHANNEL	FREQUENCY	TX MODE
LOW	9262	1852.4 MHz	WCDMA
MIDDLE	9400	1880.0 MHz	WCDMA
HIGH	9538	1907.6 MHz	WCDMA

NOTE:

1. Below 1 GHz, the channel 9262, 9400 and 9538 were pre-tested in chamber. The channel 9538 was chosen for final test.
2. Above 1 GHz, the channel 9262, 9400 and 9538 were tested individually.
3. The channel space is 0.2MHz.
4. WCDMA-RMC mode has been chosen for the worst case to do the final test and record.

3.2.1 CONFIGURATION OF SYSTEM UNDER TEST

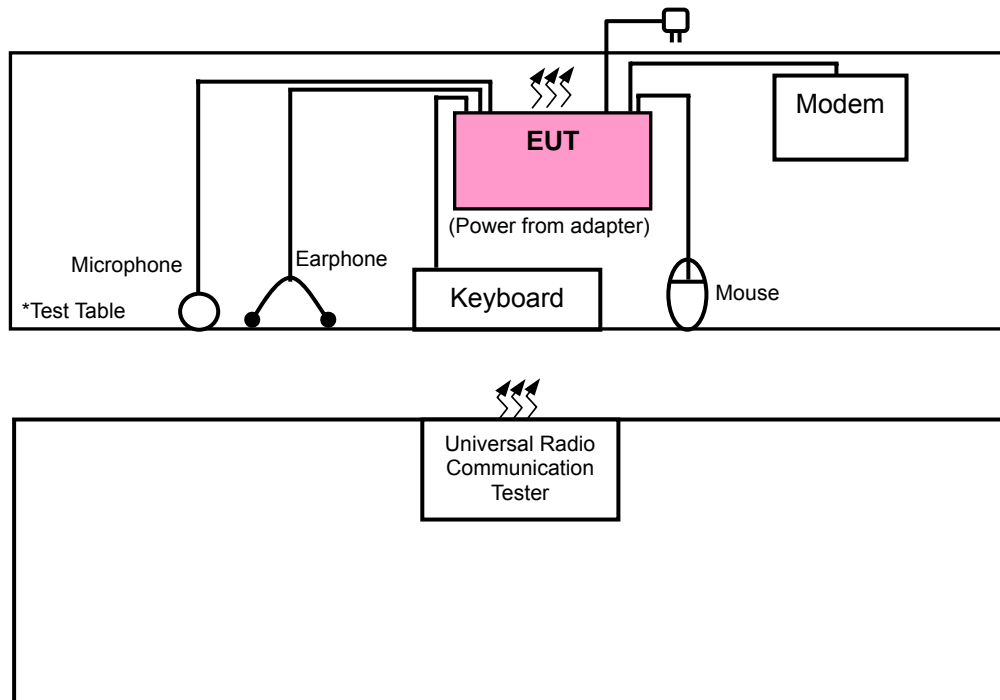

3.2.2 TEST MODE APPLICABILITY AND TESTED CHANNEL DETAIL

FOR GPRS & E-GPRS:

EUT CONFIGURE MODE	APPLICABLE TO							DESCRIPTION
	OP	FS	OB	BE	CE	RE<1G	RE≥1G	
-	√	√	√	√	√	√	√	-

Where

OP: Output power	FS: Frequency stability
OB: Occupied bandwidth	BE: Band edge
CE: Conducted spurious emissions	RE<1G: Radiated emission below 1GHz
RE≥1G: Radiated emission above 1GHz	

OUTPUT POWER MEASUREMENT:

- Pre-Scan has been conducted to determine the worst-case mode from all possible combinations between available modulations and antenna ports (if EUT with antenna diversity architecture).
- Following channel(s) was (were) selected for the final test as listed below.

AVAILABLE CHANNEL	TESTED CHANNEL	MODULATION TECHNOLOGY
512 to 810	512, 661, 810	GPRS, EGPRS

FREQUENCY STABILITY MEASUREMENT:

- Pre-Scan has been conducted to determine the worst-case mode from all possible combinations between available modulations and antenna ports (if EUT with antenna diversity architecture).
- Following channel(s) was (were) selected for the final test as listed below.

AVAILABLE CHANNEL	TESTED CHANNEL	MODULATION TECHNOLOGY
512 to 810	661	GPRS

OCCUPIED BANDWIDTH MEASUREMENT:

- This item includes all test value of each mode, but only includes spectrum plot of worst value of each mode.
- Pre-Scan has been conducted to determine the worst-case mode from all possible combinations between available modulations and antenna ports (if EUT with antenna diversity architecture).
- Following channel(s) was (were) selected for the final test as listed below.

AVAILABLE CHANNEL	TESTED CHANNEL	MODULATION TECHNOLOGY
512 to 810	512, 661, 810	GPRS, EGPRS

BAND EDGE MEASUREMENT:

- Pre-Scan has been conducted to determine the worst-case mode from all possible combinations between available modulations and antenna ports (if EUT with antenna diversity architecture).
- Following channel(s) was (were) selected for the final test as listed below.

AVAILABLE CHANNEL	TESTED CHANNEL	MODULATION TECHNOLOGY
512 to 810	512, 810	GPRS, EGPRS



CONDUCTED SPURIOUS EMISSIONS MEASUREMENT:

- Pre-Scan has been conducted to determine the worst-case mode from all possible combinations between available modulations and antenna ports (if EUT with antenna diversity architecture).
- Following channel(s) was (were) selected for the final test as listed below.

AVAILABLE CHANNEL	TESTED CHANNEL	MODULATION TECHNOLOGY
512 to 810	512, 661, 810	GPRS

RADIATED EMISSION MEASUREMENT (BELOW 1 GHz):

- Pre-Scan has been conducted to determine the worst-case mode from all possible combinations between available modulations, data rates, XYZ axis and antenna ports (if EUT with antenna diversity architecture).
- Following channel(s) was (were) selected for the final test as listed below.

AVAILABLE CHANNEL	TESTED CHANNEL	MODULATION TECHNOLOGY	AXIS
512 to 810	661	GPRS	Z

RADIATED EMISSION MEASUREMENT (ABOVE 1 GHz):

- Pre-Scan has been conducted to determine the worst-case mode from all possible combinations between available modulations, data rates, XYZ axis and antenna ports (if EUT with antenna diversity architecture).
- Following channel(s) was (were) selected for the final test as listed below.

AVAILABLE CHANNEL	TESTED CHANNEL	MODULATION TECHNOLOGY	AXIS
512 to 810	512, 661, 810	GPRS	Z

TEST CONDITION:

APPLICABLE TO	ENVIRONMENTAL CONDITIONS	INPUT POWER (SYSTEM)	TESTED BY
OP	23deg. C, 63%RH, 1008 hPa	120Vac, 60Hz	Mark Liao
FS	23deg. C, 63%RH, 1008 hPa	120Vac, 60Hz	Mark Liao
OB	23deg. C, 63%RH, 1008 hPa	120Vac, 60Hz	Mark Liao
EM	23deg. C, 63%RH, 1008 hPa	120Vac, 60Hz	Mark Liao
BE	23deg. C, 63%RH, 1008 hPa	120Vac, 60Hz	Mark Liao
CE	23deg. C, 63%RH, 1008 hPa	120Vac, 60Hz	Mark Liao
RE < 1G	25deg. C, 68%RH, 991 hPa	120Vac, 60Hz	Sun Lin
RE ≥ 1G	25deg. C, 65%RH, 991 hPa	120Vac, 60Hz	Mark Liao



A D T

FOR CDMA:

EUT CONFIGURE MODE	APPLICABLE TO							DESCRIPTION
	OP	FS	OB	BE	CE	RE<1G	RE≥1G	
-	√	√	√	√	√	√	√	-

Where **OP**: Output power **FS**: Frequency stability
OB: Occupied bandwidth **BE**: Band edge
CE: Conducted spurious emissions **RE<1G**: Radiated emission below 1GHz
RE≥1G: Radiated emission above 1GHz

OUTPUT POWER MEASUREMENT:

- Pre-Scan has been conducted to determine the worst-case mode from all possible combinations between available modulations and antenna ports (if EUT with antenna diversity architecture).
- Following channel(s) was (were) selected for the final test as listed below.

AVAILABLE CHANNEL	TESTED CHANNEL	MODULATION TECHNOLOGY
25 to 1175	25, 600, 1175	CDMA

FREQUENCY STABILITY MEASUREMENT:

- Pre-Scan has been conducted to determine the worst-case mode from all possible combinations between available modulations and antenna ports (if EUT with antenna diversity architecture).
- Following channel(s) was (were) selected for the final test as listed below.

AVAILABLE CHANNEL	TESTED CHANNEL	MODULATION TECHNOLOGY
25 to 1175	600	CDMA

OCCUPIED BANDWIDTH MEASUREMENT:

- This item includes all test value of each mode, but only includes spectrum plot of worst value of each mode.
- Pre-Scan has been conducted to determine the worst-case mode from all possible combinations between available modulations and antenna ports (if EUT with antenna diversity architecture).
- Following channel(s) was (were) selected for the final test as listed below.

AVAILABLE CHANNEL	TESTED CHANNEL	MODULATION TECHNOLOGY
25 to 1175	25, 600, 1175	CDMA

BAND EDGE MEASUREMENT:

- Pre-Scan has been conducted to determine the worst-case mode from all possible combinations between available modulations and antenna ports (if EUT with antenna diversity architecture).
- Following channel(s) was (were) selected for the final test as listed below.

AVAILABLE CHANNEL	TESTED CHANNEL	MODULATION TECHNOLOGY
25 to 1175	25, 1175	CDMA



CONDUCTED SPURIOUS EMISSIONS MEASUREMENT:

- Pre-Scan has been conducted to determine the worst-case mode from all possible combinations between available modulations and antenna ports (if EUT with antenna diversity architecture).
- Following channel(s) was (were) selected for the final test as listed below.

AVAILABLE CHANNEL	TESTED CHANNEL	MODULATION TECHNOLOGY
25 to 1175	25, 600, 1175	CDMA

RADIATED EMISSION MEASUREMENT (BELOW 1 GHz):

- Pre-Scan has been conducted to determine the worst-case mode from all possible combinations between available modulations, data rates, XYZ axis and antenna ports (if EUT with antenna diversity architecture).
- Following channel(s) was (were) selected for the final test as listed below.

AVAILABLE CHANNEL	TESTED CHANNEL	MODULATION TECHNOLOGY	AXIS
25 to 1175	25	CDMA	Z

RADIATED EMISSION MEASUREMENT (ABOVE 1 GHz):

- Pre-Scan has been conducted to determine the worst-case mode from all possible combinations between available modulations, data rates, XYZ axis and antenna ports (if EUT with antenna diversity architecture).
- Following channel(s) was (were) selected for the final test as listed below.

AVAILABLE CHANNEL	TESTED CHANNEL	MODULATION TECHNOLOGY	AXIS
25 to 1175	25, 600, 1175	CDMA	Z

TEST CONDITION:

APPLICABLE TO	ENVIRONMENTAL CONDITIONS	INPUT POWER (SYSTEM)	TESTED BY
OP	23deg. C, 63%RH, 1008 hPa	120Vac, 60Hz	Mark Liao
FS	23deg. C, 63%RH, 1008 hPa	120Vac, 60Hz	Mark Liao
OB	23deg. C, 63%RH, 1008 hPa	120Vac, 60Hz	Mark Liao
EM	23deg. C, 63%RH, 1008 hPa	120Vac, 60Hz	Mark Liao
BE	23deg. C, 63%RH, 1008 hPa	120Vac, 60Hz	Mark Liao
CE	23deg. C, 63%RH, 1008 hPa	120Vac, 60Hz	Mark Liao
RE < 1G	25deg. C, 68%RH, 991 hPa	120Vac, 60Hz	Sun Lin
RE ≥ 1G	25deg. C, 65%RH, 991 hPa	120Vac, 60Hz	Mark Liao

FOR WCDMA:

EUT CONFIGURE MODE	APPLICABLE TO							DESCRIPTION
	OP	FS	OB	BE	CE	RE<1G	RE≥1G	
-	√	√	√	√	√	√	√	-

Where

OP: Output power	FS: Frequency stability
OB: Occupied bandwidth	BE: Band edge
CE: Conducted spurious emissions	RE<1G: Radiated emission below 1GHz
RE≥1G: Radiated emission above 1GHz	

OUTPUT POWER MEASUREMENT:

- Pre-Scan has been conducted to determine the worst-case mode from all possible combinations between available modulations and antenna ports (if EUT with antenna diversity architecture).
- Following channel(s) was (were) selected for the final test as listed below.

AVAILABLE CHANNEL	TESTED CHANNEL	MODULATION TECHNOLOGY
9262 to 9538	9262, 9400, 9538	WCDMA

FREQUENCY STABILITY MEASUREMENT:

- Pre-Scan has been conducted to determine the worst-case mode from all possible combinations between available modulations and antenna ports (if EUT with antenna diversity architecture).
- Following channel(s) was (were) selected for the final test as listed below.

AVAILABLE CHANNEL	TESTED CHANNEL	MODULATION TECHNOLOGY
9262 to 9538	9400	WCDMA

OCCUPIED BANDWIDTH MEASUREMENT:

- This item includes all test value of each mode, but only includes spectrum plot of worst value of each mode.
- Pre-Scan has been conducted to determine the worst-case mode from all possible combinations between available modulations and antenna ports (if EUT with antenna diversity architecture).
- Following channel(s) was (were) selected for the final test as listed below.

AVAILABLE CHANNEL	TESTED CHANNEL	MODULATION TECHNOLOGY
9262 to 9538	9262, 9400, 9538	WCDMA

BAND EDGE MEASUREMENT:

- Pre-Scan has been conducted to determine the worst-case mode from all possible combinations between available modulations and antenna ports (if EUT with antenna diversity architecture).
- Following channel(s) was (were) selected for the final test as listed below.

AVAILABLE CHANNEL	TESTED CHANNEL	MODULATION TECHNOLOGY
9262 to 9538	9262, 9538	WCDMA



A D T

CONDUCTED SPURIOUS EMISSIONS MEASUREMENT:

- Pre-Scan has been conducted to determine the worst-case mode from all possible combinations between available modulations and antenna ports (if EUT with antenna diversity architecture).
- Following channel(s) was (were) selected for the final test as listed below.

AVAILABLE CHANNEL	TESTED CHANNEL	MODULATION TECHNOLOGY
9262 to 9538	9262, 9400, 9538	WCDMA

RADIATED EMISSION MEASUREMENT (BELOW 1 GHz):

- Pre-Scan has been conducted to determine the worst-case mode from all possible combinations between available modulations, data rates, XYZ axis and antenna ports (if EUT with antenna diversity architecture).
- Following channel(s) was (were) selected for the final test as listed below.

AVAILABLE CHANNEL	TESTED CHANNEL	MODULATION TECHNOLOGY	AXIS
9262 to 9538	9538	WCDMA	Z

RADIATED EMISSION MEASUREMENT (ABOVE 1 GHz):

- Pre-Scan has been conducted to determine the worst-case mode from all possible combinations between available modulations, data rates, XYZ axis and antenna ports (if EUT with antenna diversity architecture).
- Following channel(s) was (were) selected for the final test as listed below.

AVAILABLE CHANNEL	TESTED CHANNEL	MODULATION TECHNOLOGY	AXIS
9262 to 9538	9262, 9400, 9538	WCDMA	Z

TEST CONDITION:

APPLICABLE TO	ENVIRONMENTAL CONDITIONS	INPUT POWER (SYSTEM)	TESTED BY
OP	23deg. C, 63%RH, 1008 hPa	120Vac, 60Hz	Mark Liao
FS	23deg. C, 63%RH, 1008 hPa	120Vac, 60Hz	Mark Liao
OB	23deg. C, 63%RH, 1008 hPa	120Vac, 60Hz	Mark Liao
EM	23deg. C, 63%RH, 1008 hPa	120Vac, 60Hz	Mark Liao
BE	23deg. C, 63%RH, 1008 hPa	120Vac, 60Hz	Mark Liao
CE	23deg. C, 63%RH, 1008 hPa	120Vac, 60Hz	Mark Liao
RE < 1G	25deg. C, 68%RH, 991 hPa	120Vac, 60Hz	Sun Lin
RE ≥ 1G	25deg. C, 65%RH, 991 hPa	120Vac, 60Hz	Mark Liao

3.3 GENERAL DESCRIPTION OF APPLIED STANDARDS

The EUT is a RF product. According to the specifications of the manufacturer, it must comply with the requirements of the following standards:

FCC 47 CFR Part 2

FCC 47 CFR Part 24

IC RSS-133

ANSI C63.4-2003

ANSI/TIA/EIA-603-C 2004

NOTE: All test items have been performed and recorded as per the above standards.

3.4 DESCRIPTION OF SUPPORT UNITS

The EUT has been tested as an independent unit together with other necessary accessories or support units. The following support units or accessories were used to form a representative test configuration during the tests.

NO.	PRODUCT	BRAND	MODEL NO.	SERIAL NO.	FCC ID
1	MOUSE	DELL	MO56U0	513001542	FCC DoC Approved
2	USB KEYBOARD	DELL	SK-8115	MY-0DJ325-716 19-857-0405	NA
3	MODEM	ACEEX	1414V/3	0401008270	IFAXDM1414
4	EARPHONE	PHILIPS	HL145	N/A	NA
5	MICROPHONE	Labtec	LVA7313	N/A	NA
6	UNIVERSAL RADIO COMMUNICATION TESTER	R&S	CMU200	104484	NA
7	NJZ-2000 (GPRS+WCDMA SIMULATOR)	JRC	NJZ-2000	ET00054	NA

NO.	SIGNAL CABLE DESCRIPTION OF THE ABOVE SUPPORT UNITS
1	1.8m foil shielded wire, USB Connector, w/o core.
2	1.8m foil shielded wire, USB Connector, w/o core.
3	1.2m braid shielded wire, DB25 & DB9 connector, w/o core.
4	1.2m shielded cable
5	1m wrapped shielded wire, terminated via drain wire, with 3.5 mm phone plug, w/o core.
6	NA
7	NA

NOTE 1: All power cords of the above support units are non shielded (1.8m).

NOTE 2: Item 6-7 acted as a communication partners to transfer data.

4 TEST TYPES AND RESULTS

4.1 OUTPUT POWER MEASUREMENT

4.1.1 LIMITS OF OUTPUT POWER MEASUREMENT

The radiated peak output power shall be according to the specific rule Part 24.232(b) that “Mobile / Portable station are limited to 2 watts e.i.r.p” and 24.232(c) specific that “Peak transmit power must be measure over any interval of continuous transmission using instrumentation calibration in terms of rms-equivalent voltage.”

4.1.2 TEST INSTRUMENTS

DESCRIPTION & MANUFACTURER	MODEL NO.	SERIAL NO.	DATE OF CALIBRATION	DUE DATE OF CALIBRATION
Test Receiver ROHDE & SCHWARZ	ESIB7	100188	Dec. 21, 2009	Dec. 20, 2010
Spectrum Analyzer ROHDE & SCHWARZ	FSP40	100269	Dec. 31, 2009	Dec. 30, 2010
BILOG Antenna SCHWARZBECK	VULB9168	9168-160	Apr. 27, 2010	Apr. 26, 2011
HORN Antenna SCHWARZBECK	9120D	9120D-405	Feb. 03, 2010	Feb. 02, 2011
HORN Antenna SCHWARZBECK	BBHA 9170	BBHA9170243	Dec. 25, 2009	Dec. 24, 2010
Preamplifier Agilent	8447D	2944A10638	Dec. 21, 2009	Dec. 20, 2010
Preamplifier Agilent	8449B	3008A01964	Nov. 09, 2009	Nov. 08, 2010
RF signal cable HUBER+SUHNNER	SUCOFLEX 104	238141/4	May 14, 2010	May 13, 2011
RF signal cable HUBER+SUHNNER	SUCOFLEX 104	12738/6	May 14, 2010	May 13, 2011
Software ADT.	ADT_Radiated_ V7.6.15.9.2	NA	NA	NA
Antenna Tower inn-co GmbH	MA 4000	013303	NA	NA
Antenna Tower Controller inn-co GmbH	CO2000	017303	NA	NA
Turn Table ADT.	TT100.	TT93021703	NA	NA
Turn Table Controller ADT.	SC100.	SC93021703	NA	NA

- NOTE:**
1. The calibration interval of the above test instruments is 12 months and the calibrations are traceable to NML/ROC and NIST/USA.
 2. The test was performed in HwaYa Chamber 3.
 3. The horn antenna and HP preamplifier (model: 8449B) are used only for the measurement of emission frequency above 1GHz if tested.
 4. The FCC Site Registration No. is 988962.
 5. The IC Site Registration No. is IC 7450F-3.

4.1.3 TEST PROCEDURES

- a. The power was measured with R&S Spectrum Analyzer. All measurements were done at 3 channels, 512, 661 and 810 (GPRS & E-GPRS) / 25, 600 and 1175 (CDMA) / 9262, 9400 and 9538 (WCDMA) (low, middle and high operational frequency range.)
- b. The conducted output power used the power splitter via EUT RF power connector between simulation base station and spectrum analyzer. The path loss included the splitter loss, cable loss and 20dB pad loss. The spectrum set RB/VB 1MHz (GPRS & E-GPRS), 3MHz (CDMA), and 5MHz (WCDMA), then read power value and record to the test. (All transmitted path loss shall be considered in the test report data.)
- c. Substitution method is used for E.I.R.P measurement. In the semi-anechoic chamber, EUT placed on the 0.8m height of Turn Table, rotated the table around 360 degrees to search the maximum radiation power and receiver antenna shall be rotated vertical and horizontal polarization and moved height from 1m to 4m to find the maximum polar radiated power. The “Read Value” is the spectrum reading the maximum power value.
- d. The substitution horn antenna is substituted for EUT at the same position and signals generator export the CW signal to the substitution antenna via a tx cable . Rotated the Turn Table and moved receiving antenna to find the maximum radiation power. Adjust output power level of S.G to get a Value of spectrum reading equal to “Read Value “ of step c. Record the power level of S.G
- e. $EIRP = \text{Output power level of S.G} - \text{TX cable loss} + \text{Antenna gain of substitution horn.}$

4.1.4 TEST SETUP

EIRP POWER MEASUREMENT:

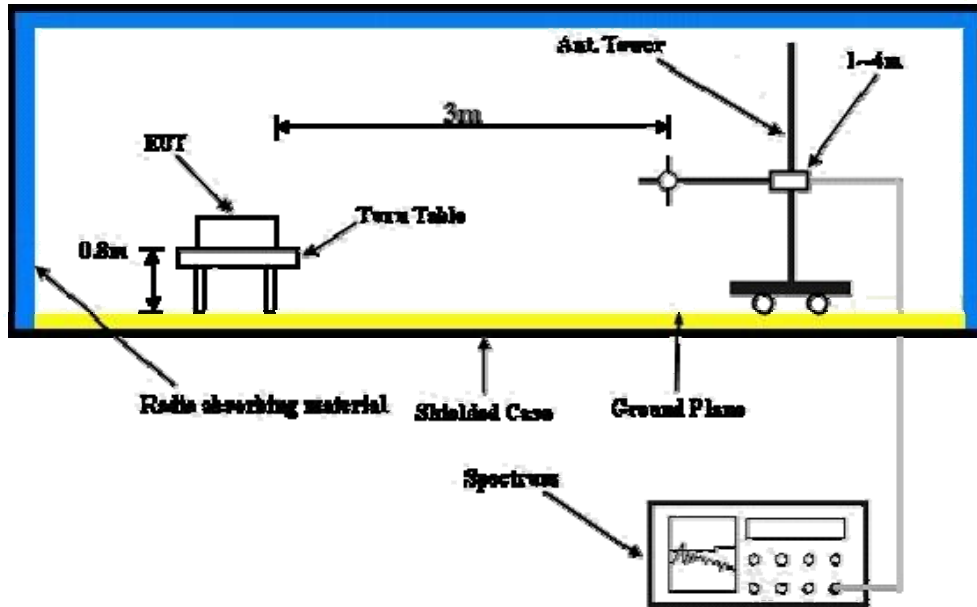

For the actual test configuration, please refer to the attached file (Test Setup Photo).

CONDUCTED POWER MEASUREMENT:

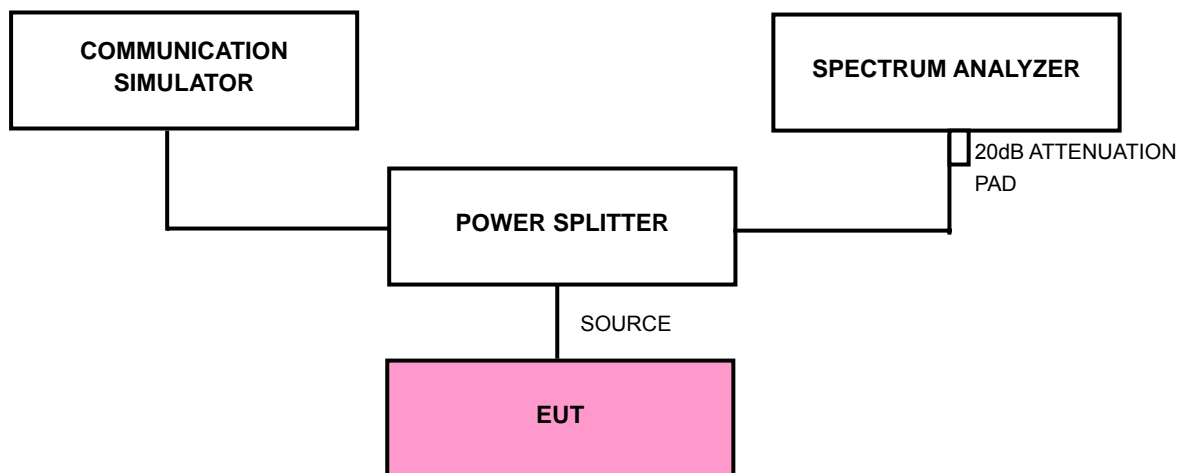

For the actual test configuration, please refer to the related item – Photographs of the Test Configuration.

4.1.5 EUT OPERATING CONDITIONS

- a. The EUT makes a call to the communication simulator.
- b. The communication simulator station system controlled an EUT to export maximum output power under transmission mode and specific channel frequency.

4.1.6 TEST RESULTS

FOR GPRS & E-GPRS:

FOR GPRS MODE (UP-LINK WITH 1 TIME SLOT)

CONDUCTED OUTPUT POWER					
CHANNEL NO.	FREQUENCY (MHz)	RAW VALUE (dBm)	CORRECTION FACTOR (dB)	OUTPUT POWER	
				dBm	Watt
512	1850.2	5.00	24.10	29.10	0.8128
661	1880.0	4.80	24.10	28.90	0.7762
810	1909.8	4.70	24.10	28.80	0.7586

FOR E-GPRS MODE (UP-LINK WITH 1 TIME SLOT)

CONDUCTED OUTPUT POWER					
CHANNEL NO.	FREQUENCY (MHz)	RAW VALUE (dBm)	CORRECTION FACTOR (dB)	OUTPUT POWER	
				dBm	Watt
512	1850.2	1.70	24.10	25.80	0.3802
661	1880.0	1.50	24.10	25.60	0.3631
810	1909.8	1.40	24.10	25.50	0.3548

- REMARKS:** 1. Output Power (dBm) = Raw Value (dBm) + Correction Factor (dB).
 2. Correction Factor (dB) = Power Splitter Loss (dB) + Cable Loss (dB) + 20dB Pad.

FOR GPRS MODE (UP-LINK WITH 1 TIME SLOT)

EIRP POWER					
CHANNEL NO.	FREQUENCY (MHz)	S.G VALUE (dBm)	CORRECTION FACTOR (dB)	OUTPUT POWER	
				dBm	Watt
512	1850.2	24.6	8.4	33.0	1.9953
661	1880.0	23.6	8.6	32.2	1.6596
810	1909.8	23.6	8.5	32.1	1.6218

FOR E-GPRS MODE (UP-LINK WITH 1 TIME SLOT)

EIRP POWER					
CHANNEL NO.	FREQUENCY (MHz)	S.G VALUE (dBm)	CORRECTION FACTOR (dB)	OUTPUT POWER	
				dBm	Watt
512	1850.2	20.8	8.4	29.2	0.8318
661	1880.0	19.9	8.6	28.5	0.7079
810	1909.8	19.8	8.5	28.3	0.6761

- REMARKS:** 1. Output Power (dBm) = S.G Value (dBm) + Correction Factor (dB).
 2. Correction Factor (dB) = Substitution Antenna Gain (dB) + Cable Loss (dB).



A D T

FOR CDMA:

WORST CASE CONDUCTED POWER OF 1x EV-DO								
CHANNEL	FREQ. (MHz)	Revision A	Release 0	CORR. FACTOR (dB)	Revision A		Release 0	
		RAW VALUE (dBm)			OUTPUT POWER			
		dBm	Watt		dBm	Watt		
25	1851.25	-0.60	-0.30	24.10	23.50	0.2239	23.80	0.2399
600	1880.00	-0.40	0.10	24.10	23.70	0.2344	24.20	0.2630
1175	1908.75	-1.20	-0.70	24.10	22.90	0.1950	23.40	0.2188

CDMA 2000 CONDUCTED POWER											
CHAN.	FREQ. (MHz)	CDMA 2000	RAW VALUE (dBm)				CORR. FACTOR (dB)	OUTPUT POWER (dBm)			
		RC	SO2	SO55	TDSO SO32 (FCH)	TDSO SO32 (FCH+S CH)		SO2	SO55	TDSO SO32 (FCH)	TDSO SO32 (FCH+S CH)
		25	1851.25	RC1	-0.22	-0.12		-	-	24.10	23.88
		RC3	-0.09	-0.01	-0.11	-0.23	24.10	24.01	24.09	23.99	23.87
600	1880.00	RC1	0.15	0.17	-	-	24.10	24.25	24.27	-	-
		RC3	0.24	0.31	0.29	0.21	24.10	24.34	24.41	24.39	24.31
1175	1908.75	RC1	-0.65	-0.63	-	-	24.10	23.45	23.47	-	-
		RC3	-0.51	-0.41	-0.46	-0.59	24.10	23.59	23.69	23.64	23.51

REMARKS: 1. Output Power (dBm) = Raw Value (dBm) + Correction Factor (dB).
 2. Correction Factor (dB) = Power Splitter Loss (dB) + Cable Loss (dB) + 20dB Pad.



A D T

1xEV-DO MODE

EIRP POWER (1x EV-DO)								
CHANNEL	FREQ. (MHz)	S.G. VALUE (dBm)		CORR. FACTOR (dB)	OUTPUT POWER			
					Revision A		Release 0	
		Revision A	Release 0		dBm	Watt	dBm	Watt
25	1851.25	19.1	19.3	8.4	27.5	0.5623	27.7	0.5888
60	1880.00	19.0	19.6	8.6	27.6	0.5754	28.2	0.6607
1175	1908.75	19.2	18.8	8.5	27.7	0.5888	27.3	0.5370

CDMA MODE

EIRP POWER (SO55)					
CHANNEL NO.	FREQUENCY (MHz)	S.G. VALUE (dBm)	CORRECTION FACTOR (dB)	OUTPUT POWER	
				dBm	Watt
25	1851.25	19.9	8.4	28.3	0.6761
600	1880.00	20.0	8.6	28.6	0.7244
1175	1908.75	19.1	8.5	27.6	0.5754

- REMARKS:** 1. Output Power (dBm) = S.G Value (dBm) + Correction Factor (dB).
2. Correction Factor (dB) = Substitution Antenna Gain (dB) + Cable Loss (dB).

FOR WCDMA:
WCDMA-RMC MODE

CONDUCTED OUTPUT POWER					
CHANNEL NO.	FREQUENCY (MHz)	RAW VALUE (dBm)	CORRECTION FACTOR (dB)	OUTPUT POWER	
				dBm	Watt
9262	1852.40	0.02	24.10	24.12	0.2582
9400	1880.00	0.23	24.10	24.33	0.2710
9538	1907.60	-0.04	24.10	24.06	0.2547

HSDPA MODE-R5 Subtest 1

CONDUCTED OUTPUT POWER					
CHANNEL NO.	FREQUENCY (MHz)	RAW VALUE (dBm)	CORRECTION FACTOR (dB)	OUTPUT POWER	
				dBm	Watt
9262	1852.40	-0.16	24.10	23.94	0.2477
9400	1880.00	0.10	24.10	24.20	0.2630
9538	1907.60	-0.34	24.10	23.76	0.2377

HSDPA MODE-R5 Subtest 2

CONDUCTED OUTPUT POWER					
CHANNEL NO.	FREQUENCY (MHz)	RAW VALUE (dBm)	CORRECTION FACTOR (dB)	OUTPUT POWER	
				dBm	Watt
9262	1852.40	-0.61	24.10	23.49	0.2234
9400	1880.00	-0.05	24.10	24.05	0.2541
9538	1907.60	-0.87	24.10	23.23	0.2104

HSDPA MODE-R5 Subtest 3

CONDUCTED OUTPUT POWER					
CHANNEL NO.	FREQUENCY (MHz)	RAW VALUE (dBm)	CORRECTION FACTOR (dB)	OUTPUT POWER	
				dBm	Watt
9262	1852.40	-0.80	24.10	23.30	0.2138
9400	1880.00	-0.03	24.10	24.07	0.2553
9538	1907.60	-0.98	24.10	23.12	0.2051

- REMARKS:** 1. Output Power (dBm) = Raw Value (dBm) + Correction Factor (dB).
 2. Correction Factor (dB) = Power Splitter Loss (dB) + Cable Loss (dB) + 20dB Pad.

HSDPA MODE-R5 Subtest 4

CONDUCTED OUTPUT POWER					
CHANNEL NO.	FREQUENCY (MHz)	RAW VALUE (dBm)	CORRECTION FACTOR (dB)	OUTPUT POWER	
				dBm	Watt
9262	1852.40	-0.78	24.10	23.32	0.2148
9400	1880.00	-0.09	24.10	24.01	0.2518
9538	1907.60	-0.99	24.10	23.11	0.2047

HSUPA MODE-R6 Subtest 1

CONDUCTED OUTPUT POWER					
CHANNEL NO.	FREQUENCY (MHz)	RAW VALUE (dBm)	CORRECTION FACTOR (dB)	OUTPUT POWER	
				dBm	Watt
9262	1852.40	-0.91	24.10	23.19	0.2084
9400	1880.00	-1.37	24.10	22.73	0.1875
9538	1907.60	-1.17	24.10	22.93	0.1963

HSUPA MODE-R6 Subtest 2

CONDUCTED OUTPUT POWER					
CHANNEL NO.	FREQUENCY (MHz)	RAW VALUE (dBm)	CORRECTION FACTOR (dB)	OUTPUT POWER	
				dBm	Watt
9262	1852.40	-2.27	24.10	21.83	0.1524
9400	1880.00	-1.78	24.10	22.32	0.1706
9538	1907.60	-2.53	24.10	21.57	0.1435

HSUPA MODE-R6 Subtest 3

CONDUCTED OUTPUT POWER					
CHANNEL NO.	FREQUENCY (MHz)	RAW VALUE (dBm)	CORRECTION FACTOR (dB)	OUTPUT POWER	
				dBm	Watt
9262	1852.40	-2.67	24.10	21.43	0.1390
9400	1880.00	-1.55	24.10	22.55	0.1799
9538	1907.60	-2.30	24.10	21.80	0.1514

- REMARKS:** 1. Output Power (dBm) = Raw Value (dBm) + Correction Factor (dB).
 2. Correction Factor (dB) = Power Splitter Loss (dB) + Cable Loss (dB) + 20dB Pad.

HSUPA MODE-R6 Subtest 4

CONDUCTED OUTPUT POWER					
CHANNEL NO.	FREQUENCY (MHz)	RAW VALUE (dBm)	CORRECTION FACTOR (dB)	OUTPUT POWER	
				dBm	Watt
9262	1852.40	-1.67	24.10	22.43	0.1750
9400	1880.00	-1.05	24.10	23.05	0.2018
9538	1907.60	-0.88	24.10	23.22	0.2099

HSUPA MODE-R6 Subtest 5

CONDUCTED OUTPUT POWER					
CHANNEL NO.	FREQUENCY (MHz)	RAW VALUE (dBm)	CORRECTION FACTOR (dB)	OUTPUT POWER	
				dBm	Watt
9262	1852.40	-1.29	24.10	22.81	0.1910
9400	1880.00	-1.06	24.10	23.04	0.2014
9538	1907.60	-2.65	24.10	21.45	0.1396

- REMARKS:** 1. Output Power (dBm) = Raw Value (dBm) + Correction Factor (dB).
 2. Correction Factor (dB) = Power Splitter Loss (dB) + Cable Loss (dB) + 20dB Pad.



A D T

WCDMA-RMC MODE

EIRP POWER					
CHANNEL NO.	FREQUENCY (MHz)	S.G VALUE (dBm)	CORRECTION FACTOR (dB)	OUTPUT POWER	
				dBm	Watt
9262	1852.40	18.1	8.4	26.5	0.4467
9400	1880.00	17.5	8.6	26.1	0.4074
9538	1907.60	17.4	8.5	25.9	0.3890

- REMARKS:** 1. Output Power (dBm) = S.G Value (dBm) + Correction Factor (dB).
2. Correction Factor (dB) = Substitution Antenna Gain (dB) + Cable Loss (dB).

4.2 FREQUENCY STABILITY MEASUREMENT

4.2.1 LIMITS OF FREQUENCY STABILITY MEASUREMENT

According to the FCC part 24.235 shall be tested the frequency stability. The rule is defined that” The frequency stability shall be sufficient to ensure that the fundamental emission stays within the authorized frequency block.” The frequency error rate is according to the JTC standard that the frequency error rate shall be accurate to within 2.5ppm of the received frequency from the base station. The test extreme voltage is according to the 2.1055(d)(1) Vary primary supply voltage from 85 to 115 percent of the nominal value for other than hand carried battery equipment and the extreme temperature rule is comply with the 2.1055(a)(1) $-30^{\circ}\text{C} \sim 50^{\circ}\text{C}$.

4.2.2 TEST INSTRUMENTS

DESCRIPTION & MANUFACTURER	MODEL NO.	SERIAL NO.	CALIBRATED UNTIL	CALIBRATED UNTIL
Spectrum Analyzer Agilent	E4446A	MY44360124	Feb. 05, 2010	Feb. 04, 2011
Hewlett Packard RF cable	8120-6192	01428251	NA	NA
RF cable	SUCOFLEX 104	257029	Sep. 11, 2010	Sep. 10, 2011
WIT Standard Temperature & Humidity Chamber	MHU-225AU	920409	May 06, 2010	May 05, 2011

NOTE: The calibration interval of the above test instruments is 12 months. And the calibrations are traceable to NML/ROC and NIST/USA.

4.2.3 TEST PROCEDURE

- a. Because of the measure the carrier frequency under the condition of the AFC lock, it shall be used the mobile station in the GPRS / CDMA / WCDMA link mode. This is accomplished with the use of the R&S CMU200 / JRC NJZ-2000 simulator station. The oven room could control the temperatures and humidity. The GPRS link channel is the 190, the CDMA link channel is the 600 and the WCDMA link channel is the 9400.
- b. Power must be removed when changing from one temperature to another or one voltage to another voltage. Power warm up is at least 15 min and power applied should perform before recording frequency error.
- c. EUT is connected the external power supply to control the AC input power. The various Volts from the minimum 93.5 Volts to 126.5 Volts. Each step shall be record the frequency error rate.
- d. The temperature range step is 10 degrees in this test items. All temperature levels shall be hold the $\pm 0.5^{\circ}\text{C}$ during the measurement testing.
- e. The each temperature step shall be at least 0.5 hours, consider the EUT could be test under the stability condition.

NOTE: The frequency error was recorded frequency error from the GSM simulator.

4.2.4 TEST SETUP

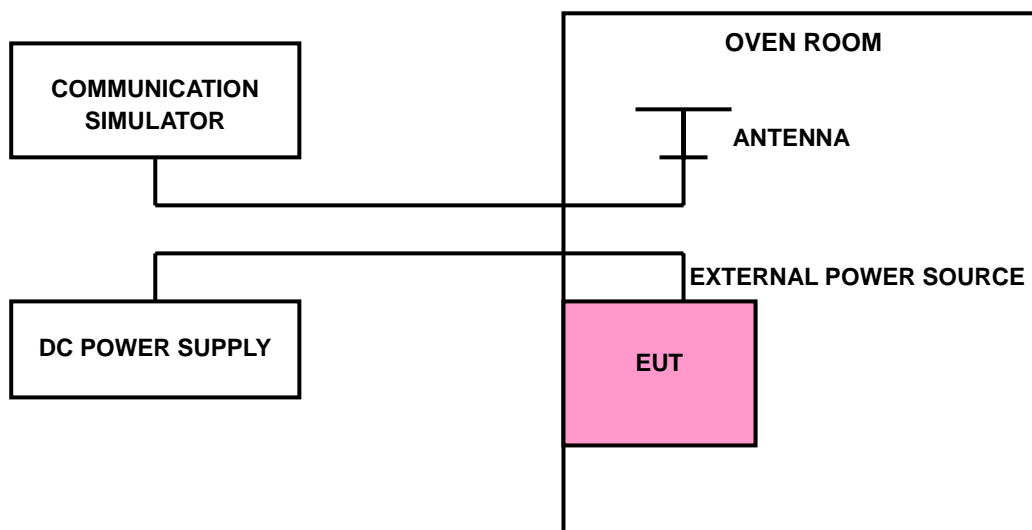

4.2.5 TEST RESULTS

FOR GSM:

AFC FREQUENCY ERROR vs. VOLTAGE			
VOLTAGE (Volts)	FREQUENCY ERROR (Hz)	FREQUENCY ERROR (ppm)	LIMIT (ppm)
126.5	-35	-0.019	2.5
93.5	-28	-0.015	2.5

NOTE: The applicant defined the normal working voltage of the AC adapter is from 93.5Vac to 126.5Vac.

AFC FREQUENCY ERROR vs. TEMP.			
TEMP. (°C)	FREQUENCY ERROR (Hz)	FREQUENCY ERROR (ppm)	LIMIT (ppm)
50	-64	-0.034	2.5
40	-11	-0.006	2.5
30	-32	-0.017	2.5
20	-39	-0.021	2.5
10	-46	-0.024	2.5
0	-21	-0.011	2.5
-10	-7	-0.004	2.5
-20	-26	-0.014	2.5
-30	-9	-0.005	2.5

FOR CDMA:

AFC FREQUENCY ERROR vs. VOLTAGE			
VOLTAGE (Volts)	FREQUENCY ERROR (Hz)	FREQUENCY ERROR (ppm)	LIMIT (ppm)
126.5	-35	-0.019	2.5
93.5	-28	-0.015	2.5

NOTE: The applicant defined the normal working voltage of the AC adapter is from 93.5Vac to 126.5Vac.

AFC FREQUENCY ERROR vs. TEMP.			
TEMP. (°C)	FREQUENCY ERROR (Hz)	FREQUENCY ERROR (ppm)	LIMIT (ppm)
50	-60	-0.032	2.5
40	-17	-0.009	2.5
30	-35	-0.019	2.5
20	-43	-0.023	2.5
10	-42	-0.022	2.5
0	-18	-0.010	2.5
-10	-9	-0.005	2.5
-20	-25	-0.013	2.5
-30	-7	-0.004	2.5

FOR WCDMA:

AFC FREQUENCY ERROR vs. VOLTAGE			
VOLTAGE (Volts)	FREQUENCY ERROR (Hz)	FREQUENCY ERROR (ppm)	LIMIT (ppm)
126.5	-32	-0.017	2.5
93.5	-28	-0.015	2.5

NOTE: The applicant defined the normal working voltage of the AC adapter is from 93.5Vac to 126.5Vac.

AFC FREQUENCY ERROR vs. TEMP.			
TEMP. (°C)	FREQUENCY ERROR (Hz)	FREQUENCY ERROR (ppm)	LIMIT (ppm)
50	-59	-0.031	2.5
40	-12	-0.006	2.5
30	-25	-0.013	2.5
20	-40	-0.021	2.5
10	-43	-0.023	2.5
0	-22	-0.012	2.5
-10	-8	-0.004	2.5
-20	-25	-0.013	2.5
-30	-10	-0.005	2.5

4.3 OCCUPIED BANDWIDTH MEASUREMENT

4.3.1 LIMITS OF OCCUPIED BANDWIDTH MEASUREMENT

The width of a frequency band such that, below the lower and above the upper frequency limits, the mean powers emitted are each equal to a specified percentage 0.5 % of the total mean power of a given emission.

4.3.2 TEST INSTRUMENTS

DESCRIPTION & MANUFACTURER	MODEL NO.	SERIAL NO.	DATE OF CALIBRATION	DUE DATE OF CALIBRATION
ROHDE & SCHWARZ Spectrum Analyzer	FSP40	100040	Jul. 09, 2010	Jul. 08, 2011
Mini-Circuits Power Splitter	ZN2PD-9G	NA	Jun. 25, 2010	Jun. 24, 2011
RF cable	SUCOFLEX 104	274403/4	Aug. 20, 2010	Aug. 19, 2011
RF cable	SUCOFLEX 104	250729/4	Aug. 19, 2010	Aug. 18, 2011
RF cable	SUCOFLEX 104	214377/4	Aug. 19, 2010	Aug. 18, 2011
JFW 20dB attenuation	50HF-020-SMA	NA	NA	NA

NOTE: The calibration interval of the above test instruments is 12 months. And the calibrations are traceable to NML/ROC and NIST/USA.

4.3.3 TEST SETUP

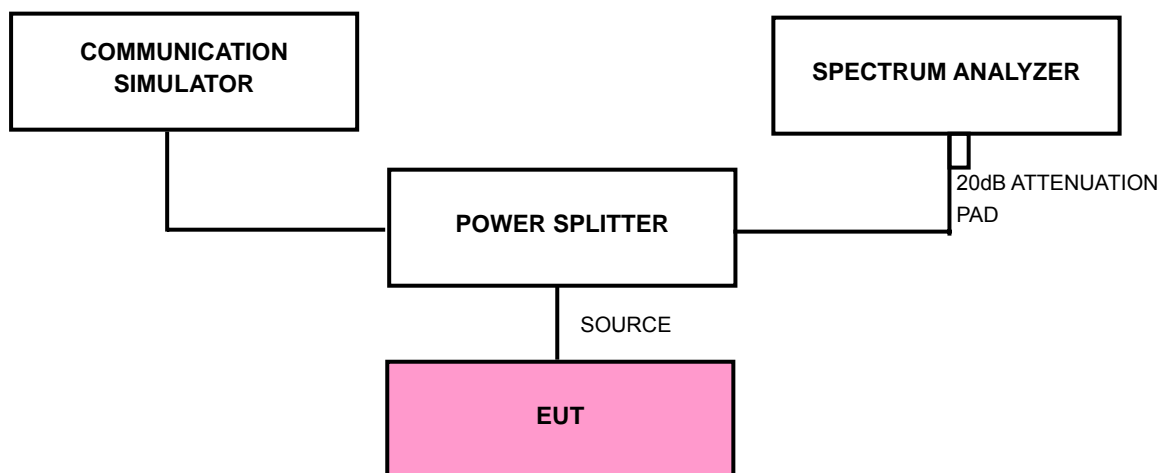

4.3.4 TEST PROCEDURES

- a. The EUT makes a call to the communication simulator. The power was measured with R&S Spectrum Analyzer. All measurements were done at 3 channels, 512, 661 and 810 (GPRS / E-GPRS) / 25, 600 and 1175 (CDMA) / 9262, 9400 and 9538 (WCDMA) (low, middle and high operational frequency range.)
- b. The conducted occupied bandwidth used the power splitter via EUT RF power connector between simulation base station and spectrum analyzer. This splitter loss and cable loss are the worst loss 24.1dB in the transmitted path track.
- c. The communication simulator station system controlled a EUT to export maximum output power under transmission mode and specific channel frequency. Use OBW measurement function of Spectrum analyzer to measure 99 % occupied bandwidth.

4.3.5 EUT OPERATING CONDITION

- a. The EUT makes a call to the communication simulator.
- b. The communication simulator station system controlled a EUT to export maximum and minimum output power under transmission mode and specific channel frequency.

4.3.6 TEST RESULTS

FOR GPRS & E-GPRS:

FOR GPRS MODE (UP-LINK WITH 1 TIME SLOT)

CHANNEL	FREQUENCY (MHz)	99% OCCUPIED BANDWIDTH (kHz)
512	1850.2	246
661	1880.0	242
810	1909.8	246

CH 512

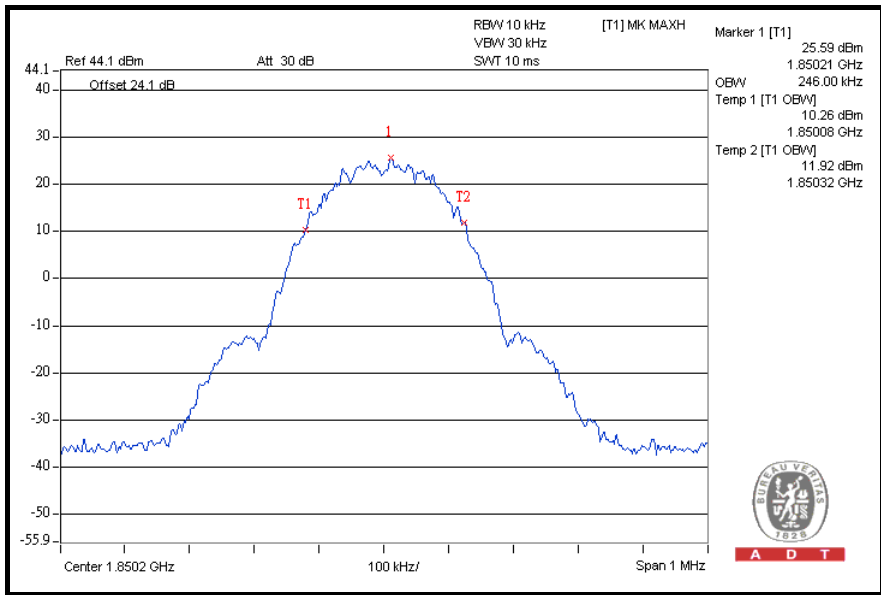



A D T

FOR E-GPRS MODE (UP-LINK WITH 1 TIME SLOT)

CHANNEL	FREQUENCY (MHz)	99% OCCUPIED BANDWIDTH (kHz)
512	1850.2	246
661	1880.0	246
810	1909.8	242

CH 661

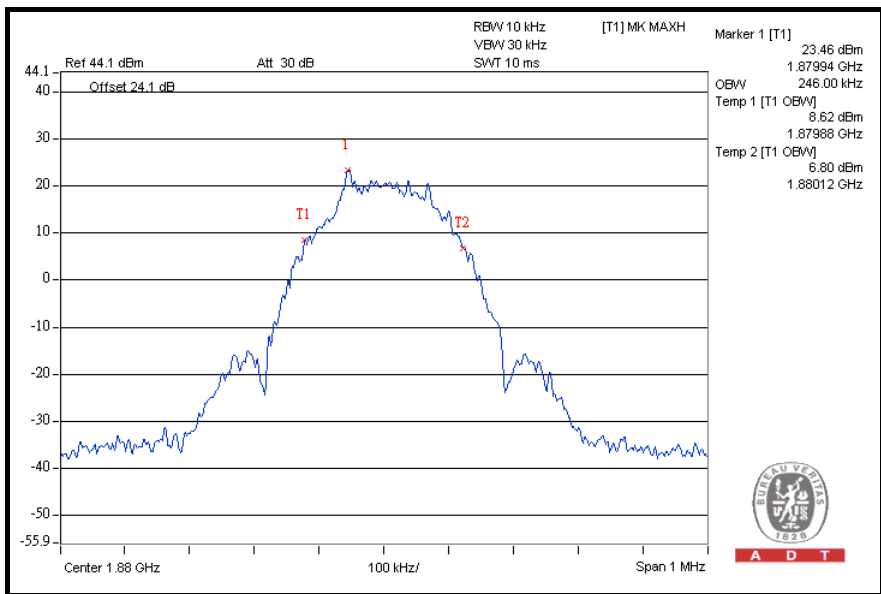

FOR CDMA:

FOR SO55:

CHANNEL	FREQUENCY (MHz)	99% OCCUPIED BANDWIDTH (MHz)
25	1851.25	1.28
600	1880.00	1.28
1175	1908.75	1.28

CH 25

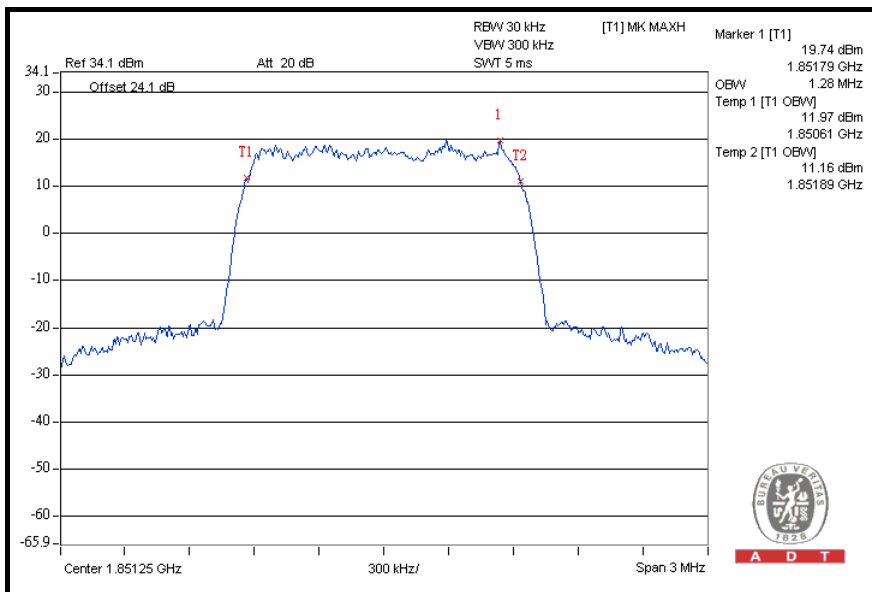



A D T

FOR EV-DO Rev. A:

CHANNEL	FREQUENCY (MHz)	99% OCCUPIED BANDWIDTH (MHz)
25	1851.25	1.28
600	1880.00	1.27
1175	1908.75	1.28

CH 25

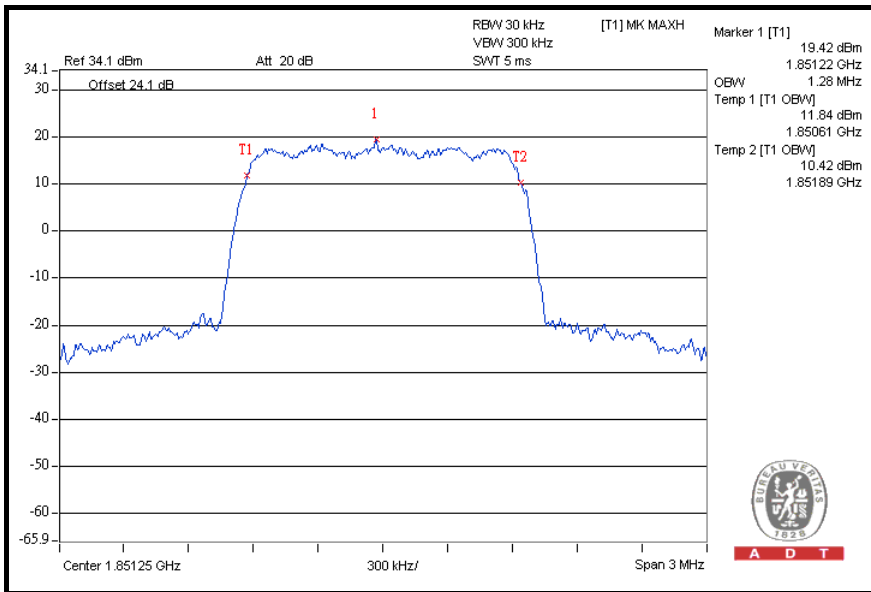



A D T

FOR EV-DO Rev. 0:

CHANNEL	FREQUENCY (MHz)	99% OCCUPIED BANDWIDTH (MHz)
25	1851.25	1.28
600	1880.00	1.28
1175	1908.75	1.28

CH 25

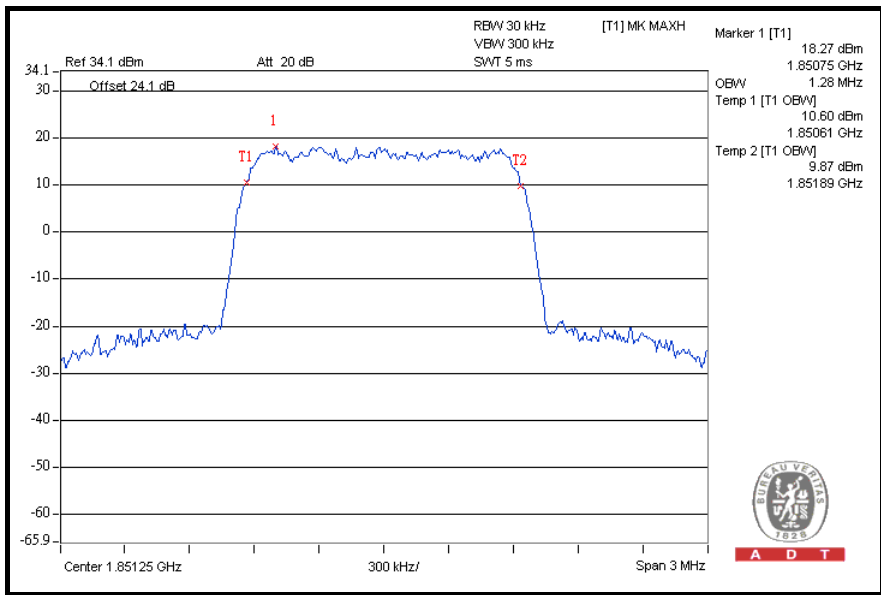

A D T



A D T

FOR WCDMA

FOR RMC:

CHANNEL	FREQUENCY (MHz)	99% OCCUPIED BANDWIDTH (MHz)
9262	1852.4	4.18
9400	1880.0	4.20
9538	1907.6	4.18

CH 9400

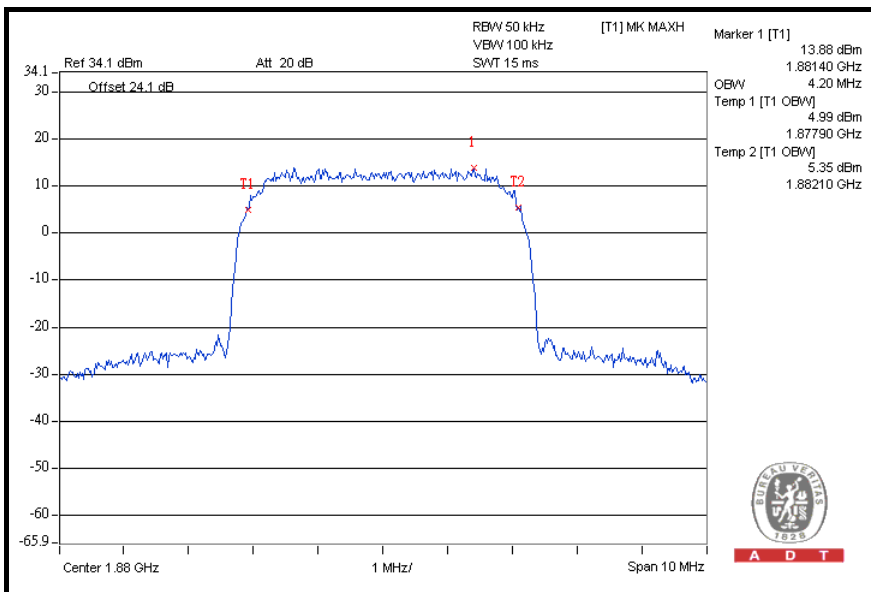

FOR HSDPA:

CHANNEL	FREQUENCY (MHz)	99% OCCUPIED BANDWIDTH (MHz)
9262	1852.4	4.20
9400	1880.0	4.20
9538	1907.6	4.18

CH 9262

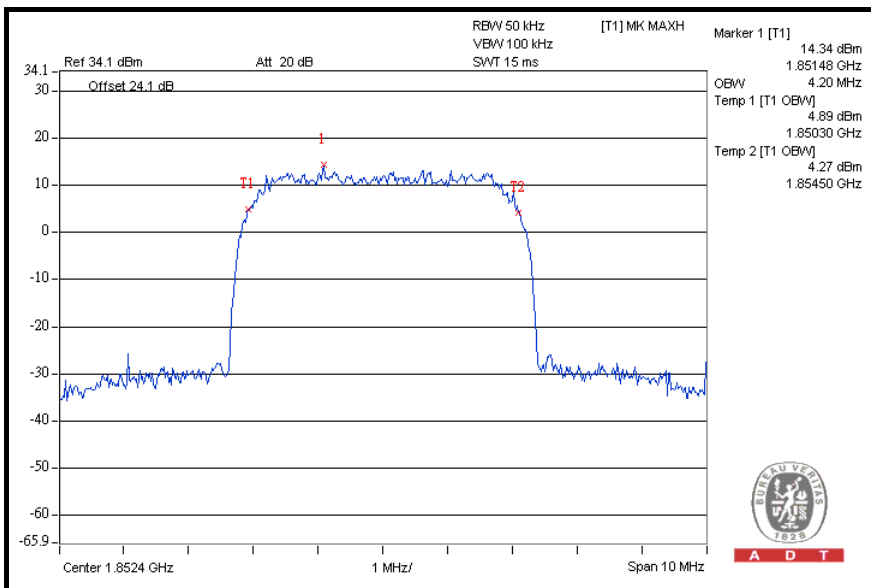

FOR HSUPA:

CHANNEL	FREQUENCY (MHz)	99% OCCUPIED BANDWIDTH (MHz)
9262	1852.4	4.18
9400	1880.0	4.18
9538	1907.6	4.22

CH 9538

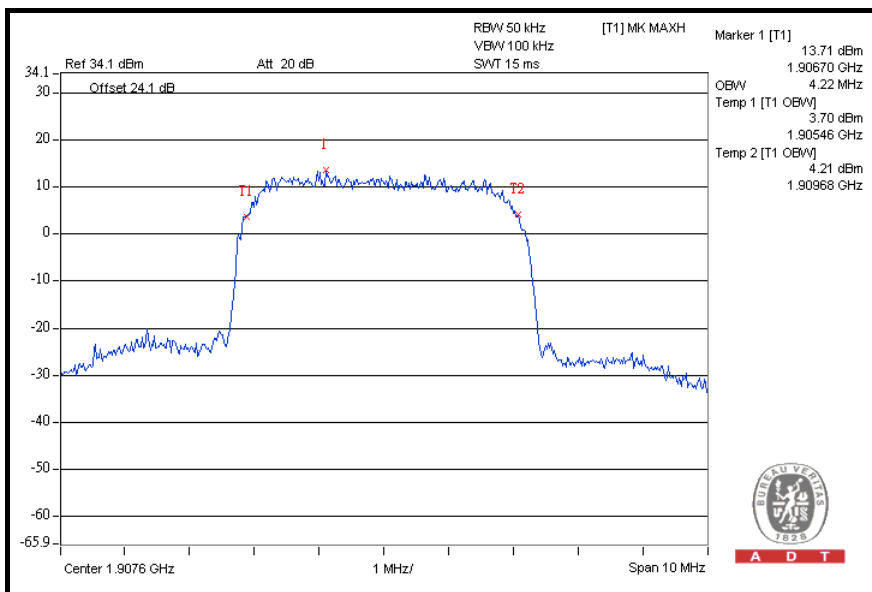

4.4 BAND EDGE MEASUREMENT

4.4.1 LIMITS OF BAND EDGE MEASUREMENT

According to FCC 24.238(a) specified that power of any emission outside of the authorized operating frequency ranges must be attenuated below the transmitting power (P) by a factor of at least $43 + 10 \log(P)$ dB. In the 1 MHz bands immediately outside and adjacent to the frequency block a resolution bandwidth of at least one percent of the emission bandwidth of the fundamental emission of the transmitter may be employed.

4.4.2 TEST INSTRUMENTS

DESCRIPTION & MANUFACTURER	MODEL NO.	SERIAL NO.	DATE OF CALIBRATION	DUE DATE OF CALIBRATION
ROHDE & SCHWARZ Spectrum Analyzer	FSP40	100040	Jul. 09, 2010	Jul. 08, 2011
Mini-Circuits Power Splitter	ZN2PD-9G	NA	Jun. 25, 2010	Jun. 24, 2011
RF cable	SUCOFLEX 104	274403/4	Aug. 20, 2010	Aug. 19, 2011
RF cable	SUCOFLEX 104	250729/4	Aug. 19, 2010	Aug. 18, 2011
RF cable	SUCOFLEX 104	214377/4	Aug. 19, 2010	Aug. 18, 2011
JFW 20dB attenuation	50HF-020-SMA	NA	NA	NA

NOTE: The calibration interval of the above test instruments is 12 months. And the calibrations are traceable to NML/ROC and NIST/USA.

4.4.3 TEST SETUP

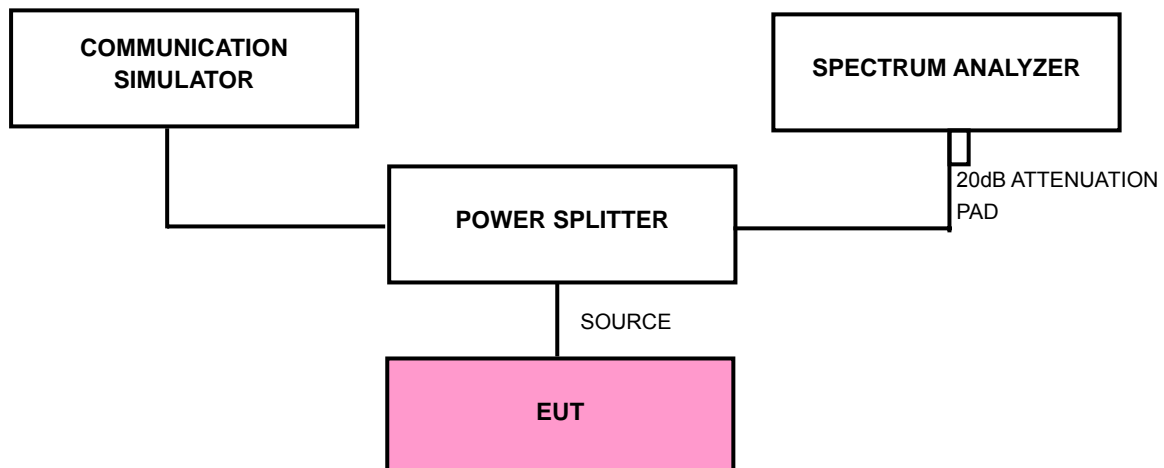

4.4.4 TEST PROCEDURES

- a. The EUT makes a call to the communication simulator. The power was measured with R&S Spectrum Analyzer. All measurements were done at 2 channels, 512 and 810 (GPRS/ E-GPRS) / 25 and 1175 (CDMA) / 9262 and 9538 (WCDMA) (low and high operational frequency range.)
- b. The band edge measurement used the power splitter via EUT RF power connector between simulation base station and spectrum analyzer. This splitter loss and cable loss are the worst loss 24.1dB in the transmitted path track.
- c. The center frequency of spectrum is the band edge frequency and span is 1.5 MHz. RB of the spectrum is 3kHz and VB of the spectrum is 10kHz (GPRS/ E-GPRS).
- d. The center frequency of spectrum is the band edge frequency and span is 3 MHz. RB of the spectrum is 15kHz and VB of the spectrum is 15kHz (CDMA).
- e. The center frequency of spectrum is the band edge frequency and span is 10 MHz. RB of the spectrum is 100kHz and VB of the spectrum is 300kHz (WCDMA).
- f. Record the max trace plot into the test report.

4.4.5 EUT OPERATING CONDITION

- a. The EUT makes a call to the communication simulator.
- b. The communication simulator station system controlled an EUT to export maximum output power under transmission mode and specific channel frequency.



A D T

4.4.6 TEST RESULTS

FOR GPRS / E-GPRS:

FOR GPRS MODE (UP-LINK WITH 1 TIME SLOT)

LOWER BAND EDGE

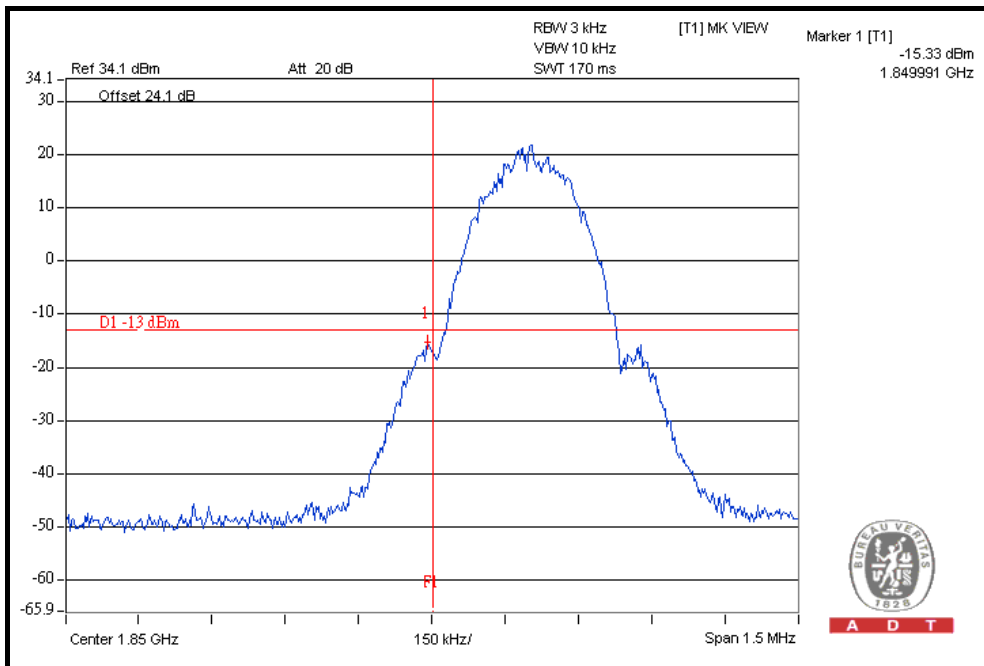

HIGHER BAND EDGE

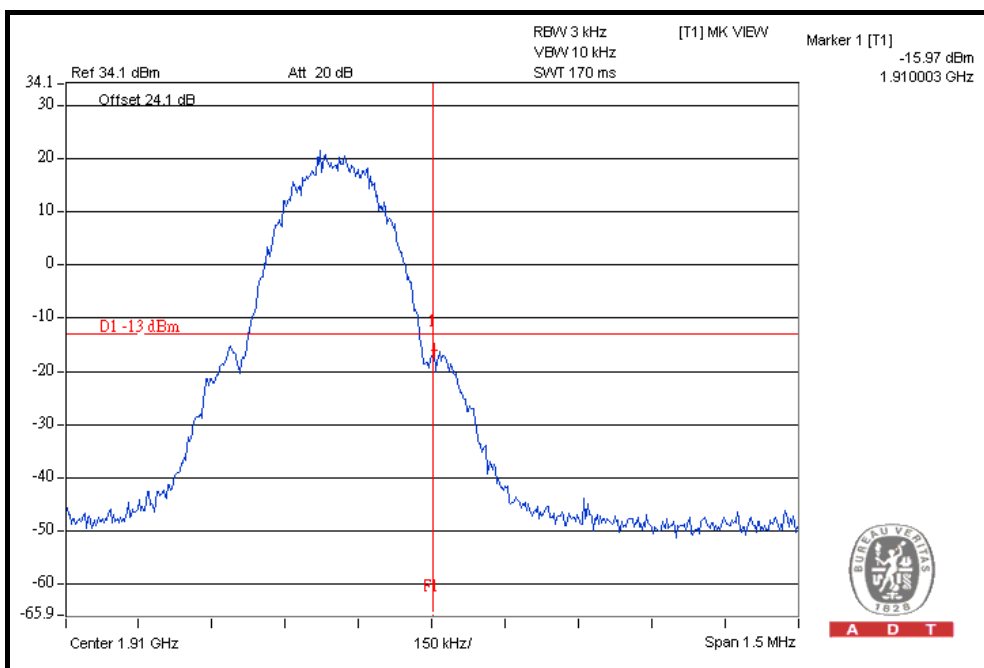



A D T

FOR E-GPRS MODE (UP-LINK WITH 1 TIME SLOT)

LOWER BAND EDGE

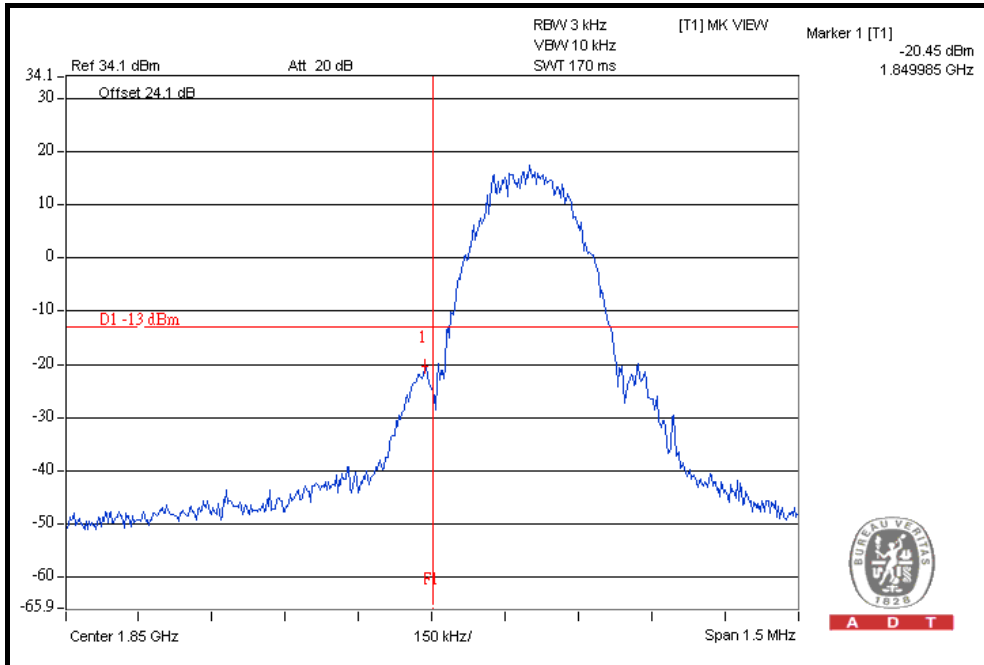

HIGHER BAND EDGE

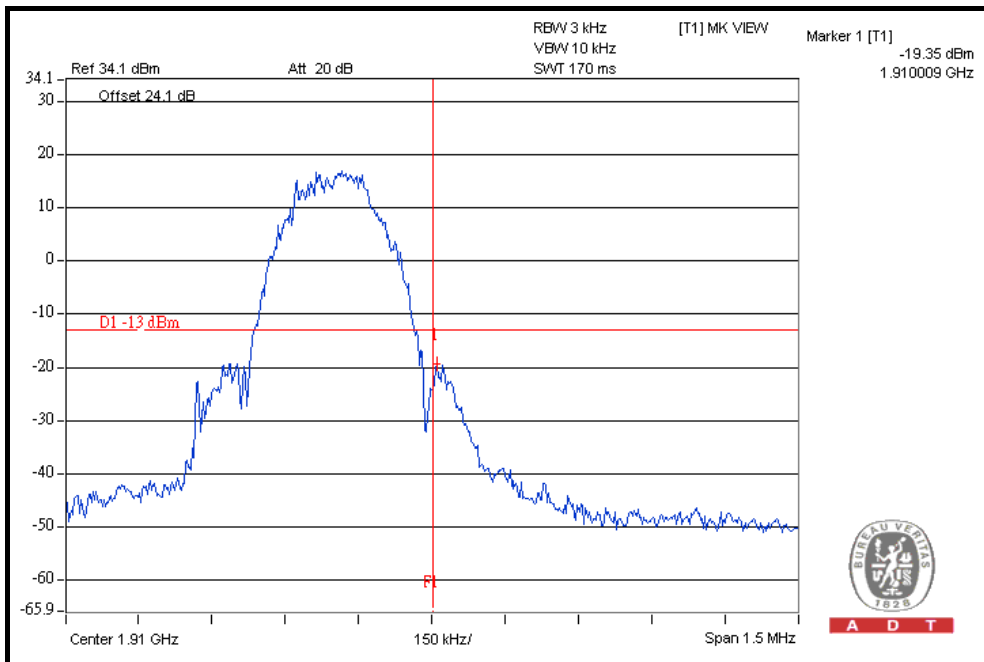



A D T

FOR CDMA:

FOR SO55:

LOWER BAND EDGE

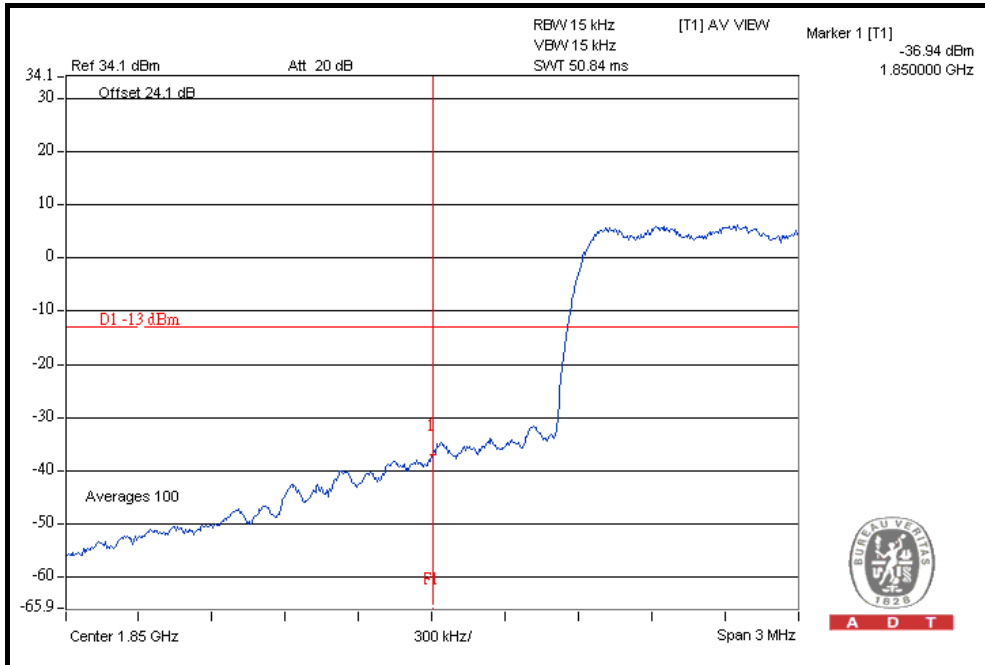

A D T

HIGHER BAND EDGE

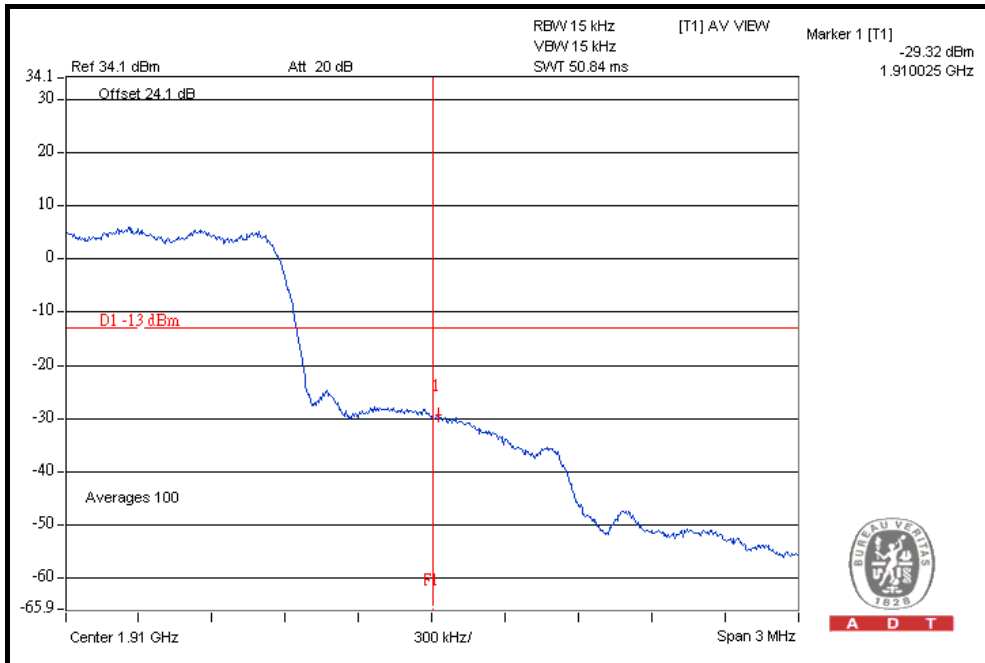

A D T



A D T

FOR EV-DO Rev. A: LOWER BAND EDGE

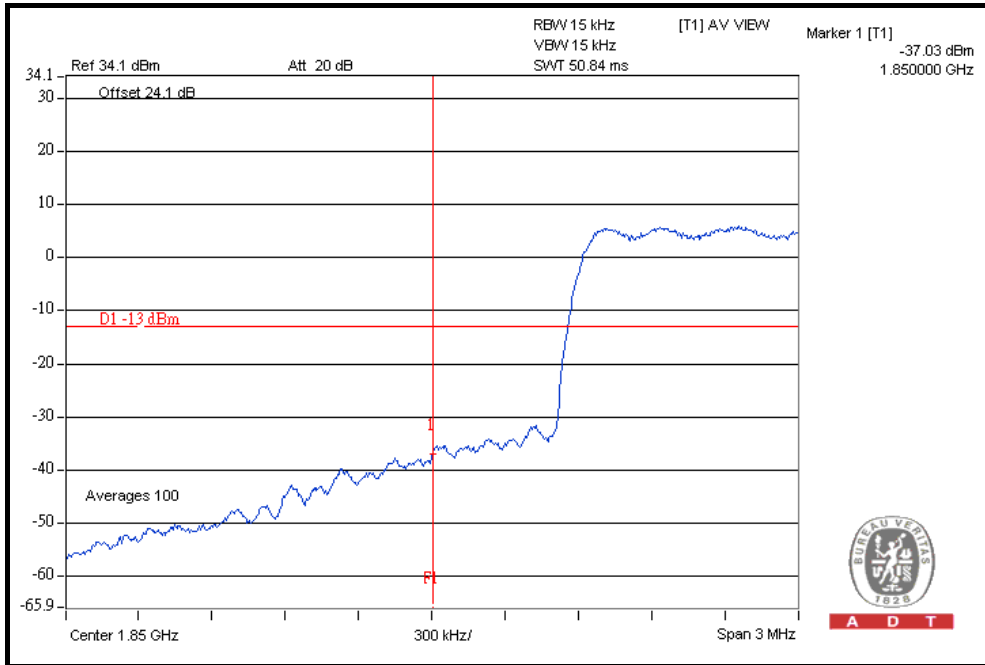

HIGHER BAND EDGE

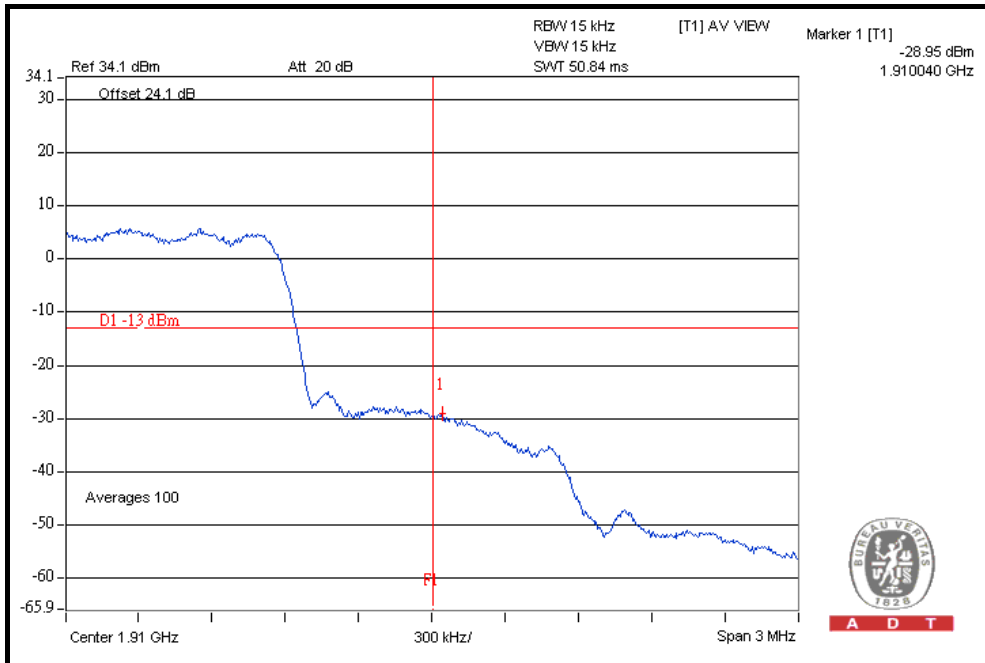



A D T

FOR EV-DO Rev. 0: LOWER BAND EDGE

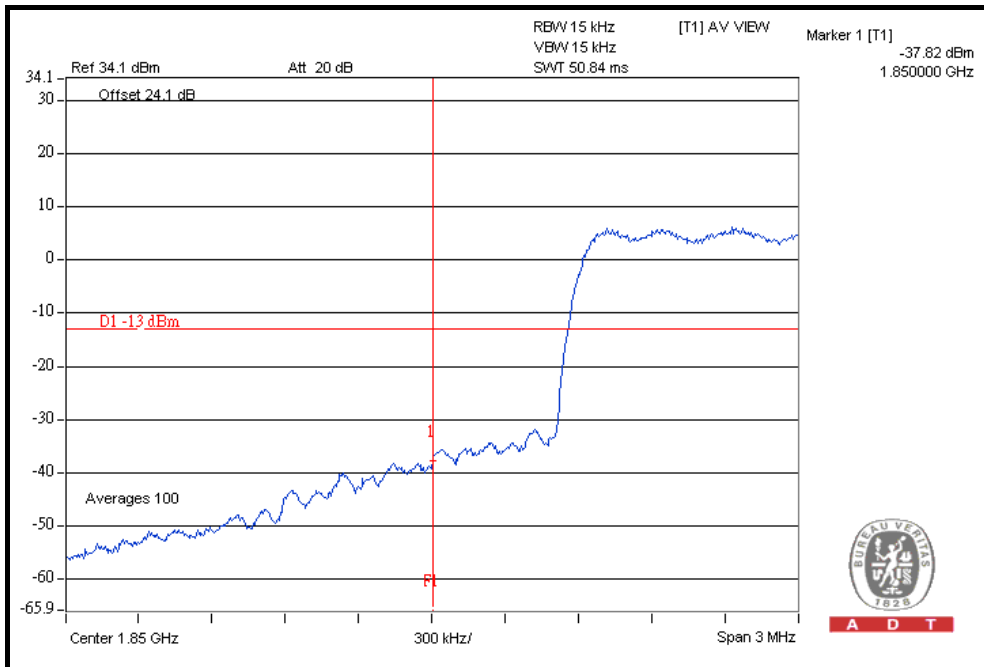

HIGHER BAND EDGE

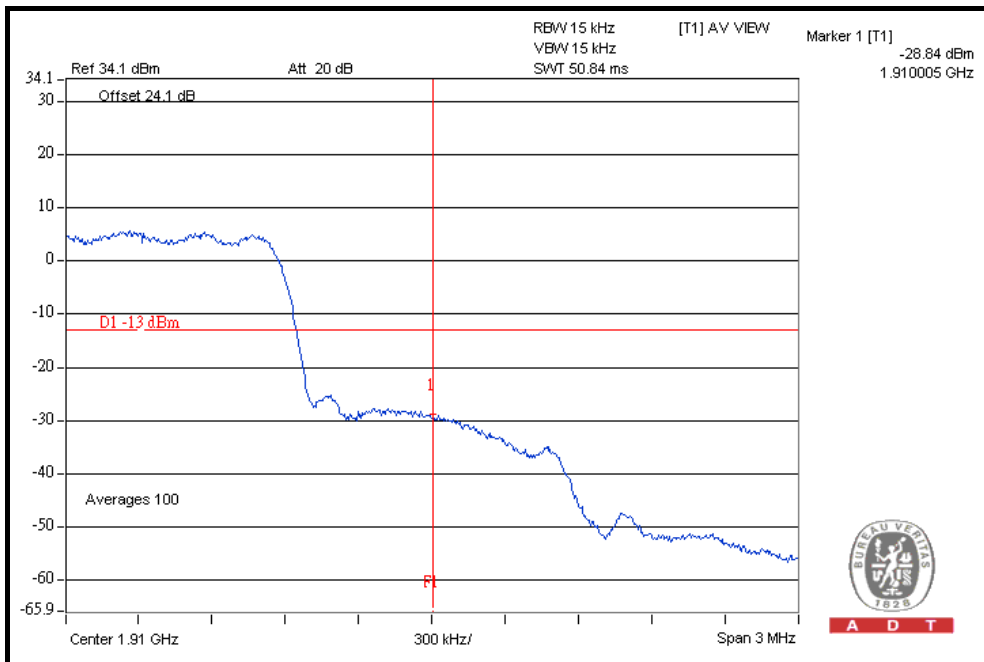



A D T

FOR WCDMA:

WCDMA MODE

LOWER BAND EDGE

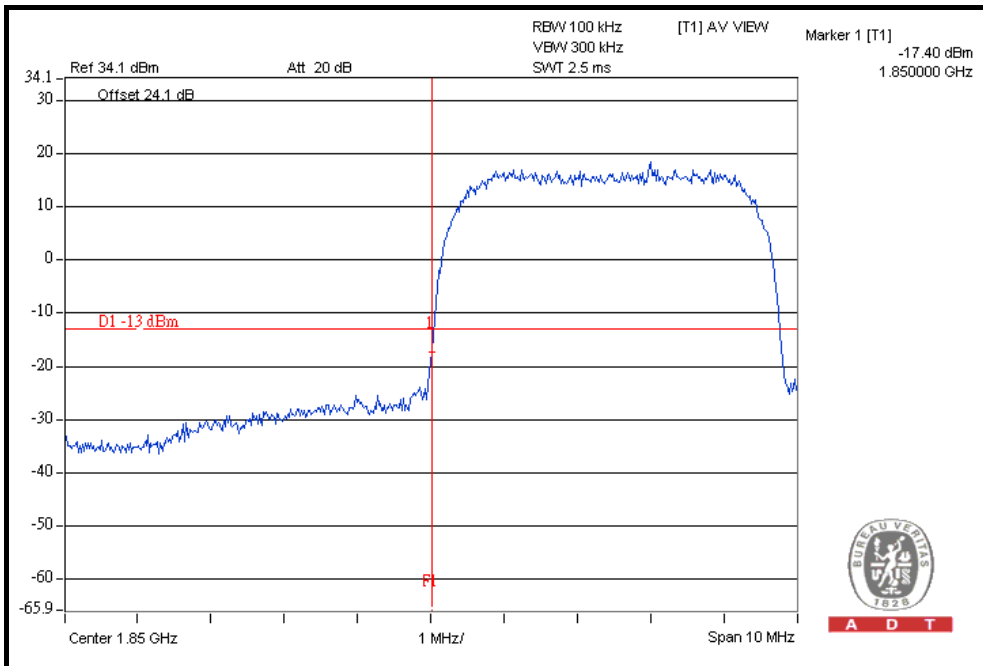

HIGHER BAND EDGE

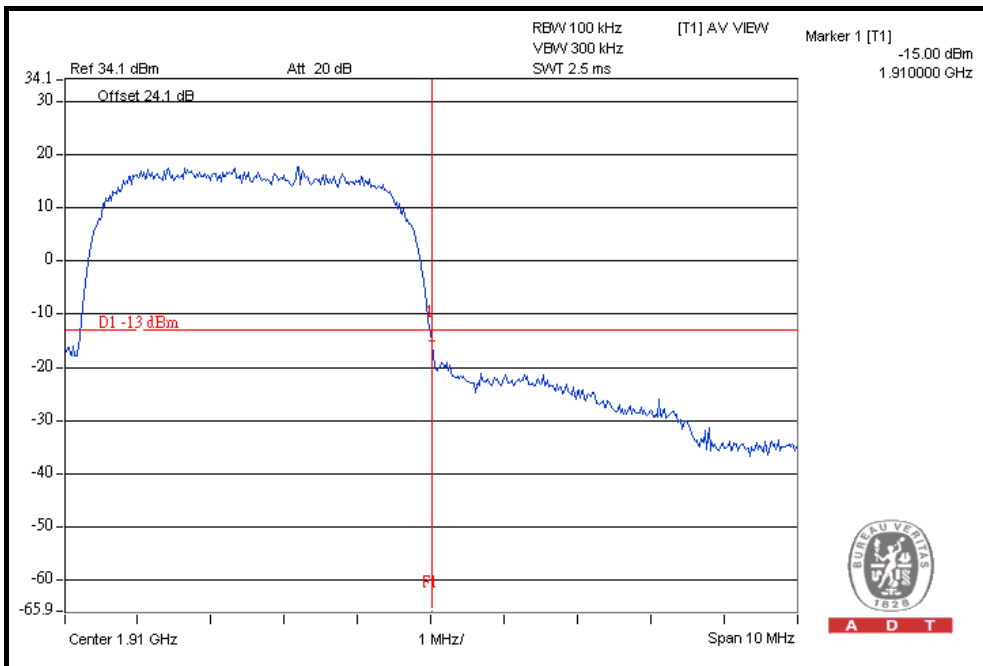



A D T

FOR HSDPA MODE

LOWER BAND EDGE

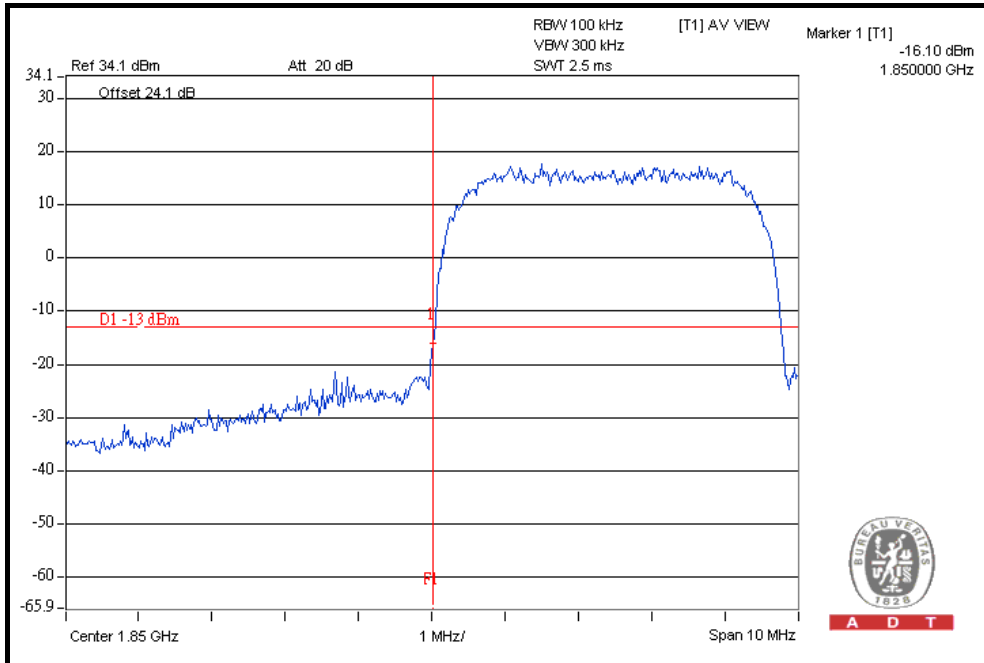

HIGHER BAND EDGE

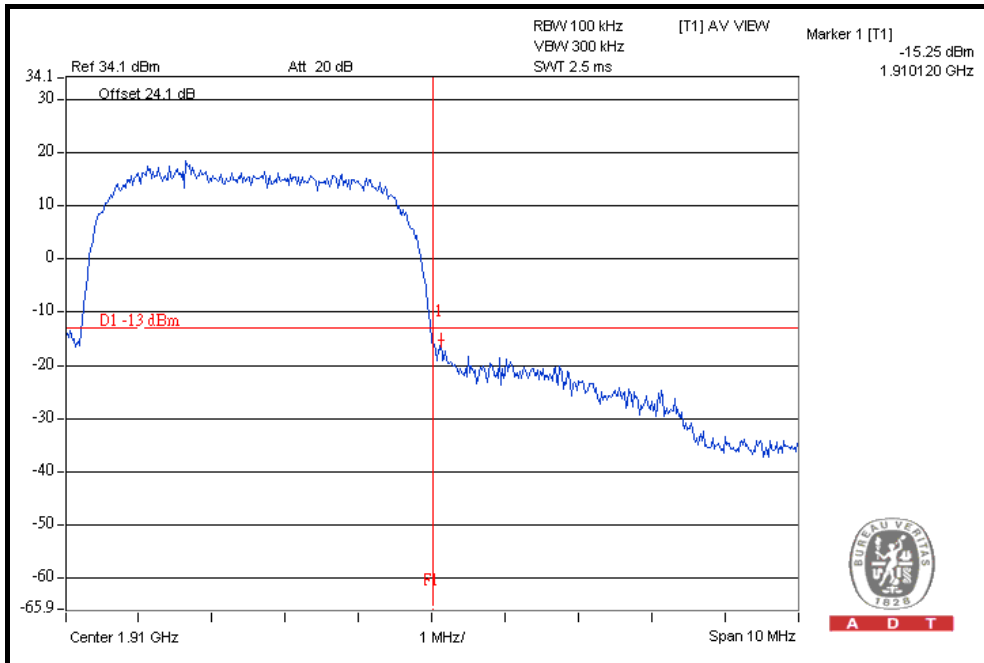



A D T

FOR HSUPA MODE

LOWER BAND EDGE

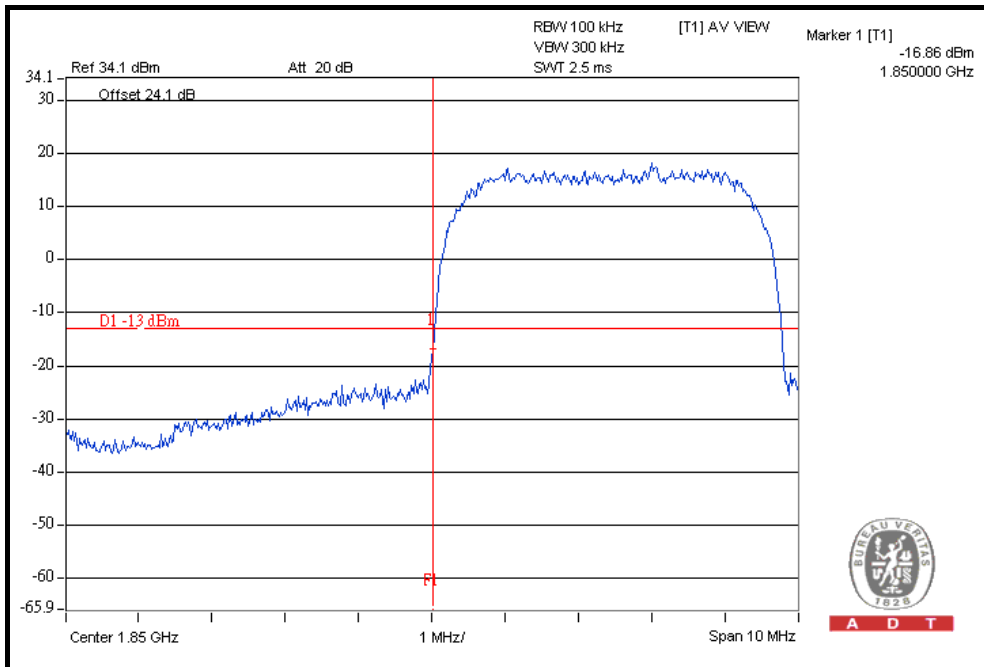

HIGHER BAND EDGE

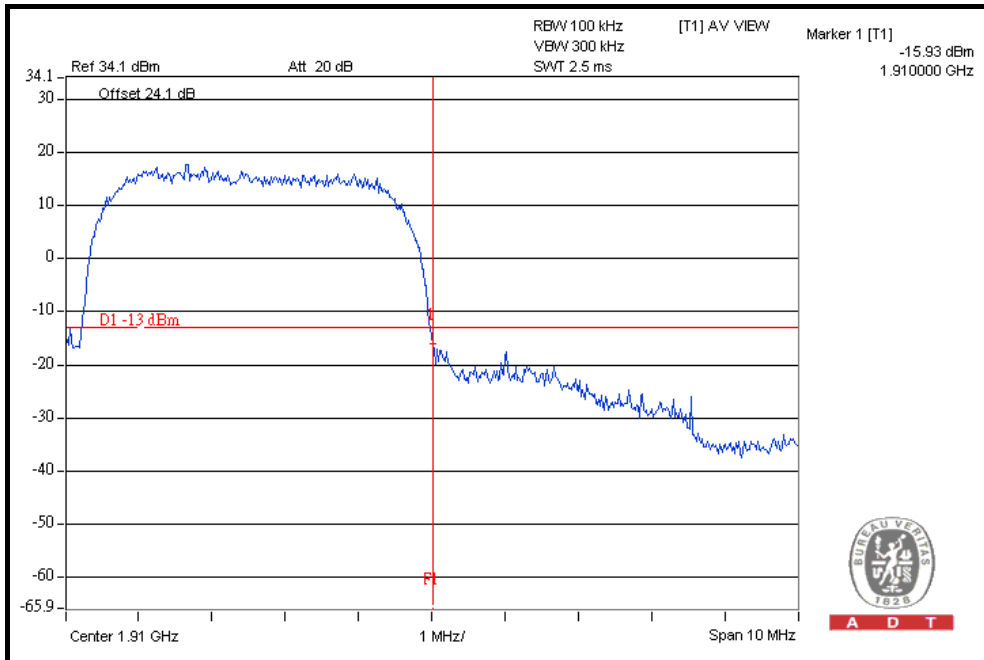

4.5 CONDUCTED SPURIOUS EMISSIONS

4.5.1 LIMITS OF CONDUCTED SPURIOUS EMISSIONS MEASUREMENT

In the FCC 24.238(a), On any frequency outside a licensee's frequency block within USPCS spectrum, the power of any emission shall be attenuated below the transmitter power (P) by at least $43 + 10 \log (P)$ dB. The specified minimum attenuation becomes 43dB and the limit of emission equal to -13dBm .

4.5.2 TEST INSTRUMENTS

DESCRIPTION & MANUFACTURER	MODEL NO.	SERIAL NO.	DATE OF CALIBRATION	DUE DATE OF CALIBRATION
ROHDE & SCHWARZ Spectrum Analyzer	FSP40	100040	Jul. 09, 2010	Jul. 08, 2011
Wainwright Instruments Band Reject Filter	WRCG 824/849-810/ 863-60/9SS	SN1	Mar. 25, 2010	Mar. 24, 2011
WI Highpass filter	WHK1.5/15G-10ST	SN1	Mar. 30, 2010	Mar. 29, 2011
Mini-Circuits Power Splitter	ZN2PD-9G	NA	Jun. 25, 2010	Jun. 24, 2011
RF cable	SUCOFLEX 104	274403/4	Aug. 20, 2010	Aug. 19, 2011
RF cable	SUCOFLEX 104	250729/4	Aug. 19, 2010	Aug. 18, 2011
RF cable	SUCOFLEX 104	214377/4	Aug. 19, 2010	Aug. 18, 2011
JFW 20dB attenuation	50HF-020-SMA	NA	NA	NA

NOTE: The calibration interval of the above test instruments is 12 months. And the calibrations are traceable to NML/ROC and NIST/USA.

4.5.3 TEST PROCEDURE

- a. The EUT makes a phone call to the communication simulator. The power was measured with R&S Spectrum Analyzer. All measurements were done at 3 channels, 512, 661 and 810 (GPRS) / 25, 600 and 1175 (CDMA) / 9262, 9400 and 9538 (WCDMA) (low, middle and high operational frequency range.)
- b. The conducted spurious emission used the power splitter via EUT RF power connector between simulation base station and spectrum analyzer. This splitter loss and cable loss are the worst loss 24.1dB in the transmitted path track.
- c. When the spectrum scanned from 9kHz to 3GHz, it shall be connected to the band reject filter attenuated the carried frequency. The spectrum set RB=1MHz, VB=3MHz.
- d. When the spectrum scanned from 3kHz to 20GHz, it shall be connected to the high pass filter attenuated the carried frequency. The spectrum set set RB=1MHz, VB=3MHz .

4.5.4 TEST SETUP

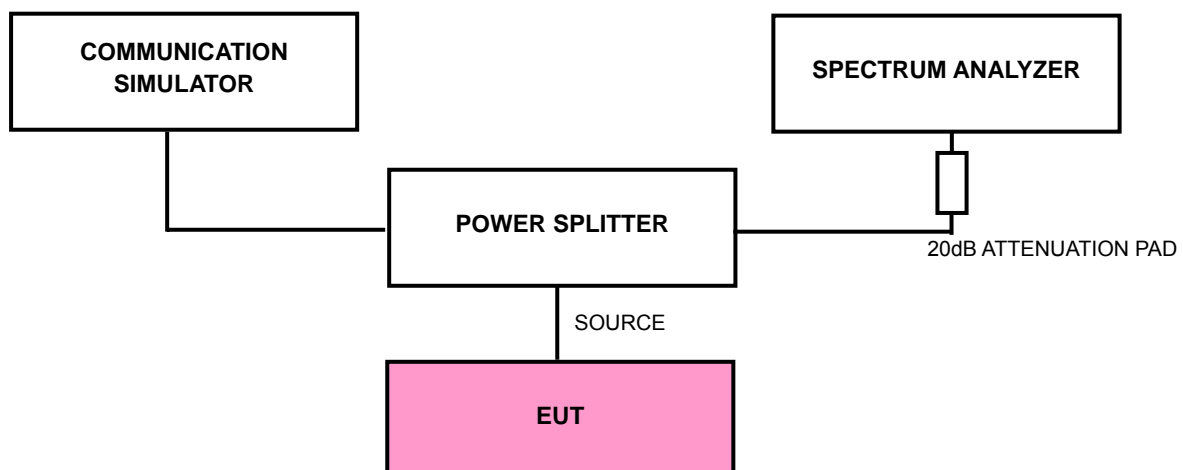

4.5.5 EUT OPERATING CONDITIONS

- a. The EUT makes a phone call to the communication simulator.
- b. The communication simulator station system controlled an EUT to export maximum output power under transmission mode and specific channel frequency.

4.5.6 TEST RESULTS

FOR GPRS:

CH 512: 9kHz ~ 3GHz

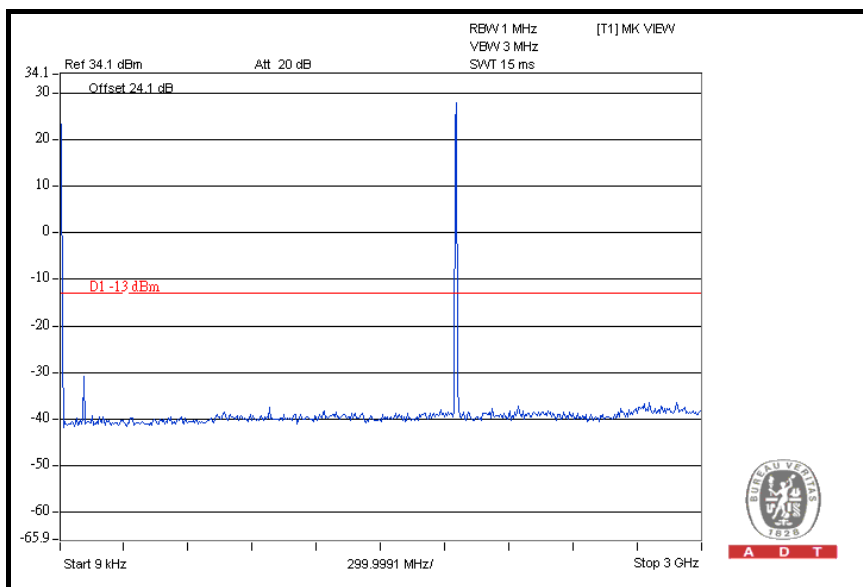

3GHz ~ 10GHz

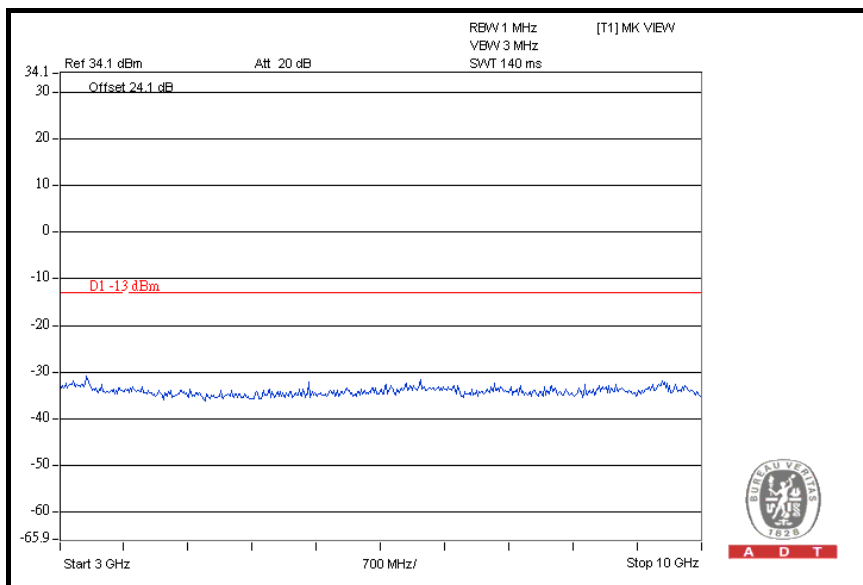



A D T

10GHz ~ 20GHz

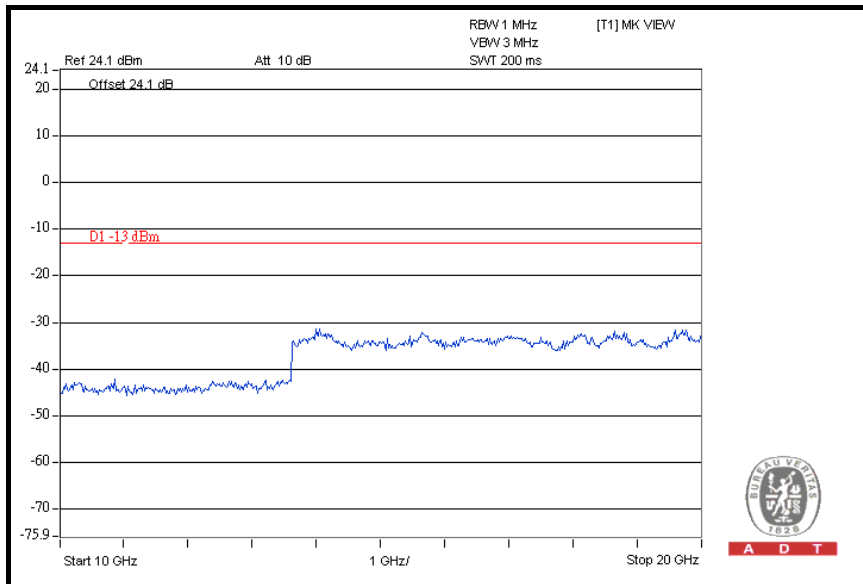

CH 661: 9kHz ~ 3GHz

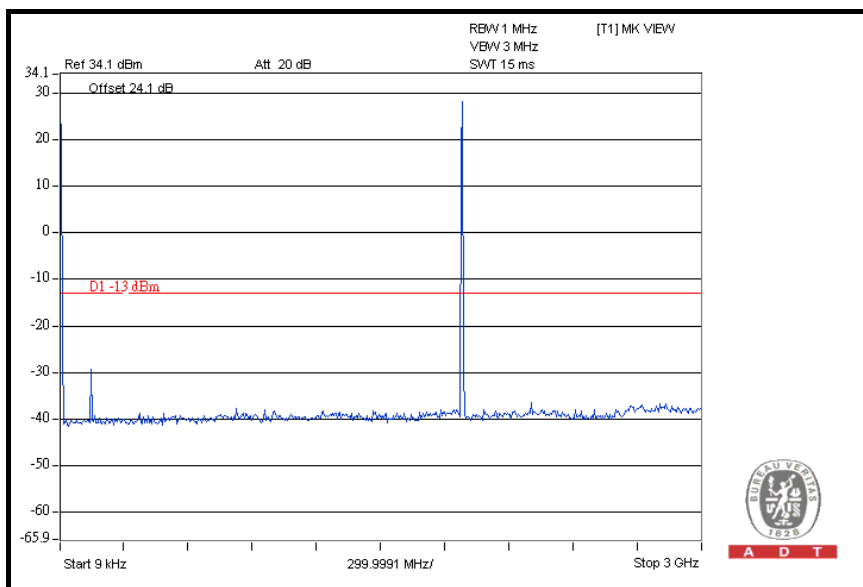



A D T

3GHz ~ 10GHz

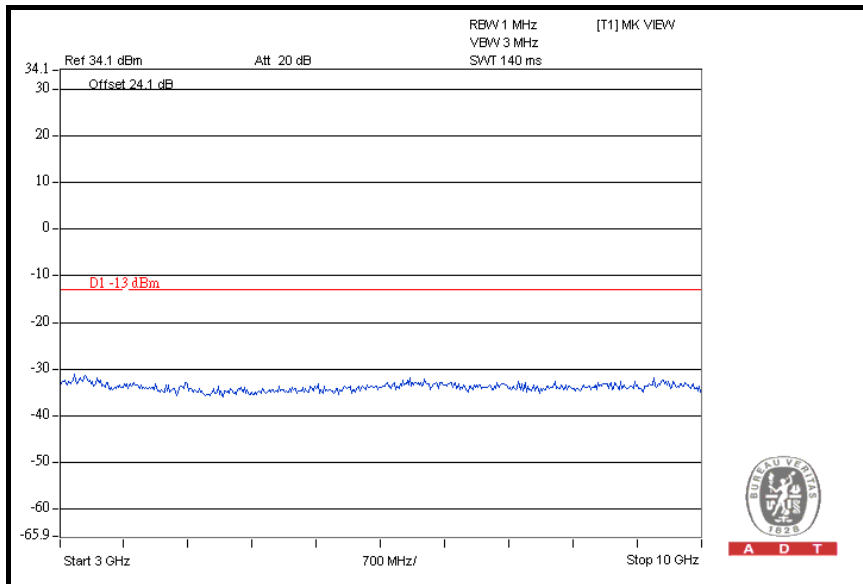

10GHz ~ 20GHz

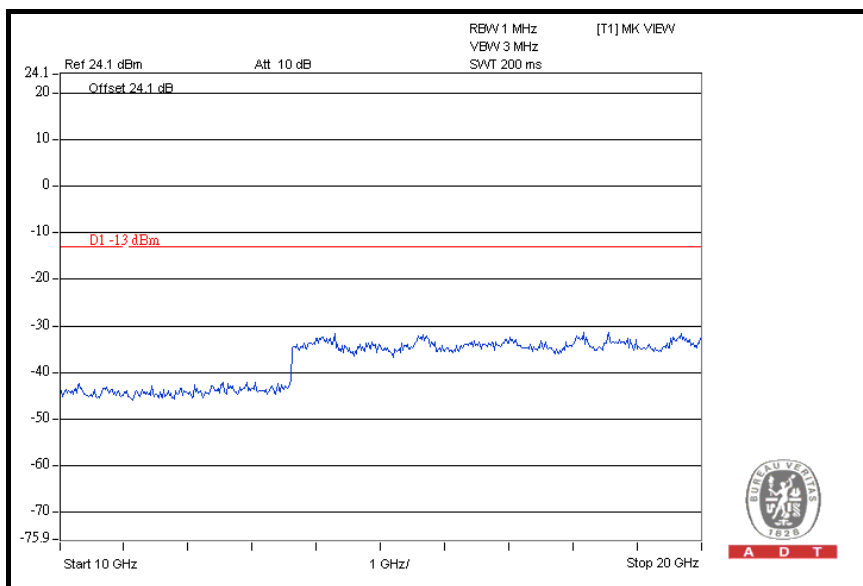



A D T

CH 810: 9kHz ~ 3GHz

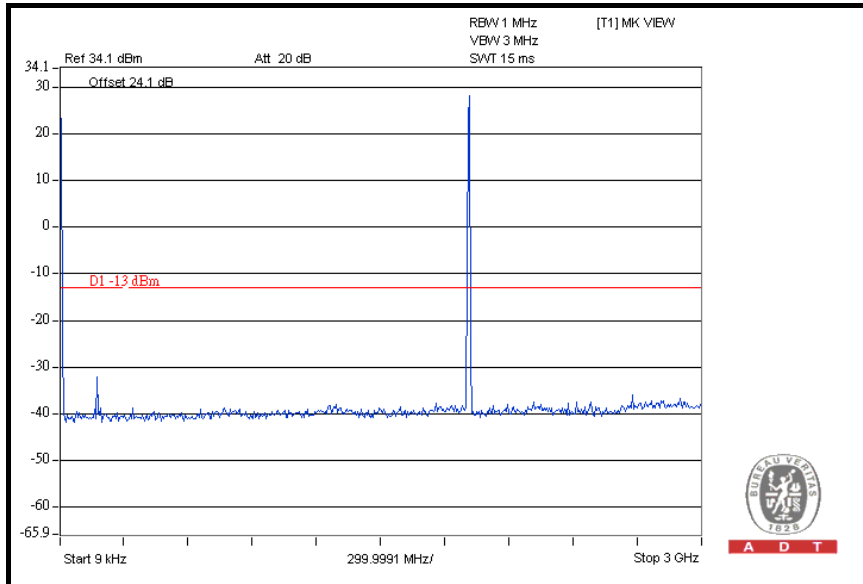

3GHz ~ 10GHz

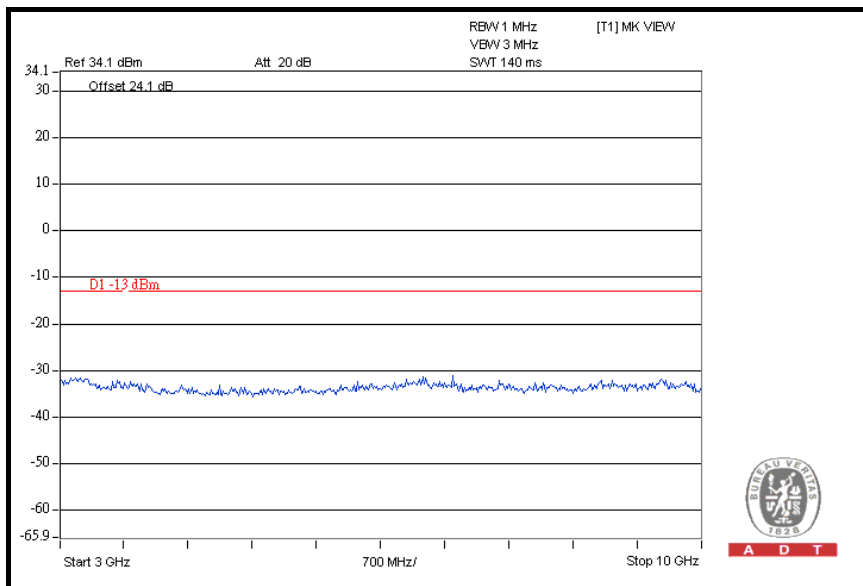



A D T

10GHz ~ 20GHz

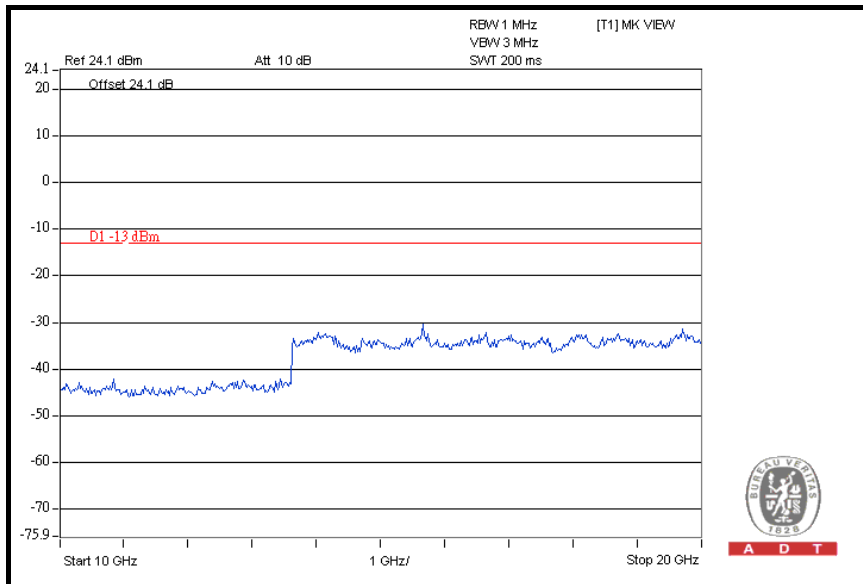



A D T

FOR CDMA:

CH 25: 9kHz ~ 3GHz

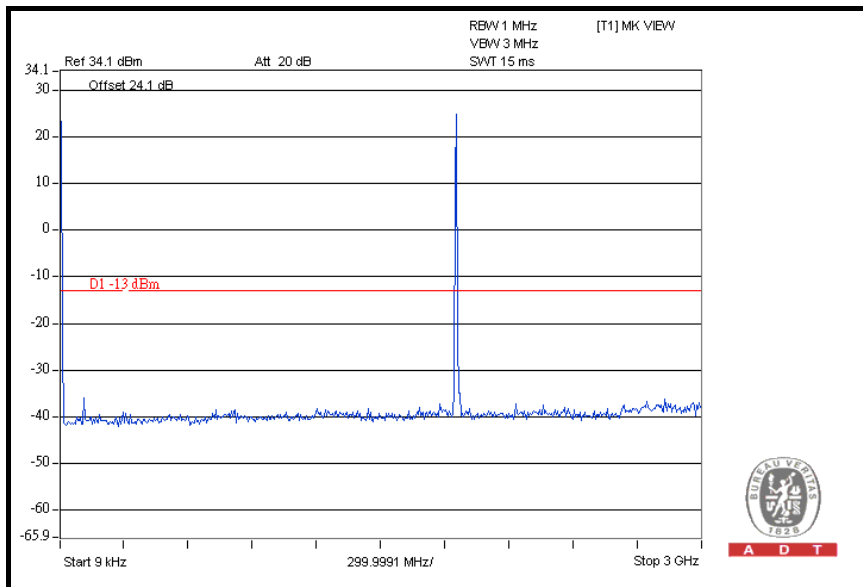

3GHz ~ 10GHz

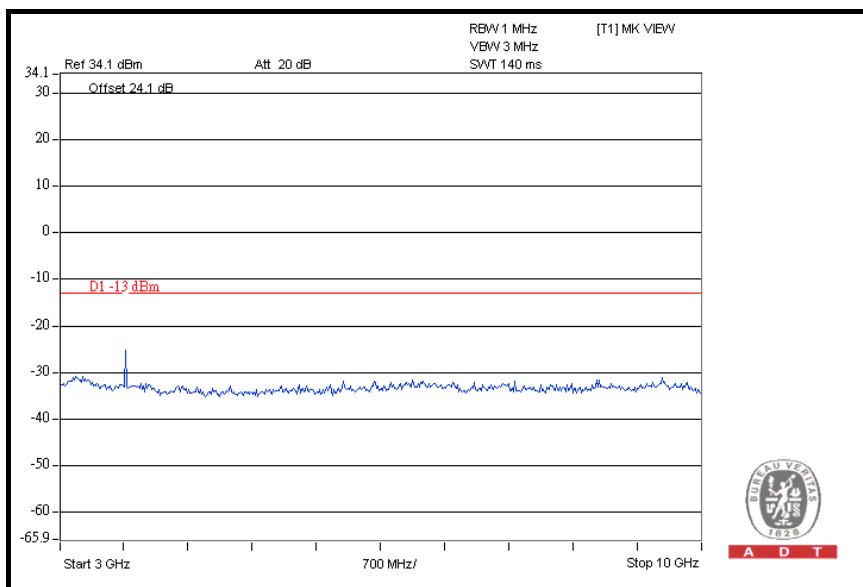



A D T

10GHz ~ 20GHz

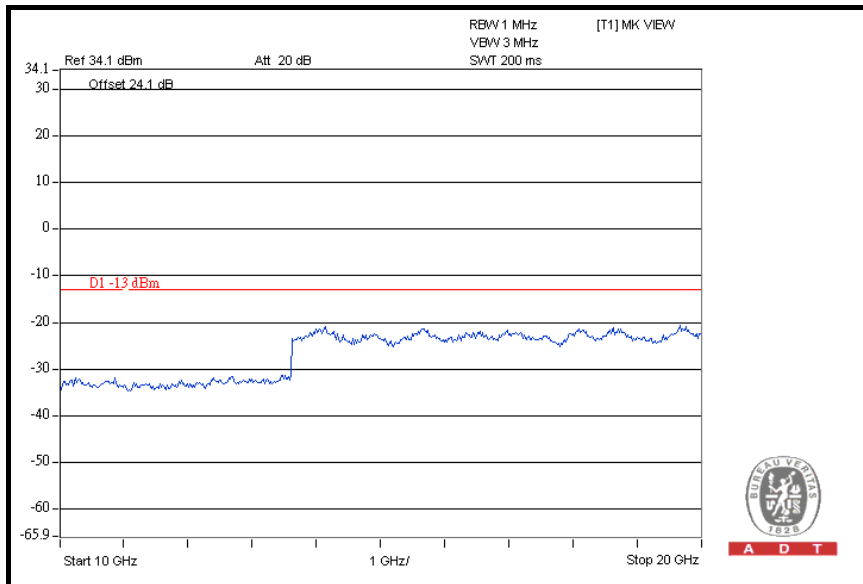

CH 600: 9kHz ~ 3GHz

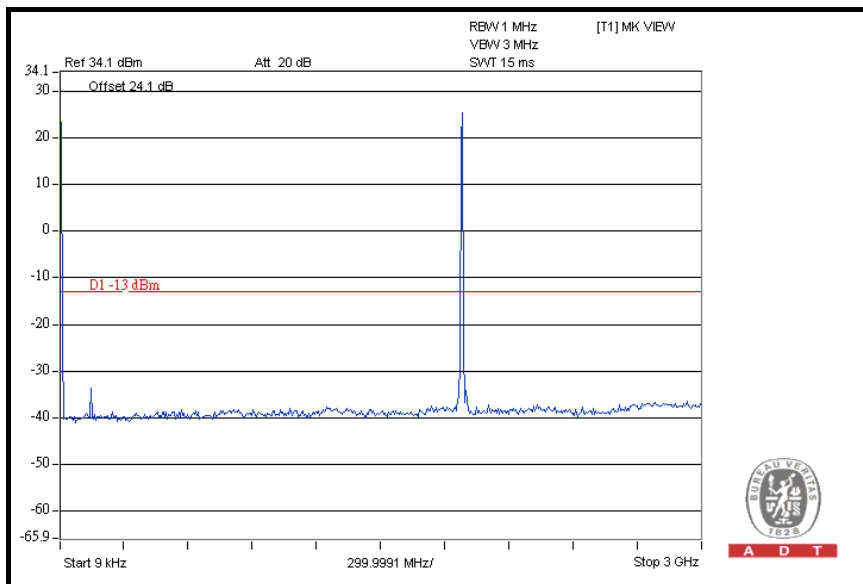



A D T

3GHz ~ 10GHz

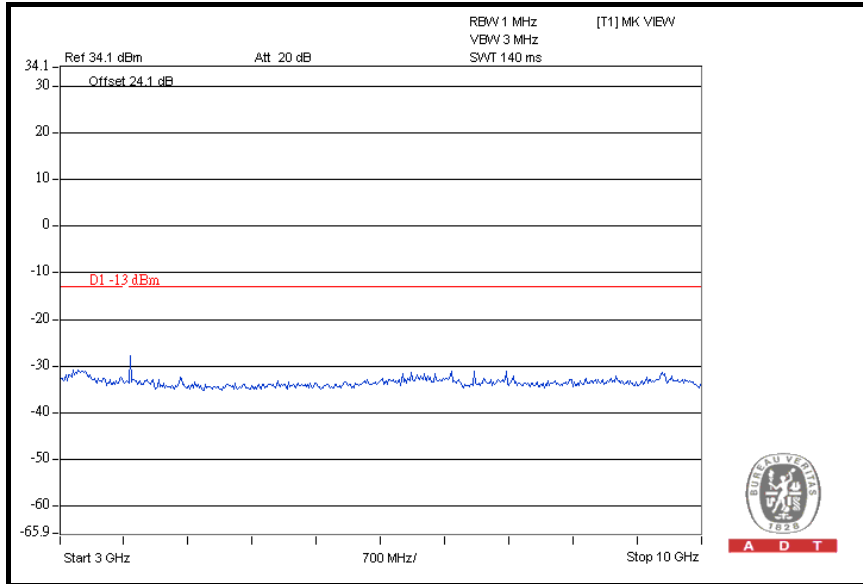

10GHz ~ 20GHz

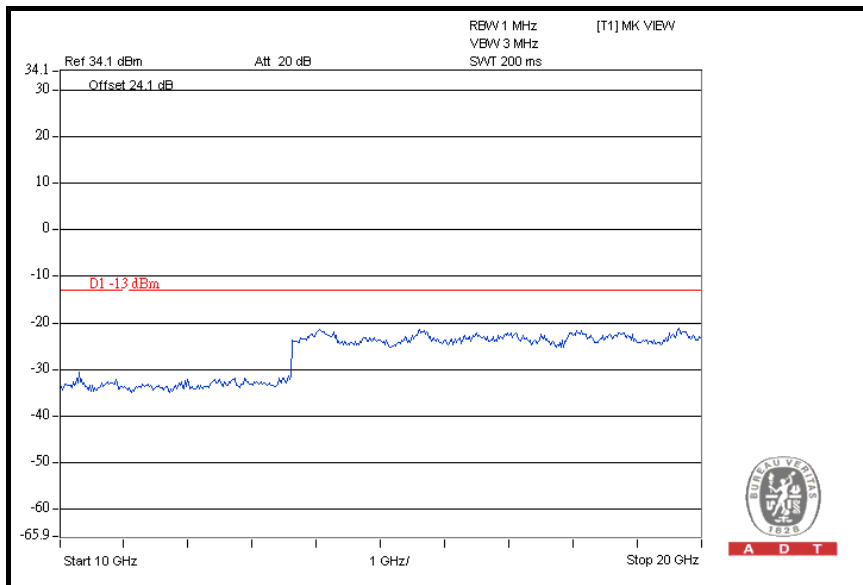



A D T

CH 1175: 9kHz ~ 3GHz

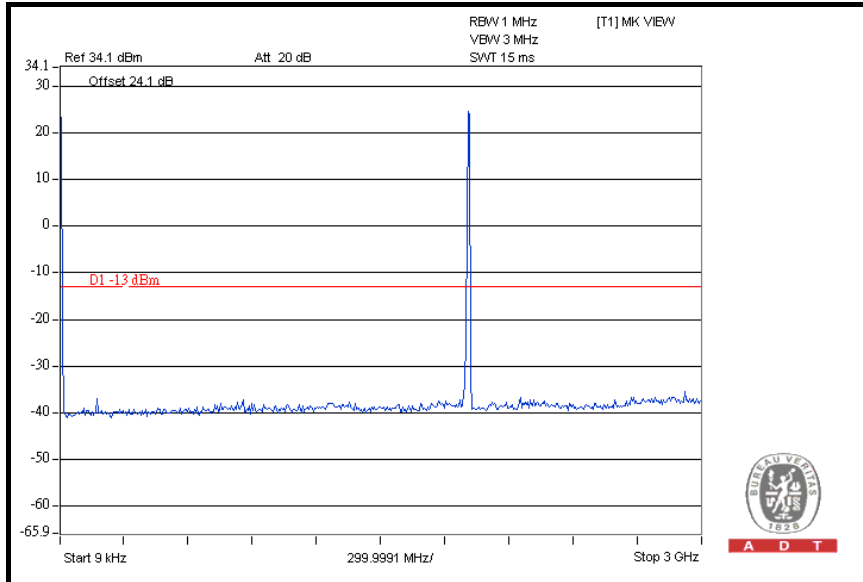

3GHz ~ 10GHz

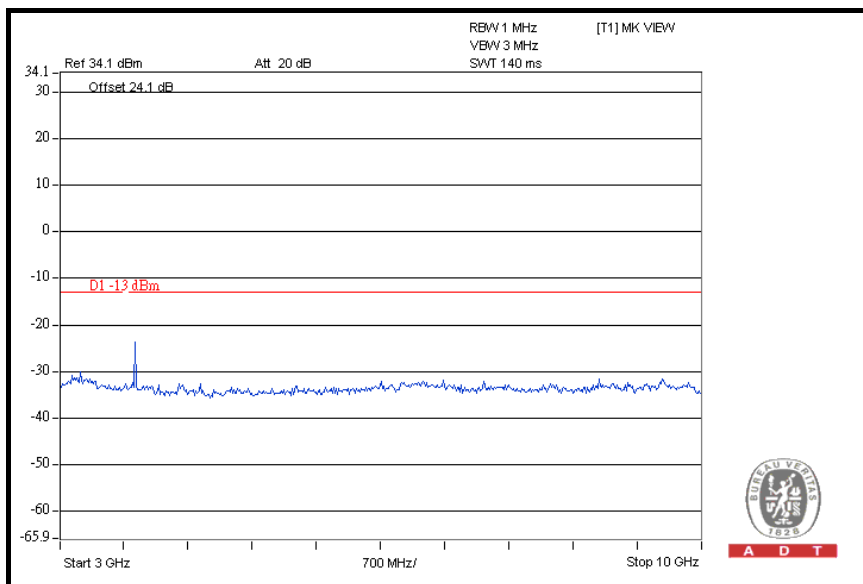



A D T

10GHz ~ 20GHz

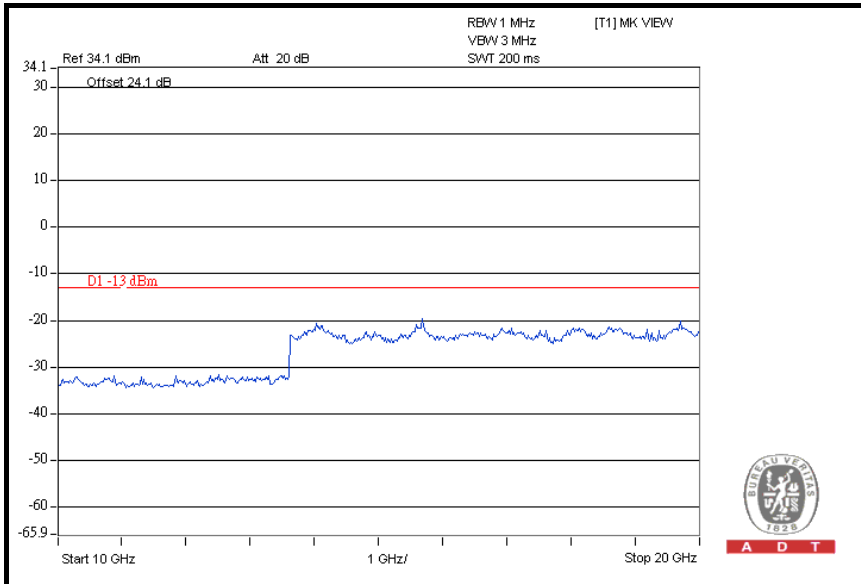



A D T

FOR WCDMA:

CH 9262: 9kHz ~ 3GHz

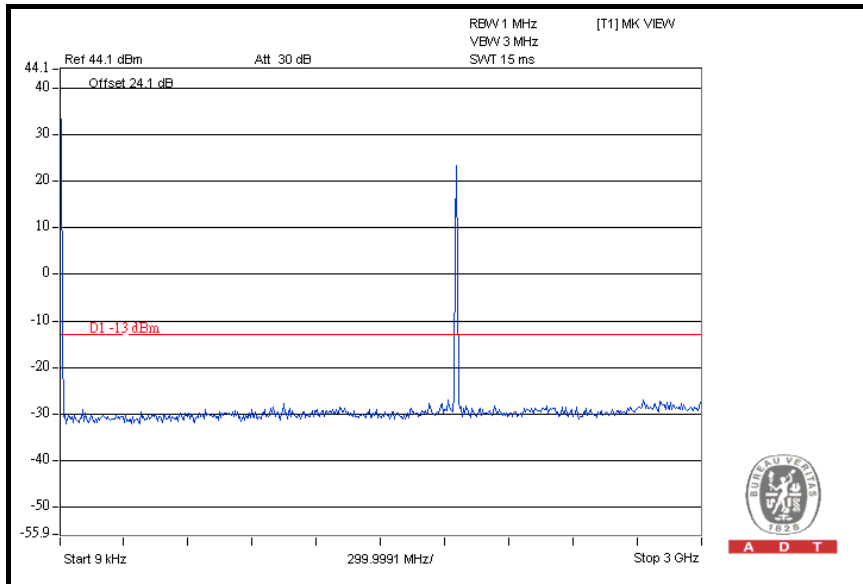

3GHz ~ 10GHz

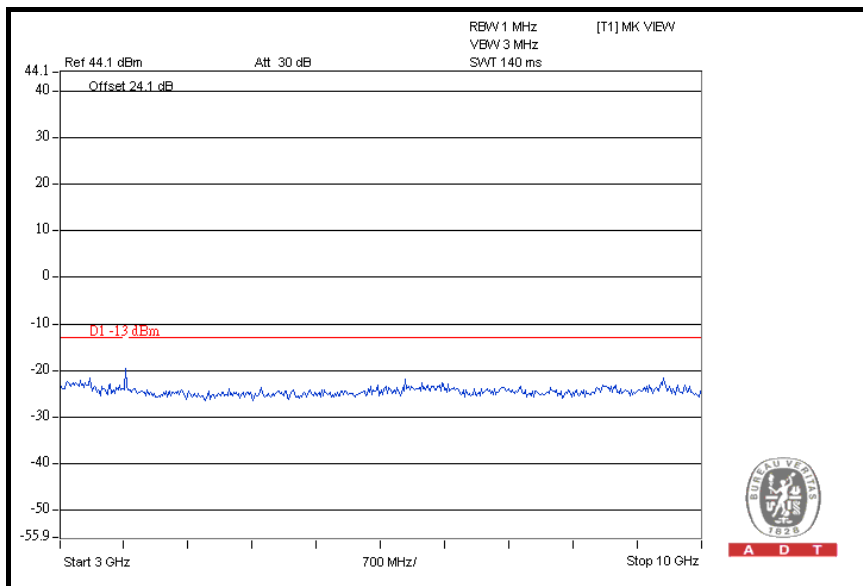



A D T

10GHz ~ 20GHz

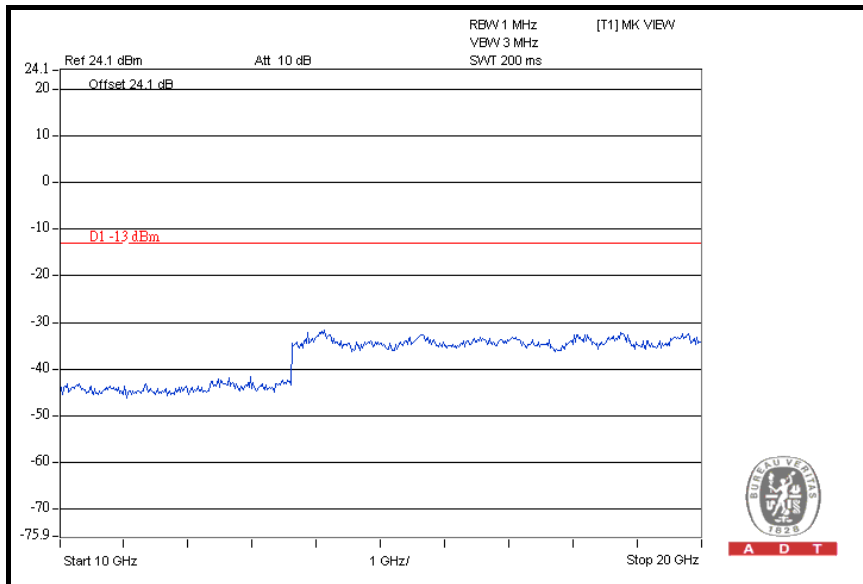

CH 9400: 9kHz ~ 3GHz

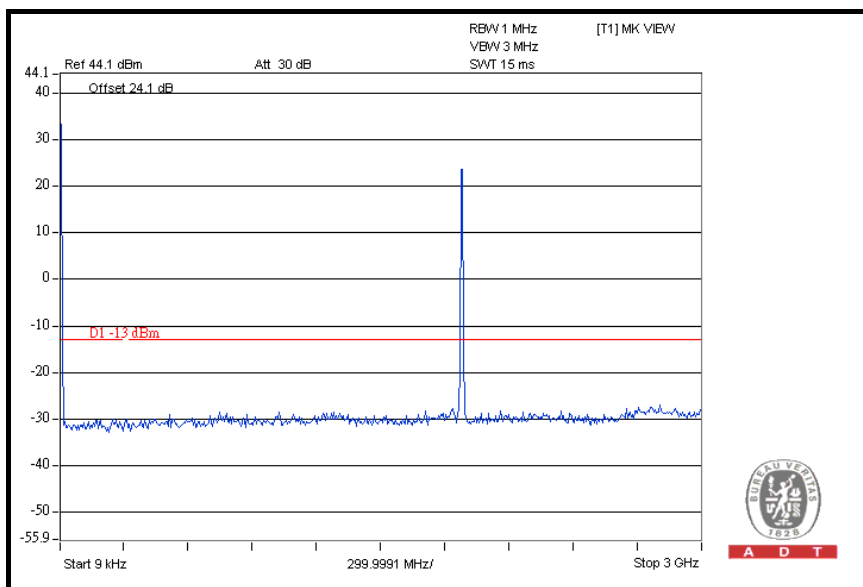



A D T

3GHz ~ 10GHz

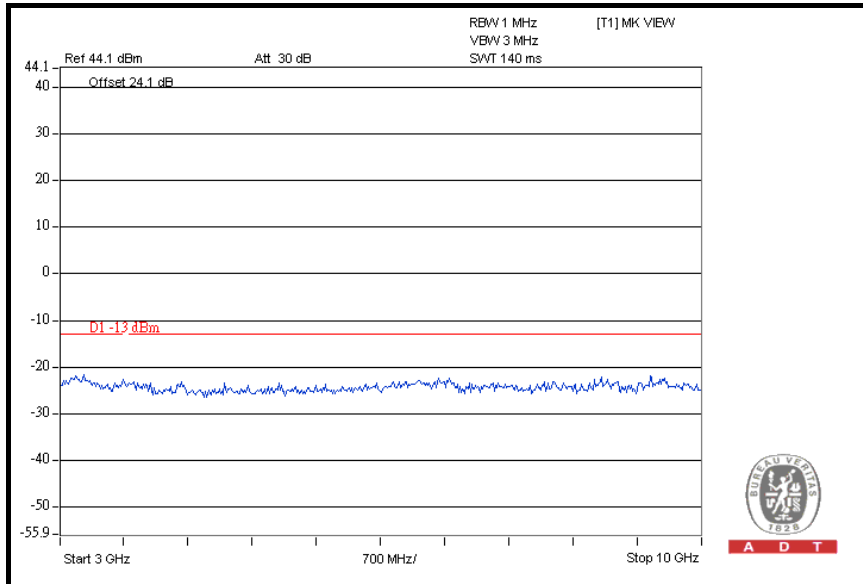

10GHz ~ 20GHz

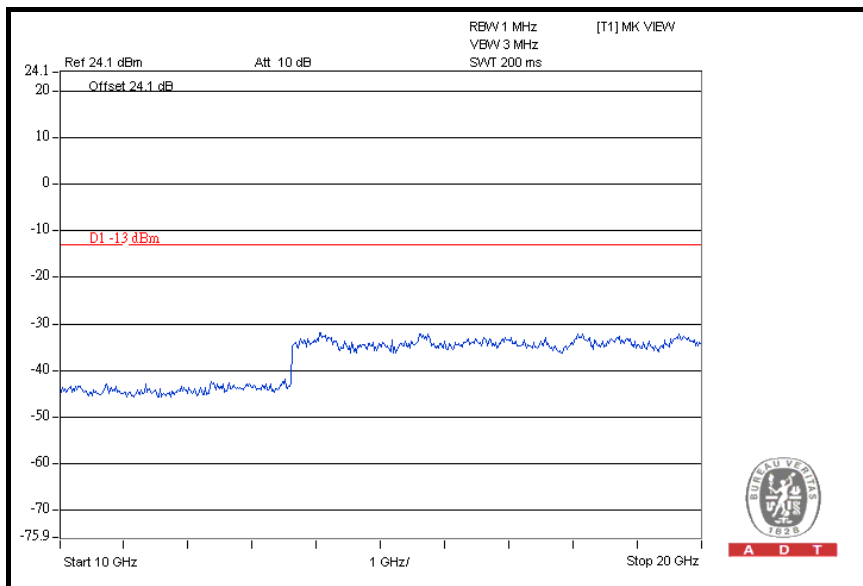



A D T

CH 9538: 9kHz ~ 3GHz

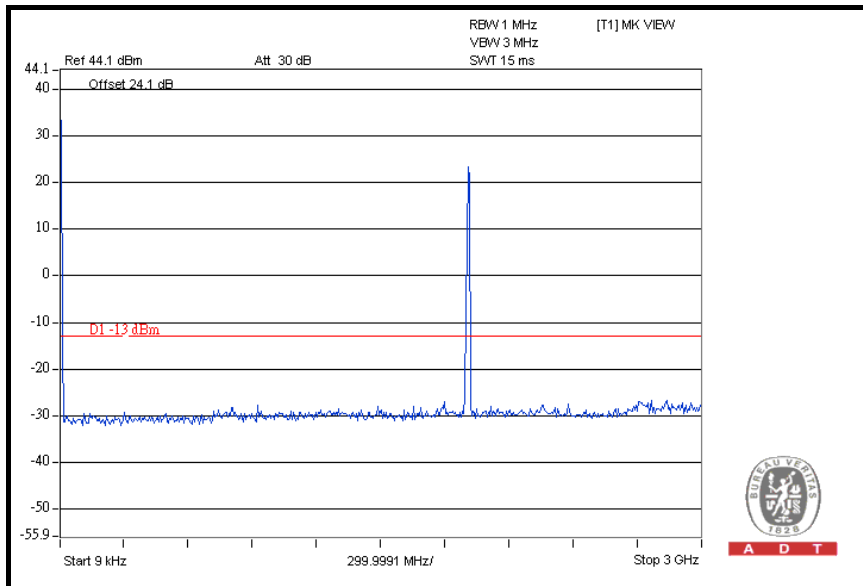

3GHz ~ 10GHz

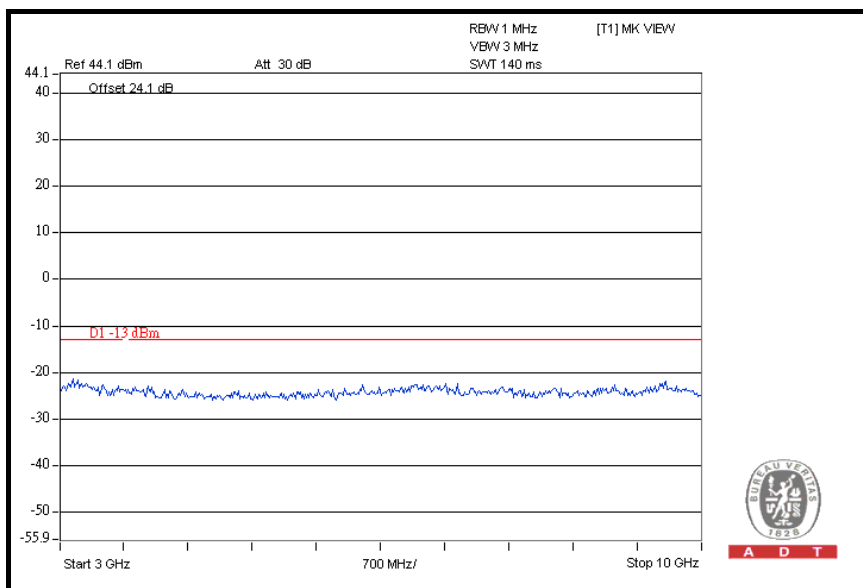



A D T

10GHz ~ 20GHz

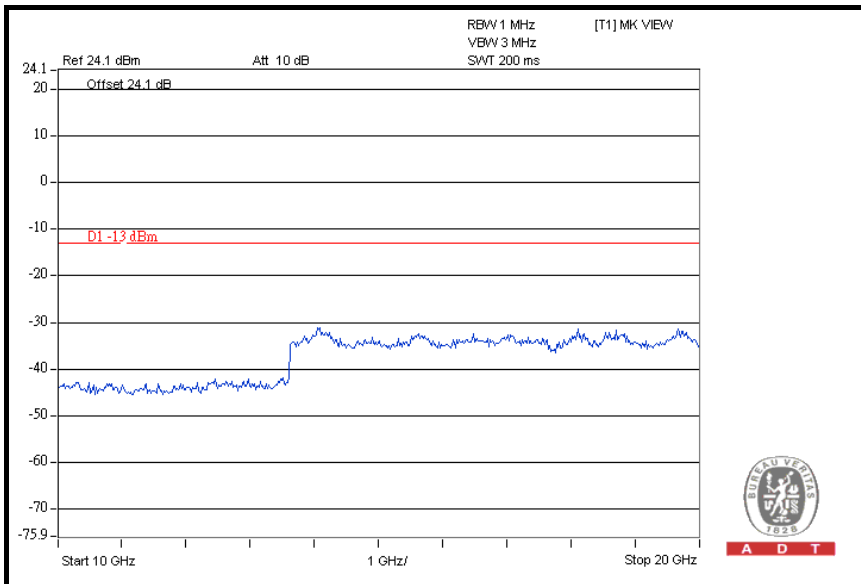

4.6 RADIATED EMISSION MEASUREMENT (BELOW 1GHz)

4.6.1 LIMITS OF RADIATED EMISSION MEASUREMENT

In the FCC 24.238(a), On any frequency outside a licensee's frequency block within USPCS spectrum, the power of any emission shall be attenuated below the transmitter power (P) by at least $43 + 10 \log (P)$ dB. The emission of limit equal to -13 dBm. So the limit of emission is the same absolute specified line.

LIMIT (dBm)	EQUIVALENT FIELD STRENGTH AT 3m (dBuV/m) (NOTE)
-13	82.2

NOTE: The following formula is used to convert the equipment radiated power to field strength.

$$E = [1000000\sqrt{(30P)}] / 3 \text{ uV/m, where P is Watts.}$$

4.6.2 TEST INSTRUMENTS

Same as 4.1.2.

4.6.3 TEST PROCEDURES

- a. The EUT was placed on the top of a rotating table 0.8 meters above the ground at a 3 meters semi-anechoic chamber. The table was rotated 360 degrees to determine the position of the highest radiation.
- b. The EUT was set 3 meters away from the interference-receiving antenna, which was mounted on the top of a variable-height antenna tower.
- c. The antenna is a broadband antenna, and its height is varied from one meter to four meters above the ground to determine the maximum value of the field strength. Both horizontal and vertical polarizations of the antenna are set to make the measurement.
- d. For each suspected emission, the EUT was arranged to its worst case and then the antenna was tuned to heights from 1 meter to 4 meters and the rotatable table was turned from 0 degrees to 360 degrees to find the maximum reading.
- e. The test-receiver system was set to Peak Detect Function and Specified Bandwidth with Maximum Hold Mode.
- f. If the emission level of the EUT in peak mode was lower than the limit specified, then testing could be stopped and the peak values of the EUT would be reported. Otherwise the emissions would be re-tested one by one using peak, quasi-peak or average method as specified and then reported in a data sheet.

NOTE: The resolution bandwidth of spectrum analyzer is 1 MHz and the video bandwidth is 3 MHz.

4.6.4 DEVIATION FROM TEST STANDARD

No deviation

4.6.5 TEST SETUP

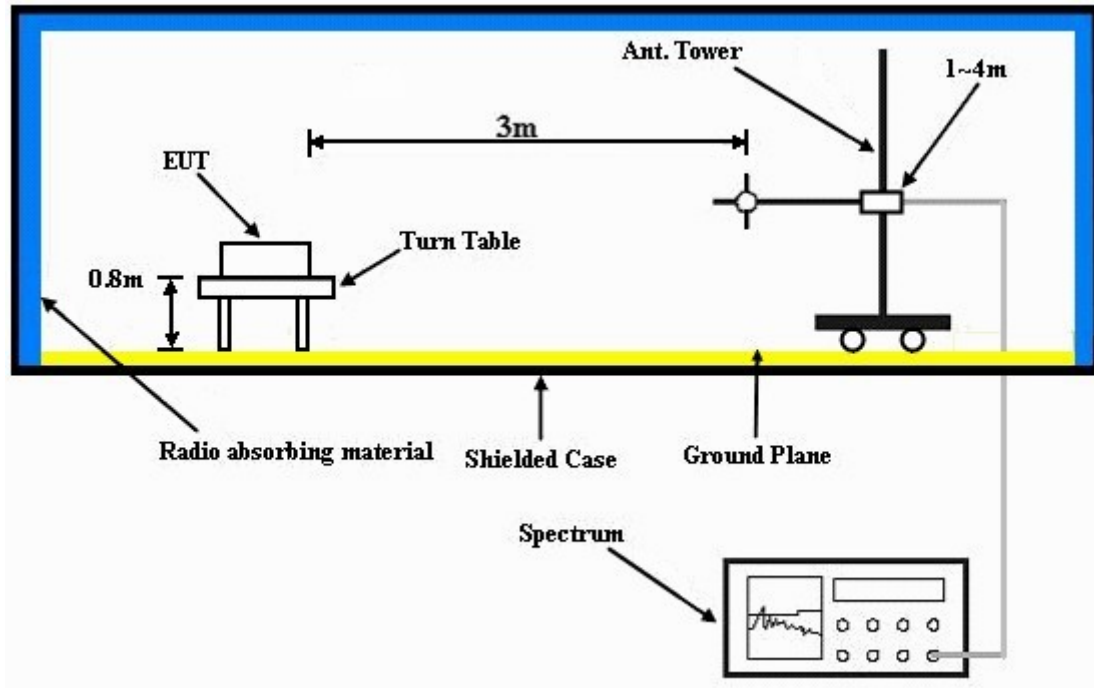

For the actual test configuration, please refer to the attached file (Test Setup Photo).

4.6.6 EUT OPERATING CONDITIONS

- a. The EUT makes a call to the communication simulator.
- b. The communication simulator station system controlled an EUT to export maximum output power under transmission mode and specific channel frequency.

4.6.7 TEST RESULTS

FOR GPRS:

MODE	TX channel 661	FREQUENCY RANGE	Below 1000 MHz
ENVIRONMENTAL CONDITIONS	25deg. C, 68%RH, 991hPa	INPUT POWER	120Vac, 60 Hz
TESTED BY	Sun Lin		

ANTENNA POLARITY & TEST DISTANCE: HORIZONTAL AT 3 M								
No.	Freq. (MHz)	Emission Level (dBuV/m)	Limit (dBuV/m)	Margin (dB)	Antenna Height (m)	Table Angle (Degree)	Raw Value (dBuV)	Correction Factor (dB/m)
1	113.59	50.6	82.2	-31.7	3.00 H	214	38.9	11.7
2	168.02	53.3	82.2	-29.0	1.25 H	136	39.7	13.6
3	333.25	52.1	82.2	-30.2	1.00 H	10	36.6	15.5
4	451.82	56.8	82.2	-25.5	2.00 H	229	38.2	18.6
5	630.66	48.7	82.2	-33.6	1.25 H	220	26.2	22.5
6	797.84	56.9	82.2	-25.4	1.50 H	94	32.3	24.6
ANTENNA POLARITY & TEST DISTANCE: VERTICAL AT 3 M								
No.	Freq. (MHz)	Emission Level (dBuV/m)	Limit (dBuV/m)	Margin (dB)	Antenna Height (m)	Table Angle (Degree)	Raw Value (dBuV)	Correction Factor (dB/m)
1	57.21	67.1	82.2	-15.2	1.00 V	352	53.6	13.5
2	115.53	51.2	82.2	-31.1	1.00 V	172	39.3	11.9
3	181.62	45.6	82.2	-36.7	1.00 V	130	33.3	12.3
4	290.48	47.1	82.2	-35.2	1.25 V	253	32.8	14.3
5	451.82	50.1	82.2	-32.2	2.50 V	154	31.5	18.6
6	799.78	57.8	82.2	-24.5	1.50 V	199	33.2	24.6

NOTE:

1. Emission level (dBuV/m) = Raw Value (dBuV) + Correction Factor (dB).
2. Correction Factor (dB/m) = Antenna Factor (dB/m) + Cable Factor (dB).
3. The other emission levels were very low against the limit.
4. Margin value = Emission level – Limit value.
5. This is valid for all 3 channels.



A D T

FOR CDMA:

MODE	TX channel 25	FREQUENCY RANGE	Below 1000MHz
ENVIRONMENTAL CONDITIONS	25deg. C, 68%RH, 991hPa	INPUT POWER	120Vac, 60 Hz
TESTED BY	Sun Lin		

ANTENNA POLARITY & TEST DISTANCE: HORIZONTAL AT 3 M								
No.	Freq. (MHz)	Emission Level (dBuV/m)	Limit (dBuV/m)	Margin (dB)	Antenna Height (m)	Table Angle (Degree)	Raw Value (dBuV)	Correction Factor (dB/m)
1	113.59	51.0	82.2	-31.3	3.00 H	235	39.3	11.7
2	311.86	52.7	82.2	-29.6	1.00 H	316	37.7	15.0
3	453.77	55.2	82.2	-27.1	2.00 H	169	36.6	18.6
4	628.72	49.0	82.2	-33.3	1.00 H	169	26.5	22.5
5	799.78	55.4	82.2	-26.9	3.00 H	55	30.8	24.6
6	931.96	51.6	82.2	-30.7	1.50 H	25	25.2	26.4
ANTENNA POLARITY & TEST DISTANCE: VERTICAL AT 3 M								
No.	Freq. (MHz)	Emission Level (dBuV/m)	Limit (dBuV/m)	Margin (dB)	Antenna Height (m)	Table Angle (Degree)	Raw Value (dBuV)	Correction Factor (dB/m)
1	57.21	66.6	82.2	-15.7	1.00 V	7	53.1	13.5
2	109.70	51.4	82.2	-30.9	1.25 V	184	40.2	11.2
3	333.25	51.2	82.2	-31.1	1.00 V	199	35.7	15.5
4	449.88	58.0	82.2	-24.3	1.00 V	151	39.5	18.5
5	630.66	46.4	82.2	-35.9	1.50 V	124	23.9	22.5
6	799.78	61.1	82.2	-21.2	1.25 V	55	36.5	24.6

NOTE:

1. Emission level (dBuV/m) = Raw Value (dBuV) + Correction Factor (dB).
2. Correction Factor (dB/m) = Antenna Factor (dB/m) + Cable Factor (dB).
3. The other emission levels were very low against the limit.
4. Margin value = Emission level – Limit value.
5. This is valid for all 3 channels.

FOR WCDMA:

MODE	TX channel 9538	FREQUENCY RANGE	Below 1000 MHz
ENVIRONMENTAL CONDITIONS	25deg. C, 68%RH, 991hPa	INPUT POWER	120Vac, 60 Hz
TESTED BY	Sun Lin		

ANTENNA POLARITY & TEST DISTANCE: HORIZONTAL AT 3 M								
No.	Freq. (MHz)	Emission Level (dBuV/m)	Limit (dBuV/m)	Margin (dB)	Antenna Height (m)	Table Angle (Degree)	Raw Value (dBuV)	Correction Factor (dB/m)
1	68.88	56.6	82.2	-25.7	4.00 H	343	44.5	12.1
2	327.41	51.3	82.2	-31.0	1.00 H	133	35.9	15.4
3	444.05	54.8	82.2	-27.5	2.50 H	184	36.4	18.4
4	628.72	49.1	82.2	-33.2	1.00 H	169	26.6	22.5
5	799.78	51.4	82.2	-30.9	2.00 H	214	26.8	24.6
6	933.91	51.2	82.2	-31.1	1.50 H	22	24.8	26.4

ANTENNA POLARITY & TEST DISTANCE: VERTICAL AT 3 M								
No.	Freq. (MHz)	Emission Level (dBuV/m)	Limit (dBuV/m)	Margin (dB)	Antenna Height (m)	Table Angle (Degree)	Raw Value (dBuV)	Correction Factor (dB/m)
1	57.21	66.9	82.2	-15.4	1.00 V	349	53.4	13.5
2	111.64	50.6	82.2	-31.7	1.00 V	178	39.1	11.5
3	362.40	50.4	82.2	-31.9	2.00 V	40	34.2	16.2
4	453.77	55.6	82.2	-26.7	1.00 V	295	37.0	18.6
5	797.84	59.5	82.2	-22.8	1.25 V	10	34.9	24.6
6	933.91	49.6	82.2	-32.7	1.00 V	25	23.2	26.4

NOTE:

1. Emission level (dBuV/m) = Raw Value (dBuV) + Correction Factor (dB).
2. Correction Factor (dB/m) = Antenna Factor (dB/m) + Cable Factor (dB).
3. The other emission levels were very low against the limit.
4. Margin value = Emission level – Limit value.
5. This is valid for all 3 channels.

4.7 RADIATED EMISSION MEASUREMENT (ABOVE 1GHz)

4.7.1 LIMITS OF RADIATED EMISSION MEASUREMENT

In the FCC 24.238(a), On any frequency outside a licensee's frequency block within USPCS spectrum, the power of any emission shall be attenuated below the transmitter power (P) by at least $43 + 10 \log (P)$ dB. The specified minimum attenuation becomes 43dB and the limit of emission equal to -13dBm .

4.7.2 TEST INSTRUMENTS

Same as 4.1.2.

4.7.3 TEST PROCEDURES

- a. Substitution method is used for E.I.R.P measurement. In the semi-anechoic chamber, EUT placed on the 0.8m height of Turn Table, rotated the table around 360 degrees to search the maximum radiation power and receiver antenna shall be rotated vertical and horizontal polarization and moved height from 1m to 4m to find the maximum polar radiated power. The “Read Value” is the spectrum reading the maximum power value.
- b. The substitution horn antenna is substituted for EUT at the same position and signals generator export the CW signal to the substitution antenna via a TX cable. Rotated the Turn Table and moved receiving antenna to find the maximum radiation power. Adjust output power level of S.G to get a Value of spectrum reading equal to “Read Value “ of step a. Record the power level of S.G
- c. $EIRP = \text{Output power level of S.G} - \text{TX cable loss} + \text{Antenna gain of substitution horn.}$

NOTE: The resolution bandwidth and video bandwidth of test receiver/spectrum analyzer is 1MHz/3MHz.

4.7.4 DEVIATION FROM TEST STANDARD

No deviation

4.7.5 TEST SETUP

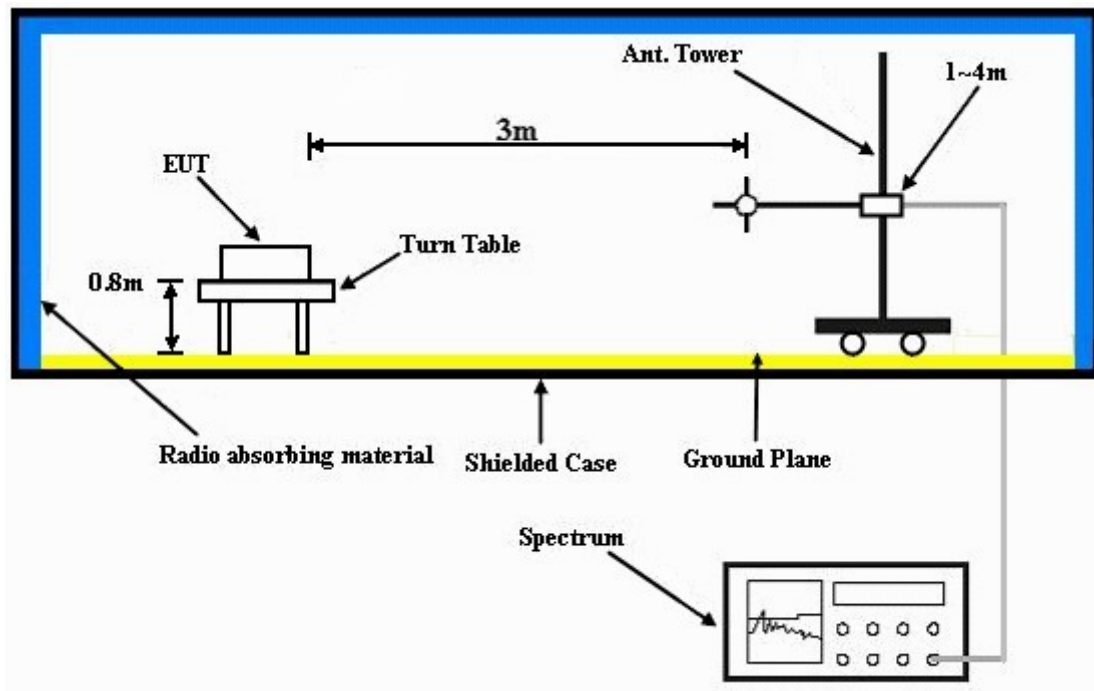

For the actual test configuration, please refer to the attached file (Test Setup Photo).

4.7.6 EUT OPERATING CONDITIONS

- a. The EUT makes a call to the communication simulator.
- b. The communication simulator station system controlled an EUT to export maximum output power under transmission mode and specific channel frequency.



A D T

4.7.7 TEST RESULTS

FOR GPRS:

MODE	TX channel 512	FREQUENCY RANGE	Above 1000 MHz
INPUT POWER	120Vac, 60 Hz	ENVIRONMENTAL CONDITIONS	23deg. C, 63%RH, 991hPa
TESTED BY	Mark Liao		

ANTENNA POLARITY & TEST DISTANCE: HORIZONTAL AT 3 M						
No.	Freq. (MHz)	Emission Level (dBuV)	Limit (dBm)	S.G Power Value (dBm)	Correction Factor (dB)	Power Value (dBm)
1	3700.4	68.1	-13.0	-36.1	9.9	-26.2
2	5550.6	52.6	-13.0	-51.8	9.7	-42.1
3	7400.8	52.1	-13.0	-50.2	7.9	-42.3
ANTENNA POLARITY & TEST DISTANCE: VERTICAL AT 3 M						
No.	Freq. (MHz)	Emission Level (dBuV)	Limit (dBm)	S.G Power Value (dBm)	Correction Factor (dB)	Power Value (dBm)
1	3700.4	76.8	-13.0	-28.0	9.9	-18.1
2	5550.6	54.1	-13.0	-50.1	9.7	-40.4
3	7400.8	52.4	-13.0	-50.3	7.9	-42.4

NOTE: Power Value (dBum) = S.G Power Value (dBm) + Correction Factor (dB).



A D T

MODE	TX channel 661	FREQUENCY RANGE	Above 1000 MHz
INPUT POWER	120Vac, 60 Hz	ENVIRONMENTAL CONDITIONS	23deg. C, 63%RH, 991hPa
TESTED BY	Mark Liao		

ANTENNA POLARITY & TEST DISTANCE: HORIZONTAL AT 3 M						
No.	Freq. (MHz)	Emission Level (dBuV)	Limit (dBm)	S.G Power Value (dBm)	Correction Factor (dB)	Power Value (dBm)
1	3760	68.6	-13.0	-36.0	9.9	-26.1
2	5640	53.8	-13.0	-50.5	9.6	-40.9
3	7520	52.8	-13.0	-49.0	7.8	-41.2
ANTENNA POLARITY & TEST DISTANCE: VERTICAL AT 3 M						
No.	Freq. (MHz)	Emission Level (dBuV)	Limit (dBm)	S.G Power Value (dBm)	Correction Factor (dB)	Power Value (dBm)
1	3760	76.2	-13.0	-28.0	9.9	-18.1
2	5640	55.2	-13.0	-48.5	9.6	-38.9
3	7520	53.1	-13.0	-49.0	7.8	-41.2

NOTE: Power Value (dBum) = S.G Power Value (dBm) + Correction Factor (dB).



MODE	TX channel 810	FREQUENCY RANGE	Above 1000 MHz
INPUT POWER	120Vac, 60 Hz	ENVIRONMENTAL CONDITIONS	23deg. C, 63%RH, 991hPa
TESTED BY	Mark Liao		

ANTENNA POLARITY & TEST DISTANCE: HORIZONTAL AT 3 M						
No.	Freq. (MHz)	Emission Level (dBuV)	Limit (dBm)	S.G Power Value (dBm)	Correction Factor (dB)	Power Value (dBm)
1	3819.6	69.3	-13.0	-35.6	9.9	-25.7
2	5729.4	56.6	-13.0	-47.8	9.6	-38.2
3	7639.2	53.8	-13.0	-49.1	7.8	-41.3
ANTENNA POLARITY & TEST DISTANCE: VERTICAL AT 3 M						
No.	Freq. (MHz)	Emission Level (dBuV)	Limit (dBm)	S.G Power Value (dBm)	Correction Factor (dB)	Power Value (dBm)
1	3819.6	77.2	-13.0	-27.3	9.9	-17.4
2	5729.4	62.0	-13.0	-42.1	9.6	-32.5
3	7639.2	53.5	-13.0	-49.1	7.8	-41.3

NOTE: Power Value (dBum) = S.G Power Value (dBm) + Correction Factor (dB).



A D T

FOR CDMA:

MODE	Channel 25	FREQUENCY RANGE	Above 1000MHz
INPUT POWER	120Vac, 60 Hz	ENVIRONMENTAL CONDITIONS	23deg. C, 63%RH, 991hPa
TESTED BY	Mark Liao		

ANTENNA POLARITY & TEST DISTANCE: HORIZONTAL AT 3 M						
NO.	FREQ. (MHz)	EMISSION LEVEL (dBuV)	LIMIT (dBm)	S.G POWER VALUE (dBm)	CORRECTION FACTOR (dB)	POWER VALUE (dBm)
1	3702.50	64.0	-13.0	-40.9	9.9	-31.0
2	5553.75	56.0	-13.0	-47.9	9.7	-38.2
3	7405.00	55.6	-13.0	-46.4	7.9	-38.5

ANTENNA POLARITY & TEST DISTANCE: VERTICAL AT 3 M						
NO.	FREQ. (MHz)	EMISSION LEVEL (dBuV)	LIMIT (dBm)	S.G POWER VALUE (dBm)	CORRECTION FACTOR (dB)	POWER VALUE (dBm)
1	3702.50	67.1	-13.0	-37.0	9.9	-27.1
2	5553.75	55.6	-13.0	-48.8	9.7	-39.1
3	7405.00	60.7	-13.0	-41.5	7.9	-33.6

NOTE: Power Value (dBum) = S.G Power Value (dBm) + Correction Factor (dB).



A D T

MODE	Channel 600	FREQUENCY RANGE	Above 1000MHz
INPUT POWER	120Vac, 60 Hz	ENVIRONMENTAL CONDITIONS	23deg. C, 63%RH, 991hPa
TESTED BY	Mark Liao		

ANTENNA POLARITY & TEST DISTANCE: HORIZONTAL AT 3 M						
NO.	FREQ. (MHz)	EMISSION LEVEL (dBuV)	LIMIT (dBm)	S.G POWER VALUE (dBm)	CORRECTION FACTOR (dB)	POWER VALUE (dBm)
1	3760	60.6	-13.0	-43.6	9.9	-33.7
2	5640	55.0	-13.0	-49.3	9.6	-39.7
3	7520	56.2	-13.0	-45.8	7.8	-38.0

ANTENNA POLARITY & TEST DISTANCE: VERTICAL AT 3 M						
NO.	FREQ. (MHz)	EMISSION LEVEL (dBuV)	LIMIT (dBm)	S.G POWER VALUE (dBm)	CORRECTION FACTOR (dB)	POWER VALUE (dBm)
1	3760	57.7	-13.0	-46.2	9.9	-36.3
2	5640	54.4	-13.0	-50.3	9.6	-40.7
3	7520	60.8	-13.0	-41.1	7.8	-33.3

NOTE: Power Value (dBum) = S.G Power Value (dBm) + Correction Factor (dB).



A D T

MODE	Channel 1175	FREQUENCY RANGE	Above 1000MHz
INPUT POWER	120Vac, 60 Hz	ENVIRONMENTAL CONDITIONS	23deg. C, 63%RH, 991hPa
TESTED BY	Mark Liao		

ANTENNA POLARITY & TEST DISTANCE: HORIZONTAL AT 3 M						
NO.	FREQ. (MHz)	EMISSION LEVEL (dBuV)	LIMIT (dBm)	S.G POWER VALUE (dBm)	CORRECTION FACTOR (dB)	POWER VALUE (dBm)
1	3817.50	60.6	-13.0	-43.8	9.9	-33.9
2	5726.25	55.0	-13.0	-49.3	9.6	-39.7
3	7635.00	56.2	-13.0	-46.4	7.8	-38.6

ANTENNA POLARITY & TEST DISTANCE: VERTICAL AT 3 M						
NO.	FREQ. (MHz)	EMISSION LEVEL (dBuV)	LIMIT (dBm)	S.G POWER VALUE (dBm)	CORRECTION FACTOR (dB)	POWER VALUE (dBm)
1	3817.50	72.1	-13.0	-32.5	9.9	-22.6
2	5726.25	53.7	-13.0	-49.7	9.6	-40.1
3	7635.00	61.5	-13.0	-40.4	7.8	-32.6

NOTE: Power Value (dBum) = S.G Power Value (dBm) + Correction Factor (dB).



A D T

FOR WCDMA:

MODE	TX channel 9262	FREQUENCY RANGE	Above 1000 MHz
INPUT POWER	120Vac, 60 Hz	ENVIRONMENTAL CONDITIONS	23deg. C, 63%RH, 991hPa
TESTED BY	Mark Liao		

ANTENNA POLARITY & TEST DISTANCE: HORIZONTAL AT 3 M						
No.	Freq. (MHz)	Emission Level (dBuV)	Limit (dBm)	S.G Power Value (dBm)	Correction Factor (dB)	Power Value (dBm)
1	3704.8	64.2	-13.0	-40.1	9.9	-30.2
2	5557.2	51.2	-13.0	-52.9	9.7	-43.2
3	7409.6	54.2	-13.0	-48.4	7.9	-40.5
ANTENNA POLARITY & TEST DISTANCE: VERTICAL AT 3 M						
No.	Freq. (MHz)	Emission Level (dBuV)	Limit (dBm)	S.G Power Value (dBm)	Correction Factor (dB)	Power Value (dBm)
1	3704.8	71.1	-13.0	-32.7	9.9	-22.8
2	5557.2	52.3	-13.0	-51.6	9.7	-41.9
3	7409.6	55.3	-13.0	-46.5	7.9	-38.6

NOTE: Power Value (dBum) = S.G Power Value (dBm) + Correction Factor (dB).



MODE	TX channel 9400	FREQUENCY RANGE	Above 1000 MHz
INPUT POWER	120Vac, 60 Hz	ENVIRONMENTAL CONDITIONS	23deg. C, 63%RH, 991hPa
TESTED BY	Mark Liao		

ANTENNA POLARITY & TEST DISTANCE: HORIZONTAL AT 3 M						
No.	Freq. (MHz)	Emission Level (dBuV)	Limit (dBm)	S.G Power Value (dBm)	Correction Factor (dB)	Power Value (dBm)
1	3760	63.3	-13.0	-41.0	9.9	-31.1
2	5640	50.7	-13.0	-53.1	9.6	-43.5
3	7520	53.9	-13.0	-48.4	7.8	-40.6
ANTENNA POLARITY & TEST DISTANCE: VERTICAL AT 3 M						
No.	Freq. (MHz)	Emission Level (dBuV)	Limit (dBm)	S.G Power Value (dBm)	Correction Factor (dB)	Power Value (dBm)
1	3760	72.9	-13.0	-31.9	9.9	-22.0
2	5640	52.9	-13.0	-51.2	9.6	-41.6
3	7520	56.6	-13.0	-46.0	7.8	-38.2

NOTE: Power Value (dBum) = S.G Power Value (dBm) + Correction Factor (dB).



A D T

MODE	TX channel 9538	FREQUENCY RANGE	Above 1000 MHz
INPUT POWER	120Vac, 60 Hz	ENVIRONMENTAL CONDITIONS	23deg. C, 63%RH, 991hPa
TESTED BY	Mark Liao		

ANTENNA POLARITY & TEST DISTANCE: HORIZONTAL AT 3 M						
No.	Freq. (MHz)	Emission Level (dBUV)	Limit (dBm)	S.G Power Value (dBm)	Correction Factor (dB)	Power Value (dBm)
1	3815.2	62.8	-13.0	-41.8	9.9	-31.9
2	5722.8	50.5	-13.0	-53.4	9.6	-43.8
3	7630.4	53.2	-13.0	-49.4	7.8	-41.6
ANTENNA POLARITY & TEST DISTANCE: VERTICAL AT 3 M						
No.	Freq. (MHz)	Emission Level (dBUV)	Limit (dBm)	S.G Power Value (dBm)	Correction Factor (dB)	Power Value (dBm)
1	3815.2	72.0	-13.0	-32.1	9.9	-22.2
2	5722.8	51.5	-13.0	-52.6	9.6	-43.0
3	7630.4	56.6	-13.0	-45.9	7.8	-38.1

NOTE: Power Value (dBum) = S.G Power Value (dBm) + Correction Factor (dB).

5 PHOTOGRAPHS OF THE TEST CONFIGURATION

Please refer to the attached file (Test Setup Photo).

6 INFORMATION ON THE TESTING LABORATORIES

We, Bureau Veritas Consumer Products Services (H.K.) Ltd., Taoyuan Branch, were founded in 1988 to provide our best service in EMC, Radio, Telecom and Safety consultation. Our laboratories are accredited and approved according to ISO/IEC 17025.

Copies of accreditation certificates of our laboratories obtained from approval agencies can be downloaded from our web site: www.adt.com.tw/index.5/phtml.
If you have any comments, please feel free to contact us at the following:

Linko EMC/RF Lab:

Tel: 886-2-26052180

Fax: 886-2-26051924

Hsin Chu EMC/RF Lab:

Tel: 886-3-5935343

Fax: 886-3-5935342

Hwa Ya EMC/RF/Safety/Telecom Lab:

Tel: 886-3-3183232

Fax: 886-3-3185050

Web Site: www.adt.com.tw

The address and road map of all our labs can be found in our web site also.

7 APPENDIX A – MODIFICATIONS RECORDERS FOR ENGINEERING CHANGES TO THE EUT BY THE LAB

No any modifications are made to the EUT by the lab during the test.

---END---