



Hermon Laboratories Ltd.
Harakevet Industrial Zone, Binyamina 30500,
Israel
Tel. +972-4-6288001
Fax. +972-4-6288277
E-mail: mail@hermonlabs.com

TEST REPORT

ACCORDING TO: FCC 47 CFR PART 15 subpart C, section 15.249; subpart B and
RSS-210 issue 8 Annex 2; ICES-003 Issue 6:2016

FOR:

Essence Security International Ltd.

Z-Wave Extender Dongle

Model: ES800ZWP

FCC ID: YXG-ES800ZWP

IC: 11061A-ES800ZWP

This report is in conformity with ISO/IEC 17025. The "A2LA Accredited" symbol endorsement applies only to the tests and calibrations that are listed in the scope of Hermon Laboratories accreditation. The test results relate only to the items tested. This test report shall not be reproduced in any form except in full with the written approval of Hermon Laboratories Ltd.

Table of contents

1	Applicant information	3
2	Equipment under test attributes	3
3	Manufacturer information	3
4	Test details	3
5	Tests summary	4
6	EUT description	5
6.1	General information	5
6.2	Ports and lines	5
6.3	Support and test equipment	5
6.4	Changes made in EUT	5
6.5	Test configuration	6
6.6	EUT test positions	7
6.7	Transmitter characteristics	8
7	Transmitter tests according to 47CFR part 15 subpart C requirements	9
7.1	Field strength of emissions	9
7.2	Occupied bandwidth test	25
7.3	Band edge emission	28
7.4	Conducted emissions	32
7.5	Antenna requirements	36
8	Emission tests according to 47CFR part 15 subpart B requirements	37
8.1	Conducted emissions	37
8.2	Radiated emission measurements	41
9	APPENDIX A Test equipment and ancillaries used for tests	48
10	APPENDIX B Measurement uncertainties	49
11	APPENDIX C Test laboratory description	50
12	APPENDIX D Specification references	50
13	APPENDIX E Test equipment correction factors	51
14	APPENDIX F Abbreviations and acronyms	62

1 Applicant information

Client name: Essence Security International Ltd.
Address: 12 Abba Eban Avenue, Ackerstein Towers Bldg. D, P.O.Box 2073, Herzliya 4612001, Israel
Telephone: +972 7324 47735
Fax: +972 9772 9962
E-mail: israelgo@essence-grp.com
Contact name: Mr. Israel Gottesman

2 Equipment under test attributes

Product name: Z-Wave Extender Dongle
Product type: Transceiver
Model(s): ES800ZWP
Serial number: Prototype
Hardware version: 3.E
Software release: 4.3
Receipt date 12-Sep-16

3 Manufacturer information

Manufacturer name: Essence Security International Ltd.
Address: 12 Abba Eban Avenue, Ackerstein Towers Bldg. D, P.O.Box 2073, Herzliya 4612001, Israel
Telephone: +972 7324 47735
Fax: +972 9772 9962
E-Mail: israelgo@essence-grp.com
Contact name: Mr. Israel Gottesman

4 Test details



Project ID: 28793
Location: Hermon Laboratories Ltd. Harakevet Industrial Zone, Binyamina 3055001, Israel
Test started: 12-Sep-16
Test completed: 14-Sep-16
Test specification(s): FCC 47 CFR Part 15, subpart C, §15.249; subpart B
RSS-210 issue 8 Annex 2; RSS-Gen issue 4, ICES-003 issue 6:2016

5 Tests summary

Test	Status
Transmitter characteristics	
Section 15.249(a)(d)/RSS-210, section A2.9, Field strength of emissions	Pass
Section 15.215(c) / RSS-Gen, Section 6.6, Occupied bandwidth	Pass
Section 15.249(d)/RSS-210, section A2.9, Band edge emissions	Pass
Section 15.207(a)/RSS-Gen, section 8.8, Conducted emission	Pass
Section 15.203/ RSS-Gen, Section 8.3, Antenna requirement	Pass
Unintentional emissions	
Section 15.107/ ICES-003, Section 6.1 class B, Conducted emission at AC power port	Pass
Section 15.109/RSS-Gen, section 7.1.2, ICES-003, Section 6.2 class B, Radiated emission	Pass

Testing was completed against all relevant requirements of the test standard. The results obtained indicate that the product under test complies in full with the requirements tested.

The test results relate only to the items tested. Pass/ fail decision was based on nominal values.

	Name and Title	Date	Signature
Tested by:	Mr. I. Zilberstein, test engineer Mr. K. Zushchyk, test engineer	September 14, 2016	
Reviewed by:	Mrs. M. Cherniavsky, certification engineer	October 11, 2016	
Approved by:	Mr. M. Nikishin, EMC and Radio group manager	November 3, 2016	



6 EUT description

6.1 General information

The EUT, ES800ZWP, is a Z-Wave Extender Dongle comprising radio unit operating at 908.4 MHz, powered by 5VDC via power adapter.

6.2 Ports and lines

Port type	Port description	Conn. from	Conn. to	Qty.	Cable type	Cable length, m	Indoor / outdoor
Power	DC	EUT	AC/DC Adapter	1	Unshielded	1.5	Indoor
Signal	USB	EUT	Control panel	1	Unshielded	0.15	Indoor

6.3 Support and test equipment

Description	Manufacturer	Model number	Serial number
Control panel	Essence Security	ES8000CP-US-K02	70024BC5
AC/DC Adapter	DVE	DSA-6PFG-05 FSU 050100	NA

6.4 Changes made in EUT

No changes were implemented in the EUT during testing.

6.5 Test configuration

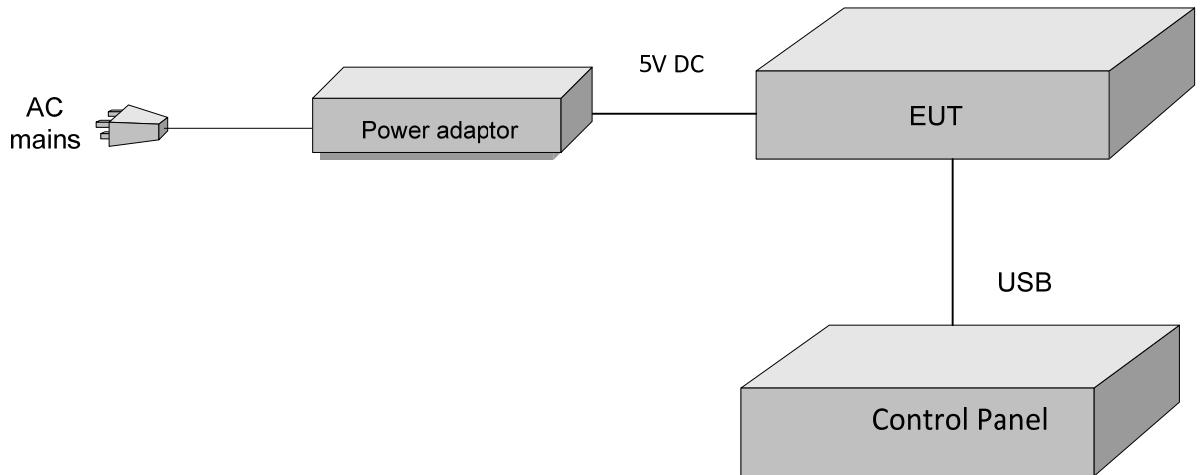

6.6 EUT test positions

Photograph 6.6.1 EUT in X-axis orthogonal position



Photograph 6.6.2 EUT in Y-axis orthogonal position



Photograph 6.6.3 EUT in Z-axis orthogonal position





6.7 Transmitter characteristics

Type of equipment					
V	Stand-alone (Equipment with or without its own control provisions)				
	Combined equipment (Equipment where the radio part is fully integrated within another type of equipment)				
	Plug-in card (Equipment intended for a variety of host systems)				
Assigned frequency range		902 - 928 MHz			
Operating frequency range		908.4 MHz			
Maximum field strength		92.73 dB(μV/m) at 3 m test distance			
Is transmitter output power variable?	V	No			
		Yes	continuous variable		
			stepped variable with stepsize, software controlled		dB
			Maximum field strength		92.73 dB(μV/m) at 3 m test distance
Antenna connection					
V	unique coupling	standard connector	Integral	V with temporary RF connector without temporary RF connector	
Antenna/s technical characteristics					
Type	Manufacturer		Model number	Gain	
Integral	Essence Security		Printed	2.5 dBi	
Transmitter aggregate data rate/s		40 kbps			
Type of modulation		2FSK			
Transmitter duty cycle supplied for test		100%			
Transmitter power source					
	Battery	Nominal rated voltage	Battery type		
	DC	Nominal rated voltage			
V	AC mains	Nominal rated voltage	120 VAC	Frequency	50 Hz
Common power source for transmitter and receiver				V yes	no



Test specification: Section 15.249(a)(d)/RSS-210, section A2.9, Field strength of emissions			
Test procedure: ANSI C63.10 sections 6.5, 6.6			
Test mode: Compliance		Verdict: PASS	
Date(s): 12-Sep-16			
Temperature: 25 °C	Relative Humidity: 44 %	Air Pressure: 1010 hPa	Power: 120 VAC
Remarks:			

7 Transmitter tests according to 47CFR part 15 subpart C requirements

7.1 Field strength of emissions

7.1.1 General

This test was performed to measure field strength of fundamental and spurious emissions from the EUT. Specification test limits are given in Table 7.1.1, Table 7.1.2 and Table 7.1.3.

Table 7.1.1 Radiated fundamental emission limits

Fundamental frequency, MHz	Field strength at 3 m, dB(μV/m)		
	Peak	Average	Quasi-Peak
902 – 928	NA	NA	94

Table 7.1.2 Harmonics limits

Fundamental frequency, MHz	Field strength at 3 m, dB(μV/m)	
	Peak	Average
902 – 928	74.0	54.0

Table 7.1.3 Radiated spurious emissions limits (other than harmonics)

Frequency, MHz	Field strength at 3 m, dB(μV/m)*			Attenuation below carrier
	Peak	Quasi Peak	Average	
0.009 – 0.090	148.5 – 128.5	NA	128.5 – 108.5**	50 dBc (whichever is the less stringent)
0.090 – 0.110	NA	108.5 – 106.8**	NA	
0.110 – 0.490	126.8 – 113.8	NA	106.8 – 93.8**	
0.490 – 1.705	NA	73.8 – 63.0**	NA	
1.705 – 30.0*		69.5		
30 – 88		40.0		
88 – 216		43.5		
216 – 960		46.0		
960 - 1000	54.0	54.0	54.0	
Above 1000	74.0	NA	54.0	

*- The limit for 3 m test distance was calculated using the inverse square distance extrapolation factor as follows:

$$\text{Lim}_{S_2} = \text{Lim}_{S_1} + 40 \log (S_1/S_2),$$

where S₁ and S₂ – standard defined and test distance respectively in meters.

**- The limit decreases linearly with the logarithm of frequency.

Note: The above field strength limits applied from the lowest radio frequency generated in the device, without going below 9 kHz up to the tenth harmonic of the highest fundamental frequency but not exceeding 40 GHz for intentional radiators operated below 10 GHz and up to the fifth harmonic of the highest fundamental frequency but not exceeding 100 GHz for intentional radiators operated above 10 GHz.



Test specification: Section 15.249(a)(d)/RSS-210, section A2.9, Field strength of emissions			
Test procedure: ANSI C63.10 sections 6.5, 6.6			
Test mode: Compliance		Verdict: PASS	
Date(s): 12-Sep-16			
Temperature: 25 °C	Relative Humidity: 44 %	Air Pressure: 1010 hPa	Power: 120 VAC
Remarks:			

7.1.2 Test procedure for spurious emission field strength measurements in 9 kHz to 30 MHz band

7.1.2.1 The EUT was set up as shown in Figure 7.1.1, energized and the performance check was conducted.

7.1.2.2 The measurements were performed in three EUT orthogonal positions.

7.1.2.3 The specified frequency range was investigated with antenna connected to spectrum analyzer/ EMI receiver. To find maximum radiation the turntable was rotated 360° and the measuring antenna was rotated around its vertical axis.

7.1.2.4 The worst test results (the lowest margins) were found in the EUT Y -axis position, recorded in the associated tables and shown in the associated plots.

7.1.3 Test procedure for spurious emission field strength measurements above 30 MHz

7.1.3.1 The EUT was set up as shown in Figure 7.1.2, Figure 7.1.3 energized and the performance check was conducted.

7.1.3.2 The measurements were performed in three EUT orthogonal positions.

7.1.3.3 The specified frequency range was investigated with antenna connected to spectrum analyzer/ EMI receiver. To find maximum radiation the turntable was rotated 360°, the measuring antenna height was changed from 1 to 4 m, its polarization was switched from vertical to horizontal.

7.1.3.4 The worst test results (the lowest margins) were found in the EUT Y-axis position, recorded in the associated tables and shown in the associated plots

Figure 7.1.1 Setup for spurious emission field strength measurements below 30 MHz

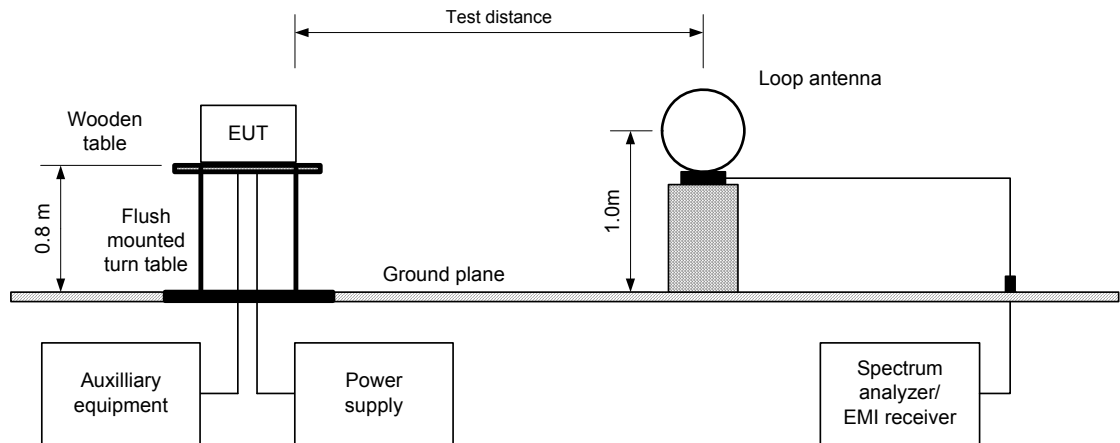



Test specification: Section 15.249(a)(d)/RSS-210, section A2.9, Field strength of emissions			
Test procedure: ANSI C63.10 sections 6.5, 6.6			
Test mode: Compliance		Verdict: PASS	
Date(s): 12-Sep-16			
Temperature: 25 °C	Relative Humidity: 44 %	Air Pressure: 1010 hPa	Power: 120 VAC
Remarks:			

Figure 7.1.2 Setup for spurious emission field strength measurements in 30 -1000 MHz

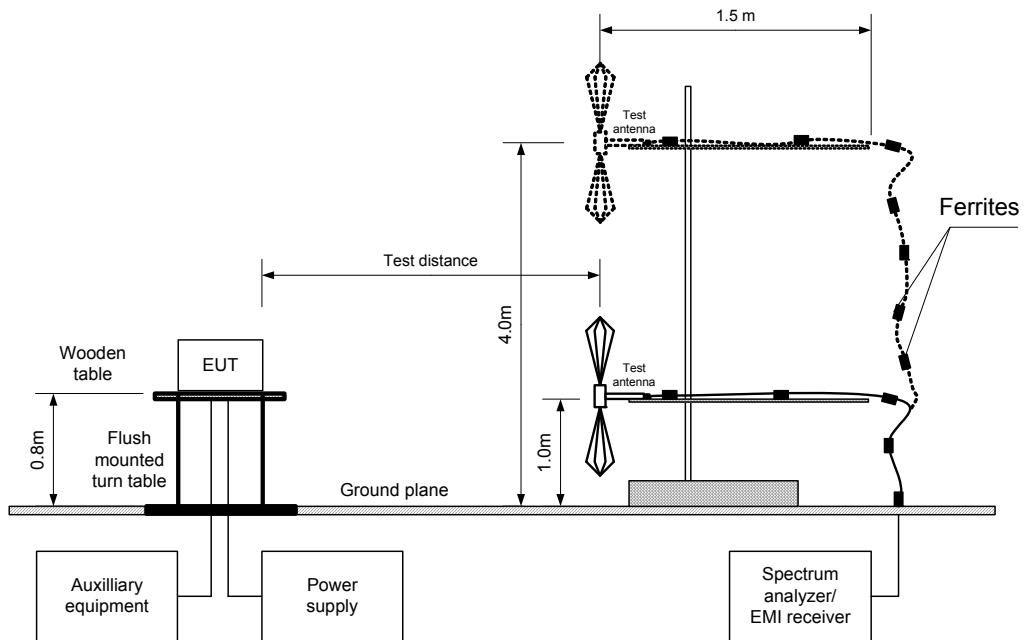
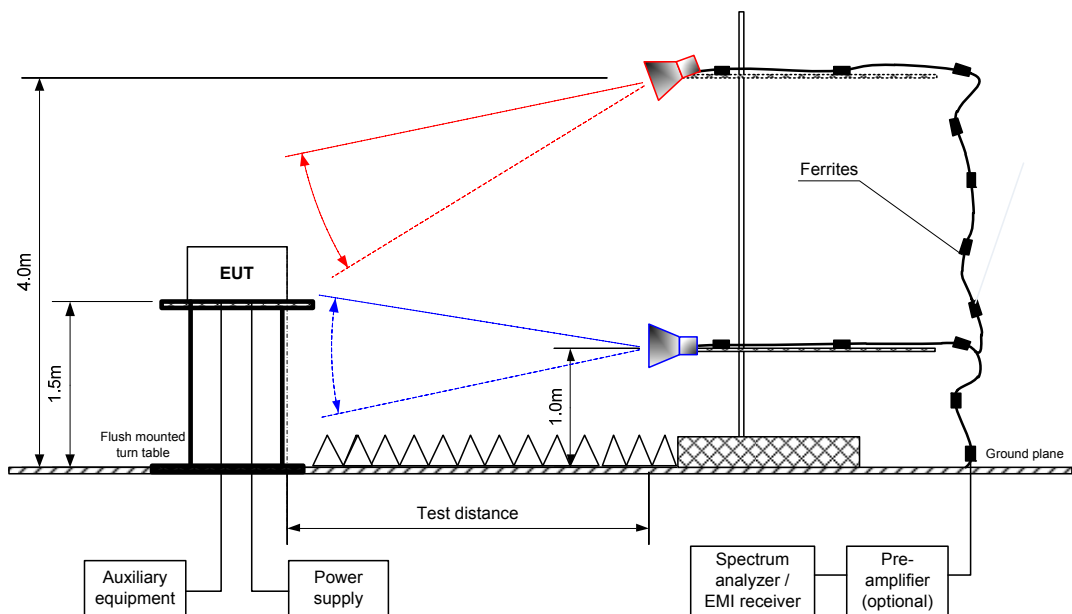

Figure 7.1.3 Setup for spurious emission field strength measurements above 1000 MHz





Test specification: Section 15.249(a)(d)/RSS-210, section A2.9, Field strength of emissions			
Test procedure: ANSI C63.10 sections 6.5, 6.6			
Test mode: Compliance		Verdict: PASS	
Date(s): 12-Sep-16			
Temperature: 25 °C	Relative Humidity: 44 %	Air Pressure: 1010 hPa	Power: 120 VAC
Remarks:			

Table 7.1.4 Field strength of fundamental emission and spurious emissions

TEST DISTANCE: 3 m
 EUT POSITION: 3 orthogonal X / Y / Z
 MODULATION: 2FSK
 TRANSMITTER OUTPUT POWER SETTINGS: Maximum
 INVESTIGATED FREQUENCY RANGE: 0.009 – 10000 MHz
 DETECTOR USED: Peak
 RESOLUTION BANDWIDTH: 1.0 kHz (9 kHz – 150 kHz)
 9.0 kHz (150 kHz – 30 MHz)
 120 kHz (30 MHz – 1000 MHz)
 1.0 MHz (above 1000 MHz)
 VIDEO BANDWIDTH: ≥ Resolution bandwidth
 TEST ANTENNA TYPE: Active loop (9 kHz – 30 MHz)
 Double ridged guide (above 1000 MHz)

Frequency, MHz	Antenna		Azimuth, degrees*	Peak emission, dB(μV/m)	Quasi-peak			Verdict
	Pol.	Height, m			Measured emission, dB(μV/m)	Limit, dB(μV/m)	Margin, dB**	
Fundamental emissions								
908.40	H	1.0	330	92.73	92.53	94.00	-1.47	Pass
Spurious emissions								
36.25	V	1.0	360	32.25	29.50	40.00	-10.50	Pass
191.99	V	1.2	90	36.10	31.25	43.50	-12.25	Pass

F, MHz	Antenna		Azimuth, degrees*	Peak field strength			Avr factor, dB	Average field strength			Verdict
	Pol.	Height, m		Measured, dB(μV/m)	Limit, dB(μV/m)	Margin, dB**		Measured, dB(μV/m)	Limit, dB(μV/m)	Margin, dB**	
Spurious emissions above 1000 MHz											
No emissions were found											Pass

Measured field strength, (dBμV/m) = meter reading (dBμV) + antenna correction factor (dB/m) + cable loss (dB) – pre-amp (dB), all correction factors were programmed into the spectrum analyzer.

*- EUT front panel refers to 0 degrees position of turntable.

** - Margin, dB = Measured (calculated) value, dB(μV/m) - Limit, dB(μV/m).

*** Max value was obtained in Y-axis orthogonal position and at Unom input power voltage.

Reference numbers of test equipment used

HL 0415	HL 0446	HL 0521	HL 0651	HL 0604	HL 2432	HL 2909	HL 3389
HL 4011	HL 4294	HL 4778	HL 4932	HL 5101			

Full description is given in Appendix A.



HERMON LABORATORIES

Test specification: Section 15.249(a)(d)/RSS-210, section A2.9, Field strength of emissions			
Test procedure: ANSI C63.10 sections 6.5, 6.6			
Test mode: Compliance		Verdict: PASS	
Date(s): 12-Sep-16			
Temperature: 25 °C	Relative Humidity: 44 %	Air Pressure: 1010 hPa	Power: 120 VAC
Remarks:			

Plot 7.1.1 Radiated emission measurements at the fundamental frequency

TEST SITE: OATS
 TEST DISTANCE: 3 m
 ANTENNA POLARIZATION: Vertical
 EUT POSITION: X-axis
 INPUT VOLTAGE: Unom

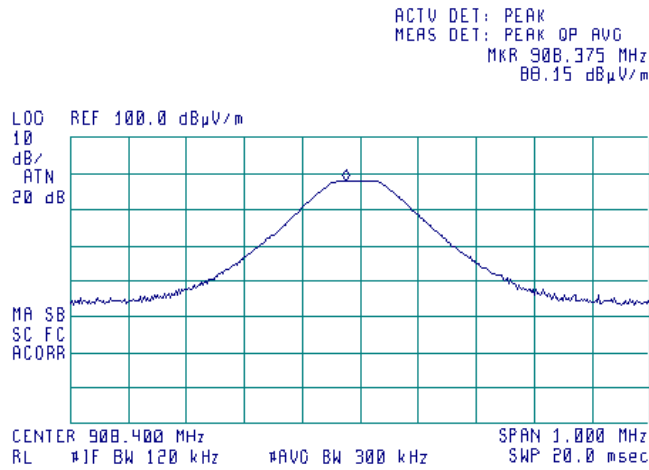

Plot 7.1.2 Radiated emission measurements at the fundamental frequency

TEST SITE: OATS
 TEST DISTANCE: 3 m
 ANTENNA POLARIZATION: Horizontal
 EUT POSITION: X-axis
 INPUT VOLTAGE: Unom

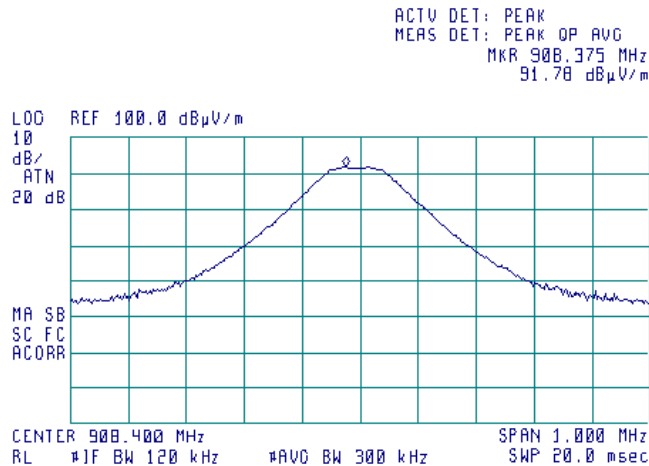



HERMON LABORATORIES

Test specification: Section 15.249(a)(d)/RSS-210, section A2.9, Field strength of emissions			
Test procedure: ANSI C63.10 sections 6.5, 6.6			
Test mode: Compliance		Verdict: PASS	
Date(s): 12-Sep-16			
Temperature: 25 °C	Relative Humidity: 44 %	Air Pressure: 1010 hPa	Power: 120 VAC
Remarks:			

Plot 7.1.3 Radiated emission measurements at the fundamental frequency

TEST SITE: OATS
 TEST DISTANCE: 3 m
 ANTENNA POLARIZATION: Vertical
 EUT POSITION: X-axis
 INPUT VOLTAGE: 115%Unom

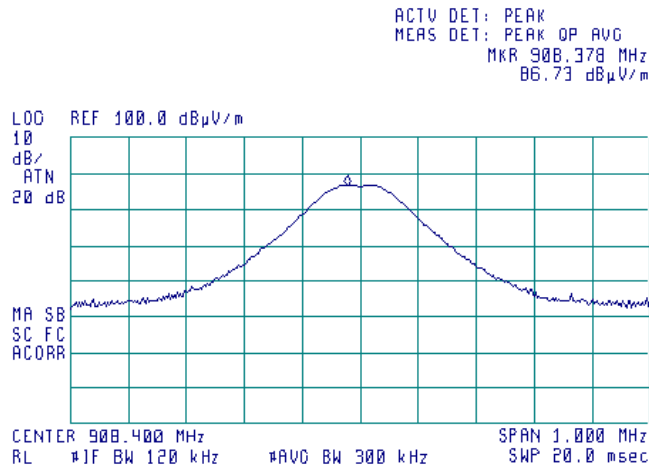

Plot 7.1.4 Radiated emission measurements at the fundamental frequency

TEST SITE: OATS
 TEST DISTANCE: 3 m
 ANTENNA POLARIZATION: Horizontal
 EUT POSITION: X-axis
 INPUT VOLTAGE: 115%Unom

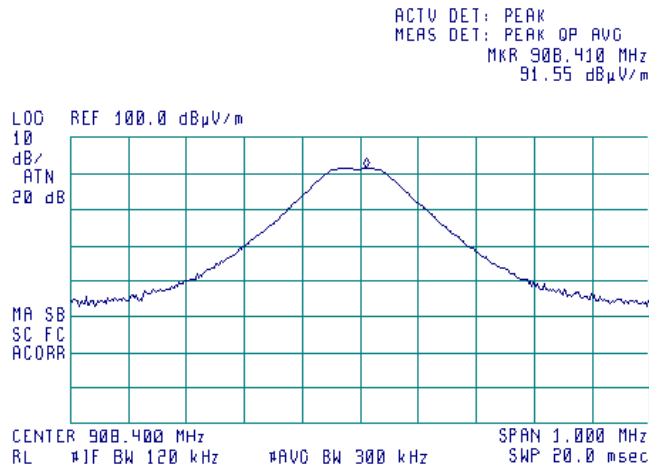



HERMON LABORATORIES

Test specification: Section 15.249(a)(d)/RSS-210, section A2.9, Field strength of emissions			
Test procedure: ANSI C63.10 sections 6.5, 6.6			
Test mode: Compliance		Verdict: PASS	
Date(s): 12-Sep-16			
Temperature: 25 °C	Relative Humidity: 44 %	Air Pressure: 1010 hPa	Power: 120 VAC
Remarks:			

Plot 7.1.5 Radiated emission measurements at the fundamental frequency

TEST SITE: OATS
 TEST DISTANCE: 3 m
 ANTENNA POLARIZATION: Vertical
 EUT POSITION: X-axis
 INPUT VOLTAGE: 85%Unom

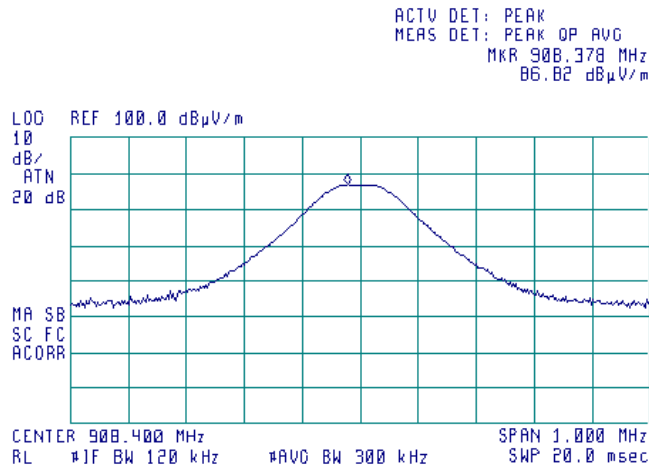

Plot 7.1.6 Radiated emission measurements at the fundamental frequency

TEST SITE: OATS
 TEST DISTANCE: 3 m
 ANTENNA POLARIZATION: Horizontal
 EUT POSITION: X-axis
 INPUT VOLTAGE: 85%Unom

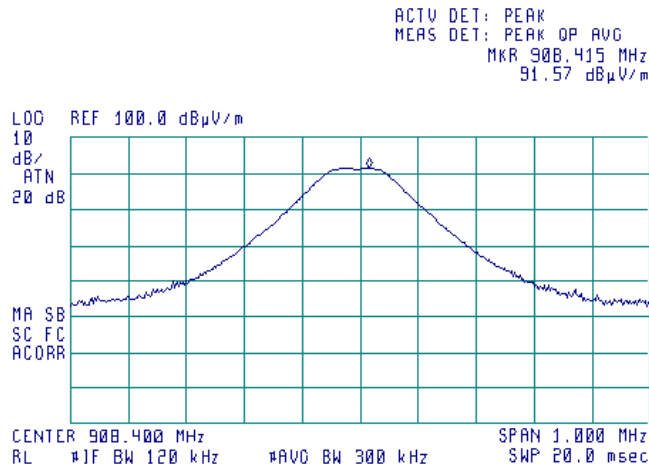



HERMON LABORATORIES

Test specification: Section 15.249(a)(d)/RSS-210, section A2.9, Field strength of emissions			
Test procedure: ANSI C63.10 sections 6.5, 6.6			
Test mode: Compliance		Verdict: PASS	
Date(s): 12-Sep-16			
Temperature: 25 °C	Relative Humidity: 44 %	Air Pressure: 1010 hPa	Power: 120 VAC
Remarks:			

Plot 7.1.7 Radiated emission measurements at the fundamental frequency

TEST SITE: OATS
 TEST DISTANCE: 3 m
 ANTENNA POLARIZATION: Vertical
 EUT POSITION: Y-axis
 INPUT VOLTAGE: Unom

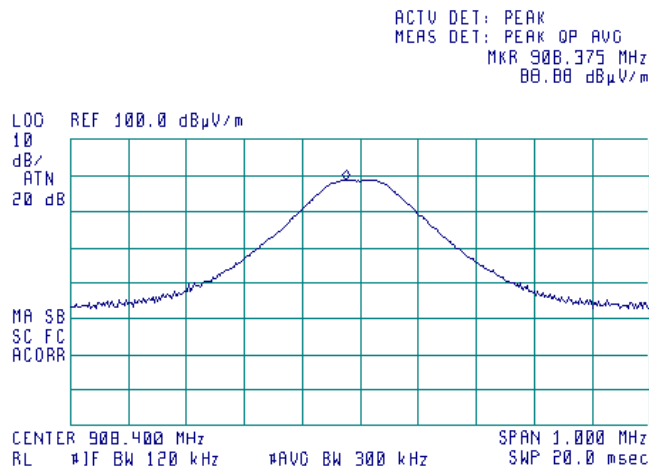

Plot 7.1.8 Radiated emission measurements at the fundamental frequency

TEST SITE: OATS
 TEST DISTANCE: 3 m
 ANTENNA POLARIZATION: Horizontal
 EUT POSITION: Y-axis
 INPUT VOLTAGE: Unom

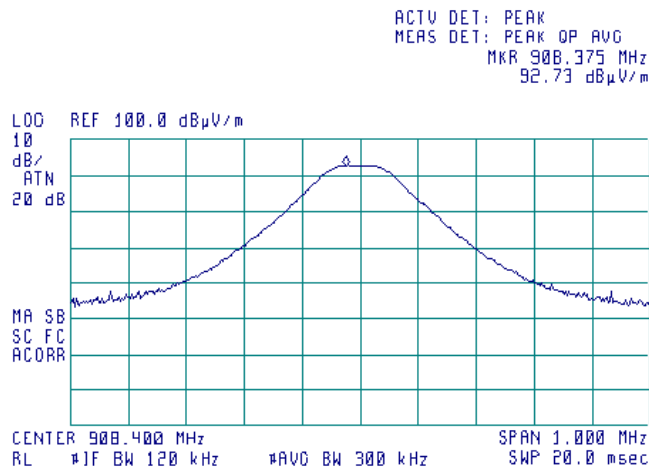



HERMON LABORATORIES

Test specification: Section 15.249(a)(d)/RSS-210, section A2.9, Field strength of emissions			
Test procedure: ANSI C63.10 sections 6.5, 6.6			
Test mode: Compliance		Verdict: PASS	
Date(s): 12-Sep-16			
Temperature: 25 °C	Relative Humidity: 44 %	Air Pressure: 1010 hPa	Power: 120 VAC
Remarks:			

Plot 7.1.9 Radiated emission measurements at the fundamental frequency

TEST SITE: OATS
TEST DISTANCE: 3 m
ANTENNA POLARIZATION: Vertical
EUT POSITION: Y-axis
INPUT VOLTAGE: 115%Unom

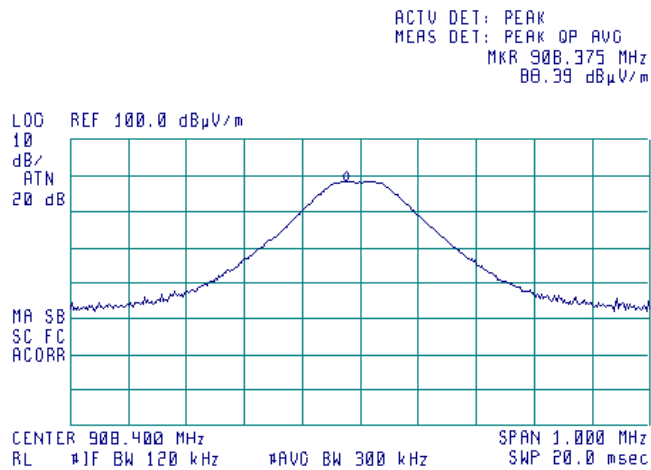

Plot 7.1.10 Radiated emission measurements at the fundamental frequency

TEST SITE: OATS
TEST DISTANCE: 3 m
ANTENNA POLARIZATION: Horizontal
EUT POSITION: Y-axis
INPUT VOLTAGE: 115%Unom

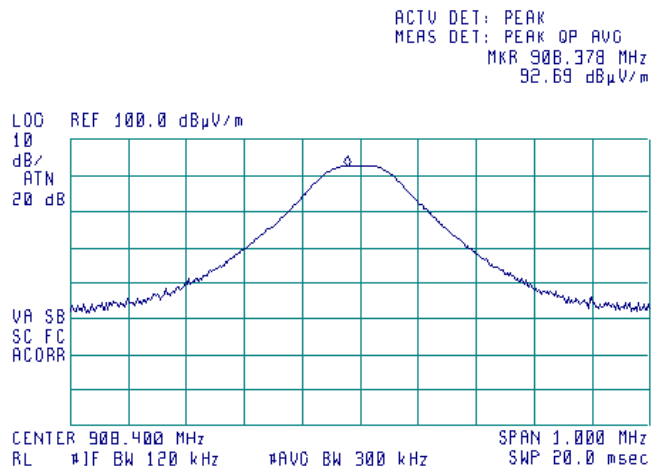



HERMON LABORATORIES

Test specification: Section 15.249(a)(d)/RSS-210, section A2.9, Field strength of emissions			
Test procedure: ANSI C63.10 sections 6.5, 6.6			
Test mode: Compliance		Verdict: PASS	
Date(s): 12-Sep-16			
Temperature: 25 °C	Relative Humidity: 44 %	Air Pressure: 1010 hPa	Power: 120 VAC
Remarks:			

Plot 7.1.11 Radiated emission measurements at the fundamental frequency

TEST SITE: OATS
TEST DISTANCE: 3 m
ANTENNA POLARIZATION: Vertical
EUT POSITION: Y-axis
INPUT VOLTAGE: 85%Unom

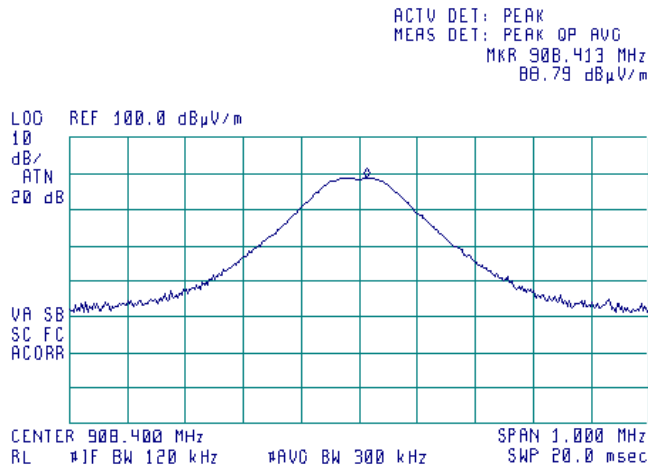

Plot 7.1.12 Radiated emission measurements at the fundamental frequency

TEST SITE: OATS
TEST DISTANCE: 3 m
ANTENNA POLARIZATION: Horizontal
EUT POSITION: Y-axis
INPUT VOLTAGE: 85%Unom

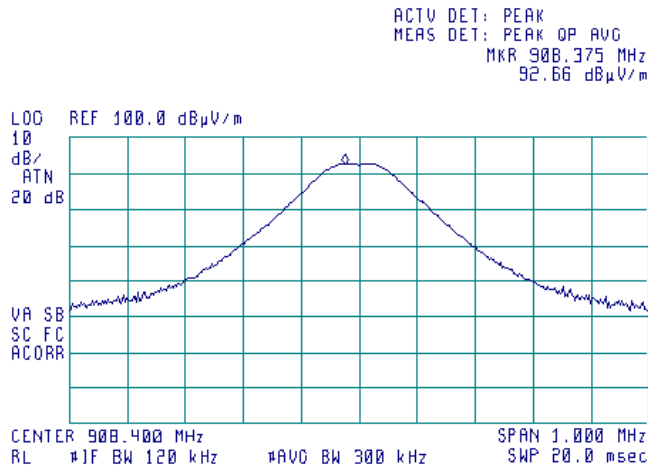



HERMON LABORATORIES

Test specification: Section 15.249(a)(d)/RSS-210, section A2.9, Field strength of emissions			
Test procedure: ANSI C63.10 sections 6.5, 6.6			
Test mode: Compliance		Verdict: PASS	
Date(s): 12-Sep-16			
Temperature: 25 °C	Relative Humidity: 44 %	Air Pressure: 1010 hPa	Power: 120 VAC
Remarks:			

Plot 7.1.13 Radiated emission measurements at the fundamental frequency

TEST SITE: OATS
TEST DISTANCE: 3 m
ANTENNA POLARIZATION: Vertical
EUT POSITION: Z-axis
INPUT VOLTAGE: Unom

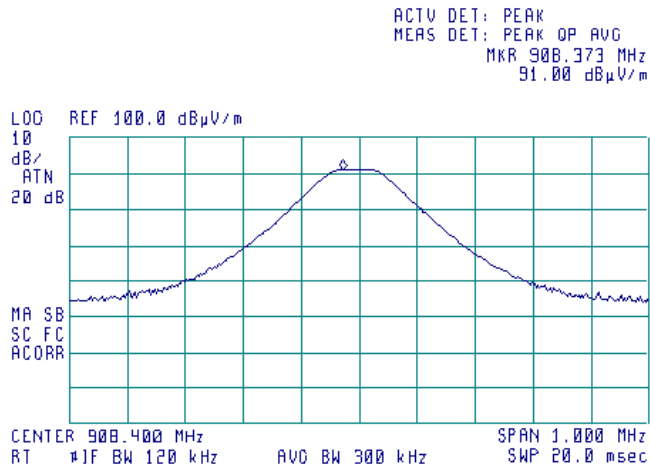

Plot 7.1.14 Radiated emission measurements at the fundamental frequency

TEST SITE: OATS
TEST DISTANCE: 3 m
ANTENNA POLARIZATION: Horizontal
EUT POSITION: Z-axis
INPUT VOLTAGE: Unom

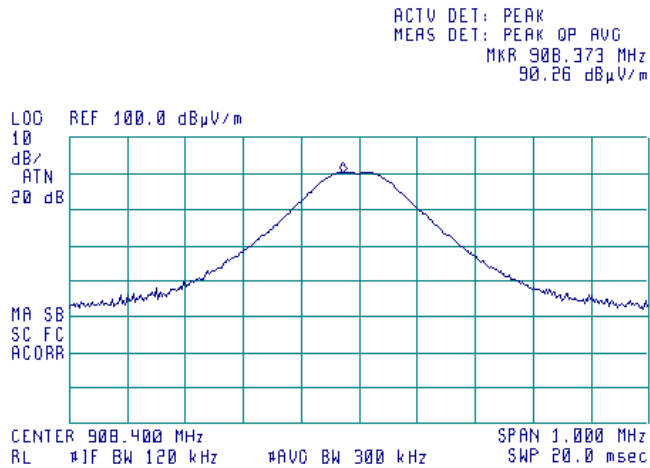



HERMON LABORATORIES

Test specification: Section 15.249(a)(d)/RSS-210, section A2.9, Field strength of emissions			
Test procedure: ANSI C63.10 sections 6.5, 6.6			
Test mode: Compliance		Verdict: PASS	
Date(s): 12-Sep-16			
Temperature: 25 °C	Relative Humidity: 44 %	Air Pressure: 1010 hPa	Power: 120 VAC
Remarks:			

Plot 7.1.15 Radiated emission measurements at the fundamental frequency

TEST SITE: OATS
 TEST DISTANCE: 3 m
 ANTENNA POLARIZATION: Vertical
 EUT POSITION: Z-axis
 INPUT VOLTAGE: 115%Unom

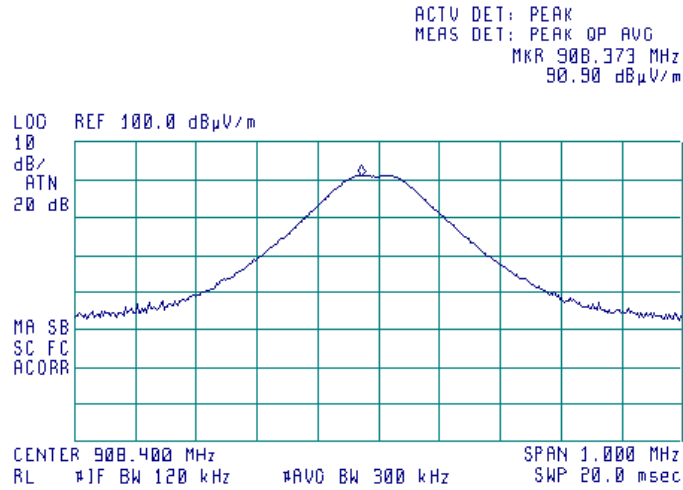

Plot 7.1.16 Radiated emission measurements at the fundamental frequency

TEST SITE: OATS
 TEST DISTANCE: 3 m
 ANTENNA POLARIZATION: Horizontal
 EUT POSITION: Z-axis
 INPUT VOLTAGE: 115%Unom

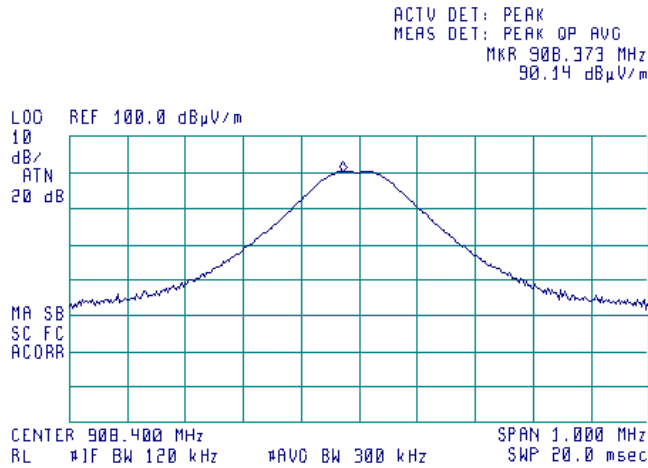



HERMON LABORATORIES

Test specification: Section 15.249(a)(d)/RSS-210, section A2.9, Field strength of emissions			
Test procedure: ANSI C63.10 sections 6.5, 6.6			
Test mode: Compliance		Verdict: PASS	
Date(s): 12-Sep-16			
Temperature: 25 °C	Relative Humidity: 44 %	Air Pressure: 1010 hPa	Power: 120 VAC
Remarks:			

Plot 7.1.17 Radiated emission measurements at the fundamental frequency

TEST SITE: OATS
 TEST DISTANCE: 3 m
 ANTENNA POLARIZATION: Vertical
 EUT POSITION: Z-axis
 INPUT VOLTAGE: 85%Unom

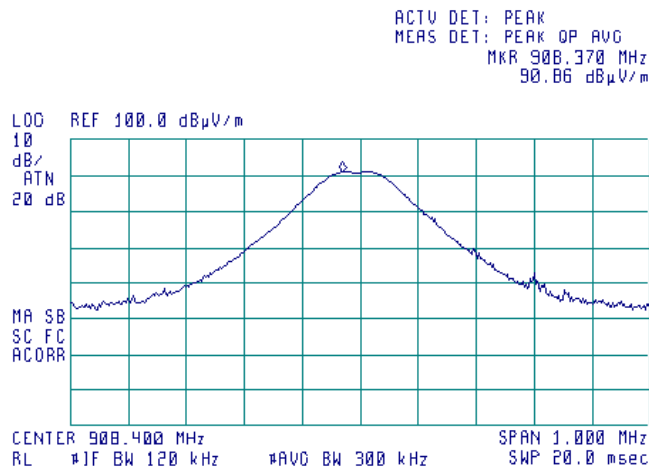

Plot 7.1.18 Radiated emission measurements at the fundamental frequency

TEST SITE: OATS
 TEST DISTANCE: 3 m
 ANTENNA POLARIZATION: Horizontal
 EUT POSITION: Z-axis
 INPUT VOLTAGE: 85%Unom

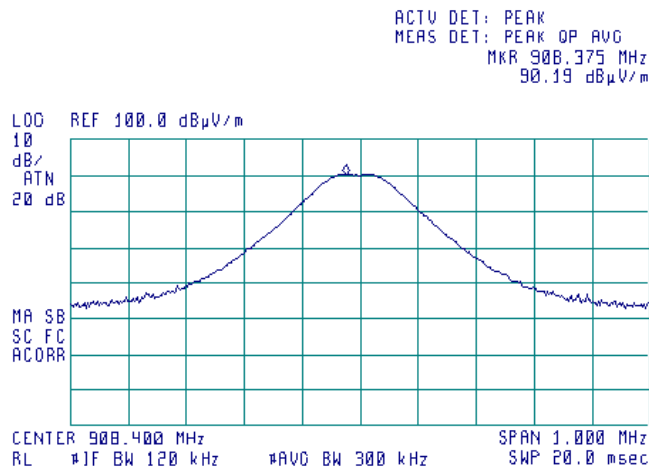



HERMON LABORATORIES

Test specification: Section 15.249(a)(d)/RSS-210, section A2.9, Field strength of emissions			
Test procedure: ANSI C63.10 sections 6.5, 6.6			
Test mode: Compliance		Verdict: PASS	
Date(s): 12-Sep-16			
Temperature: 25 °C	Relative Humidity: 44 %	Air Pressure: 1010 hPa	Power: 120 VAC
Remarks:			

Plot 7.1.19 Radiated emission measurements from 9 to 150 kHz

TEST SITE: Semi anechoic chamber
TEST DISTANCE: 3 m
EUT POSITION: Y-axis

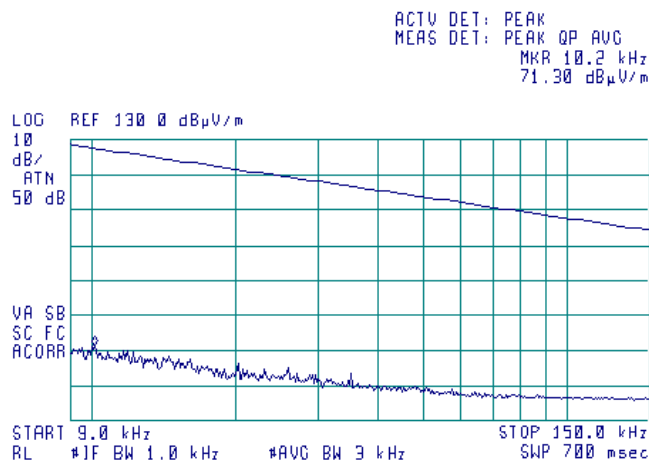

Plot 7.1.20 Radiated emission measurements from 0.15 to 30 MHz

TEST SITE: Semi anechoic chamber
TEST DISTANCE: 3 m
EUT POSITION: Y-axis

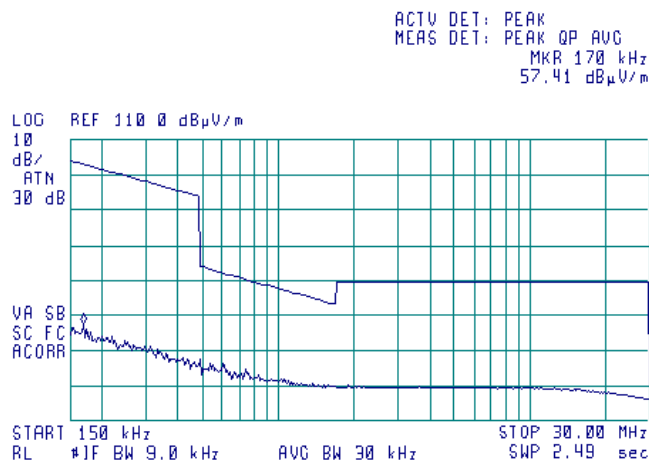



HERMON LABORATORIES

Test specification: Section 15.249(a)(d)/RSS-210, section A2.9, Field strength of emissions			
Test procedure: ANSI C63.10 sections 6.5, 6.6			
Test mode: Compliance		Verdict: PASS	
Date(s): 12-Sep-16			
Temperature: 25 °C	Relative Humidity: 44 %	Air Pressure: 1010 hPa	Power: 120 VAC
Remarks:			

Plot 7.1.21 Radiated emission measurements from 30 to 1000 MHz

TEST SITE: Semi anechoic chamber
 TEST DISTANCE: 3 m
 ANTENNA POLARIZATION: Vertical and Horizontal
 EUT POSITION: Y-axis

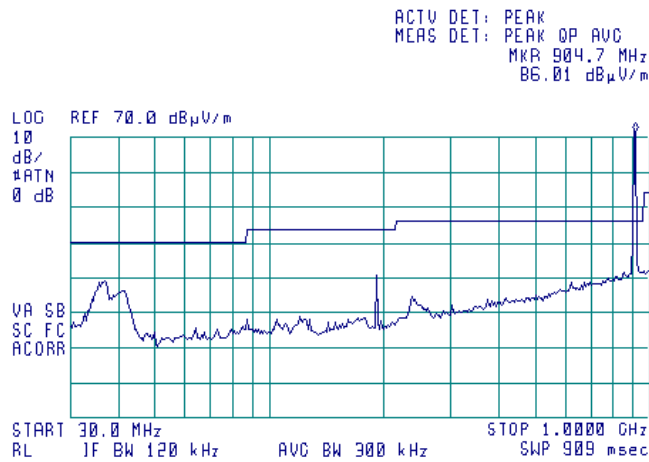

Plot 7.1.22 Radiated emission measurements from 1.0 to 6.5 GHz

TEST SITE: Semi anechoic chamber
 TEST DISTANCE: 3 m
 ANTENNA POLARIZATION: Vertical and Horizontal
 EUT POSITION: Y-axis

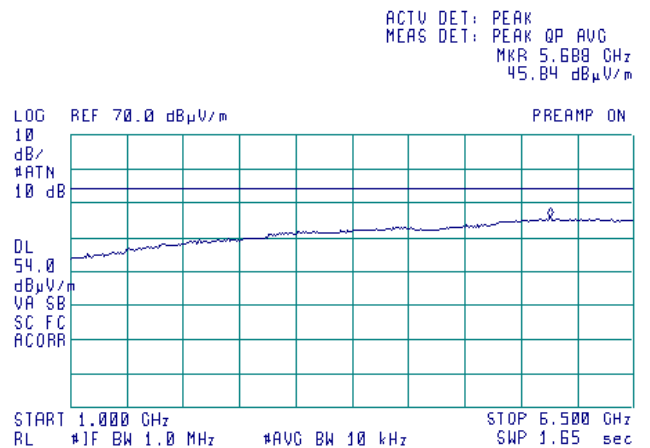
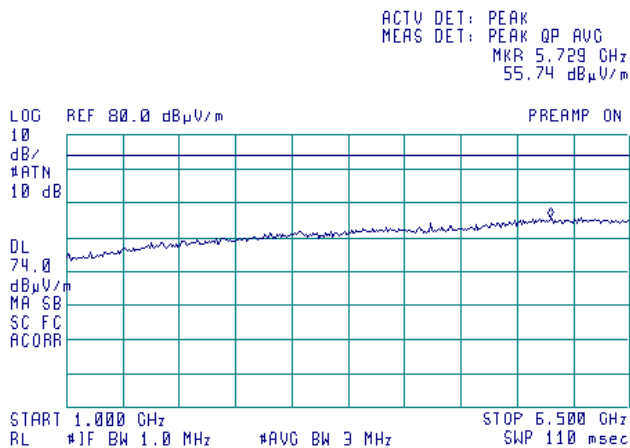



HERMON LABORATORIES

Test specification: Section 15.249(a)(d)/RSS-210, section A2.9, Field strength of emissions			
Test procedure: ANSI C63.10 sections 6.5, 6.6			
Test mode: Compliance		Verdict: PASS	
Date(s): 12-Sep-16			
Temperature: 25 °C	Relative Humidity: 44 %	Air Pressure: 1010 hPa	Power: 120 VAC
Remarks:			

Plot 7.1.23 Radiated emission measurements from 6.5 to 10.0 GHz

TEST SITE: Semi anechoic chamber
TEST DISTANCE: 3 m
ANTENNA POLARIZATION: Vertical and Horizontal
EUT POSITION: Y-axis

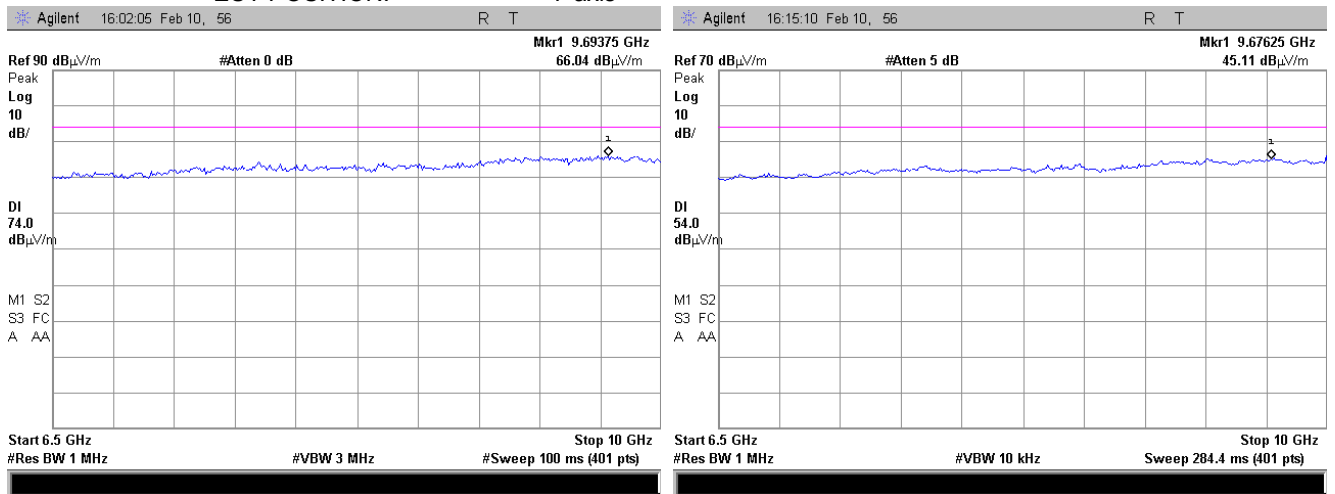



Test specification: Section 15.215(c), Occupied bandwidth			
Test procedure: ANSI C63.10 section 6.9.2			
Test mode: Compliance		Verdict: PASS	
Date(s): 14-Sep-16			
Temperature: 25 °C	Relative Humidity: 41 %	Air Pressure: 1009 hPa	Power: 120 VAC
Remarks:			

7.2 Occupied bandwidth test

7.2.1 General

This test was performed to verify that the 20 dB bandwidth of the emissions was contained within the standard specified frequency band according to FCC §15.215 requirements. Specification test limits are given in Table 7.2.1.

Table 7.2.1 Occupied bandwidth limits

Assigned frequency, MHz	Modulation envelope reference points*, dBc
902 - 928	20.0
2400 – 2483.5	
5725 – 5875	
24000 – 24250	

*- Modulation envelope reference points provided in terms of attenuation below modulated carrier.

7.2.2 Test procedure

7.2.2.1 The EUT was set up as shown in Figure 7.2.1, energized and its proper operation was checked.

7.2.2.2 The spectrum analyzer sweep time and bandwidth were set to capture all major modulation sidebands of emission and sweep time was set sufficiently slow to ensure peak measurements. Spectrum analyzer was set in peak hold mode and time sufficient for trace stabilization was allowed.

7.2.2.3 The peak of emission was measured. The transmitter occupied bandwidth was measured with spectrum analyzer as frequency delta between reference points on modulation envelope and provided in Table 7.2.2 and associated plot.

7.2.2.4 Modulation bandwidth was calculated by adding of the negative frequency drift to the lower measured frequency and the positive frequency drift to the higher measured frequency. The obtained modulation bandwidth was verified to be within the allowed frequency range.

Figure 7.2.1 Occupied bandwidth test setup





Test specification: Section 15.215(c), Occupied bandwidth			
Test procedure: ANSI C63.10 section 6.9.2			
Test mode: Compliance		Verdict: PASS	
Date(s): 14-Sep-16			
Temperature: 25 °C	Relative Humidity: 41 %	Air Pressure: 1009 hPa	Power: 120 VAC
Remarks:			

Table 7.2.2 Occupied bandwidth test results

ASSIGNED FREQUENCY BAND: 902.0 – 928.0 MHz
 DETECTOR USED: Peak hold
 RESOLUTION BANDWIDTH: 10 kHz
 VIDEO BANDWIDTH: 30 kHz
 MODULATION ENVELOPE REFERENCE POINTS: 20 dBc
 MODULATION: 2FSK

Band edge	Cross point frequency, MHz	Frequency drift, kHz		Modulation band edge, MHz	Assigned band edge, MHz	Verdict
		Negative	Positive			
Low	908.35	NA	NA	908.35	902.00	Pass
High	908.45	NA	NA	908.45	928.00	Pass

Reference numbers of test equipment used

HL 3818							
---------	--	--	--	--	--	--	--

Full description is given in Appendix A.



HERMON LABORATORIES

Test specification: Section 15.215(c), Occupied bandwidth			
Test procedure: ANSI C63.10 section 6.9.2			
Test mode: Compliance		Verdict: PASS	
Date(s): 14-Sep-16			
Temperature: 25 °C	Relative Humidity: 41 %	Air Pressure: 1009 hPa	Power: 120 VAC
Remarks:			

Plot 7.2.1 Occupied bandwidth test result

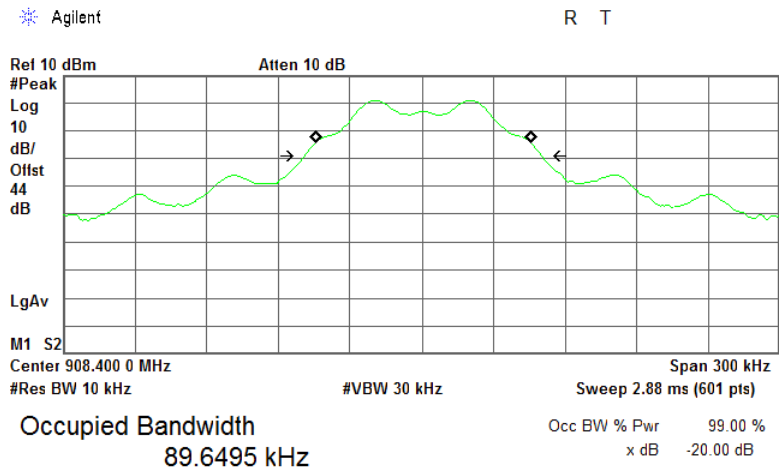

Transmit Freq Error 772.878 Hz
x dB Bandwidth 99.212 kHz



Test specification: Section 15.249(d)/RSS-210, section A2.9, Band edge emissions			
Test procedure: ANSI C63.10 section 6.10			
Test mode: Compliance		Verdict: PASS	
Date(s): 14-Sep-16			
Temperature: 27 °C	Relative Humidity: 41 %	Air Pressure: 1009 hPa	Power: 120 VAC
Remarks:			

7.3 Band edge emission

7.3.1 General

This test was performed to verify the EUT band edge emission including all associated side bands was attenuated at least 50 dB below the unmodulated carrier level or below the general spurious emission limit. Specification test limits are given in Table 7.3.1.

Table 7.3.1 Band edge emission limits

Frequency band, MHz	Field strength limit at 3 m, dBµV/m		Attenuation below carrier, dBc
	Peak	QP	
902.000 - 928.000	NA	46.0	50

7.3.2 Test procedure

7.3.2.1 The EUT was set up as shown in Figure 7.3.1, energized and the performance check was conducted.

7.3.2.2 The spectrum analyzer frequency span was set to capture all major modulation sidebands of emission and sweep time was set sufficiently slow to ensure peak measurements. Spectrum analyzer was set in peak hold mode and time sufficient for trace stabilization was allowed.

7.3.2.3 The frequency of modulation envelope points beyond which power level drops below the band edge emission limit was measured.

7.3.2.4 The test results were recorded in Table 7.3.2 and shown in the associated plots.



Test specification: Section 15.249(d)/RSS-210, section A2.9, Band edge emissions			
Test procedure: ANSI C63.10 section 6.10			
Test mode: Compliance		Verdict: PASS	
Date(s): 14-Sep-16			
Temperature: 27 °C	Relative Humidity: 41 %	Air Pressure: 1009 hPa	Power: 120 VAC
Remarks:			

Figure 7.3.1 Band edge emission measurement set up

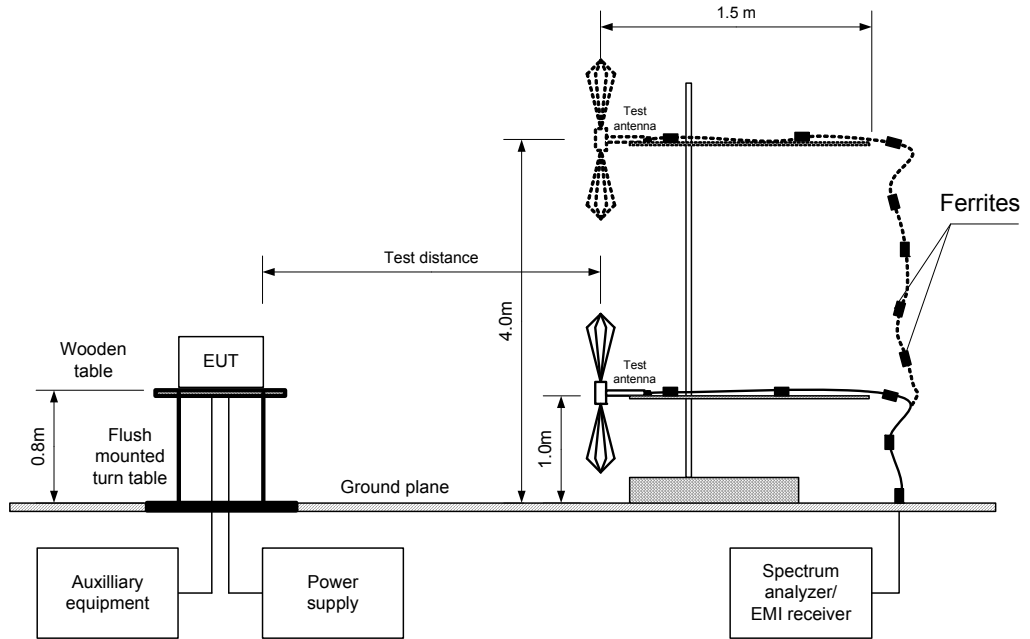



Test specification: Section 15.249(d)/RSS-210, section A2.9, Band edge emissions			
Test procedure: ANSI C63.10 section 6.10			
Test mode: Compliance		Verdict: PASS	
Date(s): 14-Sep-16			
Temperature: 27 °C	Relative Humidity: 41 %	Air Pressure: 1009 hPa	Power: 120 VAC
Remarks:			

Table 7.3.2 Band edge emission test results

OPERATING FREQUENCY RANGE: 902 – 928 MHz
DETECTOR USED: Peak hold
RESOLUTION BANDWIDTH: 120 kHz
VIDEO BANDWIDTH: 300 kHz
MODULATION: 2FSK
BIT RATE: 40 kbps
TRANSMITTER OUTPUT POWER SETTINGS: Maximum

Modulation envelope		Measured peak emission, dBµV/m	Measured QP emission, dBµV/m	QP limit, dBµV/m	Margin, dB *	Verdict
Edge	Frequency, MHz					
Low	902.00	39.82	36.25	46.00	-9.75	Pass
High	928.00	39.38	35.70	46.00	-10.30	Pass

* - Margin = measured value– limit

* - Measured frequency beyond which the emission dropped 50 dB below the carrier emission or below the field strength limit whichever was a less stringent

** - Margin = Band edge limit – Band edge frequency

Reference numbers of test equipment used

HL 0604	HL 2909	HL 4011	HL 4353	HL 5101			
---------	---------	---------	---------	---------	--	--	--

Full description is given in Appendix A.



Test specification: Section 15.249(d)/RSS-210, section A2.9, Band edge emissions			
Test procedure: ANSI C63.10 section 6.10			
Test mode: Compliance		Verdict: PASS	
Date(s): 14-Sep-16			
Temperature: 27 °C	Relative Humidity: 41 %	Air Pressure: 1009 hPa	Power: 120 VAC
Remarks:			

Plot 7.3.1 Low band edge emission test result

TEST SITE: Semi-anechoic chamber
 TEST DISTANCE: 3 m
 ANTENNA POLARIZATION: Vertical and Horizontal

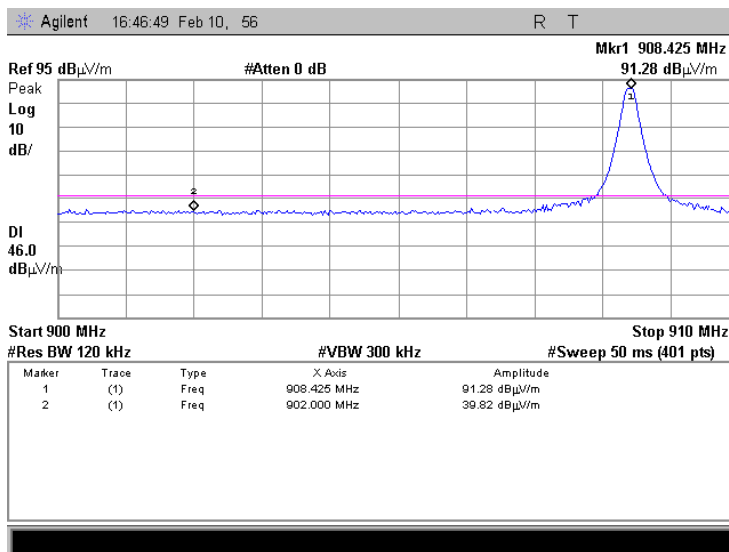

Plot 7.3.2 High band edge emission test result

TEST SITE: Semi-anechoic chamber
 TEST DISTANCE: 3 m
 ANTENNA POLARIZATION: Vertical and Horizontal

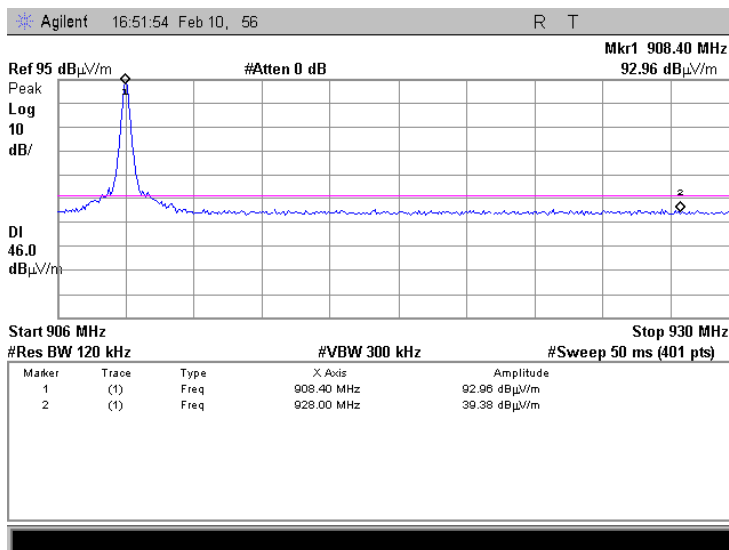



Test specification: Section 15.207(a)/ RSS-Gen, section 8.8, Conducted emission			
Test procedure: ANSI C63.10 section 6.2			
Test mode: Compliance		Verdict: PASS	
Date(s): 13-Sep-16			
Temperature: 26 °C	Relative Humidity: 36 %	Air Pressure: 1010 hPa	Power: 120 VAC
Remarks:			

7.4 Conducted emissions

7.4.1 General

This test was performed to measure common mode conducted emissions at the power port. Specification test limits are given in Table 7.4.1.

Table 7.4.1 Limits for conducted emissions

Frequency, MHz	Class B limit, dB(μV)	
	QP	AVRG
0.15 - 0.5	66 - 56*	56 - 46*
0.5 - 5.0	56	46
5.0 - 30	60	50

* The limit decreases linearly with the logarithm of frequency.

7.4.2 Test procedure

7.4.2.1 The EUT was set up as shown in Figure 7.4.1 and associated photographs, energized and the performance check was conducted.

7.4.2.2 The measurements were performed at power terminals with the LISN, connected to a spectrum analyzer in the frequency range referred to in Table 7.4.2. Unused coaxial connector of the LISN was terminated with 50 Ohm. Quasi-peak and average detectors were used throughout the testing.

7.4.2.3 The position of the device cables was varied to determine maximum emission level.

7.4.2.4 The worst test results (the lowest margins) were recorded in Table 7.4.2 and shown in the associated plots.



Test specification: Section 15.207(a)/ RSS-Gen, section 8.8, Conducted emission			
Test procedure: ANSI C63.10 section 6.2			
Test mode: Compliance		Verdict: PASS	
Date(s): 13-Sep-16			
Temperature: 26 °C	Relative Humidity: 36 %	Air Pressure: 1010 hPa	Power: 120 VAC
Remarks:			

Figure 7.4.1 Setup for conducted emission measurements, table-top equipment

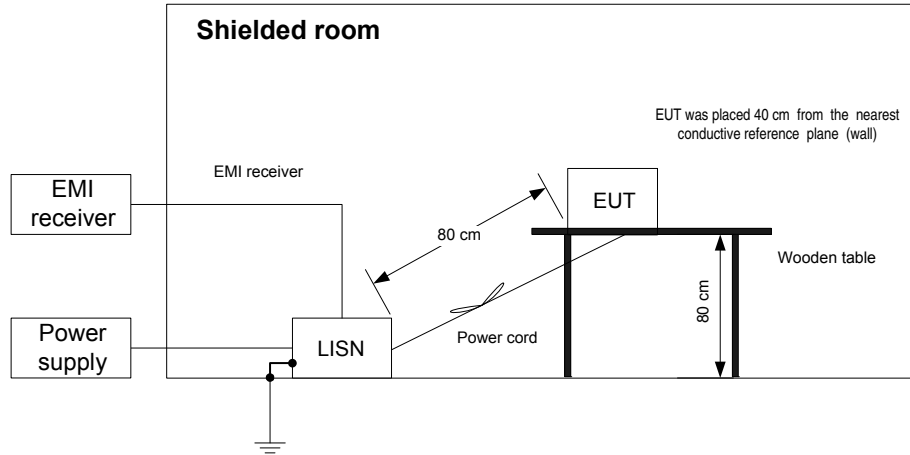



Test specification: Section 15.207(a)/ RSS-Gen, section 8.8, Conducted emission			
Test procedure: ANSI C63.10 section 6.2			
Test mode: Compliance		Verdict: PASS	
Date(s): 13-Sep-16			
Temperature: 26 °C	Relative Humidity: 36 %	Air Pressure: 1010 hPa	Power: 120 VAC
Remarks:			

Table 7.4.2 Conducted emission test results

LINE: AC mains
 EUT OPERATING MODE: Transmit
 EUT SET UP: TABLE-TOP
 TEST SITE: SHIELDED ROOM
 DETECTORS USED: PEAK / QUASI-PEAK / AVERAGE
 FREQUENCY RANGE: 150 kHz - 30 MHz
 RESOLUTION BANDWIDTH: 9 kHz

Frequency, MHz	Peak emission, dB(µV)	Quasi-peak			Average			Line ID	Verdict
		Measured emission, dB(µV)	Limit, dB(µV)	Margin, dB*	Measured emission, dB(µV)	Limit, dB(µV)	Margin, dB*		
0.155	52.74	49.54	65.75	-16.21	35.90	55.75	-19.85	L1	Pass
0.170	50.18	47.91	65.04	-17.13	33.33	55.04	-21.71		
0.198	47.67	43.32	63.72	-20.40	27.45	53.72	-26.27		
0.215	44.69	42.37	63.06	-20.69	27.26	53.06	-25.80		
0.262	40.89	38.00	61.43	-23.43	22.73	51.43	-28.70		
0.355	36.66	32.32	58.90	-26.58	19.12	48.90	-29.78		
0.155	53.09	49.30	65.75	-16.45	35.68	55.75	-20.07	L2	Pass
0.170	50.55	47.46	65.04	-17.58	33.07	55.04	-21.97		
0.198	45.85	42.31	63.72	-21.41	26.94	53.72	-26.78		
0.215	45.16	41.07	63.06	-21.99	27.32	53.06	-25.74		
0.262	40.87	36.74	61.43	-24.69	21.38	51.43	-30.05		
0.355	35.95	31.05	58.90	-27.85	18.98	48.90	-29.92		

*- Margin = Measured emission - specification limit.

Reference numbers of test equipment used

HL 0447	HL 0787	HL 1513	HL 3612	HL 4778			
---------	---------	---------	---------	---------	--	--	--

Full description is given in Appendix A.



HERMON LABORATORIES

Test specification: Section 15.207(a)/ RSS-Gen, section 8.8, Conducted emission			
Test procedure: ANSI C63.10 section 6.2			
Test mode: Compliance		Verdict: PASS	
Date(s): 13-Sep-16			
Temperature: 26 °C	Relative Humidity: 36 %	Air Pressure: 1010 hPa	Power: 120 VAC
Remarks:			

Plot 7.4.1 Conducted emission measurements

LINE: L1
 EUT OPERATING MODE: Transmit
 LIMIT: QUASI-PEAK, AVERAGE
 DETECTOR: PEAK

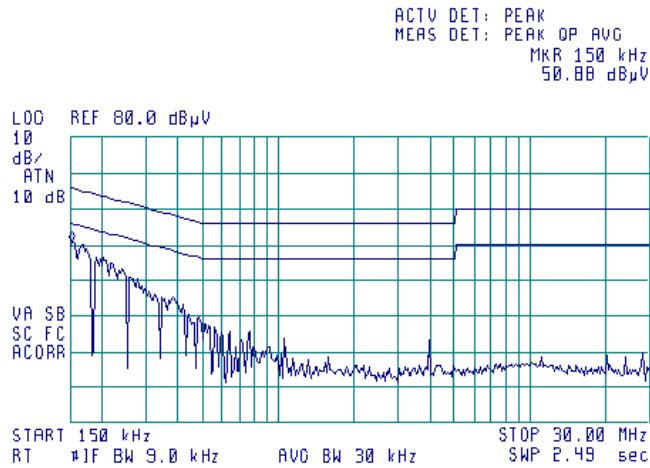

Plot 7.4.2 Conducted emission measurements

LINE: L2
 EUT OPERATING MODE: Transmit
 LIMIT: QUASI-PEAK, AVERAGE
 DETECTOR: PEAK

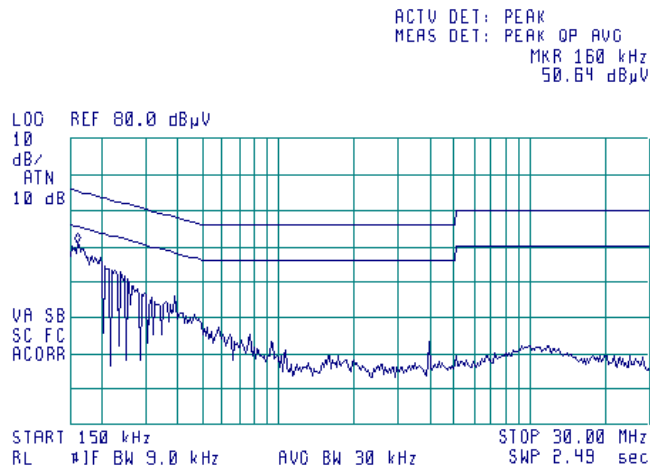



Test specification: Section 15.203/ RSS-Gen, section 8.3, Antenna requirement			
Test procedure: Visual inspection / supplier declaration			
Test mode: Compliance		Verdict: PASS	
Date(s): 13-Sep-16			
Temperature: 26 °C	Relative Humidity: 46 %	Air Pressure: 1010 hPa	Power: 120 VAC
Remarks:			

7.5 Antenna requirements

The EUT was verified for compliance with antenna requirements. A transmitter shall be designed to ensure that no antenna other than that furnished by the responsible party will be used with the device. It may be either permanently attached or employs a unique antenna connector for every antenna proposed for use with the EUT. This requirement does not apply to professionally installed transmitters. The rationale for compliance with the above requirements was either visual inspection results or supplier declaration. The summary of results is provided in Table 7.5.1.

Table 7.5.1 Antenna requirements

Requirement	Rationale	Verdict
The transmitter antenna is permanently attached	Visual inspection	Comply
The transmitter employs a unique antenna connector	NA	
The transmitter requires professional installation	NA	

Photograph 7.5.1 Antenna assembly

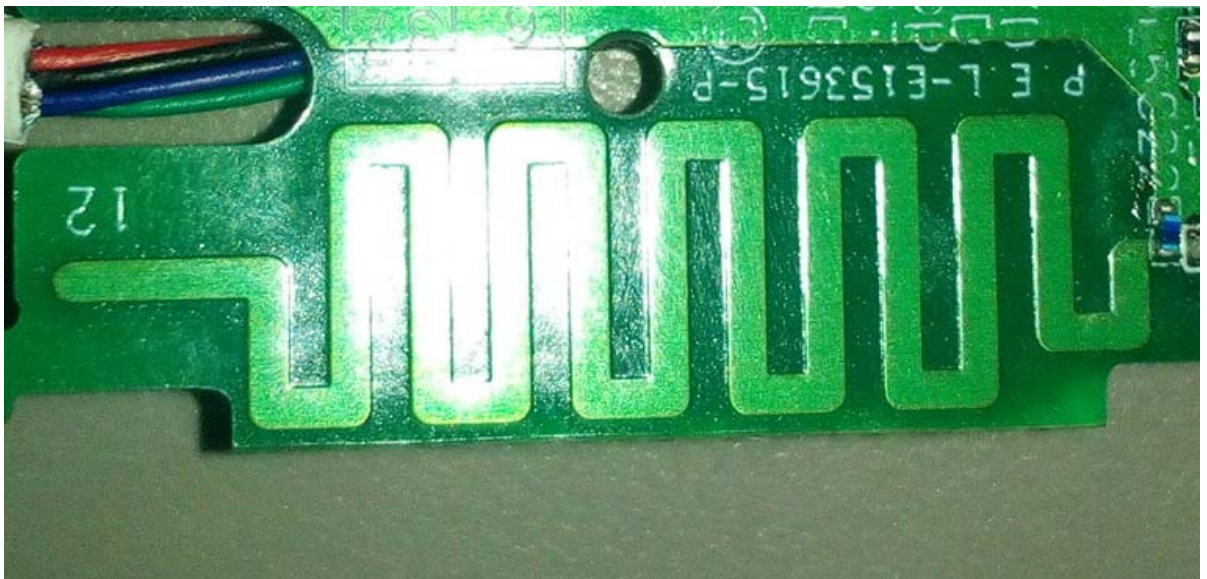



Test specification:	FCC Part 15, Section 107 / ICES-003, Section 6.1, Class B, Conducted emission at AC power port		
Test procedure:	ANSI C63.4, Section 7.3 and 12.2.4		
Test mode:	Compliance	Verdict:	PASS
Date(s):	13-Sep-16		
Temperature: 26 °C	Relative Humidity: 36 %	Air Pressure: 1010 hPa	Power: 120 VAC
Remarks:			

8 Emission tests according to 47CFR part 15 subpart B requirements

8.1 Conducted emissions

8.1.1 General

This test was performed to measure common mode conducted emissions at the mains power port. Specification test limits are given in Table 8.1.1.

Table 8.1.1 Limits for conducted emissions

Frequency, MHz	Class B limit, dB(μ V)		Class A limit, dB(μ V)	
	QP	AVRG	QP	AVRG
0.15 - 0.5	66 - 56*	56 - 46*	79	66
0.5 - 5.0	56	46	73	60
5.0 - 30	60	50	73	60

* The limit decreases linearly with the logarithm of frequency.

8.1.2 Test procedure

- 8.1.2.1** The EUT was set up as shown in Figure 8.1.1 and associated photographs, energized and the performance check was conducted.
- 8.1.2.2** The measurements were performed at power terminals with the LISN, connected to a spectrum analyzer in the frequency range referred to in Table 8.1.2. Unused coaxial connector of the LISN was terminated with 50 Ohm. Quasi-peak and average detectors were used throughout the testing.
- 8.1.2.3** The position of the device cables was varied to determine maximum emission level.
- 8.1.2.4** The worst test results (the lowest margins) were recorded in Table 8.1.2 and shown in the associated plots.



Test specification: FCC Part 15, Section 107 / ICES-003, Section 6.1, Class B, Conducted emission at AC power port			
Test procedure: ANSI C63.4, Section 7.3 and 12.2.4			
Test mode: Compliance		Verdict: PASS	
Date(s): 13-Sep-16			
Temperature: 26 °C	Relative Humidity: 36 %	Air Pressure: 1010 hPa	Power: 120 VAC
Remarks:			

Figure 8.1.1 Setup for conducted emission measurements, table-top equipment

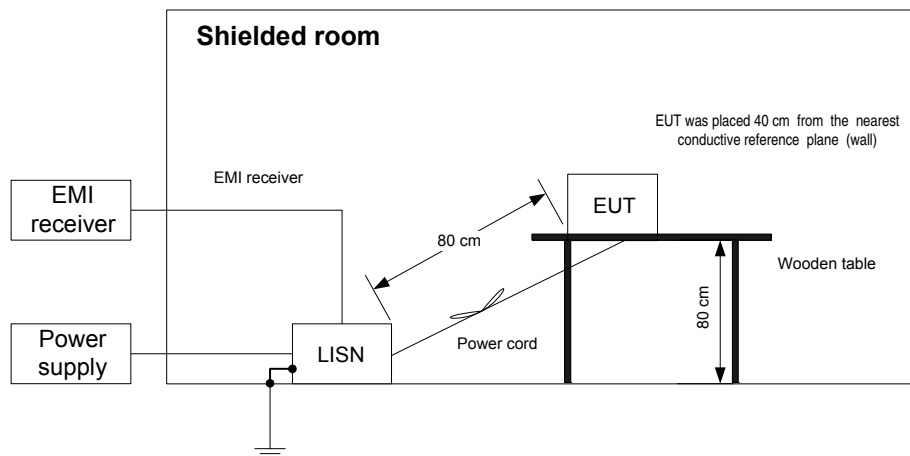

Photograph 8.1.1 Setup for conducted emission measurements





Test specification: FCC Part 15, Section 107 / ICES-003, Section 6.1, Class B, Conducted emission at AC power port			
Test procedure: ANSI C63.4, Section 7.3 and 12.2.4			
Test mode: Compliance		Verdict: PASS	
Date(s): 13-Sep-16			
Temperature: 26 °C	Relative Humidity: 36 %	Air Pressure: 1010 hPa	Power: 120 VAC
Remarks:			

Table 8.1.2 Conducted emission test results according to FCC Part 15, Section 107 and ICES-003, Section 5

LINE: AC mains
LIMIT: Class B
EUT OPERATING MODE: Receive / Stand-by
EUT SET UP: TABLE-TOP
TEST SITE: SHIELDED ROOM
DETECTORS USED: PEAK / QUASI-PEAK / AVERAGE
FREQUENCY RANGE: 150 kHz - 30 MHz
RESOLUTION BANDWIDTH: 9 kHz

Frequency, MHz	Peak emission, dB(µV)	Quasi-peak			Average			Line ID	Verdict
		Measured emission, dB(µV)	Limit, dB(µV)	Margin, dB*	Measured emission, dB(µV)	Limit, dB(µV)	Margin, dB*		
0.155	49.85	48.74	65.75	-17.01	32.89	55.75	-22.86	L1	Pass
0.170	49.51	46.14	65.04	-18.90	29.91	55.04	-25.13		
0.198	46.30	43.69	63.72	-20.03	28.43	53.72	-25.29		
0.215	44.33	41.79	63.06	-21.27	26.31	53.06	-26.75		
0.262	40.23	37.22	61.43	-24.21	22.28	51.43	-29.15		
0.355	36.60	32.76	58.90	-26.14	18.86	48.91	-30.05		
0.155	50.36	47.21	65.75	-18.54	30.27	55.75	-25.48	L2	Pass
0.170	49.88	46.14	65.04	-18.90	30.67	55.04	-24.37		
0.198	47.08	43.56	63.72	-20.16	27.27	53.72	-26.45		
0.215	45.31	40.65	63.06	-22.41	24.84	53.06	-28.22		
0.262	40.24	37.30	61.43	-24.13	22.36	51.43	-29.07		
0.355	35.82	31.89	58.90	-27.01	18.91	48.90	-29.99		

*- Margin = Measured emission - specification limit.

Reference numbers of test equipment used

HL 0447	HL 0787	HL 1513	HL 3612	HL 4778		
---------	---------	---------	---------	---------	--	--

Full description is given in Appendix A.



Test specification: FCC Part 15, Section 107 / ICES-003, Section 6.1, Class B, Conducted emission at AC power port			
Test procedure: ANSI C63.4, Section 7.3 and 12.2.4			
Test mode: Compliance		Verdict: PASS	
Date(s): 13-Sep-16			
Temperature: 26 °C	Relative Humidity: 36 %	Air Pressure: 1010 hPa	Power: 120 VAC
Remarks:			

Plot 8.1.1 Conducted emission measurements

LINE: L1
LIMIT: Class B
EUT OPERATING MODE: Receive
LIMIT: QUASI-PEAK, AVERAGE
DETECTOR: PEAK

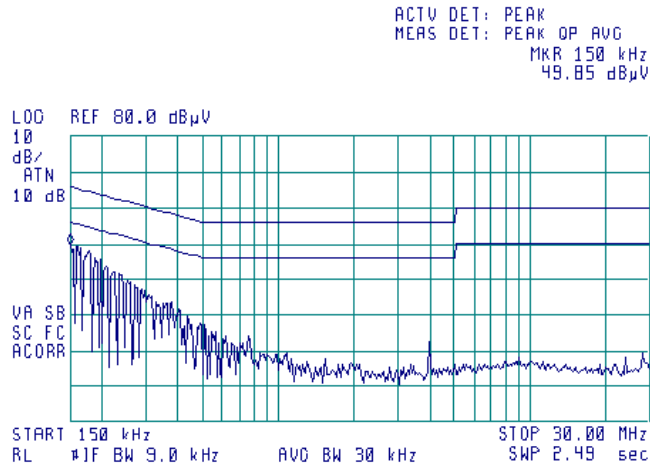

Plot 8.1.2 Conducted emission measurements

LINE: L2
LIMIT: Class B
EUT OPERATING MODE: Receive
LIMIT: QUASI-PEAK, AVERAGE
DETECTOR: PEAK

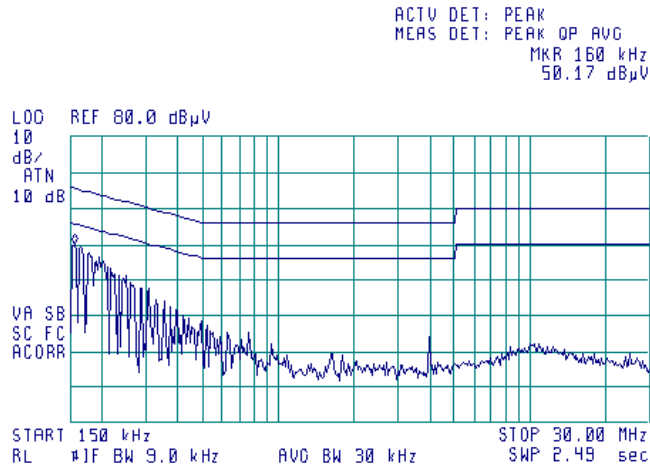



Test specification: FCC Part 15, Section 109 / RSS-Gen, Section 7.2.3 / ICES-003, Radiated emission Class B			
Test procedure: ANSI C63.4, Sections 8.3 and 12.2.5			
Test mode: Compliance		Verdict: PASS	
Date(s): 14-Sep-16			
Temperature: 25 °C	Relative Humidity: 44 %	Air Pressure: 1009 hPa	Power: 120 VAC
Remarks:			

8.2 Radiated emission measurements

8.2.1 General

This test was performed to measure radiated emissions from the EUT enclosure. Specification test limits are given in Table 8.2.1, Table 8.2.2.

Table 8.2.1 Radiated emission test limits according to FCC Part 15, Section 109 and ICES-003, Section 6.2

Frequency, MHz	Class B limit, dB(µV/m)		Class A limit, dB(µV/m)	
	10 m distance	3 m distance	10 m distance	3 m distance
30 - 88	29.5*	40.0	39.0	49.5*
88 - 216	33.0*	43.5	43.5	54.0*
216 - 960	35.5*	46.0	46.4	56.9*
Above 960	43.5*	54.0	49.5	60.0*

* The limit for test distance other than specified was calculated using the inverse linear distance extrapolation factor as follows: $Lim_{S_2} = Lim_{S_1} + 20 \log(S_1/S_2)$, where S_1 and S_2 – standard defined and test distance respectively in meters.

Table 8.2.2 Radiated emission limits according to RSS-Gen, Section 7.1.2

Frequency, MHz	Field strength limit at 3 m test distance, dB(µV/m)
30 - 88	40.0
88 - 216	43.5
216 - 960	46.0
960 - 5 th harmonic**	54.0

** - harmonic of the highest frequency the EUT generates, uses, operates or tunes to.

8.2.2 Test procedure

- 8.2.2.1 The EUT was set up as shown in Figure 8.2.1 and associated photograph/s, energized and the performance check was conducted.
- 8.2.2.2 Preliminary measurements were performed in the anechoic chamber at 3 m test distance. The specified frequency range was investigated with biconical and log periodic antennas connected to EMI receiver. To find maximum radiation the turntable was rotated 360°, the measuring antenna height was changed, its polarization was switched from vertical to horizontal and the EUT cables position was varied.
- 8.2.2.3 The EUT was set up as shown in Figure 8.2.2, energized and the performance check was conducted.
- 8.2.2.4 Final measurements were performed at the open area test site at 3 m test distance. The EUT wires and cables were arranged to produce maximum emission as it was found during preliminary measurements. The frequencies yield the worst test results (the lowest margins) during preliminary testing were investigated with biconilog antenna connected to EMI receiver. To find maximum radiation the turntable was rotated 360°, the measuring antenna height was changed from 1 to 4 m and its polarization was changed from vertical to horizontal.
- 8.2.2.5 The worst test results (the lowest margins) were recorded in Table 8.2.3 and shown in the associated plots.



Test specification: FCC Part 15, Section 109 / RSS-Gen, Section 7.2.3 / ICES-003, Radiated emission Class B			
Test procedure: ANSI C63.4, Sections 8.3 and 12.2.5			
Test mode: Compliance	Verdict: PASS		
Date(s): 14-Sep-16			
Temperature: 25 °C	Relative Humidity: 44 %	Air Pressure: 1009 hPa	Power: 120 VAC
Remarks:			

Figure 8.2.1 Setup for radiated emission measurements in anechoic chamber, table-top equipment

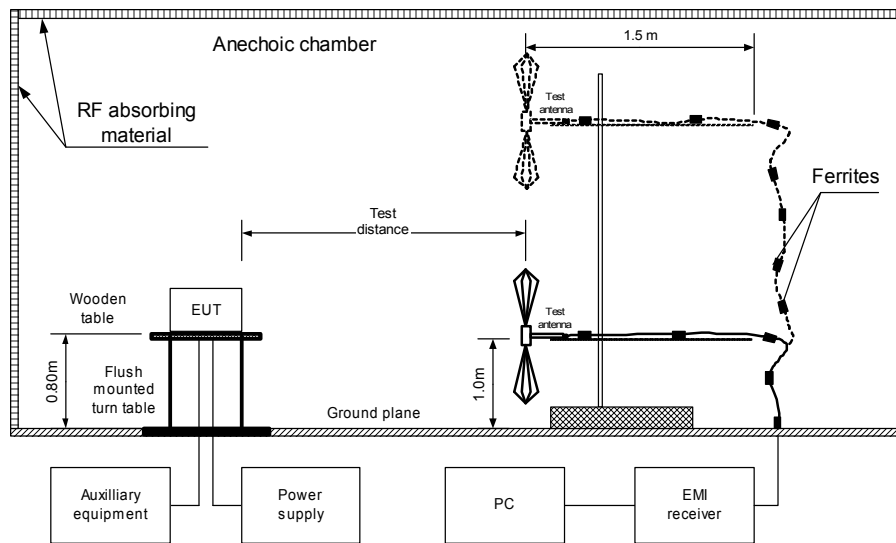

Photograph 8.2.1 Setup for radiated emission measurements in the anechoic chamber





Test specification: FCC Part 15, Section 109 / RSS-Gen, Section 7.2.3 / ICES-003, Radiated emission Class B			
Test procedure: ANSI C63.4, Sections 8.3 and 12.2.5			
Test mode: Compliance	Verdict: PASS		
Date(s): 14-Sep-16			
Temperature: 25 °C	Relative Humidity: 44 %	Air Pressure: 1009 hPa	Power: 120 VAC
Remarks:			

Figure 8.2.2 Setup for radiated emission measurements at OATS, table-top equipment

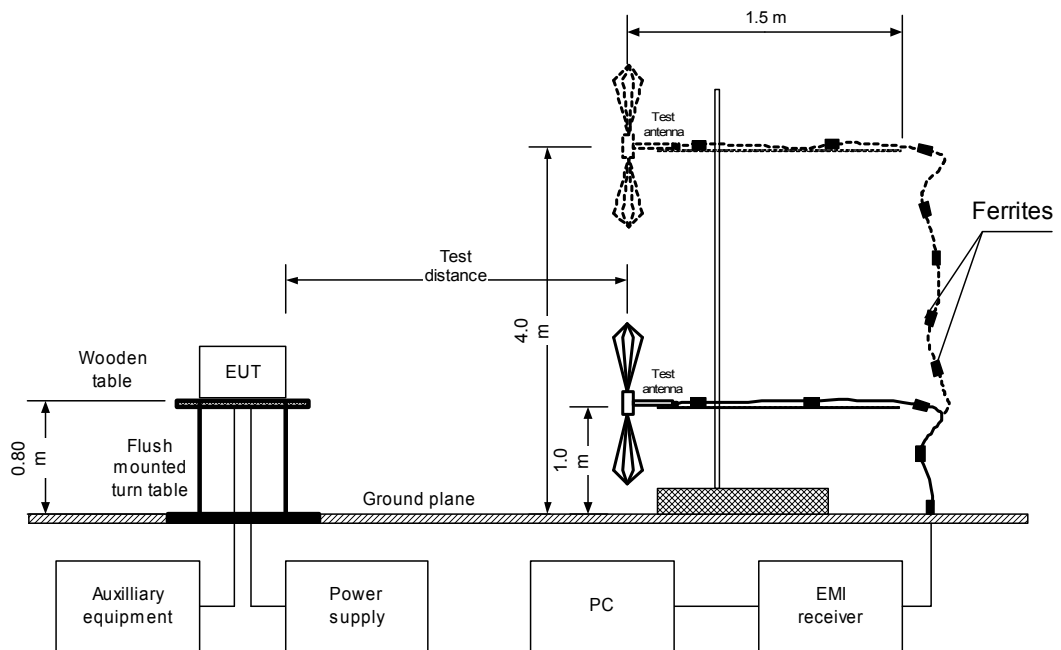



Test specification: FCC Part 15, Section 109 / RSS-Gen, Section 7.2.3 / ICES-003, Radiated emission Class B			
Test procedure: ANSI C63.4, Sections 8.3 and 12.2.5			
Test mode: Compliance	Verdict: PASS		
Date(s): 14-Sep-16			
Temperature: 25 °C	Relative Humidity: 44 %	Air Pressure: 1009 hPa	Power: 120 VAC
Remarks:			

Photograph 8.2.2 Setup for radiated emission measurements at the OATS, general view



Photograph 8.2.3 Setup for radiated emission measurements, EUT cabling





Test specification: FCC Part 15, Section 109 / RSS-Gen, Section 7.2.3 / ICES-003, Radiated emission Class B			
Test procedure: ANSI C63.4, Sections 8.3 and 12.2.5			
Test mode: Compliance		Verdict: PASS	
Date(s): 14-Sep-16			
Temperature: 25 °C	Relative Humidity: 44 %	Air Pressure: 1009 hPa	Power: 120 VAC
Remarks:			

Table 8.2.3 Radiated emission test results

EUT SET UP: TABLE-TOP
LIMIT: Class B
EUT OPERATING MODE: Receive
TEST SITE: OATS
TEST DISTANCE: 3 m
DETECTORS USED: PEAK / QUASI-PEAK
FREQUENCY RANGE: 30 MHz – 1000 MHz
RESOLUTION BANDWIDTH: 120 kHz

Frequency, MHz	Peak emission, dB(µV/m)	Quasi-peak			Antenna polarization	Antenna height, m	Turn-table position**, degrees	Verdict
		Measured emission, dB(µV/m)	Limit, dB(µV/m)	Margin, dB*				
50.00	35.31	30.53	40.00	-9.47	Vertical	1.0	360	Pass
191.99	36.11	31.22	43.50	-12.28	Vertical	1.2	90	

TEST SITE: OATS
TEST DISTANCE: 3 m
DETECTORS USED: PEAK / AVERAGE
FREQUENCY RANGE: 1000 MHz – 5000 MHz
RESOLUTION BANDWIDTH: 1000 kHz

Frequency, MHz	Peak			Average			Antenna polarization	Antenna height, m	Turn-table position**, degrees	Verdict
	Measured emission, dB(µV/m)	Limit, dB(µV/m)	Margin, dB*	Measured emission, dB(µV/m)	Limit, dB(µV/m)	Margin, dB*				
No emissions were found										Pass

*- Margin = Measured emission – specification limit.
**- EUT front panel refer to 0 degrees position of turntable.

Reference numbers of test equipment used

HL 0415	HL 0521	HL 0604	HL 0651	HL 2432	HL 4011	HL 4294	HL 4778
HL 5101							

Full description is given in Appendix A.



HERMON LABORATORIES

Test specification: FCC Part 15, Section 109 / RSS-Gen, Section 7.2.3 / ICES-003, Radiated emission Class B			
Test procedure: ANSI C63.4, Sections 8.3 and 12.2.5			
Test mode: Compliance		Verdict: PASS	
Date(s): 14-Sep-16			
Temperature: 25 °C	Relative Humidity: 44 %	Air Pressure: 1009 hPa	Power: 120 VAC
Remarks:			

Plot 8.2.1 Radiated emission measurements in 30 – 1000 MHz range, vertical antenna polarization

TEST SITE: Semi anechoic chamber
LIMIT: Class B
TEST DISTANCE: 3 m
EUT OPERATING MODE: Receive

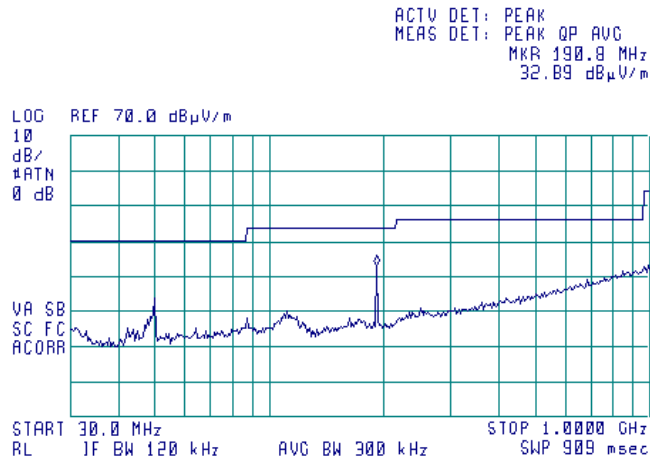

Plot 8.2.2 Radiated emission measurements in 30 – 1000 MHz range, horizontal antenna polarization

TEST SITE: Semi anechoic chamber
LIMIT: Class B
TEST DISTANCE: 3 m
EUT OPERATING MODE: Receive

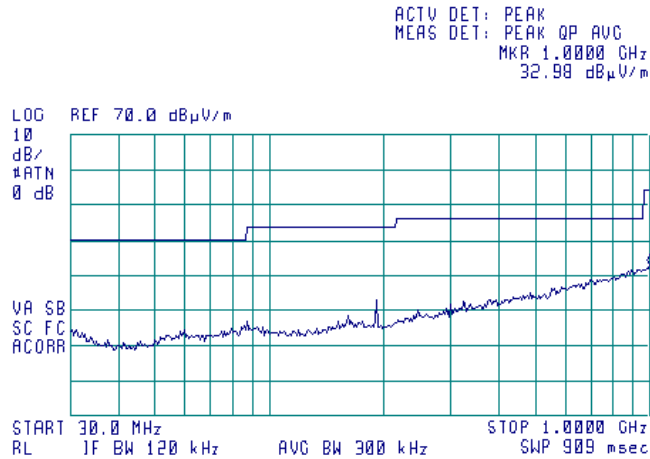



HERMON LABORATORIES

Test specification: FCC Part 15, Section 109 / RSS-Gen, Section 7.2.3 / ICES-003, Radiated emission Class B			
Test procedure: ANSI C63.4, Sections 8.3 and 12.2.5			
Test mode: Compliance		Verdict: PASS	
Date(s): 14-Sep-16			
Temperature: 25 °C	Relative Humidity: 44 %	Air Pressure: 1009 hPa	Power: 120 VAC
Remarks:			

Plot 8.2.3 Radiated emission measurements above 1000 MHz, vertical antenna polarization

TEST SITE: Semi anechoic chamber
LIMIT: Class B
TEST DISTANCE: 3 m
EUT OPERATING MODE: Receive

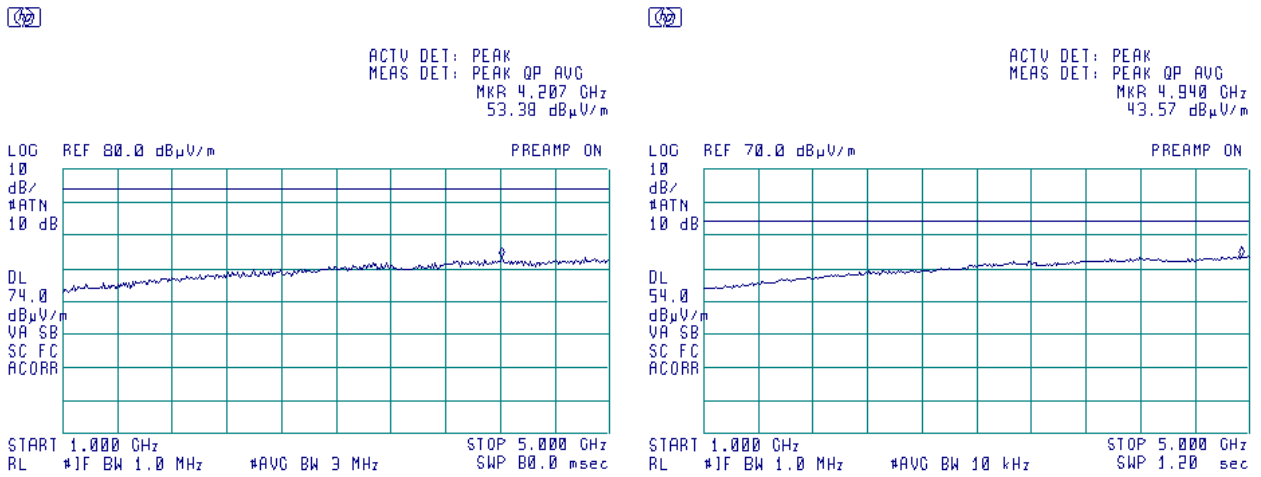

Plot 8.2.4 Radiated emission measurements above 1000 MHz, horizontal antenna polarization

TEST SITE: Semi anechoic chamber
LIMIT: Class B
TEST DISTANCE: 3 m
EUT OPERATING MODE: Receive

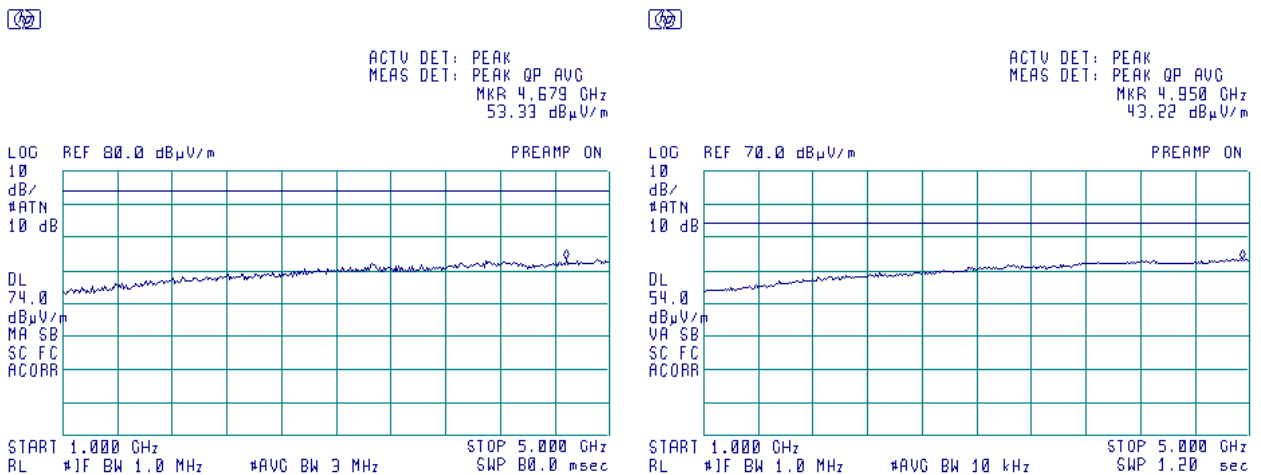



9 APPENDIX A Test equipment and ancillaries used for tests

HL No	Description	Manufacturer	Model	Ser. No.	Last Cal./ Check	Due Cal./ Check
0415	Cable, Coax, RF, RG-214, 12.3 m	Hermon Laboratories	CC-3	056	07-Dec-15	07-Dec-16
0446	Antenna, Loop, Active, 10 kHz – 30 MHz	EMCO	6502	2857	18-Jan-16	18-Jan-17
0447	LISN, 16/2, 300V RMS, 50 Ohm/50 uH + 5 Ohm, STD CISPR 16-1	Hermon Laboratories	LISN 16 – 1	066	13-Oct-16	13-Oct-17
0465	Anechoic Chamber 9(L) x 6.5(W) x 5.5(H) m	Hermon Laboratories	AC - 1	023	5-Apr-16	5-Apr-17
0521	EMI Receiver (Spectrum Analyzer) with RF filter section 9 kHz-6.5 GHz	Hewlett Packard	8546A	3617A 00319, 3448A002 53	27-Oct-15	27-Oct-16
0604	Antenna BiconiLog Log-Periodic/T Bow-TIE, 26 - 2000 MHz	EMCO	3141	9611-1011	10-May-16	10-May-17
0651	Antenna, Biconical, 30 - 200 MHz	Hermon Laboratories	AB-200	124	16-Mar-16	16-Mar-18
0787	Transient Limiter 9 kHz-200 MHz	Hewlett Packard	11947A	3107A018 77	12-Oct-16	12-Oct-17
1513	Cable RF, 8 m, BNC/BNC	Belden	M17/167 MIL-C-17	1513	20-Sep-16	20-Sep-17
2432	Antenna, Double-Ridged Waveguide Horn 1 to 18 GHz	EMC Test Systems	3115	00027177	28-Mar-16	28-Mar-17
2909	Spectrum analyzer, ESA-E, 100 Hz to 26.5 GHz	Agilent Technologies	E4407B	MY414447 62	21-Feb-16	21-Feb-17
3389	Microwave Cable Assembly, 26.5 GHz, 1.0 m, N type/N type	Suhner Sucoflex	104EA	3389	10-Feb-16	10-Feb-17
3612	Cable RF, 17.5 m, N type-N type	Teldor	RG-214/U	NA	07-Dec-15	07-Dec-16
3818	PSA Series Spectrum Analyzer, 3 Hz- 44 GHz	Agilent Technologies	E4446A	MY482502 88	03-May-16	03-May-17
4011	Temp. & Humidity Meter, (-50 - +70) deg, (20 - 99)% RH	Mad Electronics	HTC-1	NA	20-Sep-16	20-Sep-17
4294	Microwave Cable Assembly, 18.0 GHz, 3.4 m, SMA/SMA	Huber-Suhner	Sucoflex P103	NA	07-Dec-15	07-Dec-16
4353	Low Loss Armored Test Cable, DC - 18 GHz, 6.2 m, N type-M/N type-M	MegaPhase	NC29-N1N1-244	12025101 003	15-Mar-16	15-Mar-17
4778	EMI Receiver, 9 kHz - 2.9 GHz, System: HL1431, HL4777	Hewlett Packard	8542E	30807A00 262, 3427A001 23	05-Nov-15	05-Nov-16
4932	Microwave preamplifier, 500 MHz to 18 GHz, 40 dB Gain	COM-POWER CORPORATION	PAM-118A	551029	01-Sep-16	01-Sep-17
5101	RF cable, 18 GHz, 6 m, N-type	Huber-Suhner	SF106A/1 1N/11N/6 000MM	500847/6A	26-Jul-16	26-Jul-17

10 APPENDIX B Measurement uncertainties

Expanded uncertainty at 95% confidence in Hermon Labs EMC measurements

Test description	Expanded uncertainty
Conducted emissions with LISN	9 kHz to 150 kHz: ± 3.9 dB 150 kHz to 30 MHz: ± 3.8 dB
Radiated emissions at 10 m measuring distance Horizontal polarization Vertical polarization	Biconilog antenna: ± 5.0 dB Biconical antenna: ± 5.0 dB Log periodic antenna: ± 5.1 dB Double ridged horn antenna: ± 5.3 dB Biconilog antenna: ± 5.5 dB Biconical antenna: ± 5.5 dB Log periodic antenna: ± 5.6 dB Double ridged horn antenna: ± 5.8 dB
Radiated emissions at 3 m measuring distance Horizontal polarization Vertical polarization	Biconilog antenna: ± 5.3 dB Biconical antenna: ± 5.0 dB Log periodic antenna: ± 5.3 dB Double ridged horn antenna: ± 5.3 dB Biconilog antenna: ± 6.0 dB Biconical antenna: ± 5.7 dB Log periodic antenna: ± 6.0 dB Double ridged horn antenna: ± 6.0 dB
Conducted emissions at RF antenna connector	9 kHz to 2.9 GHz: ± 2.6 dB 2.9 GHz to 6.46 GHz: ± 3.5 dB 6.46 GHz to 13.2 GHz: ± 4.3 dB 13.2 GHz to 22.0 GHz: ± 5.0 dB 22.0 GHz to 26.8 GHz: ± 5.5 dB 26.8 GHz to 40.0 GHz: ± 4.8 dB
Duty cycle, timing (Tx ON / OFF) and average factor measurements	± 1.0 %
Occupied bandwidth	± 8.0 %

Hermon Laboratories is accredited by A2LA for calibration according to present requirements of ISO/IEC 17025 and NCSL Z540-1. The accreditation is granted to perform calibration of parameters that are listed in the Scope of Hermon Laboratories Accreditation.

Hermon Laboratories calibrates its reference and transfer standards by calibration laboratories accredited to ISO/IEC 17025 by a mutually recognized Accreditation Body or by a recognized national metrology institute. All reference and transfer standards used in the calibration system are traceable to national or international standards.

In-house calibration of all test and measurement equipment is performed on a regular basis according to Hermon Laboratories calibration procedures, manufacturer calibration/verification procedures or procedures defined in the relevant standards. The Hermon Laboratories test and measurement equipment is calibrated within the tolerances specified by the manufacturers and/or by the relevant standards.

11 APPENDIX C Test laboratory description

Tests were performed at Hermon Laboratories Ltd., which is a fully independent, private, EMC, safety, environmental and telecommunication testing facility.

Hermon Laboratories is recognized and accredited by the Federal Communications Commission (USA) for 1, 2, 15, 18 parts of Code of Federal Regulations 47 (CFR 47), Test Firm Registration Number is 927748, Designation Number is IL1001; registered by Industry Canada for electromagnetic emissions, file number IC 2186A-1 for OATS, certified by VCCI, Japan (the registration numbers are R-808 for OATS, R-1082 for anechoic chamber, G-869 for RE measurements above 1 GHz, C-845 for conducted emissions site, T-1606 for conducted emissions at telecommunication ports). The laboratory is accredited by American Association for Laboratory Accreditation (USA) according to ISO/IEC 17025 for electromagnetic compatibility, product safety, telecommunications testing and environmental simulation (for exact scope please refer to Certificate No. 839.01).

Address: P.O. Box 23, Binyamina 30500, Israel.
Telephone: +972 4628 8001
Fax: +972 4628 8277
e-mail: mail@hermonlabs.com
website: www.hermonlabs.com

Person for contact: Mr. Alex Usoskin, CEO.

12 APPENDIX D Specification references

FCC 47CFR part 15: 2015	Radio Frequency Devices
ANSI C63.10: 2013	American National Standard of Procedures for Compliance Testing of Unlicensed Wireless Devices
ANSI C63.2: 1996	American National Standard for Instrumentation-Electromagnetic Noise and Field Strength, 10 kHz to 40 GHz-Specifications
ANSI C63.4: 2014	American National Standard for Methods of Measurement of Radio-Noise Emissions from Low-Voltage Electrical and Electronic Equipment in the Range of 9 kHz to 40 GHz
RSS-210 Issue 8: 2010	Low Power Licence- Exempt Radiocommunication Devices
RSS-Gen Issue 4: 2014	General Requirements and Information for the Certification of Radiocommunication Equipment
ICES-003 Issue 6: 2016	Information Technology Equipment (Including Digital Apparatus) – Limits and methods of measurement



13 APPENDIX E Test equipment correction factors

Correction factor
Line impedance stabilization network
Model LISN 16 - 1
Hermon Laboratories, HL 0447

Frequency, kHz	Correction factor, dB
10	4.9
15	2.86
20	1.83
25	1.25
30	0.91
35	0.69
40	0.53
50	0.35
60	0.25
70	0.18
80	0.14
90	0.11
100	0.09
125	0.06
150	0.04

The correction factor in dB is to be added to meter readings of an interference analyzer or a spectrum analyzer.



Antenna factor
Active loop antenna
Model 6502, S/N 2857, HL 0446

Frequency, MHz	Magnetic antenna factor, dB	Electric antenna factor, dB
0.009	-32.8	18.7
0.010	-33.8	17.7
0.020	-38.3	13.2
0.050	-41.1	10.4
0.075	-41.3	10.2
0.100	-41.6	9.9
0.150	-41.7	9.8
0.250	-41.6	9.9
0.500	-41.8	9.8
0.750	-41.9	9.7
1.000	-41.4	10.1
2.000	-41.5	10.0
3.000	-41.4	10.2
4.000	-41.4	10.1
5.000	-41.5	10.1
10.000	-41.9	9.6
15.000	-41.9	9.6
20.000	-42.2	9.3
25.000	-42.8	8.7
30.000	-44.0	7.5

Antenna factor in dB(1/m) is to be added to receiver meter reading in dB(μ V) to convert it into field strength in dB(μ V/m).



Antenna factor
Biconilog antenna EMCO Model 3141
Ser.No.1011, HL 0604

Frequency, MHz	Antenna factor, dB(1/m)	Frequency, MHz	Antenna factor, dB(1/m)	Frequency, MHz	Antenna factor, dB(1/m)
26	7.8	580	20.6	1320	27.8
28	7.8	600	21.3	1340	28.3
30	7.8	620	21.5	1360	28.2
40	7.2	640	21.2	1380	27.9
60	7.1	660	21.4	1400	27.9
70	8.5	680	21.9	1420	27.9
80	9.4	700	22.2	1440	27.8
90	9.8	720	22.2	1460	27.8
100	9.7	740	22.1	1480	28.0
110	9.3	760	22.3	1500	28.5
120	8.8	780	22.6	1520	28.9
130	8.7	800	22.7	1540	29.6
140	9.2	820	22.9	1560	29.8
150	9.8	840	23.1	1580	29.6
160	10.2	860	23.4	1600	29.5
170	10.4	880	23.8	1620	29.3
180	10.4	900	24.1	1640	29.2
190	10.3	920	24.1	1660	29.4
200	10.6	940	24.0	1680	29.6
220	11.6	960	24.1	1700	29.8
240	12.4	980	24.5	1720	30.3
260	12.8	1000	24.9	1740	30.8
280	13.7	1020	25.0	1760	31.1
300	14.7	1040	25.2	1780	31.0
320	15.2	1060	25.4	1800	30.9
340	15.4	1080	25.6	1820	30.7
360	16.1	1100	25.7	1840	30.6
380	16.4	1120	26.0	1860	30.6
400	16.6	1140	26.4	1880	30.6
420	16.7	1160	27.0	1900	30.6
440	17.0	1180	27.0	1920	30.7
460	17.7	1200	26.7	1940	30.9
480	18.1	1220	26.5	1960	31.2
500	18.5	1240	26.5	1980	31.6
520	19.1	1260	26.5	2000	32.0
540	19.5	1280	26.6		
560	19.8	1300	27.0		

Antenna factor in dB(1/m) is to be added to receiver meter reading in dB(μV) to convert it into field strength in dB(μV/m).



Antenna factor
Biconical antenna
HL, model LPA 200/1000
Ser.No.124, HL 0651

Frequency MHz	Antenna Factor dB(1/m)
30	14.0
35	11.9
40	10.9
45	10.3
50	10.1
60	9.7
70	7.9
80	7.1
90	9.1
100	11.1
120	15.3
140	13.1
160	14.8
180	16.0
200	17.4

Antenna factor in dB(1/m) is to be added to receiver meter reading in dB(μ V) to convert it into field intensity in dB(μ V/m).



Antenna factor
Double-ridged guide horn antenna
Model 3115, serial number: 00027177, HL 2432

Frequency, MHz	Antenna factor. dB(1/m)
1000.0	24.7
1500.0	25.7
2000.0	27.8
2500.0	28.9
3000.0	30.7
3500.0	31.8
4000.0	33.0
4500.0	32.8
5000.0	34.2
5500.0	34.9
6000.0	35.2
6500.0	35.4
7000.0	36.3
7500.0	37.3
8000.0	37.5
8500.0	38.0
9000.0	38.3
9500.0	38.3
10000.0	38.7
10500.0	38.7
11000.0	38.9
11500.0	39.5
12000.0	39.5
12500.0	39.4
13000.0	40.5
13500.0	40.8
14000.0	41.5
14500.0	41.3
15000.0	40.2
15500.0	38.7
16000.0	38.5
16500.0	39.8
17000.0	41.9
17500.0	45.8
18000.0	49.1

Antenna factor in dB(1/m) is to be added to receiver meter reading in dB(μ V) to convert it into field strength in dB(μ V/m).



Cable loss
Cable coax, RG-214, 12.3 m, s/n 056, HL 0415

No.	Frequency, MHz	Cable loss, dB	Measured uncertainty, dB
1	10	0.23	±0.12
2	30	0.44	±0.12
3	50	0.60	±0.12
4	100	0.89	±0.12
5	150	1.11	±0.13
6	200	1.30	±0.13
7	250	1.45	±0.13
8	300	1.61	±0.13
9	400	1.94	±0.13
10	500	2.18	±0.13
11	600	2.45	±0.14
12	700	2.67	±0.14
13	800	2.94	±0.14
14	900	3.16	±0.14
15	1000	3.38	±0.14



Cable loss
Cable coaxial, Microwave Cable Assembly, 104EA, 18 GHz, 1.0 m
Suhner Sucoflex, HL 3389

Frequency, MHz	Cable loss, dB	Frequency, MHz	Cable loss, dB	Frequency, MHz	Cable loss, dB	Frequency, MHz	Cable loss, dB
10	-0.16	4000	0.67	9000	1.03	14000	1.35
15	-0.02	4100	0.68	9100	1.03	14100	1.36
20	0.01	4200	0.70	9200	1.03	14200	1.35
30	0.04	4300	0.71	9300	1.03	14300	1.36
40	0.05	4400	0.71	9400	1.03	14400	1.34
50	0.06	4500	0.72	9500	1.02	14500	1.34
60	0.07	4600	0.73	9600	1.03	14600	1.35
70	0.08	4700	0.73	9700	1.03	14700	1.35
80	0.09	4800	0.73	9800	1.02	14800	1.32
90	0.10	4900	0.74	9900	1.00	14900	1.30
100	0.10	5000	0.73	10000	0.99	15000	1.31
150	0.13	5100	0.72	10100	0.99	15100	1.30
200	0.15	5200	0.73	10200	0.98	15200	1.30
300	0.18	5300	0.73	10300	0.98	15300	1.31
400	0.21	5400	0.75	10400	0.96	15400	1.31
500	0.23	5500	0.77	10500	0.95	15500	1.31
600	0.25	5600	0.80	10600	0.93	15600	1.31
700	0.27	5700	0.79	10700	0.91	15700	1.32
800	0.29	5800	0.79	10800	0.92	15800	1.33
900	0.30	5900	0.79	10900	0.95	15900	1.34
1000	0.32	6000	0.79	11000	0.97	16000	1.34
1100	0.33	6100	0.79	11100	0.99	16100	1.34
1200	0.35	6200	0.82	11200	0.98	16200	1.33
1300	0.37	6300	0.82	11300	0.98	16300	1.33
1400	0.38	6400	0.85	11400	0.97	16400	1.33
1500	0.40	6500	0.84	11500	0.96	16500	1.31
1600	0.40	6600	0.84	11600	0.95	16600	1.29
1700	0.41	6700	0.85	11700	0.95	16700	1.27
1800	0.42	6800	0.85	11800	0.97	16800	1.28
1900	0.44	6900	0.84	11900	0.99	16900	1.29
2000	0.48	7000	0.85	12000	0.99	17000	1.32
2100	0.49	7100	0.87	12100	1.01	17100	1.35
2200	0.50	7200	0.89	12200	1.04	17200	1.36
2300	0.51	7300	0.91	12300	1.06	17300	1.40
2400	0.52	7400	0.95	12400	1.07	17400	1.42
2500	0.53	7500	0.97	12500	1.08	17500	1.40
2600	0.54	7600	0.98	12600	1.11	17600	1.39
2700	0.55	7700	1.01	12700	1.13	17700	1.36
2800	0.57	7800	1.00	12800	1.13	17800	1.35
2900	0.58	7900	1.01	12900	1.15	17900	1.35
3000	0.59	8000	1.02	13000	1.16	18000	1.35
3100	0.59	8100	1.04	13100	1.18		
3200	0.60	8200	1.05	13200	1.21		
3300	0.61	8300	1.05	13300	1.23		
3400	0.61	8400	1.05	13400	1.26		
3500	0.62	8500	1.05	13500	1.26		
3600	0.62	8600	1.05	13600	1.30		
3700	0.62	8700	1.04	13700	1.29		
3800	0.63	8800	1.03	13800	1.31		
3900	0.65	8900	1.03	13900	1.33		



Cable loss
Cable coaxial, RG-214/U, N type-N type, 17 m
Teldor, HL 3612

Frequency, MHz	Cable loss, dB
0.1	0.05
0.5	0.07
1	0.10
3	0.22
5	0.29
10	0.39
30	0.68
50	0.90
100	1.27
150	1.58
200	1.80
250	2.12
300	2.36
350	2.60
400	2.82
450	2.99
500	3.23
550	3.40
600	3.56
650	3.71
700	3.90
750	4.04
800	4.23
850	4.39
900	4.55
950	4.65
1000	4.79



Cable loss
Microwave Cable Assembly, 18.0 GHz, 3.4 m, SMA/SMA, Huber-Suhner,
Sucoflex P103, HL 4294

Frequency, MHz	Cable loss, dB	Frequency, MHz	Cable loss, dB	Frequency, MHz	Cable loss, dB	Frequency, MHz	Cable loss, dB
10	0.11	4900	2.09	10000	2.90	15100	3.61
30	0.17	5000	2.10	10100	2.92	15200	3.67
50	0.22	5100	2.14	10200	2.95	15300	3.63
100	0.30	5200	2.16	10300	2.96	15400	3.64
200	0.42	5300	2.17	10400	2.99	15500	3.68
300	0.51	5400	2.19	10500	2.99	15600	3.71
400	0.59	5500	2.19	10600	3.03	15700	3.74
500	0.66	5600	2.22	10700	3.03	15800	3.71
600	0.72	5700	2.24	10800	3.04	15900	3.74
700	0.77	5800	2.23	10900	3.05	16000	3.71
800	0.82	5900	2.26	11000	3.09	16100	3.73
900	0.88	6000	2.27	11100	3.07	16200	3.76
1000	0.93	6100	2.26	11200	3.08	16300	3.82
1100	0.98	6200	2.29	11300	3.11	16400	3.90
1200	1.02	6300	2.30	11400	3.12	16500	3.81
1300	1.06	6400	2.34	11500	3.11	16600	3.88
1400	1.10	6500	2.34	11600	3.15	16700	3.87
1500	1.14	6600	2.36	11700	3.16	16800	3.89
1600	1.19	6700	2.36	11800	3.18	16900	3.95
1700	1.23	6800	2.39	11900	3.19	17000	4.02
1800	1.27	6900	2.39	12000	3.23	17100	4.04
1900	1.30	7000	2.44	12100	3.25	17200	3.99
2000	1.35	7100	2.46	12200	3.22	17300	4.03
2100	1.38	7200	2.44	12300	3.25	17400	4.03
2200	1.42	7300	2.48	12400	3.25	17500	4.06
2300	1.45	7400	2.47	12500	3.28	17600	4.05
2400	1.48	7500	2.48	12600	3.27	17700	4.12
2500	1.51	7600	2.50	12700	3.27	17800	4.14
2600	1.55	7700	2.53	12800	3.30	17900	4.18
2700	1.59	7800	2.56	12900	3.30	18000	4.14
2800	1.62	7900	2.55	13000	3.27		
2900	1.65	8000	2.56	13100	3.32		
3000	1.66	8100	2.56	13200	3.32		
3100	1.69	8200	2.57	13300	3.32		
3200	1.71	8300	2.59	13400	3.35		
3300	1.74	8400	2.62	13500	3.38		
3400	1.76	8500	2.67	13600	3.39		
3500	1.78	8600	2.65	13700	3.42		
3600	1.80	8700	2.68	13800	3.47		
3700	1.85	8800	2.68	13900	3.45		
3800	1.88	8900	2.68	14000	3.49		
3900	1.90	9000	2.74	14100	3.50		
4000	1.91	9100	2.74	14200	3.55		
4100	1.93	9200	2.76	14300	3.59		
4200	1.96	9300	2.78	14400	3.58		
4300	1.97	9400	2.79	14500	3.56		
4400	1.99	9500	2.80	14600	3.57		
4500	2.02	9600	2.83	14700	3.57		
4600	2.02	9700	2.84	14800	3.57		
4700	2.04	9800	2.86	14900	3.64		
4800	2.05	9900	2.92	15000	3.64		



Cable loss
Low Loss Armored Test Cable, MegaPhase, 18 GHz, 6.2 m, N type-M/N type-M,
NC29-N1N1-244S/N 12025101 003,
HL 4353

Frequency, MHz	Cable loss, dB	Frequency, MHz	Cable loss, dB
50	0.20	9000	2.71
100	0.27	9500	2.81
300	0.47	10000	2.90
500	0.61	10500	2.97
1000	0.87	11000	3.06
1500	1.07	11500	3.13
2000	1.24	12000	3.20
2500	1.39	12500	3.26
3000	1.53	13000	3.34
3500	1.65	13500	3.39
4000	1.77	14000	3.47
4500	1.89	14500	3.54
5000	1.99	15000	3.62
5500	2.07	15500	3.69
6000	2.20	16000	3.76
6500	2.30	16500	3.83
7000	2.39	17000	3.86
7500	2.51	17500	3.94
8000	2.58	18000	4.02
8500	2.65		



Cable loss
RF Cable, Huber-Suhner, 18 GHz, 6 m, N- type,
SF106A/11N/11N/6000MM, S/N 500847/6A
HL 5101

Frequency, MHz	Cable loss, dB	Frequency, MHz	Cable loss, dB
0.1	0.01	5500	2.42
50	0.22	6000	2.53
100	0.31	6500	2.65
200	0.43	7000	2.76
300	0.53	7500	2.86
400	0.62	8000	2.96
500	0.69	8500	3.06
600	0.76	9000	3.16
700	0.82	9500	3.26
800	0.87	10000	3.35
900	0.93	10500	3.44
1000	0.98	11000	3.54
1100	1.03	11500	3.62
1200	1.08	12000	3.70
1300	1.12	12500	3.80
1400	1.17	13000	3.88
1500	1.21	13500	3.97
1600	1.25	14000	4.04
1700	1.29	14500	4.13
1800	1.33	15000	4.22
1900	1.37	15500	4.31
2000	1.41	16000	4.39
2500	1.59	16500	4.47
3000	1.75	17000	4.54
3500	1.90	17500	4.61
4000	2.04	18000	4.68
4500	2.17		
5000	2.30		



14 APPENDIX F Abbreviations and acronyms

A	ampere
AC	alternating current
A/m	ampere per meter
AM	amplitude modulation
AVRG	average (detector)
cm	centimeter
dB	decibel
dBm	decibel referred to one milliwatt
dB(μ V)	decibel referred to one microvolt
dB(μ V/m)	decibel referred to one microvolt per meter
dB(μ A)	decibel referred to one microampere
DC	direct current
EIRP	equivalent isotropically radiated power
ERP	effective radiated power
EUT	equipment under test
F	frequency
GHz	gigahertz
GND	ground
H	height
HL	Hermon laboratories
Hz	hertz
k	kilo
kHz	kilohertz
LO	local oscillator
m	meter
MHz	megahertz
min	minute
mm	millimeter
ms	millisecond
μ s	microsecond
NA	not applicable
NB	narrow band
OATS	open area test site
Ω	Ohm
PM	pulse modulation
PS	power supply
ppm	part per million (10^{-6})
QP	quasi-peak
RE	radiated emission
RF	radio frequency
rms	root mean square
Rx	receive
s	second
T	temperature
Tx	transmit
V	volt
WB	wideband

END OF DOCUMENT