



Hermon Laboratories Ltd.  
Harakevet Industrial Zone, Binyamina 30500,  
Israel  
Tel. +972-4-6288001  
Fax. +972-4-6288277  
E-mail: mail@hermonlabs.com

# TEST REPORT

ACCORDING TO: FCC CFR 47 Part 15 subpart C, section 15.231

FOR:  
**Essence Security International Ltd.**  
**Control panel**  
**Model:ES6502VSF-ES-M02**  
**FCC ID:YXG-ES6502VSF**

This report is in conformity with ISO/IEC 17025. The "A2LA Accredited" symbol endorsement applies only to the tests and calibrations that are listed in the scope of Hermon Laboratories accreditation. The test results relate only to the items tested. This test report shall not be reproduced in any form except in full with the written approval of Hermon Laboratories Ltd.

## Table of contents

1	Applicant information .....	3
2	Equipment under test attributes .....	3
3	Manufacturer information .....	3
4	Test details .....	3
5	Tests summary .....	4
6	EUT description .....	5
6.1	General information .....	5
6.2	Test configuration .....	5
6.3	Changes made in EUT .....	5
6.4	Transmitter characteristics .....	6
7	Transmitter tests according to 47CFR part 15 subpart C requirements .....	7
7.1	Periodic operation requirements .....	7
7.2	Field strength of emissions .....	9
7.3	Occupied bandwidth test .....	23
7.4	Conducted emissions .....	26
7.5	Antenna requirements .....	29
8	APPENDIX A Test equipment and ancillaries used for tests .....	30
9	APPENDIX B Measurement uncertainties .....	32
10	APPENDIX C Test laboratory description .....	33
11	APPENDIX D Specification references .....	33
12	APPENDIX E Test equipment correction factors .....	34
13	APPENDIX F Abbreviations and acronyms .....	48
14	APPENDIX G Manufacturer's declaration .....	49

## 1 Applicant information

**Client name:** Essence Security International Ltd.  
**Address:** 12 Abba Eban avenue, Ackerstein Tower Bldg. D, P.O.Box 2073, Herzliya 4612001, Israel  
**Telephone:** +972 7324 47735  
**Fax:** +972 9772 9962  
**E-mail:** israelgo@essence-grp.com  
**Contact name:** Mr. Israel Gottesman

## 2 Equipment under test attributes

**Product name:** Control panel  
**Product type:** Transceiver  
**Model(s):** ES6502VSF-ES-M02  
**Serial number:** 9976791102573290  
**Hardware version:** 7  
**Software release:** 9  
**Receipt date** 18-Aug-16

## 3 Manufacturer information

**Manufacturer name:** Essence Security International Ltd.  
**Address:** 12 Abba Eban avenue, Ackerstein Tower Bldg. D, P.O.Box 2073, Herzliya 4612001, Israel  
**Telephone:** +972 7324 47735  
**Fax:** +972 9772 9962  
**E-Mail:** israelgo@essence-grp.com  
**Contact name:** Mr. Israel Gottesman

## 4 Test details





**Project ID:** 28529  
**Location:** Primary: Hermon Laboratories Ltd. Harakevet Industrial Zone, Binyamina 30500, Israel  
Satellite: Hermon Laboratories Ltd. Hefetz-Haim 10, Tel Aviv 6744124, Israel  
**Test started:** 18-Aug-16  
**Test completed:** 3-May-17  
**Test specification(s):** FCC 47CFR part 15, subpart C, §15.231

## 5 Tests summary

Test	Status
<b>Transmitter characteristics</b>	
FCC Part 15, Section 231(a), Periodic operation requirements	Pass
FCC Part 15, Section 231(a), Field strength of emissions	Pass
FCC Part 15, Section 231(c), Occupied bandwidth	Pass
FCC Part 15, Section 207, Conducted emission	Pass
FCC Part 15, Section 203, Antenna requirements	Pass

Testing was completed against all relevant requirements of the test standard. The results obtained indicate that the product under test complies in full with the requirements tested. The test results relate only to the items tested. Pass/ fail decision was based on nominal values.

This test report supersedes the previously issued test report identified by Doc ID:ESSRAD\_FCC.28529\_rev2.

	Name and Title	Date	Signature
<b>Tested by:</b>	Mr. I. Zilberstein, test engineer	May 3, 2017	
	Mr. K. Zushchyk, test engineer		
<b>Reviewed by:</b>	Mrs. M. Cherniavsky, certification engineer	May 22, 2017	
<b>Approved by:</b>	Mr. M. Nikishin, EMC and Radio group manager	June 8, 2017	

## 6 EUT description

### 6.1 General information

The EUT is a Wireless Control Panel operating at 916.5 MHz which comprises GSM Telit module approved by FCC, FCC ID:RI7HE910NA.

The EUT is powered from AC mains and is equipped with internal rechargeable battery of 3.7 V.

### 6.2 Test configuration

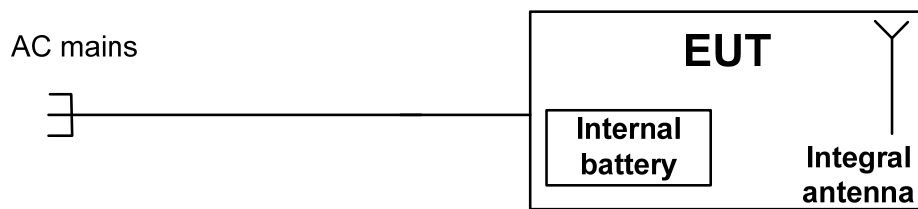

### 6.3 Changes made in EUT

No changes were implemented in the EUT during testing.



### 6.4 Transmitter characteristics

<b>Type of equipment</b>						
X	Stand-alone (Equipment with or without its own control provisions)					
	Combined equipment (Equipment where the radio part is fully integrated within another type of equipment)					
	Plug-in card (Equipment intended for a variety of host systems)					
<b>Operating frequencies</b>		916.5 MHz				
<b>Maximum rated output power</b>		At transmitter 50 Ω RF output connector		dBm		
		Field strength at 3 m distance		96.90 dB(μV/m) -peak 72.46 dB(μV/m)-average		
<b>Is transmitter output power variable?</b>		X	No			
			Yes			
			continuous variable			
			stepped variable with stepsize		dB	
	minimum RF power		dBm			
	maximum RF power		dBm			
<b>Antenna connection</b>						
unique coupling		standard connector		X	integral	
				X	with temporary RF connector without temporary RF connector	
<b>Antenna/s technical characteristics</b>						
Type	Manufacturer		Model number		Gain	
Integral	YIPSHING		11673Phor		2 dBi	
<b>Type of modulation</b>		2FSK				
<b>Transmitter aggregate data rate/s</b>		38.4 kbps				
<b>Transmitter power source</b>						
X	Battery	<b>Nominal rated voltage</b>	3.7 VDC	Battery type	Lithium	
	DC	<b>Nominal rated voltage</b>				
X	AC mains	<b>Nominal rated voltage</b>	120 VAC r	Frequency 60 Hz		
<b>Common power source for transmitter and receiver</b>				X	yes	no



<b>Test specification:</b> FCC Part 15, Section 231(a), Periodic operation requirements			
<b>Test procedure:</b> Supplier declaration			
<b>Test mode:</b> Compliance		<b>Verdict:</b> PASS	
<b>Date(s):</b> 3-May-17			
<b>Temperature:</b> 26 °C	<b>Relative Humidity:</b> 42 %	<b>Air Pressure:</b> 1010 hPa	<b>Power:</b> 120 VAC
<b>Remarks:</b>			

## 7 Transmitter tests according to 47CFR part 15 subpart C requirements

### 7.1 Periodic operation requirements

#### 7.1.1 General

The EUT was verified for compliance with periodic operation requirements listed below:

- Continuous transmissions such as voice, video and the radio control of toys are not permitted;
- A manually operated transmitter shall employ switch that will automatically deactivate the transmitter within not more than 5 seconds of being released;
- A transmitter activated automatically shall cease transmission within 5 seconds after activation;
- Periodic transmissions, excluding polling or supervision transmissions, at regular predetermined intervals are not permitted;
- Total duration of polling or supervision transmissions, including data, to determine system integrity in security or safety applications shall not exceed 2 seconds per hour;
- Transmission of set-up information for security systems may exceed the transmission duration limits of 5 seconds, provided such transmissions are under the control of a professional installer and do not exceed ten seconds after a manually operated switch is released or a transmitter is activated automatically. Such set-up information may include data.

The rationale for compliance with the above requirements was either test results or supplier declaration. The summary of results is provided in Table 7.1.1.

#### 7.1.2 Test procedure for transmitter shut down test

7.1.2.1 The EUT was set up as shown in Figure 7.1.1.

7.1.2.2 The spectrum analyzer center frequency was adjusted to the EUT carrier, span set to zero and video triggered for transmission.

7.1.2.3 The transmitter was activated either manually or automatically. Once manually operated transmitter was activated, the switch was immediately released.

7.1.2.4 The transmission time was captured and shown in Plot 7.1.1.

#### 7.1.3 Test procedure for measurements of polling / supervision transmission duration

7.1.3.1 According to manufacturer declaration provided in Appendix G of this test report the device does not transmit any polling/supervision signals.

Figure 7.1.1 Setup for transmitter shut down test





HERMON LABORATORIES

<b>Test specification:</b> FCC Part 15, Section 231(a), Periodic operation requirements			
<b>Test procedure:</b> Supplier declaration			
<b>Test mode:</b> Compliance		<b>Verdict:</b> PASS	
<b>Date(s):</b> 3-May-17			
<b>Temperature:</b> 26 °C	<b>Relative Humidity:</b> 42 %	<b>Air Pressure:</b> 1010 hPa	<b>Power:</b> 120 VAC
<b>Remarks:</b>			

Table 7.1.1 Periodic operation requirements

Requirement	Rationale	Verdict
Continuous transmissions are not permitted	Supplier declaration	Comply
A manually operated transmitter shall be deactivated within not more than 5 seconds of switch being released	NA	NA
Transmitter activated automatically shall cease transmission within 5 seconds	Plot 7.1.1	Comply
Periodic transmissions at regular predetermined intervals are not permitted	Supplier declaration	Comply
Total duration of polling or supervision transmissions shall not exceed 2 seconds per hour	NA	NA
Transmission of set-up information for security systems may exceed the transmission duration limits of 5 seconds, provided such transmissions are under the control of a professional installer and do not exceed ten seconds after a manually operated switch is released or a transmitter is activated automatically. Such set-up information may include data.	Supplier declaration	Comply

Plot 7.1.1 Transmitter shut down test result

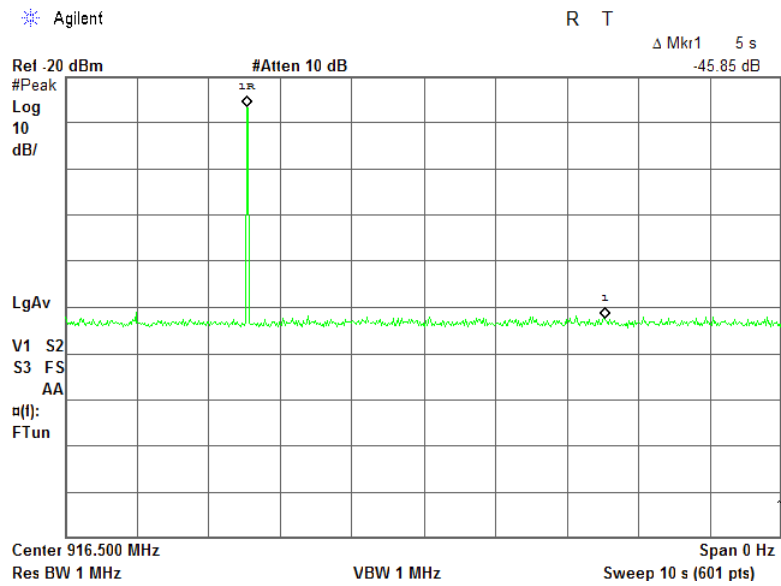

Reference numbers of test equipment used

HL 3818						
---------	--	--	--	--	--	--

Full description is given in Appendix A.





<b>Test specification: FCC Part 15, Section 231(b), Field strength of emissions</b>			
<b>Test procedure:</b> ANSI C63.10 sections 6.5, 6.6			
<b>Test mode:</b> Compliance		<b>Verdict:</b> PASS	
<b>Date(s):</b> 21-Aug-16; 3-May-17			
<b>Temperature:</b> 27 °C	<b>Relative Humidity:</b> 52 %	<b>Air Pressure:</b> 1008 hPa	<b>Power:</b> 120 VAC
<b>Remarks:</b>			

## 7.2 Field strength of emissions

### 7.2.1 General

This test was performed to measure field strength of fundamental and spurious emissions from the EUT. Specification test limits are given in Table 7.2.1 and Table 7.2.2.

Table 7.2.1 Radiated fundamental emission limits

Fundamental frequency, MHz	Field strength at 3 m, dB(μV/m)	
	Peak	Average
916.5	102.0	82.0

Table 7.2.2 Radiated spurious emissions limits

Frequency, MHz	Field strength at 3 m, dB(μV/m)				
	Within restricted bands			Outside restricted bands	
	Peak	Quasi Peak	Average	Peak	Average
0.009 – 0.090	148.5 – 128.5	NA	128.5 – 108.5**	82.0	62.0
0.090 – 0.110	NA	108.5 – 106.8**	NA		
0.110 – 0.490	126.8 – 113.8	NA	106.8 – 93.8**		
0.490 – 1.705	NA	73.8 – 63.0**	NA		
1.705 – 30.0*		69.5			
30 – 88		40.0			
88 – 216		43.5			
216 – 960		46.0			
960 - 1000		54.0			
Above 1000		74.0			

\*- The limit for 3 m test distance was calculated using the inverse square distance extrapolation factor as follows:

$$Lim_{S_2} = Lim_{S_1} + 40 \log (S_1/S_2),$$

where S<sub>1</sub> and S<sub>2</sub> – standard defined and test distance respectively in meters.

\*\* - The limit decreases linearly with the logarithm of frequency.

Note 1: The fundamental emission limit in dB(μV/m) was calculated as follows:

$$Lim_{AVR} = 20 \times \log(56.81818 \times F - 6136.3636) - \text{within } 130 - 174 \text{ MHz band};$$

$$Lim_{AVR} = 20 \times \log(41.6667 \times F - 7083.3333) - \text{within } 260 - 470 \text{ MHz band},$$

where F is the carrier frequency in MHz.

The limit for spurious emissions was 20 dB lower than fundamental emission limit.

The above limits provided in terms of average values, peak limit was 20 dB above the average limit.

Note 2: The above field strength limits applied from the lowest radio frequency generated in the device, without going below 9 kHz up to the tenth harmonic of the highest fundamental frequency.



<b>Test specification: FCC Part 15, Section 231(b), Field strength of emissions</b>			
<b>Test procedure:</b> ANSI C63.10 sections 6.5, 6.6			
<b>Test mode:</b> Compliance		<b>Verdict:</b> PASS	
<b>Date(s):</b> 21-Aug-16; 3-May-17			
<b>Temperature:</b> 27 °C	<b>Relative Humidity:</b> 52 %	<b>Air Pressure:</b> 1008 hPa	<b>Power:</b> 120 VAC
<b>Remarks:</b>			

**7.2.2 Test procedure for spurious emission field strength measurements in 9 kHz to 30 MHz band**

7.2.2.1 The EUT was set up as shown in Figure 7.2.1, energized and the performance check was conducted.

7.2.2.2 The specified frequency range was investigated with antenna connected to spectrum analyzer/ EMI receiver. To find maximum radiation the turntable was rotated 360° and the measuring antenna was rotated around its vertical axis.

7.2.2.3 The worst test results (the lowest margins) were recorded in Table 7.2.3, Table 7.2.5 and shown in the associated plots.

**7.2.3 Test procedure for spurious emission field strength measurements above 30 MHz**

7.2.3.1 The EUT was set up as shown in Figure 7.2.2, Figure 7.2.3, energized and the performance check was conducted.

7.2.3.2 The specified frequency range was investigated with antenna connected to spectrum analyzer/ EMI receiver. To find maximum radiation the turntable was rotated 360°, the measuring antenna height was changed from 1 to 4 m, its polarization was switched from vertical to horizontal.

7.2.3.3 The worst test results (the lowest margins) were recorded in Table 7.2.3, Table 7.2.5 and shown in the associated plots.

**Figure 7.2.1 Setup for spurious emission field strength measurements below 30 MHz**

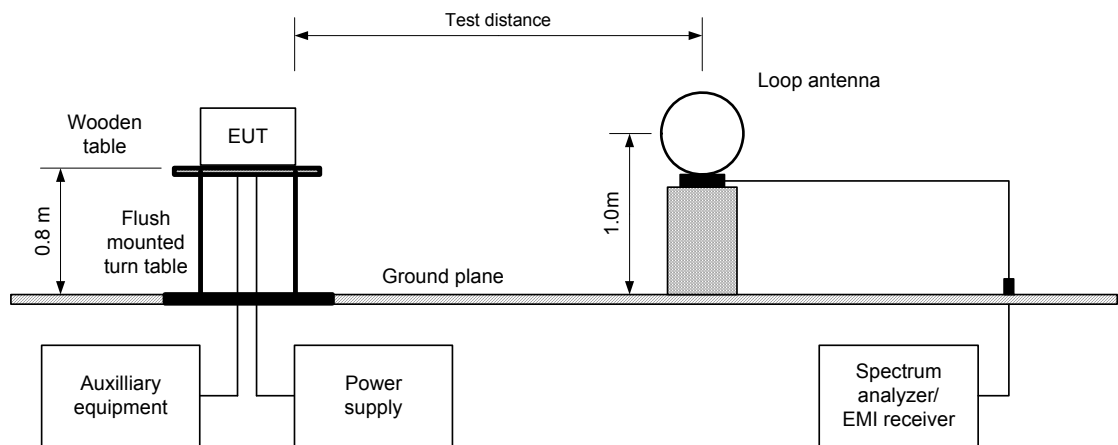



<b>Test specification: FCC Part 15, Section 231(b), Field strength of emissions</b>			
<b>Test procedure:</b> ANSI C63.10 sections 6.5, 6.6			
<b>Test mode:</b> Compliance		<b>Verdict:</b> PASS	
<b>Date(s):</b> 21-Aug-16; 3-May-17			
<b>Temperature:</b> 27 °C	<b>Relative Humidity:</b> 52 %	<b>Air Pressure:</b> 1008 hPa	<b>Power:</b> 120 VAC
<b>Remarks:</b>			

Figure 7.2.2 Setup for spurious emission field strength measurements in 30 -1000 MHz

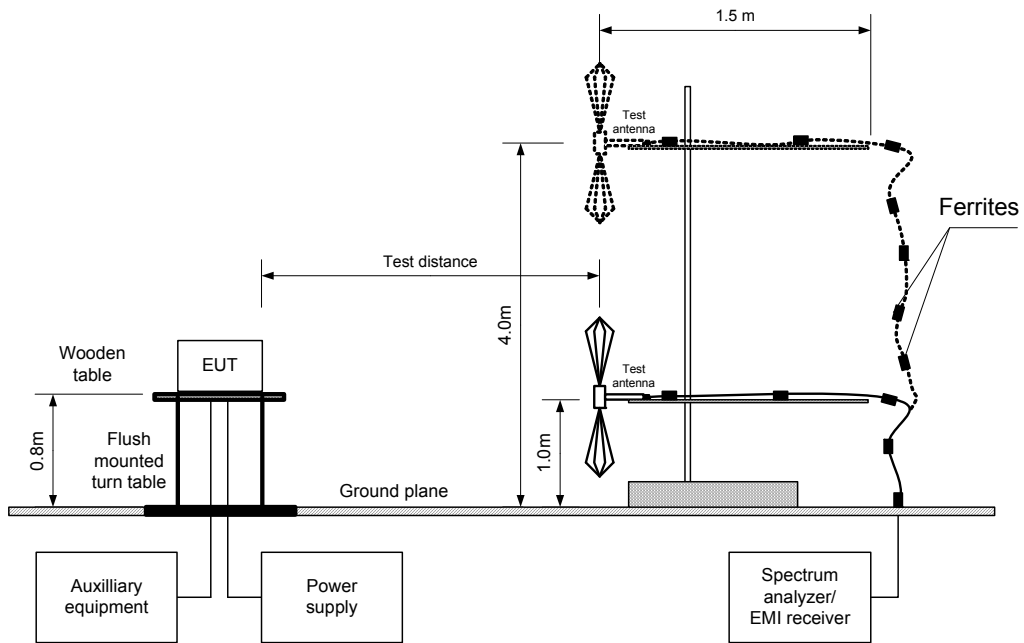
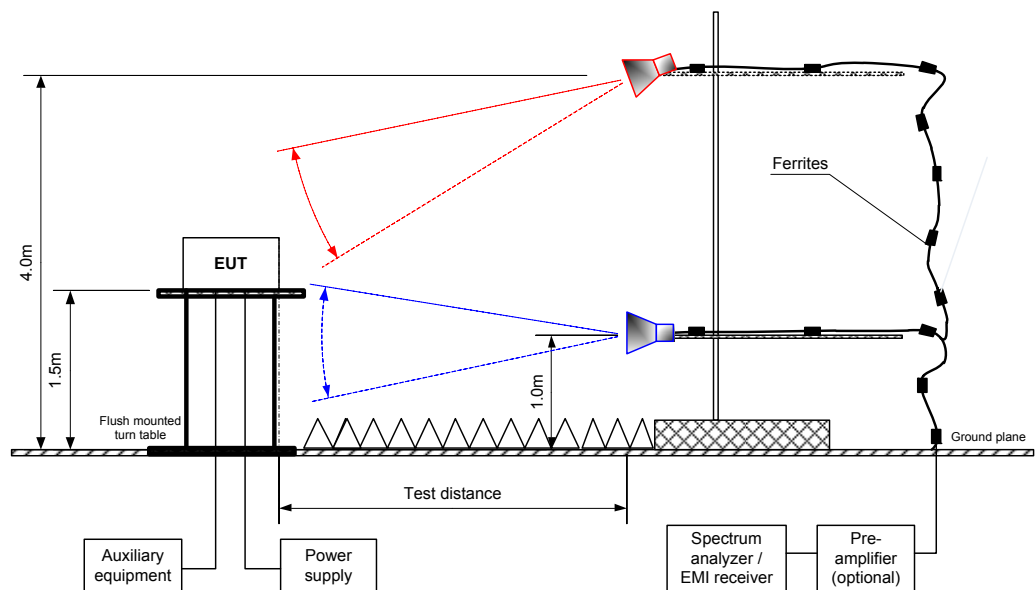

Figure 7.2.3 Setup for spurious emission field strength measurements above 1000 MHz





<b>Test specification: FCC Part 15, Section 231(b), Field strength of emissions</b>			
<b>Test procedure:</b> ANSI C63.10 sections 6.5, 6.6			
<b>Test mode:</b> Compliance		<b>Verdict: PASS</b>	
<b>Date(s):</b> 21-Aug-16; 3-May-17			
<b>Temperature:</b> 27 °C	<b>Relative Humidity:</b> 52 %	<b>Air Pressure:</b> 1008 hPa	<b>Power:</b> 120 VAC
<b>Remarks:</b>			

**Table 7.2.3 Field strength of fundamental emission, spurious emissions outside restricted bands and within restricted bands at frequencies above 1 GHz**

TEST DISTANCE: 3 m  
 EUT POSITION: Typical (Vertical)  
 MODULATION: 2FSK  
 BIT RATE: 38.4 kbps  
 INVESTIGATED FREQUENCY RANGE: 0.009 -10000 MHz  
 DETECTOR USED: Peak  
 RESOLUTION BANDWIDTH: 0.2 kHz (9 kHz – 150 kHz)  
 9.0 kHz (150 kHz – 30 MHz)  
 120 kHz (30 MHz – 1000 MHz)  
 1.0 MHz (above 1000 MHz)  
 VIDEO BANDWIDTH: ≥ Resolution bandwidth  
 TEST ANTENNA TYPE: Active loop (9 kHz – 30 MHz)  
 Biconilog (30 MHz – 1000 MHz)  
 Double ridged guide (above 1000 MHz)

F, MHz	Antenna		Azimuth, degrees*	Peak field strength			Average field strength			Verdict	
	Pol.	Height, m		Measured, dB(μV/m)	Limit, dB(μV/m)	Margin, dB**	Measured, dB(μV/m)	Calculated, dB(μV/m)	Limit, dB(μV/m)		Margin, dB**
<b>Fundamental emission***</b>											
916.499	V	1.5	50	96.90	102.0	-5.10	96.90	72.46	82.00	-9.54	Pass
<b>Spurious emissions</b>											
69.09	V	1.0	180	36.33	82.0	-45.67	36.33	NA	62.00	-25.67	Pass
153.78	H	1.2	330	47.67	82.0	-34.33	47.67	NA	62.00	-14.33	
383.97	H	1.0	0	35.28	82.0	-46.72	35.28	NA	62.00	-26.72	
942.49	V	1.3	0	43.75	82.0	-38.25	43.75	NA	62.00	-18.25	
1833.030	V	1.6	30	44.40	82.0	-37.60	44.40	19.96	62.00	-42.04	
5498.910	H	1.2	270	43.55	82.0	-38.45	43.55	19.11	62.00	-42.89	

Measured field strength, (dBμV/m) = meter reading (dBμV) + antenna correction factor (dB/m)+cable loss (dB) – pre-amp (dB), all correction factors were programmed into the spectrum analyzer.

- \*- EUT front panel refers to 0 degrees position of turntable.
- \*\*- Margin, dB =Measured (calculated) value, dB(μV/m)-Limit, dB(μV/m)
- \*\*\* Max value was obtained at Unom input power voltage.

**Table 7.2.4 Average factor calculation**

Transmission pulse		Transmission burst		Transmission train duration, ms	Average factor, dB
Duration, ms	Number of pulses in 100 ms	Duration, ms	Period, ms		
6	1	N/A	N/A	N/A	-24.44

\*- Average factor was calculated as follows  
 for pulse train shorter than 100 ms:  $Average\ factor = 20 \times \log_{10} \left( \frac{Pulse\ duration}{Pulse\ period} \times \frac{Burst\ duration}{Train\ duration} \times Number\ of\ bursts\ within\ pulse\ train \right)$   
 for pulse train longer than 100 ms:  $Average\ factor = 20 \times \log_{10} \left( \frac{Pulse\ duration}{Pulse\ period} \times \frac{Burst\ duration}{100\ ms} \times Number\ of\ bursts\ within\ 100\ ms \right)$

**Reference numbers of test equipment used**

HL 0415	HL 0566	HL 0583	HL 1915	HL 2432	HL 2780	HL 4294	HL 4295
HL 4535	HL 4541	HL 4542	HL 4543	HL 4549	HL 4551	HL 4575	HL 4603
HL 4604							

Full description is given in Appendix A.



<b>Test specification: FCC Part 15, Section 231(b), Field strength of emissions</b>			
<b>Test procedure:</b> ANSI C63.10 sections 6.5, 6.6			
<b>Test mode:</b> Compliance		<b>Verdict: PASS</b>	
<b>Date(s):</b> 21-Aug-16; 3-May-17			
<b>Temperature:</b> 27 °C	<b>Relative Humidity:</b> 52 %	<b>Air Pressure:</b> 1008 hPa	<b>Power:</b> 120 VAC
<b>Remarks:</b>			

Table 7.2.5 Field strength of emissions below 1 GHz within restricted bands

TEST DISTANCE:	3 m
EUT POSITION:	Typical (Vertical)
MODULATION:	2FSK
BIT RATE:	38.4 kbps
INVESTIGATED FREQUENCY RANGE:	0.009 -1000 MHz
DETECTOR USED:	Peak
RESOLUTION BANDWIDTH:	0.2 kHz (9 kHz – 150 kHz) 9.0 kHz (150 kHz – 30 MHz) 120 kHz (30 MHz – 1000 MHz) 1.0 MHz (above 1000 MHz)
VIDEO BANDWIDTH:	≥ Resolution bandwidth
TEST ANTENNA TYPE:	Active loop (9 kHz – 30 MHz) Biconilog (30 MHz – 1000 MHz)

Frequency, MHz	Peak emission, dB(μV/m)	Quasi-peak			Antenna polarization	Antenna height, m	Turn-table position**, degrees	Verdict
		Measured emission, dB(μV/m)	Limit, dB(μV/m)	Margin, dB*				
249.58	41.63	NA	46	-4.37	Horizontal	1.0	330	Pass

**Note:** peak value was found below quasi-peak limit.

\*- Margin = Measured emission - specification limit.

\*\* - EUT front panel refer to 0 degrees position of turntable.

#### Reference numbers of test equipment used

HL 0415	HL 0566	HL 0583	HL 1915	HL 2780	HL 4294	HL 4295	HL 4535
HL 4541	HL 4542	HL 4543	HL 4549	HL 4551	HL 4575	HL 4604	

Full description is given in Appendix A.



<b>Test specification:</b> FCC Part 15, Section 231(b), Field strength of emissions			
<b>Test procedure:</b> ANSI C63.10 sections 6.5, 6.6			
<b>Test mode:</b> Compliance		<b>Verdict:</b> PASS	
<b>Date(s):</b> 21-Aug-16; 3-May-17			
<b>Temperature:</b> 27 °C	<b>Relative Humidity:</b> 52 %	<b>Air Pressure:</b> 1008 hPa	<b>Power:</b> 120 VAC
<b>Remarks:</b>			

Table 7.2.6 Restricted bands according to FCC 15, Section 205

MHz	MHz	MHz	MHz	MHz	GHz
0.09 - 0.11	8.37625 - 8.38675	73 - 74.6	399.9 - 410	2690 - 2900	10.6 - 12.7
0.495 - 0.505	8.41425 - 8.41475	74.8 - 75.2	608 - 614	3260 - 3267	13.25 - 13.4
2.1735 - 2.1905	12.290 - 12.293	108 - 121.94	960 - 1240	3332 - 3339	14.47 - 14.5
4.125 - 4.128	12.51975 - 12.52025	123 - 138	1300 - 1427	3345.8 - 3358	15.35 - 16.2
4.17725 - 4.17775	12.57675 - 12.57725	149.9 - 150.05	1435 - 1626.5	3600 - 4400	17.7 - 21.4
4.20725 - 4.20775	13.36 - 13.41	156.52475 - 156.52525	1645.5 - 1646.5	4500 - 5150	22.01 - 23.12
6.215 - 6.218	16.420 - 16.423	156.7 - 156.9	1660 - 1710	5350 - 5460	23.6 - 24
6.26775 - 6.26825	16.69475 - 16.69525	162.0125 - 167.17	1718.8 - 1722.2	7250 - 7750	31.2 - 31.8
6.31175 - 6.31225	16.80425 - 16.80475	167.72 - 173.2	2200 - 2300	8025 - 8500	36.43 - 36.5
8.291 - 8.294	25.5 - 25.67	240 - 285	2310 - 2390	9000 - 9200	Above 38.6
8.362 - 8.366	37.5 - 38.25	322 - 335.4	2483.5 - 2500	9300 - 9500	

Table 7.2.7 Restricted bands according to RSS-Gen, Table 3

MHz	MHz	MHz	MHz	MHz	GHz
0.09 - 0.11	8.291 - 8.294	16.80425 - 16.80475	399.9 - 410	3260 - 3267	10.6 - 12.7
2.1735 - 2.190	8.362 - 8.366	25.5 - 25.67	608 - 614	3332 - 3339	13.25 - 13.4
3.020 - 3.026	8.37625 - 8.38675	37.5 - 38.25	960 - 1427	3345.8 - 3358	14.47 - 14.5
4.125 - 4.128	8.41425 - 8.41475	73 - 74.6	1435 - 1626.5	3500 - 4400	15.35 - 16.2
4.17725 - 4.17775	12.290 - 12.293	74.8 - 75.2	1645.5 - 1646.5	4500 - 5150	17.7 - 21.4
4.20725 - 4.20775	12.51975 - 12.52025	108 - 138	1660 - 1710	5350 - 5460	22.01 - 23.12
5.677 - 5.683	12.57675 - 12.57725	156.52475 - 156.52525	1718.8 - 1722.2	7250 - 7750	23.6 - 24.0
6.215 - 6.218	13.36 - 13.41	156.7 - 156.9	2200 - 2300	8025 - 8500	31.2 - 31.8
6.26775 - 6.26825	16.42 - 16.423	240 - 285	2310 - 2390	9000 - 9200	36.43 - 36.5
6.31175 - 6.31225	16.69475 - 16.69525	322 - 335.4	2655 - 2900	9300 - 9500	Above 38.6



HERMON LABORATORIES

<b>Test specification: FCC Part 15, Section 231(b), Field strength of emissions</b>			
<b>Test procedure:</b> ANSI C63.10 sections 6.5, 6.6			
<b>Test mode:</b> Compliance		<b>Verdict: PASS</b>	
<b>Date(s):</b> 21-Aug-16; 3-May-17			
<b>Temperature:</b> 27 °C	<b>Relative Humidity:</b> 52 %	<b>Air Pressure:</b> 1008 hPa	<b>Power:</b> 120 VAC
<b>Remarks:</b>			

**Plot 7.2.1 Radiated emission measurements at the fundamental frequency**

TEST SITE: OATS  
 TEST DISTANCE: 3 m  
 ANTENNA POLARIZATION: Vertical  
 EUT POSITION: Typical (Vertical)  
 INPUT VOLTAGE: Unom

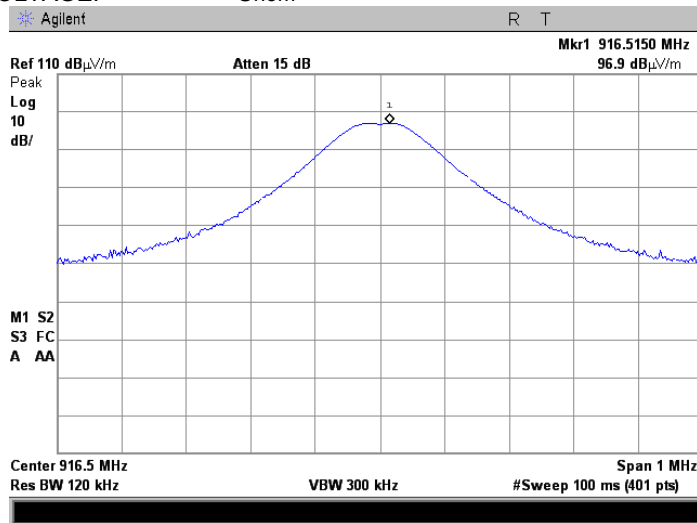

**Plot 7.2.2 Radiated emission measurements at the fundamental frequency**

TEST SITE: OATS  
 TEST DISTANCE: 3 m  
 ANTENNA POLARIZATION: Horizontal  
 EUT POSITION: Typical (Vertical)  
 INPUT VOLTAGE: Unom

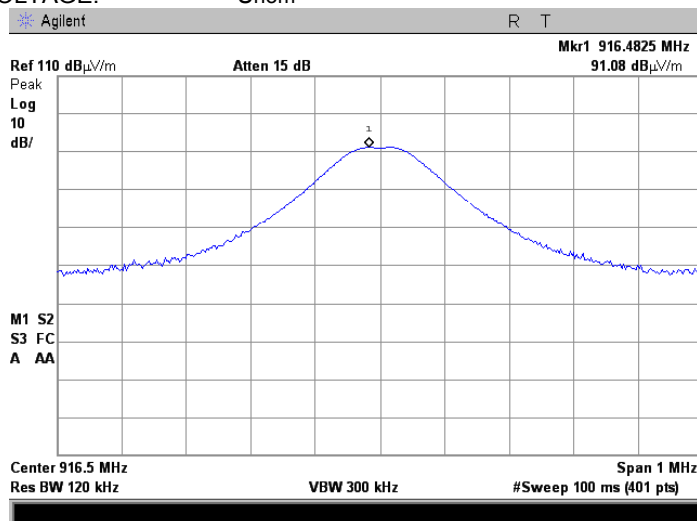



<b>Test specification: FCC Part 15, Section 231(b), Field strength of emissions</b>			
<b>Test procedure:</b> ANSI C63.10 sections 6.5, 6.6			
<b>Test mode:</b> Compliance		<b>Verdict:</b> PASS	
<b>Date(s):</b> 21-Aug-16; 3-May-17			
<b>Temperature:</b> 27 °C	<b>Relative Humidity:</b> 52 %	<b>Air Pressure:</b> 1008 hPa	<b>Power:</b> 120 VAC
<b>Remarks:</b>			

**Plot 7.2.3 Radiated emission measurements at the fundamental frequency**

TEST SITE: OATS  
TEST DISTANCE: 3 m  
ANTENNA POLARIZATION: Vertical  
EUT POSITION: Typical (Vertical)  
INPUT VOLTAGE: 115% Unom

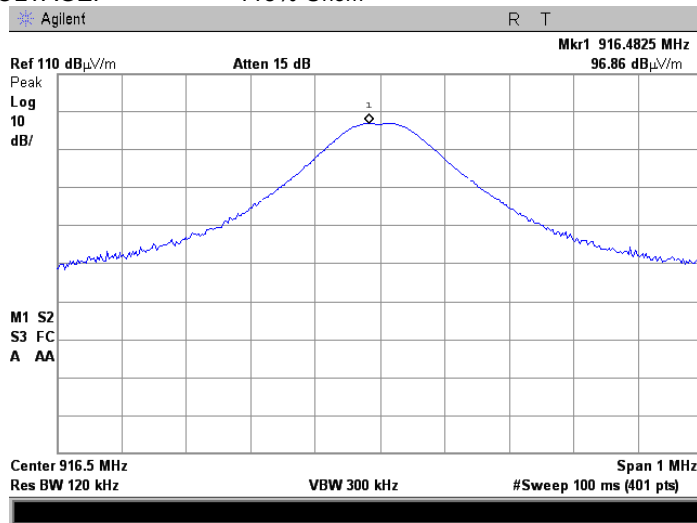

**Plot 7.2.4 Radiated emission measurements at the fundamental frequency**

TEST SITE: OATS  
TEST DISTANCE: 3 m  
ANTENNA POLARIZATION: Horizontal  
EUT POSITION: Typical (Vertical)  
INPUT VOLTAGE: 115% Unom

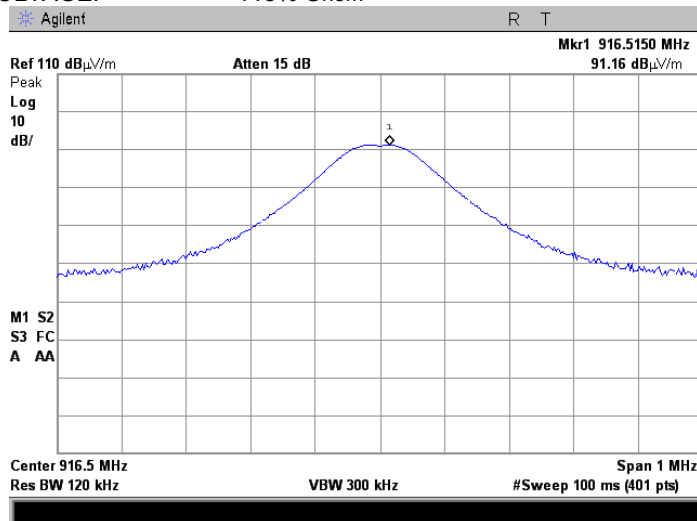





<b>Test specification: FCC Part 15, Section 231(b), Field strength of emissions</b>			
<b>Test procedure:</b> ANSI C63.10 sections 6.5, 6.6			
<b>Test mode:</b> Compliance		<b>Verdict:</b> PASS	
<b>Date(s):</b> 21-Aug-16; 3-May-17			
<b>Temperature:</b> 27 °C	<b>Relative Humidity:</b> 52 %	<b>Air Pressure:</b> 1008 hPa	<b>Power:</b> 120 VAC
<b>Remarks:</b>			

**Plot 7.2.5 Radiated emission measurements at the fundamental frequency**

TEST SITE: OATS  
TEST DISTANCE: 3 m  
ANTENNA POLARIZATION: Vertical  
EUT POSITION: Typical (Vertical)  
INPUT VOLTAGE: 85% Unom

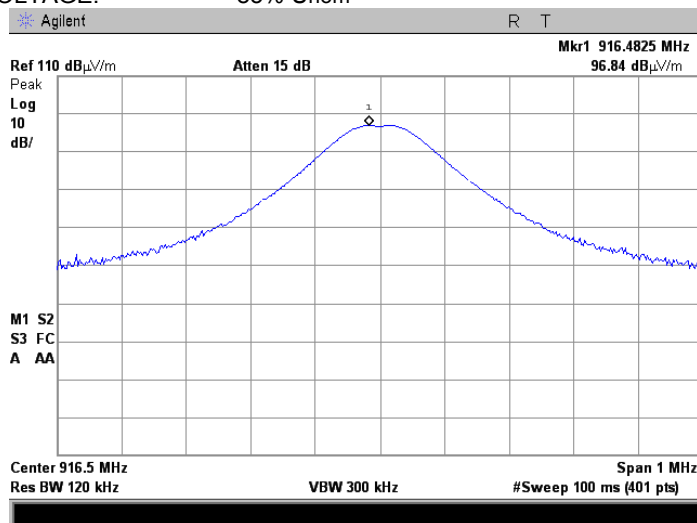

**Plot 7.2.6 Radiated emission measurements at the fundamental frequency**

TEST SITE: OATS  
TEST DISTANCE: 3 m  
ANTENNA POLARIZATION: Horizontal  
EUT POSITION: Typical (Vertical)  
INPUT VOLTAGE: 85% Unom

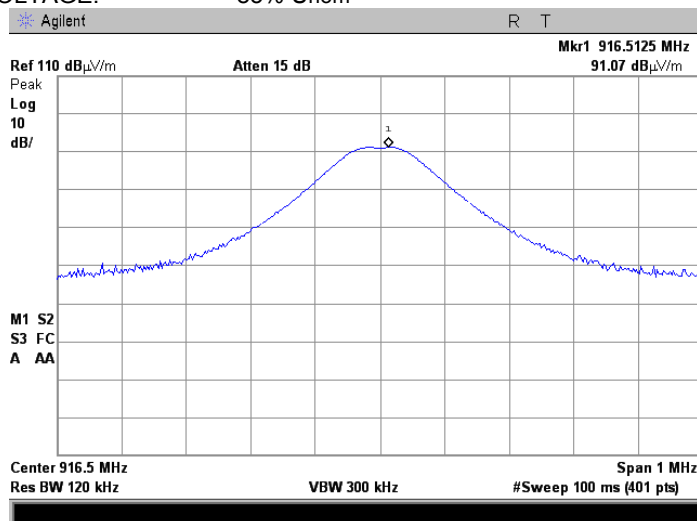



HERMON LABORATORIES

<b>Test specification: FCC Part 15, Section 231(b), Field strength of emissions</b>			
<b>Test procedure: ANSI C63.10 sections 6.5, 6.6</b>			
<b>Test mode: Compliance</b>		<b>Verdict: PASS</b>	
<b>Date(s): 21-Aug-16; 3-May-17</b>			
<b>Temperature: 27 °C</b>	<b>Relative Humidity: 52 %</b>	<b>Air Pressure: 1008 hPa</b>	<b>Power: 120 VAC</b>
<b>Remarks:</b>			

Plot 7.2.7 Radiated emission measurements from 9 to 150 kHz

TEST SITE: Semi anechoic chamber  
TEST DISTANCE: 3 m  
ANTENNA POLARIZATION: Vertical  
EUT POSITION: Typical (Vertical)

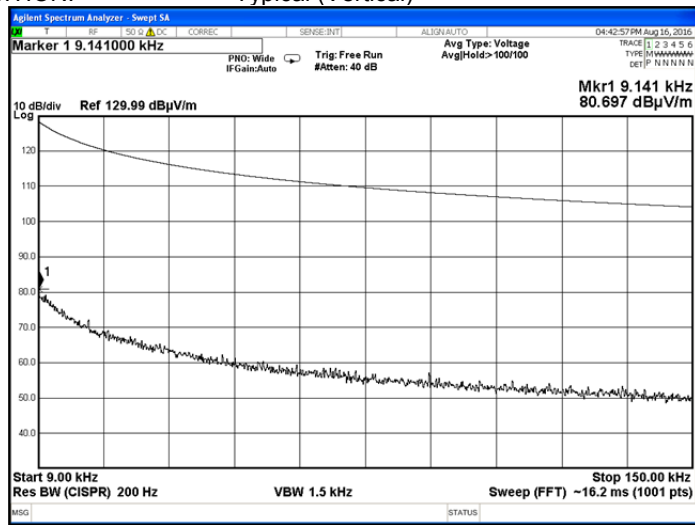

Plot 7.2.8 Radiated emission measurements from 0.15 to 30 MHz

TEST SITE: Anechoic chamber  
TEST DISTANCE: 3 m  
ANTENNA POLARIZATION: Vertical  
EUT POSITION: Typical (Vertical)

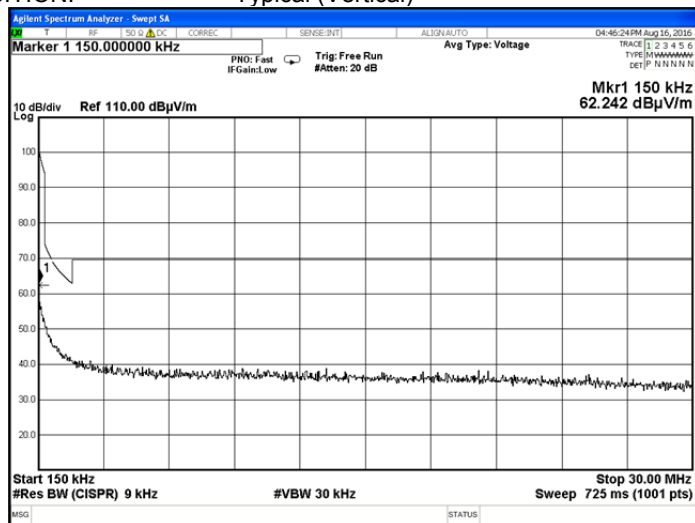



HERMON LABORATORIES

<b>Test specification:</b> FCC Part 15, Section 231(b), Field strength of emissions			
<b>Test procedure:</b> ANSI C63.10 sections 6.5, 6.6			
<b>Test mode:</b> Compliance		<b>Verdict:</b> PASS	
<b>Date(s):</b> 21-Aug-16; 3-May-17			
<b>Temperature:</b> 27 °C	<b>Relative Humidity:</b> 52 %	<b>Air Pressure:</b> 1008 hPa	<b>Power:</b> 120 VAC
<b>Remarks:</b>			

Plot 7.2.9 Radiated emission measurements from 30 to 1000 MHz

TEST SITE: Semi anechoic chamber  
TEST DISTANCE: 3 m  
ANTENNA POLARIZATION: Vertical and Horizontal  
EUT POSITION: Typical (Vertical)

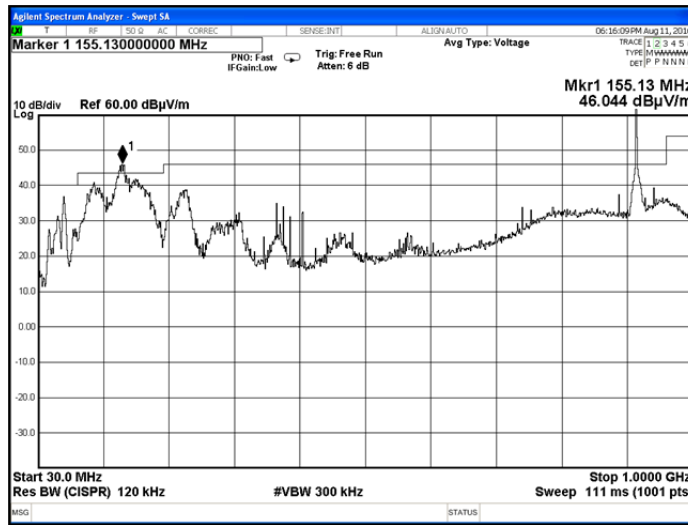

Plot 7.2.10 Radiated emission measurements from 1000 to 10000 MHz

TEST SITE: Semi anechoic chamber  
TEST DISTANCE: 3 m  
ANTENNA POLARIZATION: Vertical and Horizontal  
EUT POSITION: Typical (Vertical)

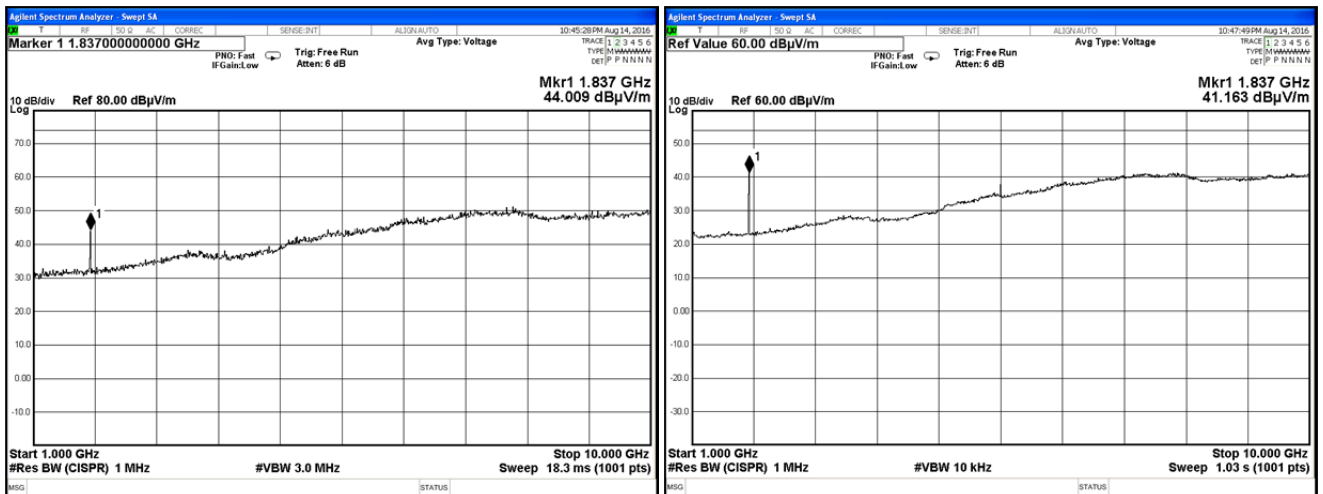



HERMON LABORATORIES

<b>Test specification:</b> FCC Part 15, Section 231(b), Field strength of emissions			
<b>Test procedure:</b> ANSI C63.10 sections 6.5, 6.6			
<b>Test mode:</b> Compliance		<b>Verdict:</b> PASS	
<b>Date(s):</b> 21-Aug-16; 3-May-17			
<b>Temperature:</b> 27 °C	<b>Relative Humidity:</b> 52 %	<b>Air Pressure:</b> 1008 hPa	<b>Power:</b> 120 VAC
<b>Remarks:</b>			

**Plot 7.2.11 Radiated emission measurements at the second harmonic frequency**

TEST SITE: Semi anechoic chamber  
TEST DISTANCE: 3 m  
ANTENNA POLARIZATION: Vertical  
EUT POSITION: Typical (Vertical)

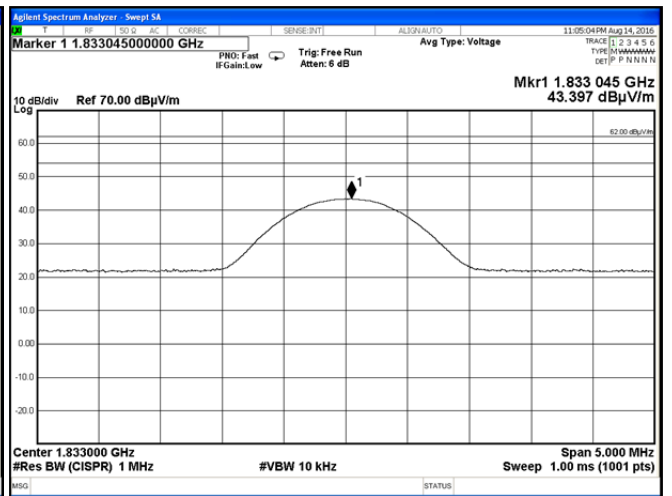
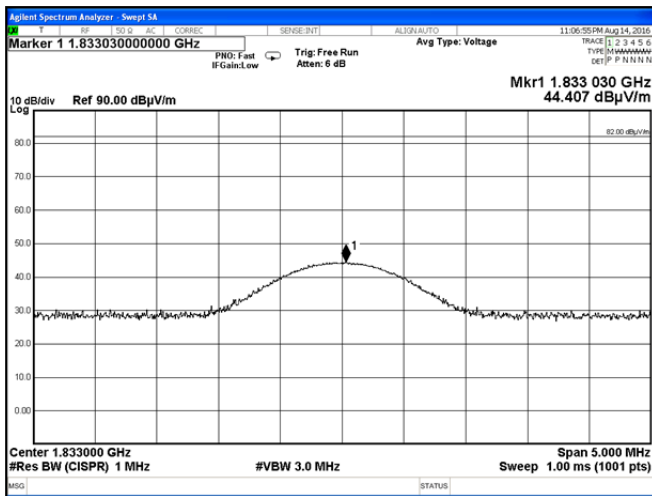

**Plot 7.2.12 Radiated emission measurements at the second harmonic frequency**

TEST SITE: Semi anechoic chamber  
TEST DISTANCE: 3 m  
ANTENNA POLARIZATION: Horizontal  
EUT POSITION: Typical (Vertical)

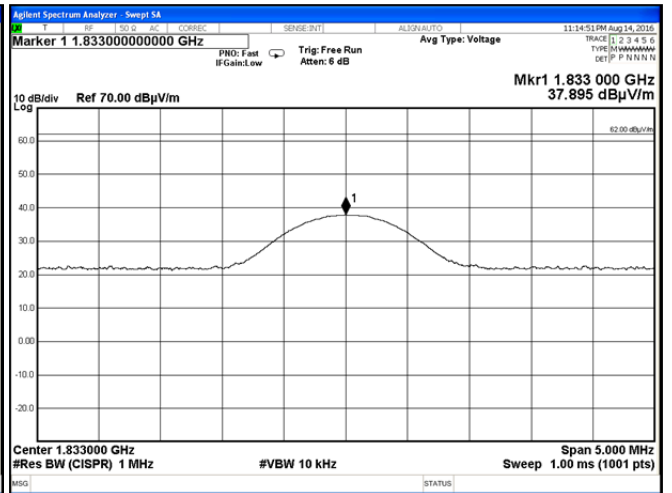
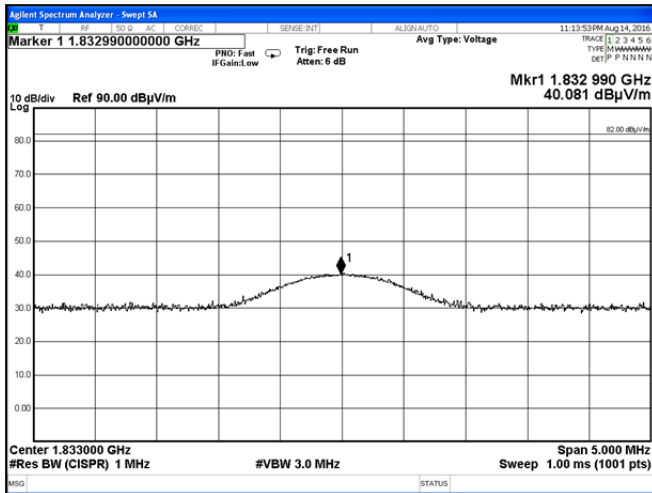



HERMON LABORATORIES

<b>Test specification:</b> FCC Part 15, Section 231(b), Field strength of emissions			
<b>Test procedure:</b> ANSI C63.10 sections 6.5, 6.6			
<b>Test mode:</b> Compliance		<b>Verdict:</b> PASS	
<b>Date(s):</b> 21-Aug-16; 3-May-17			
<b>Temperature:</b> 27 °C	<b>Relative Humidity:</b> 52 %	<b>Air Pressure:</b> 1008 hPa	<b>Power:</b> 120 VAC
<b>Remarks:</b>			

Plot 7.2.13 Radiated emission measurements at the sixth harmonic frequency

TEST SITE: Semi anechoic chamber  
TEST DISTANCE: 3 m  
ANTENNA POLARIZATION: Vertical  
EUT POSITION: Typical (Vertical) /

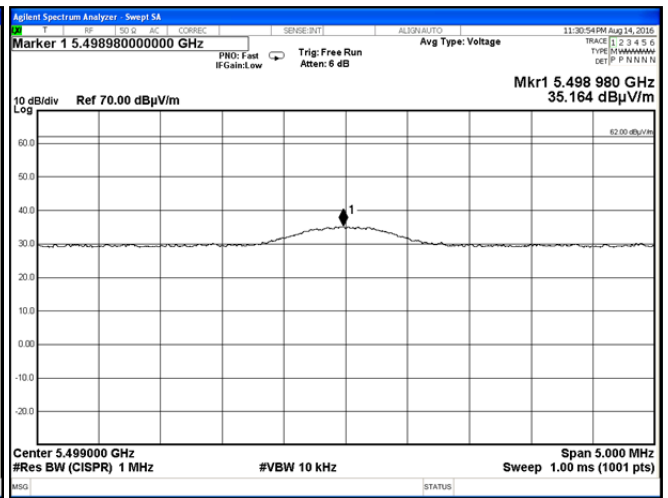
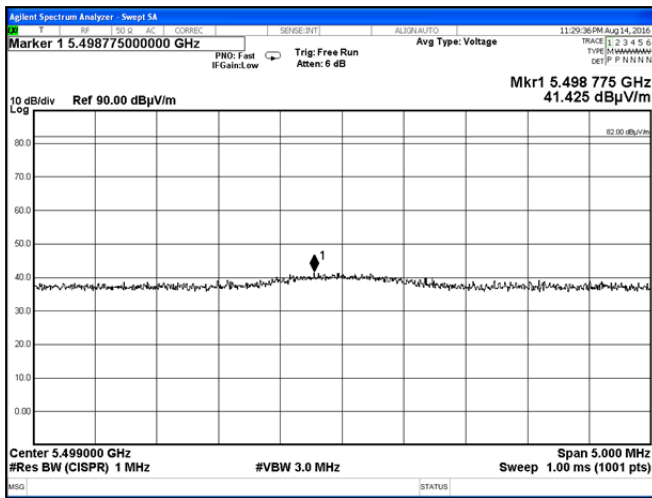

Plot 7.2.14 Radiated emission measurements at the sixth harmonic frequency

TEST SITE: Semi anechoic chamber  
TEST DISTANCE: 3 m  
ANTENNA POLARIZATION: Horizontal  
EUT POSITION: Typical (Vertical)

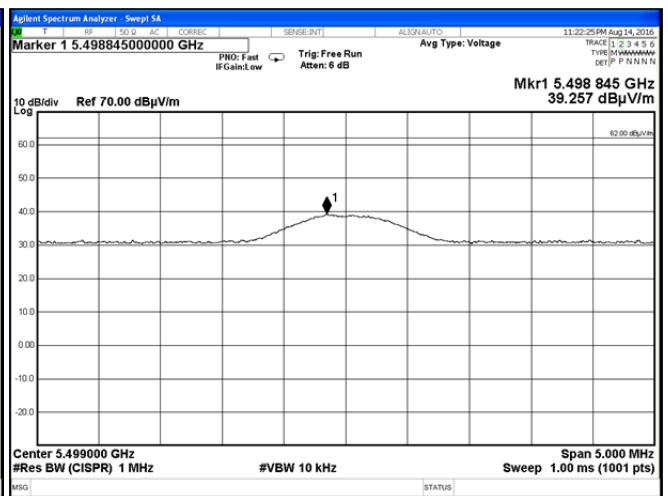
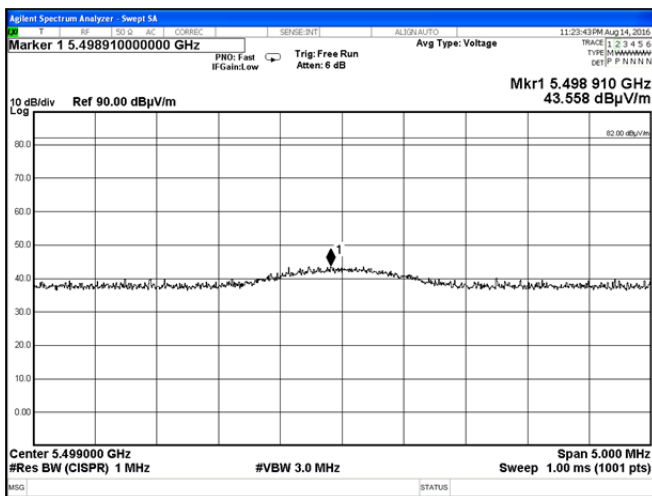



HERMON LABORATORIES

<b>Test specification: FCC Part 15, Section 231(b), Field strength of emissions</b>			
<b>Test procedure:</b> ANSI C63.10 sections 6.5, 6.6			
<b>Test mode:</b> Compliance		<b>Verdict:</b> PASS	
<b>Date(s):</b> 21-Aug-16; 3-May-17			
<b>Temperature:</b> 27 °C	<b>Relative Humidity:</b> 52 %	<b>Air Pressure:</b> 1008 hPa	<b>Power:</b> 120 VAC
<b>Remarks:</b>			

Plot 7.2.15 Transmission pulse duration

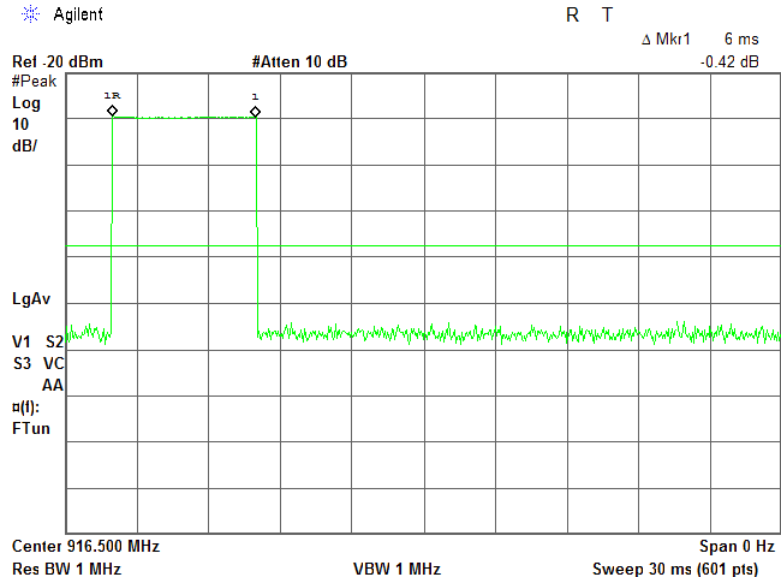

Plot 7.2.16 Transmission pulse period

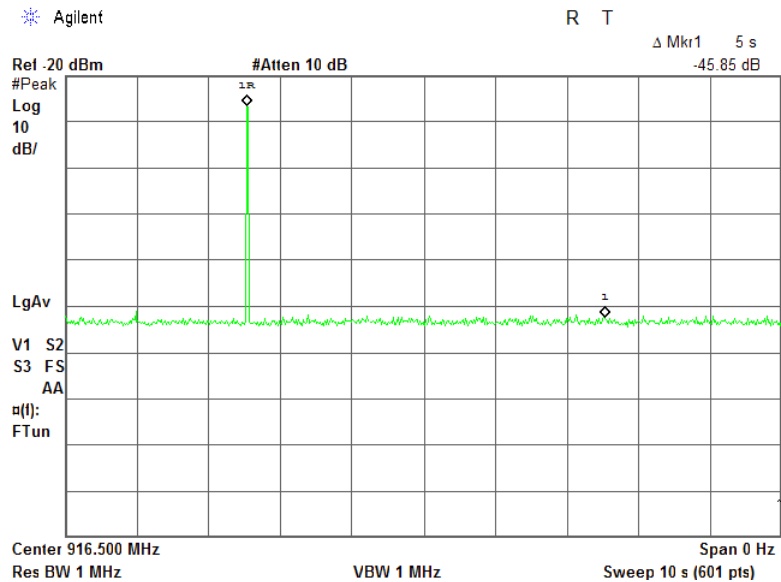



<b>Test specification: FCC Part 15, Section 231(c), Occupied bandwidth</b>			
<b>Test procedure:</b> ANSI C63.10 section 6.9.2			
<b>Test mode:</b> Compliance		<b>Verdict:</b> PASS	
<b>Date(s):</b> 18-Aug-16			
<b>Temperature:</b> 25.9 °C	<b>Relative Humidity:</b> 52 %	<b>Air Pressure:</b> 1005 hPa	<b>Power:</b> 120 VAC
<b>Remarks:</b>			

### 7.3 Occupied bandwidth test

#### 7.3.1 General

This test was performed to measure transmitter occupied bandwidth. Specification test limits are given in Table 7.3.1.

Table 7.3.1 Occupied bandwidth limits

Assigned frequency, MHz	Modulation envelope reference points*, dBc	Maximum allowed bandwidth, % of the carrier frequency
70 - 900	20.0	0.25
Above 900		0.50

\*- Modulation envelope reference points provided in terms of attenuation below modulated carrier.

#### 7.3.2 Test procedure

7.3.2.1 The EUT was set up as shown in Figure 7.3.1, energized and its proper operation was checked.

7.3.2.2 The EUT was set to transmit modulated carrier.

7.3.2.3 The transmitter occupied bandwidth was measured with spectrum analyzer as frequency delta between reference points on modulation envelope and provided in Table 7.3.2 and associated plot.

Figure 7.3.1 Occupied bandwidth test setup





<b>Test specification:</b> FCC Part 15, Section 231(c), Occupied bandwidth			
<b>Test procedure:</b> ANSI C63.10 section 6.9.2			
<b>Test mode:</b> Compliance		<b>Verdict:</b> PASS	
<b>Date(s):</b> 18-Aug-16			
<b>Temperature:</b> 25.9 °C	<b>Relative Humidity:</b> 52 %	<b>Air Pressure:</b> 1005 hPa	<b>Power:</b> 120 VAC
<b>Remarks:</b>			

Table 7.3.2 Occupied bandwidth test results

DETECTOR USED: Peak hold  
RESOLUTION BANDWIDTH: 1 kHz  
VIDEO BANDWIDTH: 3 kHz  
MODULATION ENVELOPE REFERENCE POINTS: 20 dBc  
MODULATION: FSK  
BIT RATE: 38.4kbps  
DETECTOR USED: Peak hold

Carrier frequency, MHz	Occupied bandwidth, kHz	Limit		Margin, kHz	Verdict
		% of the carrier frequency	kHz		
916.5	80.36	0.5	4582.5	-4502.14	Pass

Reference numbers of test equipment used

HL 4136	HL 4274	HL 4575						
---------	---------	---------	--	--	--	--	--	--

Full description is given in Appendix A.





HERMON LABORATORIES

<b>Test specification:</b> FCC Part 15, Section 231(c), Occupied bandwidth			
<b>Test procedure:</b> ANSI C63.10 section 6.9.2			
<b>Test mode:</b> Compliance		<b>Verdict:</b> PASS	
<b>Date(s):</b> 18-Aug-16			
<b>Temperature:</b> 25.9 °C	<b>Relative Humidity:</b> 52 %	<b>Air Pressure:</b> 1005 hPa	<b>Power:</b> 120 VAC
<b>Remarks:</b>			

Plot 7.3.1 Occupied bandwidth test result

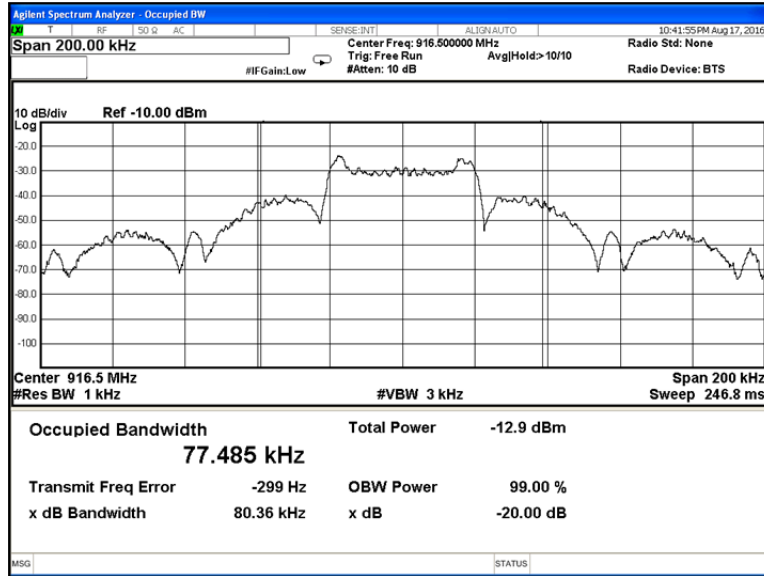



<b>Test specification: FCC Part 15, Section 207, Conducted emission</b>			
<b>Test procedure:</b> ANSI C63.10 section 6.2			
<b>Test mode:</b> Compliance		<b>Verdict:</b> PASS	
<b>Date(s):</b> 22-Aug-16			
<b>Temperature:</b> 26 °C	<b>Relative Humidity:</b> 40 %	<b>Air Pressure:</b> 1008 hPa	<b>Power:</b> 120 VAC
<b>Remarks:</b>			

## 7.4 Conducted emissions

### 7.4.1 General

This test was performed to measure common mode conducted emissions at the power port. Specification test limits are given in Table 7.4.1.

Table 7.4.1 Limits for conducted emissions

Frequency, MHz	Class B limit, dB(μV)	
	QP	AVRG
0.15 - 0.5	66 - 56*	56 - 46*
0.5 - 5.0	56	46
5.0 - 30	60	50

\* - The limit decreases linearly with the logarithm of frequency.

### 7.4.2 Test procedure

7.4.2.1 The EUT was set up as shown in Figure 7.4.1 and associated photographs, energized and the performance check was conducted.

7.4.2.2 The measurements were performed at power terminals with the LISN, connected to a spectrum analyzer while unused coaxial connector of the LISN was terminated with 50 Ohm.

7.4.2.3 The position of the device cables was varied to determine maximum emission level.

7.4.2.4 The worst test results (the lowest margins) were recorded in Table 7.4.2 and shown in the associated plots.

Figure 7.4.1 Setup for conducted emission measurements, table-top equipment

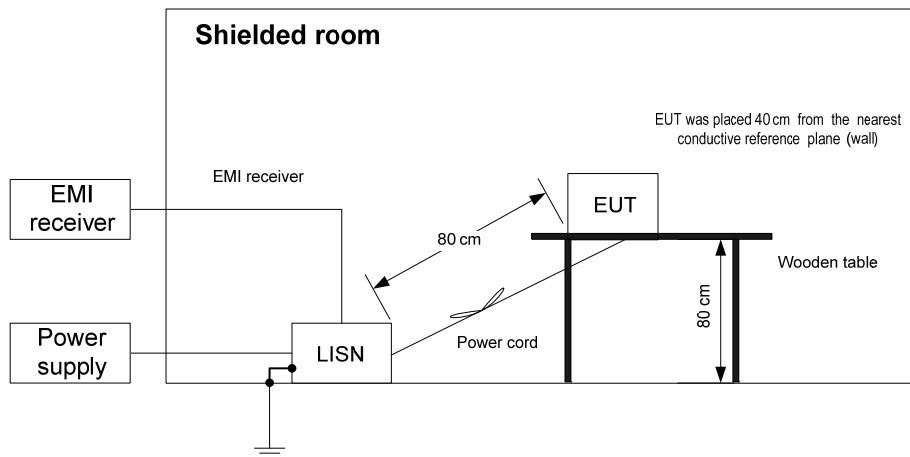



<b>Test specification:</b> FCC Part 15, Section 207, Conducted emission			
<b>Test procedure:</b> ANSI C63.10 section 6.2			
<b>Test mode:</b> Compliance		<b>Verdict:</b> PASS	
<b>Date(s):</b> 22-Aug-16			
<b>Temperature:</b> 26 °C	<b>Relative Humidity:</b> 40 %	<b>Air Pressure:</b> 1008 hPa	<b>Power:</b> 120 VAC
<b>Remarks:</b>			

Table 7.4.2 Conducted emission test results

LINE: AC mains  
 EUT OPERATING MODE: Transmit  
 EUT SET UP: TABLE-TOP  
 TEST SITE: SHIELDED ROOM  
 FREQUENCY RANGE: 150 kHz - 30 MHz  
 RESOLUTION BANDWIDTH: 9 kHz

Frequency, MHz	Peak emission, dB(µV)	Quasi-peak			Average			Line ID	Verdict
		Measured emission, dB(µV)	Limit, dB(µV)	Margin, dB*	Measured emission, dB(µV)	Limit, dB(µV)	Margin, dB*		
0.164	47.28	43.24	65.32	-22.08	29.74	55.32	-25.58	L1	Pass
0.245	45.59	42.96	61.94	-18.98	36.08	51.94	-15.86		
0.655	52.37	49.96	56.00	-6.04	45.07	46.00	-0.93		
0.934	45.68	37.84	56.00	-18.16	22.65	46.00	-23.35		
1.867	39.53	33.58	56.00	-22.42	24.15	46.00	-21.85		
2.708	45.36	40.08	56.00	-15.92	25.87	46.00	-20.13		
0.165	49.18	45.14	65.29	-20.15	29.48	55.29	-25.81	L2	Pass
0.205	47.99	44.76	63.45	-18.69	32.61	53.45	-20.84		
0.654	48.82	46.29	56.00	-9.71	41.47	46.00	-4.53		
0.901	47.34	38.62	56.00	-17.38	24.92	46.00	-21.08		
2.704	46.06	41.16	56.00	-14.84	26.26	46.00	-19.74		
3.033	44.29	38.90	56.00	-17.10	25.18	46.00	-20.82		

\*- Margin = Measured emission - specification limit.

Reference numbers of test equipment used

HL 0447	HL 0787	HL 1513	HL 3612	HL 4756	HL 4778		
---------	---------	---------	---------	---------	---------	--	--

Full description is given in Appendix A.



HERMON LABORATORIES

<b>Test specification: FCC Part 15, Section 207, Conducted emission</b>			
<b>Test procedure:</b> ANSI C63.10 section 6.2			
<b>Test mode:</b> Compliance		<b>Verdict:</b> PASS	
<b>Date(s):</b> 22-Aug-16			
<b>Temperature:</b> 26 °C	<b>Relative Humidity:</b> 40 %	<b>Air Pressure:</b> 1008 hPa	<b>Power:</b> 120 VAC
<b>Remarks:</b>			

**Plot 7.4.1 Conducted emission measurements**

LINE: L1  
EUT OPERATING MODE: Transmit  
LIMIT: QUASI-PEAK, AVERAGE  
DETECTOR: PEAK



ACTV DET: PEAK  
MEAS DET: PEAK QP AVG  
MKR 660 kHz  
50.61 dBµV

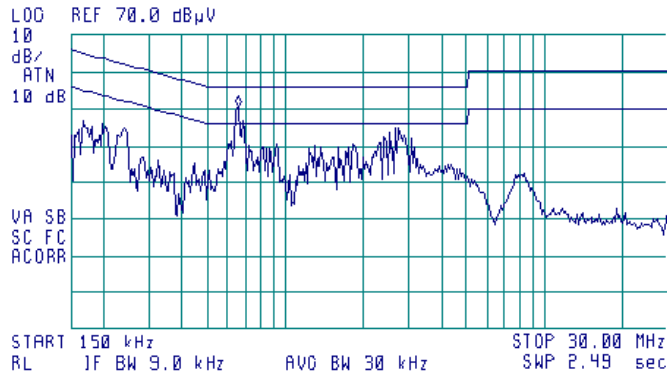

**Plot 7.4.2 Conducted emission measurements**

LINE: L2  
EUT OPERATING MODE: Transmit  
LIMIT: QUASI-PEAK, AVERAGE  
DETECTOR: PEAK



ACTV DET: PEAK  
MEAS DET: PEAK QP AVG  
MKR 160 kHz  
40.35 dBµV

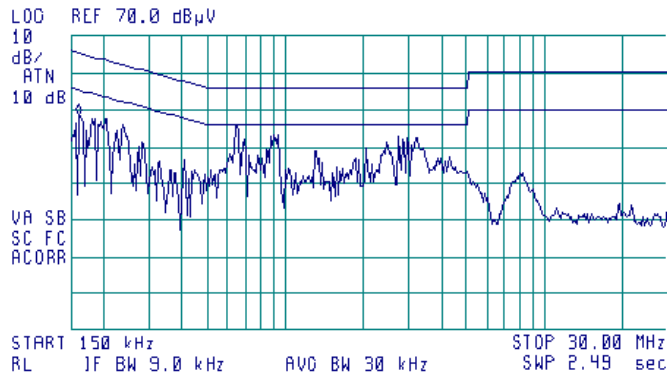



<b>Test specification:</b> FCC Part 15, Section 203, Antenna requirements			
<b>Test procedure:</b> Visual inspection / supplier declaration			
<b>Test mode:</b> Compliance		<b>Verdict:</b> PASS	
<b>Date(s):</b> 18-Aug-16			
<b>Temperature:</b> 25 °C	<b>Relative Humidity:</b> 51 %	<b>Air Pressure:</b> 1005 hPa	<b>Power:</b> 120 VAC
<b>Remarks:</b>			

### 7.5 Antenna requirements

The EUT was verified for compliance with antenna requirements. A transmitter shall be designed to ensure that no antenna other than that furnished by the responsible party will be used with the device. It may be either permanently attached or employs a unique antenna connector for every antenna proposed for use with the EUT. This requirement does not apply to professionally installed transmitters. The rationale for compliance with the above requirements was either visual inspection results or supplier declaration. The summary of results is provided in Table 7.5.1.

Table 7.5.1 Antenna requirements

Requirement	Rationale	Verdict
The transmitter antenna is permanently attached	Visual inspection	Comply
The transmitter employs a unique antenna connector	NA	
The transmitter requires professional installation	NA	

Photograph 7.5.1 Antenna assembly

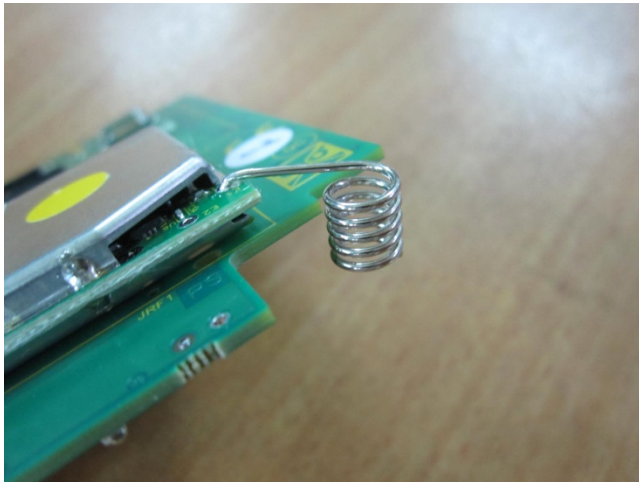

**8 APPENDIX A Test equipment and ancillaries used for tests**

HL No	Description	Manufacturer	Model	Ser. No.	Last Cal./ Check	Due Cal./ Check
0415	Cable, Coax, RF, RG-214, 12.3 m	Hermon Laboratories	CC-3	056	18-Dec-16	18-Dec-17
0447	LISN, 16/2, 300V RMS, 50 Ohm/50 uH + 5 Ohm, STD CISPR 16-1	Hermon Laboratories	LISN 16 - 1	066	01-Nov-16	01-Nov-17
0566	Antenna, Biconical, 20 - 200 MHz	Electro-Metrics	BIA 25/30	3566	05-Dec-17	05-Dec-18
0583	Antenna, Log Periodic, 200 - 1000 MHz	Hermon Laboratories	LP 200/1000	035	30-Sep-16	30-Sep-18
0787	Transient Limiter 9 kHz-200 MHz	Hewlett Packard	11947A	3107A018 77	26-Oct-16	26-Oct-17
1513	Cable RF, 8 m, BNC/BNC	Belden	M17/167 MIL-C-17	1513	20-Sep-16	20-Sep-17
1915	Antenna, Loop, Active Receiving, 1 kHz - 30 MHz	EMC Test Systems	6507	1457	19-Jan-17	19-Jan-18
2432	Antenna, Double-Ridged Waveguide Horn 1 to 18 GHz	EMC Test Systems	3115	00027177	07-Feb-17	07-Feb-18
2780	EMC analyzer, 100 Hz to 26.5 GHz	Agilent Technologies	E7405A	MY451024 62	21-Feb-17	21-Feb-18
3612	Cable RF, 17.5 m, N type-N type	Teldor	RG-214/U	NA	18-Dec-16	18-Dec-17
3818	PSA Series Spectrum Analyzer, 3 Hz- 44 GHz	Agilent Technologies	E4446A	MY482502 88	07-May-17	07-May-18
4136	Shield Box	TESCOM CO., LTD	TC-5916A	5916A000 137	06-Apr-17	06-Apr-18
4274	Test Cable , DC-18 GHz, 1.8 m, SMA/M - N/M	Mini-Circuits	CBL-6FT-SMNM+	70047	30-May-16	30-May-17
4294	Microwave Cable Assembly, 18.0 GHz, 3.4 m, SMA/SMA	Huber-Suhner	Sucoflex P103	NA	18-Dec-16	18-Dec-17
4295	Microwave Cable Assembly, 18.0 GHz, 3.4 m, SMA/SMA	Huber-Suhner	Sucoflex P103	NA	16-Oct-16	16-Oct-17
4535	Microwave Cable Assembly, 6.5 GHz, 5.0 m, N/M type-N/M type	Suhner Switzerland	214-U	NA	30-May-16	30-May-17
4541	Microwave Cable Assembly, 4.0 GHz, 1.0 m, N/M type-N/M type	Suhner Switzerland	214-U	NA	25-Sep-16	25-Sep-17
4542	Amplifier, 9 kHz to 1 GHz, 32 dB gain	Sonoma Instrument	310	0002A056 39	15-Mar-17	15-Mar-18
4543	Broadband preamplifier, 0.5 to 18 GHz, 35 dB gain	Schwarzbeck mess-elektronik	BBV 9718	9718-134	15-Mar-17	15-Mar-18
4549	Cable RF, 6.8 m, N/N - type, up to 3 GHz	Suhner Switzerland	NA	07262	14-Mar-17	14-Mar-18
4551	Cable RF, 6.6 m, N/N - type, up to 18 GHz	Suhner Switzerland	Sucoflex 104E	22200/4E	01-Jan-17	01-Jan-18
4575	EXA Signal Analyzer, 9 kHz - 26.5 GHz	Agilent Technologies	N9010A	MY480301 10	06-Apr-17	06-Apr-18
4603	Horn Antenna, 1 - 18 GHz	Schwarzbeck mess-elektronik	BBHA 9120 D	9120D-611	14-Oct-16	14-Oct-17



HL No	Description	Manufacturer	Model	Ser. No.	Last Cal./ Check	Due Cal./ Check
4604	Biconilog Antenna, 26 - 2000 MHz	EMCO	3142B	9909-1421	12-May-17	12-May-18
4659	EMC Anechoic Chanber (6.75 x 3.05 x 3.69)m	ETS Euroshield	Ft2000	NA	NA	NA
4663	Spectrum Analyzer, 9 kHz - 1.5 GHz	Hewlett Packard	E7401A	US391501 41	15-Mar-17	15-Mar-18
4756	Digital Hygrometer / Thermometer, (0 to +50) deg., (20 to 99) %RH	WESTERN Humidor Corporation	Caliber 4	NA	06-Nov-16	06-Nov-17
4778	EMI Receiver, 9 kHz - 2.9 GHz, System: HL1431, HL4777	Hewlett Packard	8542E	30807A00 262, 3427A001 23	31-Oct-16	31-Oct-17

## 9 APPENDIX B Measurement uncertainties

### Expanded uncertainty at 95% confidence in Hermon Labs EMC measurements

Test description	Expanded uncertainty
Conducted emissions with LISN	9 kHz to 150 kHz: $\pm 3.9$ dB 150 kHz to 30 MHz: $\pm 3.8$ dB
Radiated emissions at 10 m measuring distance Horizontal polarization  Vertical polarization	Biconilog antenna: $\pm 5.0$ dB Biconical antenna: $\pm 5.0$ dB Log periodic antenna: $\pm 5.1$ dB Double ridged horn antenna: $\pm 5.3$ dB Biconilog antenna: $\pm 5.5$ dB Biconical antenna: $\pm 5.5$ dB Log periodic antenna: $\pm 5.6$ dB Double ridged horn antenna: $\pm 5.8$ dB
Radiated emissions at 3 m measuring distance Horizontal polarization  Vertical polarization	Biconilog antenna: $\pm 5.3$ dB Biconical antenna: $\pm 5.0$ dB Log periodic antenna: $\pm 5.3$ dB Double ridged horn antenna: $\pm 5.3$ dB Biconilog antenna: $\pm 6.0$ dB Biconical antenna: $\pm 5.7$ dB Log periodic antenna: $\pm 6.0$ dB Double ridged horn antenna: $\pm 6.0$ dB
Conducted emissions at RF antenna connector	9 kHz to 2.9 GHz: $\pm 2.6$ dB 2.9 GHz to 6.46 GHz: $\pm 3.5$ dB 6.46 GHz to 13.2 GHz: $\pm 4.3$ dB 13.2 GHz to 22.0 GHz: $\pm 5.0$ dB 22.0 GHz to 26.8 GHz: $\pm 5.5$ dB 26.8 GHz to 40.0 GHz: $\pm 4.8$ dB
Duty cycle, timing (Tx ON / OFF) and average factor measurements	$\pm 1.0$ %
Occupied bandwidth	$\pm 8.0$ %

Hermon Laboratories is accredited by A2LA for calibration according to present requirements of ISO/IEC 17025 and NCSL Z540-1. The accreditation is granted to perform calibration of parameters that are listed in the Scope of Hermon Laboratories Accreditation.

Hermon Laboratories calibrates its reference and transfer standards by calibration laboratories accredited to ISO/IEC 17025 by a mutually recognized Accreditation Body or by a recognized national metrology institute. All reference and transfer standards used in the calibration system are traceable to national or international standards.

In-house calibration of all test and measurement equipment is performed on a regular basis according to Hermon Laboratories calibration procedures, manufacturer calibration/verification procedures or procedures defined in the relevant standards. The Hermon Laboratories test and measurement equipment is calibrated within the tolerances specified by the manufacturers and/or by the relevant standards.



## 10 APPENDIX C Test laboratory description

Tests were performed at Hermon Laboratories Ltd., which is a fully independent, private, EMC, safety, environmental and telecommunication testing facility.

Hermon Laboratories is recognized and accredited by the Federal Communications Commission (USA) for 1, 2, 15, 18 parts of Code of Federal Regulations 47 (CFR 47), Test Firm Registration Number is 927748, Designation Number is IL1001; registered by Industry Canada for electromagnetic emissions, file number IC 2186A-1 for OATS, certified by VCCI, Japan (the registration numbers are R-808 for OATS, R-1082 for anechoic chamber, G-869 for RE measurements above 1 GHz, C-845 for conducted emissions site, T-1606 for conducted emissions at telecommunication ports). The laboratory is accredited by American Association for Laboratory Accreditation (USA) according to ISO/IEC 17025 for electromagnetic compatibility, product safety, telecommunications testing and environmental simulation (for exact scope please refer to Certificate No. 839.01).

Address: P.O. Box 23, Binyamina 30500, Israel.  
Telephone: +972 4628 8001  
Fax: +972 4628 8277  
e-mail: mail@hermonlabs.com  
website: www.hermonlabs.com

Person for contact: Mr. Alex Usoskin, CEO.

## 11 APPENDIX D Specification references

47CFR part 15: 2015	Radio Frequency Devices.
ANSI C63.10: 2013	American National Standard of Procedures for Compliance Testing of Unlicensed Wireless Devices
ANSI C63.2: 1996	American National Standard for Instrumentation-Electromagnetic Noise and Field Strength, 10 kHz to 40 GHz-Specifications.
ANSI C63.4: 2014	American National Standard for Methods of Measurement of Radio-Noise Emissions from Low-Voltage Electrical and Electronic Equipment in the Range of 9 kHz to 40 GHz



## 12 APPENDIX E Test equipment correction factors

Correction factor  
Line impedance stabilization network  
Model LISN 16 - 1  
Hermon Laboratories, HL 0447

Frequency, kHz	L1, dB	L2, dB
150	0.11	0.09
170	0.10	0.08
200	0.09	0.07
250	0.08	0.07
300	0.07	0.06
350	0.07	0.06
400	0.08	0.05
500	0.07	0.05
600	0.07	0.05
700	0.06	0.06
800	0.07	0.05
900	0.07	0.05
1000	0.07	0.05
1200	0.08	0.05
1500	0.08	0.06
2000	0.08	0.06
2500	0.08	0.06
3000	0.09	0.07
4000	0.09	0.06
5000	0.10	0.08
7000	0.11	0.09
10000	0.14	0.12
15000	0.19	0.17
20000	0.26	0.24
30000	0.45	0.45

The correction factor in dB is to be added to meter readings of an interference analyzer or a spectrum analyzer.



**Antenna factor  
Active loop antenna  
EMC Test Systems  
Model 6507, S/N 1457, HL 1915**

Frequency, kHz	Measured antenna factor, dBS/m
10	-22.7
20	-27.6
50	-31.3
75	-31.8
100	-32.2
150	-32.3
250	-32.6
500	-32.8
750	-33.0
1000	-33.1
2000	-33.4
3000	-33.7
4000	-34.0
5000	-34.3
10000	-34.9
15000	-35.6
20000	-35.9
25000	-36.1
30000	-36.7

The antenna factor shall be added to receiver reading in dB $\mu$ V to obtain field strength in dB $\mu$ A/m.



**Antenna factor  
Biconical antenna  
Electro-Metrics, model BIA-25/30  
Ser.No.3566, HL 0566**

Frequency MHz	Antenna Factor dB(1/m)	Frequency MHz	Antenna Factor dB(1/m)
30	14.7	120	16.8
35	12.9	125	15.5
40	12.6	130	15.5
45	12.8	135	15.1
50	12.6	140	14.8
55	11.8	145	15.1
60	11.7	150	16.9
65	10.4	155	17.2
70	9.2	160	17.3
75	9.1	165	17.8
80	9.1	170	18.3
85	9.5	175	19.0
90	11.2	180	19.5
95	12.6	185	20.0
100	13.7	190	20.4
105	14.2	195	20.5
110	15.3	200	20.6
115	17.1		

Antenna factor in dB(1/m) is to be added to receiver meter reading in dB( $\mu$ V) to convert it into field strength in dB( $\mu$ V/m).



**Antenna factor**  
**Log periodic antenna**  
**Hermon Laboratories, model LP 200/1000**  
**Ser.No.035, HL 0583**

Frequency, MHz	Antenna factor, dB(1/m)
200	12.0
250	12.5
300	14.5
350	15.7
400	16.0
450	16.7
500	18.1
550	18.2
600	18.8
650	20.1
700	21.8
750	21.4
800	21.4
850	22.4
900	22.8
950	23.4
1000	24.6

The antenna factor shall be added to receiver reading in dB $\mu$ V to obtain field strength in dB $\mu$ V/m.



**Antenna factor**  
**Double-ridged guide horn antenna**  
**Model 3115, serial number: 00027177, HL 2432**

<b>Frequency, MHz</b>	<b>Antenna factor. dB(1/m)</b>
1000.0	24.7
1500.0	25.7
2000.0	27.8
2500.0	28.9
3000.0	30.7
3500.0	31.8
4000.0	33.0
4500.0	32.8
5000.0	34.2
5500.0	34.9
6000.0	35.2
6500.0	35.4
7000.0	36.3
7500.0	37.3
8000.0	37.5
8500.0	38.0
9000.0	38.3
9500.0	38.3
10000.0	38.7
10500.0	38.7
11000.0	38.9
11500.0	39.5
12000.0	39.5
12500.0	39.4
13000.0	40.5
13500.0	40.8
14000.0	41.5
14500.0	41.3
15000.0	40.2
15500.0	38.7
16000.0	38.5
16500.0	39.8
17000.0	41.9
17500.0	45.8
18000.0	49.1

Antenna factor in dB(1/m) is to be added to receiver meter reading in dB( $\mu$ V) to convert it into field strength in dB( $\mu$ V/m).



**Antenna factor**  
**Horn antenna**  
Schwarzbeck mess-elektronik, Model BBHA 9120 D, serial number: 9120D-611, HL 4603

Frequency, MHz	Measured antenna factor, dB/m
1000	25.2
1500	25.7
2000	26.1
2500	27.5
3000	28.3
3500	29.0
4000	30.0
4500	30.8
5000	31.9
5500	32.2
6000	33.1
6500	34.6
7000	35.9
7500	36.6
8000	37.2
8500	36.6
9000	36.9
9500	37.5
10000	38.4
10500	39.5
11000	40.3
11500	40.0
12000	39.2
12500	38.7
13000	39.6
13500	40.8
14000	41.6
14500	42.1
15000	41.2
15500	39.1
16000	38.5
16500	39.9
17000	41.0
17500	44.1
18000	55.6

The antenna factor shall be added to receiver reading in dB $\mu$ V to obtain field strength in dB $\mu$ V/m.



**Antenna factor**  
**Biconilog Antenna, 26 - 2000 MHz**  
**EMCO, Model 3142B, serial number: 9909-1421, HL 4604**

Frequency, MHz	Measured, dB/m
30	17.9
35	14.8
40	12.1
45	10.0
50	8.7
60	8.1
70	7.3
80	6.6
90	7.6
100	7.9
120	7.0
140	7.7
160	9.6
180	10.0
200	10.2
250	12.7
300	13.4
400	16.7
500	18.2
600	20.2
700	22.0
800	22.7
900	24.1
1000	25.0

The antenna factor shall be added to receiver reading in dB $\mu$ V to obtain field strength in dB $\mu$ V/m





**Cable loss**  
**Cable coax, RG-214, 12.3 m, s/n 056, HL 0415**

No.	Frequency, MHz	Cable loss, dB	Measured uncertainty, dB
1	10	0.23	±0.12
2	30	0.44	±0.12
3	50	0.60	±0.12
4	100	0.89	±0.12
5	150	1.11	±0.13
6	200	1.30	±0.13
7	250	1.45	±0.13
8	300	1.61	±0.13
9	400	1.94	±0.13
10	500	2.18	±0.13
11	600	2.45	±0.14
12	700	2.67	±0.14
13	800	2.94	±0.14
14	900	3.16	±0.14
15	1000	3.38	±0.14



**Cable loss**  
**Cable coaxial, RG-214/U, N type-N type, 17 m**  
**Teldor, HL 3612**

Frequency, MHz	Measured, dB
0.10	0.04
10.0	0.37
20.0	0.54
30.0	0.69
40.0	0.80
50	0.91
60	1.00
70	1.08
80	1.16
90	1.24
100	1.31
150	1.63
200	1.90
250	2.15
300	2.38
350	2.60
400	2.80
450	3.00
500	3.18
550	3.36
600	3.54
650	3.71
700	3.87
750	4.04
800	4.20
850	4.35
900	4.51
950	4.66
1000	4.81



**Cable loss**  
**Test cable, Mini-Circuits, S/N 70047, 18 GHz, 1.8 m, SMA/M - N/M**  
**CBL-6FT-SMNM+, HL 4274**

Frequency, MHz	Cable loss, dB	Frequency, MHz	Cable loss, dB	Frequency, MHz	Cable loss, dB	Frequency, MHz	Cable loss, dB
10	0.07	4800	1.69	9800	2.62	14800	3.42
30	0.11	4900	1.70	9900	2.63	14900	3.39
50	0.14	5000	1.72	10000	2.64	15000	3.38
100	0.21	5100	1.75	10100	2.64	15100	3.40
200	0.26	5200	1.76	10200	2.66	15200	3.41
300	0.30	5300	1.77	10300	2.67	15300	3.40
400	0.37	5400	1.79	10400	2.68	15400	3.39
500	0.44	5500	1.82	10500	2.68	15500	3.41
600	0.49	5600	1.85	10600	2.70	15600	3.44
700	0.54	5700	1.86	10700	2.71	15700	3.46
800	0.58	5800	1.87	10800	2.73	15800	3.45
900	0.63	5900	1.91	10900	2.74	15900	3.47
1000	0.67	6000	1.94	11000	2.76	16000	3.51
1100	0.71	6100	1.97	11100	2.77	16100	3.56
1200	0.75	6200	1.98	11200	2.78	16200	3.55
1300	0.78	6300	1.99	11300	2.79	16300	3.54
1400	0.81	6400	2.02	11400	2.80	16400	3.57
1500	0.85	6500	2.05	11500	2.82	16500	3.62
1600	0.88	6600	2.06	11600	2.83	16600	3.61
1700	0.91	6700	2.06	11700	2.84	16700	3.60
1800	0.94	6800	2.08	11800	2.85	16800	3.62
1900	0.97	6900	2.10	11900	2.87	16900	3.68
2000	1.00	7000	2.12	12000	2.88	17000	3.70
2100	1.03	7100	2.12	12100	2.89	17100	3.68
2200	1.06	7200	2.13	12200	2.90	17200	3.70
2300	1.08	7300	2.16	12300	2.92	17300	3.80
2400	1.11	7400	2.19	12400	2.94	17400	3.84
2500	1.14	7500	2.22	12500	2.95	17500	3.83
2600	1.16	7600	2.23	12600	2.96	17600	3.83
2700	1.19	7700	2.26	12700	2.98	17700	3.86
2800	1.21	7800	2.30	12800	3.00	17800	3.86
2900	1.27	7900	2.33	12900	3.02	17900	3.80
3000	1.29	8000	2.35	13000	3.03	18000	3.79
3100	1.32	8100	2.37	13100	3.06		
3200	1.35	8200	2.41	13200	3.08		
3300	1.37	8300	2.44	13300	3.09		
3400	1.38	8400	2.47	13400	3.10		
3500	1.41	8500	2.48	13500	3.13		
3600	1.43	8600	2.51	13600	3.17		
3700	1.46	8700	2.53	13700	3.17		
3800	1.47	8800	2.55	13800	3.18		
3900	1.49	8900	2.56	13900	3.22		
4000	1.52	9000	2.57	14000	3.26		
4100	1.55	9100	2.58	14100	3.28		
4200	1.56	9200	2.59	14200	3.30		
4300	1.58	9300	2.59	14300	3.35		
4400	1.60	9400	2.60	14400	3.39		
4500	1.63	9500	2.60	14500	3.39		
4600	1.65	9600	2.61	14600	3.39		
4700	1.67	9700	2.61	14700	3.41		



**Cable loss**  
**Microwave Cable Assembly, 18.0 GHz, 3.4 m, SMA/SMA, Huber-Suhner,**  
**Sucoflex P103, HL 4294**

Frequency, MHz	Cable loss, dB	Frequency, MHz	Cable loss, dB	Frequency, MHz	Cable loss, dB	Frequency, MHz	Cable loss, dB
10	0.11	4900	2.09	10000	2.90	15100	3.61
30	0.17	5000	2.10	10100	2.92	15200	3.67
50	0.22	5100	2.14	10200	2.95	15300	3.63
100	0.30	5200	2.16	10300	2.96	15400	3.64
200	0.42	5300	2.17	10400	2.99	15500	3.68
300	0.51	5400	2.19	10500	2.99	15600	3.71
400	0.59	5500	2.19	10600	3.03	15700	3.74
500	0.66	5600	2.22	10700	3.03	15800	3.71
600	0.72	5700	2.24	10800	3.04	15900	3.74
700	0.77	5800	2.23	10900	3.05	16000	3.71
800	0.82	5900	2.26	11000	3.09	16100	3.73
900	0.88	6000	2.27	11100	3.07	16200	3.76
1000	0.93	6100	2.26	11200	3.08	16300	3.82
1100	0.98	6200	2.29	11300	3.11	16400	3.90
1200	1.02	6300	2.30	11400	3.12	16500	3.81
1300	1.06	6400	2.34	11500	3.11	16600	3.88
1400	1.10	6500	2.34	11600	3.15	16700	3.87
1500	1.14	6600	2.36	11700	3.16	16800	3.89
1600	1.19	6700	2.36	11800	3.18	16900	3.95
1700	1.23	6800	2.39	11900	3.19	17000	4.02
1800	1.27	6900	2.39	12000	3.23	17100	4.04
1900	1.30	7000	2.44	12100	3.25	17200	3.99
2000	1.35	7100	2.46	12200	3.22	17300	4.03
2100	1.38	7200	2.44	12300	3.25	17400	4.03
2200	1.42	7300	2.48	12400	3.25	17500	4.06
2300	1.45	7400	2.47	12500	3.28	17600	4.05
2400	1.48	7500	2.48	12600	3.27	17700	4.12
2500	1.51	7600	2.50	12700	3.27	17800	4.14
2600	1.55	7700	2.53	12800	3.30	17900	4.18
2700	1.59	7800	2.56	12900	3.30	18000	4.14
2800	1.62	7900	2.55	13000	3.27		
2900	1.65	8000	2.56	13100	3.32		
3000	1.66	8100	2.56	13200	3.32		
3100	1.69	8200	2.57	13300	3.32		
3200	1.71	8300	2.59	13400	3.35		
3300	1.74	8400	2.62	13500	3.38		
3400	1.76	8500	2.67	13600	3.39		
3500	1.78	8600	2.65	13700	3.42		
3600	1.80	8700	2.68	13800	3.47		
3700	1.85	8800	2.68	13900	3.45		
3800	1.88	8900	2.68	14000	3.49		
3900	1.90	9000	2.74	14100	3.50		
4000	1.91	9100	2.74	14200	3.55		
4100	1.93	9200	2.76	14300	3.59		
4200	1.96	9300	2.78	14400	3.58		
4300	1.97	9400	2.79	14500	3.56		
4400	1.99	9500	2.80	14600	3.57		
4500	2.02	9600	2.83	14700	3.57		
4600	2.02	9700	2.84	14800	3.57		
4700	2.04	9800	2.86	14900	3.64		
4800	2.05	9900	2.92	15000	3.64		



**Cable loss**  
**Microwave Cable Assembly, 18.0 GHz, 3.4 m, SMA/SMA, Huber-Suhner, S/N 4295,**  
**Sucoflex P103, HL 4295**

Frequency, MHz	Cable loss, dB	Frequency, MHz	Cable loss, dB	Frequency, MHz	Cable loss, dB	Frequency, MHz	Cable loss, dB
10	0.11	5000	2.09	10200	2.97	15400	3.63
30	0.18	5100	2.12	10300	3.01	15500	3.65
50	0.23	5200	2.13	10400	3.00	15600	3.63
100	0.31	5300	2.16	10500	3.05	15700	3.64
200	0.38	5400	2.19	10600	3.09	15800	3.64
300	0.43	5500	2.21	10700	3.05	15900	3.66
400	0.52	5600	2.21	10800	3.09	16000	3.71
500	0.60	5700	2.24	10900	3.10	16100	3.67
600	0.67	5800	2.24	11000	3.08	16200	3.71
700	0.72	5900	2.25	11100	3.11	16300	3.70
800	0.78	6000	2.27	11200	3.12	16400	3.71
900	0.83	6100	2.25	11300	3.12	16500	3.72
1000	0.89	6200	2.29	11400	3.20	16600	3.84
1100	0.94	6300	2.34	11500	3.16	16700	3.78
1200	0.98	6400	2.37	11600	3.16	16800	3.85
1300	1.03	6500	2.33	11700	3.20	16900	3.88
1400	1.06	6600	2.34	11800	3.19	17000	3.85
1500	1.11	6700	2.39	11900	3.21	17100	3.88
1600	1.14	6800	2.46	12000	3.28	17200	3.92
1700	1.19	6900	2.45	12100	3.23	17300	3.90
1800	1.22	7000	2.44	12200	3.26	17400	4.00
1900	1.26	7100	2.43	12300	3.30	17500	4.02
2000	1.30	7200	2.44	12400	3.25	17600	4.00
2100	1.34	7300	2.51	12500	3.26	17700	3.96
2200	1.37	7400	2.54	12600	3.30	17800	4.01
2300	1.40	7500	2.49	12700	3.26	17900	4.02
2400	1.44	7600	2.52	12800	3.34	18000	4.08
2500	1.47	7700	2.59	12900	3.37		
2600	1.50	7800	2.57	13000	3.30		
2700	1.55	7900	2.55	13100	3.35		
2800	1.58	8000	2.57	13200	3.31		
2900	1.60	8100	2.58	13300	3.33		
3000	1.63	8200	2.64	13400	3.42		
3100	1.64	8300	2.70	13500	3.43		
3200	1.67	8400	2.65	13600	3.40		
3300	1.69	8500	2.66	13700	3.47		
3400	1.73	8600	2.68	13800	3.45		
3500	1.74	8700	2.70	13900	3.43		
3600	1.76	8800	2.74	14000	3.52		
3700	1.79	8900	2.74	14100	3.51		
3800	1.82	9000	2.76	14200	3.54		
3900	1.85	9100	2.82	14300	3.55		
4000	1.87	9200	2.79	14400	3.52		
4100	1.90	9300	2.82	14500	3.52		
4200	1.92	9400	2.83	14600	3.56		
4300	1.93	9500	2.83	14700	3.55		
4400	1.94	9600	2.86	14800	3.55		
4500	1.97	9700	2.93	14900	3.59		
4600	1.99	9800	2.89	15000	3.56		
4700	2.01	9900	2.91	15100	3.59		
4800	2.02	10000	2.94	15200	3.59		
4900	2.04	10100	2.94	15300	3.59		



**Cable loss**  
**Microwave Cable Assembly, 6.5 GHz, 5.0 m, N/M type-N/M type**  
**Suhner Switzerland, HL 4535**

Frequency, MHz	Cable loss, dB	Frequency, MHz	Cable loss, dB	Frequency, MHz	Cable loss, dB
10	0.10	1700	1.79	4400	3.53
15	0.13	1800	1.86	4500	3.60
20	0.15	1900	1.93	4600	3.72
30	0.18	2000	2.00	4700	3.80
40	0.21	2100	2.06	4800	3.87
50	0.24	2200	2.13	4900	3.94
60	0.26	2300	2.19	5000	3.99
70	0.29	2400	2.25	5100	4.06
80	0.31	2500	2.32	5200	4.12
90	0.33	2600	2.38	5300	4.17
100	0.35	2700	2.45	5400	4.25
150	0.43	2800	2.51	5500	4.31
200	0.50	2900	2.57	5600	4.40
300	0.63	3000	2.64	5700	4.47
400	0.74	3100	2.73	5800	4.54
500	0.85	3200	2.79	5900	4.64
600	0.94	3300	2.86	6000	4.73
700	1.03	3400	2.91	6100	4.79
800	1.12	3500	2.97	6200	4.89
900	1.20	3600	3.02	6300	5.00
1000	1.28	3700	3.07	6400	5.06
1100	1.35	3800	3.14	6500	5.13
1200	1.43	3900	3.20		
1300	1.50	4000	3.25		
1400	1.58	4100	3.32		
1500	1.65	4200	3.38		
1600	1.72	4300	3.46		



**Cable loss**  
**Microwave Cable Assembly, 4.0 GHz, 1.0 m, N/M type-N/M type**  
**Suhner Switzerland, HL 4541**

Frequency, MHz	Cable loss, dB	Frequency, MHz	Cable loss, dB
10	0.02	1700	0.45
15	0.03	1800	0.46
20	0.03	1900	0.48
30	0.04	2000	0.49
40	0.04	2100	0.52
50	0.05	2200	0.54
60	0.06	2300	0.55
70	0.06	2400	0.56
80	0.07	2500	0.58
90	0.07	2600	0.59
100	0.08	2700	0.61
150	0.10	2800	0.63
200	0.12	2900	0.64
300	0.15	3000	0.67
400	0.18	3100	0.70
500	0.20	3200	0.74
600	0.23	3300	0.77
700	0.25	3400	0.80
800	0.28	3500	0.82
900	0.30	3600	0.86
1000	0.31	3700	0.88
1100	0.33	3800	0.94
1200	0.35	3900	0.95
1300	0.37	4000	0.99
1400	0.39		
1500	0.41		
1600	0.43		



### 13 APPENDIX F Abbreviations and acronyms

A	ampere
AC	alternating current
A/m	ampere per meter
AM	amplitude modulation
AVRG	average (detector)
cm	centimeter
dB	decibel
dBm	decibel referred to one milliwatt
dB( $\mu$ V)	decibel referred to one microvolt
dB( $\mu$ V/m)	decibel referred to one microvolt per meter
dB( $\mu$ A)	decibel referred to one microampere
DC	direct current
EIRP	equivalent isotropically radiated power
ERP	effective radiated power
EUT	equipment under test
F	frequency
GHz	gigahertz
GND	ground
H	height
HL	Hermon laboratories
Hz	hertz
k	kilo
kHz	kilohertz
LO	local oscillator
m	meter
MHz	megahertz
min	minute
mm	millimeter
ms	millisecond
$\mu$ s	microsecond
NA	not applicable
NB	narrow band
OATS	open area test site
$\Omega$	Ohm
PM	pulse modulation
PS	power supply
ppm	part per million ( $10^{-6}$ )
QP	quasi-peak
RE	radiated emission
RF	radio frequency
rms	root mean square
Rx	receive
s	second
T	temperature
Tx	transmit
V	volt
WB	wideband

END OF TEST REPORT



## 14 APPENDIX G Manufacturer's declaration



### Declaration

We, the undersigned,

**Essence Security International**

**Part of Essence Group**

**12 Abba Eban Avenue,**

**Ackerstein Tower Bldg. D**

**P.O Box 2073**

**Herzliya, 4612001**

**ISRAEL**

Tel: +972-73-2447777

Fax: +972-9-7729962

certify and declare under our sole responsibility that the following equipment:

Product Description	Brand
VeriSureFast To Mobile, Control Panel	ES6502VSF

Confirm that the device is not transmit any Supervision signals.

Israel Gottesman  
Standards Engineer  
May 14, 2017

END OF DOCUMENT