



SAR Test Report

Product Name : Wireless USB Adaptor
Model No. : GWF-3S4T
FCC ID : YWTWF3SXXT

Applicant : Shenzhen Ogemray Technology Co., Ltd
Address : 3/F, No.9 Bldg.Minxing Industrial Park.Minkang Rd.
Minzhi St.Baoan District. Shenzhen

Date of Receipt : 24/02/2012
Date of Test : 22/04/2012~23/04/2012
Issued Date : 25/04/2012
Report No. : 122S082R-HP-US-P03V01
Report Version : V1.1

The test results relate only to the samples tested.

The test report shall not be reproduced except in full without the written approval of Quietek Corporation.

Test Report Certification

Issued Date: 25/04/2012

Report No: 122S082R-HP-US-P03V01



Product Name : Wireless USB Adaptor

Applicant : Shenzhen Ogemray Technology Co., Ltd

Address : 3/F, No.9 Bldg.Minxing Industrial Park.Minkang Rd. Minzhi
St.Baoan District. Shenzhen

Manufacturer : Shenzhen Ogemray Technology Co., Ltd

Address : 3/F, No.9 Bldg.Minxing Industrial Park.Minkang Rd. Minzhi
St.Baoan District. Shenzhen

FCC ID : YWTWF3SXXT

Model No. : GWF-3S4T

EUT Voltage : DC 5V

Applicable Standard : FCC OET65 Supplement C June 2001
IEEE Std. 1528-2003,
47CFR § 2.1093

Test Result : Max. SAR Measurement (1g)
802.11b: 0.587 W/kg

Performed Location : Suzhou EMC Laboratory
No.99 Hongye Rd., Suzhou Industrial Park Loufeng Hi-Tech
Development Zone., Suzhou, China
TEL: +86-512-6251-5088 / FAX: +86-512-6251-5098
FCC Registration Number: 800392

Documented By : Alice Ni
(Engineering ADM: Alice Ni)

Reviewed By : Robin Wu
(Engineering Supervisor: Robin Wu)

Approved By : Marlin Chen
(Engineering Manager: Marlin Chen)

Laboratory Information

We, **Quietek Corporation**, are an independent EMC and safety consultancy that was established the whole facility in our laboratories. The test facility has been accredited/accepted(audited or listed) by the following related bodies in compliance with ISO 17025, EN 45001 and specified testing scope:

Taiwan R.O.C.	:	BSMI, NCC, TAF
Germany	:	TUV Rheinland
Norway	:	Nemko, DNV
USA	:	FCC, NVLAP
Japan	:	VCCI
China	:	CNAS

The related certificate for our laboratories about the test site and management system can be downloaded from Quietek Corporation's Web Site :<http://www.quietek.com/tw/ctg/cts/accreditations.htm>

The address and introduction of Quietek Corporation's laboratories can be founded in our Web site :
<http://www.quietek.com/>

If you have any comments, Please don't hesitate to contact us. Our contact information is as below:

HsinChu Testing Laboratory :

No.75-2, 3rd Lin, Wangye Keng, Yonghxing Tsuen, Qionglin Shiang, Hsinchu County 307, Taiwan, R.O.C.
TEL:+886-3-592-8858 / FAX:+886-3-592-8859 E-Mail : service@quietek.com

LinKou Testing Laboratory :

No.5-22, Ruishukeng, Linkou Dist., New Taipei City 24451, Taiwan, R.O.C.
TEL : 886-2-8601-3788 / FAX : 886-2-8601-3789 E-Mail : service@quietek.com

Suzhou Testing Laboratory :

No.99 Hongye Rd., Suzhou Industrial Park Loufeng Hi-Tech Development Zone., SuZhou, China
TEL : +86-512-6251-5088 / FAX : 86-512-6251-5098 E-Mail : service@quietek.com

TABLE OF CONTENTS

Description	Page
1. General Information	6
1.1. EUT Description	6
1.2. Test Environment.....	7
2. SAR Measurement System	8
2.1. DASY5 System Description.....	8
2.1.1. Applications	9
2.1.2. Area Scans	9
2.1.3. Zoom Scan (Cube Scan Averaging)	9
2.1.4. Uncertainty of Inter-/Extrapolation and Averaging	9
2.2. DASY5 E-Field Probe.....	10
2.2.1. Isotropic E-Field Probe Specification	10
2.3. Boundary Detection Unit and Probe Mounting Device	11
2.4. DATA Acquisition Electronics (DAE) and Measurement Server	11
2.5. Robot.....	12
2.6. Light Beam Unit.....	12
2.7. Device Holder.....	13
2.8. SAM Twin Phantom.....	13
3. Tissue Simulating Liquid	14
3.1. The composition of the tissue simulating liquid	14
3.2. Tissue Calibration Result.....	14
3.3. Tissue Dielectric Parameters for Head and Body Phantoms	15
4. SAR Measurement Procedure	16
4.1. SAR System Validation.....	16
4.1.1. Validation Dipoles	16
4.1.2. Validation Result	16
4.2. SAR Measurement Procedure.....	17
5. SAR Exposure Limits.....	18
6. Test Equipment List.....	19
7. Measurement Uncertainty.....	20
8. Conducted Power Measurement	21
9. Test Procedures.....	22

9.1. Test position and configuration22

9.2. SAR Test Results Summary23

Appendix A. SAR System Validation Data25

Appendix B. SAR measurement Data26

Appendix C. Test Setup Photographs & EUT Photographs47

Appendix D. Probe Calibration Data59

Appendix E. Dipole Calibration Data.....70

Appendix F. DAE Calibration Data.....79

1. General Information

1.1. EUT Description

Product Name	Wireless USB Adaptor
FCC ID	YWTWF3SXXT
Model No.	GWF-3S4T
Frequency Range	802.11b/g/n(20MHz): 2412 - 2462 MHz 802.11n(40MHz): 2422 - 2452 MHz
Channel Number	802.11b/g/n(20MHz): 11 802.11n(40MHz): 7
Type of Modulation	802.11b: DSSS 802.11g/n: OFDM
Data Rate	802.11g: 6/9/12/18/24/36/48/54 Mbps 802.11b: 1/2/5.5/11 Mbps 802.11n: up to 150 Mbps
Device Category	Mobile
RF Exposure Environment	Uncontrolled
Antenna Type	Dipole
Peak Antenna Gain	2 dBi
Max. Output Power (Conducted)	802.11b: 18.81dBm 802.11g: 15.79dBm 802.11n(20MHz): 14.53dBm 802.11n(40MHz): 14.00dBm

1.2. Test Environment

Ambient conditions in the laboratory:

Items	Required	Actual
Temperature (°C)	18-25	21.5± 2
Humidity (%RH)	30-70	52

2. SAR Measurement System

2.1. DASY5 System Description

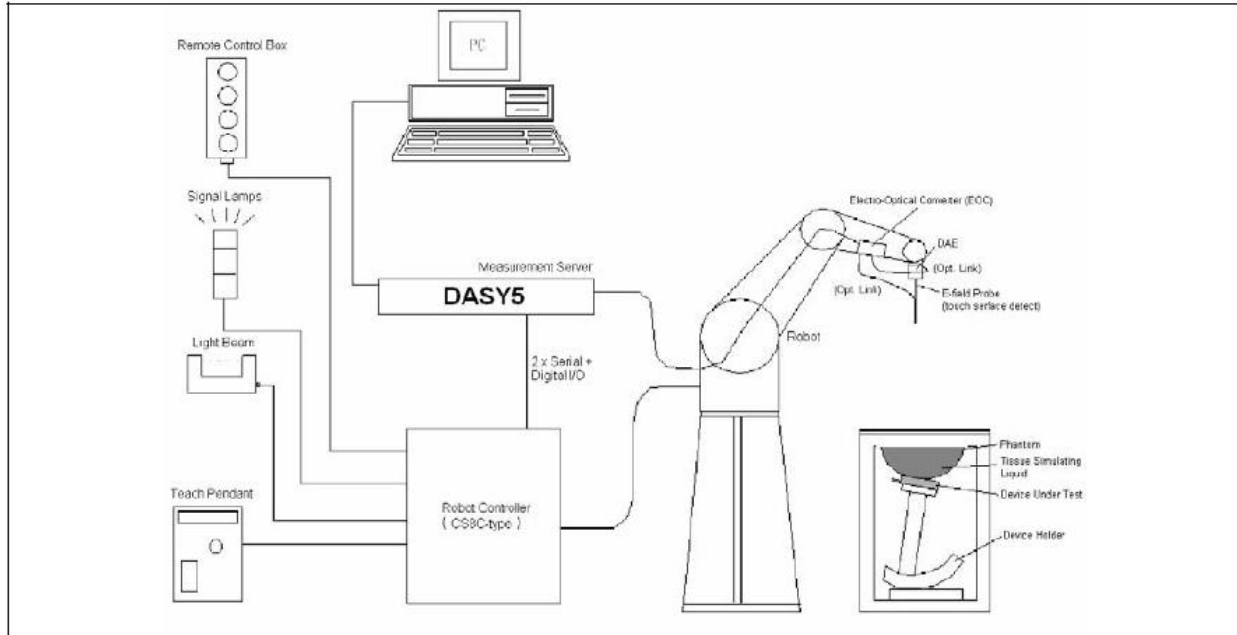

The DASY5 system for performing compliance tests consists of the following items:

- A standard high precision 6-axis robot with controller, teach pendant and software. An arm extension for accommodating the data acquisition electronics (DAE).
- A data acquisition electronics (DAE) which performs the signal amplification, signal multiplexing, AD-conversion, offset measurements, mechanical surface detection, collision detection, etc. The unit is battery powered with standard or rechargeable batteries. The signal is optically transmitted to the EOC.
- The Electro-optical converter (EOC) performs the conversion from optical to electrical signals for the digital communication to the DAE. To use optical surface detection, a special version of the EOC is required. The EOC signal is transmitted to the measurement server.
- The Light Beam used is for probe alignment. This improves the (absolute) accuracy of the probe positioning.
- A computer running WinXP and the DASY5 software.
- Remote control and teach pendant as well as additional circuitry for robot safety such as warning lamps, etc.
- The phantom, the device holder and other accessories according to the targeted measurement.

2.1.1. Applications

Predefined procedures and evaluations for automated compliance testing with all worldwide standards, e.g., IEEE 1528, OET 65, IEC 62209-1, IEC 62209-2, EN 50360, EN 50383 and others.

2.1.2. Area Scans

Area scans are defined prior to the measurement process being executed with a user defined variable spacing between each measurement point (integral) allowing low uncertainty measurements to be conducted. Scans defined for FCC applications utilize a 10mm² step integral, with 1mm interpolation used to locate the peak SAR area used for zoom scan assessments.

When an Area Scan has measured all reachable points, it computes the field maxima found in the scanned area, within a range of the global maximum. The range (in dB) is specified in the standards for compliance testing. For example, a 2 dB range is required in IEEE 1528-2003 and IEC 62209 standards, whereby 3 dB is a requirement when compliance is assessed in accordance with the ARIB standard (Japan).

2.1.3. Zoom Scan (Cube Scan Averaging)

Zoom Scans are used to assess the peak spatial SAR values within a cubic averaging volume containing 1 g and 10 g of simulated tissue. A density of 1000 kg/m³ is used to represent the head and body tissue density and not the phantom liquid density, in order to be consistent with the definition of the liquid dielectric properties, i.e. the side length of the 1 g cube is 10mm, with the side length of the 10 g cube 21,5mm.

The zoom scan integer steps can be user defined so as to reduce uncertainty, but normal practice for typical test applications utilize a physical step of 7x7x7 (5mmx5mmx5mm) providing a volume of 30mm in the X & Y axis, and 30mm in the Z axis.

2.1.4. Uncertainty of Inter-/Extrapolation and Averaging

In order to evaluate the uncertainty of the interpolation, extrapolation and averaged SAR calculation algorithms of the Postprocessor, DASY5 allows the generation of measurement grids which are artificially predefined by analytically based test functions. Therefore, the grids of area scans and zoom scans can be filled with uncertainty test data, according to the SAR benchmark functions of IEEE 1528. The three analytical functions shown in equations as below are used to describe the possible range of the expected SAR distributions for the tested handsets. The field gradients are covered by the spatially flat distribution f1, the spatially steep distribution f3 and f2 accounts for H-field cancellation on the phantom/tissue surface.

$$f_1(x, y, z) = Ae^{-\frac{z}{2a}} \cos^2 \left(\frac{\pi \sqrt{x'^2 + y'^2}}{2 \cdot 5a} \right)$$

$$f_2(x, y, z) = Ae^{-\frac{z}{a}} \frac{a^2}{a^2 + x'^2} \left(3 - e^{-\frac{2z}{a}} \right) \cos^2 \left(\frac{\pi y'}{2 \cdot 3a} \right)$$

$$f_3(x, y, z) = A \frac{a^2}{\frac{a^2}{4} + x'^2 + y'^2} \left(e^{-\frac{2z}{a}} + \frac{a^2}{2(a + 2z)^2} \right)$$

2.2. DASY5 E-Field Probe

The SAR measurement is conducted with the dosimetric probe manufactured by SPEAG. The probe is specially designed and calibrated for use in liquid with high permittivity. The dosimetric probe has special calibration in liquid at different frequency. SPEAG conducts the probe calibration in compliance with international and national standards (e.g. IEEE 1528, EN 62209-1, IEC 62209, etc.) under ISO 17025. The calibration data are in Appendix D.

2.2.1. Isotropic E-Field Probe Specification

Model	EX3DV4	
Construction	Symmetrical design with triangular core Built-in shielding against static charges PEEK enclosure material (resistant to organic solvents, e.g., DGBE)	
Frequency	10 MHz to 6 GHz Linearity: ± 0.2 dB (30 MHz to 6 GHz)	
Directivity	± 0.3 dB in HSL (rotation around probe axis) ± 0.5 dB in tissue material (rotation normal to probe axis)	
Dynamic Range	10 µW/g to 100 mW/g Linearity: ± 0.2 dB (noise: typically < 1 µW/g)	
Dimensions	Overall length: 330 mm (Tip: 20 mm) Tip diameter: 2.5 mm (Body: 12 mm) Typical distance from probe tip to dipole centers: 1 mm	
Application	High precision dosimetric measurements in any exposure scenario (e.g., very strong gradient fields). Only probe which enables compliance testing for frequencies up to 6 GHz with precision of better 30%.	

2.3. Boundary Detection Unit and Probe Mounting Device

The DASY probes use a precise connector and an additional holder for the probe, consisting of a plastic tube and a flexible silicon ring to center the probe. The connector at the DAE is flexibly mounted and held in the default position with magnets and springs. Two switching systems in the connector mount detect frontal and lateral probe collisions and trigger the necessary software response.

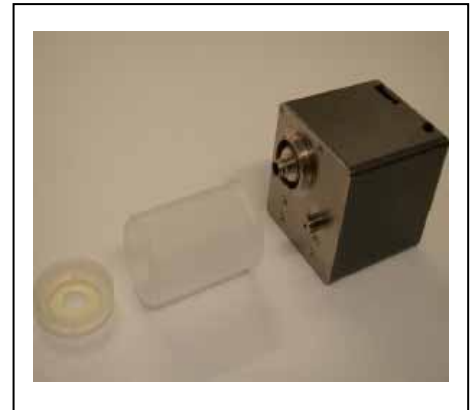

2.4. DATA Acquisition Electronics (DAE) and Measurement Server

The data acquisition electronics (DAE) consists of a highly sensitive electrometer-grade preamplifier with auto-zeroing, a channel and gain-switching multiplexer, a fast 16 bit AD-converter and a command decoder and control logic unit.

Transmission to the measurement server is accomplished through an optical downlink for data and status information as well as an optical uplink for commands and the clock.

The input impedance of the DAE4 is 200M Ohm; the inputs are symmetrical and floating. Common mode rejection is above 80dB.



The DASY5 measurement server is based on a PC/104 CPU board with a 400MHz intel ULV Celeron, 128MB chipdisk and 128MB RAM. The necessary circuits for communication with the DAE electronics box, as well as the 16 bit AD converter system for optical detection and digital I/O interface are contained on the DASY5 I/O board, which is directly connected to the PC/104 bus of the CPU board.



2.5. Robot

The DASY5 system uses the high precision robots TX90 XL type out of the newer series from Stäubli SA (France). For the 6-axis controller DASY5 system, the CS8C robot controller version from Stäubli is used.

The XL robot series have many features that are important for our application:

- High precision (repeatability 0.02 mm)
- High reliability (industrial design)
- Jerk-free straight movements
- Low ELF interference (the closed metallic construction shields against motor control fields)
- 6-axis controller



2.6. Light Beam Unit

The light beam switch allows automatic "tooling" of the probe. During the process, the actual position of the probe tip with respect to the robot arm is measured, as well as the probe length and the horizontal probe offset. The software then corrects all movements, such that the robot coordinates are valid for the probe tip.

The repeatability of this process is better than 0.1 mm. If a position has been taught with an aligned probe, the same position will be reached with another aligned probe within 0.1 mm, even if the other probe has different dimensions. During probe rotations, the probe tip will keep its actual position.



2.7. Device Holder

The DASY5 device holder is designed to cope with different positions given in the standard. It has two scales for the device rotation (with respect to the body axis) and the device inclination (with respect to the line between the ear reference points). The rotation center for both scales is the ear reference point (EPR).

Thus the device needs no repositioning when changing the angles.

The DASY5 device holder has been made out of low-loss POM material having the following dielectric parameters: relative permittivity $\epsilon_r = 3$ and loss tangent $\delta = 0.02$. The amount of dielectric material has been reduced in the closest vicinity of the device, since measurements have suggested that the influence of the clamp on the test results could thus be lowered.



2.8. SAM Twin Phantom

The SAM twin phantom is a fiberglass shell phantom with 2mm shell thickness (except the ear region where shell thickness increases to 6mm). It has three measurement areas:

- Left head
- Right head
- Flat phantom



The bottom plate contains three pair of bolts for locking the device holder. The device holder positions are adjusted to the standard measurement positions in the three sections. A white cover is provided to tap the phantom during off-periods to prevent water evaporation and changes in the liquid parameters. On the phantom top, three reference markers are provided to identify the phantom position with respect to the robot.

3. Tissue Simulating Liquid

3.1. The composition of the tissue simulating liquid

INGREDIENT (% Weight)	2450MHz Head	2450MHz Body
Water	46.7	73.2
Salt	0.00	0.04
Sugar	0.00	0.00
HEC	0.00	0.00
Preventol	0.00	0.00
DGBE	53.3	26.7
Triton X-100	0.00	0.00

3.2. Tissue Calibration Result

The dielectric parameters of the liquids were verified prior to the SAR evaluation using DASY5 Dielectric Probe Kit and Agilent Vector Network Analyzer E5071C

Body Tissue Simulant Measurement				
Frequency [MHz]	Description	Dielectric Parameters		Tissue Temp. [°C]
		ϵ_r	σ [s/m]	
2450MHz	Reference result ± 5% window	52.7 50.07 to 55.34	1.95 1.85 to 2.05	N/A
	22-04-2012	52.06	1.99	21.0

3.3. Tissue Dielectric Parameters for Head and Body Phantoms

The head tissue dielectric parameters recommended by the IEEE SCC-34/SC-2 in P1528 have been incorporated in the following table. These head parameters are derived from planar layer models simulating the highest expected SAR for the dielectric properties and tissue thickness variations in a human head. Other head and body tissue parameters that have not been specified in P1528 are derived from the tissue dielectric parameters computed from the 4-Cole-Cole equations described in Reference [12] and extrapolated according to the head parameters specified in P1528.

Target Frequency (MHz)	Head		Body	
	ϵ_r	σ (S/m)	ϵ_r	σ (S/m)
150	52.3	0.76	61.9	0.80
300	45.3	0.87	58.2	0.92
450	43.5	0.87	56.7	0.94
835	41.5	0.90	55.2	0.97
900	41.5	0.97	55.0	1.05
915	41.5	0.98	55.0	1.06
1450	40.5	1.20	54.0	1.30
1610	40.3	1.29	53.8	1.40
1800 – 2000	40.0	1.40	53.3	1.52
2450	39.2	1.80	52.7	1.95
3000	38.5	2.40	52.0	2.73
5800	35.3	5.27	48.2	6.00

(ϵ_r = relative permittivity, σ = conductivity and $\rho = 1000 \text{ kg/m}^3$)

4. SAR Measurement Procedure

4.1. SAR System Validation

4.1.1. Validation Dipoles

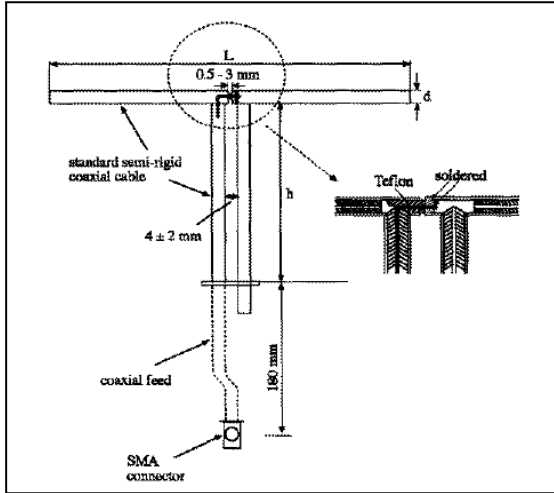

The dipoles used is based on the IEEE-1528 standard, and is complied with mechanical and electrical specifications in line with the requirements of both IEEE and FCC Supplement C. the table below provides details for the mechanical and electrical specifications for the dipoles.

Frequency	L (mm)	h (mm)	d (mm)
2450MHz	53.5	30.4	3.6

4.1.2. Validation Result

System Performance Check at 2450MHz				
Validation Dipole: D2450V2, SN: 839				
Frequency [MHz]	Description	SAR [w/kg] 1g	SAR [w/kg] 10g	Tissue Temp. [°C]
2450 MHz	Reference result ± 10% window	48.7 43.83 to 53.57	22.8 20.52 to 25.08	N/A
	22-04-2012	49.2	22.48	21.0

Note: All SAR values are normalized to 1W forward power.

4.2. SAR Measurement Procedure

The DAS5 calculates SAR using the following equation,

$$SAR = \frac{\sigma |E|^2}{\rho}$$

σ : represents the simulated tissue conductivity

ρ : represents the tissue density

The EUT is set to transmit at the required power in line with product specification, at each frequency relating to the LOW, MID, and HIGH channel settings.

Pre-scans are made on the device to establish the location for the transmitting antenna, using a large area scan in either air or tissue simulation fluid.

The EUT is placed against the Universal Phantom where the maximum area scan dimensions are larger than the physical size of the resonating antenna. When the scan size is not large enough to cover the peak SAR distribution, it is modified by either extending the area scan size in both the X and Y directions, or the device is shifted within the predefined area.

The area scan is then run to establish the peak SAR location (interpolated resolution set at 1mm²) which is then used to orient the center of the zoom scan. The zoom scan is then executed and the 1g and 10g averages are derived from the zoom scan volume (interpolated resolution set at 1mm³).

5. SAR Exposure Limits

SAR assessments have been made in line with the requirements of IEEE-1528, FCC Supplement C, and comply with ANSI/IEEE C95.1-1992 “Uncontrolled Environments” limits. These limits apply to a location which is deemed as “Uncontrolled Environment” which can be described as a situation where the general public may be exposed to an RF source with no prior knowledge or control over their exposure.

Limits for General Population/Uncontrolled Exposure (W/kg)

Type Exposure	Uncontrolled Environment Limit
Spatial Peak SAR (1g cube tissue for brain or body)	1.60 W/kg
Spatial Average SAR (whole body)	0.08 W/kg
Spatial Peak SAR (10g for hands, feet, ankles and wrist)	4.00 W/kg

6. Test Equipment List

Instrument	Manufacturer	Model No.	Serial No.	Cali. Due Date
Stäubli Robot TX60L	Stäubli	TX60L	F10/5C90A1/A/01	only once
Controller	Stäubli	SP1	S-0034	only once
Dipole Validation Kits	Speag	D2450V2	839	2013.02.23
SAM Twin Phantom	Speag	SAM	TP-1561/1562	N/A
Device Holder	Speag	SD 000 H01 HA	N/A	N/A
Data Acquisition Electronic	Speag	DAE4	1220	2013.01.23
E-Field Probe	Speag	EX3DV4	3710	2013.03.12
SAR Software	Speag	DASY5	V5.2 Build 162	N/A
Power Amplifier	Mini-Circuit	ZHL-42	D051404-28	N/A
Directional Coupler	Agilent	778D	20160	N/A
Universal Radio Communication Tester	R&S	CMU 200	117088	2013.04.18
Vector Network	Agilent	E5071C	MY48367267	2013.04.10
Signal Generator	Agilent	E4438C	MY49070163	2013.04.10
Power Meter	Anritsu	ML2495A	0905006	2013.01.12
Wide Bandwidth Sensor	Anritsu	MA2411B	0846014	2013.01.12

7. Measurement Uncertainty

DASY5 Uncertainty								
Measurement uncertainty for 300 MHz to 3 GHz averaged over 1 gram / 10 gram.								
Error Description	Uncert. value	Prob. Dist.	Div.	(ci) 1g	(ci) 10g	Std. Unc. (1g)	Std. Unc. (10g)	(vi) V _{eff}
Measurement System								
Probe Calibration	±6.0%	N	1	1	1	±6.0%	±6.0%	∞
Axial Isotropy	±4.7%	R	√3	0.7	0.7	±1.9%	±1.9%	∞
Hemispherical Isotropy	±9.6%	R	√3	0.7	0.7	±3.9%	±3.9%	∞
Boundary Effects	±1.0%	R	√3	1	1	±0.6%	±0.6%	∞
Linearity	±4.7%	R	√3	1	1	±2.7%	±2.7%	∞
System Detection Limits	±1.0%	R	√3	1	1	±0.6%	±0.6%	∞
Readout Electronics	±0.3%	N	1	1	1	±0.3%	±0.3%	∞
Response Time	±0.8%	R	√3	1	1	±0.5%	±0.5%	∞
Integration Time	±2.6%	R	√3	1	1	±1.5%	±1.5%	∞
RF Ambient Noise	±3.0%	R	√3	1	1	±1.7%	±1.7%	∞
RF Ambient Reflections	±3.0%	R	√3	1	1	±1.7%	±1.7%	∞
Probe Positioner	±0.4%	R	√3	1	1	±0.2%	±0.2%	∞
Probe Positioning	±2.9%	R	√3	1	1	±1.7%	±1.7%	∞
Max. SAR Eval.	±1.0%	R	√3	1	1	±0.6%	±0.6%	∞
Test Sample Related								
Device Positioning	±2.9%	N	1	1	1	±2.9%	±2.9%	145
Device Holder	±3.6%	N	1	1	1	±3.6%	±3.6%	5
Power Drift	±5.0%	R	√3	1	1	±2.9%	±2.9%	∞
Phantom and Setup								
Phantom Uncertainty	±4.0%	R	√3	1	1	±2.3%	±2.3%	∞
Liquid Conductivity (target)	±5.0%	R	√3	0.64	0.43	±1.8%	±1.2%	∞
Liquid Conductivity (meas.)	±2.5%	N	1	0.64	0.43	±1.6%	±1.1%	∞
Liquid Permittivity (target)	±5.0%	R	√3	0.6	0.49	±1.7%	±1.4%	∞
Liquid Permittivity (meas.)	±2.5%	N	1	0.6	0.49	±1.5%	±1.2%	∞
Combined Std. Uncertainty						±10.9%	±10.7%	387
Expanded STD Uncertainty						±21.9%	±21.4%	

8. Conducted Power Measurement

Test Mode	Data Rate (Mbps)	Channel No.	Frequency (MHz)	Average Power (dBm)
802.11b	1	01	2412	18.81
		06	2437	18.71
		11	2462	18.55
802.11g	6	01	2412	15.79
		06	2437	15.76
		11	2462	15.60
802.11n (20MHz)	6.5	01	2412	14.53
		06	2437	14.50
		11	2462	14.30
802.11n (40MHz)	13	03	2422	13.94
		06	2437	13.97
		09	2452	14.00

9. Test Procedures

9.1. Test position and configuration

SAR was performed with the device configured in the positions according to IEEE1528, and KDB 447498 D02 SAR Procedures for Dongle Xmtr v02, body SAR was performed with the device to phantom separation distance of 5mm. All USB orientations (A: Horizontal-Up, B: Horizontal-Down, C: Vertical-Front, D: Vertical-Back, and E: Tip) were evaluated with 15cm USB cable for extension. The antenna swivel angle (0°, 45°, 90°) were evaluated also. Please check the SAR test photos.

Other KDB files were referred for this device SAR evaluation: KDB 248227, KDB 388624 and KDB 302947.

9.2. SAR Test Results Summary

SAR MEASUREMENT							
Ambient Temperature (°C) : 21.5 ±2					Relative Humidity (%): 55		
Liquid Temperature (°C) : 21.0 ±2					Depth of Liquid (cm):>15		
Product: Wireless USB Adaptor							
Test Mode: 802.11b							
Test Position Body	Antenna Position	Frequency		Separation Distance (cm)	Power Drift (<±0.2)	SAR 1g (W/kg)	Limit (W/kg)
		Channel	MHz				
Horizontal Up (Laptop)	Straight	1	2412	0.5	-0.17	0.520	1.6
Horizontal Up (Laptop)	Swivel 0°	1	2412	0.5	-0.17	0.587	1.6
Horizontal Up (Laptop)	Swivel 0°	6	2437	0.5	-0.12	0.475	1.6
Horizontal Up (Laptop)	Swivel 0°	11	2462	0.5	-0.16	0.389	1.6
Horizontal Up (Laptop)	Swivel 45°	1	2412	0.5	-0.12	0.035	1.6
Horizontal Up (Laptop)	Swivel 90°	1	2412	0.5	-0.11	0.015	1.6
Horizontal Down (USB Cable)	Straight	1	2412	0.5	-0.05	0.343	1.6
Horizontal Down (USB Cable)	Swivel 0°	1	2412	0.5	0.13	0.290	1.6
Vertical Front (Laptop)	Straight	1	2412	0.5	-0.12	0.434	1.6
Vertical Front (Laptop)	Swivel 0°	1	2412	0.5	0.13	0.305	1.6
Vertical Front (Laptop)	Swivel 45°	1	2412	0.5	-0.12	0.033	1.6
Vertical Front (Laptop)	Swivel 90°	1	2412	0.5	0.10	0.014	1.6
Vertical Back (USB Cable)	Straight	1	2412	0.5	0.003	0.415	1.6
Vertical Back (USB Cable)	Swivel 0°	1	2412	0.5	-0.13	0.483	1.6

Tip (USB Cable)	Straight	1	2412	0.5	-0.12	0.010	1.6
Tip (USB Cable)	Swivel 45°	1	2412	0.5	-0.10	0.013	1.6
Tip (USB Cable)	Swivel 90°	1	2412	0.5	-0.13	0.429	1.6
Test Mode: 802.11g							
Horizontal Up (Laptop)	Swivel 0°	1	2412	0.5	0.004	0.189	1.6
Test Mode: 802.11n(20MHz)							
Horizontal Up (Laptop)	Swivel 0°	1	2412	0.5	-0.16	0.213	1.6
Test Mode: 802.11n(40MHz)							
Horizontal Up (Laptop)	Swivel 0°	9	2452	0.5	-0.15	0.219	1.6

Appendix A. SAR System Validation Data

Date/Time: 22-04-2012

Test Laboratory: QuieTek Lab

System Check Body 2450MHz

DUT: Dipole 2450 MHz D2450V2; Type: D2450V2

Communication System: CW; Communication System Band: D2450 (2450.0 MHz); Duty Cycle: 1:1;

Frequency: 2450 MHz; Medium parameters used: $f = 2450$ MHz; $\sigma = 1.99$ mho/m; $\epsilon_r = 52.06$; $\rho = 1000$ kg/m³; Phantom section: Flat Section ; Input Power=250mW

Ambient temperature (): 21.5, Liquid temperature (): 21.0

DASY5 Configuration:

- Probe: EX3DV4 - SN3710; ConvF(6.98, 6.98, 6.98); Calibrated: 12/03/2012
- Sensor-Surface: 4mm (Mechanical Surface Detection)
- Electronics: DAE4 Sn1220; Calibrated: 23/01/2012
- Phantom: SAM1; Type: SAM; Serial: TP1561
- Measurement SW: DASY52, Version 52.8 (0); SEMCAD X Version 14.6.4 (4989)

Configuration/System Check Body 2450MHz/Area Scan (7x11x1): Measurement grid: dx=10mm, dy=10mm, Maximum value of SAR (measured) = 13.408 mW/g

Configuration/System Check Body 2450MHz/Zoom Scan (7x7x7)/Cube 0: Measurement grid: dx=5mm, dy=5mm, dz=5mm, Reference Value = 81.585 V/m; Power Drift = 0.17 dB

Peak SAR (extrapolated) = 25.3510

SAR(1 g) = 12.3 mW/g; SAR(10 g) = 5.62 mW/g Maximum value of SAR (measured) = 14.054 mW/g

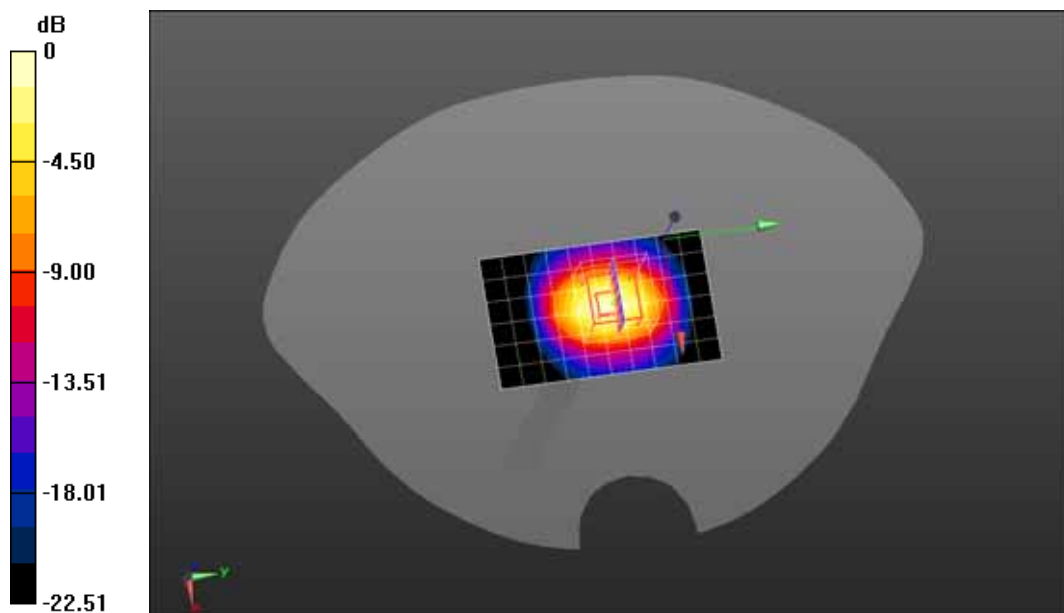

0 dB = 14.050mW/g = 22.95 dB mW/g

Appendix B. SAR measurement Data

Date/Time: 22-04-2012

Test Laboratory: QuieTek Lab

802.11b Low-Horizontal Up(Antenna Straight)

DUT: Wireless USB Adaptor; Type: GWF-3S4T

Communication System: Wi-Fi; Communication System Band: 802.11b; Duty Cycle: 1:1; Frequency: 2412 MHz; Medium parameters used: $f = 2412$ MHz; $\sigma = 1.94$ mho/m; $\epsilon_r = 52.23$; $\rho = 1000$ kg/m³; Phantom section: Flat Section

Ambient temperature (): 21.5, Liquid temperature (): 21.0

DASY5 Configuration:

- Probe: EX3DV4 - SN3710; ConvF(6.98, 6.98, 6.98); Calibrated: 12/03/2012
- Sensor-Surface: 4mm (Mechanical Surface Detection)
- Electronics: DAE4 Sn1220; Calibrated: 23/01/2012
- Phantom: SAM1; Type: SAM; Serial: TP1561
- Measurement SW: DASY52, Version 52.8 (0); SEMCAD X Version 14.6.4 (4989)

Configuration/802.11b Low-Horizontal Up/Area Scan (5x10x1): Measurement grid: dx=15mm, dy=15mm
Maximum value of SAR (measured) = 0.598 mW/g

Configuration/802.11b Low-Horizontal Up/Zoom Scan (5x5x7)/Cube 0: Measurement grid: dx=8mm, dy=8mm, dz=5mm, Reference Value = 22.148 V/m; Power Drift = -0.17 dB

Peak SAR (extrapolated) = 1.0970

SAR(1 g) = 0.520 mW/g; SAR(10 g) = 0.237 mW/g Maximum value of SAR (measured) = 0.583 mW/g

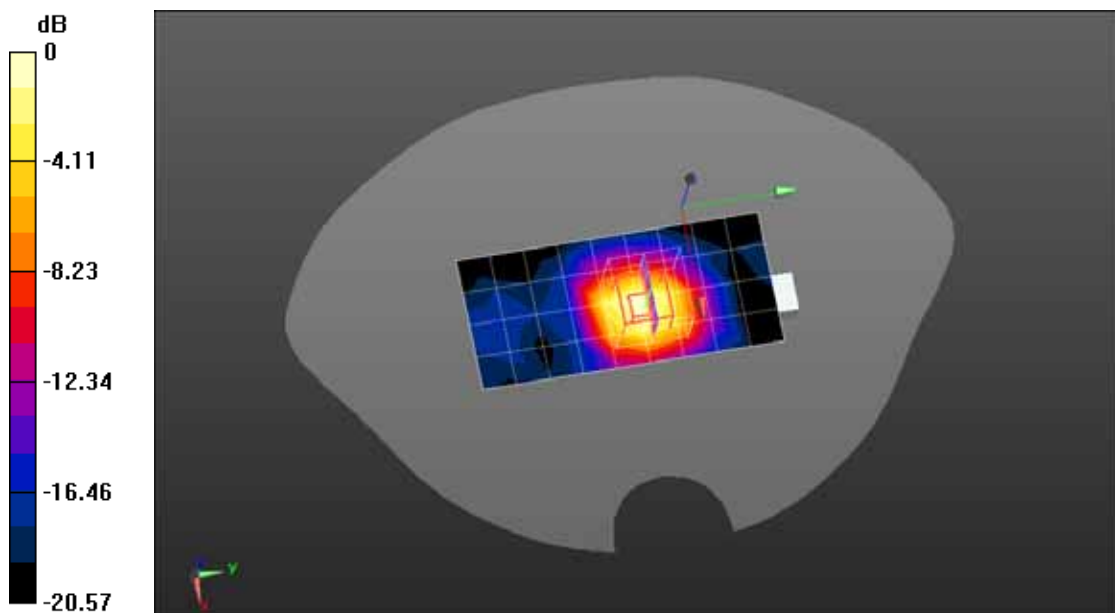

0 dB = 0.580mW/g = -4.73 dB mW/g

Date/Time: 22-04-2012

Test Laboratory: QuieTek Lab

802.11b Low-Horizontal Up(Antenna Swivel 0°)

DUT: Wireless USB Adaptor; Type: GWF-3S4T

Communication System: Wi-Fi; Communication System Band: 802.11b; Duty Cycle: 1:1; Frequency: 2412 MHz; Medium parameters used: $f = 2412$ MHz; $\sigma = 1.94$ mho/m; $\epsilon_r = 52.23$; $\rho = 1000$ kg/m³; Phantom section: Flat Section

Ambient temperature (): 21.5, Liquid temperature (): 21.0

DASY5 Configuration:

- Probe: EX3DV4 - SN3710; ConvF(6.98, 6.98, 6.98); Calibrated: 12/03/2012
- Sensor-Surface: 4mm (Mechanical Surface Detection)
- Electronics: DAE4 Sn1220; Calibrated: 23/01/2012
- Phantom: SAM1; Type: SAM; Serial: TP1561
- Measurement SW: DASY52, Version 52.8 (0); SEMCAD X Version 14.6.4 (4989)

Configuration/802.11b Low-Horizontal Up/Area Scan (8x5x1): Measurement grid: dx=15mm, dy=15mm

Maximum value of SAR (measured) = 0.603 mW/g

Configuration/802.11b Low-Horizontal Up/Zoom Scan (5x5x7)/Cube 0: Measurement grid: dx=8mm, dy=8mm, dz=5mm, Reference Value = 15.330 V/m; Power Drift = -0.17 dB

Peak SAR (extrapolated) = 1.2120

SAR(1 g) = 0.587 mW/g; SAR(10 g) = 0.272 mW/g Maximum value of SAR (measured) = 0.650 mW/g

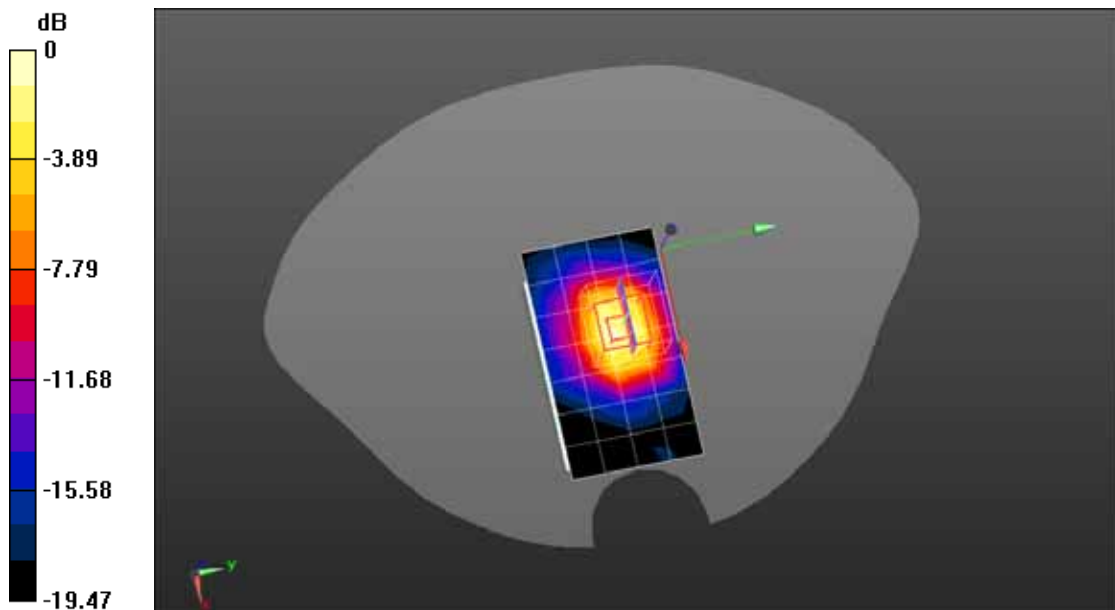

0 dB = 0.650mW/g = -3.74 dB mW/g

Z-Axis Plot

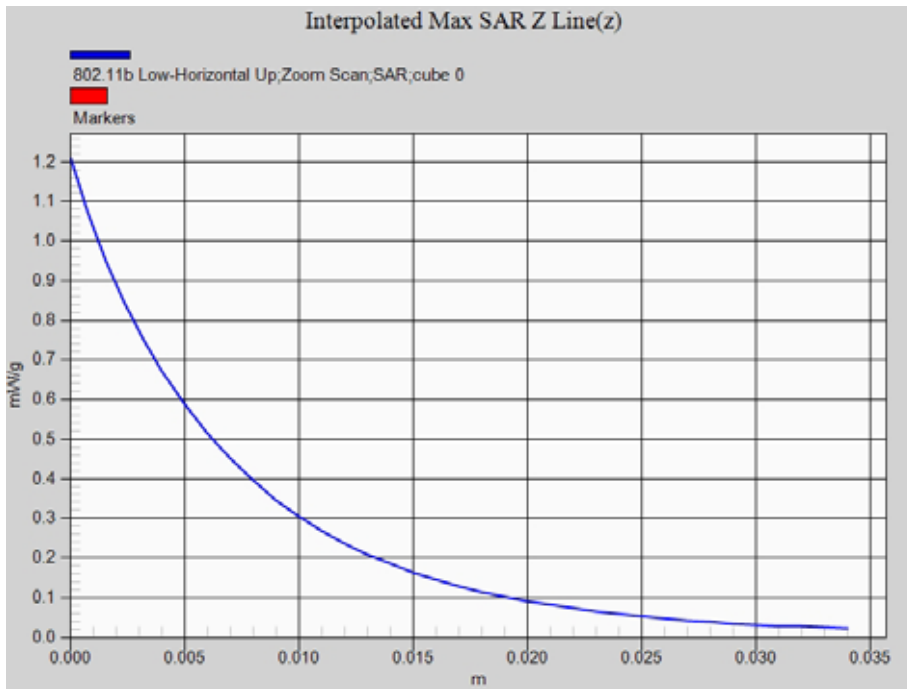

Date/Time: 22-04-2012

Test Laboratory: QuieTek Lab

802.11b Mid-Horizontal Up(Antenna Swivel 0°)

DUT: Wireless USB Adaptor; Type: GWF-3S4T

Communication System: Wi-Fi; Communication System Band: 802.11b; Duty Cycle: 1:1; Frequency: 2437 MHz; Medium parameters used: $f = 2437$ MHz; $\sigma = 1.98$ mho/m; $\epsilon_r = 52.15$; $\rho = 1000$ kg/m³; Phantom section: Flat Section

Ambient temperature (): 21.5, Liquid temperature (): 21.0

DASY5 Configuration:

- Probe: EX3DV4 - SN3710; ConvF(6.98, 6.98, 6.98); Calibrated: 12/03/2012
- Sensor-Surface: 4mm (Mechanical Surface Detection)
- Electronics: DAE4 Sn1220; Calibrated: 23/01/2012
- Phantom: SAM1; Type: SAM; Serial: TP1561
- Measurement SW: DASY52, Version 52.8 (0); SEMCAD X Version 14.6.4 (4989)

Configuration/802.11b Mid-Horizontal Up/Area Scan (8x5x1): Measurement grid: dx=15mm, dy=15mm

Maximum value of SAR (measured) = 0.524 mW/g

Configuration/802.11b Mid-Horizontal Up/Zoom Scan (5x5x7)/Cube 0: Measurement grid: dx=8mm, dy=8mm, dz=5mm, Reference Value = 15.580 V/m; Power Drift = -0.12 dB

Peak SAR (extrapolated) = 0.9780

SAR(1 g) = 0.475 mW/g; SAR(10 g) = 0.222 mW/g Maximum value of SAR (measured) = 0.531 mW/g

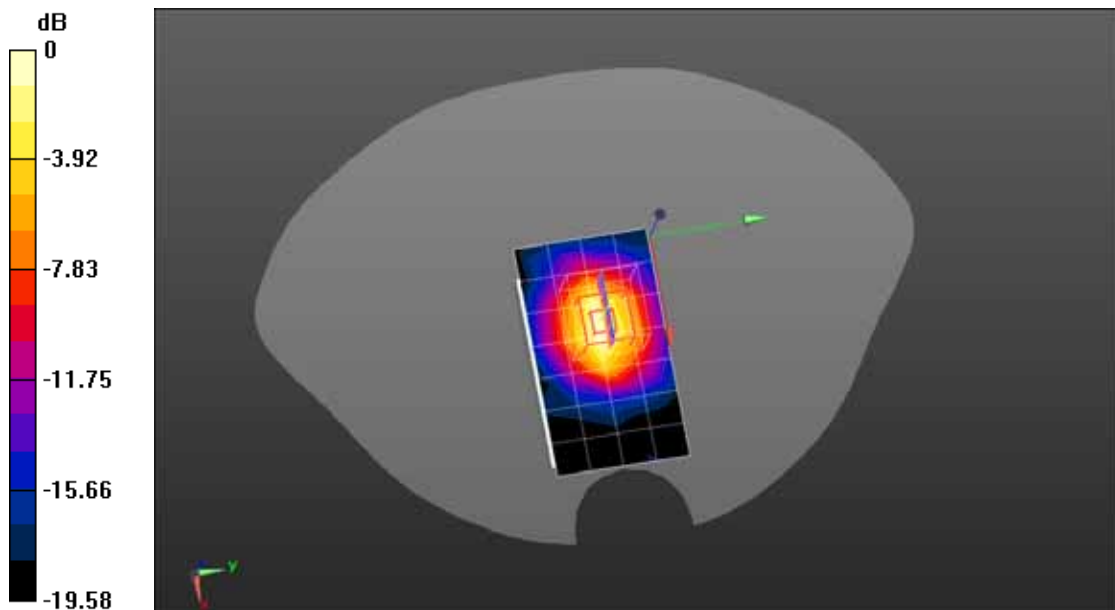

0 dB = 0.530mW/g = -5.51 dB mW/g

Date/Time: 22-04-2012

Test Laboratory: QuieTek Lab

802.11b High-Horizontal Up(Antenna Swivel 0°)

DUT: Wireless USB Adaptor; Type: GWF-3S4T

Communication System: Wi-Fi; Communication System Band: 802.11b; Duty Cycle: 1:1; Frequency: 2462 MHz; Medium parameters used: $f = 2462$ MHz; $\sigma = 2.01$ mho/m; $\epsilon_r = 51.98$; $\rho = 1000$ kg/m³; Phantom section: Flat Section

Ambient temperature (): 21.5, Liquid temperature (): 21.0

DASY5 Configuration:

- Probe: EX3DV4 - SN3710; ConvF(6.98, 6.98, 6.98); Calibrated: 12/03/2012
- Sensor-Surface: 4mm (Mechanical Surface Detection)
- Electronics: DAE4 Sn1220; Calibrated: 23/01/2012
- Phantom: SAM1; Type: SAM; Serial: TP1561
- Measurement SW: DASY52, Version 52.8 (0); SEMCAD X Version 14.6.4 (4989)

Configuration/802.11b High-Horizontal Up/Area Scan (8x5x1): Measurement grid: dx=15mm, dy=15mm

Maximum value of SAR (measured) = 0.413 mW/g

Configuration/802.11b High-Horizontal Up/Zoom Scan (5x5x7)/Cube 0: Measurement grid: dx=8mm, dy=8mm, dz=5mm, Reference Value = 13.456 V/m; Power Drift = -0.16 dB

Peak SAR (extrapolated) = 0.8110

SAR(1 g) = 0.389 mW/g; SAR(10 g) = 0.182 mW/g Maximum value of SAR (measured) = 0.436 mW/g

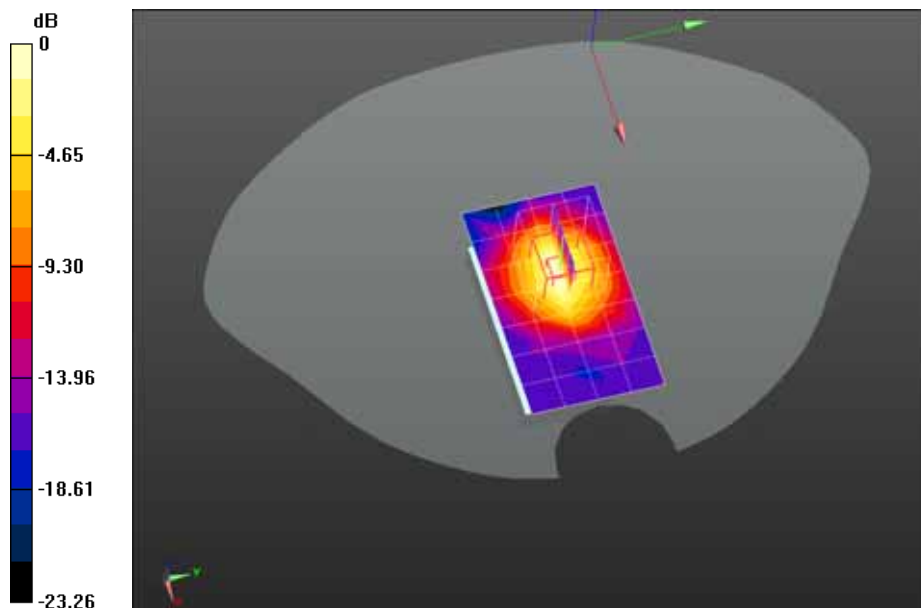

0 dB = 0.440mW/g = -7.13 dB mW/g

Date/Time: 22-04-2012

Test Laboratory: QuieTek Lab

802.11b Low-Horizontal Up(Antenna Swivel 45°)

DUT: Wireless USB Adaptor; Type: GWF-3S4T

Communication System: Wi-Fi; Communication System Band: 802.11b; Duty Cycle: 1:1; Frequency: 2412 MHz; Medium parameters used: $f = 2412$ MHz; $\sigma = 1.94$ mho/m; $\epsilon_r = 52.23$; $\rho = 1000$ kg/m³; Phantom section: Flat Section

Ambient temperature (): 21.5, Liquid temperature (): 21.0

DASY5 Configuration:

- Probe: EX3DV4 - SN3710; ConvF(6.98, 6.98, 6.98); Calibrated: 12/03/2012
- Sensor-Surface: 4mm (Mechanical Surface Detection)
- Electronics: DAE4 Sn1220; Calibrated: 23/01/2012
- Phantom: SAM1; Type: SAM; Serial: TP1561
- Measurement SW: DASY52, Version 52.8 (0); SEMCAD X Version 14.6.4 (4989)

Configuration/802.11b Low-Horizontal Up/Area Scan (8x5x1): Measurement grid: dx=15mm, dy=15mm

Maximum value of SAR (measured) = 0.041 mW/g

Configuration/802.11b Low-Horizontal Up/Zoom Scan (5x5x7)/Cube 0: Measurement grid: dx=8mm, dy=8mm, dz=5mm, Reference Value = 4.022 V/m; Power Drift = -0.12 dB

Peak SAR (extrapolated) = 0.0670

SAR(1 g) = 0.035 mW/g; SAR(10 g) = 0.021 mW/g Maximum value of SAR (measured) = 0.036 mW/g

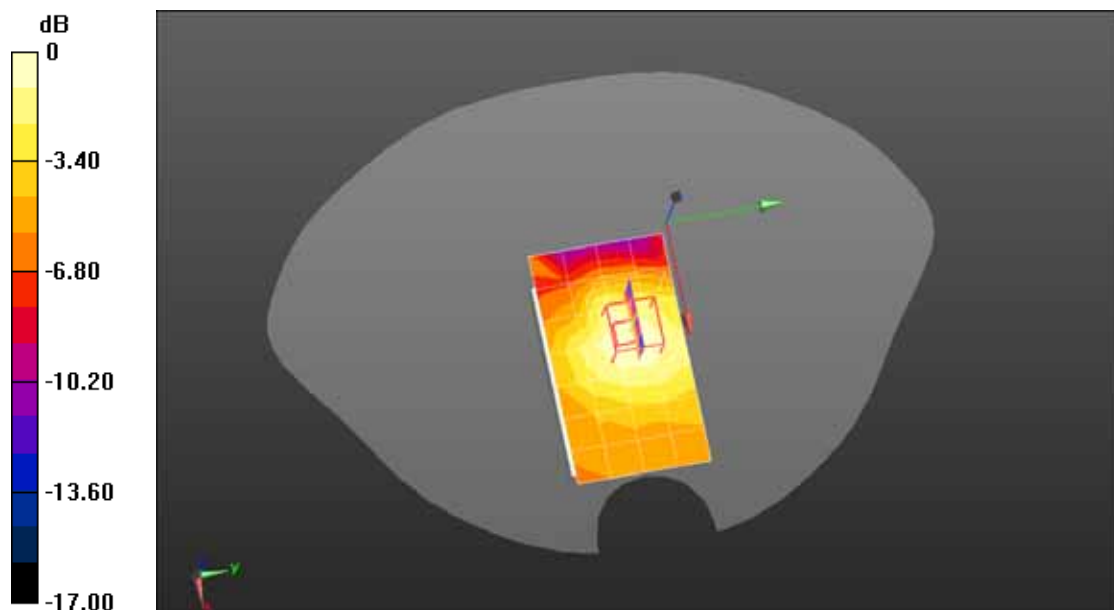

0 dB = 0.040mW/g = -27.96 dB mW/g

Date/Time: 22-04-2012

Test Laboratory: QuieTek Lab

802.11b Low-Horizontal Up(Antenna Swivel 90°)

DUT: Wireless USB Adaptor; Type: GWF-3S4T

Communication System: Wi-Fi; Communication System Band: 802.11b; Duty Cycle: 1:1; Frequency: 2412 MHz; Medium parameters used: $f = 2412$ MHz; $\sigma = 1.94$ mho/m; $\epsilon_r = 52.23$; $\rho = 1000$ kg/m³; Phantom section: Flat Section

Ambient temperature (): 21.5, Liquid temperature (): 21.0

DASY5 Configuration:

- Probe: EX3DV4 - SN3710; ConvF(6.98, 6.98, 6.98); Calibrated: 12/03/2012
- Sensor-Surface: 4mm (Mechanical Surface Detection)
- Electronics: DAE4 Sn1220; Calibrated: 23/01/2012
- Phantom: SAM1; Type: SAM; Serial: TP1561
- Measurement SW: DASY52, Version 52.8 (0); SEMCAD X Version 14.6.4 (4989)

Configuration/802.11b Low-Horizontal Up/Area Scan (7x7x1): Measurement grid: dx=15mm, dy=15mm

Maximum value of SAR (measured) = 0.012 mW/g

Configuration/802.11b Low-Horizontal Up/Zoom Scan (6x6x7)/Cube 0: Measurement grid: dx=8mm, dy=8mm, dz=5mm, Reference Value = 1.185 V/m; Power Drift = -0.11 dB

Peak SAR (extrapolated) = 0.0240

SAR(1 g) = 0.015 mW/g; SAR(10 g) = 0.011 mW/g Maximum value of SAR (measured) = 0.016 mW/g

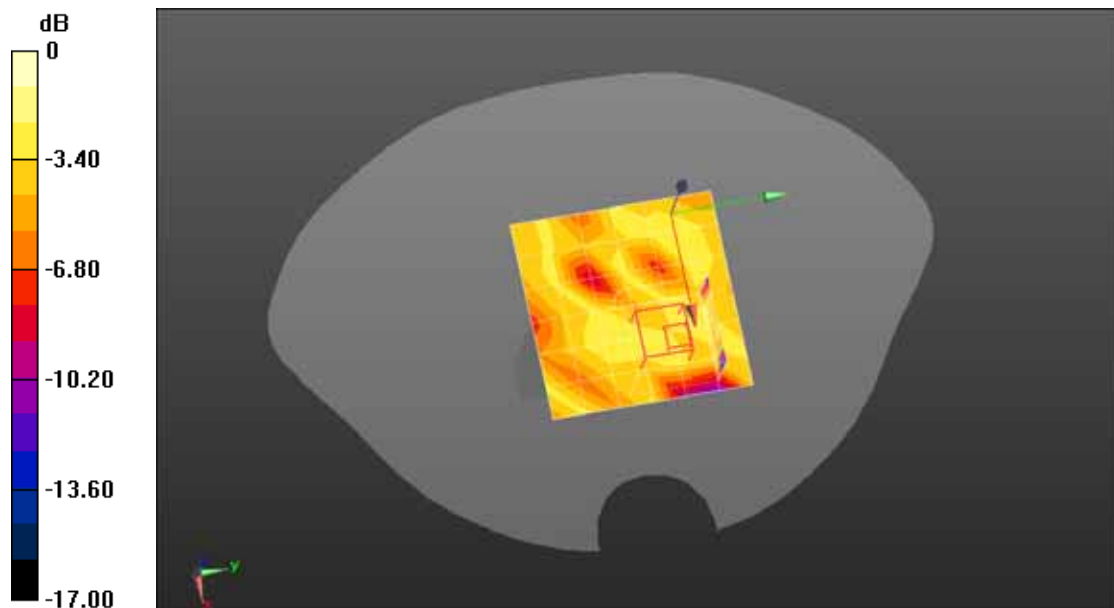

0 dB = 0.020mW/g = -33.98 dB mW/g

Date/Time: 22-04-2012

Test Laboratory: QuieTek Lab

802.11b Low-Horizontal Down(Antenna Straight)

DUT: Wireless USB Adaptor; Type: GWF-3S4T

Communication System: Wi-Fi; Communication System Band: 802.11b; Duty Cycle: 1:1; Frequency: 2412 MHz; Medium parameters used: $f = 2412$ MHz; $\sigma = 1.94$ mho/m; $\epsilon_r = 52.23$; $\rho = 1000$ kg/m³; Phantom section: Flat Section

Ambient temperature (): 21.5, Liquid temperature (): 21.0

DASY5 Configuration:

- Probe: EX3DV4 - SN3710; ConvF(6.98, 6.98, 6.98); Calibrated: 12/03/2012
- Sensor-Surface: 4mm (Mechanical Surface Detection)
- Electronics: DAE4 Sn1220; Calibrated: 23/01/2012
- Phantom: SAM1; Type: SAM; Serial: TP1561
- Measurement SW: DASY52, Version 52.8 (0); SEMCAD X Version 14.6.4 (4989)

Configuration/802.11b Low-Horizontal Down/Area Scan (5x10x1): Measurement grid: dx=15mm, dy=15mm, Maximum value of SAR (measured) = 0.327 mW/g

Configuration/802.11b Low-Horizontal Down/Zoom Scan (5x5x7)/Cube 0: Measurement grid: dx=8mm, dy=8mm, dz=5mm, Reference Value = 10.936 V/m; Power Drift = -0.05 dB

Peak SAR (extrapolated) = 0.6880

SAR(1 g) = 0.343 mW/g; SAR(10 g) = 0.164 mW/g Maximum value of SAR (measured) = 0.386 mW/g

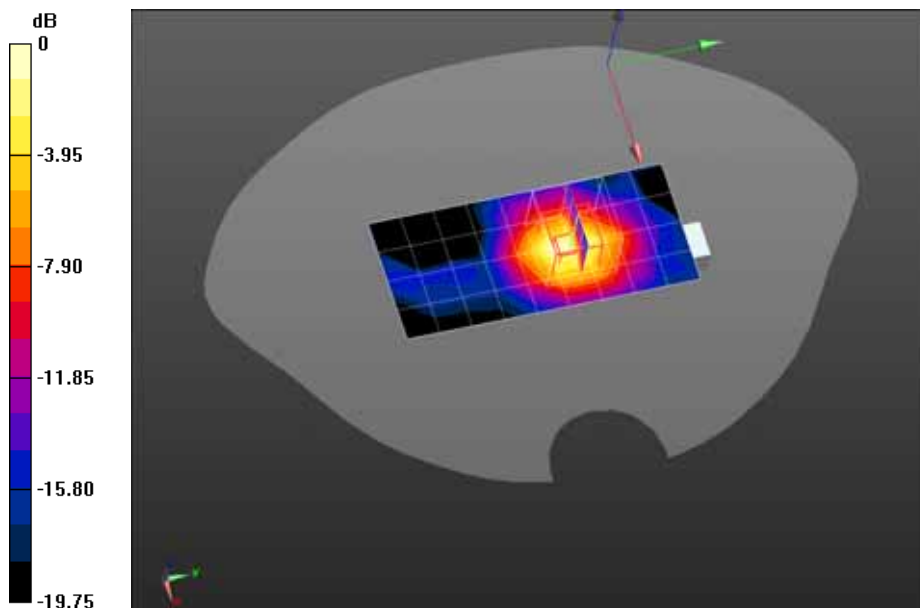

0 dB = 0.390mW/g = -8.18 dB mW/g

Date/Time: 22-04-2012

Test Laboratory: QuieTek Lab

802.11b Low-Horizontal Down(Antenna Swivel 0°)

DUT: Wireless USB Adaptor; Type: GWF-3S4T

Communication System: Wi-Fi; Communication System Band: 802.11b; Duty Cycle: 1:1; Frequency: 2412 MHz; Medium parameters used: $f = 2412$ MHz; $\sigma = 1.94$ mho/m; $\epsilon_r = 52.23$; $\rho = 1000$ kg/m³; Phantom section: Flat Section

Ambient temperature (): 21.5, Liquid temperature (): 21.0

DASY5 Configuration:

- Probe: EX3DV4 - SN3710; ConvF(6.98, 6.98, 6.98); Calibrated: 12/03/2012
- Sensor-Surface: 4mm (Mechanical Surface Detection)
- Electronics: DAE4 Sn1220; Calibrated: 23/01/2012
- Phantom: SAM1; Type: SAM; Serial: TP1561
- Measurement SW: DASY52, Version 52.8 (0); SEMCAD X Version 14.6.4 (4989)

Configuration/802.11b Low-Horizontal Down/Area Scan (8x5x1): Measurement grid: dx=15mm, dy=15mm, Maximum value of SAR (measured) = 0.255 mW/g

Configuration/802.11b Low-Horizontal Down/Zoom Scan (5x5x7)/Cube 0: Measurement grid: dx=8mm, dy=8mm, dz=5mm, Reference Value = 6.691 V/m; Power Drift = 0.13 dB

Peak SAR (extrapolated) = 0.5720

SAR(1 g) = 0.290 mW/g; SAR(10 g) = 0.141 mW/g Maximum value of SAR (measured) = 0.326 mW/g

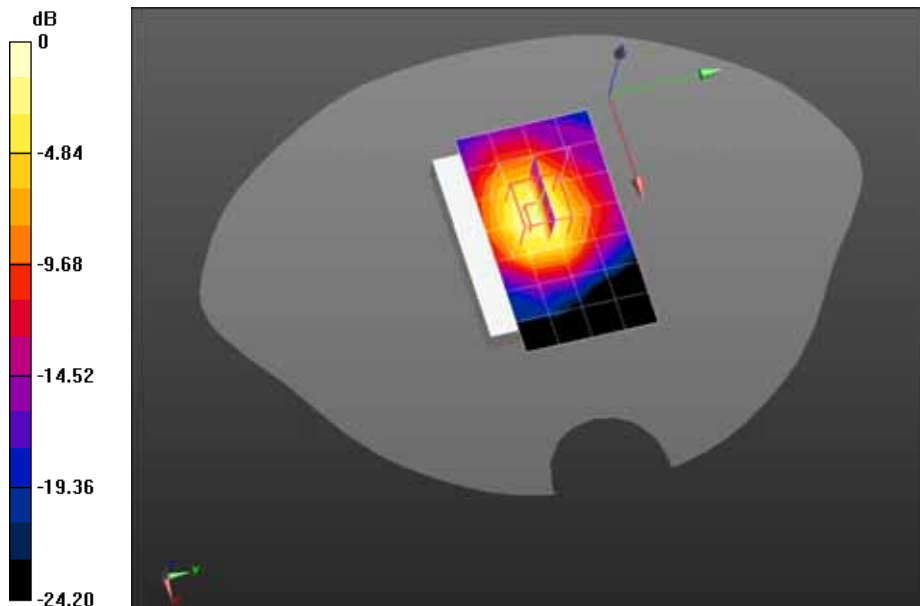

0 dB = 0.330mW/g = -9.63 dB mW/g

Date/Time: 23-04-2012

Test Laboratory: QuieTek Lab

802.11b Low-Vertical Front(Antenna Straight)

DUT: Wireless USB Adaptor; Type: GWF-3S4T

Communication System: Wi-Fi; Communication System Band: 802.11b; Duty Cycle: 1:1; Frequency: 2412 MHz; Medium parameters used: $f = 2412$ MHz; $\sigma = 1.94$ mho/m; $\epsilon_r = 52.23$; $\rho = 1000$ kg/m³; Phantom section: Flat Section

Ambient temperature (): 21.5, Liquid temperature (): 21.0

DASY5 Configuration:

- Probe: EX3DV4 - SN3710; ConvF(6.98, 6.98, 6.98); Calibrated: 12/03/2012
- Sensor-Surface: 4mm (Mechanical Surface Detection)
- Electronics: DAE4 Sn1220; Calibrated: 23/01/2012
- Phantom: SAM1; Type: SAM; Serial: TP1561
- Measurement SW: DASY52, Version 52.8 (0); SEMCAD X Version 14.6.4 (4989)

Configuration/802.11b Low-Vertical Front/Area Scan (5x10x1): Measurement grid: dx=15mm, dy=15mm

Maximum value of SAR (measured) = 0.454 mW/g

Configuration/802.11b Low-Vertical Front/Zoom Scan (5x5x7)/Cube 0: Measurement grid: dx=8mm, dy=8mm, dz=5mm, Reference Value = 15.558 V/m; Power Drift = -0.12 dB

Peak SAR (extrapolated) = 0.9160

SAR(1 g) = 0.434 mW/g; SAR(10 g) = 0.197 mW/g Maximum value of SAR (measured) = 0.491 mW/g

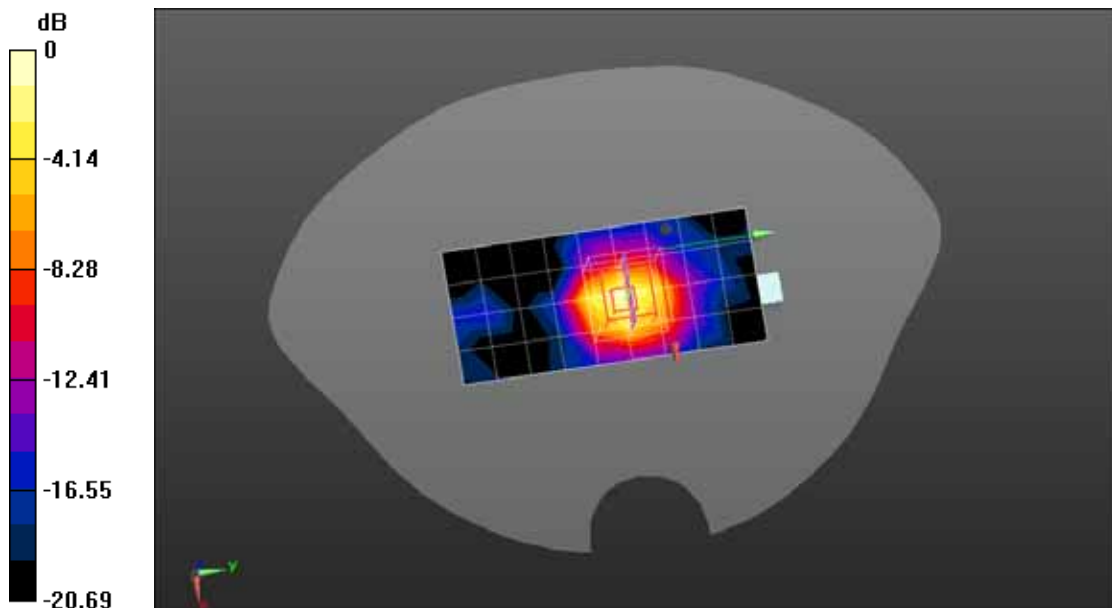

0 dB = 0.490mW/g = -6.20 dB mW/g

Date/Time: 23-04-2012

Test Laboratory: QuieTek Lab

802.11b Low-Vertical Front(Antenna Swivel 0°)

DUT: Wireless USB Adaptor; Type: GWF-3S4T

Communication System: Wi-Fi; Communication System Band: 802.11b; Duty Cycle: 1:1; Frequency: 2412 MHz; Medium parameters used: $f = 2412$ MHz; $\sigma = 1.94$ mho/m; $\epsilon_r = 52.23$; $\rho = 1000$ kg/m³; Phantom section: Flat Section

Ambient temperature (): 21.5, Liquid temperature (): 21.0

DASY5 Configuration:

- Probe: EX3DV4 - SN3710; ConvF(6.98, 6.98, 6.98); Calibrated: 12/03/2012
- Sensor-Surface: 4mm (Mechanical Surface Detection)
- Electronics: DAE4 Sn1220; Calibrated: 23/01/2012
- Phantom: SAM1; Type: SAM; Serial: TP1561
- Measurement SW: DASY52, Version 52.8 (0); SEMCAD X Version 14.6.4 (4989)

Configuration/802.11b Low-Vertical Front/Area Scan (8x5x1): Measurement grid: dx=15mm, dy=15mm

Maximum value of SAR (measured) = 0.249 mW/g

Configuration/802.11b Low-Vertical Front/Zoom Scan (5x5x7)/Cube 0: Measurement grid: dx=8mm, dy=8mm, dz=5mm, Reference Value = 8.100 V/m; Power Drift = 0.13 dB

Peak SAR (extrapolated) = 0.6210

SAR(1 g) = 0.305 mW/g; SAR(10 g) = 0.147 mW/g Maximum value of SAR (measured) = 0.337 mW/g

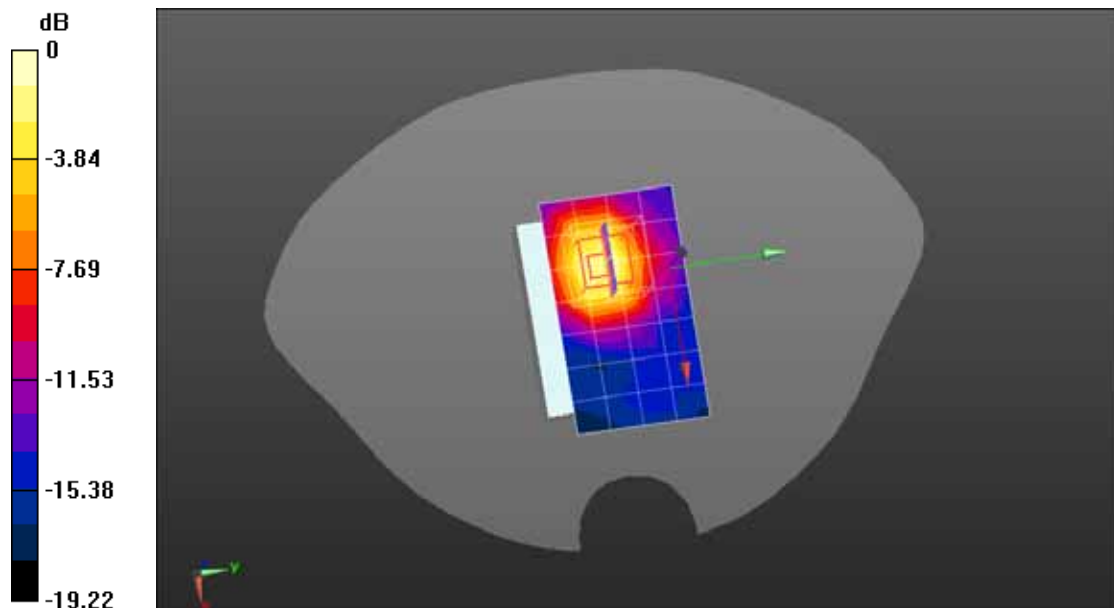

0 dB = 0.340mW/g = -9.37 dB mW/g

Date/Time: 23-04-2012

Test Laboratory: QuieTek Lab

802.11b Low-Vertical Front(Antenna Swivel 45°)

DUT: Wireless USB Adaptor; Type: GWF-3S4T

Communication System: Wi-Fi; Communication System Band: 802.11b; Duty Cycle: 1:1; Frequency: 2412 MHz; Medium parameters used: $f = 2412$ MHz; $\sigma = 1.94$ mho/m; $\epsilon_r = 52.23$; $\rho = 1000$ kg/m³; Phantom section: Flat Section

Ambient temperature (): 21.5, Liquid temperature (): 21.0

DASY5 Configuration:

- Probe: EX3DV4 - SN3710; ConvF(6.98, 6.98, 6.98); Calibrated: 12/03/2012
- Sensor-Surface: 4mm (Mechanical Surface Detection)
- Electronics: DAE4 Sn1220; Calibrated: 23/01/2012
- Phantom: SAM1; Type: SAM; Serial: TP1561
- Measurement SW: DASY52, Version 52.8 (0); SEMCAD X Version 14.6.4 (4989)

Configuration/802.11b Low-Vertical Front/Area Scan (8x5x1): Measurement grid: dx=15mm, dy=15mm

Maximum value of SAR (measured) = 0.028 mW/g

Configuration/802.11b Low-Vertical Front/Zoom Scan (5x5x7)/Cube 0: Measurement grid: dx=8mm, dy=8mm, dz=5mm, Reference Value = 3.110 V/m; Power Drift = -0.12 dB

Peak SAR (extrapolated) = 0.0650

SAR(1 g) = 0.033 mW/g; SAR(10 g) = 0.020 mW/g Maximum value of SAR (measured) = 0.035 mW/g

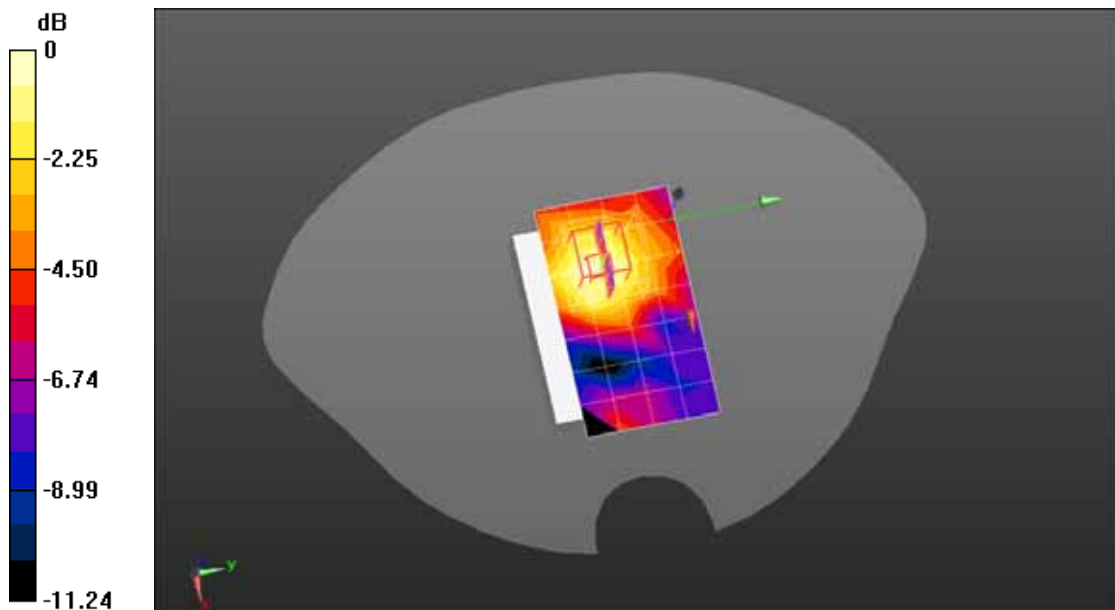

0 dB = 0.030mW/g = -30.46 dB mW/g

Date/Time: 23-04-2012

Test Laboratory: QuieTek Lab

802.11b Low-Vertical Front(Antenna Swivel 90°)

DUT: Wireless USB Adaptor; Type: GWF-3S4T

Communication System: Wi-Fi; Communication System Band: 802.11b; Duty Cycle: 1:1; Frequency: 2412 MHz; Medium parameters used: $f = 2412$ MHz; $\sigma = 1.94$ mho/m; $\epsilon_r = 52.23$; $\rho = 1000$ kg/m³; Phantom section: Flat Section

Ambient temperature (): 21.5, Liquid temperature (): 21.0

DASY5 Configuration:

- Probe: EX3DV4 - SN3710; ConvF(6.98, 6.98, 6.98); Calibrated: 12/03/2012
- Sensor-Surface: 4mm (Mechanical Surface Detection)
- Electronics: DAE4 Sn1220; Calibrated: 23/01/2012
- Phantom: SAM1; Type: SAM; Serial: TP1561
- Measurement SW: DASY52, Version 52.8 (0); SEMCAD X Version 14.6.4 (4989)

Configuration/802.11b Low-Vertical Front/Area Scan (7x7x1): Measurement grid: dx=15mm, dy=15mm

Maximum value of SAR (measured) = 0.013 mW/g

Configuration/802.11b Low-Vertical Front/Zoom Scan (5x6x7)/Cube 0: Measurement grid: dx=8mm, dy=8mm, dz=5mm, Reference Value = 1.729 V/m; Power Drift = 0.10 dB

Peak SAR (extrapolated) = 0.0280

SAR(1 g) = 0.014 mW/g; SAR(10 g) = 0.010 mW/g Maximum value of SAR (measured) = 0.017 mW/g

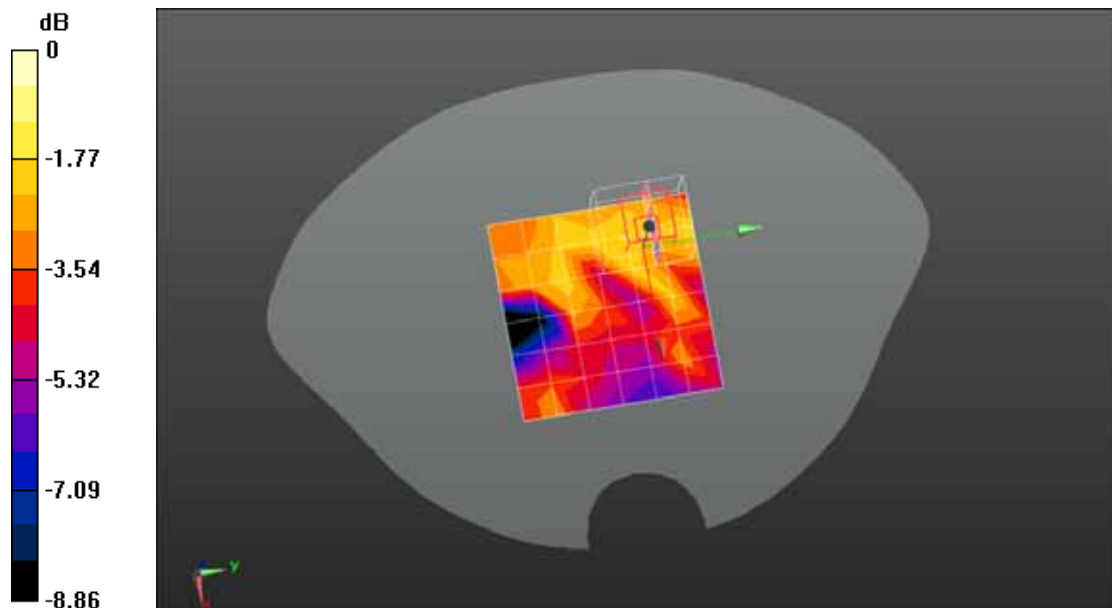

0 dB = 0.020mW/g = -33.98 dB mW/g

Date/Time: 23-04-2012

Test Laboratory: QuieTek Lab

802.11b Low-Vertical Back(Antenna Straight)

DUT: Wireless USB Adaptor; Type: GWF-3S4T

Communication System: Wi-Fi; Communication System Band: 802.11b; Duty Cycle: 1:1; Frequency: 2412 MHz; Medium parameters used: $f = 2412$ MHz; $\sigma = 1.94$ mho/m; $\epsilon_r = 52.23$; $\rho = 1000$ kg/m³; Phantom section: Flat Section

Ambient temperature (): 21.5, Liquid temperature (): 21.0

DASY5 Configuration:

- Probe: EX3DV4 - SN3710; ConvF(6.98, 6.98, 6.98); Calibrated: 12/03/2012
- Sensor-Surface: 4mm (Mechanical Surface Detection)
- Electronics: DAE4 Sn1220; Calibrated: 23/01/2012
- Phantom: SAM1; Type: SAM; Serial: TP1561
- Measurement SW: DASY52, Version 52.8 (0); SEMCAD X Version 14.6.4 (4989)

Configuration/802.11b Low-Vertical Back/Area Scan (5x10x1): Measurement grid: dx=15mm, dy=15mm

Maximum value of SAR (measured) = 0.292 mW/g

Configuration/802.11b Low-Vertical Back/Zoom Scan (5x5x7)/Cube 0: Measurement grid: dx=8mm, dy=8mm, dz=5mm, Reference Value = 11.681 V/m; Power Drift = 0.003 dB

Peak SAR (extrapolated) = 0.8730

SAR(1 g) = 0.415 mW/g; SAR(10 g) = 0.190 mW/g Maximum value of SAR (measured) = 0.465 mW/g

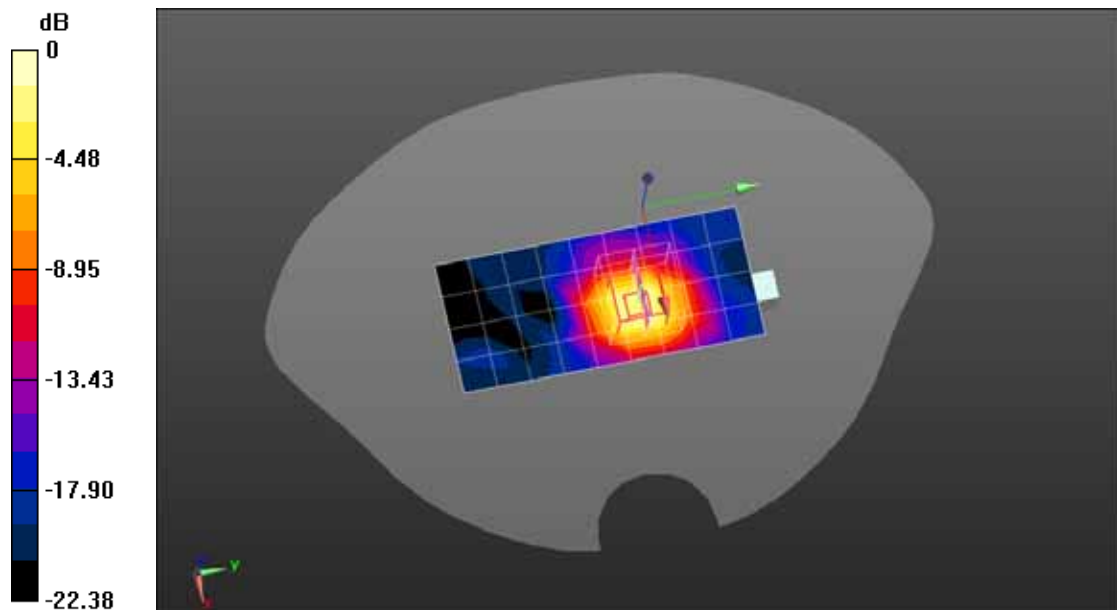

0 dB = 0.460mW/g = -6.74 dB mW/g

Date/Time: 23-04-2012

Test Laboratory: QuieTek Lab

802.11b Low-Vertical Back(Antenna Swivel 0°)

DUT: Wireless USB Adaptor; Type: GWF-3S4T

Communication System: Wi-Fi; Communication System Band: 802.11b; Duty Cycle: 1:1; Frequency: 2412 MHz; Medium parameters used: $f = 2412$ MHz; $\sigma = 1.94$ mho/m; $\epsilon_r = 52.23$; $\rho = 1000$ kg/m³; Phantom section: Flat Section

Ambient temperature (): 21.5, Liquid temperature (): 21.0

DASY5 Configuration:

- Probe: EX3DV4 - SN3710; ConvF(6.98, 6.98, 6.98); Calibrated: 12/03/2012
- Sensor-Surface: 4mm (Mechanical Surface Detection)
- Electronics: DAE4 Sn1220; Calibrated: 23/01/2012
- Phantom: SAM1; Type: SAM; Serial: TP1561
- Measurement SW: DASY52, Version 52.8 (0); SEMCAD X Version 14.6.4 (4989)

Configuration/802.11b Low-Vertical Back/Area Scan (8x5x1): Measurement grid: dx=15mm, dy=15mm

Maximum value of SAR (measured) = 0.577 mW/g

Configuration/802.11b Low-Vertical Back/Zoom Scan (5x5x7)/Cube 0: Measurement grid: dx=8mm, dy=8mm, dz=5mm, Reference Value = 11.540 V/m; Power Drift = -0.13 dB

Peak SAR (extrapolated) = 0.9820

SAR(1 g) = 0.483 mW/g; SAR(10 g) = 0.229 mW/g Maximum value of SAR (measured) = 0.540 mW/g

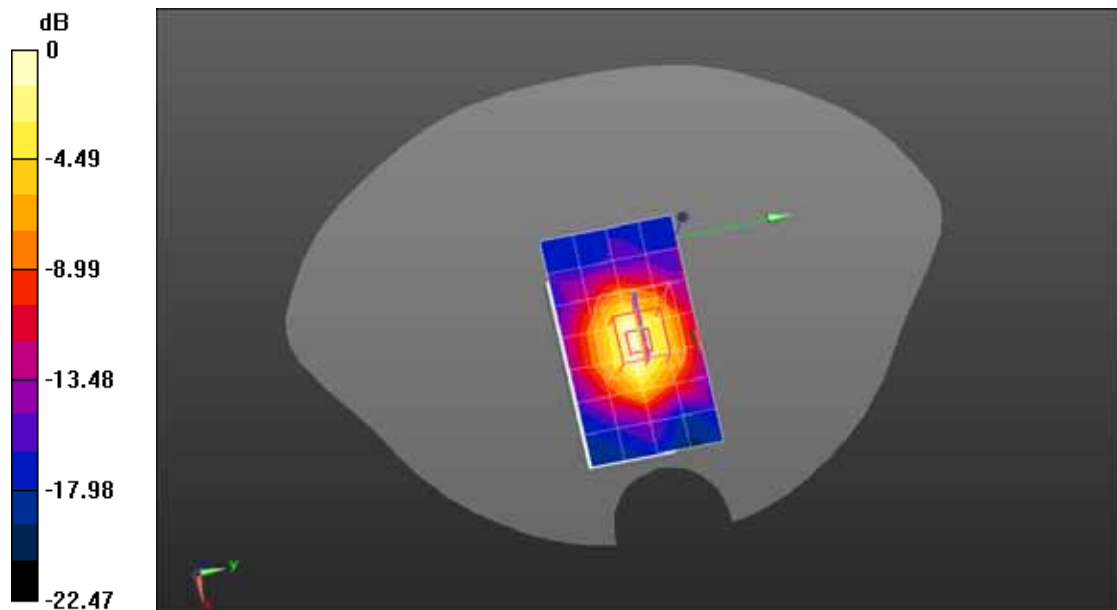

0 dB = 0.540mW/g = -5.35 dB mW/g

Date/Time: 23-04-2012

Test Laboratory: QuieTek Lab

802.11b Low-Tip(Antenna Straight)

DUT: Wireless USB Adaptor; Type: GWF-3S4T

Communication System: Wi-Fi; Communication System Band: 802.11b; Duty Cycle: 1:1; Frequency: 2412 MHz; Medium parameters used: $f = 2412$ MHz; $\sigma = 1.94$ mho/m; $\epsilon_r = 52.23$; $\rho = 1000$ kg/m³; Phantom section: Flat Section

Ambient temperature (): 21.5, Liquid temperature (): 21.0

DASY5 Configuration:

- Probe: EX3DV4 - SN3710; ConvF(6.98, 6.98, 6.98); Calibrated: 12/03/2012
- Sensor-Surface: 4mm (Mechanical Surface Detection)
- Electronics: DAE4 Sn1220; Calibrated: 23/01/2012
- Phantom: SAM1; Type: SAM; Serial: TP1561
- Measurement SW: DASY52, Version 52.8 (0); SEMCAD X Version 14.6.4 (4989)

Configuration/802.11b Low-Tip/Area Scan (6x6x1): Measurement grid: dx=15mm, dy=15mm

Maximum value of SAR (measured) = 0.010 mW/g

Configuration/802.11b Low-Tip/Zoom Scan (6x6x7)/Cube 0: Measurement grid: dx=8mm, dy=8mm, dz=5mm, Reference Value = 0.334 V/m; Power Drift = -0.12 dB

Peak SAR (extrapolated) = 0.0430

SAR(1 g) = 0.010 mW/g; SAR(10 g) = 0.00513 mW/g Maximum value of SAR (measured) = 0.00972 mW/g

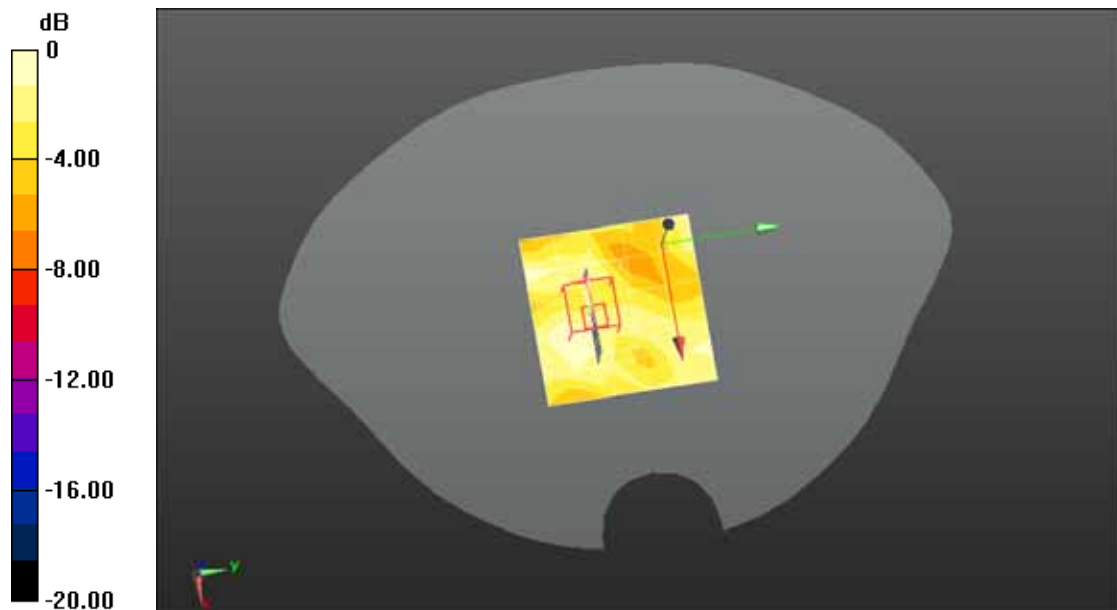

0 dB = 0.0097mW/g = -40.26 dB mW/g

Date/Time: 23-04-2012

Test Laboratory: QuieTek Lab

802.11b Low-Tip (Antenna Swivel 45°)

DUT: Wireless USB Adaptor; Type: GWF-3S4T

Communication System: Wi-Fi; Communication System Band: 802.11b; Duty Cycle: 1:1; Frequency: 2412 MHz; Medium parameters used: $f = 2412$ MHz; $\sigma = 1.94$ mho/m; $\epsilon_r = 52.23$; $\rho = 1000$ kg/m³; Phantom section: Flat Section

Ambient temperature (): 21.5, Liquid temperature (): 21.0

DASY5 Configuration:

- Probe: EX3DV4 - SN3710; ConvF(6.98, 6.98, 6.98); Calibrated: 12/03/2012
- Sensor-Surface: 4mm (Mechanical Surface Detection)
- Electronics: DAE4 Sn1220; Calibrated: 23/01/2012
- Phantom: SAM1; Type: SAM; Serial: TP1561
- Measurement SW: DASY52, Version 52.8 (0); SEMCAD X Version 14.6.4 (4989)

Configuration/802.11b Low-Tip/Area Scan (8x5x1): Measurement grid: dx=15mm, dy=15mm

Maximum value of SAR (measured) = 0.016 mW/g

Configuration/802.11b Low-Tip/Zoom Scan (5x5x7)/Cube 0: Measurement grid: dx=8mm, dy=8mm, dz=5mm, Reference Value = 2.089 V/m; Power Drift = -0.10 dB

Peak SAR (extrapolated) = 0.0340

SAR(1 g) = 0.013 mW/g; SAR(10 g) = 0.00655 mW/g Maximum value of SAR (measured) = 0.014 mW/g

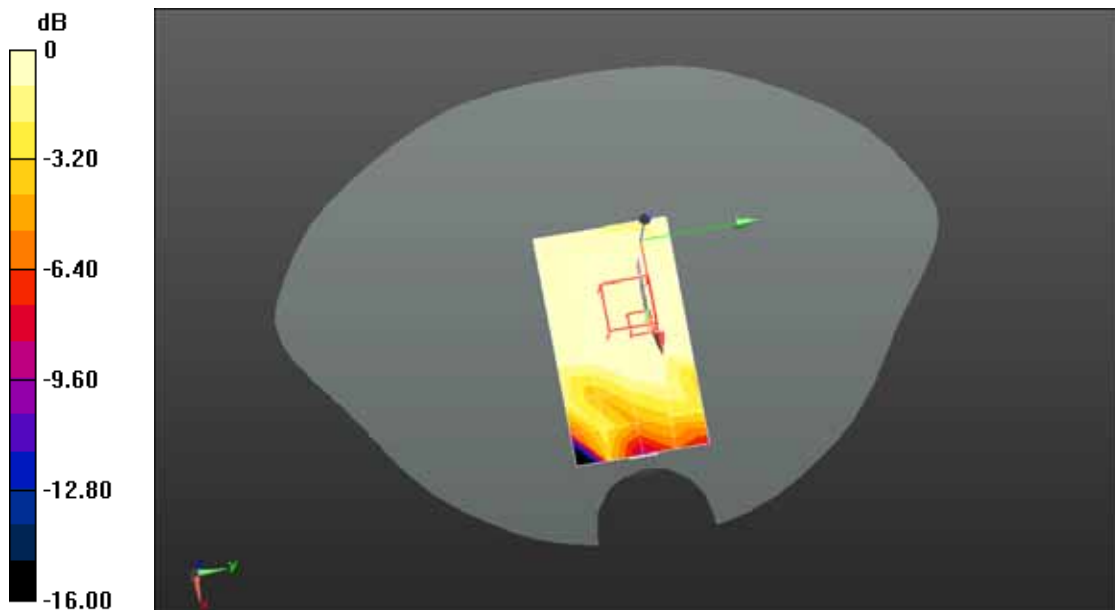

0 dB = 0.010mW/g = -40.00 dB mW/g

Date/Time: 23-04-2012

Test Laboratory: QuieTek Lab

802.11b Low-Tip (Antenna Swivel 90°)

DUT: Wireless USB Adaptor; Type: GWF-3S4T

Communication System: Wi-Fi; Communication System Band: 802.11b; Duty Cycle: 1:1; Frequency: 2412 MHz; Medium parameters used: $f = 2412$ MHz; $\sigma = 1.94$ mho/m; $\epsilon_r = 52.23$; $\rho = 1000$ kg/m³; Phantom section: Flat Section

Ambient temperature (): 21.5, Liquid temperature (): 21.0

DASY5 Configuration:

- Probe: EX3DV4 - SN3710; ConvF(6.98, 6.98, 6.98); Calibrated: 12/03/2012
- Sensor-Surface: 4mm (Mechanical Surface Detection)
- Electronics: DAE4 Sn1220; Calibrated: 23/01/2012
- Phantom: SAM1; Type: SAM; Serial: TP1561
- Measurement SW: DASY52, Version 52.8 (0); SEMCAD X Version 14.6.4 (4989)

Configuration/802.11b Low-Tip/Area Scan (8x5x1): Measurement grid: dx=15mm, dy=15mm

Maximum value of SAR (measured) = 0.467 mW/g

Configuration/802.11b Low-Tip/Zoom Scan (5x5x7)/Cube 0: Measurement grid: dx=8mm, dy=8mm, dz=5mm, Reference Value = 11.499 V/m; Power Drift = -0.13 dB

Peak SAR (extrapolated) = 0.8660

SAR(1 g) = 0.429 mW/g; SAR(10 g) = 0.201 mW/g Maximum value of SAR (measured) = 0.476 mW/g

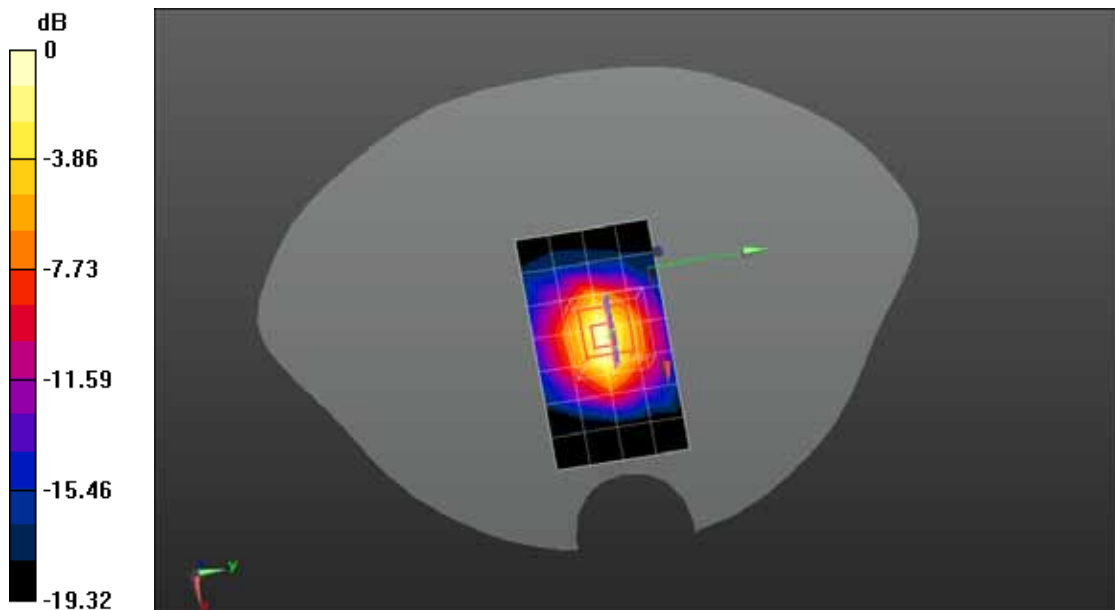

0 dB = 0.480mW/g = -6.38 dB mW/g

Date/Time: 23-04-2012

Test Laboratory: QuieTek Lab

802.11g Low-Horizontal Up(Antenna Swivel 0°)

DUT: Wireless USB Adaptor; Type: GWF-3S4T

Communication System: Wi-Fi; Communication System Band: 802.11g; Duty Cycle: 1:1; Frequency: 2412 MHz; Medium parameters used: $f = 2412$ MHz; $\sigma = 1.94$ mho/m; $\epsilon_r = 52.23$; $\rho = 1000$ kg/m³; Phantom section: Flat Section

Ambient temperature (): 21.5, Liquid temperature (): 21.0

DASY5 Configuration:

- Probe: EX3DV4 - SN3710; ConvF(6.98, 6.98, 6.98); Calibrated: 12/03/2012
- Sensor-Surface: 4mm (Mechanical Surface Detection)
- Electronics: DAE4 Sn1220; Calibrated: 23/01/2012
- Phantom: SAM1; Type: SAM; Serial: TP1561
- Measurement SW: DASY52, Version 52.8 (0); SEMCAD X Version 14.6.4 (4989)

Configuration/802.11g Low-Horizontal Up/Area Scan (8x5x1): Measurement grid: dx=15mm, dy=15mm

Maximum value of SAR (measured) = 0.198 mW/g

Configuration/802.11g Low-Horizontal Up/Zoom Scan (5x5x7)/Cube 0: Measurement grid: dx=8mm, dy=8mm, dz=5mm, Reference Value = 8.773 V/m; Power Drift = 0.004 dB

Peak SAR (extrapolated) = 0.3840

SAR(1 g) = 0.189 mW/g; SAR(10 g) = 0.089 mW/g Maximum value of SAR (measured) = 0.215 mW/g

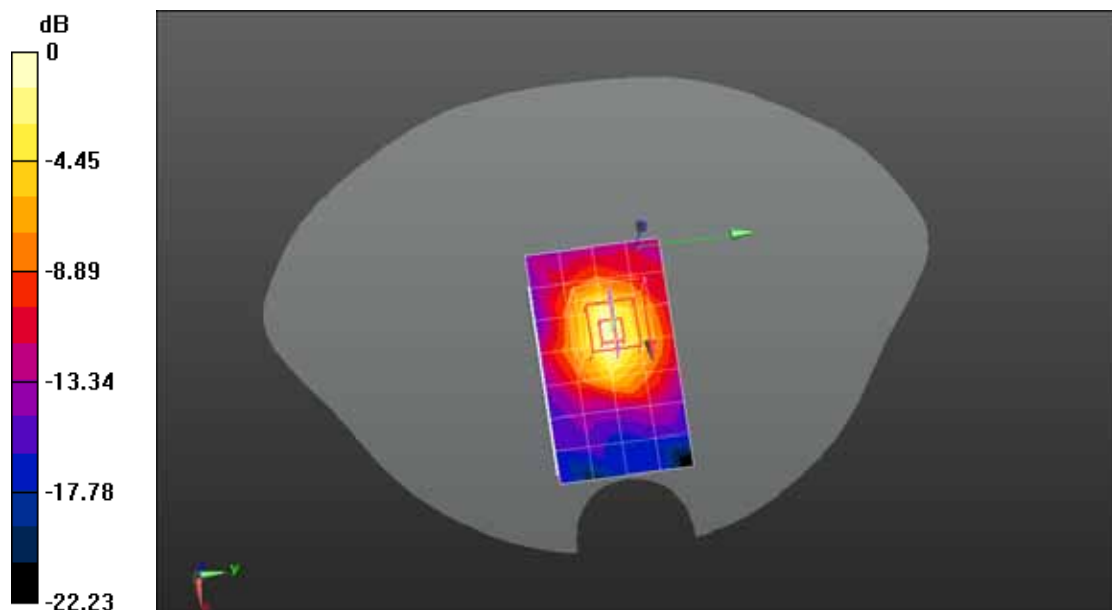

0 dB = 0.210mW/g = -13.56 dB mW/g

Date/Time: 23-04-2012

Test Laboratory: QuieTek Lab

802.11n(20MHz) Low-Horizontal Up(Antenna Swivel 0°)

DUT: Wireless USB Adaptor; Type: GWF-3S4T

Communication System: Wi-Fi; Communication System Band: 802.11n(20MHz); Duty Cycle: 1:1; Frequency: 2412 MHz; Medium parameters used: $f = 2412 \text{ MHz}$; $\sigma = 1.94 \text{ mho/m}$; $\epsilon_r = 52.23$; $\rho = 1000 \text{ kg/m}^3$; Phantom section: Flat Section

Ambient temperature (): 21.5, Liquid temperature (): 21.0

DASY5 Configuration:

- Probe: EX3DV4 - SN3710; ConvF(6.98, 6.98, 6.98); Calibrated: 12/03/2012
- Sensor-Surface: 4mm (Mechanical Surface Detection)
- Electronics: DAE4 Sn1220; Calibrated: 23/01/2012
- Phantom: SAM1; Type: SAM; Serial: TP1561
- Measurement SW: DASY52, Version 52.8 (0); SEMCAD X Version 14.6.4 (4989)

Configuration/802.11n(20MHz) Low-Horizontal Up/Area Scan (8x5x1): Measurement grid: dx=15mm, dy=15mm, Maximum value of SAR (measured) = 0.225 mW/g

Configuration/802.11n(20MHz) Low-Horizontal Up/Zoom Scan (5x5x7)/Cube 0: Measurement grid: dx=8mm, dy=8mm, dz=5mm, Reference Value = 9.776 V/m; Power Drift = -0.16 dB
Peak SAR (extrapolated) = 0.4280

SAR(1 g) = 0.213 mW/g; SAR(10 g) = 0.104 mW/g Maximum value of SAR (measured) = 0.237 mW/g

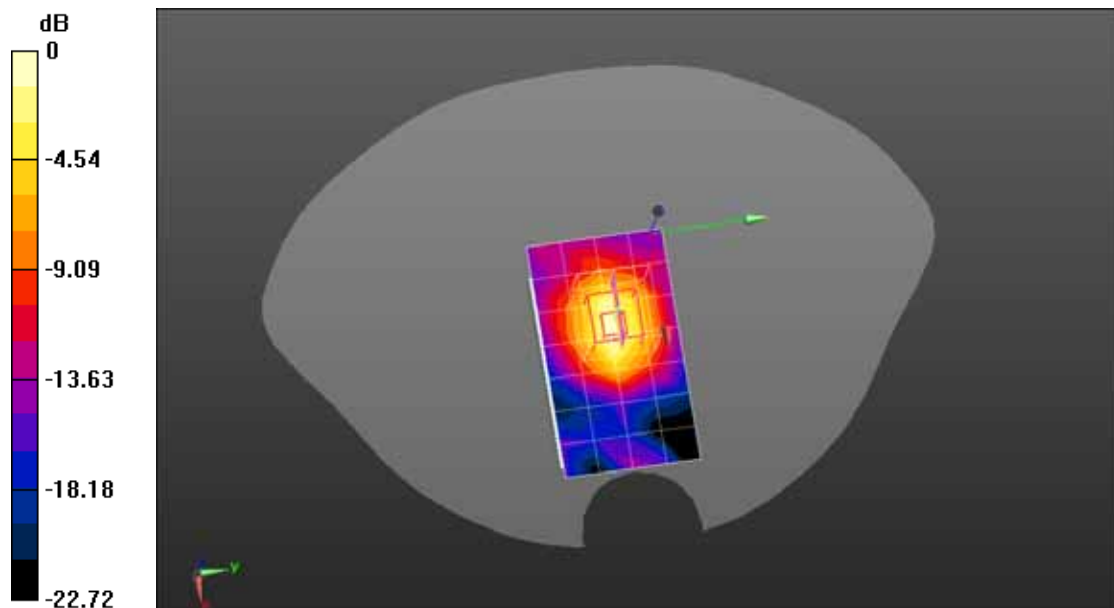

0 dB = 0.240mW/g = -12.40 dB mW/g

Date/Time: 23-04-2012

Test Laboratory: QuieTek Lab

802.11n(40MHz) High-Horizontal Up(Antenna Swivel 0°)

DUT: Wireless USB Adaptor; Type: GWF-3S4T

Communication System: Wi-Fi; Communication System Band: 802.11n(40MHz); Duty Cycle: 1:1; Frequency: 2452 MHz; Medium parameters used: $f = 2452$ MHz; $\sigma = 2$ mho/m; $\epsilon_r = 52.05$; $\rho = 1000$ kg/m³; Phantom section: Flat Section

Ambient temperature (): 21.5, Liquid temperature (): 21.0

DASY5 Configuration:

- Probe: EX3DV4 - SN3710; ConvF(6.98, 6.98, 6.98); Calibrated: 12/03/2012
- Sensor-Surface: 4mm (Mechanical Surface Detection)
- Electronics: DAE4 Sn1220; Calibrated: 23/01/2012
- Phantom: SAM1; Type: SAM; Serial: TP1561
- Measurement SW: DASY52, Version 52.8 (0); SEMCAD X Version 14.6.4 (4989)

Configuration/802.11n(40MHz) High-Horizontal Up/Area Scan (8x5x1): Measurement grid: dx=15mm, dy=15mm, Maximum value of SAR (measured) = 0.225 mW/g

Configuration/802.11n(40MHz) High-Horizontal Up/Zoom Scan (5x5x7)/Cube 0: Measurement grid: dx=8mm, dy=8mm, dz=5mm, Reference Value = 9.414 V/m; Power Drift = -0.15 dB
Peak SAR (extrapolated) = 0.4400

SAR(1 g) = 0.219 mW/g; SAR(10 g) = 0.105 mW/g Maximum value of SAR (measured) = 0.240 mW/g

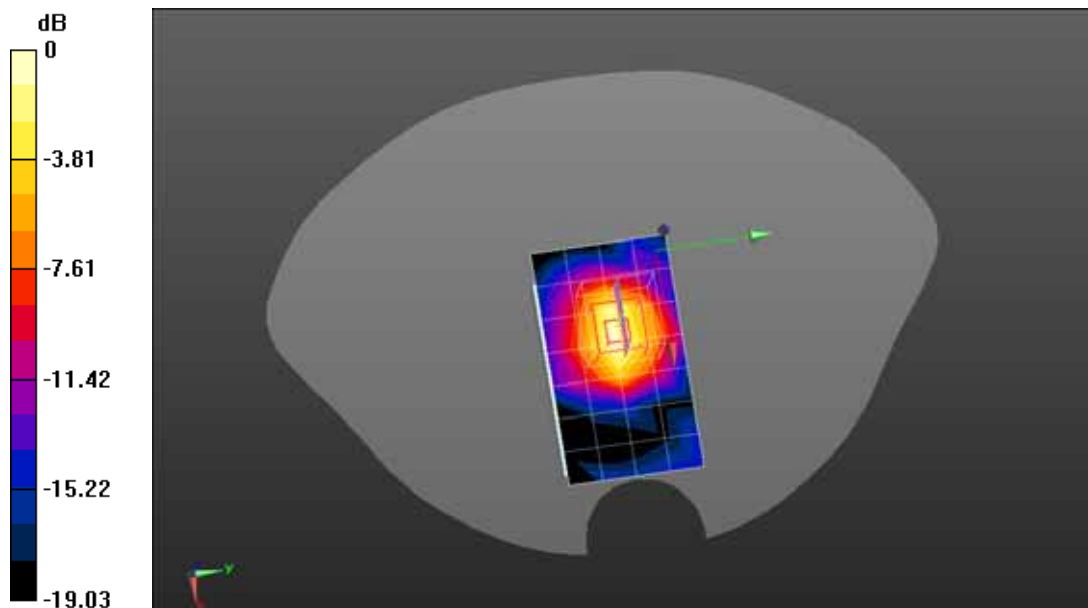

0 dB = 0.240mW/g = -12.40 dB mW/g

Appendix C. Test Setup Photographs & EUT Photographs

Test Setup Photographs

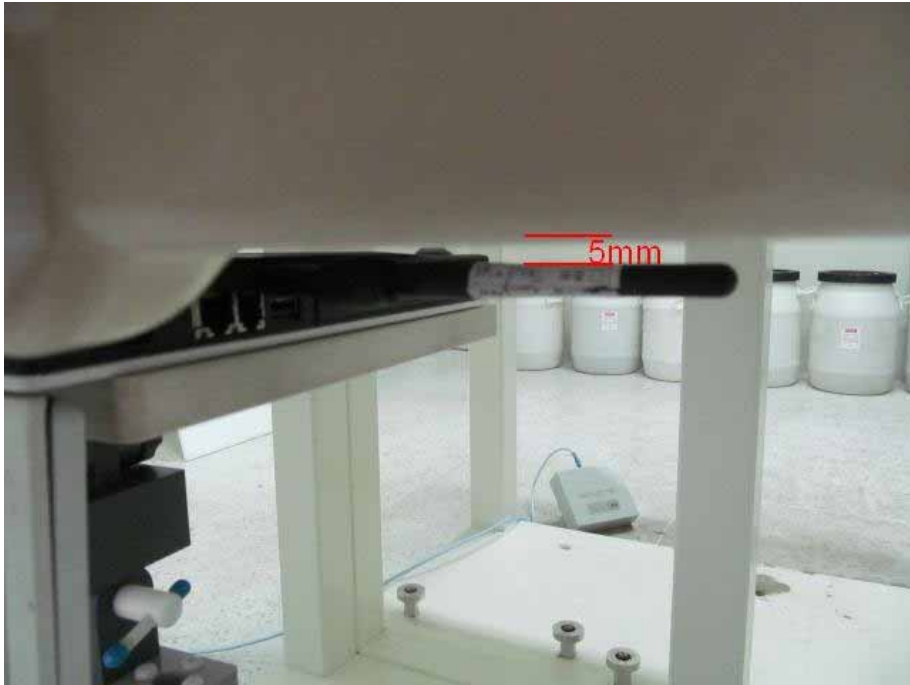

(Horizontal Up-Antenna Straight)



(Horizontal Up-Antenna Swivel 0°)



(Horizontal Up-Antenna Swivel 45°)

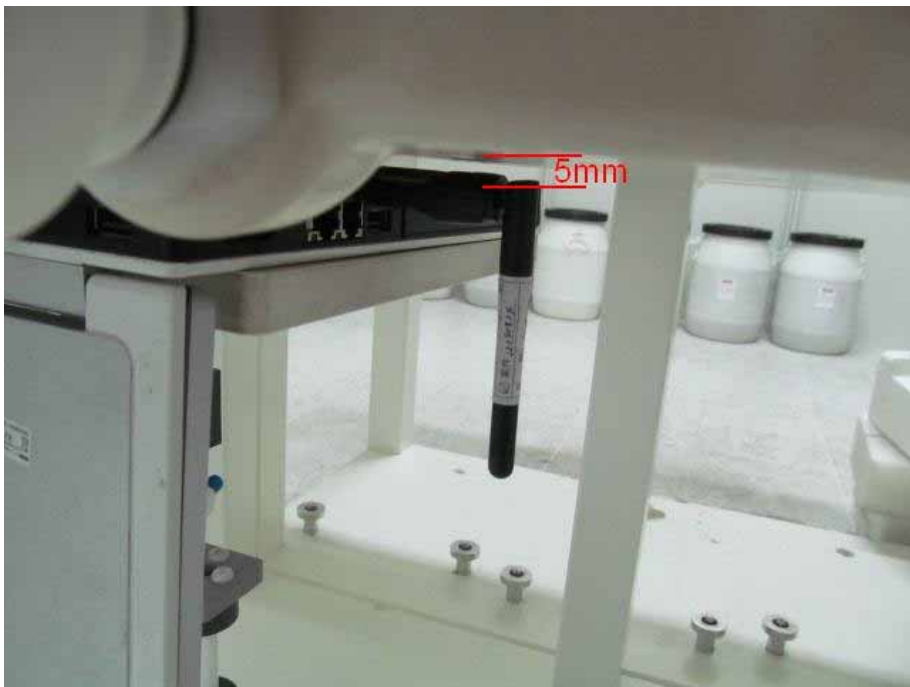

(Horizontal Up-Antenna Swivel 90°)



(Horizontal Down-Antenna Straight)



(Horizontal Down-Antenna Swivel 0°)



(Vertical Front-Antenna Straight)



(Vertical Front-Antenna Swivel 0°)



(Vertical Front-Antenna Swivel 45°)



(Vertical Front-Antenna Swivel 90°)



(Vertical Back-Antenna Straight)



(Vertical Back-Antenna Swivel 0°)



(Tip-Antenna Straight)

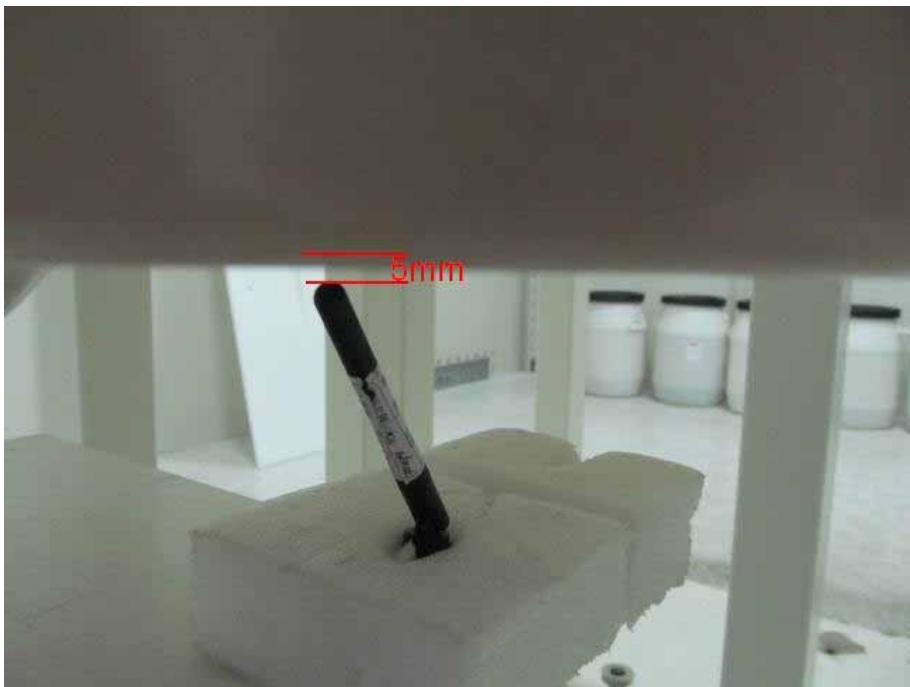

(Tip-Antenna Swivel 45°)

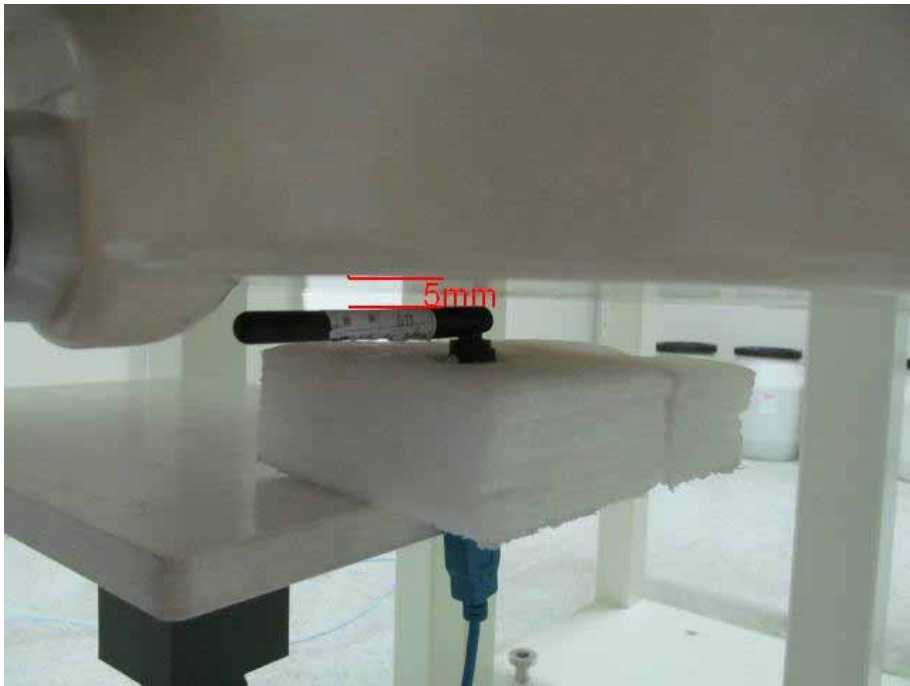

(Tip- Antenna Swivel 90°)

Depth of the liquid in the phantom – Zoom in

Note: The position used in the measurements were according to IEEE 1528 - 2003



EUT Photographs

(1) EUT Photo



(2) EUT Photo



(3) EUT Photo



(4) EUT Photo

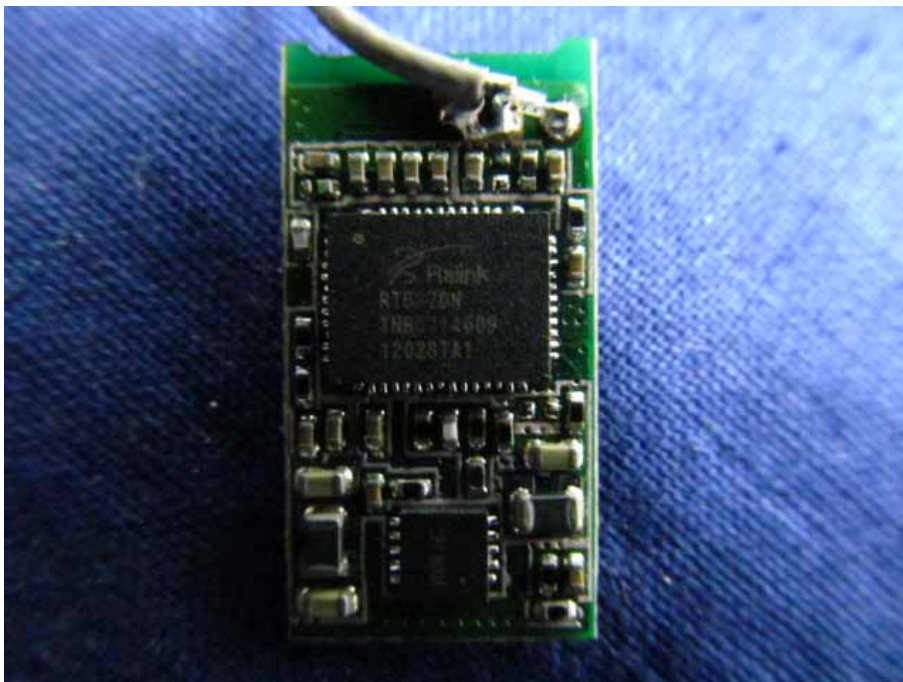

(5) EUT Photo

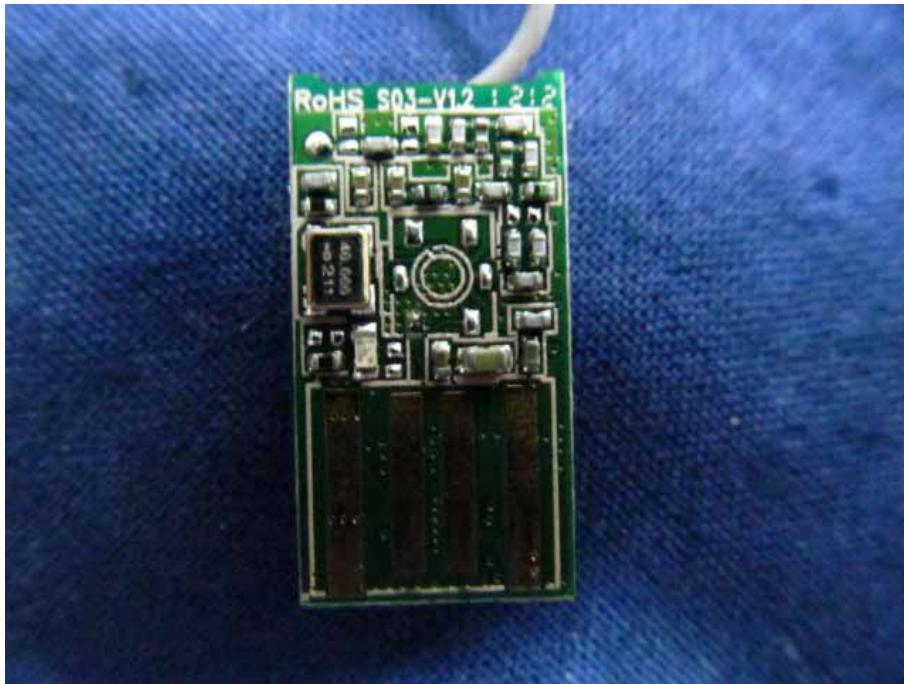

Appendix D. Probe Calibration Data

**Calibration Laboratory of
Schmid & Partner
Engineering AG**
Zeughausstrasse 43, 8004 Zurich, Switzerland



S Schweizerischer Kalibrierdienst
C Service suisse d'étalonnage
S Servizio svizzero di taratura
S Swiss Calibration Service

Accredited by the Swiss Accreditation Service (SAS)
The Swiss Accreditation Service is one of the signatories to the EA
Multilateral Agreement for the recognition of calibration certificates

Accreditation No.: **SCS 108**

Client **Quietek-CN (Auden)**

Certificate No: **EX3-3710_Mar12**

CALIBRATION CERTIFICATE

Object: **EX3DV4 - SN:3710**

Calibration procedure(s): **QA CAL-01.v8, QA CAL-12.v7, QA CAL-14.v3, QA CAL-23.v4, QA CAL-25.v4
Calibration procedure for dosimetric E-field probes**

Calibration date: **March 12, 2012**

This calibration certificate documents the traceability to national standards, which realize the physical units of measurements (SI). The measurements and the uncertainties with confidence probability are given on the following pages and are part of the certificate.

All calibrations have been conducted in the closed laboratory facility: environment temperature (22 ± 3)°C and humidity < 70%.

Calibration Equipment used (M&TE critical for calibration)

Primary Standards	ID	Cal Date (Certificate No.)	Scheduled Calibration
Power meter E4419B	GB41293874	31-Mar-11 (No. 217-01372)	Apr-12
Power sensor E4412A	MY41498087	31-Mar-11 (No. 217-01372)	Apr-12
Reference 3 dB Attenuator	SN: S5054 (3c)	29-Mar-11 (No. 217-01369)	Apr-12
Reference 20 dB Attenuator	SN: S5086 (20b)	29-Mar-11 (No. 217-01367)	Apr-12
Reference 30 dB Attenuator	SN: S5129 (30b)	29-Mar-11 (No. 217-01370)	Apr-12
Reference Probe ES3DV2	SN: 3013	29-Dec-11 (No. ES3-3013_Dec11)	Dec-12
DAE4	SN: 654	3-May-11 (No. DAE4-654_May11)	May-12
Secondary Standards	ID	Check Date (in house)	Scheduled Check
RF generator HP 8648C	US3642U01700	4-Aug-99 (in house check Apr-11)	In house check: Apr-13
Network Analyzer HP 8753E	US37390585	18-Oct-01 (in house check Oct-11)	In house check: Oct-12

	Name	Function	Signature
Calibrated by:	Jeton Kastrati	Laboratory Technician	
Approved by:	Katja Pokovic	Technical Manager	

Issued: March 13, 2012

This calibration certificate shall not be reproduced except in full without written approval of the laboratory.

**Calibration Laboratory of
Schmid & Partner
Engineering AG**
Zeughausstrasse 43, 8004 Zurich, Switzerland



S Schweizerischer Kalibrierdienst
S Service suisse d'étalonnage
S Servizio svizzero di taratura
S Swiss Calibration Service

Accredited by the Swiss Accreditation Service (SAS)

Accreditation No.: **SCS 108**

The Swiss Accreditation Service is one of the signatories to the EA
Multilateral Agreement for the recognition of calibration certificates

Glossary:

TSL	tissue simulating liquid
NORM _{x,y,z}	sensitivity in free space
ConvF	sensitivity in TSL / NORM _{x,y,z}
DCP	diode compression point
CF	crest factor (1/duty_cycle) of the RF signal
A, B, C	modulation dependent linearization parameters
Polarization φ	φ rotation around probe axis
Polarization ϑ	ϑ rotation around an axis that is in the plane normal to probe axis (at measurement center), i.e., $\vartheta = 0$ is normal to probe axis

Calibration is Performed According to the Following Standards:

- IEEE Std 1528-2003, "IEEE Recommended Practice for Determining the Peak Spatial-Averaged Specific Absorption Rate (SAR) in the Human Head from Wireless Communications Devices: Measurement Techniques", December 2003
- IEC 62209-1, "Procedure to measure the Specific Absorption Rate (SAR) for hand-held devices used in close proximity to the ear (frequency range of 300 MHz to 3 GHz)", February 2005

Methods Applied and Interpretation of Parameters:

- NORM_{x,y,z}**: Assessed for E-field polarization $\vartheta = 0$ ($f \leq 900$ MHz in TEM-cell; $f > 1800$ MHz: R22 waveguide). NORM_{x,y,z} are only intermediate values, i.e., the uncertainties of NORM_{x,y,z} does not affect the E²-field uncertainty inside TSL (see below ConvF).
- NORM(f)_{x,y,z} = NORM_{x,y,z} * frequency_response** (see Frequency Response Chart). This linearization is implemented in DASY4 software versions later than 4.2. The uncertainty of the frequency response is included in the stated uncertainty of ConvF.
- DCP_{x,y,z}**: DCP are numerical linearization parameters assessed based on the data of power sweep with CW signal (no uncertainty required). DCP does not depend on frequency nor media.
- PAR**: PAR is the Peak to Average Ratio that is not calibrated but determined based on the signal characteristics
- A_{x,y,z}; B_{x,y,z}; C_{x,y,z}; VR_{x,y,z}; A, B, C** are numerical linearization parameters assessed based on the data of power sweep for specific modulation signal. The parameters do not depend on frequency nor media. VR is the maximum calibration range expressed in RMS voltage across the diode.
- ConvF and Boundary Effect Parameters**: Assessed in flat phantom using E-field (or Temperature Transfer Standard for $f \leq 800$ MHz) and inside waveguide using analytical field distributions based on power measurements for $f > 800$ MHz. The same setups are used for assessment of the parameters applied for boundary compensation (alpha, depth) of which typical uncertainty values are given. These parameters are used in DASY4 software to improve probe accuracy close to the boundary. The sensitivity in TSL corresponds to NORM_{x,y,z} * ConvF whereby the uncertainty corresponds to that given for ConvF. A frequency dependent ConvF is used in DASY version 4.4 and higher which allows extending the validity from ± 50 MHz to ± 100 MHz.
- Spherical isotropy (3D deviation from isotropy)**: in a field of low gradients realized using a flat phantom exposed by a patch antenna.
- Sensor Offset**: The sensor offset corresponds to the offset of virtual measurement center from the probe tip (on probe axis). No tolerance required.

EX3DV4 – SN:3710

March 12, 2012

Probe EX3DV4

SN:3710

Manufactured:	July 21, 2009
Repaired:	February 21, 2012
Calibrated:	March 12, 2012

Calibrated for DASY/EASY Systems
(Note: non-compatible with DASY2 system!)

EX3DV4- SN:3710

March 12, 2012

DASY/EASY - Parameters of Probe: EX3DV4 - SN:3710

Basic Calibration Parameters

	Sensor X	Sensor Y	Sensor Z	Unc (k=2)
Norm ($\mu\text{V}/(\text{V}/\text{m})^2$) ^A	0.51	0.56	0.44	$\pm 10.1 \%$
DCP (mV) ^B	101.3	98.9	100.9	

Modulation Calibration Parameters

UID	Communication System Name	PAR		A dB	B dB	C dB	VR mV	Unc ^E (k=2)
10000	CW	0.00	X	0.00	0.00	1.00	114.4	$\pm 2.2 \%$
			Y	0.00	0.00	1.00	94.4	
			Z	0.00	0.00	1.00	114.2	

The reported uncertainty of measurement is stated as the standard uncertainty of measurement multiplied by the coverage factor k=2, which for a normal distribution corresponds to a coverage probability of approximately 95%.

^A The uncertainties of NormX,Y,Z do not affect the E²-field uncertainty inside TSL (see Pages 5 and 6).

^B Numerical linearization parameter: uncertainty not required.

^E Uncertainty is determined using the max. deviation from linear response applying rectangular distribution and is expressed for the square of the field value.

EX3DV4- SN:3710

March 12, 2012

DASY/EASY - Parameters of Probe: EX3DV4 - SN:3710

Calibration Parameter Determined in Head Tissue Simulating Media

f (MHz) ^C	Relative Permittivity ^F	Conductivity (S/m) ^F	ConvF X	ConvF Y	ConvF Z	Alpha	Depth (mm)	Unct. (k=2)
450	43.5	0.87	9.61	9.61	9.61	0.12	1.00	± 13.4 %
750	41.9	0.89	9.51	9.51	9.51	0.24	1.16	± 12.0 %
835	41.5	0.90	9.18	9.18	9.18	0.22	1.15	± 12.0 %
900	41.5	0.97	8.97	8.97	8.97	0.19	1.35	± 12.0 %
1810	40.0	1.40	8.32	8.32	8.32	0.79	0.60	± 12.0 %
1900	40.0	1.40	8.16	8.16	8.16	0.72	0.66	± 12.0 %
2450	39.2	1.80	7.25	7.25	7.25	0.36	0.91	± 12.0 %
2600	39.0	1.96	6.96	6.96	6.96	0.39	0.95	± 12.0 %
3500	37.9	2.91	6.80	6.80	6.80	0.33	1.09	± 13.1 %
5200	36.0	4.66	5.21	5.21	5.21	0.35	1.80	± 13.1 %
5500	35.6	4.96	4.95	4.95	4.95	0.35	1.80	± 13.1 %
5800	35.3	5.27	4.56	4.56	4.56	0.45	1.80	± 13.1 %

^C Frequency validity of ± 100 MHz only applies for DASY v4.4 and higher (see Page 2), else it is restricted to ± 50 MHz. The uncertainty is the RSS of the ConvF uncertainty at calibration frequency and the uncertainty for the indicated frequency band.

^F At frequencies below 3 GHz, the validity of tissue parameters (ϵ and σ) can be relaxed to ± 10% if liquid compensation formula is applied to measured SAR values. At frequencies above 3 GHz, the validity of tissue parameters (ϵ and σ) is restricted to ± 5%. The uncertainty is the RSS of the ConvF uncertainty for indicated target tissue parameters.

EX3DV4--SN:3710

March 12, 2012

DASY/EASY - Parameters of Probe: EX3DV4 - SN:3710

Calibration Parameter Determined in Body Tissue Simulating Media

f (MHz) ^C	Relative Permittivity ^F	Conductivity (S/m) ^F	ConvF X	ConvF Y	ConvF Z	Alpha	Depth (mm)	Unct. (k=2)
450	56.7	0.94	10.69	10.69	10.69	0.06	1.00	± 13.4 %
750	55.5	0.96	9.33	9.33	9.33	0.43	0.86	± 12.0 %
835	55.2	0.97	9.13	9.13	9.13	0.63	0.70	± 12.0 %
900	55.0	1.05	9.04	9.04	9.04	0.39	0.88	± 12.0 %
1810	53.3	1.52	7.73	7.73	7.73	0.33	1.10	± 12.0 %
1900	53.3	1.52	7.43	7.43	7.43	0.42	0.90	± 12.0 %
2450	52.7	1.95	6.98	6.98	6.98	0.79	0.59	± 12.0 %
2600	52.5	2.16	6.68	6.68	6.68	0.79	0.52	± 12.0 %
3500	51.3	3.31	6.23	6.23	6.23	0.36	1.13	± 13.1 %
5200	49.0	5.30	4.20	4.20	4.20	0.50	1.90	± 13.1 %
5500	48.6	5.65	3.82	3.82	3.82	0.50	1.90	± 13.1 %
5800	48.2	6.00	3.89	3.89	3.89	0.60	1.90	± 13.1 %

^C Frequency validity of ± 100 MHz only applies for DASY v4.4 and higher (see Page 2), else it is restricted to ± 50 MHz. The uncertainty is the RSS of the ConvF uncertainty at calibration frequency and the uncertainty for the indicated frequency band.

^F At frequencies below 3 GHz, the validity of tissue parameters (ϵ and σ) can be relaxed to ± 10% if liquid compensation formula is applied to measured SAR values. At frequencies above 3 GHz, the validity of tissue parameters (ϵ and σ) is restricted to ± 5%. The uncertainty is the RSS of the ConvF uncertainty for indicated target tissue parameters.

EX3DV4- SN:3710

March 12, 2012

Frequency Response of E-Field (TEM-Cell:ifi110 EXX, Waveguide: R22)

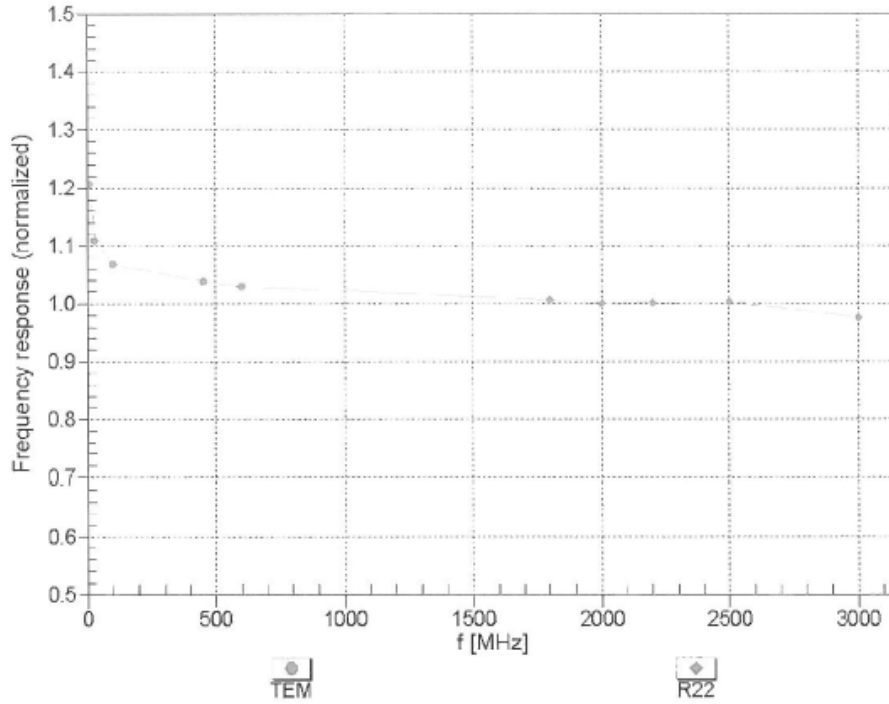

Uncertainty of Frequency Response of E-field: $\pm 6.3\%$ (k=2)

EX3DV4- SN:3710

March 12, 2012

Receiving Pattern (ϕ), $\vartheta = 0^\circ$

f=600 MHz,TEM

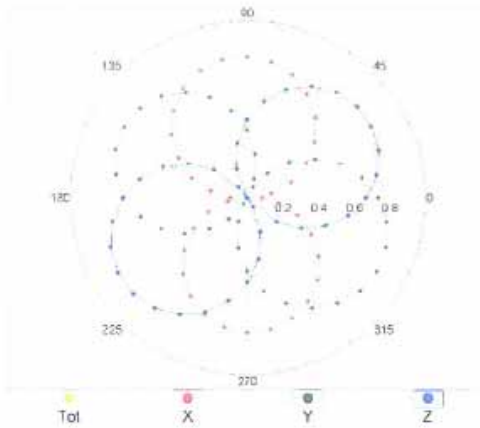

f=1800 MHz,R22

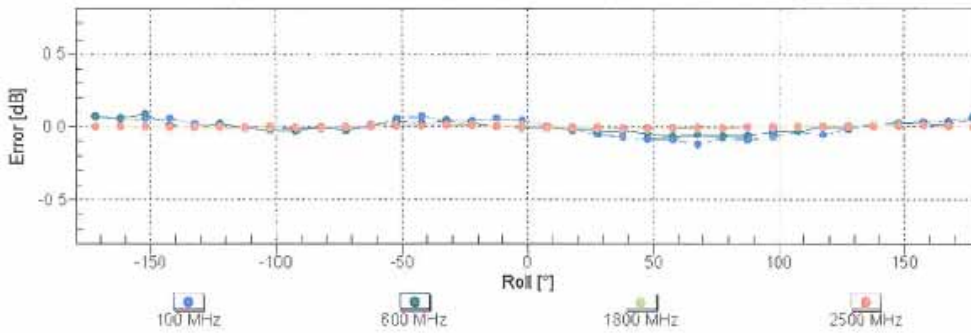
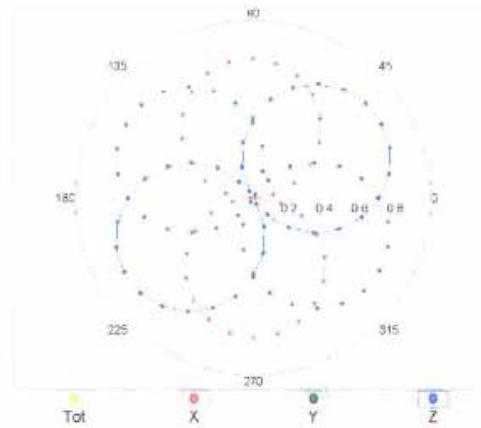

Uncertainty of Axial Isotropy Assessment: $\pm 0.5\%$ (k=2)

EX3DV4-- SN:3710

March 12, 2012

Dynamic Range f(SAR_{head}) (TEM cell , f = 900 MHz)

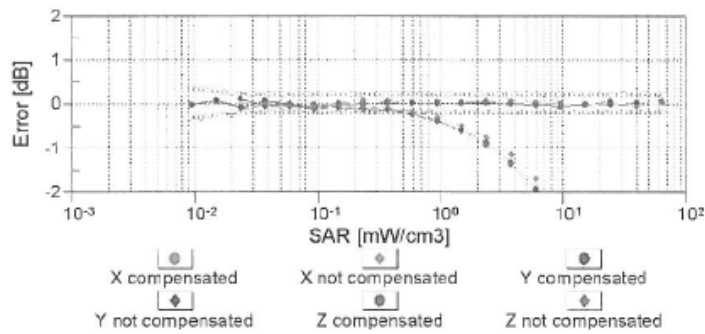
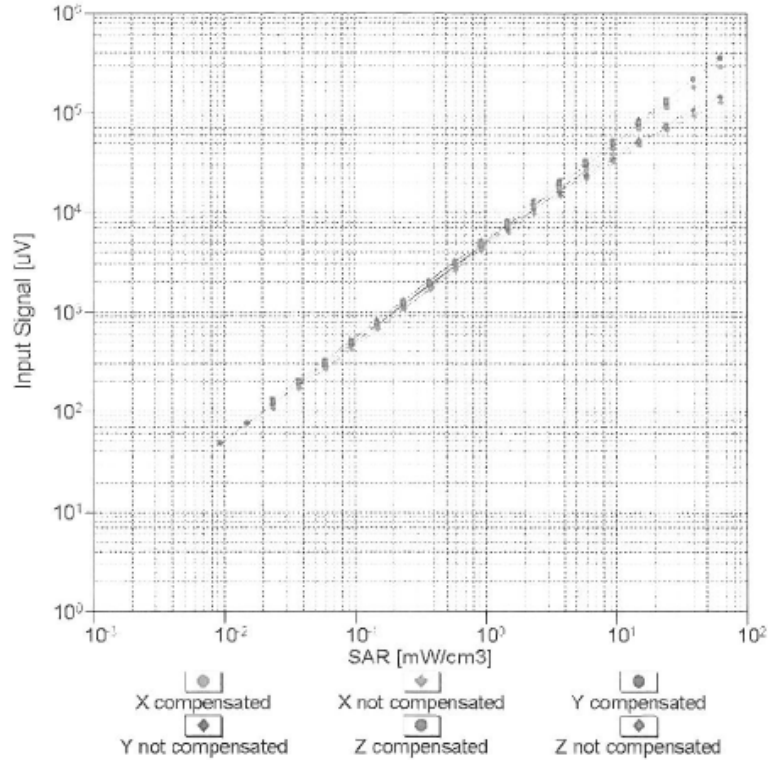

Uncertainty of Linearity Assessment: ± 0.6% (k=2)

EX3DV4-SN:3710

March 12, 2012

Conversion Factor Assessment

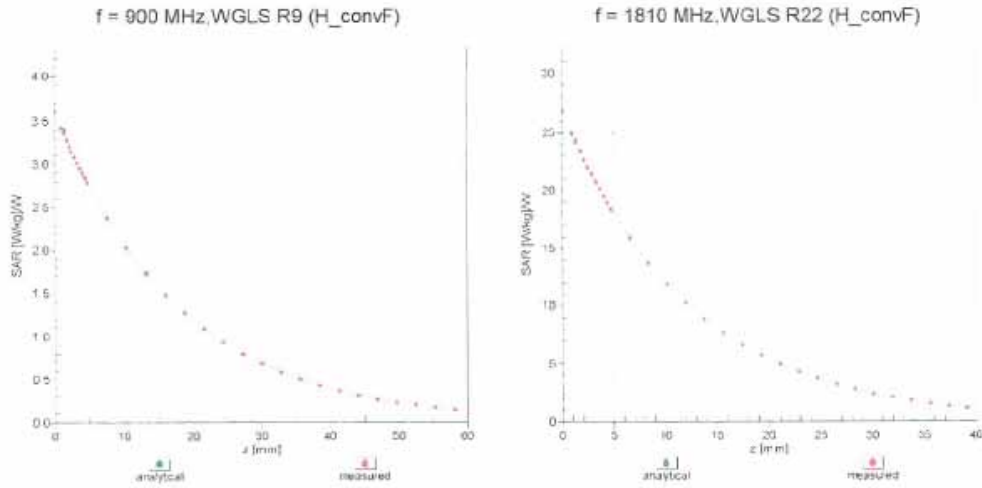

Deviation from Isotropy in Liquid Error (ϕ, θ), f = 900 MHz

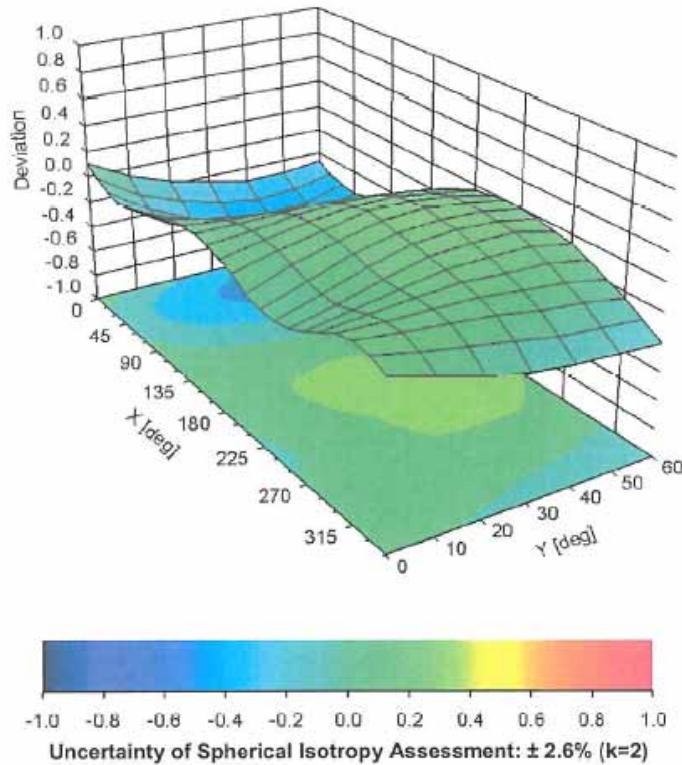

EX3DV4- SN:3710

March 12, 2012

DASY/EASY - Parameters of Probe: EX3DV4 - SN:3710

Other Probe Parameters

Sensor Arrangement	Triangular
Connector Angle (°)	Not applicable
Mechanical Surface Detection Mode	enabled
Optical Surface Detection Mode	disabled
Probe Overall Length	337 mm
Probe Body Diameter	10 mm
Tip Length	9 mm
Tip Diameter	2.5 mm
Probe Tip to Sensor X Calibration Point	1 mm
Probe Tip to Sensor Y Calibration Point	1 mm
Probe Tip to Sensor Z Calibration Point	1 mm
Recommended Measurement Distance from Surface	2 mm

Appendix E. Dipole Calibration Data

**Calibration Laboratory of
Schmid & Partner
Engineering AG**
Zeughausstrasse 43, 8004 Zurich, Switzerland



S Schweizerischer Kalibrierdienst
C Service suisse d'étalonnage
S Servizio svizzero di taratura
S Swiss Calibration Service

Accredited by the Swiss Accreditation Service (SAS)
The Swiss Accreditation Service is one of the signatories to the EA
Multilateral Agreement for the recognition of calibration certificates

Accreditation No.: **SCS 108**

Client **Quietek-CN (Auden)**

Certificate No: **D2450V2-839_Feb12**

CALIBRATION CERTIFICATE

Object: **D2450V2 - SN: 839**

Calibration procedure(s): **QA CAL-05.v8
Calibration procedure for dipole validation kits above 700 MHz**

Calibration date: **February 23, 2012**

This calibration certificate documents the traceability to national standards, which realize the physical units of measurements (SI).
The measurements and the uncertainties with confidence probability are given on the following pages and are part of the certificate.

All calibrations have been conducted in the closed laboratory facility: environment temperature (22 ± 3)°C and humidity < 70%.

Calibration Equipment used (M&TE critical for calibration)

Primary Standards	ID #	Cal Date (Certificate No.)	Scheduled Calibration
Power meter EPM-442A	GB37480704	05-Oct-11 (No. 217-01451)	Oct-12
Power sensor HP 8481A	US37292783	05-Oct-11 (No. 217-01451)	Oct-12
Reference 20 dB Attenuator	SN: 5086 (20g)	29-Mar-11 (No. 217-01368)	Apr-12
Type N mismatch combination	SN: 5017.2 / 06327	29-Mar-11 (No. 217-01371)	Apr-12
Reference Probe ES3DV3	SN: 3205	30-Dec-11 (No. ES3-3205_Dec11)	Dec-12
DAE4	SN: 601	04-Jul-11 (No. DAE4-601_Jul11)	Jul-12
Secondary Standards	ID #	Check Date (in house)	Scheduled Check
Power sensor HP 8481A	MY41092317	18-Oct-02 (in house check Oct-11)	In house check: Oct-13
RF generator R&S SMT-06	100005	04-Aug-99 (in house check Oct-11)	In house check: Oct-13
Network Analyzer HP 8753E	US37390585 S4206	18-Oct-01 (in house check Oct-11)	In house check: Oct-12

Calibrated by:	Name Israe El-Naouq	Function Laboratory Technician	Signature
Approved by:	Name Katja Pokovic	Function Technical Manager	

Issued: February 23, 2012

This calibration certificate shall not be reproduced except in full without written approval of the laboratory.

**Calibration Laboratory of
Schmid & Partner
Engineering AG**
Zeughausstrasse 43, 8004 Zurich, Switzerland



S Schweizerischer Kalibrierdienst
C Service suisse d'étalonnage
S Servizio svizzero di taratura
S Swiss Calibration Service

Accredited by the Swiss Accreditation Service (SAS)
The Swiss Accreditation Service is one of the signatories to the EA
Multilateral Agreement for the recognition of calibration certificates

Accreditation No.: **SCS 108**

Glossary:

TSL	tissue simulating liquid
ConvF	sensitivity in TSL / NORM x,y,z
N/A	not applicable or not measured

Calibration is Performed According to the Following Standards:

- a) IEEE Std 1528-2003, "IEEE Recommended Practice for Determining the Peak Spatial-Averaged Specific Absorption Rate (SAR) in the Human Head from Wireless Communications Devices: Measurement Techniques", December 2003
- b) IEC 62209-1, "Procedure to measure the Specific Absorption Rate (SAR) for hand-held devices used in close proximity to the ear (frequency range of 300 MHz to 3 GHz)", February 2005
- c) Federal Communications Commission Office of Engineering & Technology (FCC OET), "Evaluating Compliance with FCC Guidelines for Human Exposure to Radiofrequency Electromagnetic Fields; Additional Information for Evaluating Compliance of Mobile and Portable Devices with FCC Limits for Human Exposure to Radiofrequency Emissions", Supplement C (Edition 01-01) to Bulletin 65

Additional Documentation:

- d) DASY4/5 System Handbook

Methods Applied and Interpretation of Parameters:

- *Measurement Conditions:* Further details are available from the Validation Report at the end of the certificate. All figures stated in the certificate are valid at the frequency indicated.
- *Antenna Parameters with TSL:* The dipole is mounted with the spacer to position its feed point exactly below the center marking of the flat phantom section, with the arms oriented parallel to the body axis.
- *Feed Point Impedance and Return Loss:* These parameters are measured with the dipole positioned under the liquid filled phantom. The impedance stated is transformed from the measurement at the SMA connector to the feed point. The Return Loss ensures low reflected power. No uncertainty required.
- *Electrical Delay:* One-way delay between the SMA connector and the antenna feed point. No uncertainty required.
- *SAR measured:* SAR measured at the stated antenna input power.
- *SAR normalized:* SAR as measured, normalized to an input power of 1 W at the antenna connector.
- *SAR for nominal TSL parameters:* The measured TSL parameters are used to calculate the nominal SAR result.

Measurement Conditions

DASY system configuration, as far as not given on page 1.

DASY Version	DASY5	V52.8.0
Extrapolation	Advanced Extrapolation	
Phantom	Modular Flat Phantom	
Distance Dipole Center - TSL	10 mm	with Spacer
Zoom Scan Resolution	dx, dy, dz = 5 mm	
Frequency	2450 MHz ± 1 MHz	

Head TSL parameters

The following parameters and calculations were applied.

	Temperature	Permittivity	Conductivity
Nominal Head TSL parameters	22.0 °C	39.2	1.80 mho/m
Measured Head TSL parameters	(22.0 ± 0.2) °C	38.9 ± 6 %	1.86 mho/m ± 6 %
Head TSL temperature change during test	< 0.5 °C	----	----

SAR result with Head TSL

SAR averaged over 1 cm ³ (1 g) of Head TSL	Condition	
SAR measured	250 mW input power	13.2 mW / g
SAR for nominal Head TSL parameters	normalized to 1W	51.9 mW / g ± 17.0 % (k=2)

SAR averaged over 10 cm ³ (10 g) of Head TSL	condition	
SAR measured	250 mW input power	6.09 mW / g
SAR for nominal Head TSL parameters	normalized to 1W	24.1 mW / g ± 16.5 % (k=2)

Body TSL parameters

The following parameters and calculations were applied.

	Temperature	Permittivity	Conductivity
Nominal Body TSL parameters	22.0 °C	52.7	1.95 mho/m
Measured Body TSL parameters	(22.0 ± 0.2) °C	52.3 ± 6 %	2.02 mho/m ± 6 %
Body TSL temperature change during test	< 0.5 °C	----	----

SAR result with Body TSL

SAR averaged over 1 cm ³ (1 g) of Body TSL	Condition	
SAR measured	250 mW input power	12.4 mW / g
SAR for nominal Body TSL parameters	normalized to 1W	48.7 mW / g ± 17.0 % (k=2)

SAR averaged over 10 cm ³ (10 g) of Body TSL	condition	
SAR measured	250 mW input power	5.76 mW / g
SAR for nominal Body TSL parameters	normalized to 1W	22.8 mW / g ± 16.5 % (k=2)

Appendix

Antenna Parameters with Head TSL

Impedance, transformed to feed point	55.7 Ω - 1.0 j Ω
Return Loss	- 25.2 dB

Antenna Parameters with Body TSL

Impedance, transformed to feed point	52.1 Ω + 1.0 j Ω
Return Loss	- 32.9 dB

General Antenna Parameters and Design

Electrical Delay (one direction)	1.160 ns
----------------------------------	----------

After long term use with 100W radiated power, only a slight warming of the dipole near the feedpoint can be measured.

The dipole is made of standard semirigid coaxial cable. The center conductor of the feeding line is directly connected to the second arm of the dipole. The antenna is therefore short-circuited for DC-signals. On some of the dipoles, small end caps are added to the dipole arms in order to improve matching when loaded according to the position as explained in the "Measurement Conditions" paragraph. The SAR data are not affected by this change. The overall dipole length is still according to the Standard.

No excessive force must be applied to the dipole arms, because they might bend or the soldered connections near the feedpoint may be damaged.

Additional EUT Data

Manufactured by	SPEAG
Manufactured on	July 20, 2009

DASY5 Validation Report for Head TSL

Date: 23.02.2012

Test Laboratory: SPEAG, Zurich, Switzerland

DUT: Dipole 2450 MHz; Type: D2450V2; Serial: D2450V2 - SN: 839

Communication System: CW; Frequency: 2450 MHz
 Medium parameters used: $f = 2450$ MHz; $\sigma = 1.86$ mho/m; $\epsilon_r = 38.9$; $\rho = 1000$ kg/m³
 Phantom section: Flat Section
 Measurement Standard: DASY5 (IEEE/IEC/ANSI C63.19-2007)

DASY52 Configuration:

- Probe: ES3DV3 - SN3205; ConvF(4.45, 4.45, 4.45); Calibrated: 30.12.2011
- Sensor-Surface: 3mm (Mechanical Surface Detection)
- Electronics: DAE4 Sn601; Calibrated: 04.07.2011
- Phantom: Flat Phantom 5.0 (front); Type: QD000P50AA; Serial: 1001
- DASY52 52.8.0(692); SEMCAD X 14.6.4(4989)

Dipole Calibration for Head Tissue/Pin=250 mW, d=10mm/Zoom Scan (7x7x7)/Cube 0:

Measurement grid: $dx=5$ mm, $dy=5$ mm, $dz=5$ mm
 Reference Value = 98.155 V/m; Power Drift = 0.08 dB
 Peak SAR (extrapolated) = 27.8700
SAR(1 g) = 13.2 mW/g; SAR(10 g) = 6.09 mW/g
 Maximum value of SAR (measured) = 16.839 mW/g

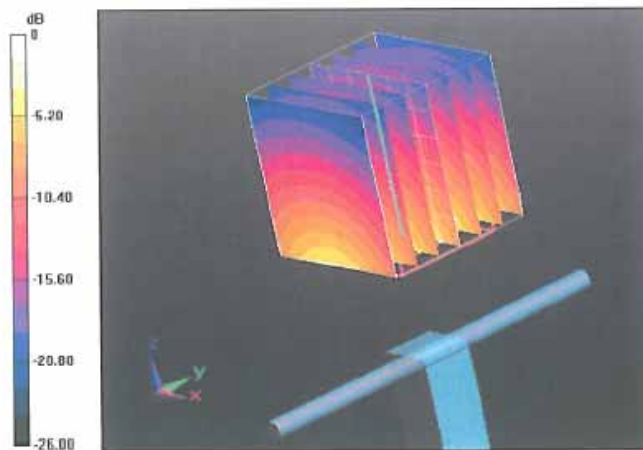

0 dB = 16.840mW/g = 24.53 dB mW/g

Impedance Measurement Plot for Head TSL

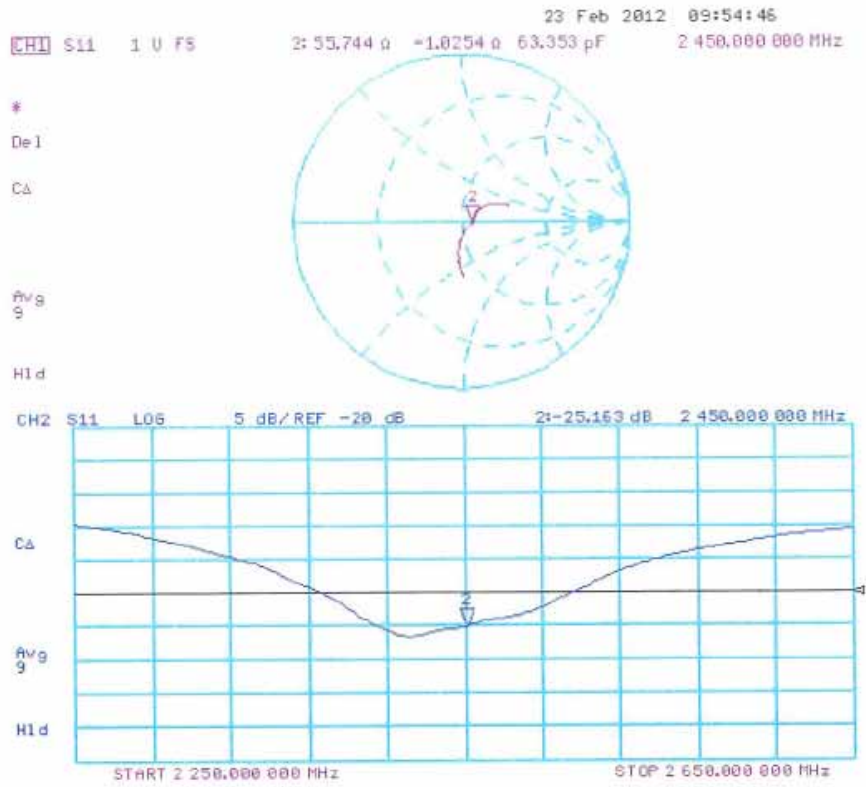

DASY5 Validation Report for Body TSL

Date: 23.02.2012

Test Laboratory: SPEAG, Zurich, Switzerland

DUT: Dipole 2450 MHz; Type: D2450V2; Serial: D2450V2 - SN: 839

Communication System: CW; Frequency: 2450 MHz

Medium parameters used: $f = 2450$ MHz; $\sigma = 2.02$ mho/m; $\epsilon_r = 52.3$; $\rho = 1000$ kg/m³

Phantom section: Flat Section

Measurement Standard: DASY5 (IEEE/IEC/ANSI C63.19-2007)

DASY52 Configuration:

- Probe: ES3DV3 - SN3205; ConvF(4.26, 4.26, 4.26); Calibrated: 30.12.2011
- Sensor-Surface: 3mm (Mechanical Surface Detection)
- Electronics: DAE4 Sn601; Calibrated: 04.07.2011
- Phantom: Flat Phantom 5.0 (back); Type: QD000P50AA; Serial: 1002
- DASY52 52.8.0(692); SEMCAD X 14.6.4(4989)

Dipole Calibration for Body Tissue/Pin=250 mW, d=10mm/Zoom Scan (7x7x7)/Cube 0:

Measurement grid: dx=5mm, dy=5mm, dz=5mm

Reference Value = 93.056 V/m; Power Drift = 0.0053 dB

Peak SAR (extrapolated) = 25.2250

SAR(1 g) = 12.4 mW/g; SAR(10 g) = 5.76 mW/g

Maximum value of SAR (measured) – 16.258 mW/g

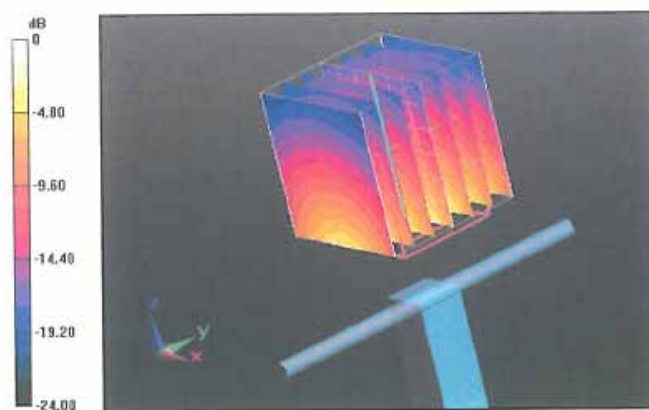

0 dB = 16.260mW/g = 24.22 dB mW/g

Impedance Measurement Plot for Body TSL

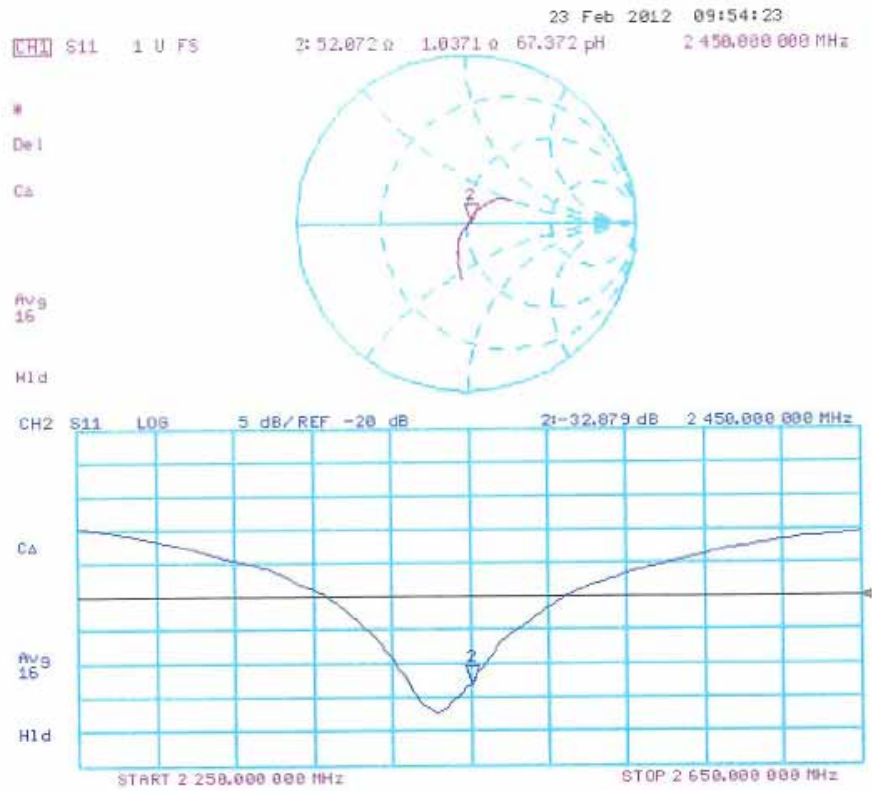

Appendix F. DAE Calibration Data

Calibration Laboratory of
Schmid & Partner
Engineering AG
Zeughausstrasse 43, 8004 Zurich, Switzerland



S Schweizerischer Kalibrierdienst
C Service suisse d'étalonnage
S Servizio svizzero di taratura
S Swiss Calibration Service

Accredited by the Swiss Accreditation Service (SAS)
The Swiss Accreditation Service is one of the signatories to the EA
Multilateral Agreement for the recognition of calibration certificates

Accreditation No.: **SCS 108**

Client **Quietek-CN (Auden)**

Certificate No: **DAE4-1220_Jan12**

CALIBRATION CERTIFICATE																			
Object	DAE4 - SD 000 D04 BJ - SN: 1220																		
Calibration procedure(s)	QA CAL-06.v24 Calibration procedure for the data acquisition electronics (DAE)																		
Calibration date:	January 23, 2012																		
<p>This calibration certificate documents the traceability to national standards, which realize the physical units of measurements (SI). The measurements and the uncertainties with confidence probability are given on the following pages and are part of the certificate.</p> <p>All calibrations have been conducted in the closed laboratory facility: environment temperature (22 ± 3)°C and humidity < 70%.</p> <p>Calibration Equipment used (M&TE critical for calibration)</p> <table border="1"> <thead> <tr> <th>Primary Standards</th> <th>ID #</th> <th>Cal Date (Certificate No.)</th> <th>Scheduled Calibration</th> </tr> </thead> <tbody> <tr> <td>Keithley Multimeter Type 2001</td> <td>SN: 0810278</td> <td>28-Sep-11 (No:11450)</td> <td>Sep-12</td> </tr> <tr> <th>Secondary Standards</th> <th>ID #</th> <th>Check Date (in house)</th> <th>Scheduled Check</th> </tr> <tr> <td>Calibrator Box V2.1</td> <td>SE UWS 053 AA 1001</td> <td>05-Jan-12 (in house check)</td> <td>In house check: Jan-13</td> </tr> </tbody> </table>				Primary Standards	ID #	Cal Date (Certificate No.)	Scheduled Calibration	Keithley Multimeter Type 2001	SN: 0810278	28-Sep-11 (No:11450)	Sep-12	Secondary Standards	ID #	Check Date (in house)	Scheduled Check	Calibrator Box V2.1	SE UWS 053 AA 1001	05-Jan-12 (in house check)	In house check: Jan-13
Primary Standards	ID #	Cal Date (Certificate No.)	Scheduled Calibration																
Keithley Multimeter Type 2001	SN: 0810278	28-Sep-11 (No:11450)	Sep-12																
Secondary Standards	ID #	Check Date (in house)	Scheduled Check																
Calibrator Box V2.1	SE UWS 053 AA 1001	05-Jan-12 (in house check)	In house check: Jan-13																
Calibrated by:	Name Dominique Steffen	Function Technician	Signature 																
Approved by:	Fin Bomholt	R&D Director																	
			Issued: January 23, 2012																
This calibration certificate shall not be reproduced except in full without written approval of the laboratory.																			

Calibration Laboratory of
 Schmid & Partner
 Engineering AG
 Zeughausstrasse 43, 8004 Zurich, Switzerland



S Schweizerischer Kalibrierdienst
S Service suisse d'étalonnage
C Servizio svizzero di taratura
S Swiss Calibration Service

Accredited by the Swiss Accreditation Service (SAS)
 The Swiss Accreditation Service is one of the signatories to the EA
 Multilateral Agreement for the recognition of calibration certificates

Accreditation No.: **SCS 108**

Glossary

DAE data acquisition electronics
 Connector angle information used in DASY system to align probe sensor X to the robot coordinate system.

Methods Applied and Interpretation of Parameters

- *DC Voltage Measurement:* Calibration Factor assessed for use in DASY system by comparison with a calibrated instrument traceable to national standards. The figure given corresponds to the full scale range of the voltmeter in the respective range.
- *Connector angle:* The angle of the connector is assessed measuring the angle mechanically by a tool inserted. Uncertainty is not required.
- The following parameters as documented in the Appendix contain technical information as a result from the performance test and require no uncertainty.
 - *DC Voltage Measurement Linearity:* Verification of the Linearity at +10% and -10% of the nominal calibration voltage. Influence of offset voltage is included in this measurement.
 - *Common mode sensitivity:* Influence of a positive or negative common mode voltage on the differential measurement.
 - *Channel separation:* Influence of a voltage on the neighbor channels not subject to an input voltage.
 - *AD Converter Values with inputs shorted:* Values on the internal AD converter corresponding to zero input voltage
 - *Input Offset Measurement:* Output voltage and statistical results over a large number of zero voltage measurements.
 - *Input Offset Current:* Typical value for information; Maximum channel input offset current, not considering the input resistance.
 - *Input resistance:* Typical value for information: DAE input resistance at the connector, during internal auto-zeroing and during measurement.
 - *Low Battery Alarm Voltage:* Typical value for information. Below this voltage, a battery alarm signal is generated.
 - *Power consumption:* Typical value for information. Supply currents in various operating modes.

DC Voltage Measurement

A/D - Converter Resolution nominal

High Range: 1LSB = 6.1 μ V, full range = -100...+300 mV

Low Range: 1LSB = 61nV, full range = -1.....+3mV

DASY measurement parameters: Auto Zero Time: 3 sec; Measuring time: 3 sec

Calibration Factors	X	Y	Z
High Range	405.267 \pm 0.1% (k=2)	404.990 \pm 0.1% (k=2)	404.221 \pm 0.1% (k=2)
Low Range	3.97762 \pm 0.7% (k=2)	3.99629 \pm 0.7% (k=2)	3.98707 \pm 0.7% (k=2)

Connector Angle

Connector Angle to be used in DASY system	176.5 $^{\circ}$ \pm 1 $^{\circ}$
---	-------------------------------------

Appendix

1. DC Voltage Linearity

High Range	Reading (μV)	Difference (μV)	Error (%)
Channel X + Input	199991.77	-2.52	-0.00
Channel X + Input	20001.19	1.01	0.01
Channel X - Input	-19996.52	3.93	-0.02
Channel Y + Input	199992.70	-2.15	-0.00
Channel Y + Input	19999.00	-1.14	-0.01
Channel Y - Input	-19999.75	0.71	-0.00
Channel Z + Input	199991.55	-3.11	-0.00
Channel Z + Input	19999.33	-0.76	-0.00
Channel Z - Input	-20001.23	-0.67	0.00

Low Range	Reading (μV)	Difference (μV)	Error (%)
Channel X + Input	1999.14	-1.60	-0.08
Channel X + Input	201.79	0.59	0.29
Channel X - Input	-198.19	0.48	-0.24
Channel Y + Input	1999.56	-0.99	-0.05
Channel Y + Input	200.20	-0.96	-0.48
Channel Y - Input	-199.38	-0.54	0.27
Channel Z + Input	2000.07	-0.52	-0.03
Channel Z + Input	200.32	-0.83	-0.41
Channel Z - Input	-199.60	-0.78	0.39

2. Common mode sensitivity

DASY measurement parameters: Auto Zero Time: 3 sec; Measuring time: 3 sec

	Common mode Input Voltage (mV)	High Range Average Reading (μV)	Low Range Average Reading (μV)
Channel X	200	10.22	8.65
	-200	-6.99	-8.91
Channel Y	200	-10.43	-11.02
	-200	7.95	9.22
Channel Z	200	14.25	13.66
	-200	-15.77	-14.99

3. Channel separation

DASY measurement parameters: Auto Zero Time: 3 sec; Measuring time: 3 sec

	Input Voltage (mV)	Channel X (μV)	Channel Y (μV)	Channel Z (μV)
Channel X	200	-	-1.62	-2.79
Channel Y	200	8.07	-	-2.95
Channel Z	200	7.90	6.93	-

4. AD-Converter Values with inputs shorted

DASY measurement parameters: Auto Zero Time: 3 sec; Measuring time: 3 sec

	High Range (LSB)	Low Range (LSB)
Channel X	15896	16218
Channel Y	16012	15924
Channel Z	15702	15710

5. Input Offset Measurement

DASY measurement parameters: Auto Zero Time: 3 sec; Measuring time: 3 sec

Input 10MΩ

	Average (μV)	min. Offset (μV)	max. Offset (μV)	Std. Deviation (μV)
Channel X	0.67	-0.77	1.84	0.43
Channel Y	-1.44	-2.35	-0.02	0.39
Channel Z	-0.81	-1.60	0.01	0.37

6. Input Offset Current

Nominal Input circuitry offset current on all channels: <25fA

7. Input Resistance (Typical values for information)

	Zeroing (kOhm)	Measuring (MOhm)
Channel X	200	200
Channel Y	200	200
Channel Z	200	200

8. Low Battery Alarm Voltage (Typical values for information)

Typical values	Alarm Level (VDC)
Supply (+ Vcc)	+7.9
Supply (- Vcc)	-7.6

9. Power Consumption (Typical values for information)

Typical values	Switched off (mA)	Stand by (mA)	Transmitting (mA)
Supply (+ Vcc)	+0.01	+6	+14
Supply (- Vcc)	-0.01	-8	-9