

# Wireless Mouse

## User Manual

Compliant model: M-XGS31DBS, M-XGM31DBS, M-XGL31DBS, M-XGXL31DBS, E02A

Thank you very much for purchasing this product.

\* Each of the "M-XGS31DBS/M-XGM31DBS/M-XGL31DBS/M-XGXL31DBS" series is referred to as "this product" in this manual except in some cases.

## Precautions



This manual describes the important precautions you should take for safe operation of this product. Observe these precautions carefully to avoid personal injury, damage, fire, and other problems.

### ■ Meaning of symbols

---

## **WARNING**

Failure to observe precautions carries the possibility of serious personal injury or death due to fire, electric shock, or other causes.

## **CAUTION**

Failure to observe precautions may result in personal injury due to electric shock or other causes, and may damage other equipment.

 Prohibited action

 Mandatory action

 Situation that needs attention

 Notes and reference information

## **WARNING**

 **If a foreign object (water, metal chips) enters the product, stop using the product immediately, remove the receiver unit from the PC, and remove the battery from the mouse.**

Continuing to use the product as it is may cause a fire or electric shock.

 **If the product is behaving abnormally, such as by generating heat, smoke, or giving off a strange smell, stop using the product immediately, shut down the PC, and then after sufficiently checking for whether the product is generating heat without being burned, remove the receiver unit from the PC, and remove the battery from the mouse. Afterwards, please contact your dealer.**

Continuing to use the product as it is may cause a fire or electric shock.

 **Please do not drop or hit this product.**

**In the unlikely event that this product is damaged, stop using the product immediately, remove the receiver unit from the PC, and remove the battery from the mouse. Afterwards, please contact your dealer.**

Fires or electric shocks may occur if this product is used when damaged.

 **Do not attempt to disassemble, modify or repair this product.**

Doing so may cause a fire, electric shock, or product damage.

Malfunctions are not covered under warranty.

 **Do not put this product in fire.**

Breakage may cause fire or injury.

## CAUTION

### Do not place this product in any of the following environments:

- In a car exposed to sunlight or a place exposed to direct sunlight.
- In a place that becomes hot, such as around a heater.
- In a moist place or a place where condensation may occur.
- In an uneven place or a place exposed to vibration.
- In a place where a magnetic field is generated (such as near a magnet.)
- In a dusty place.

### This product does not have a waterproof structure. Use or store in a place not exposed to liquids such as water.

Any liquid such as rain, water spray, juice, coffee, steam, and sweat, may cause this product to breakdown.

- ###
- Only use this mouse with PCs, smartphones, tablets, and video game systems.
  - Do not use this product with any device that may significantly be affected in the case of this product malfunctioning.
  - If this product is used on a transparent surface such as glass or a highly reflective surface such as a mirror, the optical sensor will not function correctly and the mouse cursor movement will become unstable.
  - Although the sensor light is not visible, please note that looking directly into the sensor may hurt your eyes.
  - When you no longer need to use this product and the battery, be sure to dispose of them in accordance with the local ordinances and laws of your area.

## ■ Battery

## CAUTION

### Please use either an AA alkaline battery, an AA manganese battery or an AA nickel-metal hydride rechargeable battery.

### Remove the battery when you are not using this product for long periods of time.

This may cause leakage or malfunction.

## ■ Cleaning the Product

If the body of this product becomes dirty, wipe with a soft, dry cloth.



Using a volatile liquid such as paint thinner, benzene or alcohol may affect the material quality and/or discolor this product.

Please note the following for disinfection.



Gently soak a cleaning cloth, such as a microfiber cloth, in the disinfectant solution. Make sure there are no loose droplets and gently wipe the product using the cloth.

After wiping, dry thoroughly and wipe off any residual liquid.

\* Do not spray any liquid onto the product directly. Doing so can cause electric malfunctions.



## IMPORTANT



**Do not spray any liquid onto the product directly.**

Doing so can cause electric malfunctions.



**Do not use organic solvents or ultraviolet lights.**

Usage can result in deterioration of the housing components or paints, which can cause damage to the exterior.



**We recommend the usage of disposable gloves.**



**Please unplug the USB connector from the PC.**



**When using any alcohol-based products, please check that it is appropriate for the specific purpose and that it is used properly.**



**Please note that in the event that damage or abnormal operation to the product is caused by the cleaning process, the customer will be fully responsible for the cost of repair.**



**We recommend that you disinfect your hands before and after using PCs and peripheral devices that are used by multiple people in order to prevent the spread of infection through the equipment.**



**Please turn off any connected devices.**

\* Please turn off connected devices in sleep or hibernation mode.

\* Please unplug the AC adapter and power cable from the power outlet.

## Cautions for Wireless Equipment

This product is a wireless device that can use the entire 2.4 GHz band, and is able to avoid the mobile entity identification device range. The GFSK method is adopted as the radio wave method, and the interference distance is 10 m. The 2.4 GHz band is also used in medical devices, Bluetooth, and wireless LAN devices of the IEEE 802.11b/11g/11n standards.

- Before using this product, check that there are no other "radio stations"\* operating nearby.
- If electromagnetic interference occurs between this product and other "radio stations"\*, move this product to another location or stop using this product.

\* Other "radio stations" refer to industrial, scientific and medical devices using the 2.4 GHz band, the same as this product, other radio stations of this type, licensed radio station premises for a mobile object identification system that is used in factory production lines, certain non-licensed low power radio stations, and amateur radio stations.

## WARNING

-  Do not use in equipment which may cause serious effects due to it malfunctioning. There are rare cases in which an external radio wave at the same frequency, or the radio wave emitted from a mobile phone, causes this product to malfunction, slow down, or fail to operate.
  - Do not use this product in places where radio wave usage is prohibited, such as hospitals. Radio waves of this product may affect electronic devices and medical devices (for example pacemakers).
  - Due to the possibility of hindering safe navigation of aircraft, use of wireless mouse in aircraft is prohibited by the Civil Aeronautics Act. Turn off the power of the wireless mouse before boarding and do not use after boarding.
- \* ELECOM is not liable for any accidents or any indirect or consequential damage incurred due to the failure of this product.

## How to use

### Items included in this package

The following are included in this package. Verify the package to ensure all items are accounted for prior to using this product. While every effort has been made to ensure proper packaging, in the event that any shortage or damage is discovered, please contact the retailer where the product was purchased.

- **Mouse x 1**
- **Receiver unit x 1**



At the time of shipment, it is stored in the mouse.  
Please remove before use.

•AA alkaline battery for confirming operability × 1



It is pre-inserted in the mouse body. Please remove the battery insulating pull tab before use.

## Name and function of each part



\* This manual uses illustrations of the "M-XGM31DBS" series for explanation.

### ■ Mouse

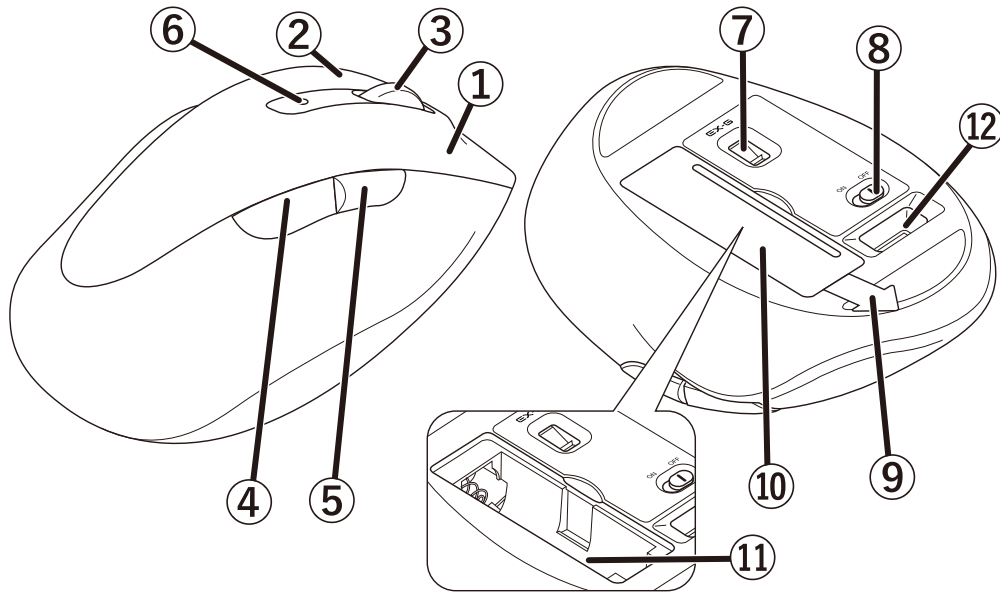

① **Left button**

To left click on your PC.

② **Right button**

To right click on your PC.

③ **Wheel**

Rotate forward and backward or click like a button to operate your PC.

④ **"Back" button**

Perform the "Back" function on the Web browser.

⑤ **"Forward" button**

Perform the "Forward" function on the Web browser.

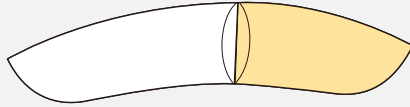

**"Forward" button**  
Continue to next page.

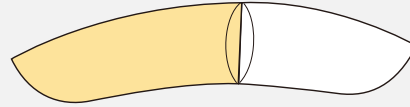

**"Back" button**  
Return to previous page.



You will need to install the "ELECOM Mouse Assistant Mac version" from our website to use the "Back" and "Forward" button on Mac. Please refer to "[Install ELECOM Mouse Assistant](#)".

## ⑥ LED light

- The LED will light up white for a period of time when the mouse is switched ON.
- The LED will blink white during use when the battery level is low.

## ⑦ Optical sensor

The LED will light up blue when the battery is inserted into the mouse.

This sensor will detect mouse movements when you move the mouse.

\* Please note that looking directly into the sensor light may hurt your eyes.

## ⑧ Power switch

Turn the mouse power on (ON) and off (OFF).

## ⑨ Battery insulating tab

Remove this tab before using.

## ⑩ Battery cover

Remove this cover and insert the battery.

## ⑪ Battery storage compartment

Holds the battery.

## ⑫ Receiver unit storage compartment

The receiver unit can be stored here when the mouse is not in use.

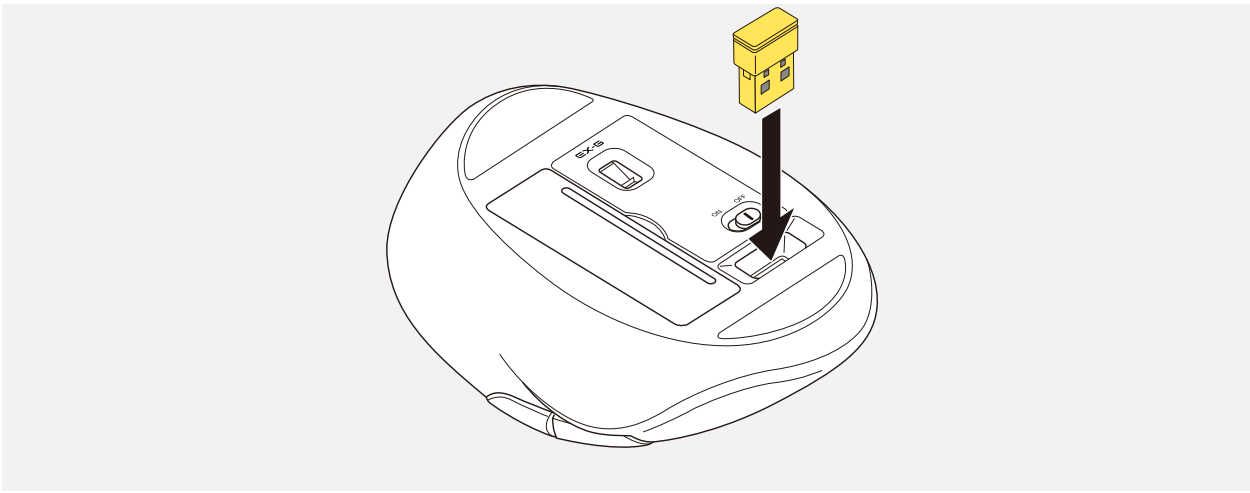

## ■ Receiver unit

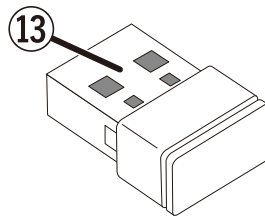

### ⑬ USB connector (male)

Connects to the PC USB-A port

## Connecting and setting up the mouse



## Windows®



### 1. Turn the power ON

1) Remove the battery cover.

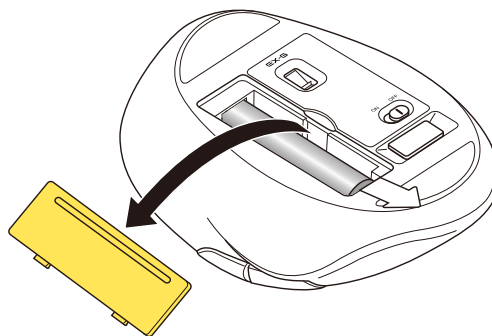

2) Remove the battery insulating tab.



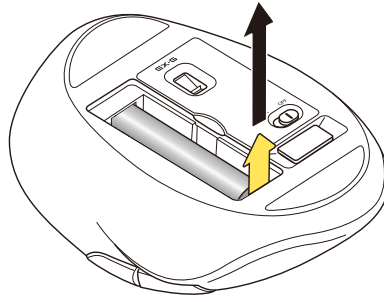

**3) Put the battery cover back on.**

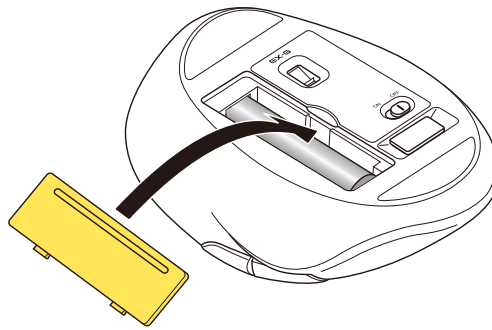

**4) Remove the receiver unit.**

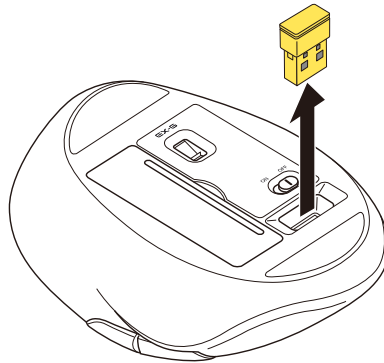

**5) Slide the power switch on the underside of the product to the ON position.**

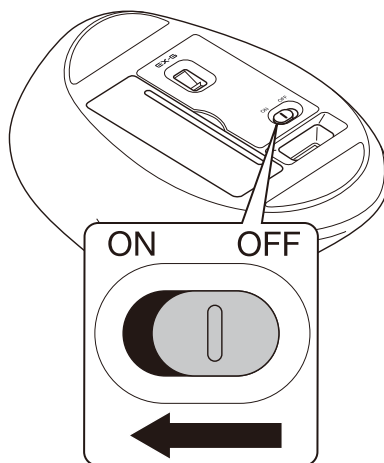

The LED will light up white for a period of time.

\* When the battery level is running low, the LED will blink white for a period of time.



**Power-saving mode**

When the mouse is left untouched for a fixed period of time while the power is ON, it automatically shifts to power-saving mode.

The mouse returns from power-saving mode when it is moved.

\* Mouse operation may be unstable for 2-3 seconds after returning from the power-saving mode.

## Replacing the battery...

### 1) Remove the battery cover.

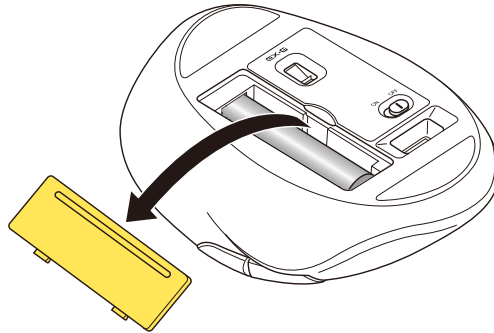

### 2) Remove the battery.

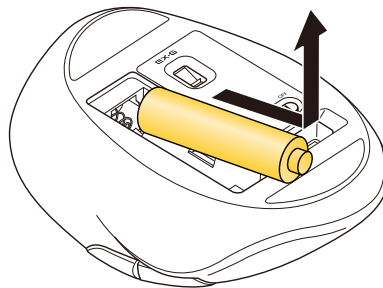

### 3) Insert the battery according to the instructions on the battery compartment.

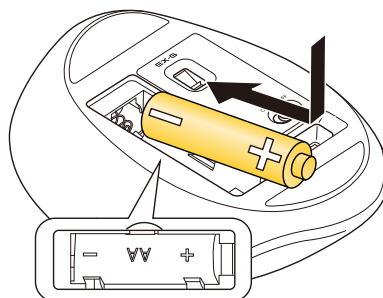

Ensure that the battery is inserted with the positive (+) and negative (-) terminals oriented correctly.

### 4) Put the battery cover back on.

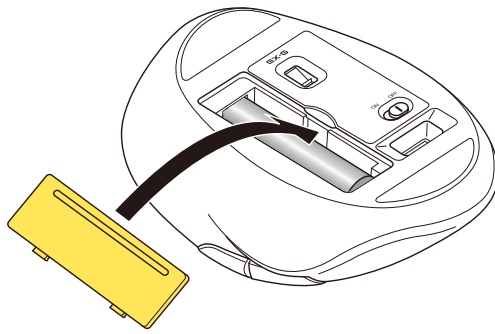

## 2. Connect to a PC

### 1) Start up your PC.

Please wait until your PC has started up and can be operated.

### 2) Insert the receiver unit into the PC's USB-A port.

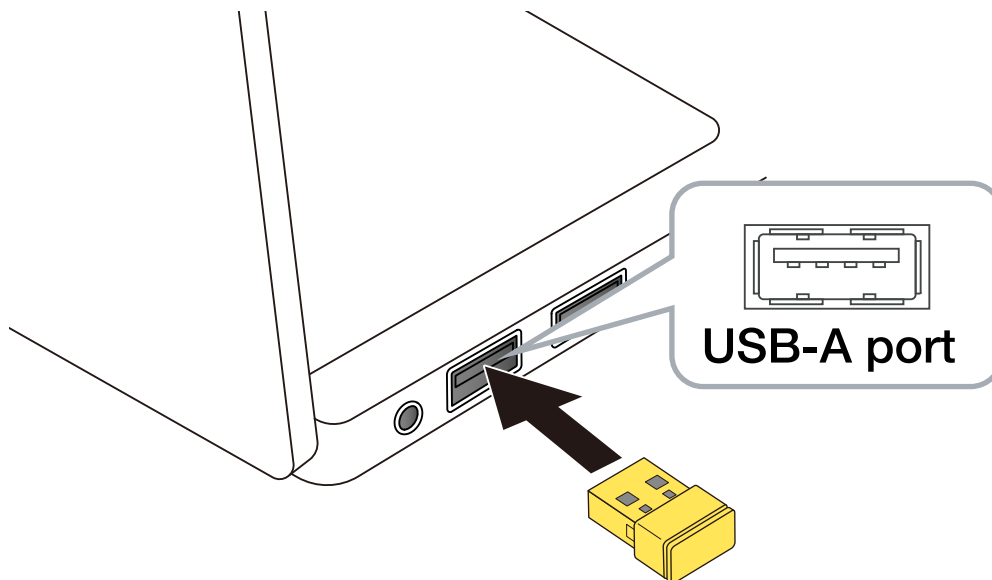

You may use any USB-A port.



- Ensure that the connector is correctly oriented to the port.
- If there is strong resistance when inserting, check the shape and orientation of the connector. Forcibly inserting the connector may damage the connector, and there is a risk of injury.
- Do not touch the terminal portion of the USB connector.



#### **When removing the receiver unit**

This product supports hot plugging. The receiver unit can be removed while the PC is on.

### 3) The driver will be automatically installed, and you will then be able to use the mouse.

**You can now use the mouse.**

By downloading and installing the "ELECOM Mouse Assistant" from our company website, functions such as button assignment function and presentation mode can be used. Please proceed to "[Install](#)

## Change the mouse pointer speed

Adjust the mouse pointer movement speed on your PC if the mouse pointer moves too fast or too slow.

### ■ For Windows 11

#### 1) Click on "Start" on the bottom of the screen and click on "Settings".

The "Settings" page will appear.

#### 2) Click on "Bluetooth & devices" and then "Mouse".

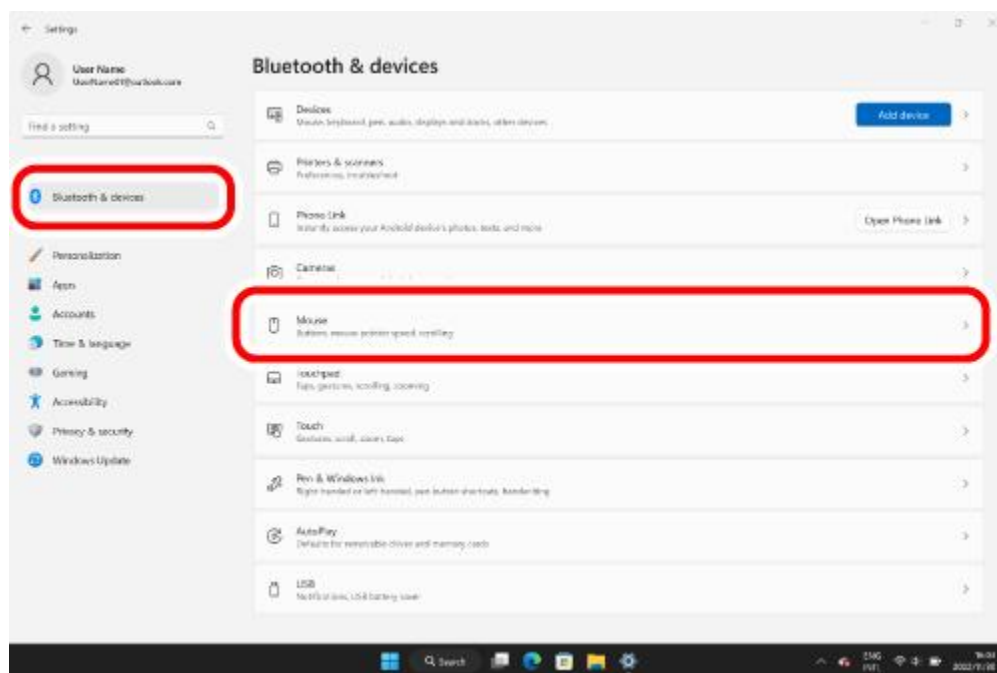

#### 3) Adjust the "Mouse pointer speed" slider bar to adjust the mouse pointer movement speed.

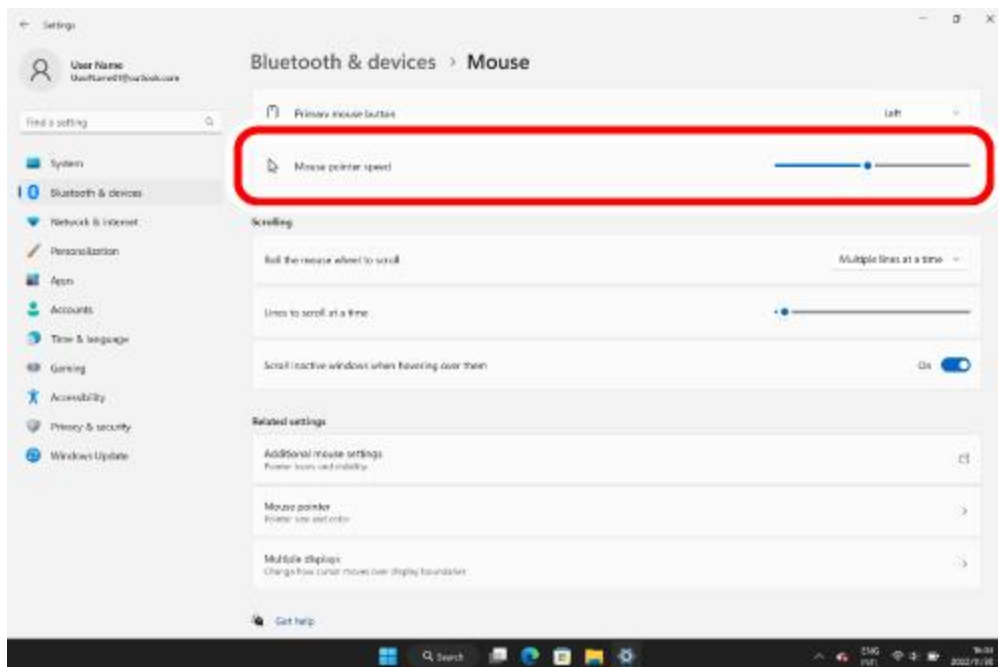

## ■ For Windows 10

### 1) Open "Mouse" properties.

From the Start menu, click the Settings icon, select "Devices" → "Mouse", then click "Additional mouse options" under "Related settings".

### 2) Select the "Pointer Options" tab.

3) Adjust the "Select a pointer speed" slider bar to adjust the mouse pointer movement speed.

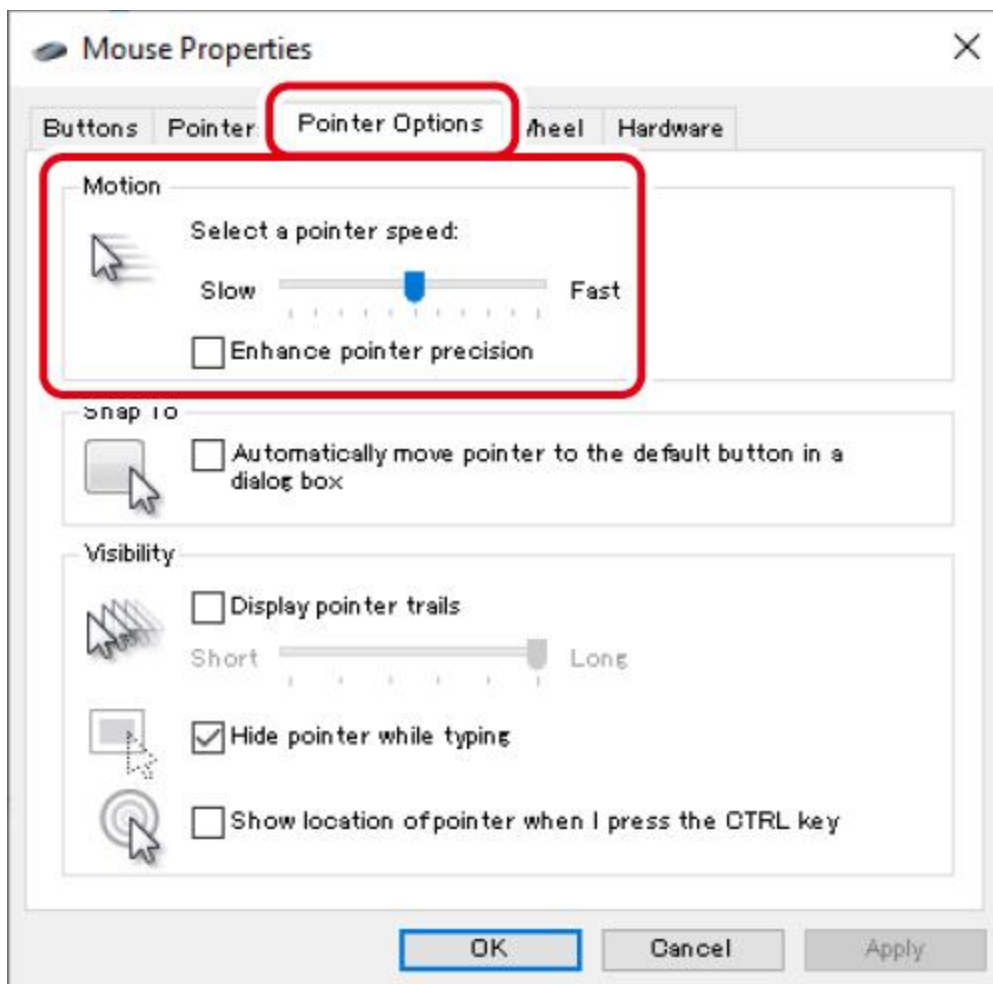

## Change the number of lines scrolled in one wheel turn

### ■ For Windows 11

1) Click on "Start" on the bottom of the screen and click on "Settings".

The "Settings" page will appear.

2) Click on "Bluetooth & devices" and then "Mouse".

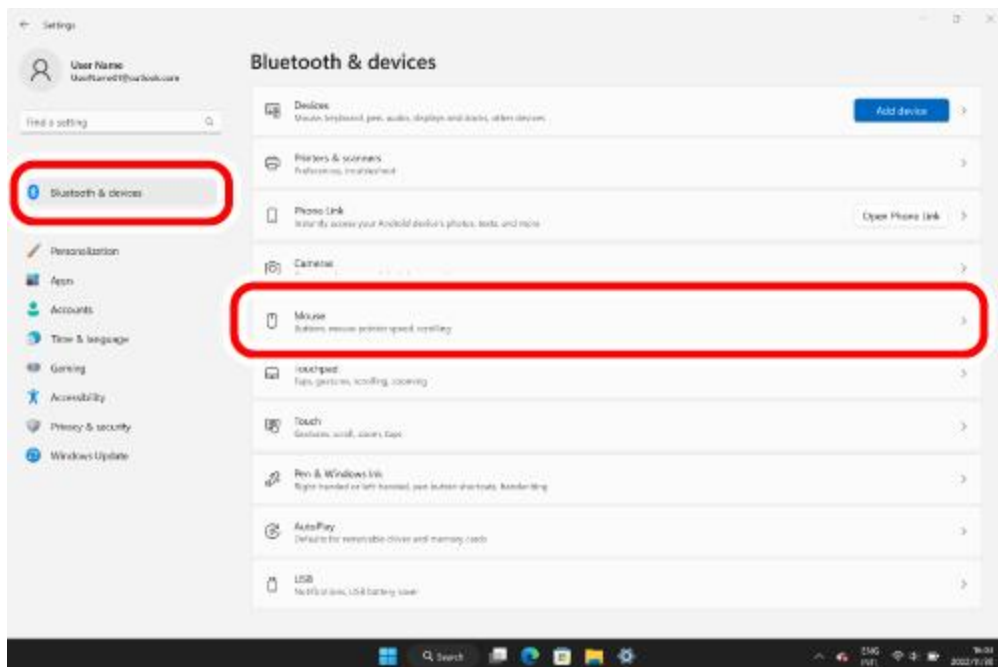

3) Adjust the “Lines to scroll at a time” slider bar to adjust the number of lines per scroll.

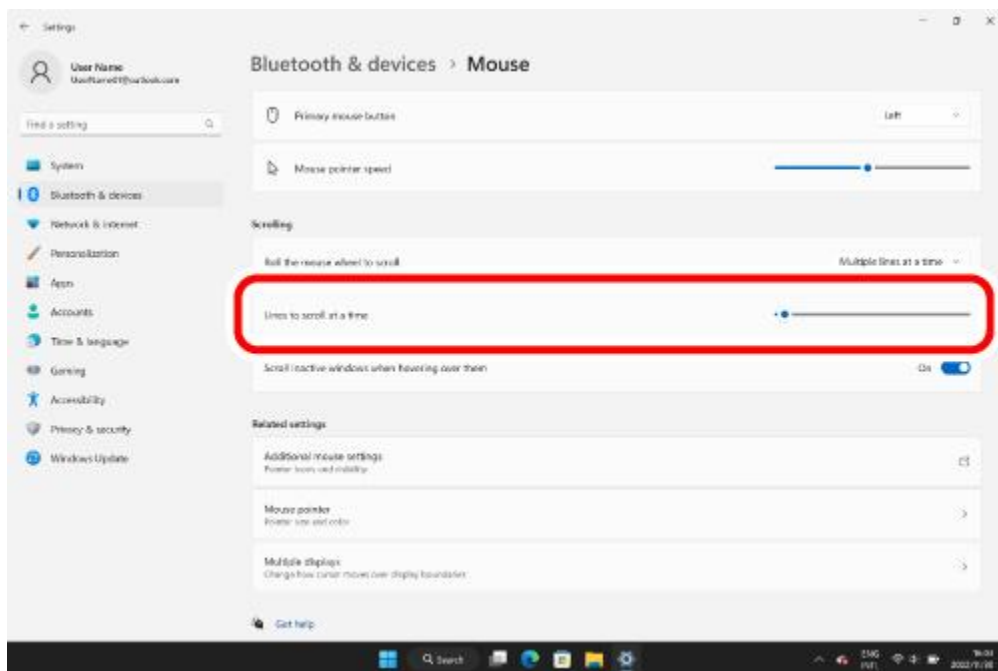

## ■ For Windows 10

### 1) Open “Mouse” properties.

From the Start menu, click the Settings icon, select “Devices” → “Mouse”, then click “Additional mouse options” under “Related settings”.

### 2) Select the “Wheel” tab.

3) Change the value of “The following number of lines at a time” under “Roll the wheel one notch to scroll”

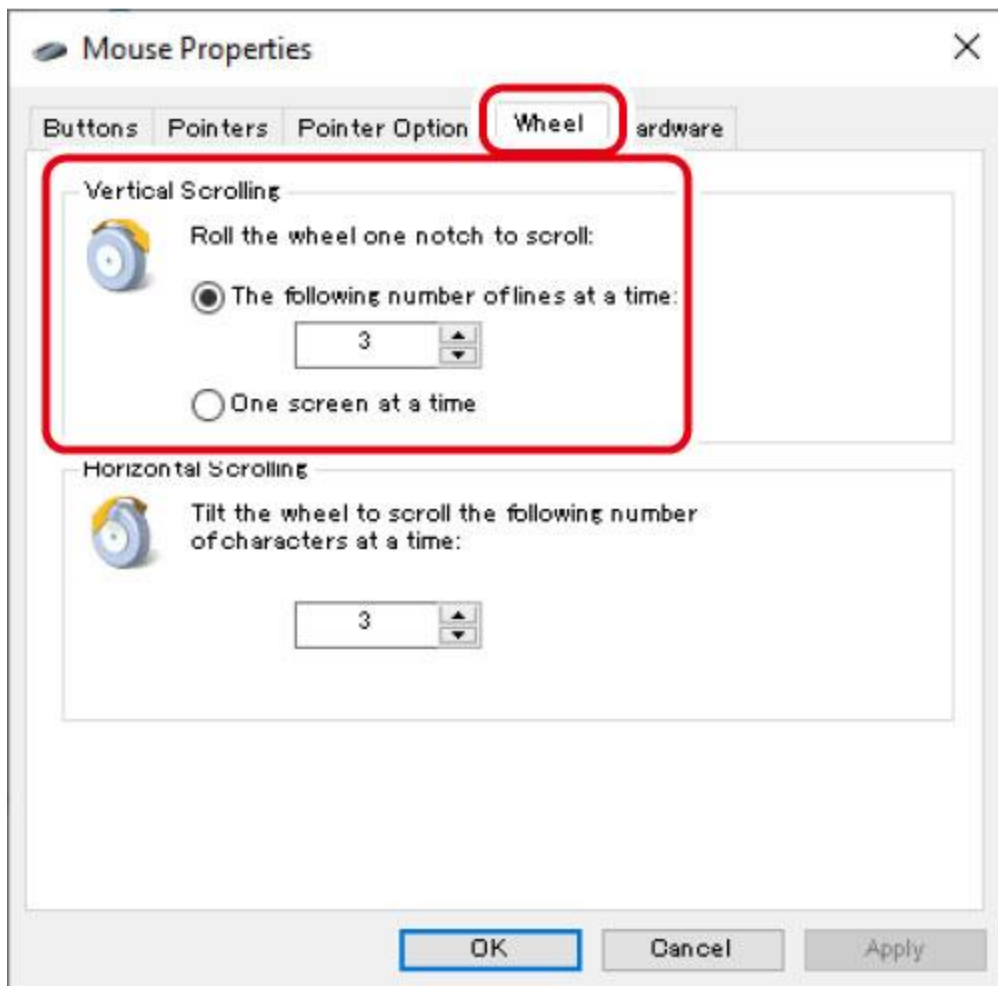

## Mac



### 1. Turn the power ON

1) Remove the battery cover.

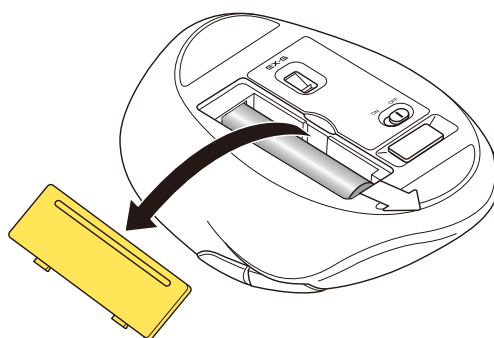

2) Remove the battery insulating tab.

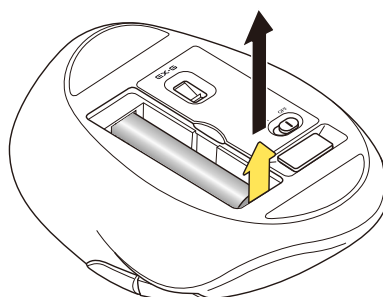



**3) Put the battery cover back on.**

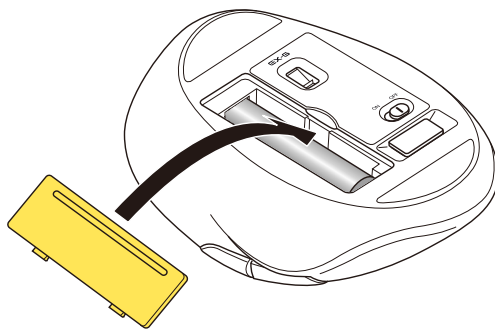

**4) Remove the receiver unit.**

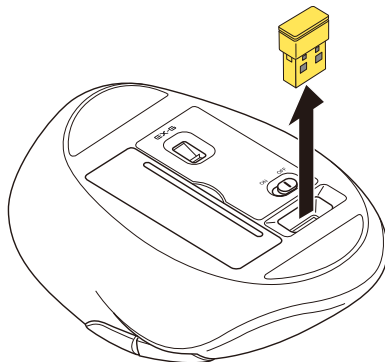

**5) Slide the power switch on the underside of the product to the ON position.**

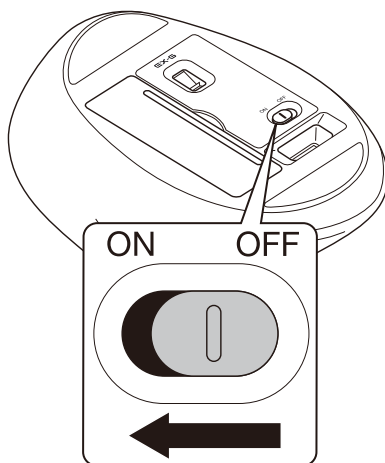

The LED will light up white for a period of time.

\* When the battery level is running low, the LED will blink white for a period of time.



#### **Power-saving mode**

When the mouse is left untouched for a fixed period of time while the power is ON, it automatically shifts to power-saving mode.

The mouse returns from power-saving mode when it is moved.

\* Mouse operation may be unstable for 2-3 seconds after returning from the power-saving mode.

### **Replacing the battery...**

**1) Remove the battery cover.**

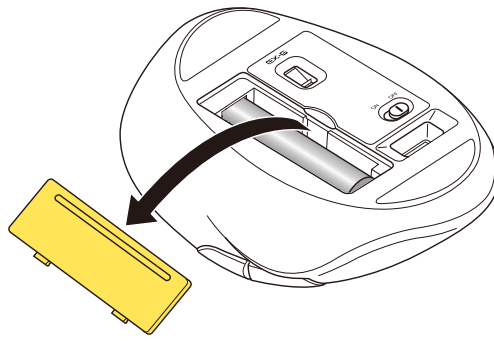

**2) Remove the battery.**

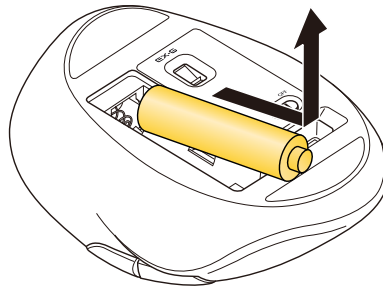

**3) Insert the battery according to the instructions on the battery compartment.**

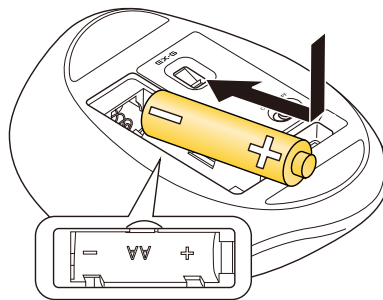

Ensure that the battery is inserted with the positive (+) and negative (-) terminals oriented correctly.

**4) Put the battery cover back on.**

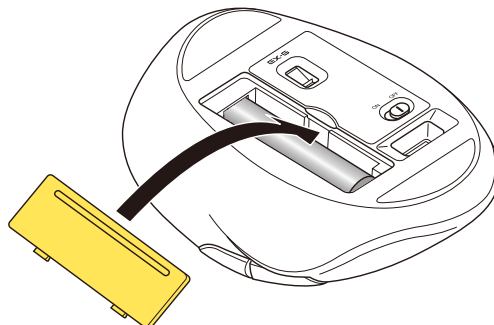

## **2. Connect to a PC**

**1) Start up your PC.**

Please wait until your PC has started up and can be operated.

## 2) Insert the receiver unit into the PC's USB-A port.

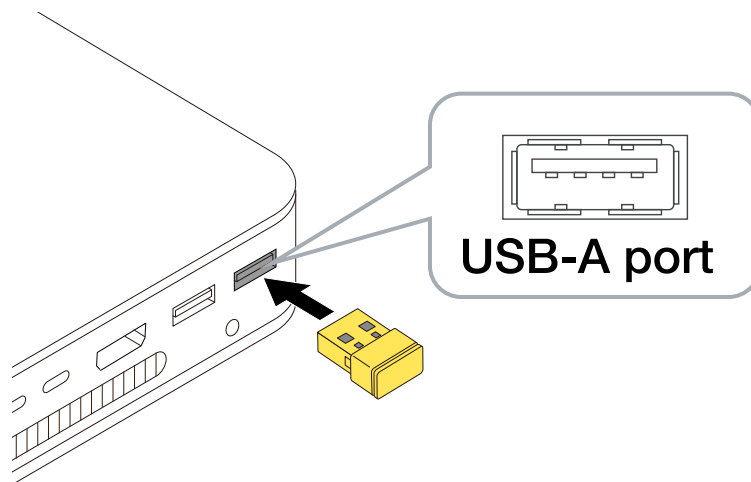

You may use any USB-A port.



• For terminals that do not have a USB-A port, such as a MacBook, use the USB Type-C® hub.

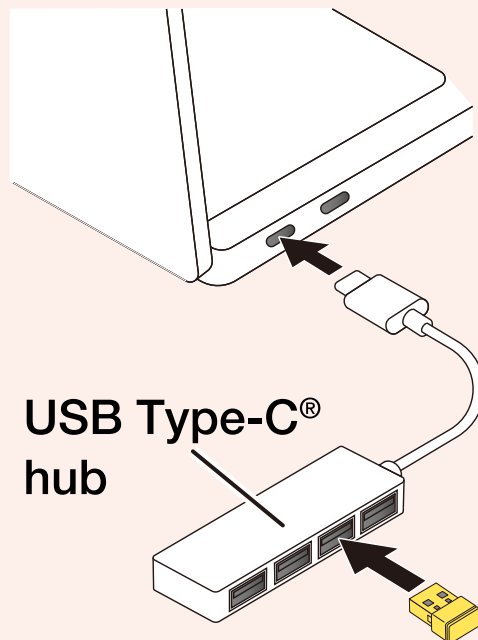

- Ensure that the connector is correctly oriented to the port.
- If there is strong resistance when inserting, check the shape and orientation of the connector. Forcibly inserting the connector may damage the connector, and there is a risk of injury.
- Do not touch the terminal portion of the USB connector.



### When removing the receiver unit

This product supports hot plugging. The receiver unit can be removed while the PC is on.

## 3) The driver will be automatically installed, and you will then be able to use the mouse.

You can now use the mouse.

By downloading and installing the "ELECOM Mouse Assistant" from our company website, functions such as button assignment function and presentation mode can be used. Please proceed to "[Install ELECOM Mouse Assistant](#)".

## Change the mouse pointer speed

Adjust the mouse pointer movement speed on your PC if the mouse pointer moves too fast or too slow.

### 1) Click "Mouse" under "System Settings".

The "Mouse" settings page will load up.

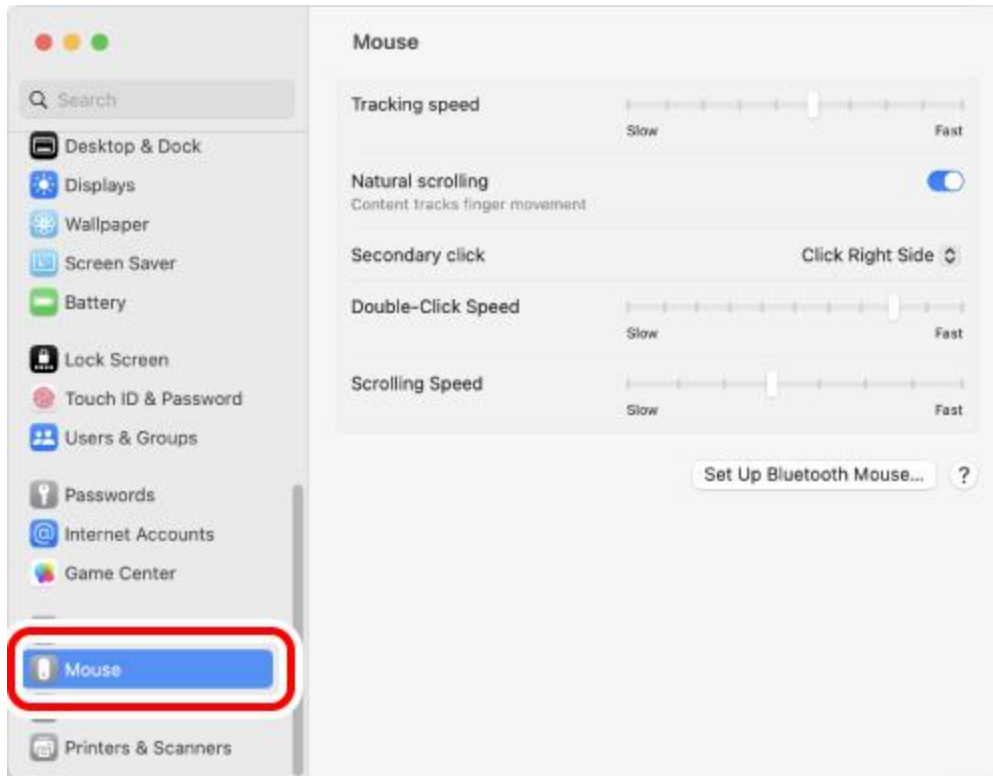

### 2) Adjust the "Tracking speed" slider to adjust the speed of the mouse pointer.

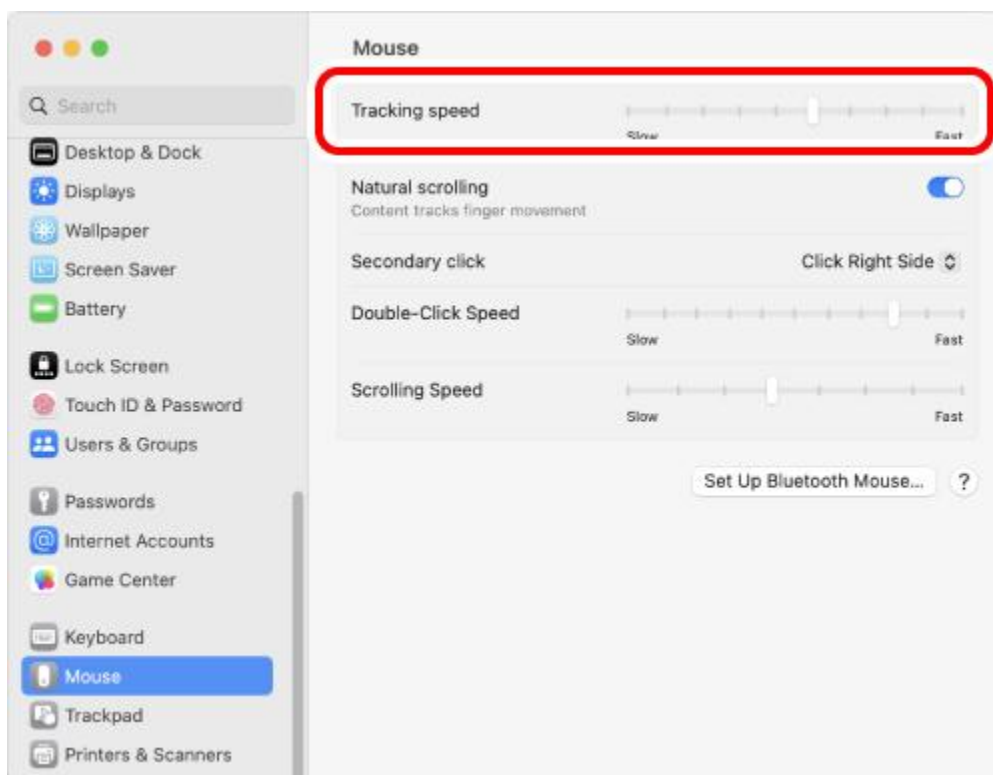



Unchecking "Natural scrolling" will cause the scroll direction to be reversed.

## ChromeOS



### 1. Turn the power ON

1) Remove the battery cover.

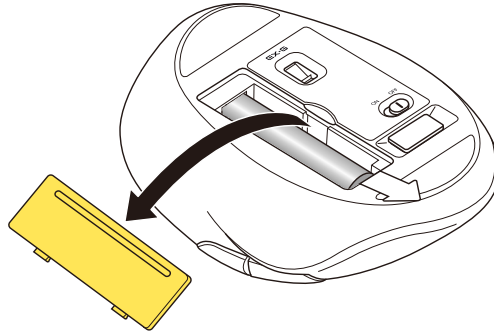

2) Remove the battery insulating tab.

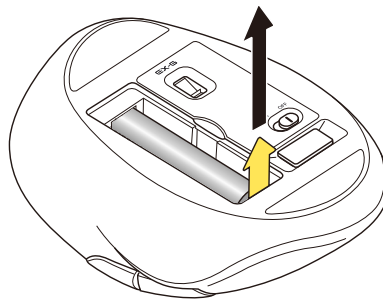

3) Put the battery cover back on.

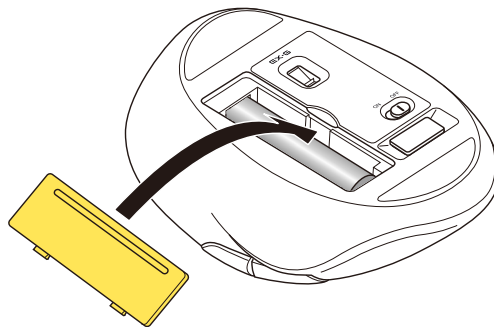

4) Remove the receiver unit.

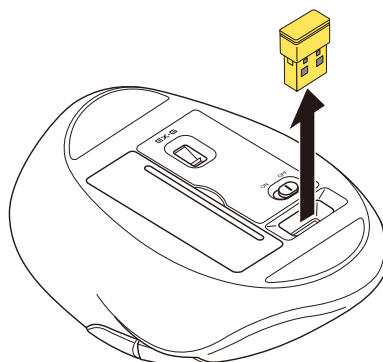

5) Slide the power switch on the underside of the product to the ON position.

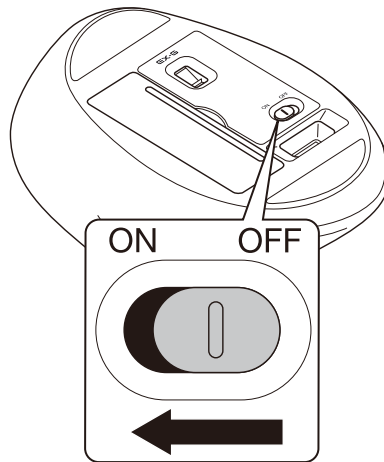

The LED will light up white for a period of time.

\* When the battery level is running low, the LED will blink white for a period of time.



#### **Power-saving mode**

When the mouse is left untouched for a fixed period of time while the power is ON, it automatically shifts to power-saving mode.

The mouse returns from power-saving mode when it is moved.

\* Mouse operation may be unstable for 2-3 seconds after returning from the power-saving mode.

### **Replacing the battery...**

1) Remove the battery cover.

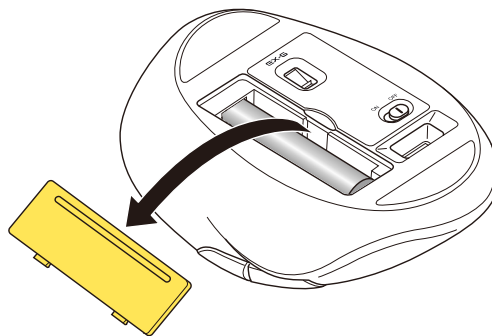

2) Remove the battery.

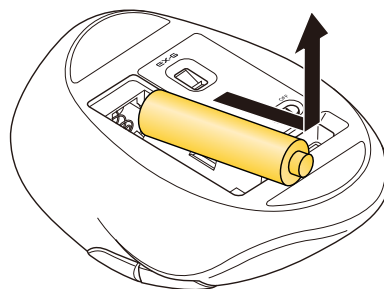

3) Insert the battery according to the instructions on the battery compartment.

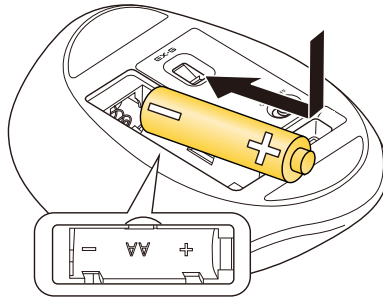

Ensure that the battery is inserted with the positive (+) and negative (-) terminals oriented correctly.

#### 4) Put the battery cover back on.

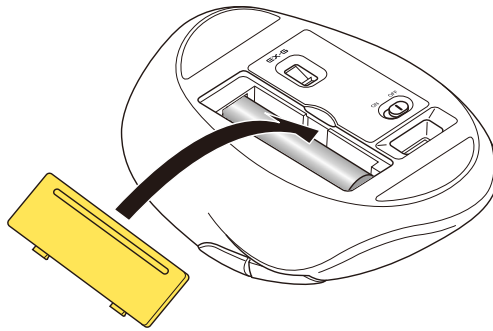

## 2. Connect to a PC

### 1) Start up your PC.

Please wait until your PC has started up and can be operated.

### 2) Insert the receiver unit into the PC's USB-A port.

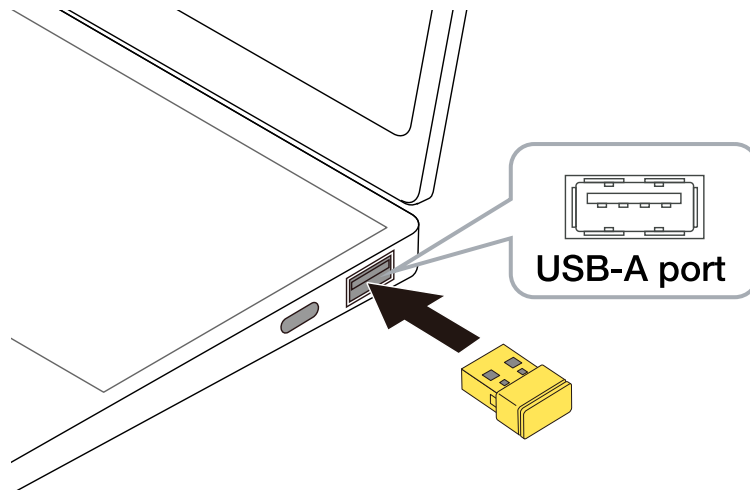

You may use any USB-A port.



\* For devices that do not have a USB-A port, please use a USB Type-C® hub.

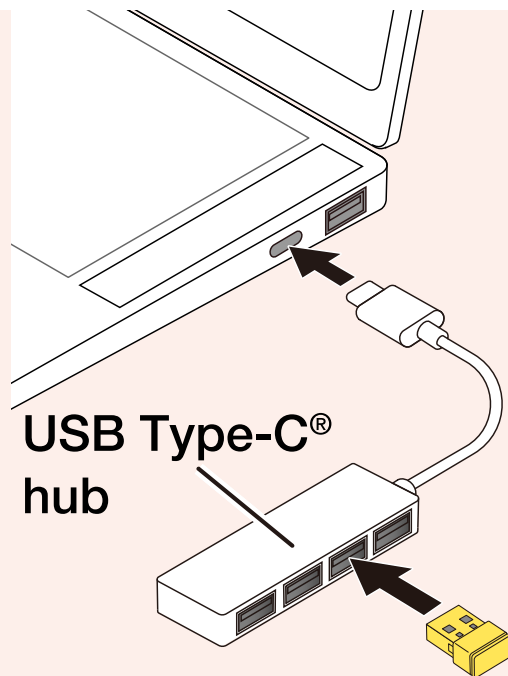

- Ensure that the connector is correctly oriented to the port.
- If there is strong resistance when inserting, check the shape and orientation of the connector. Forcibly inserting the connector may damage the connector, and there is a risk of injury.
- Do not touch the terminal portion of the USB connector.



#### **When removing the receiver unit**

This product supports hot plugging. The receiver unit can be removed while the PC is on.

**3) The driver will be automatically installed, and you will then be able to use the mouse.**

**You can now use the mouse.**

### **Change the mouse pointer speed**

Adjust the mouse pointer movement speed on your PC if the mouse pointer moves too fast or too slow.

**1) Click on the quick settings panel on the bottom right.**

**2) Click on "Settings".**

The settings page will appear.



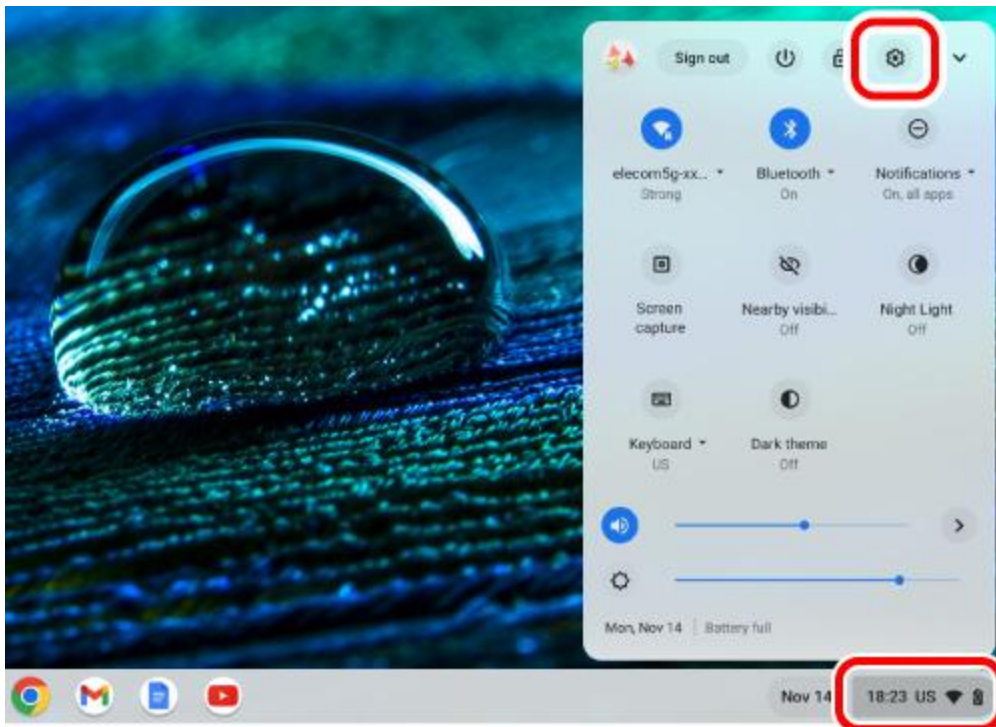

3) Click on “Mouse and touchpad” under “Device”.

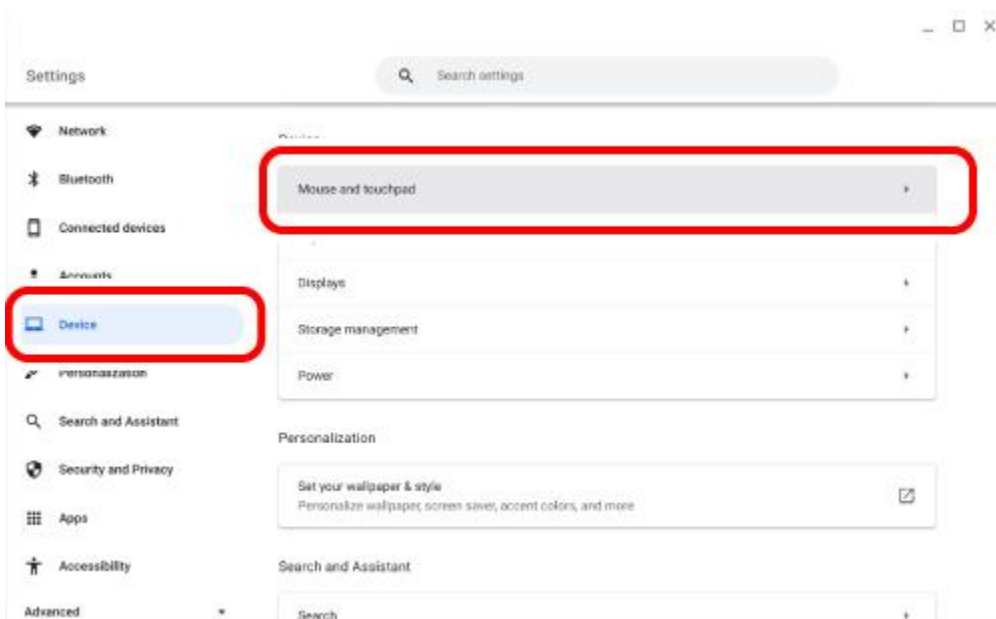

4) Adjust the “Mouse speed” slider to adjust the speed of the mouse pointer.

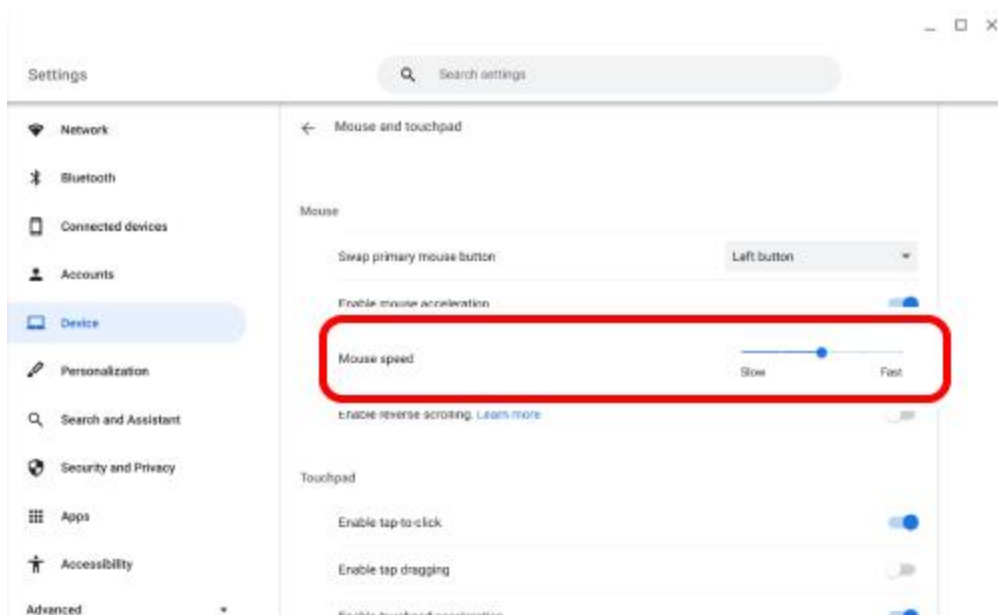

## Install ELECOM Mouse Assistant



To use the function assignment function, fast scroll function and presentation mode with this product, the ELECOM Mouse Assistant must be installed.

“ELECOM Mouse Assistant” is a software that allows you to use the mouse more effectively.

Using ELECOM Mouse Assistant, users can set the functions they want to the unique buttons and use them to perform the operations they want.

### ■ Get ELECOM Mouse Assistant

Please visit our homepage below and download the latest version of the application.

> The download page is [here](#).

## Specifications



Connector type	USB-A connector
Connection method	USB 2.4 GHz wireless
Compatible models	USB port-equipped Windows OS, macOS, and ChromeOS devices
Supported OS	Windows 11, Windows 10, macOS Ventura (13), ChromeOS * Update for each new version of the OS or the installation of a service pack might be required.

Sensor Resolution	2000 DPI
Communication method	GFSK
Radio frequency	2.4 GHz
Radio wave range	When used on magnetic surfaces such as metal desks: 3 m, When used on non-magnetic surfaces such as wooden desks: 10 m * These values were obtained in ELECOM's test environment and are not guaranteed.
Read method	BlueLED
Buttons	5 * including wheel button
Number of wheels	1
Battery life	Maximum duration approximately 23 months (estimated operating time when using alkaline batteries) * May vary depending on the environment.
Power source	Any 1 of AA alkaline battery, AA manganese battery or AA nickel-metal hydride rechargeable battery
Rated voltage	1.5 V
Dimensions (main unit) (W x D x H)	M-XGS31DBS series: approximately 71 × 108 × 52 mm / 2.8 × 4.3 × 2.1 in. M-XGM31DBS series: approximately 75 × 114 × 55 mm / 3 × 4.5 × 2.2 in. M-XGL31DBS series: approximately 79 × 120 × 58 mm / 3.1 × 4.7 × 2.3 in. M-XGXL31DBS series: approximately 82 × 126 × 61 mm / 3.2 × 5 × 2.4 in.
Dimensions (receiver) (W x D x H)	Approximately 15 × 20 × 7 mm / 0.6 × 0.8 × 0.3 in.
Size category	M-XGS31DBS series: S size M-XGM31DBS series: M size M-XGL31DBS series: L size M-XGXL31DBS series: XL size

Weight (main unit)	M-XGS31DBS series: approximately 82 g / 2.9 oz M-XGM31DBS series: approximately 91 g / 3.2 oz M-XGL31DBS series: approximately 100 g / 3.5 oz M-XGXL31DBS series: approximately 110 g / 3.9 oz * excluding battery
Weight (receiver unit)	Approximately 2 g / 0.1 oz
Operating environment conditions	Temperature: 5 °C to 40 °C / 41 °F to 104 °F; humidity: up to 90 % RH (without condensation)
Storage environment conditions	Temperature -10 °C to 60 °C / 14 °F to 140 °F; humidity: up to 90 % RH (without condensation)
Accessories	AA alkaline battery for confirming operability × 1

## Troubleshooting



### When disinfecting the mouse



#### IMPORTANT

 **Do not spray any liquid onto the product directly.**

Doing so can cause electric malfunctions.

 **Never apply hot water.**

Doing so can cause electric malfunctions.

 **Do not use organic solvents or ultraviolet lights.**

Usage can result in deterioration of the housing components or paints, which can cause damage to the exterior.

 **We recommend the usage of disposable gloves.**

 **Please unplug the USB connector from this product and the PC.**

 **When using any alcohol-based products, please check that it is appropriate for the specific purpose and that it is used properly.**

---

 **Please note that in the event that damage or abnormal operation to the product is caused by the cleaning process, the customer will be fully responsible for the cost of repair.**

---

 **We recommend that you disinfect your hands before and after using PCs and peripheral devices that are used by multiple people in order to prevent the spread of infection through the equipment.**

---



Gently soak a cleaning cloth, such as a microfiber cloth, in the disinfectant solution. Make sure there are no loose droplets and gently wipe the product using the cloth.

After wiping, dry thoroughly and wipe off any residual liquid.

\* Do not spray any liquid onto the product directly. Doing so can cause electric malfunctions.

## When the mouse is not working properly



Try the following if the mouse operates abnormally.

① **Check that the mouse is turned ON.**

② **Check that the battery is inserted correctly and that it is not depleted.**

• The protective film may have been left on the battery. Remove the protective film from the battery before reinserting the battery.

• Ensure that the battery is inserted with the terminals in the right orientation.

• The mouse operation will become unstable when the battery is low. Refer to “Replacing the battery...” and replace with a new battery as soon as possible.

The alkaline battery included with this product is only for confirming operability. The battery will discharge naturally during the distribution process of the product.

\* Turning off the power when the mouse is not used for a long period of time can extend the battery life.

③ **Change the positions of the PC and the mouse.**

• This wireless device uses the 2.4 GHz band. Please use the mouse within range of the PC.



### **Average radio wave range**

Non-magnetic surface (such as wooden desks): approximately 10 m

Magnetic surface (such as steel desks): approximately 3 m

\* These values were obtained in ELECOM's test environment and are not guaranteed. The 2.4 GHz band signal may be shorter depending on the environment you use it in.

④ **Please reboot the PC.**

- The mouse may become unstable depending on the PC. Please restart the PC.

⑤ **Please update your PC's OS to the latest version.**

- The mouse may become unstable when the PC version is old. Please update your PC's OS to the latest version.

⑥ **Please change the connection of the receiver unit.**

Depending on the specifications of the PC's USB port or USB hub, other USB 3.0 devices used simultaneously with the mouse may generate noise that can worsen the 2.4 GHz signal in the vicinity.



**Examples of USB devices that may degrade the 2.4 GHz band signal**

- USB memory
- Hard disk or SSD
- Optical disk drive
- Card reader / writer
- LAN adapter
- Others, all devices communicating data with a PC via USB 3.0.

You may be able to improve the situation with the following method.

- **Connect the mouse receiver unit to another USB port away from other USB 3.0 devices that are simultaneously in use.**



- **Connect the mouse receiver unit to a USB 2.0 USB hub or extension cable.**

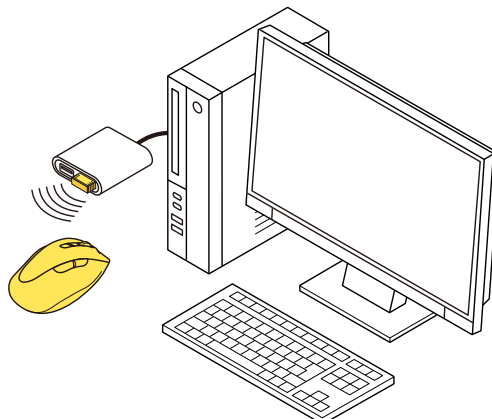

⑦ **Check the energy saver settings on the connected device. (When using Windows® PC)**

On Windows, in order to reduce power consumption depending on the PC, the power of the USB-connected product is set to turn off automatically.

You can change the settings in the following ways:

**For Windows 11**

1) Click the "Start" button at the bottom of the screen.

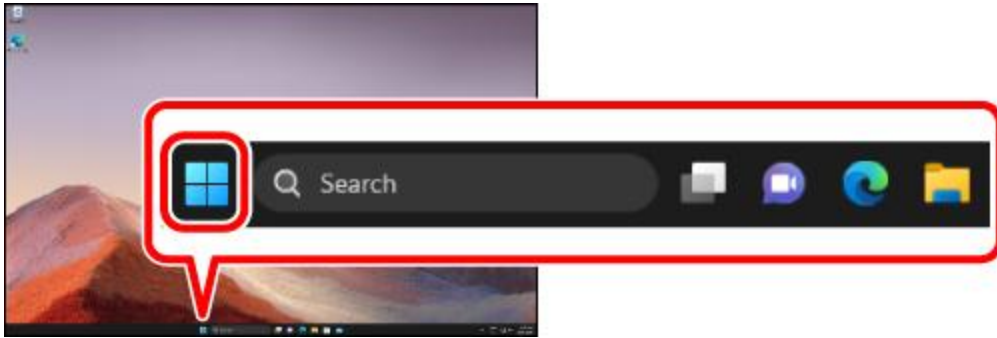

2) Click "All apps".

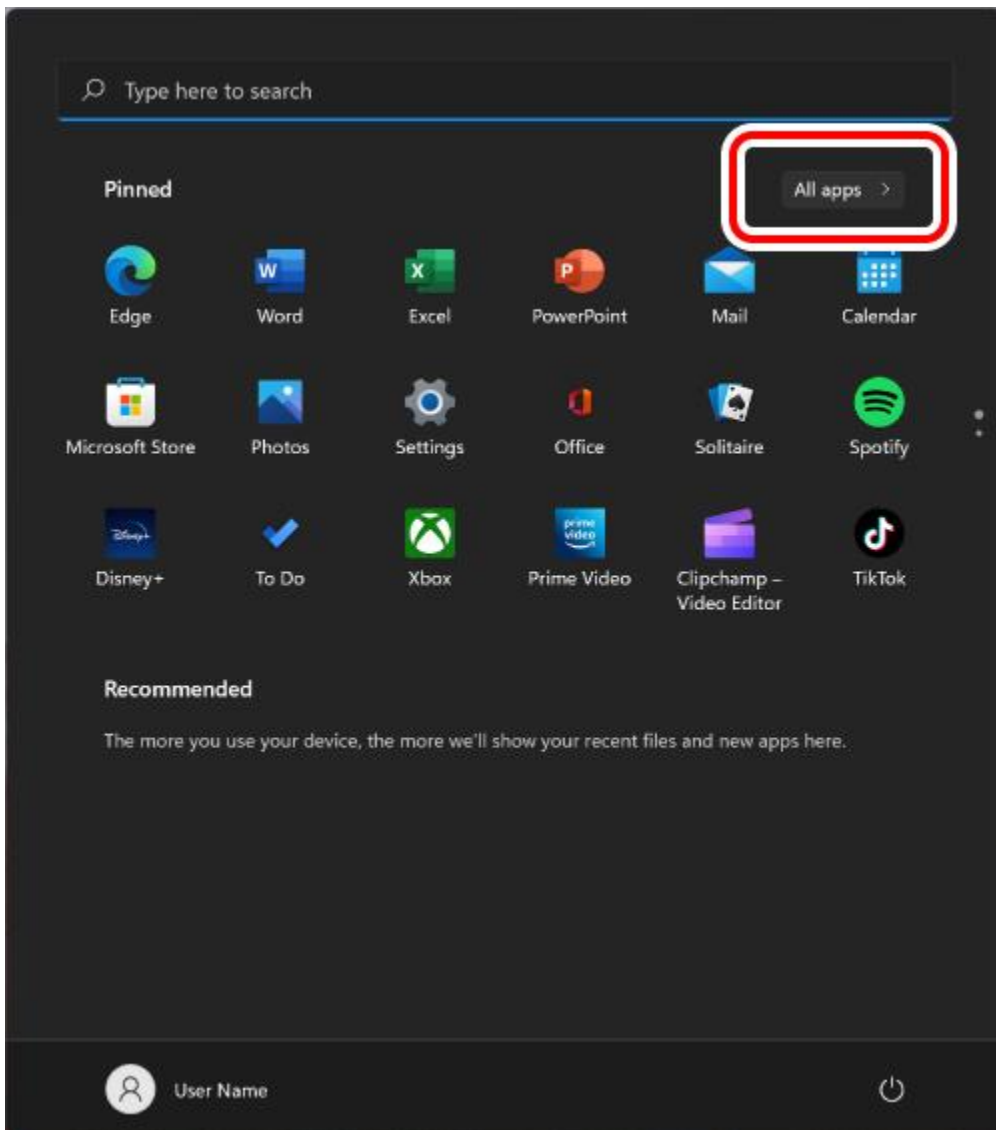

3) Click "Windows Tools".

The "Windows Tools" screen will appear.

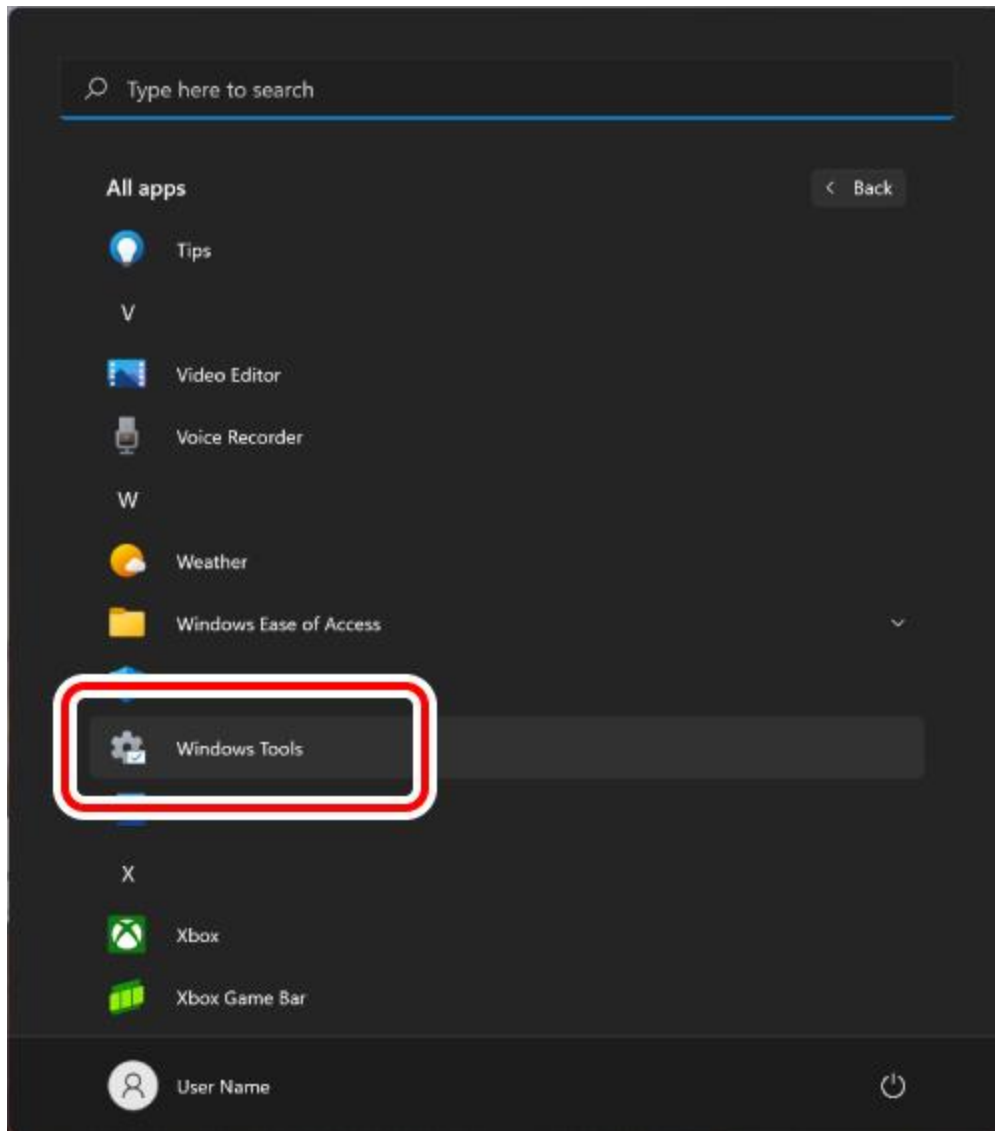

4) Double-click "Control Panel".

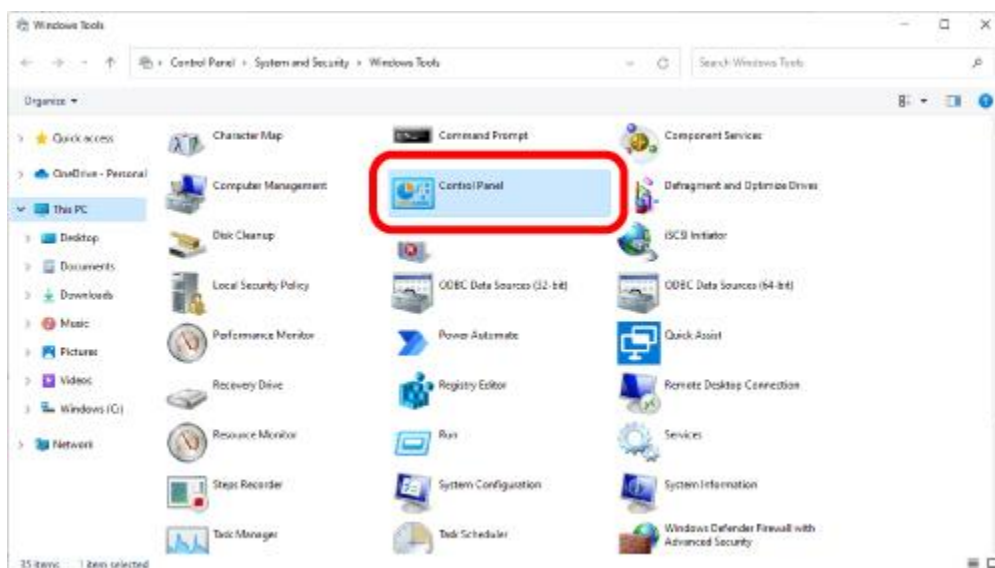

5) Click "System and Security".



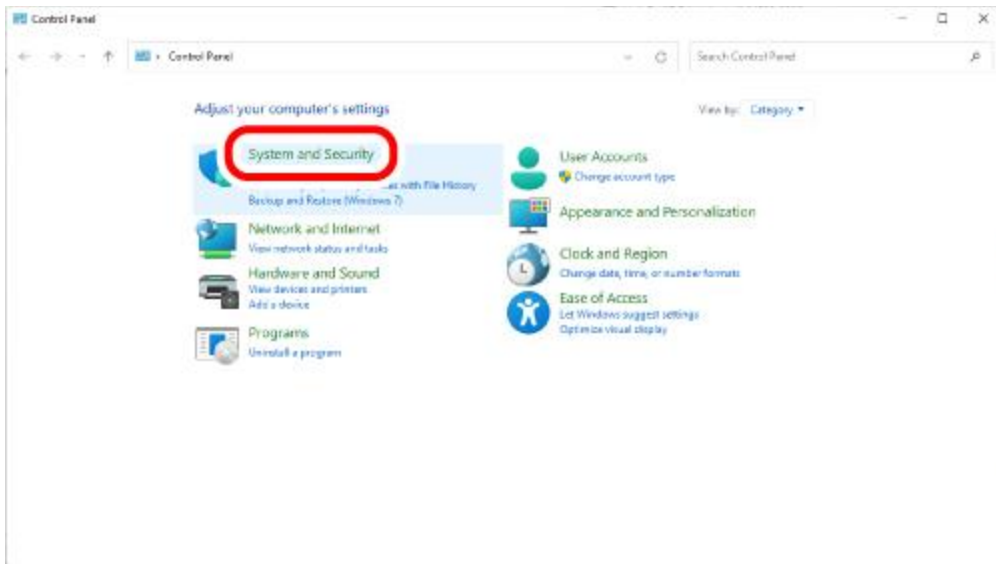

6) Click "Power Options".

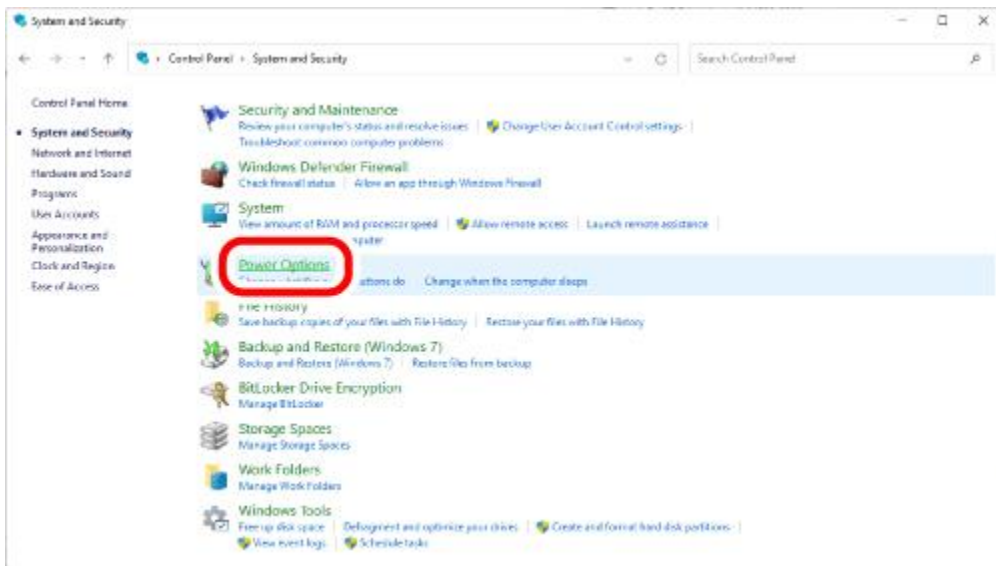

7) Click "Change plan settings" to the right of the item selected in "Power Plan".

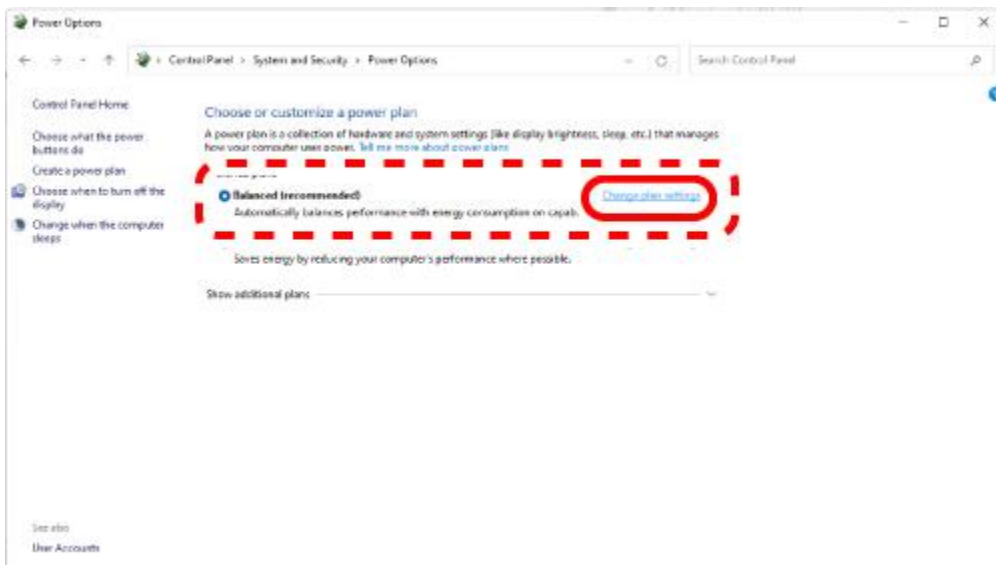

8) On the "Edit Plan Settings" screen, click "Change advanced power settings".

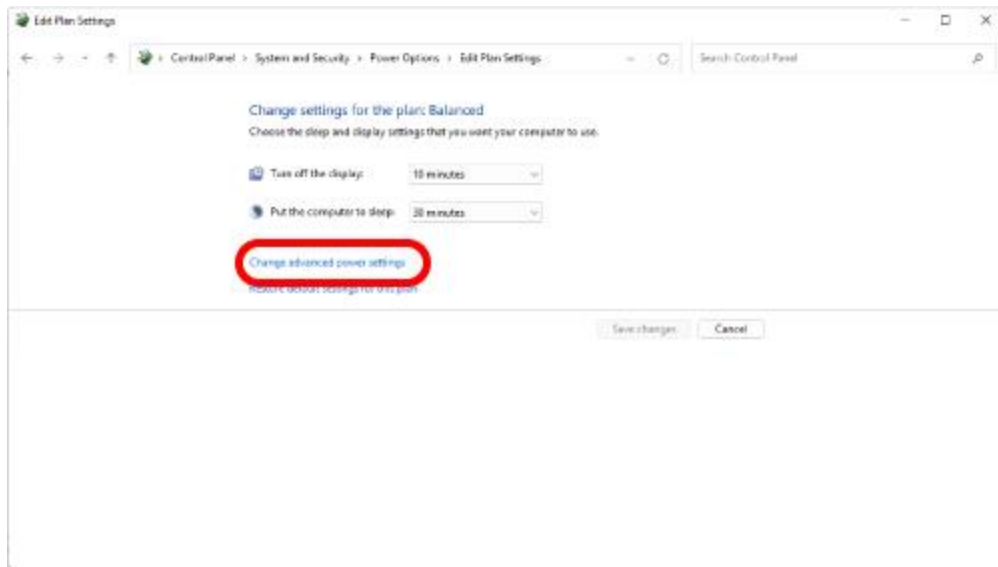

9) On the "Power Options" screen, click the "+" mark in "USB settings" from the list, and then click the "+" mark in "USB Selective Suspend Settings".

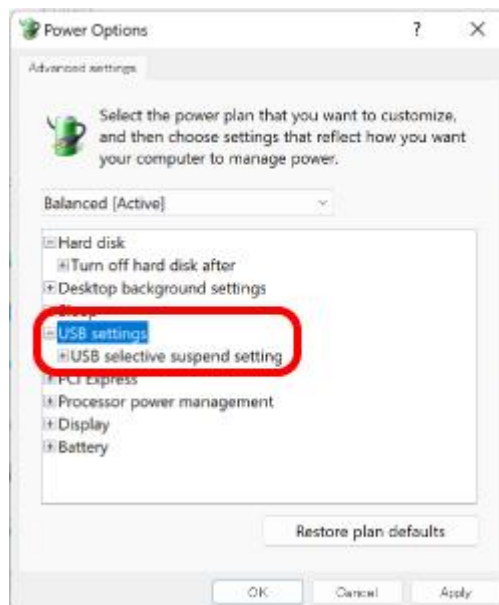

10) In the drop box next to "Settings", select "Disable".

If you are using a laptop, there are two items instead of "Settings": "On battery" and "Plugged in". In that case, please set the "Plugged in" setting to "Disable".

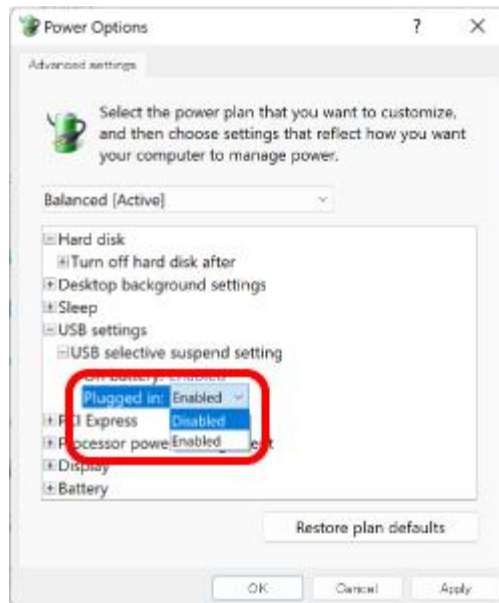

11) Click "OK" to confirm the settings.

12) Click the "X" (close) in the upper right corner to close "Edit Plan Settings".

## For Windows 10

1) Right-click the Start button at the bottom left of the screen, click "Power Options", and then click "Additional power settings" under "Related settings" on the right side of the "Power & sleep" screen.

2) Click "Change plan settings" on the right side of the item selected in "Power Plan".

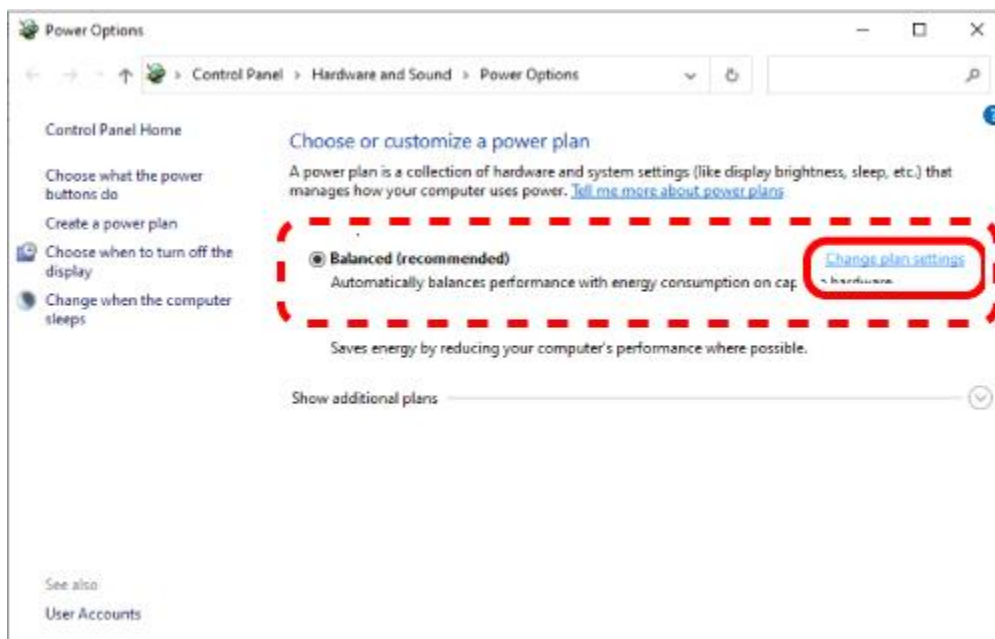

3) On the "Edit Plan Settings" screen, click "Change advanced power settings".

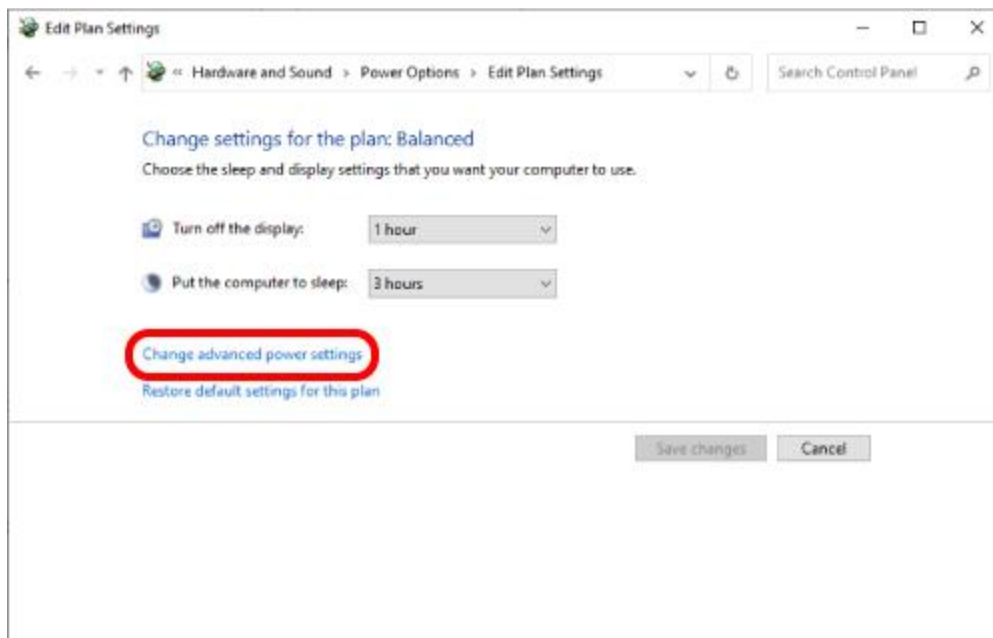

4) On the "Power Options" screen, click the "+" mark in "USB settings" from the list, and then click the "+" mark in "USB Selective Suspend Settings".

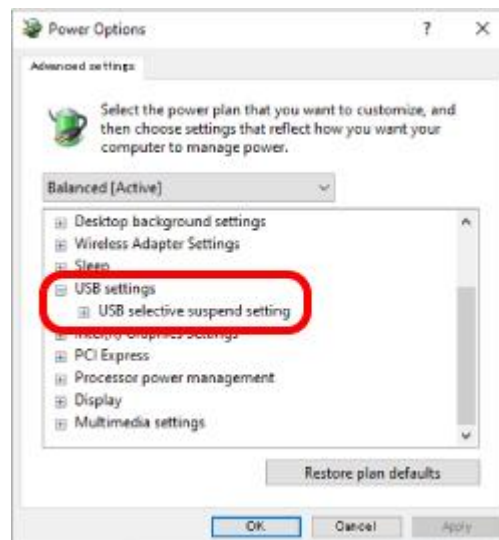

5) In the drop box next to "Settings", select "Disable".

If you are using a laptop, there are two items instead of "Settings": "On battery" and "Plugged in". In that case, please set the "Plugged in" setting to "Disable".

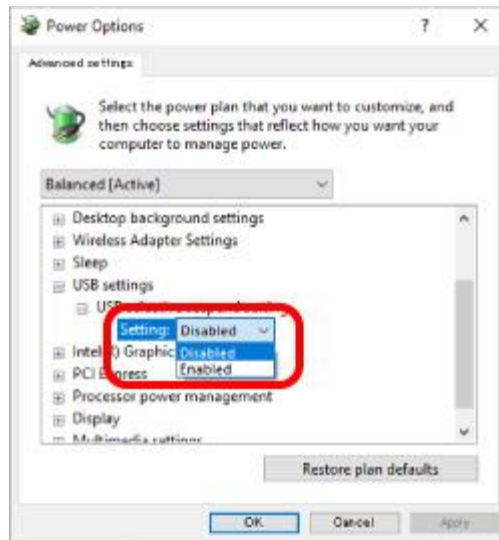

6) Click "OK" to confirm the settings.

7) Click the "X" (close) in the upper right corner to close "Edit Plan Settings".

## Compliance status



**Model/모델명:** M-XGXL31DBS, E02A

[www.elecom.co.jp/global/certification/](http://www.elecom.co.jp/global/certification/)

### ▼ China / 中国

**RoHS Compliance (产品中有毒有害物质或元素的名称及含量)**

[https://www.elecom.co.jp/global/certification/pdf/RoHS\\_China.pdf](https://www.elecom.co.jp/global/certification/pdf/RoHS_China.pdf)

### ▼ EU



**CE Declaration of Conformity**

[https://www.elecom.co.jp/global/certification/pdf/CE\\_DoC.pdf](https://www.elecom.co.jp/global/certification/pdf/CE_DoC.pdf)

**RoHS Compliance**

[https://www.elecom.co.jp/global/certification/pdf/RoHS\\_EU\\_UK\\_Vietnam.pdf](https://www.elecom.co.jp/global/certification/pdf/RoHS_EU_UK_Vietnam.pdf)

**CE Authorised representative:**

Amazon Services Europe S.à r.l

38 avenue John F. Kennedy, L-1855 Luxembourg

**WEEE Disposal and Recycling Information**

This symbol means that waste of electrical and electronic equipment (WEEE) should not be disposed as general household waste. WEEE should be treated separately to prevent possible harm to the environment or human health. Consult your retailer or local municipal office for collection, return, recycle or reuse of WEEE.

**FR: INFORMATION DES CONSOMMATEURS SUR LA RÈGLE DE TRI**

<https://www.elecom.co.jp/global/certification/pdf/FR-Info-Tri.pdf>

**▼ Korea / 대한민국**

인증번호: R-R-ELJ-M-XGXL31DBS

인증번호: R-R-ELJ-E02A

제작자 및 설치자는 해당 무선설비가 전파혼신 가능성이 있으므로 인명안전과 관련된 서비스는 할 수 없습니다.

**▼ Singapore**

Complies with  
IMDA standards  
DA106058.

**Model: M-XGXL31DBS**

**Operating Frequencies:** 2405-2474 MHz

**Maximum field intensity / RF Output power:** 1.20 mW

**Model: E02A**

**Operating Frequencies:** 2405-2474 MHz

**Maximum field intensity / RF Output power:** 0.296 mW

▼ Taiwan / 台灣



**BSMI RoHS Compliance (限用物質含有情況標示聲明書)**

[https://www.elecom.co.jp/global/certification/pdf/RoHS\\_Taiwan.pdf](https://www.elecom.co.jp/global/certification/pdf/RoHS_Taiwan.pdf)



**型號 M-XGXL31DBS:** XXXXXXXXXXXXXXXX

**型號 M-XGM31DBS:** XXXXXXXXXXXXXXXX

**型號 E02A:** CCAH23LP0900T2

取得審驗證明之低功率射頻器材，非經核准，公司、商號或使用者均不得擅自變更頻率、加大功率或變更原設計之特性及功能。低功率射頻器材之使用不得影響飛航安全及干擾合法通信；經發現有干擾現象時，應立即停用，並改善至無干擾時方得繼續使用。前述合法通信，指依電信管理法規定作業之無線電通信。低功率射頻器材須忍受合法通信或工業、科學及醫療用電波輻射性電機設備之干擾。

▼ UK



**UK Declaration of Conformity**

[https://www.elecom.co.jp/global/certification/pdf/UK\\_DoC.pdf](https://www.elecom.co.jp/global/certification/pdf/UK_DoC.pdf)

**RoHS Compliance**

[https://www.elecom.co.jp/global/certification/pdf/RoHS\\_EU\\_UK\\_Vietnam.pdf](https://www.elecom.co.jp/global/certification/pdf/RoHS_EU_UK_Vietnam.pdf)



## **WEEE Disposal and Recycling Information**

This symbol means that waste of electrical and electronic equipment (WEEE) should not be disposed as general household waste. WEEE should be treated separately to prevent possible harm to the environment or human health. Consult your retailer or local municipal office for collection, return, recycle or reuse of WEEE.

## **▼ US**

**FCC ID:** YWO-M-XGXL31DBS

**FCC ID:** YWO-E02A

This device complies with Part 15 of the FCC Rules. Operation is subject to the following two conditions: (1) this device may not cause harmful interference, and (2) this device must accept any interference received, including interference that may cause undesired operation.

NOTE; This equipment has been tested and found to comply with the limits for a Class B Digital Device, pursuant to part 15 of the FCC Rules. These limits are designed to provide reasonable protection against harmful interference in a residential installation. This equipment generates, uses and can radiated radio frequency energy and, if not installed and used in accordance with the instruction, may cause harmful interference to radio communication. However, there is no guarantee that interference will not occur in a particular installation. If this equipment does cause harmful interference to radio or television reception, which can be determined by tuning the equipment off and on, the user is encouraged to try to correct the interference by one or more of the following measures:

- Reorient or relocate the receiving antenna
- Increase the separation between the equipment and receiver
- Connect the equipment into an outlet on a circuit different from that to which the receiver is connected
- Consult the dealer or an experienced radio/TV technician for help

NOTICE: The manufacture is not responsible for any radio or TV interference caused by unauthorized modification to this equipment. Such modifications could void the user's authority to operate the equipment.

In order to make improvements to this product, the design and specifications are subject to change without prior notice.

**FCC Caution:** To assure continued compliance, any changes or modifications not expressly approved by the party responsible for compliance could void the user's authority to operate this equipment. (Example - use only shielded interface cables when connecting to computer or peripheral devices).

## **FCC Radiation Exposure Statement**

This equipment complies with FCC RF radiation exposure limits set forth for an uncontrolled environment. This equipment should be installed and operated with a minimum distance of 0.5 cm between the radiator and your body.



This transmitter must not be co-located or operating in conjunction with any other antenna or transmitter.

The antennas used for this transmitter must be installed to provide a separation distance of at least 0.5 cm from all persons and must not be co-located or operating in conjunction with any other antenna or transmitter.

### **Responsible party**

ELECOM USA, Inc.

4041 MacArthur Blvd Suite 400, Newport Beach, CA 92660 USA

[elecomusa.com](http://elecomusa.com)

## ▼ **Vietnam / Việt Nam**

### **RoHS Compliance (Chứng Nhận Đạt Tiêu Chuẩn RoHS)**

[https://www.elecom.co.jp/global/certification/pdf/RoHS\\_EU\\_UK\\_Vietnam.pdf](https://www.elecom.co.jp/global/certification/pdf/RoHS_EU_UK_Vietnam.pdf)

## **Intellectual property rights**



- ELECOM CO., LTD. owns the copyright to this manual.
- All products and company names on this product and the package are trademarks or registered trademarks of their respective owners.
- Duplicating and transferring this document in part or whole is prohibited.
- Windows is a registered trademark or trademark of Microsoft Corporation in the United States and/or other countries.
- macOS is a trademark of Apple Inc., registered in the U.S. and other countries and regions.
- ChromeOS and Chromebook are trademarks of Google LLC.

## **Support information**



### **ELECOM CO., LTD.**

Fushimimachi 4-1-1, Chuo-ku, Osaka City

### **Go to Global Site**

### **Global Support**

Please contact the shop where you purchased this product if you have any feedback or questions about the contents of this manual.

Specifications and external appearance of this product may be changed without prior notice for the purpose of product improvement.

ELECOM is not responsible for any damages to, or failure of other devices caused by using this product.

The images are for illustration purposes only and may differ from your actual product.

When exporting this product, check the export regulations for the country of origin.

A customer who purchases outside Japan should contact the local retailer in the country of purchase for enquiries. In "ELECOM CO., LTD. (Japan)", no customer support is available for enquiries about purchases or usage in/from any countries other than Japan. Also, no foreign language other than Japanese is available. Replacements will be made under stipulation of the ELECOM warranty.

Bei Fragen zum Inhalt dieses Handbuchs wenden Sie sich bitte an das Geschäft, in dem Sie dieses Produkt erworben haben.

Die technischen Daten und das äußere Erscheinungsbild dieses Produkts können zum Zweck der Produktverbesserung ohne vorherige Ankündigung geändert werden.

ELECOM haftet nicht für Schäden oder Ausfälle an anderen Geräten, die durch die Verwendung dieses Produkts verursacht werden.

Die Abbildungen dienen nur der Veranschaulichung und können vom tatsächlichen Produkt abweichen.

Prüfen Sie bei der Ausfuhr dieses Produkts die Ausfuhrbestimmungen für das Herkunftsland.

Ein Kunde, der außerhalb Japans kauft, sollte sich für Rückfragen an den örtlichen Händler im jeweiligen Erwerbsland wenden. Bei „ELECOM CO., LTD. (Japan)“ steht, außer in Japan, kein Kundendienst für Anfragen zum Kauf oder zur Verwendung in/aus anderen Ländern zur Verfügung. Zudem ist keine andere Fremdsprache als Japanisch verfügbar. Ersatz wird im Rahmen der ELECOM-Garantie geleistet, ist aber außerhalb Japans nicht erhältlich.

Por favor, póngase en contacto con la tienda en la que adquirió este producto si tiene algún comentario o pregunta sobre el contenido de este manual.

Las especificaciones y la apariencia externa de este producto pueden modificarse sin previo aviso con el fin de mejorar el producto.

ELECOM no se hace responsable de los daños o fallos de otros dispositivos causados por el uso de este producto.

Las imágenes son solo para fines ilustrativos y pueden diferir del producto real.

Al exportar este producto, compruebe la normativa de exportación del país de origen.

Los clientes que compren fuera de Japón deben ponerse en contacto con el distribuidor local del país de compra para realizar consultas. En "ELECOM CO., LTD. (Japón)", no hay servicio de atención al cliente para consultas sobre compras o uso en/desde otros países que no sean Japón. Además, no está disponible ninguna otra lengua extranjera que no sea el japonés. Los reemplazos se harán bajo la estipulación de la garantía de ELECOM, pero no están disponibles fuera de Japón.

Veillez contacter le magasin où vous avez acheté ce produit si vous avez des commentaires ou des questions sur le contenu de ce manuel.

Les spécifications et l'aspect extérieur de ce produit peuvent être modifiés sans préavis dans le but d'améliorer le produit.

ELECOM n'est pas responsable des dommages ou des défaillances d'autres appareils causés par l'utilisation de ce produit.

Les images sont fournies à titre d'illustration uniquement et peuvent différer du produit réel.

Lorsque vous exportez ce produit, vérifiez les réglementations d'exportation du pays d'origine.

Un client qui achète hors du Japon doit contacter le détaillant local du pays d'achat pour toute question. Chez "ELECOM CO., LTD. (Japon)", aucun support client n'est disponible pour les questions relatives aux achats ou à l'utilisation dans/à partir de tout pays autre que le Japon. De même, aucune langue étrangère autre que le japonais n'est disponible. Les remplacements seront effectués conformément aux dispositions de la garantie ELECOM, mais ne sont pas disponibles en dehors du Japon.

Entre em contato com a loja onde você comprou este produto se tiver alguma sugestão ou dúvida sobre o conteúdo deste manual.

As especificações e aparência externa deste produto podem ser alteradas sem aviso prévio para fins de melhoria do produto.

A ELECOM não é responsável por quaisquer danos ou falhas de outros dispositivos causados pelo uso deste produto.

As imagens são apenas para fins ilustrativos e podem diferir do produto real.

Ao exportar este produto, confira os regulamentos de exportação para o país de origem.

Um cliente que compra fora do Japão deve entrar em contato com o revendedor local no país de compra para obter informações. Na "ELECOM CO., LTD. (Japão)", nenhum suporte ao cliente está disponível para consultas sobre compras ou uso em/de quaisquer outros países além do Japão.

Além disso, nenhum outro idioma estrangeiro está disponível além do japonês. As trocas serão feitas sob estipulação da garantia ELECOM, mas não estão disponíveis fora do Japão.

如果您对本手册内容有任何反馈或疑问，请与购买本产品的零售商联系。

本产品的规格及外观如有变更以对产品进行改进，恕不另行通知。

因使用本产品而造成其他设备故障或问题时，ELECOM概不负责，敬请知悉。

图片仅供参考，您所收到的实际产品可能有所差异。

出口本产品至海外时，请检查原产国的出口法规。

在日本境外购买产品的客户应与当地的的零售商联系进行咨询。ELECOM株式会社（日本）有限公司不对日本之外的其他国家的客户提供有关购买或使用的咨询服务。另外，公司不提供日语之外的其他外语服务。产品如需更换，需要在 ELECOM 保修期规定范围之内，日本境外的产品不提供更换服务。

若您對本手冊的內容有任何回饋或疑問，請聯絡您購買本產品的商店。

為了改進產品，本產品的規格和外觀可能會發生變化，恕不事先通知。

ELECOM 對因使用本產品而造成的其他裝置損壞或故障不承擔責任。

圖片僅用於說明目的，可能與您的實際產品有所出入。

出口這款產品時，需檢查原產國的出口規定。

客戶若日本以外地區購買本產品，如有任何問題，應聯絡購買當地的經銷商。「ELECOM CO., LTD. (Japan)」不在日本以外的其他地區提供購買或使用產品等相關問題的客戶支援。與此同時，除日語以外，不提供其他的外國語言服務。您可以根據ELECOM的規定於保固期間要求更換產品，但您不能在日本以外的其他地區使用此服務。

본 취급설명서는 설명서에 대한 의견 또는 질문이 있으신 경우 본 제품을 구매한 대리점으로 문의하시기 바랍니다.

본 제품의 사양 및 외관은 제품 개선을 위해 사전 통지 없이 변경될 수 있습니다.

본 제품의 사용에 따른 다른 기기의 고장이나 트러블에 관해서는 책임을 지지 않으므로 양해 바랍니다.

일부 형태가 달라지는 경우도 있습니다.

본 제품을 수출할 때, 원산지의 수출 규정을 확인합니다.

일본 외 다른 국가에서 구입하는 고객은 문의 사항이 있는 경우 제품 구입 국가의 대리점에 연락하십시오. 'ELECOM CO., LTD.(일본)'는 일본 이외의 국가에서 구입 또는 사용 문의에 대한 고객 지원을

제공하지 않습니다. 또한 일본어 이외의 외국어는 지원되지 않습니다. 제품 교체는 ELECOM 보증 규정에 따라 이루어지지만 일본 외에서는 교체가 불가능합니다.