

# SAMPLE



## M-VM600, EG01A Wireless Mouse User Manual

How to use



Connecting and setting up the mouse



Using in wireless mode



**1. Charging the battery**

- 1) Plug the Type-C connector of the included USB Type-C - USB-A cable to the USB Type-C port of this product.

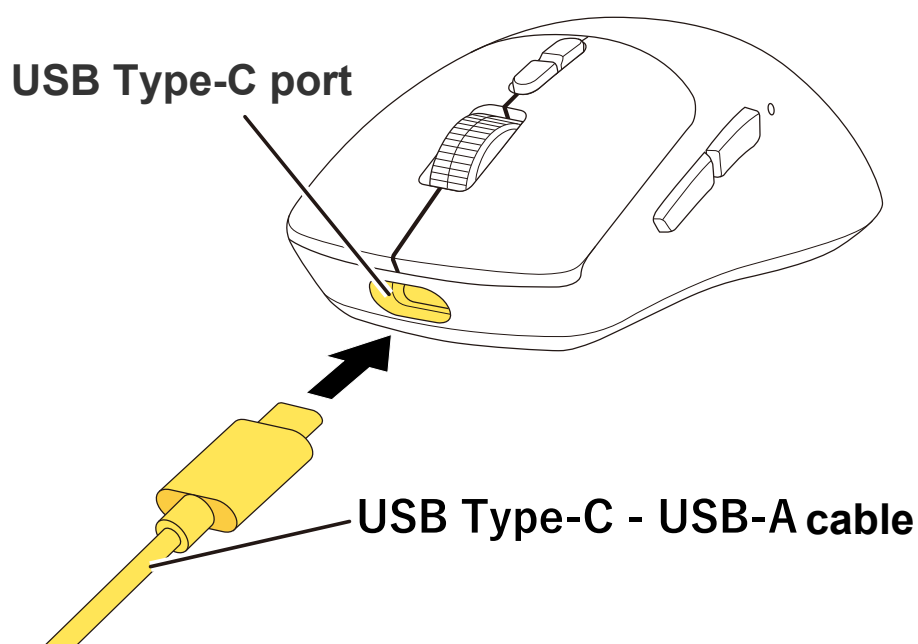

- 2) Plug the USB-A connector of the USB Type-C – USB-A cable into the USB-A port of the PC.

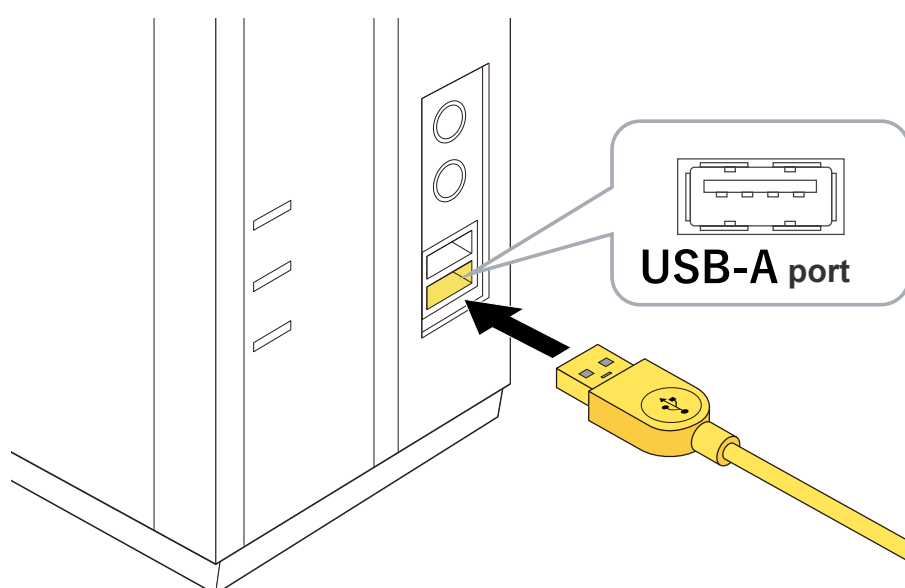

- ⚠ Ensure that the connector is correctly oriented to the port.
- \* If there is strong resistance when inserting, check the shape and orientation of the connector. Forcibly inserting the connector may damage the connector, and there is a risk of injury.
- \* Do not touch the terminal portion of the USB connector.

### 3) Turn on the power of the PC, if it has not been already switched on.

The notification LED will blink green and charging will begin. When charging is complete, the green light will remain lit up.

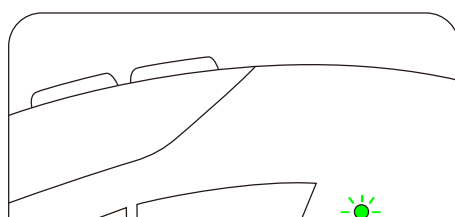

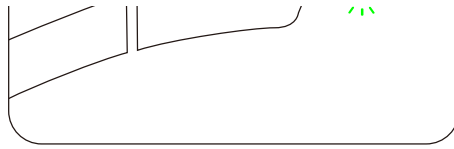

It will take approximately x.x hours until full charge.

If the green LED light does not stay lit up even after the prescribed charging time, remove the USB Type-C - USB-A cable and stop charging for the moment. Otherwise, this can cause heating, explosions or fires.

## 2. Turn the power ON

1) Slide the power switch on the underside of this product to the ON position.

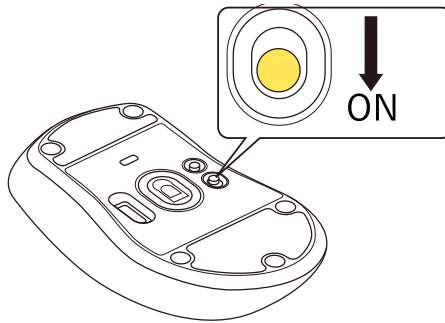

The notification LED will light up red for 3 seconds. The LED will also light up for 3 seconds in different colors depending on the DPI count in use.

\* The LED will blink red when the remaining charge is low.



### Power-saving mode

When the mouse is left untouched for a fixed period of time while the power is ON, it automatically shifts to power-saving mode.

The mouse returns from power-saving mode when it is moved.

\* Mouse operation may be unstable for 2-3 seconds after returning from the power-saving mode.

## 3. Connect to a PC

1) Start up your PC.

Please wait until your PC has started up and can be operated.

2) Insert the receiver unit into the PC's USB-A port.

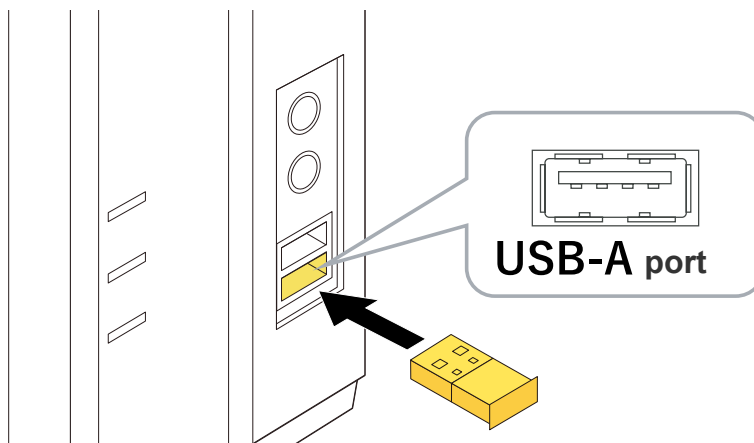

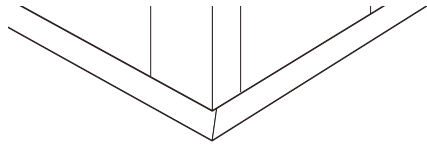

You may use any USB-A port.



If there is a problem with the position of the computer, or with the communication between the receiver unit and this product, you can use the included USB-A - USB Type-C adapter with the included USB Type-C - USB-A cable, or place this product where there will be no problems with the communication with the receiver unit.

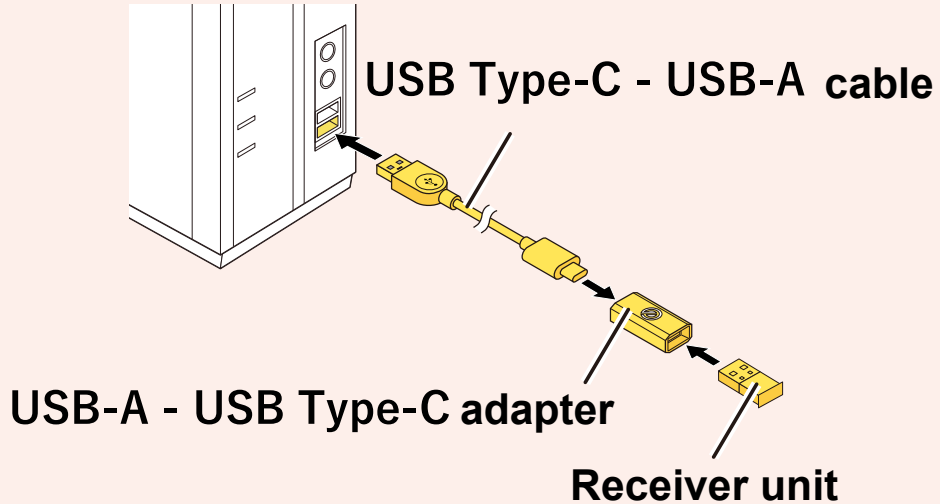

- Ensure that the connector is correctly oriented to the port.
- If there is strong resistance when inserting, check the shape and orientation of the connector. Forcibly inserting the connector may damage the connector, and there is a risk of injury.
- Do not touch the terminal portion of the USB connector.



#### When removing the receiver unit

This product supports hot plugging. The receiver unit can be removed while the PC is on.

**3) The driver will be automatically installed, and you will then be able to use the mouse.**

**You can now use the mouse.**

### Using in wired mode



## 1. Connect to a PC

1) Plug the Type-C connector of the included USB Type-C - USB-A cable to the USB Type-C port of this product.

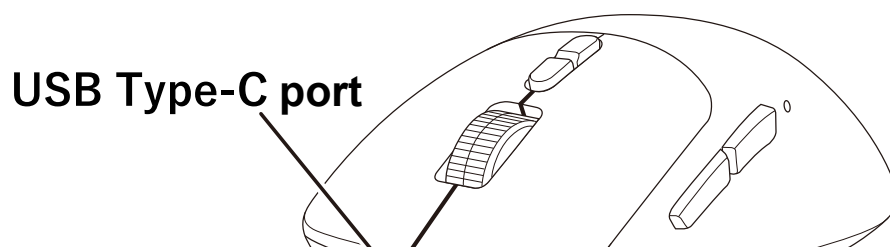

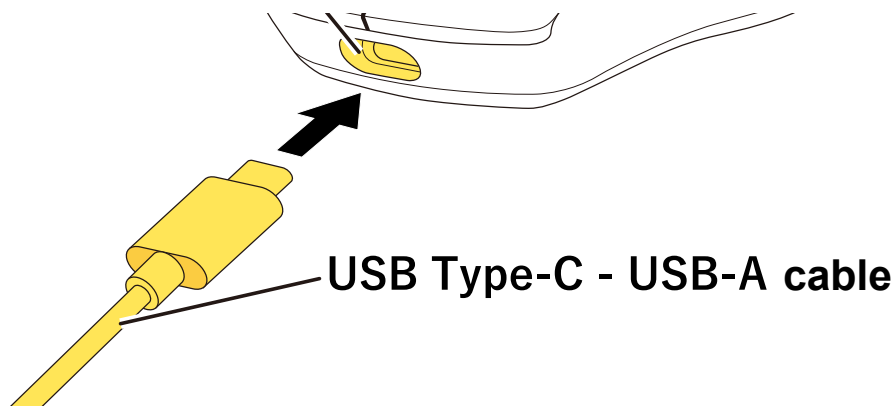

## 2) Start up your PC.

Please wait until your PC has started up and can be operated.

## 3) Connect the USB-A side of the included USB Type-C - USB-A cable into the USB-A port of the PC.

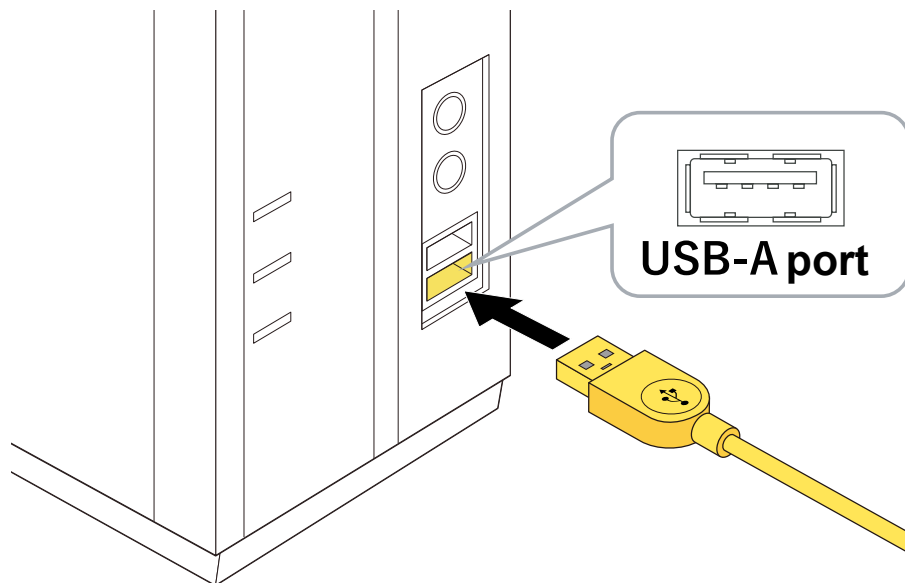

- Ensure that the connector is correctly oriented to the port.
- If there is strong resistance when inserting, check the shape and orientation of the connector. Forcibly inserting the connector may damage the connector, and there is a risk of injury.
- Do not touch the terminal portion of the USB connector.

## 4) The driver will be automatically installed, and you will then be able to use the mouse.

You can now use the mouse.

You will be able to assign functions to all the buttons, and setup the DPI count and light by installing the settings software "ELECOM Accessory Central". Proceed to "[Setup with ELECOM Accessory Central](#)".

Connection method	USB2.4GHZ wireless (USB wired when connected via cable)
Supported OS	Windows11, Windows10, Windows 8.1, Windows 7 * Update for each new version of the OS or the installation of a service pack might be required.
Communication method	GFSK
Radio frequency	2.4GHz
Radio wave range	When used on magnetic surfaces (metal desks, etc.): approximately 3m When used on non-magnetic surfaces (wooden desks, etc.): approximately 10m * These values were obtained in ELECOM's test environment and are not guaranteed.
Sensor	PixArt PAW3395 + LoD sensor
Resolution	100-26000 DPI (can be set at intervals of 100 DPI)
Maximum tracking speed	650 IPS (approximately 16.5m)/s
Maximum detected acceleration	50G
Polling rate	Maximum 1000 Hz
Switch	Optical magnetic switch V custom Magoptic switch
Dimensions (W x D x H)	Mouse: Approximately 67 × 124 × 42 mm / 2.6 × 4.9 × 1.7 in. Receiver unit: Approximately 13 × 24 × 6 mm / 0.5 × 0.9 × 0.2 in.
Cable length	Approximately 1.5m
Continuous operating time:	Approximately 120 hours
Weight	Mouse: approximately 73g Receiver unit: approximately 2g
Accessories	USB A male-USB C male cable (1.5m) ×1, USB adapter ×1, 3D PTFE additional feet × 1, 3D PTFE replacement feet × 1, cleaning cloth ×1, grip sheet ×1

# Compliance status



Model/모델명/设备型号/型号: M-VM600

## ▼ China / 中国

RoHS Compliance  
(产品中有毒有害物质或元素的名称及含量)

产品中有毒有害物质或元素的名称及含量

部件名称	有毒有害物质或元素					
	铅 (Pb)	汞 (Hg)	镉 (Cd)	六价铬 (Cr(VI))	多溴联苯 (PBDE)	多溴二苯醚 (PBDE)
① 鼠标本体	○	○	○	○	○	○
② USB 接口	○	○	○	○	○	○
③ 电池	○	○	○	○	○	○

○ : 表示该有害物质在该部件所有均质材料中的含量均在 SJ/T 11363-2006 标准规定的限量要求以下。  
× : 表示该有害物质至少在该部件的某一均质材料中的含量超出 SJ/T 11363-2006 标准规定的限量要求。

## ▼ EU



CE Declaration of Conformity

RoHS Compliance

**Importer EU Contact** (For CE matters only)

Around the World Trading, Ltd.

5th floor, Koenigsallee 2b, Dusseldorf, Nordrhein-Westfalen, 40212, Germany



## WEEE Disposal and Recycling Information

This symbol means that waste of electrical and electronic equipment (WEEE) should not be disposed as general household waste. WEEE should be treated separately to prevent possible harm to the environment or human health. Consult your retailer or local municipal office for collection, return, recycle or reuse of WEEE.

## ▼ Korea / 대한민국



인증번호: R-R-ELJ-M-M-VM600

제작자 및 설치자는 해당 무선설비가 전파혼신 가능성이 있으므로 인명안전과 관련된 서비스는 할 수 없습니다.

안전인증번호: YU10444-22005

Safety Certification (전기용품 안전인증)

## ▼ Singapore

Complies with  
IMDA standards  
DA106058

▼ Taiwan / 台灣



BSMI RoHS statement (限用物質含有情況標示聲明書)

設備名稱：無線滑鼠 Equipment name		型號 (型式)： Type designation (Type)					
單元 Unit	限用物質及其化學符號 Restricted substances and its chemical symbols						
	鉛 Lead (Pb)	汞 Mercury (Hg)	鎘 Cadmium (Cd)	六價鉻 Hexavalent chromium (Cr)	多溴聯苯 Polybrominated diphenyls (PBB)	多溴二苯聯 Polybrominated diphenyl ethers (PBDE)	
電路板	○	○	○	○	○	○	
外殼	○	○	○	○	○	○	
連接線	○	○	○	○	○	○	
USB 接口	○	○	○	○	○	○	

備考 1: "超出 0.1 wt %" 及 "超出 0.01 wt %" 係指限用物質之百分比含量超出百分比含量基準值。  
 Note 1: "Exceeding 0.1 wt %" and "exceeding 0.01 wt %" indicate that the percentage content of the restricted substance exceeds the reference percentage value of presence condition.  
 備考 2: "○" 係指該項限用物質之百分比含量未超出百分比含量基準值。  
 Note 2: "○" indicates that the percentage content of the restricted substance does not exceed the percentage of reference value of presence.  
 備考 3: "-" 係指該項限用物質為排除項目。  
 Note 3: The "-" indicates that the restricted substance corresponds to the exemption.



M-VM600: XXXXXXXXXXXXXXXX

EG01A: XXXXXXXXXXXXXXXX

取得審驗證明之低功率射頻器材，非經核准，公司、商號或使用均不得擅自變更頻率、加大功率或變更原設計之特性及功能。低功率射頻器材之使用不得影響飛航安全及干擾合法通信；經發現有干擾現象時，應立即停用，並改善至無干擾時方得繼續使用。前述合法通信，指依電信管理法規定作業之無線電通信。低功率射頻器材須忍受合法通信或工業、科學及醫療用電波輻射性電機設備之干擾。

▼ UK



UK Declaration of Conformity

RoHS Compliance

**Importer UK Contact** (For UKCA matters only)

Around the World Trading, Ltd.

25 Clarendon Road Redhill, Surrey RH1 1QZ, United Kingdom





**FCC ID:** YWO-M-VM600

**FCC ID:** YWO-EG01A

This device complies with Part 15 of the FCC Rules. Operation is subject to the following two conditions: (1) this device may not cause harmful interference, and (2) this device must accept any interference received, including interference that may cause undesired operation.

NOTE; This equipment has been tested and found to comply with the limits for a Class B Digital Device, pursuant to part 15 of the FCC Rules. These limits are designed to provide reasonable protection against harmful interference in a residential installation. This equipment generates, uses and can radiated radio frequency energy and, if not installed and used in accordance with the instruction, may cause harmful interference to radio communication. However, there is no grantee that interference will not occur in a particular installation. If this equipment does cause harmful interference to radio or television reception, which can be determined by tuning the equipment off and on, the user is encouraged to try to correct the interference by one or more of the following measures:

- Reorient or relocate the receiving antenna - Increase the separation between the equipment and receiver -
- Connect the equipment into an outlet on a circuit different from that to which the receiver is connected -
- Consult the dealer or an experienced radio/TV technician for help

NOTICE: The manufacture is not responsible for any radio or TV interference caused by unauthorized modification to this equipment. Such modifications could void the user's authority to operate the equipment.

In order to make improvements to this product, the design and specifications are subject to change without prior notice.

**FCC Caution:** To assure continued compliance, any changes or modifications not expressly approved by the party responsible for compliance could void the user's authority to operate this equipment. (Example - use only shielded interface cables when connecting to computer or peripheral devices).

### **FCC Radiation Exposure Statement**

This equipment complies with FCC RF radiation exposure limits set forth for an uncontrolled environment. This equipment should be installed and operated with a minimum distance of 0.5 centimeters between the radiator and your body.

This transmitter must not be co-located or operating in conjunction with any other antenna or transmitter.

The antennas used for this transmitter must be installed to provide a separation distance of at least 0.5 cm from all persons and must not be co-located or operating in conjunction with any other antenna or transmitter.

**Responsible party** (For FCC matters only)

Around The World Trading Inc.,

7636 Miramar Rd #1300, San Diego, CA 92126

[elecomus.com](http://elecomus.com)