

# Wireless Trackball Mouse User Manual

M-IT10DR/E01D

Thank you very much for purchasing this product.

\* "M-IT10DR" series is referred to as "this product" in this manual except in some cases.

## Precautions



This manual describes the important precautions you should take for safe operation of this product. Observe these precautions carefully to avoid personal injury, damage, fire, and other problems.

### ■ Meaning of symbols

#### **WARNING**

Failure to observe precautions carries the possibility of serious personal injury or death due to fire, electric shock, or other causes.

#### **CAUTION**

Failure to observe precautions may result in personal injury due to electric shock or other causes, and may damage other equipment.

 Prohibited action

 Mandatory action

 Situation that needs attention

 Notes and reference information

## WARNING

 **If a foreign object (water, metal chips) enters the product, immediately stop using the product, remove the receiver unit from the PC, and remove the batteries from the trackball.**

Continuing to use the product as it is may cause a fire or electric shock.

 **If the product is behaving abnormally, such as by generating heat, smoke, or giving off a strange smell, immediately stop using the product, shut down the PC, and then after sufficiently checking for whether the product is generating heat without being burned, remove the receiver unit from the PC, and remove the batteries from the trackball. Afterwards, please contact your dealer.**

Continuing to use the product as it is may cause a fire or electric shock.

 **Please do not drop or hit this product.**

**In the unlikely event that this product is damaged, immediately stop using the product, remove the receiver unit from the PC, and remove the batteries from the trackball. Afterwards, please contact your dealer.**

Fires or electric shocks may occur if this product is used when damaged.

 **Do not attempt to disassemble, modify or repair this product.**

Doing so may cause a fire, electric shock, or product damage.

Malfunctions are not covered under warranty.

 **Do not put this product in fire.**

Ruptures may cause fire or injury.

## CAUTION

 **Do not place this product in any of the following environments:**

- In a car exposed to sunlight or a place exposed to direct sunlight.
- In a place that becomes hot, such as around a heater.

- In a moist place or a place where condensation may occur.
- In an uneven place or a place exposed to vibration.
- In a place where a magnetic field is generated (such as near a magnet.)
- In a dusty place.

---

**!** **This product does not have a waterproof structure. Use or store in a place not exposed to liquids such as water.**

Any liquid such as rain, water spray, juice, coffee, steam, and sweat, may cause this product to breakdown.



- Only use this trackball with PCs, smartphones, tablets, and video game systems.
- Do not use this product with any device that may significantly be affected in the case of this product malfunctioning.
- When you no longer need to use this product and the battery, be sure to dispose of them in accordance with the local ordinances and laws of your area.

## ■ Battery

### CAUTION



Please use either an AA alkaline battery, an AA manganese battery or an AA nickel-metal hydride rechargeable battery.



**Remove the battery when you are not using this product for long periods of time.**

Otherwise, this may cause leakage or malfunction.

## ■ Cleaning the Product

If the body of this product becomes dirty, wipe it with a soft, dry cloth.



Using a volatile liquid such as paint thinner, benzene or alcohol may affect the material quality and/or discolor this product.

Please note the following for disinfection.



Gently soak a cleaning cloth, such as a microfiber cloth, in the disinfectant solution. Make sure there are no loose droplets and gently wipe the product using the cloth.

After wiping, dry thoroughly and wipe off any residual liquid.

\* Do not spray any liquid onto the product directly. Doing so can cause electric malfunctions.



### IMPORTANT

 **Do not spray any liquid onto the product directly.**

Doing so can cause electric malfunctions.

 **Do not use organic solvents or ultraviolet lights.**

Usage can result in deterioration of the housing components or paints, which can cause damage to the exterior.

 **We recommend the usage of disposable gloves.**

 **Please unplug the USB connector from the PC.**

 **When using any alcohol-based products, please check that it is appropriate for the specific purpose and that it is used properly.**

 **Please note that in the event that damage or abnormal operation to the product is caused by the cleaning process, the customer will be fully responsible for the cost of repair.**

 **We recommend that you disinfect your hands before and after using PCs and peripheral devices that are used by multiple people in order to prevent the spread of infection through the equipment.**

 **Please turn off any connected devices.**

\* Please turn off connected devices when in sleep or hibernation mode.

\* Please unplug the AC adapter and power cable from the power outlet.

## Cautions for Wireless Equipment

This product is a wireless device that can use the entire 2.4 GHz band, and is able to avoid the mobile entity identification device range. The GFSK method is adopted as the radio wave method, and the interference distance is 10 m. The 2.4 GHz band is also used in medical devices, Bluetooth, and wireless LAN devices of the IEEE 802.11b/11g/11n standards.

• Before using this product, check that there are no other "radio stations"\* operating nearby.

• If electromagnetic interference occurs between this product and other "radio stations"\*, move this product to another location or stop using this product.

\* Other "radio stations" refer to industrial, scientific and medical devices using the 2.4 GHz band, the same as this product, other radio stations of this type, licensed radio station premises for a mobile object identification system that is used in factory production lines, certain non-licensed low power radio stations, and amateur radio stations.



**WARNING**

- 
-  Do not use in equipment which may cause serious effects due to it malfunctioning. There are rare cases in which an external radio wave at the same frequency, or the radio wave emitted from a mobile phone, causes this product to malfunction, slow down, or fail to operate.
  - Do not use this product in places where radio wave usage is prohibited, such as hospitals. Radio waves of this product may affect electronic devices and medical devices (for example pacemakers).
  - Due to the possibility of hindering safe navigation of aircraft, use of wireless trackball in aircraft is prohibited by the Civil Aeronautics Act. Turn off the power of the wireless trackball before boarding and do not use after boarding.
- \* ELECOM is not liable for any accidents or any indirect or consequential damage incurred due to the failure of this product.
- 

## How to use



### Items included in this package



The following are included in this package. Verify the package to ensure all items are accounted for prior to using this product. Every effort has been made to ensure proper packaging. However, in the event that any part is missing or damaged, please contact the retailer where this product was purchased.

• **Trackball × 1**

• **Receiver unit x 1**



Pre-inserted into the trackball. Please remove before use.

• **AA alkaline dry cell battery for confirming operability × 1**



Pre-inserted into the trackball. Please remove the battery insulating pull tab before use.

• **Support part removal tool × 1**

### Name and function of each part



#### ■ Trackball

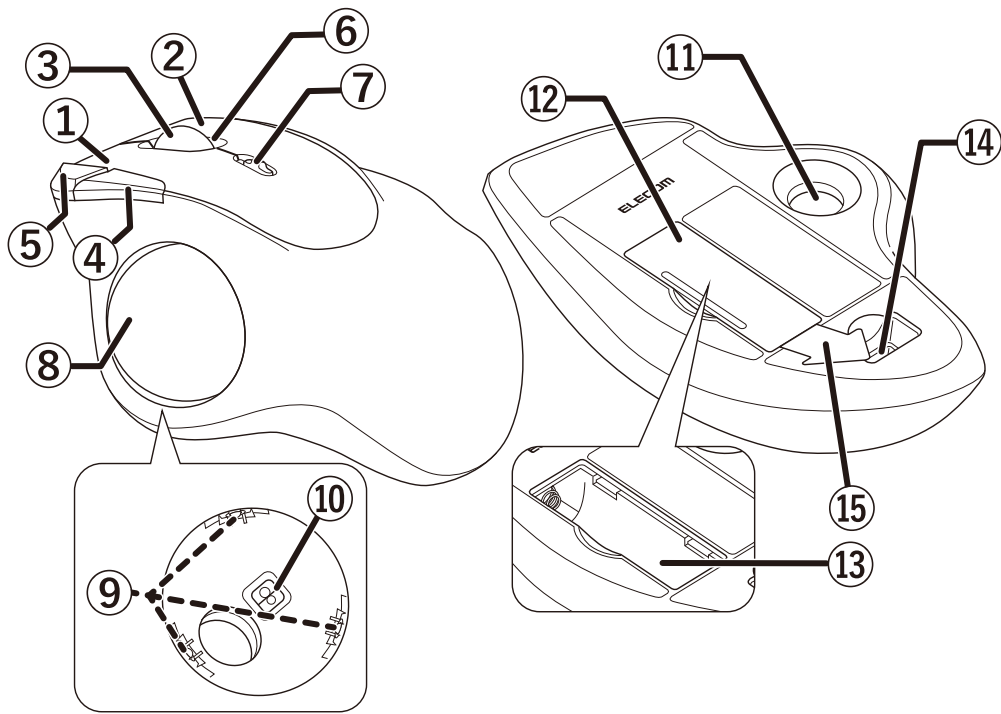

① **Left button**

To left click on your PC.

② **Right button**

To right click on your PC.

③ **Wheel**

Rotate forward and backward or click like a button to operate your PC.

④ **"Back" button**

Performs the "Back" function on the Web browser.

⑤ **"Forward" button**

Performs the "Forward" function on the Web browser.

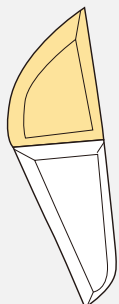

**"Forward" button**  
Continue to next page.

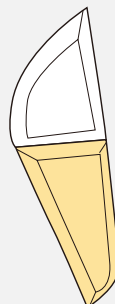

**"Back" button**  
Return to previous page.



You will need to install the "ELECOM Mouse Assistant Mac version" from our website to use the "Back" and "Forward" button on Mac. Refer to "[Install ELECOM Mouse Assistant](#)".

## ⑥ LED light

- The base of the wheel illuminates in red for a few seconds when the power is turned on.
- The light around the mouse will start to blink red when the battery level is low.

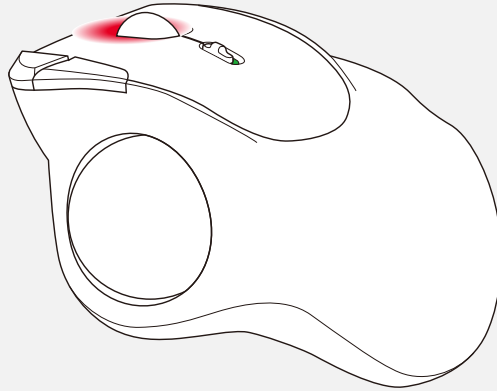

## ⑦ Power switch

Turn the trackball power ON and OFF.

## ⑧ Ball (36mm)

Rotate using your fingertips to move the cursor.



Separately sold ball

- [Replacement 36 mm ball \(M-B10SV\)](#)

## ⑨ Support parts (synthetic ruby)

Support the ball.

Support parts are consumables. Compatible support parts can be purchased separately to replace existing support parts.



Optional Parts

- [Replacement synthetic ruby unit \(M-RS10\)](#)
- [Replacement bearing unit \(M-BS10\)](#)

## ⑩ Optical sensor (under the ball)

This sensor will detect the trackball's movements when you move the trackball.

## ⑪ Ball removal hole

Remove the ball from here to clean the support parts in the housing.

\* See "[How to clean the trackball](#)" for details.

## ⑫ Receiver unit storage compartment

The receiver unit can be stored here when the mouse is not in use.

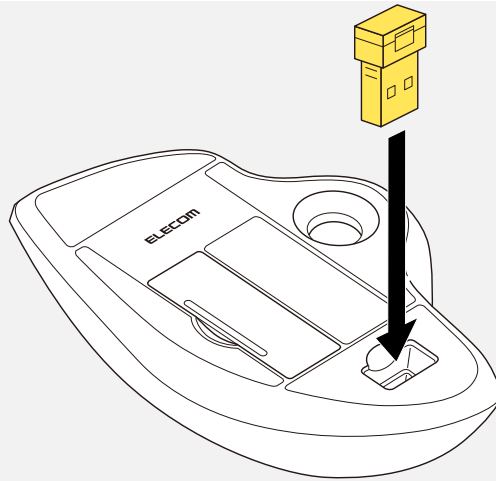

⑬ **Battery cover**

Remove this cover and insert the battery.

⑭ **Battery storage compartment**

Holds the battery.

⑮ **Battery insulating tab**

Remove this tab before using.

## ■ Receiver unit

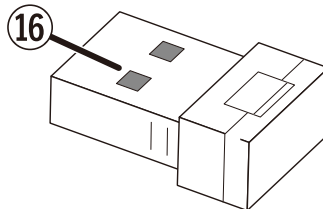

⑯ **USB connector**

Connects to the PC USB-A port

## ■ Support part removal tool

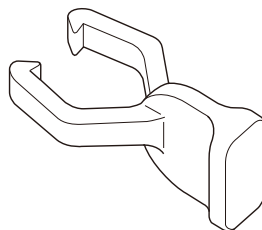

\* See ["How to replace support parts"](#) for details.



## 1. Turn the power ON

1) Remove the battery cover.

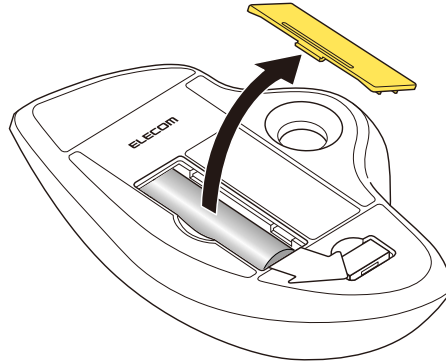

2) Remove the battery insulating tab.

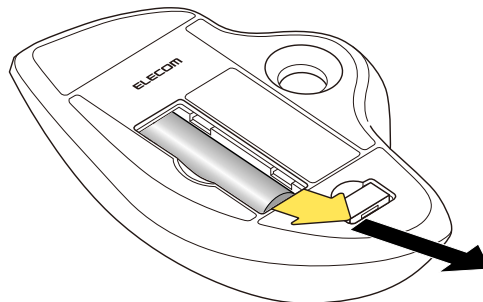

3) Put the battery cover back on.

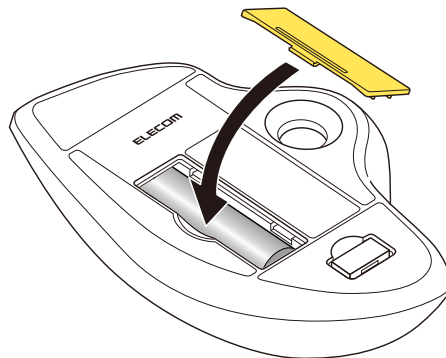

4) Remove the receiver unit.

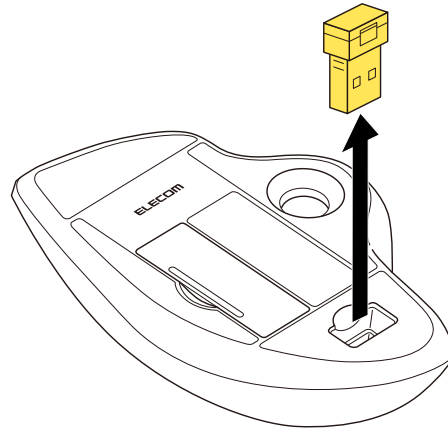

**5) Slide the power switch to the ON position.**

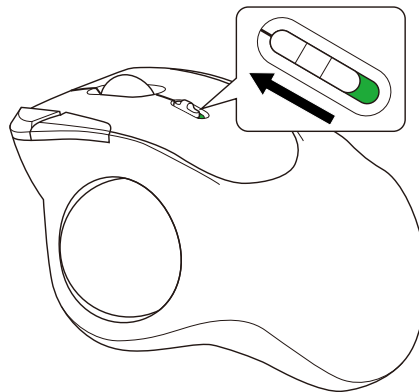

The light around the wheel lights up red for 3 seconds.

\* When the battery level is running low, the LED light will blink slowly for a period of time.



#### **Power-saving mode**

When the trackball is left untouched for a fixed period of time while the power is ON, it automatically shifts to power-saving mode.

Moving the trackball restores it from energy saving mode.

\* For two to three seconds after restoring from energy saving mode, trackball operation may be unstable.

### **Replacing the battery...**

**1) Remove the battery cover.**

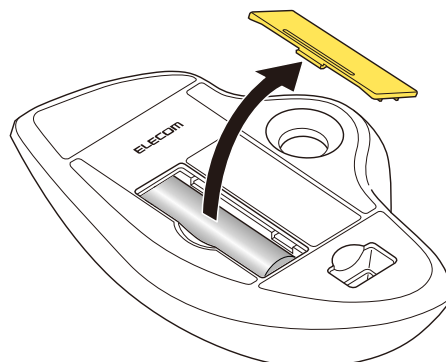

**2) Remove the battery.**

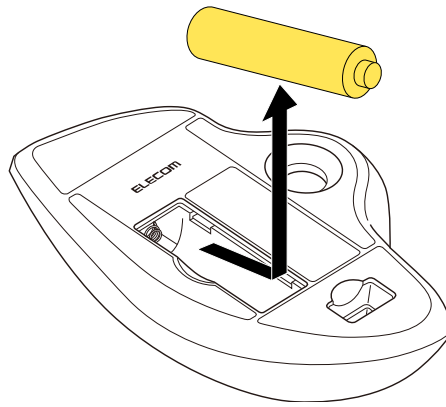

**3) Insert the battery according to the instructions on the battery compartment.**

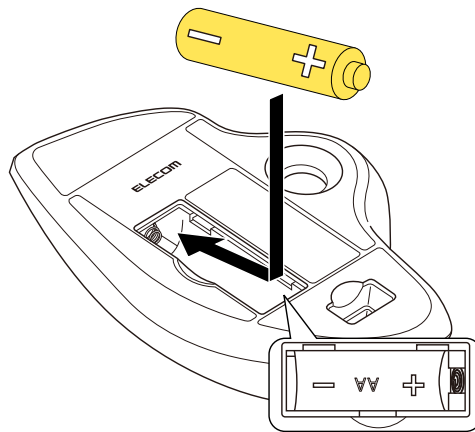

Ensure that the battery is inserted with the positive (+) and negative (-) terminals oriented correctly.

**4) Put the battery cover back on.**

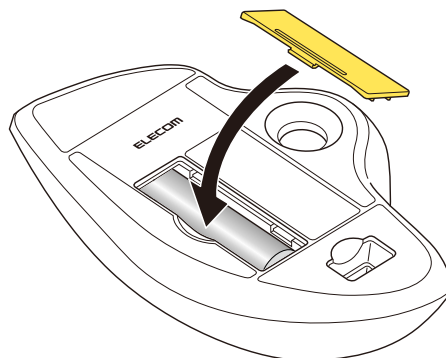

## **2. Connect to a PC**

**1) Start up your PC.**

Please wait until your PC has started up and can be operated.

**2) Insert the receiver unit into the PC's USB-A port.**

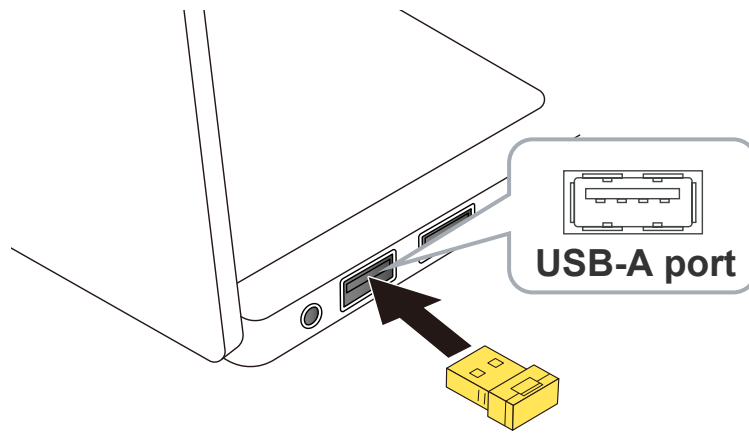

You may use any USB-A port.



- Ensure that the connector is correctly oriented to the port.
- If there is strong resistance when inserting, check the shape and orientation of the connector. Forcibly inserting the connector may damage the connector, and there is a risk of injury.
- Do not touch the terminal portion of the USB connector.



#### **When removing the receiver unit**

This product supports hot plugging. The receiver unit can be removed while the PC is on.

### **3) The driver is automatically installed and the trackball can be used.**

**You can now use the trackball.**

By downloading and installing the "ELECOM Mouse Assistant" from our company website, functions such as button assignment function and presentation mode can be used. Please proceed to "[Install ELECOM Mouse Assistant](#)".

## **Change the mouse pointer speed**

Adjust the mouse pointer movement speed on your PC if the mouse pointer moves too fast or too slow.

### **■ For Windows 11**

#### **1) Click on "Start" on the bottom of the screen and click on "Settings".**

The "Settings" page will appear.

#### **2) Click on "Bluetooth & devices" and then "Mouse".**

\* The screenshots will be replaced with the English version when it's ready

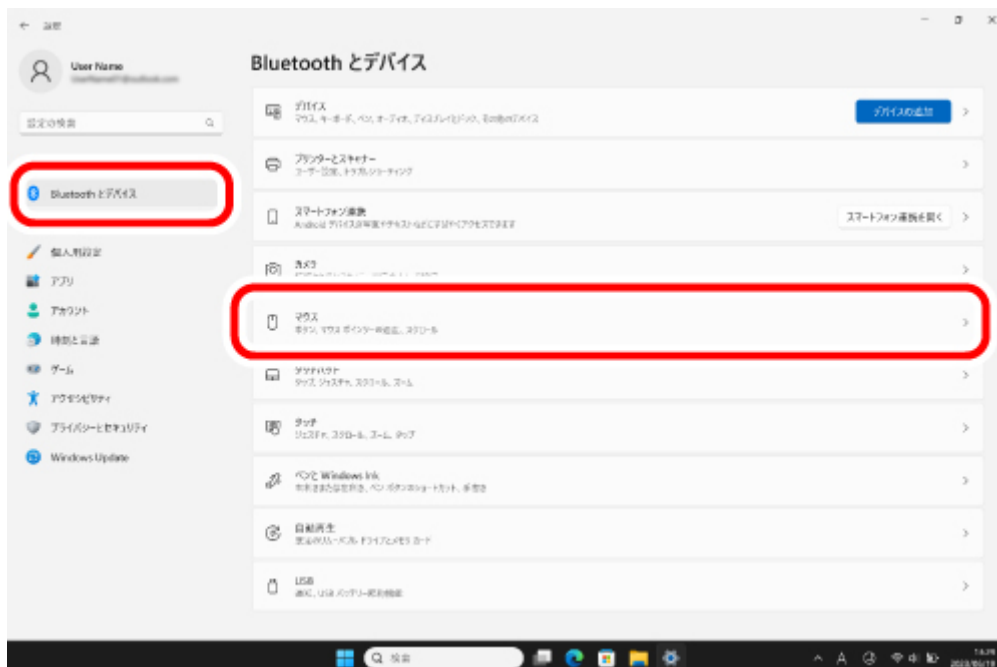

3) Adjust the “Mouse pointer speed” slider bar to adjust the mouse pointer movement speed.

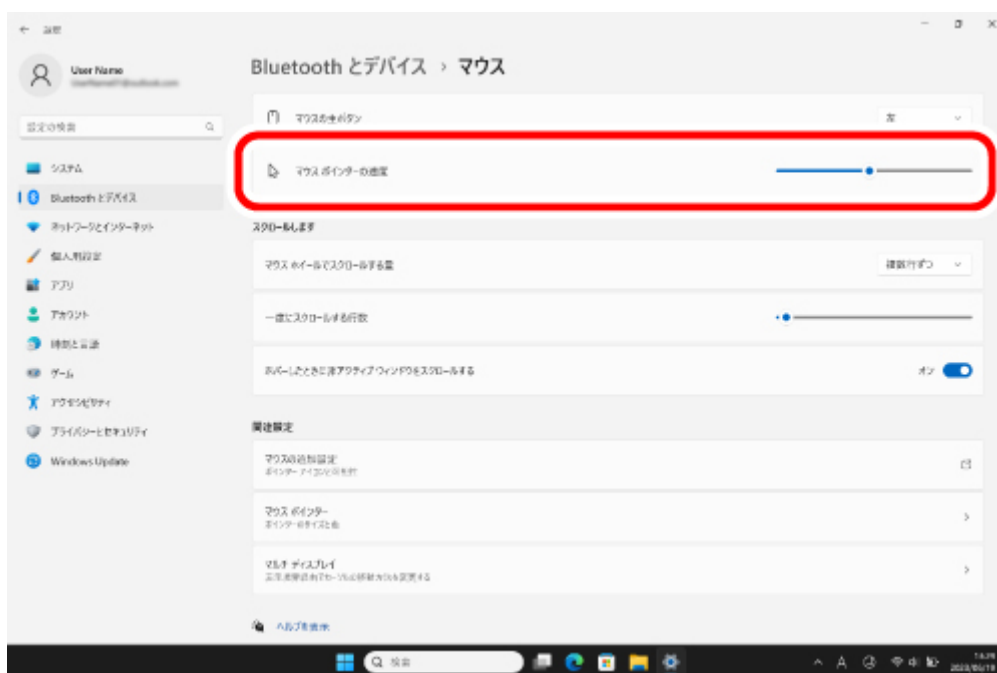

## ■ For Windows 10

1) Open “Mouse” properties.

From the start menu, click the Settings icon, select “Devices” → “Mouse”, then click “Additional mouse options” under “Related Settings”.

2) Select the “Pointer Options” tab.

3) Adjust the “Select a pointer speed” slider bar to adjust the mouse pointer movement speed.

\* The screenshots will be replaced with the English version when it's ready

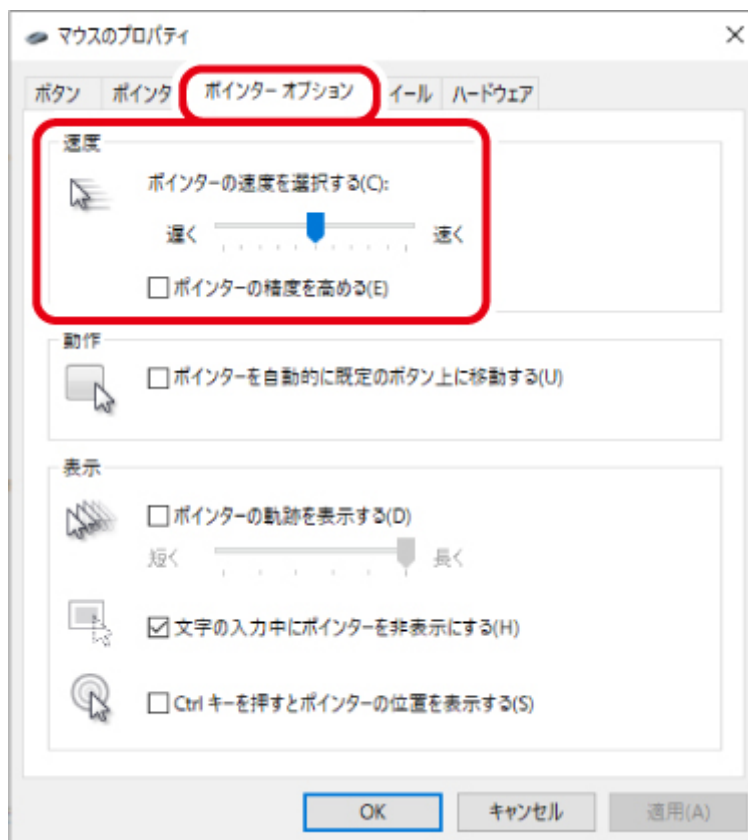

## Change the number of lines scrolled in one wheel turn

### ■ For Windows 11

1) Click on "Start" on the bottom of the screen and click on "Settings".

The "Settings" page will appear.

2) Click on "Bluetooth & devices" and then "Mouse".

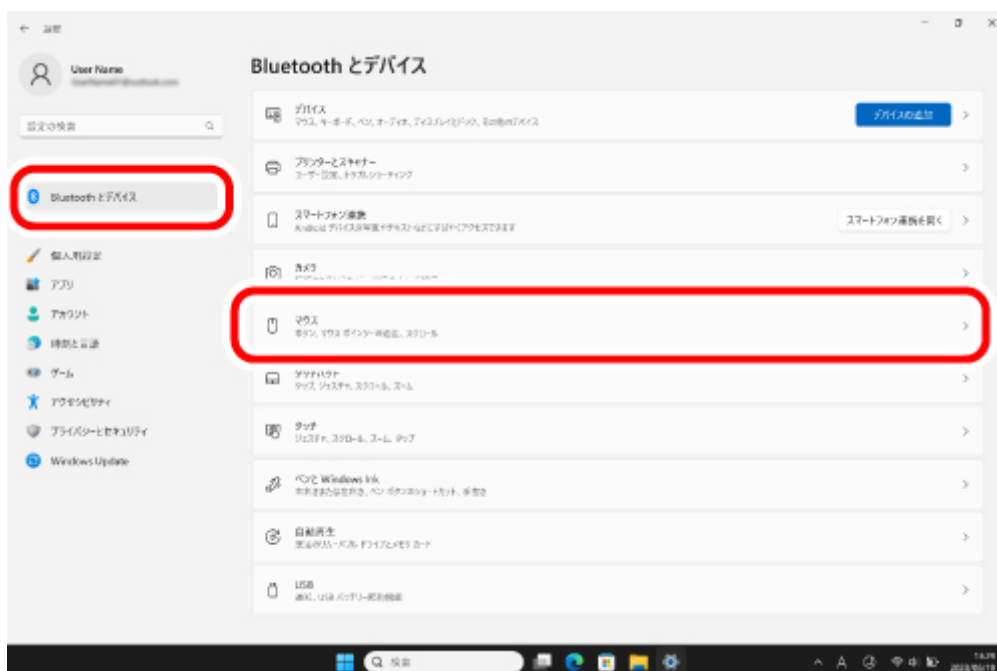

3) Adjust the "Lines to scroll at a time" slider bar to adjust the number of lines per scroll.

\* The screenshots will be replaced with the English version when it's ready

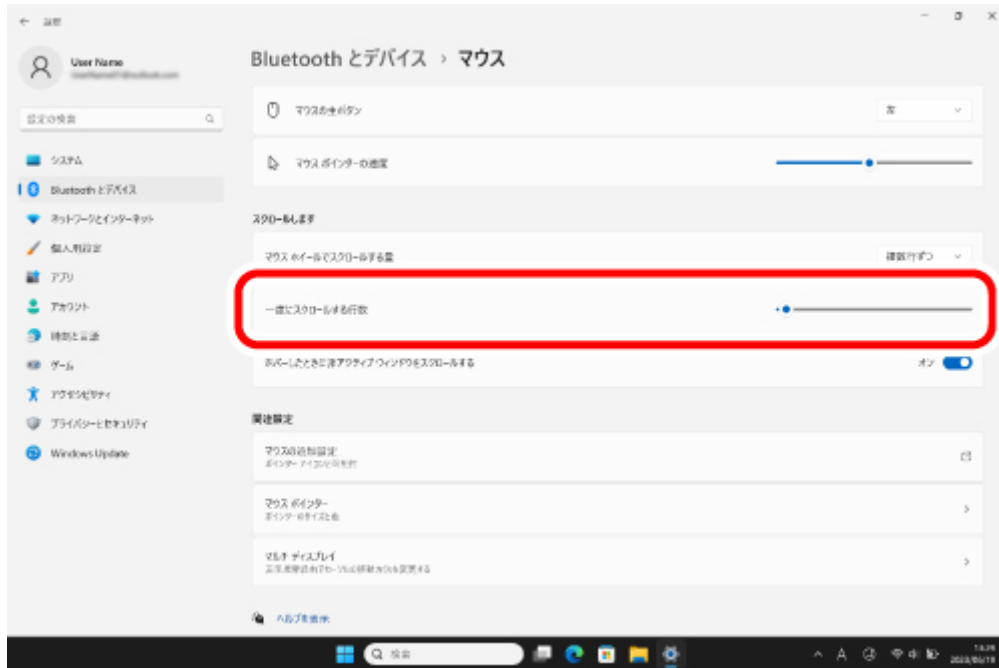

## ■ For Windows 10

### 1) Open "Mouse" properties.

From the start menu, click the Settings icon, select "Devices" → "Mouse", then click "Additional mouse options" under "Related Settings".

### 2) Select the "Wheel" tab.

### 3) Change the value of "The following number of lines at a time" under "Roll the wheel one notch to scroll"

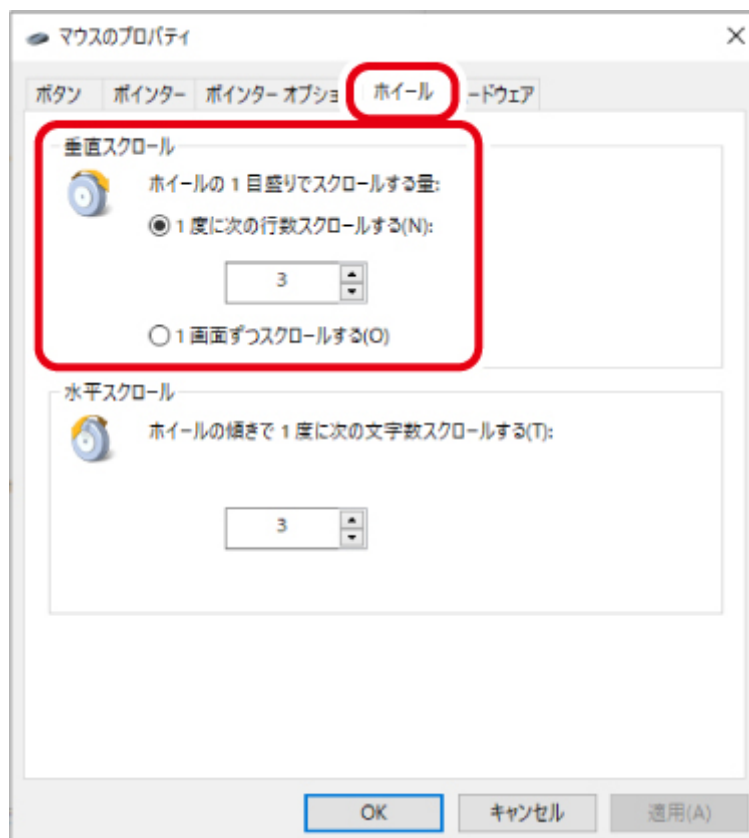

## 1. Turn the power ON

1) Remove the battery cover.

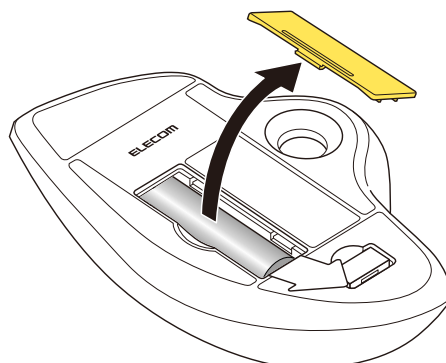

2) Remove the battery insulating tab.

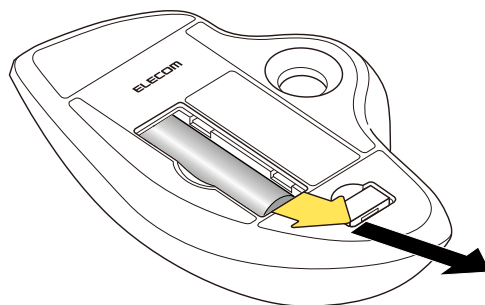

3) Put the battery cover back on.

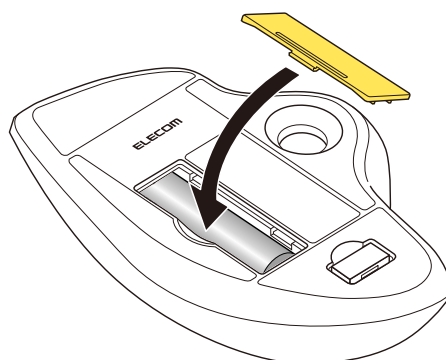

4) Remove the receiver unit.



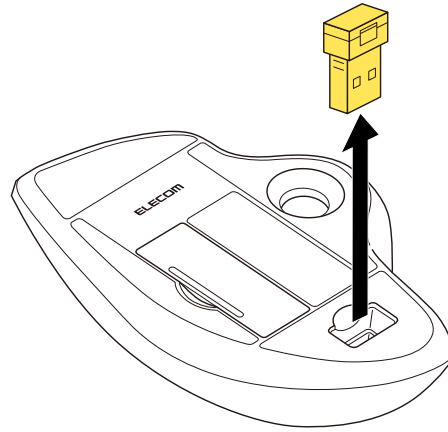

**5) Slide the power switch to the ON position.**

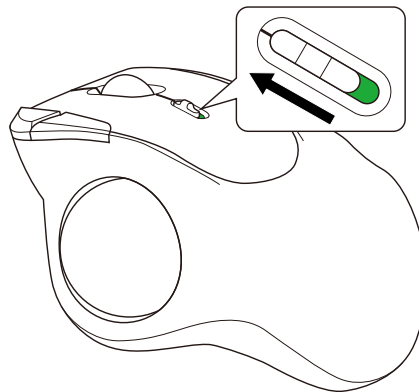

The light around the wheel lights up red for 3 seconds.

\* When the battery level is running low, the LED light will blink slowly for a period of time.



#### **Power-saving mode**

When the trackball is left untouched for a fixed period of time while the power is ON, it automatically shifts to power-saving mode.

Moving the trackball restores it from energy saving mode.

\* For two to three seconds after restoring from energy saving mode, trackball operation may be unstable.

### **Replacing the battery...**

**1) Remove the battery cover.**

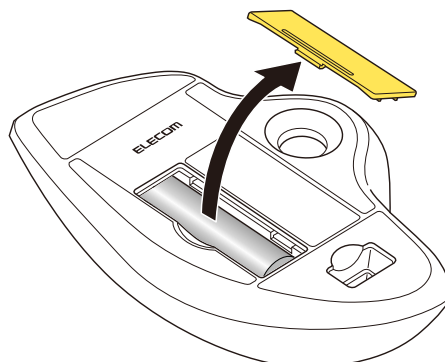

**2) Remove the battery.**

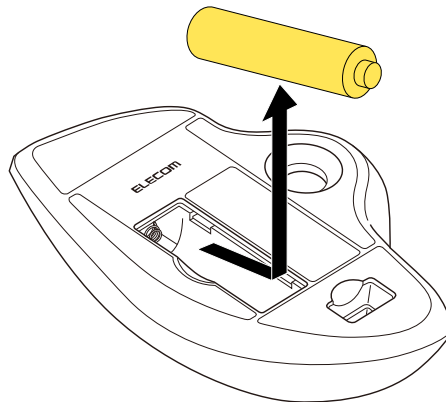

**3) Insert the battery according to the instructions on the battery compartment.**

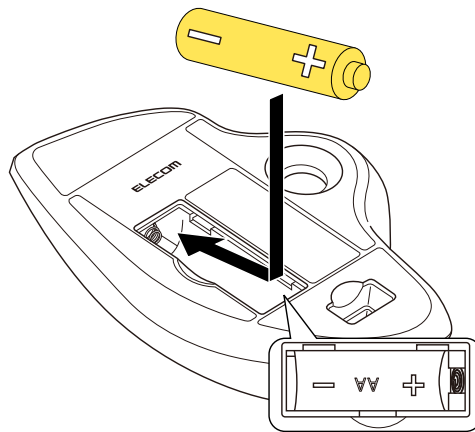

Ensure that the battery is inserted with the positive (+) and negative (-) terminals oriented correctly.

**4) Put the battery cover back on.**

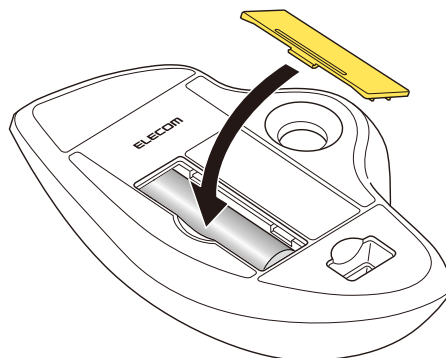

## **2. Connect to a PC**

**1) Start up your PC.**

Please wait until your PC has started up and can be operated.

**2) Insert the receiver unit into the PC's USB-A port.**

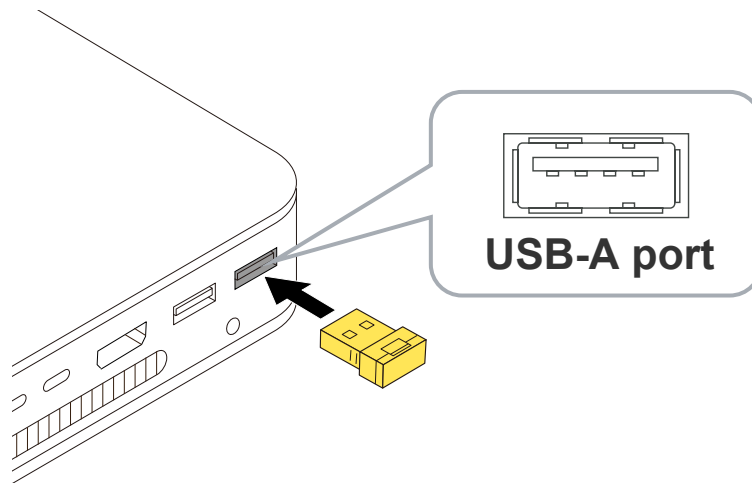

You may use any USB-A port.



• For terminals that do not have a USB-A port, such as a MacBook, use the USB Type-C® hub.

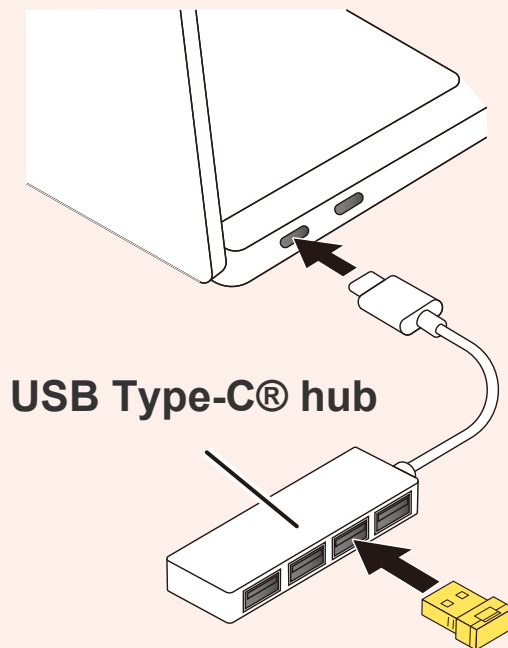

- Ensure that the connector is correctly oriented to the port.
- If there is strong resistance when inserting, check the shape and orientation of the connector. Forcibly inserting the connector may damage the connector, and there is a risk of injury.
- Do not touch the terminal portion of the USB connector.



#### **When removing the receiver unit**

This product supports hot plugging. The receiver unit can be removed while the PC is on.

### **3) The driver is automatically installed and the trackball can be used.**

**You can now use the trackball.**

By downloading and installing the "ELECOM Mouse Assistant" from our company website, functions such as button assignment function and presentation mode can be used. Please proceed to "[Install ELECOM Mouse Assistant](#)".

\* The screenshots will be replaced with the English version when it's ready

## Change the mouse pointer speed

Adjust the mouse pointer movement speed on your PC if the mouse pointer moves too fast or too slow.

### 1) Click "Mouse" under "System Settings".

The "Mouse" settings page will load up.



### 2) Adjust the "Tracking speed" slider to adjust the speed of the mouse pointer.



 Unchecking "Natural scrolling" will cause the scroll direction to be reversed.

## 1. Turn the power ON

1) Remove the battery cover.

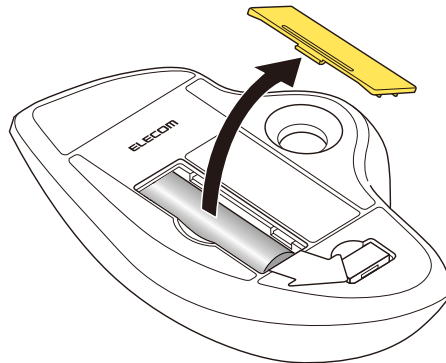

2) Remove the battery insulating tab.

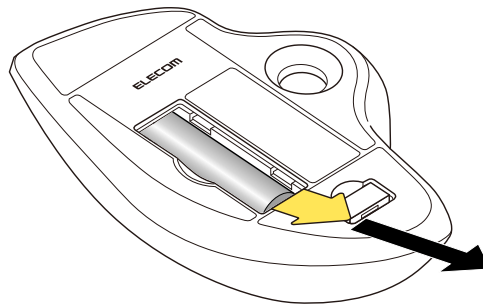

3) Put the battery cover back on.

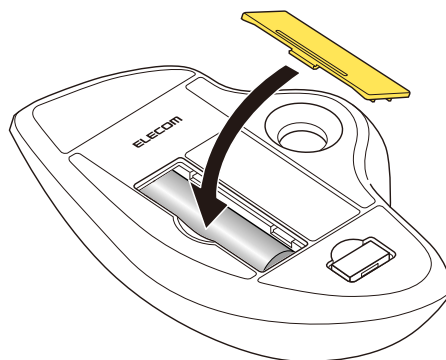

4) Remove the receiver unit.

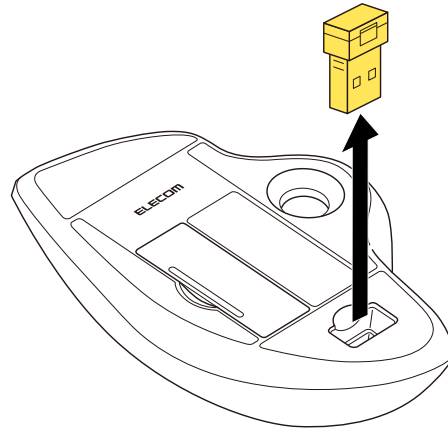

**5) Slide the power switch to the ON position.**

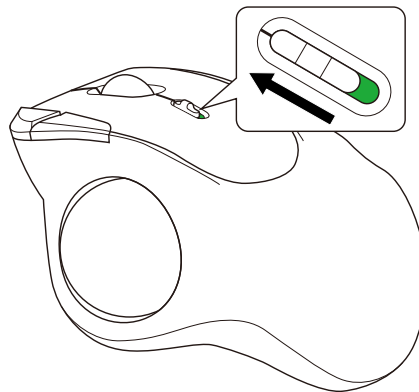

The light around the wheel lights up red for 3 seconds.

\* When the battery level is running low, the LED light will blink slowly for a period of time.



#### **Power-saving mode**

When the trackball is left untouched for a fixed period of time while the power is ON, it automatically shifts to power-saving mode.

Moving the trackball restores it from energy saving mode.

\* For two to three seconds after restoring from energy saving mode, trackball operation may be unstable.

### **Replacing the battery...**

**1) Remove the battery cover.**

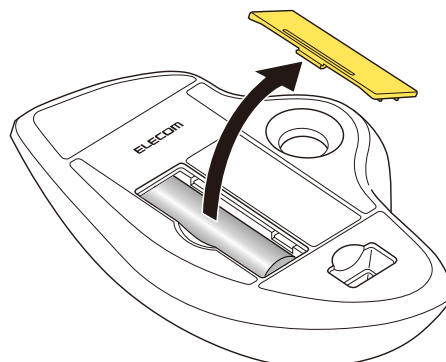

**2) Remove the battery.**

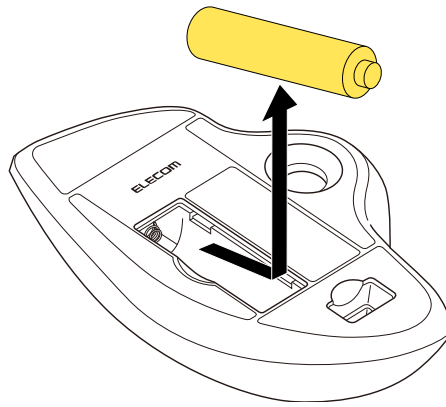

**3) Insert the battery according to the instructions on the battery compartment.**

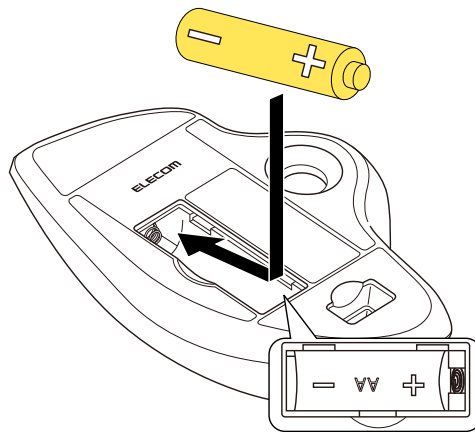

Ensure that the battery is inserted with the positive (+) and negative (-) terminals oriented correctly.

**4) Put the battery cover back on.**

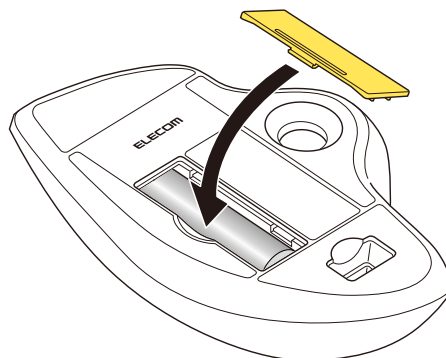

## **2. Connect to a PC**

**1) Start up your PC.**

Please wait until your PC has started up and can be operated.

**2) Insert the receiver unit into the PC's USB-A port.**

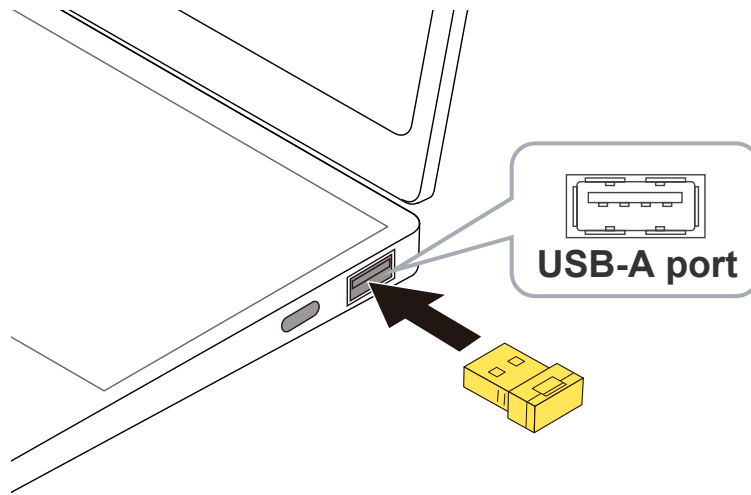

You may use any USB-A port.



• For devices that do not have a USB-A port, please use a USB Type-C hub.

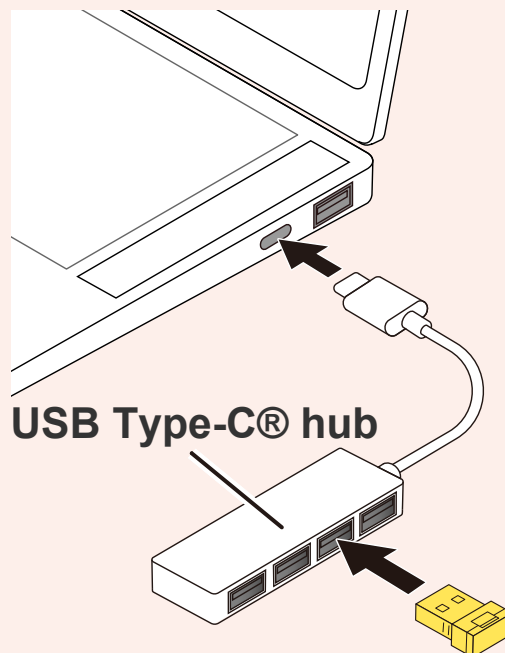

- Ensure that the connector is correctly oriented to the port.
- If there is strong resistance when inserting, check the shape and orientation of the connector. Forcibly inserting the connector may damage the connector, and there is a risk of injury.
- Do not touch the terminal portion of the USB connector.



#### **When removing the receiver unit**

This product supports hot plugging. The receiver unit can be removed while the PC is on.

### **3) The driver is automatically installed and the trackball can be used.**

**You can now use the trackball.**

## **Change the mouse pointer speed**

Adjust the mouse pointer movement speed on your PC if the mouse pointer moves too fast or too slow.

### **1) Click on the quick settings panel on the bottom right.**



\* The screenshots will be replaced with the English version when it's ready

## 2) Click on "Settings".

The settings page will appear.

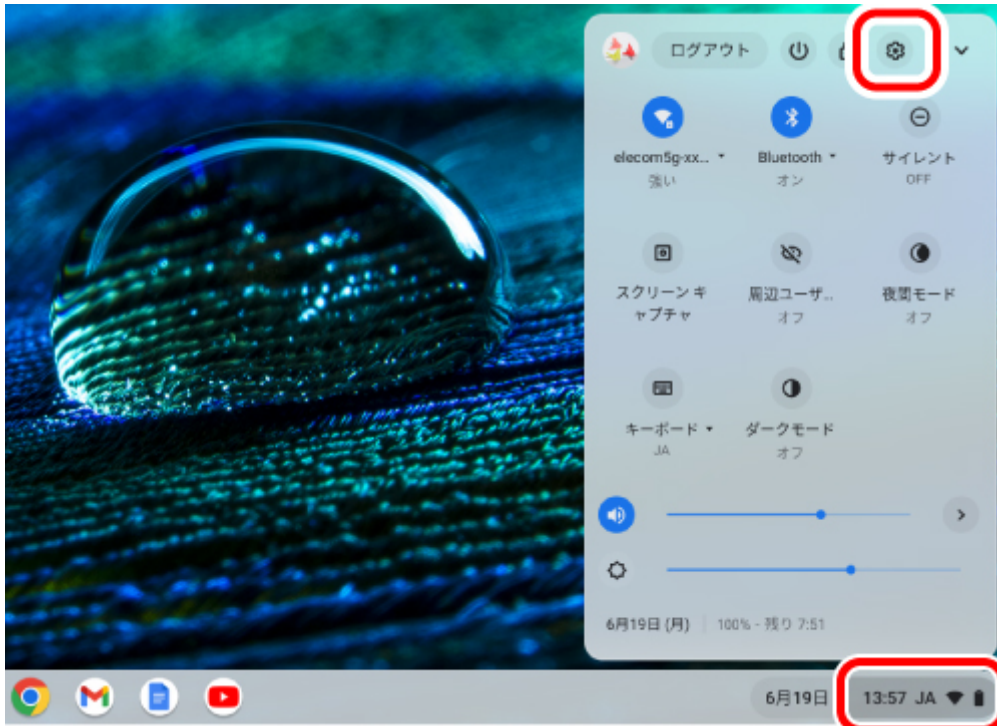

## 3) Click on "Mouse and touchpad" under "Device".



## 4) Adjust the "Mouse speed" slider to adjust the speed of the mouse pointer.

\* The screenshots will be replaced with the English version when it's ready



\* XXX will be determined when it's fixed.

## Product specifications



Connector type	USB Type-A plug
Connection method	USB 2.4 GHz Wireless
Compatible models	USB port-equipped Windows OS, macOS, and ChromeOS devices
Supported OS	Windows 11/10, macOS Ventura 13 and ChromeOS * Update for each new version of the OS or the installation of a service pack might be required. * Compatibility information was retrieved during operation confirmation in our verification environment. There is no guarantee of full compatibility with all devices, OS versions and applications.
Communication method	GFSK
Radio frequency	2.4 GHz
Radio wave range	Maximum distance approximately 10 m *May vary depending on the environment.
Sensor Resolution	500 DPI
Sensor type	IR LED

\* **XXX will be determined when it's fixed.**

Light beam type	Infra-red light
Buttons	5 * including wheel button
Number of wheels	1
Power source	Any 1 of AA alkaline battery, AA manganese battery or AA nickel-metal hydride rechargeable battery
Battery life	Maximum duration approximately XX months (estimated operating time when using alkaline batteries) * May vary depending on the usage conditions.
Size category	XL size
External dimensions (main unit)	Approximately width 96 mm × length 126 mm × height 52 mm / width 3.8 in. × length 5.0 in. × height 2.0 in.
External dimensions (receiver)	Approximately width 19 mm × length 14.5 mm × height 6.3 mm / width 0.75 in. × length 0.57 in. × height 0.25 in.
Weight (main unit)	Approximately XX g / X.X oz *excluding battery
Mass (receiver unit)	Approximately 2 g / 0.07 oz
Operating environment conditions	Temperature: 5 °C to 40 °C / 41 °F to 104 °F, humidity: 90 % RH (without condensation)
Storage environment conditions	Temperature: -10 °C to 60 °C / 14 °F to 140 °F, humidity: 90 % RH (without condensation)
Accessories	Support part removal tool × 1
Environmental Considerations	EU RoHS compliant (10 substances), environmentally friendly package

## Compliance status



**Model/모델명//设备型号/型号: M-IT10DR, E01D**

[www.elecom.co.jp/global/certification/](http://www.elecom.co.jp/global/certification/)

\* **XXX will be determined when it's fixed.**

## ▼ China / 中国

**RoHS Compliance (产品中有毒有害物质或元素的名称及含量)**

[https://www.elecom.co.jp/global/certification/pdf/RoHS\\_China.pdf](https://www.elecom.co.jp/global/certification/pdf/RoHS_China.pdf)

## ▼ EU



**CE Declaration of Conformity**

[https://www.elecom.co.jp/global/certification/pdf/CE\\_DoC.pdf](https://www.elecom.co.jp/global/certification/pdf/CE_DoC.pdf)

**RoHS Compliance**

[https://www.elecom.co.jp/global/certification/pdf/RoHS\\_EU\\_UK\\_Vietnam.pdf](https://www.elecom.co.jp/global/certification/pdf/RoHS_EU_UK_Vietnam.pdf)

**CE Authorised representative:**

Amazon Services Europe S.à r.l

38 avenue John F. Kennedy, L-1855 Luxembourg



**WEEE Disposal and Recycling Information**

This symbol means that waste of electrical and electronic equipment (WEEE) should not be disposed as general household waste. WEEE should be treated separately to prevent possible harm to the environment or human health. Consult your retailer or local municipal office for collection, return, recycle or reuse of WEEE.

**FR: INFORMATION DES CONSOMMATEURS SUR LA RÈGLE DE TRI**

<https://www.elecom.co.jp/global/certification/pdf/FR-Info-Tri.pdf>

## ▼ Korea / 대한민국



인증번호: R-R-ELJ-M-IT10DR

**\* XXX will be determined when it's fixed.**

**인증번호: R-R-ELJ-E01D**

제작자 및 설치자는 해당 무선설비가 전파혼신 가능성이 있으므로 인명안전과 관련된 서비스는 할 수 없습니다.

## ▼ Singapore

Complies with  
IMDA standards  
DA106058.

**Operating Frequencies:** XXXX-XXXX MHz

**Maximum field intensity / RF Output power:** X.XX dBm / X.XX mW

## ▼ Taiwan / 台灣



**BSMI RoHS Compliance (限用物質含有情況標示聲明書)**

[https://www.elecom.co.jp/global/certification/pdf/RoHS\\_Taiwan.pdf](https://www.elecom.co.jp/global/certification/pdf/RoHS_Taiwan.pdf)



**型號 M-IT10DR:** XXXXXXXXXXXXXXXX

**型號 E01D:** XXXXXXXXXXXXXXXX

取得審驗證明之低功率射頻器材，非經核准，公司、商號或使用者均不得擅自變更頻率、加大功率或變更原設計之特性及功能。低功率射頻器材之使用不得影響飛航安全及干擾合法通信；經發現有干擾現象時，應立即停用，並改善至無干擾時方得繼續使用。前述合法通信，指依電信管理法規定作業之無線電通信。低功率射頻器材須忍受合法通信或工業、科學及醫療用電波輻射性電機設備之干擾。

## ▼ UK



### UK Declaration of Conformity

[https://www.elecom.co.jp/global/certification/pdf/UK\\_DoC.pdf](https://www.elecom.co.jp/global/certification/pdf/UK_DoC.pdf)

### RoHS Compliance

[https://www.elecom.co.jp/global/certification/pdf/RoHS\\_EU\\_UK\\_Vietnam.pdf](https://www.elecom.co.jp/global/certification/pdf/RoHS_EU_UK_Vietnam.pdf)



### WEEE Disposal and Recycling Information

This symbol means that waste of electrical and electronic equipment (WEEE) should not be disposed as general household waste. WEEE should be treated separately to prevent possible harm to the environment or human health. Consult your retailer or local municipal office for collection, return, recycle or reuse of WEEE.

### ▼ US

FCC ID: YWO-M-IT10DR

FCC ID: YWO-E01D

This device complies with Part 15 of the FCC Rules. Operation is subject to the following two conditions: (1) this device may not cause harmful interference, and (2) this device must accept any interference received, including interference that may cause undesired operation.

NOTE; This equipment has been tested and found to comply with the limits for a Class B Digital Device, pursuant to part 15 of the FCC Rules. These limits are designed to provide reasonable protection against harmful interference in a residential installation. This equipment generates, uses and can radiated radio frequency energy and, if not installed and used in accordance with the instruction, may cause harmful interference to radio communication. However, there is no guarantee that interference will not occur in a particular installation. If this equipment does cause harmful interference to radio or television reception, which can be determined by tuning the equipment off and on, the user is encouraged to try to correct the interference by one or more of the following measures:

- Reorient or relocate the receiving antenna
- Increase the separation between the equipment and receiver
- Connect the equipment into an outlet on a circuit different from that to which the receiver is connected
- Consult the dealer or an experienced radio/TV technician for help

NOTICE: The manufacture is not responsible for any radio or TV interference caused by unauthorized modification to this equipment. Such modifications could void the user's authority to operate the equipment.

In order to make improvements to this product, the design and specifications are subject to change without prior notice.

**FCC Caution:** To assure continued compliance, any changes or modifications not expressly approved by the party responsible for compliance could void the user's authority to operate this equipment. (Example - use only shielded interface cables when connecting to computer or peripheral devices).

### **FCC Radiation Exposure Statement**

This equipment complies with FCC RF radiation exposure limits set forth for an uncontrolled environment. This equipment should be installed and operated with a minimum distance of 0.5 cm between the radiator and your body.

This transmitter must not be co-located or operating in conjunction with any other antenna or transmitter.

The antennas used for this transmitter must be installed to provide a separation distance of at least 0.5 cm from all persons and must not be co-located or operating in conjunction with any other antenna or transmitter.

### **Responsible party**

ELECOM USA, Inc.

4041 MacArthur Blvd Suite 400, Newport Beach, CA 92660 USA

[elecomusa.com](http://elecomusa.com)

## **▼ Vietnam / Việt Nam**

### **RoHS Compliance (Chứng Nhận Đạt Tiêu Chuẩn RoHS)**

[https://www.elecom.co.jp/global/certification/pdf/RoHS\\_EU\\_UK\\_Vietnam.pdf](https://www.elecom.co.jp/global/certification/pdf/RoHS_EU_UK_Vietnam.pdf)