

# Ant. Matching

- Antenna Placement

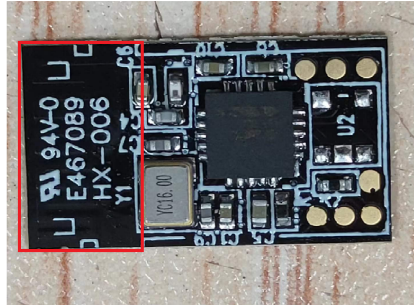

- Matching Circuit

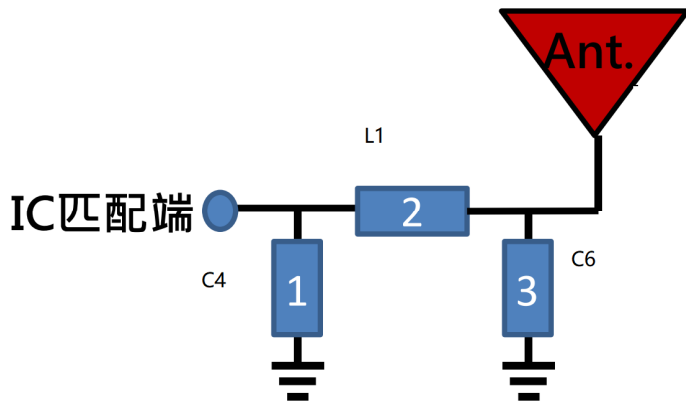
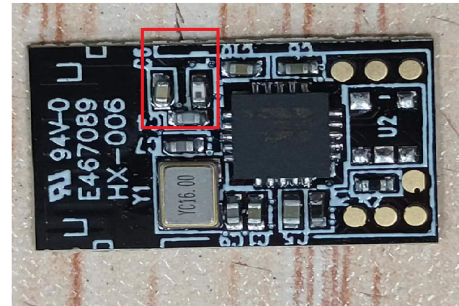

	LC	P/N
Ant.		
1	1.2PF	Murata
2	1NH	Murata
3	1.2PF	Murata

# Ant. S11 Parameter

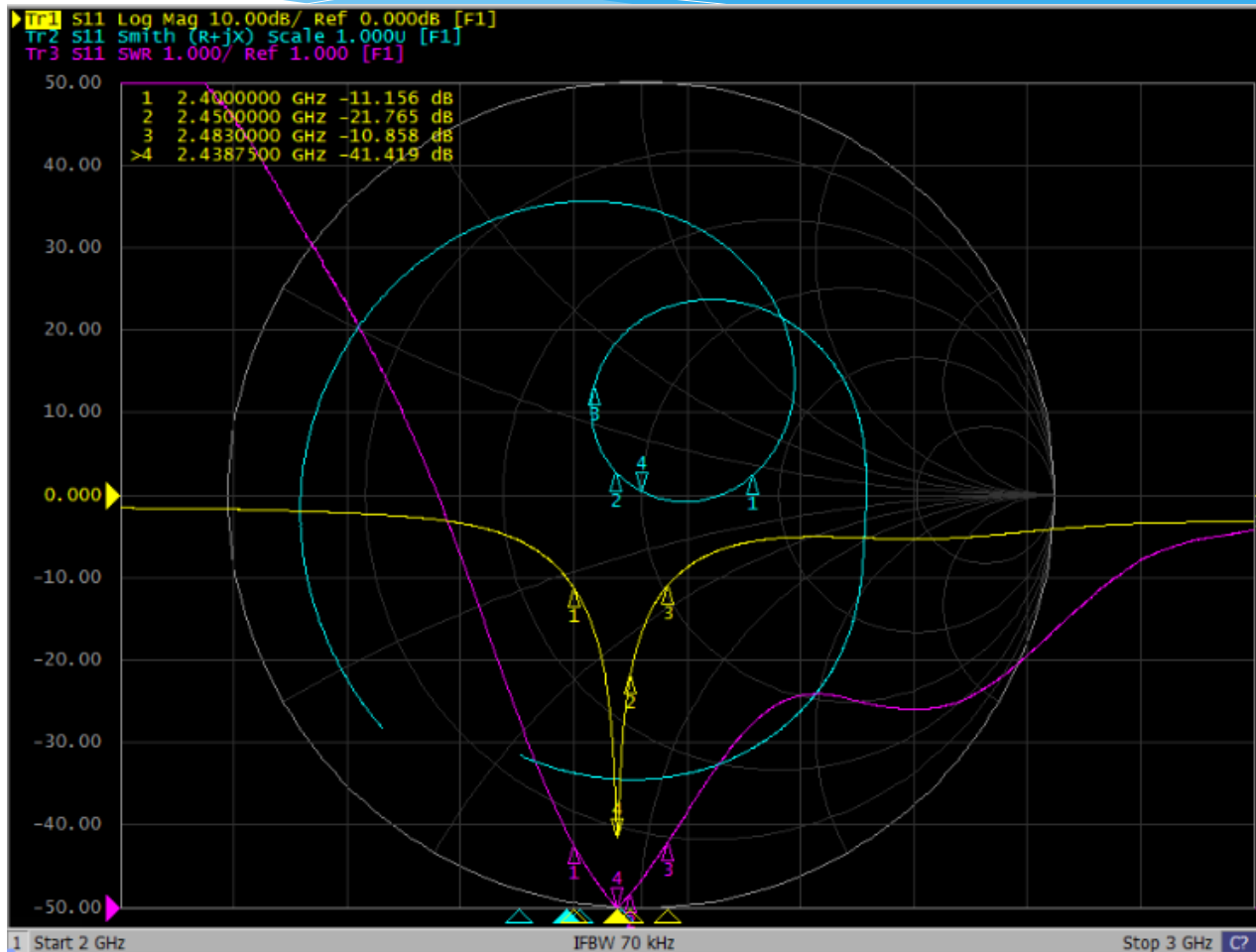

Fre.(MHz)	2400	2450	2483
S11(dB)	-11.1	-21.7	-10.8

# Ant. Gain Pattern@2.45GHz(无源)

- Free Space

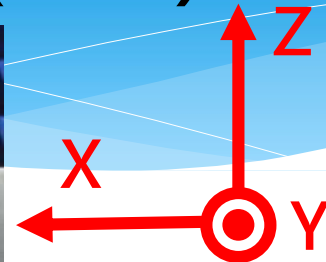

2450.0MHz H+V, Eff: 15.4%

Back View

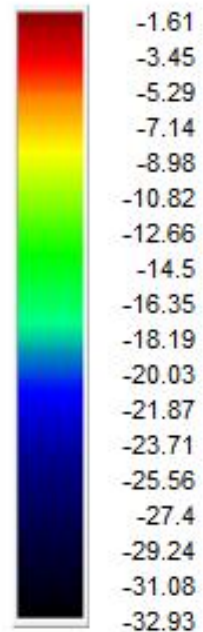
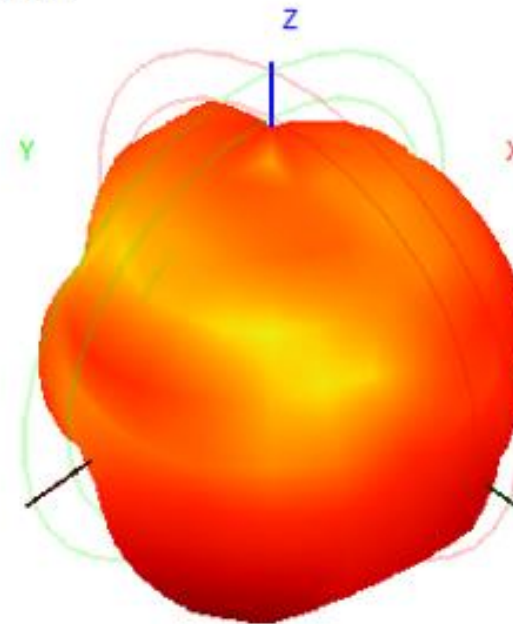
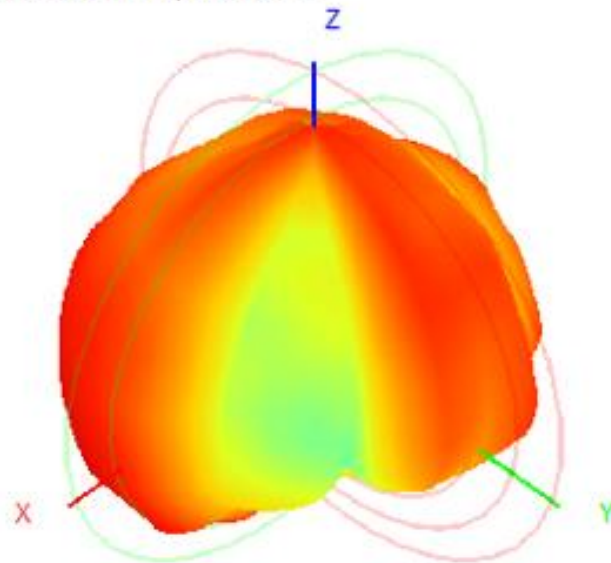

Frequency (MHz)	2400.0	2410.0	2420.0	2430.0	2440.0	2450.0	2460.0	2470.0	2480.0	2490.0	2500.0
Efficiency (dBi)	-8.27	-8.04	-7.97	-7.93	-8.01	-8.12	-8.29	-8.51	-8.80	-9.08	-9.48
Gain (dBi)	-1.93	-1.68	-1.59	-1.50	-1.50	-1.61	-1.84	-2.14	-2.58	-3.06	-3.56
Efficiency (%)	14.90	15.69	15.96	16.12	15.82	15.42	14.83	14.09	13.18	12.36	11.26