

OPERATOR'S MANUAL

Green Auto Leveling Rotary Laser Level

GRL9202



WARNING:

To reduce the risk of injury, the user must read and understand the operator's manual before using this product.

Thank you for buying a RIDGID product.

SAVE THIS MANUAL FOR FUTURE REFERENCE

TABLE OF CONTENTS

■ **General Safety Instruction**

Safety Symbols

Damage Prevention and Information Messages

Safety Precautions for Lasers and Operations

Electricity Safety

Service Safety

FCC Statement

■ **Unpacking and Checking Contents**

Unpacking

List of Contents

■ **Getting to Know Your Green Auto Leveling Rotary Laser Level**

Main Parts

Keyboard Functions

Technical Specifications

■ **Operation**

To Install / Change Batteries

To Connect AC/DC Adapter to the Green Auto Leveling Rotary Laser Level

Turn ON/OFF the Green Auto Leveling Rotary Laser Level

Choose the Working Mode

Axis Drive Error

Remote Control

Green Laser Detector

Detector Mounting Base

Wall mounting Base

Surveyor's tripod

Leveling rod

■ **Application**

■ **Maintaining Your Green Auto Leveling Rotary Laser Level**

■ **Accuracy Checking and Calibration**

■ **Troubleshooting**

■ **Warranty**

GENERAL SAFETY INSTRUCTIONS

The purpose of safety symbols is to attract your attention to possible dangers. The safety symbols and the explanations with them deserve your careful attention and understanding. The symbol warnings **DO NOT**, by themselves, eliminate any danger. The instructions and warnings they give are no substitutes for proper accident prevention measures.

Safety Symbols



SAFETY ALERT SYMBOL: Indicates **DANGER, WARNING, OR CAUTION**; may be used in conjunction with other symbols or pictographs.



DANGER: Failure to obey this safety warning **WILL** result in death or serious injury to you or to others. Always follow the safety precautions to reduce the risk of fire, electric shock, and personal injury.



WARNING: Failure to obey this safety warning **CAN** result in death or serious injury to you or to others. Always follow the safety precautions to reduce the risk of fire, electric shock, and personal injury.



CAUTION: Failure to obey this safety warning **MAY** result in personal injury to you or to others or property damage. Always follow the safety precautions to reduce the risk of fire, electric shock, and personal injury.

Damage Prevention and Information Messages

These inform user of important information and/or instructions that could lead to equipment or other property damage if not followed. Each message is preceded by the word "**NOTE:**" as in the example below:

NOTE: Equipment and/or property damage may result if these instructions are not followed.



WARNING: Be sure to read and understand all safety instructions in this manual, including all safety alert symbols such as "**DANGER,**" "**WARNING,**" and "**CAUTION,**" before using this Green Auto Leveling Rotary Laser Level. Failure to follow all

instructions listed below may result in electric shock, fire, and/or serious personal injury.

Safety Precautions for Lasers and operations

⚠ DANGER: DO NOT OPERATE the leveling rod during storms or near high voltage, if the leveling rod were to fall and contact high voltage it will result in serious electric shock and/or bodily injury.

⚠ WARNING: Use of controls, adjustments, or performance of procedures other than those specified in this manual may result in hazardous radiation exposure.

⚠ WARNING: The use of optical instruments such as, but not limited to, telescopes or transits to view the laser beam will increase eye hazard.

⚠ CAUTION: Do not attempt to modify the performance of the level in any way. This may result in a dangerous exposure to laser radiation.

⚠ WARNING: Batteries can explode or leak, causing injury or fire. To reduce this risk, always follow all instructions and warning on the battery label and package.

⚠ CAUTION: The following labels are on your level. They indicate the location from which the green rotary laser level emits the laser light. Be aware of the laser light location when using the level. Always make sure that any bystanders in the vicinity of use are made aware of the dangers of looking directly into the laser.

Remote Control
Model: RC9202
3V  (2x1.5V AAA batteries)
FCC ID: YWKRC9202
This device complies with Part 15 of the FCC Rules. Operation is subject to the following two conditions: (1) this device may not cause harmful interference, and (2) this device must accept any interference received, including interference that may cause undesired operation.

FCC ID: YWKGRL9202
This device complies with Part 15 of the FCC rules. Operation is subject to the following two conditions: (1) This device may not cause harmful interference, and (2) This device must accept any interference received, including interference that may cause undesired operation.
Ce dispositif est conforme à la partie 15 des règles de FCC. L'exécution est sujette aux deux conditions suivantes : (1) ce dispositif ne peut pas entraîner l'interférence nocive, et (2) Ce dispositif doit recevoir n'importe quelle interférence reçue, y compris l'interférence qui peut entraîner l'exécution peu désirée.
Este dispositivo cumple con la parte 15 de las reglas de la FCC. La operación está conforme a las dos condiciones siguientes: (1) Este dispositivo debe validar cualquier interferencia recibida, incluyendo interferencia que pueda causar la operación indeseada.



WARNING: Laser radiation. **AVOID DIRECT EYE EXPOSURE. Class IIIa Laser Product!**

- **Do not** remove or deface any product labels.
- **Avoid** direct eye exposure. The laser beam can cause flash blindness.
- **Never** direct the laser light emitted from this level towards any person for any reason.
- **Do not** place the level in a position that may cause anyone to stare at the laser beam, whether intentionally or unintentionally.
- **Do not** use on surfaces that have shiny, reflective surfaces such as sheet steel. The shiny surface could reflect the beam back at the operator.
- **Always** turn the green rotary laser level off when it is not in use. Leaving the level on increases the risk of someone inadvertently staring into the laser beam.
- **Do not** operate the green rotary laser level around children or allow children to operate the tool.
- **Always** keep this green rotary laser level, batteries and the accessories out of the reach of children. They are not toys.
- **Do not** operate the green rotary laser level in combustible areas, such as in the presence of flammable liquids, gases, or dust.
- **Always** use only accessories that are designed for use with this product. Use of accessories that have been designed for use with other laser tools could result in serious injury.
- **Do not** attempt to modify the performance of this laser level in any way. This may result in a dangerous exposure to laser radiation.
- **Always** check to be sure that the green rotary laser level is securely mounted on the base when using any of the base plates. Damage to the tool and/or serious injury to the user could result if the level falls.
- **Do not** use the laser enhancing glasses as safety goggles. The laser enhancing

glasses are intended to improve visibility of the laser beam, but they do not protect against laser radiation or injuries to the eyes.

- **Do not** use the laser enhancing glasses as sun glasses or in traffic. The laser enhancing glasses do not afford complete UV protection and can reduce color perception.
- **Do not** use this green rotary laser level for any purpose other than those outlined in this manual. This could result in serious injury.
- For further information regarding lasers, refer to ANSI-Z136.1, the Standard for the Safe Use of Lasers, available from the Laser Institute of America (407) 380-1553.
- **Do not** short any battery terminals.
- **Do not** attempt to recharge alkaline batteries.
- **Do not** mix old and new batteries. Replace all of them at the same time with new batteries of the same brand and type.
- **Always** dispose of the used batteries according to your local ordinance; **do not** incinerate the batteries.
- **Keep** batteries out of reach of children.
- **Remove** batteries if the device will not be used for several months.

Electricity Safety

- **Before** using the power adapter, be sure that the outlet voltage supplied is same as the voltage marked on the level's power adapter.
- **Do not** expose the power adapter to rain or wet conditions. Water entering the adapter will increase the risk of electric shock.
- **Always** use an outdoor extension cord marked "W-A" or "W" when operating the power adapter outside. These cords are rated for outdoor use and reduce the risk of electric shock.



CAUTION: To reduce the risk of electric shock, use the tool only in dry location.

Service Safety

Do not attempt to repair or disassemble the Green Auto Leveling Rotary Laser Level. If unqualified persons attempt to repair this product, serious injury may occur. Any repair required on this laser tool should be performed only by authorized service personnel.

FCC Statement

FCC STATEMENT

1. This device complies with Part 15 of the FCC Rules. Operation is subject to the following two conditions:

(1) This device may not cause harmful interference.

(2) This device must accept any interference received, including interference that may cause undesired operation.

2. Changes or modifications not expressly approved by the party responsible for compliance could void the user's authority to operate the equipment.

NOTE: This equipment has been tested and found to comply with the limits for a Class B digital device, pursuant to Part 15 of the FCC Rules. These limits are designed to provide reasonable protection against harmful interference in a residential installation.

This equipment generates uses and can radiate radio frequency energy and, if not installed and used in accordance with the instructions, may cause harmful interference to radio communications. However, there is no guarantee that interference will not occur in a particular installation. If this equipment does cause harmful interference to radio or television reception, which can be determined by turning the equipment off and on, the user is encouraged to try to correct the interference by one or more of the following measures:

Reorient or relocate the receiving antenna.

Increase the separation between the equipment and receiver.

Connect the equipment into an outlet on a circuit different from that to which the receiver is connected.

Consult the dealer or an experienced radio/TV technician for help.

UNPACKING AND CHECKING CONTENTS

The Green Auto Leveling Rotary Laser Level level kit comes in one box. Do not discard any packing materials until all of the contents are accounted for.

Separate all the parts from the packing materials. Refer to the “List of Contents” and Fig. 1a to Fig. 1c to make certain that all of the items are accounted for before discarding any packing material. Call the RIDGID Service Center if any parts are damaged or missing.

List of Contents

PART NAME	QUANTITY
Green Auto Leveling Rotary Laser Level	1
Remote control	1
Green laser detector	1
AC/DC adapter	1
Wall mounting base	1
Detector mounting base	1
Green laser enhancing glasses	1
Magnetic laser target	1
Batteries for green rotary laser level	4
Batteries for remote control	2
Battery for green laser detector	1
Surveyor's tripod	1
Leveling rod	1

GETTING TO KNOW YOUR GREEN AUTO LEVELING ROTARY LASER LEVEL

Fig. 1a



Fig. 1b



Fig. 1c



Remote control



Green laser detector



AC/DC adapter



Green laser enhancing glasses



Magnetic laser target



Detector mounting base



Batteries for rotary laser



Wall mounting base



Batteries for laser detector



Batteries for remote control

Surveyor's tripod



Leveling rod



Protective cover

Protects the laser from dirt, water droplets and accidental damage.

Laser aperture

Laser is emitted from this aperture. **AVOID** direct eye exposure to the laser beam.

LCD panel

Large panel with blue backlight clearly displays the working mode and status.

Keypad (Fig. 2)

Keypad functions:

Fig. 2

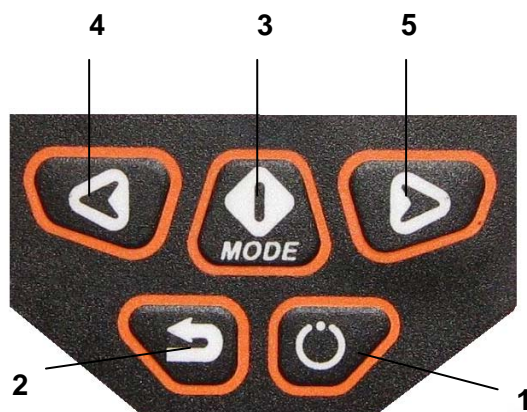

1. ON/OFF: press to turn on the level, press again to turn it off.
2. Return - return to the main menu from the submenu
3. Mode – choose among different working modes; enter the submenu
4. Left arrow – moves the cursor in the menu; moves the laser dot or chalk line in the counter-clockwise direction.
5. Right arrow – moves the cursor in the menu; moves the laser dot or chalk line in the clockwise direction.

Handle

Overmold handle for secure and comfortable transport.

6V AC/DC Adapter receptacle

For connection to the AC/DC adapter.

Battery cover knob

Turn to lock/unlock the battery cover.

Battery compartment

For 4 alkaline LR20 D batteries.

5/8" tripod screws

There are two 5/8" tripod screws: one is inside the bottom base, the other is inside the side base. They are used to connect the level to the surveyor's tripod or to the wall mounting base.

Top mounted sight

To orient the level to your target, and to locate the high and low points within the arc.

Rubber feet

The rubber feet keep the level stable on the working base.

Remote control

For remote operation within a range of 133 feet.

Green laser detector

Assists the detection of the green laser line position within a maximum range of 330 feet.

AC/DC adapter

The level can be powered with the AC/DC adapter for prolonged operation.

Laser enhancing glasses

Made of laser light enhancing material, the glasses improve the visibility of the tool's laser line.

WARNING: These glasses will not protect your eyes from damage that could result from looking directly at the laser projection.

Magnetic laser target

The laser target helps to improve the visibility of the green laser lines.

When the surrounding light is too bright, the laser line may be difficult to observe.

Surveyor's tripod

Support the laser level and permits height adjustment

Leveling rod

Supports the detector mounting base and green laser detector for detailed surveys.

Detector mounting base

Permits the laser detector to be mounted on the leveling rod or a vertical pillar.

Wall mounting base

Hang the mounted laser level can be hung from nails or screws on a wall or clamp it to a beam.

Technical Specifications

Power supply	4 pcs 1.5V "D" batteries for green rotary-laser level 2 pcs 1.5V "AAA" battery for remote control 1 pc 9V "6LR61" battery for green laser detector
AC/DC adapter	Output: 6V dc/Input: 100-240V, 50/60Hz
Laser Diode Type	Green Laser Diode 522-542nm
Laser Class	Class IIIa, output <5mW
Working range	Maximum 100 ft. (30m) without detector, depending upon light conditions Maximum 330 ft. (100m) with detector
Working range of remote control	133 feet (40m)
Accuracy of the rotary laser	$\pm 0.1\text{mm/m}$
Accuracy of the detector	Fine, $\pm 3\text{mm}$; Medium, $\pm 5\text{mm}$; Coarse, $\pm 8\text{mm}$
Auto leveling range	$\pm 5^\circ$
Leveling time	About 45s
Operating time	Approx. 40 hours with alkaline batteries.
Optimum operating temperature range	0-40°C
Storage temperature range	-20-60°C
Protection against water	IP54

OPERATION

To Install /Change Batteries for the Green Auto Leveling Rotary Laser Level

This green rotary laser level uses four “D” 1.5V batteries, included.

1. Turn the battery cover knob counterclockwise to open the battery compartment (Fig. 3).
2. Install four, new, “D” size, alkaline batteries according to the polarity indicators (+ and -) inside the battery compartment (Fig. 4).
3. Replace the battery compartment in the tool and tighten the battery cover knob clockwise to lock it.



To Connect AC/DC Adapter to the Green Auto Leveling Rotary Laser Level

The green rotary laser level can also be powered with the AC/DC adapter.

1. Insert the connecting plug into the adapter receptacle, located in the right top of the battery compartment (Fig. 5).
2. Plug the AC/DC adapter into the correct power outlet.

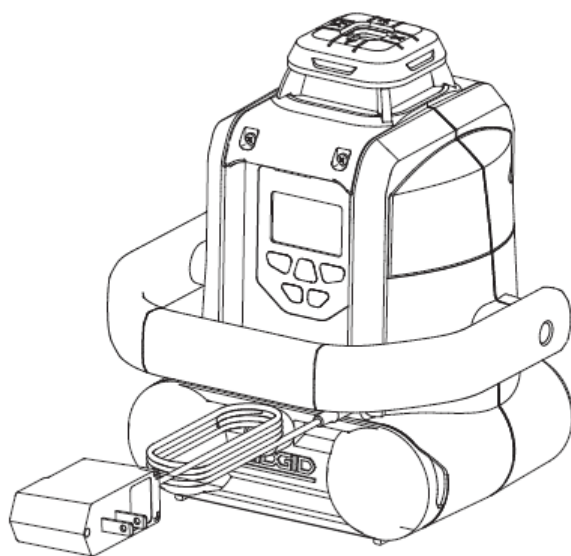

Fig. 5

Turn ON/OFF the Green Auto Leveling Rotary Laser Level

Press the power button  to turn on the Green Auto Leveling Rotary Laser Level:

- The display backlight will illuminate for increased visibility.
- The backlight will turn off automatically after one minute has elapsed without keypad operation.
- The Green Auto Leveling Rotary Laser Level will automatically self-adjust to level in approximately 45 seconds.
- After self-leveling, the level will start operating in Rotation mode. (The default mode is Rotation.)

Either **H** or **V** will display in the upper line, next to the battery level indicator on the LCD when the level is turned on (Fig. 6).

H indicates that the level is positioned horizontally and will perform a leveling measurement;

V Indicates that the level is positioned vertically and will perform a plumb measurement.







The battery level indicator in the upper right of the display communicates the remaining charge in the batteries in the Green Auto Leveling Rotary Laser Level (Fig. 6).

6). Press the  button again to turn off power to the Green Auto Leveling Rotary Laser Level.

WARNING: When turning ON the Green Auto Leveling Rotary Laser Level, **ALWAYS** be aware of protecting your eyes and the eyes of those around you from the laser. **NEVER** point the laser at anyone's face, including your own.

WORKING MODES

Press the Mode button  to enter the main menu (Fig. 7a); there are four options on the screen: ROTATE, SWEEP, AUTO LEVEL and GRADE. Press the  or  button to move the cursor among these options. Press the  button to enter the submenu or confirm the chosen option; press the back button  to return to the main menu.

1. ROTATEMODE (Fig. 7a)

The default ROTATE mode generates a 360° horizontal (level) or vertical (plumb) reference, depending on the orientation of the Green Auto Leveling Rotary Laser Level. The 360° reference laser appears on all walls of a room (horizontal) or ceiling, floor, and opposite walls (vertical).

The ROTATE mode is automatically selected (light letters on a dark rectangle; see Fig.7a), after the Green Auto Leveling Rotary Laser Level is turned on or use the  button to select the ROTATE mode after another mode has been highlighted.

With ROTATE selected (highlighted) press the  button again to enter the sub menu to select among rotation speeds.

Fig. 7a

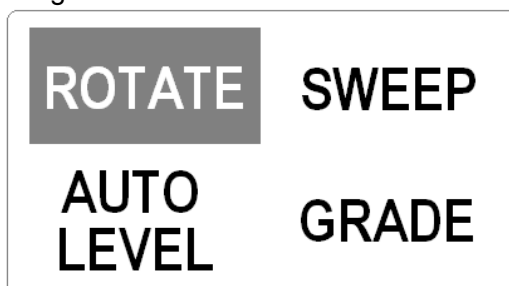

Fig. 7b

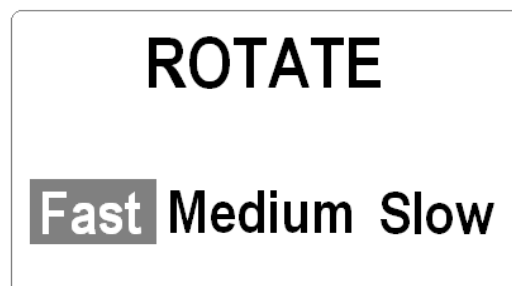

Fig. 7c

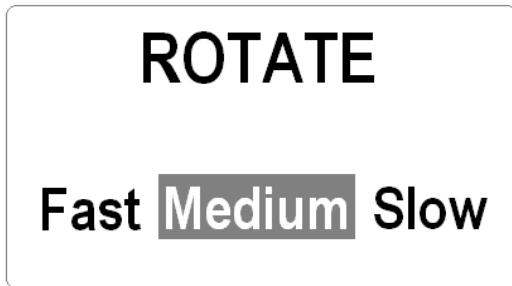
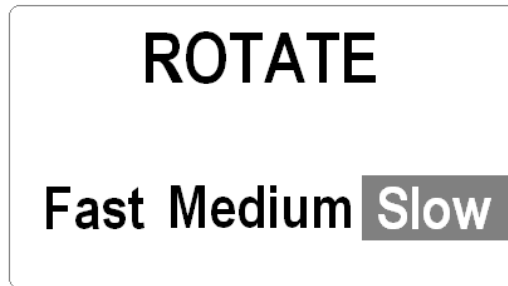

Fig. 7d



- Fast (Fig.7b):, the green laser line pulses very quickly; this is useful in darker or low light situations.
- Medium (Fig.7c): the green laser line appears to flash intermittently; this is useful in normal indoor light condition..
- Slow (Fig.7d): low speed, the laser flashes more slowly; this is useful in bright conditions out doors.

2. SWEEP MODE (Fig. 8a)

Instead of creating a 360° line, the Sweep (Scanning) Mode creates a shorter, brighter laser “chalk line” that can be used for leveling or plumbing doors, windows, fixtures, and more. You may also use this feature to keep the level from interfering with other lasers and detectors on site.

In the main menu, press the arrow buttons  or  to move the cursor to “SWEEP” (Fig. 8a). Press the  button to enter the submenu to select the desired configuration

Fig. 8a

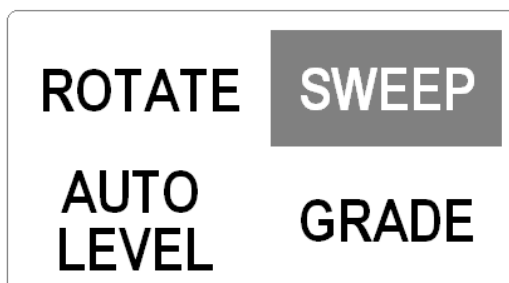

Fig. 8b

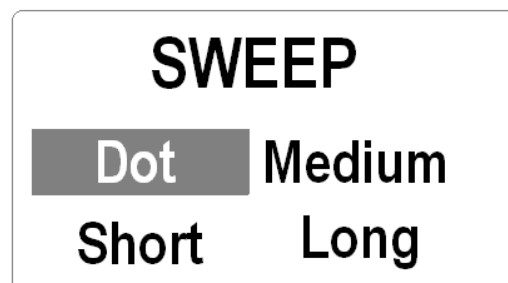

Fig. 8c

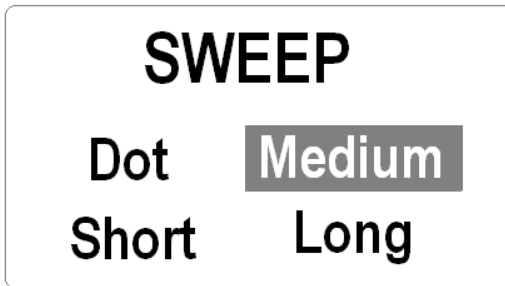

Fig. 8d

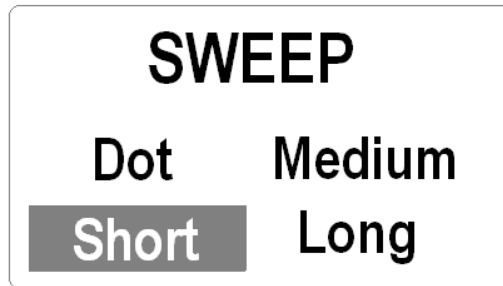

Fig. 8e

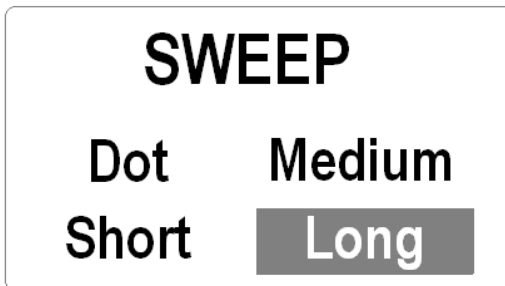



Fig. 8f





- Spot mode (Fig. 8b): creates a motionless laser dot for reference, allowing the level to be used as a straight-line laser.
- Medium (Fig. 8c): the tool produces a green laser line medium length
- Short (Fig. 8d): produces a short green laser line.
- Long (Fig. 8e): the tool sweeps a long green laser line.

Press the  button again to enter an additional submenu to change the dot or sweep direction. The laser dot or chalk line can be moved left or right by

pressing the  or  button (Fig. 8f).

3. AUTO LEVEL MODE

In the main menu, press the arrow buttons  or  to move the cursor to AUTO LEVEL (Fig. 9a). Press the  button to enter the submenu to select the desired action. (Figs 9b, 9c, 9d).

The Auto Level Mode determines how the level responds when it is moved out of level. The Auto level Mode can be set to ON, OFF, or Anti-Drift System (ADS).

Fig. 9a

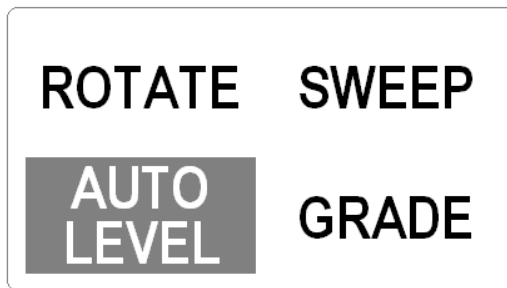

Fig. 9b

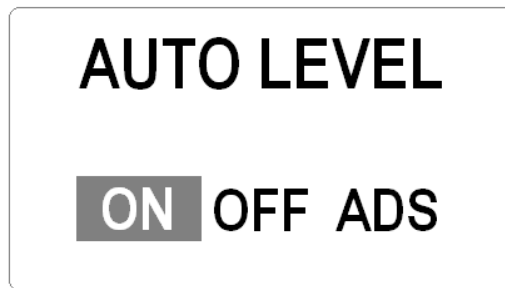

Fig. 9c

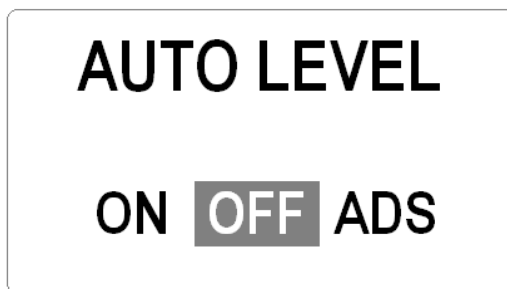
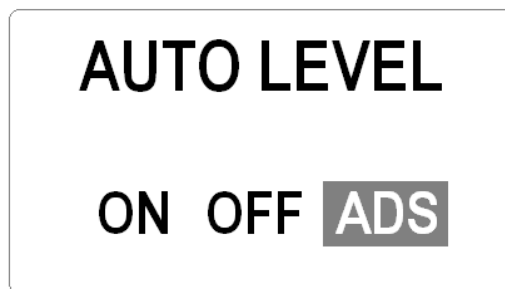

Fig. 9d



- **ON:** The level will automatically re-level when it is bumped or moved.
- **OFF:** The level will **NOT** re-level if it is moved out of level, and will continue to operate on the non-level plane. Select this option when using an adapter or mount that allows you to tilt the level to create a diagonal laser line.
- **ADS (Anti-Drift System):** The level will signal to the operator that it has been moved out of level. The laser head will stop rotating and the laser beam will blink.



NOTE:





- OFF and ADS modes are not available when the level is working in the GRADE mode.
- When setting to OFF or ADS mode, allow the level to self-level, wait until the word “Lock” or “ADS” shows on the LCD before the mode takes effect.

4. GRADE MODE- Dual or single axis grade

The dual grade function allows more specialized site preparations, such as road grading and paving), irrigation, trenching, landfills, slopes and embankments, and laying pipe.

Use the top mounted sight to orient the level to your target and to locate the high and low points within the arc (Fig. 10).

In the main menu, press the arrow buttons  or  to move the cursor to GRADE (Fig. 11a). Press the  button to enter the submenu to select the desired x and y axis. (Figs 11b, 11c, 11d, 11e).

In the Grade submenu, use the  or  button to choose the X axis or Y axis (Fig. 11a & Fig. 11b). Press the  button again enter the selected axis, press the  or  button to reduce or increase the percentage of the grade (Fig. 11c to Fig. 11e). The maximum grade range for both X axis and Y axis is 8%.

The Grade Percentage can be adjusted at any time while in this mode. The level will not move the desired grade until after it has self-leveled; allow ample time for the level to react to the input provided. Refer to examples in the illustration below to predict your results (Fig. 12a to Fig. 12d).

To exit Grade Mode, press the  button, the level will re-level.

Fig. 10



Fig. 11b

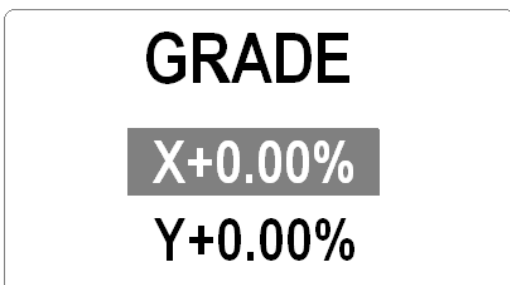

Fig. 11a

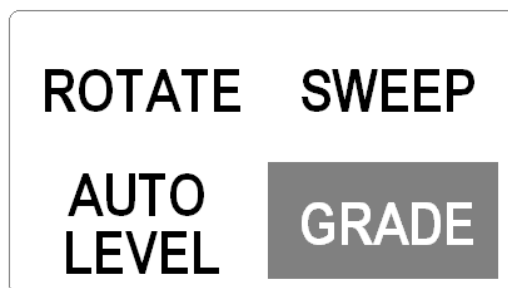

Fig. 11c

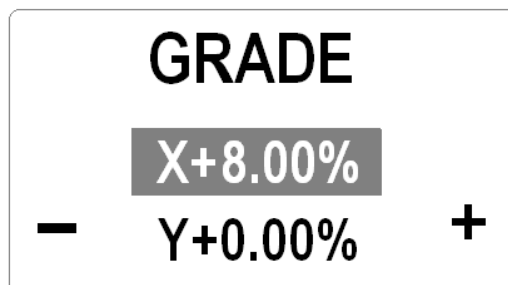

Fig. 11d

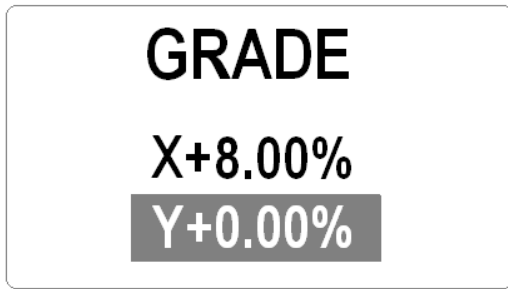

Fig. 11e

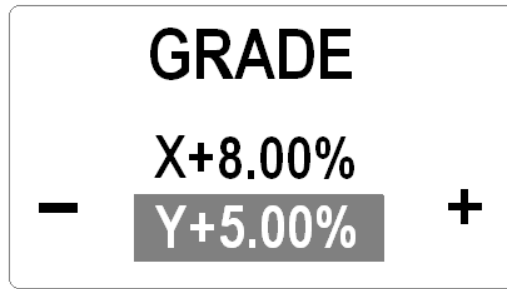

Fig. 12b

Fig. 12a

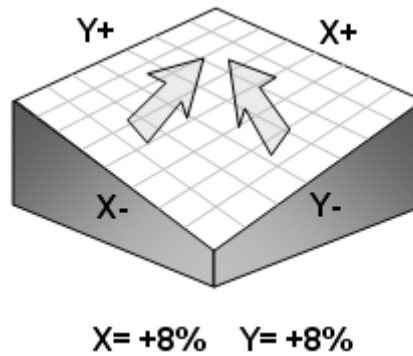
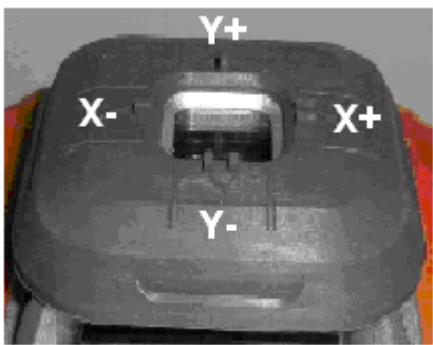

Fig. 12c

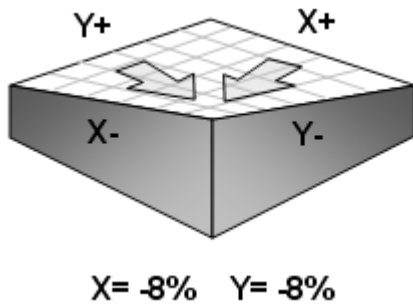
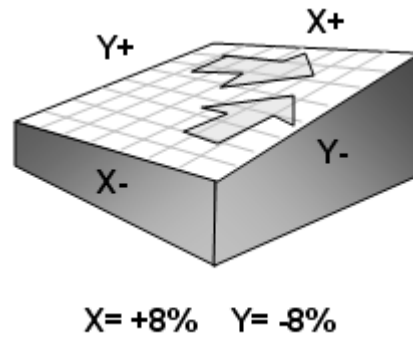

Fig. 12d



Axis Drive Error

If the level is set up beyond its self-leveling range of $\pm 5^\circ$, the laser head will initially attempt to level; however, when the self-leveling limit is reached, "Over" will appear on the LCD to communicate the axis error (Fig. 13). The laser head will stop running or chalking, and the laser blinks.

Move the level to a more level position and allow it to re-level.

Fig. 13



Remote Control

Description

The remote control can operate your Green Auto Leveling Rotary Laser Level within a maximum distance of 133 feet. Except for the power button  , the functions of other buttons on the remote control are the same as the buttons on the operation panel of the level.

POWER button the remote control

- Turn on/off the remote control;
- Put the Green Auto Leveling Rotary Laser Level in sleep mode when the level is turned on; it cannot turn on the rotary laser level directly if the level is powered off.
- Wake up the Green Auto Leveling Rotary Laser Level if the level is in sleep mode.

To Install/Change Batteries for the Remote Control

The remote control uses two “AAA” batteries.

- 1) Open the battery cover.
- 2) Insert two, new “AAA” alkaline batteries according to the polarity indicators (+ and -) in the battery compartment (Fig. 14). Be sure that the polarity is correct!

Fig. 14



3) Close the cover and lock it securely in place.

Turn On the Remote Control

The remote control and the Green Auto Leveling Rotary Laser Level have a duplex communication. To operate the remote control, press the  button to turn it on; the display on the remote control will synchronize the display on the Green Auto Leveling Rotary Laser Level

NOTE: If the control distance exceeds the maximum range, or if the Green Auto Leveling Rotary Laser Level is powered off when the remote control is turned on, “Link Lost” will appear in remote control display.

Put the Green Auto Leveling Rotary Laser Level in Sleep Mode

Press the  button on the remote control again to turn off the remote control; it will place the level in sleep mode. The “Sleep” will display on the Rotary Laser Level and the display backlights will flash once every two seconds to remind you that you can “wake” the level with the remote control within two hours. After two hours in “sleep” mode, the level will automatically shut off completely, and the remote control cannot operate the level. If the remote control is not operated in 5 minutes, the remote control will turn off automatically.

Wake Up the Green Auto Leveling Rotary Laser Level

To wake up the Green Auto Leveling Rotary Laser Level, press the  button on the remote control; it will activate the level and turn on the remote control.

Green Laser Detector

Description (Fig. 15 & Fig. 16)

Perfect for use in outdoor conditions, where sunlight and distance may make locating the beam more difficult, the green laser detector aids in locating and targeting a visible or invisible beam emitted by the Green Auto Leveling Rotary Laser Level within a maximum range of 330 feet, It cannot detect a red-laser line.



1. Beam receiver window: receives the green laser signals.
2. LCD: indicates the detection result and the position of the laser line.
3. Power ON/OFF button: turns the detector on/off.

4. Buzzer ON/OFF button: turns the buzzer on/off.
5. Coarse/Fine detection button: coarsely detects the laser position or accurately detects the laser position.
6. Lineation arrow: helps in marking a target line.
7. Lineation slot: helps in marking a target line
8. Distance indicator: shows that the lineation slot is 2 inches (50mm) to the top of the detector.
9. 1/4' Mounting hole: for installation on the mounting base.
10. Battery compartment: for holding a "6LR61" 9V battery

To Change/Install Battery for the Detector

1. Open the battery compartment cover.
2. Install one "6LR61" 9V battery (Fig. 17). Make sure the polarity (+/-) is correct!
3. Close the battery compartment cover.

Fig. 17



Locating the Green Laser Line with the Detector

NOTE: Always keep the instrument stable and level when detecting.

1. Press the  button to turn the detector on. The LCD symbols will

momentarily flash and the “coarse” indicator symbol will remain lit and the audio signal will be on (Fig. 18a).

2. Expose the beam receive window of the laser detector towards the direction of the rotating laser.
3. Slowly move the laser detector in an upward and downward direction until the LCD beam indicator arrows appear and/or a pulsing audio signal is heard.

Use the coarse/fine detection button  to choose the beam resolution.

- Coarse setting: used for approximating level or for initial location of the center level point (Fig. 18a)
- Medium setting: used for greater accuracy (Fig. 18b)
- Fine setting: used for the most accurate pinpointing of level (Fig. 18c).

Fig. 18a



Fig. 18b



Fig. 18c

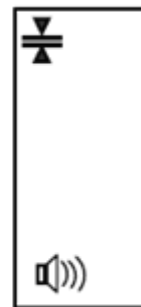

4. Move the detector upward when the low beam indicator arrow is lit (Fig. 19a). Move the detector downward when the high beam indicator arrow is lit (Fig. 19b). When the beam is level, the level beam indicator line will be lit and a solid audio tone will be heard (Fig. 19c).

5. Mark this position with a pencil through either side of the lineation slot.

If the detector is not struck by a laser beam after 3-4 minutes, the detector will automatically shut itself off to preserve battery life. Turn it back on using the power ON/OFF button.

Fig. 19a



Fig. 19b



Fig. 19c



Detector Mounting Base

Description

Fig. 20

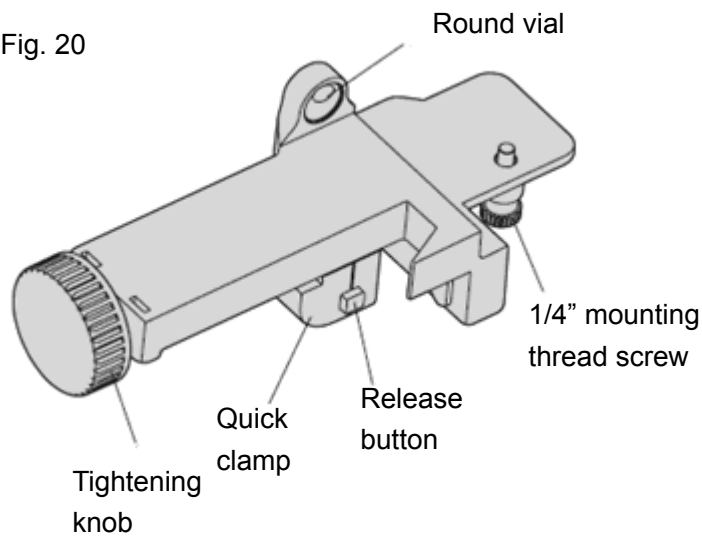

1. Tightening knob: to securely attach the detector to a vertical pillar.
2. Release button: located on the both sides of the quick clamp. Push the buttons to slide the quick clamp.
3. Quick clamp: slide to quickly clamp or unclamp.

4. 1/4" mounting thread screw: Used to mount the detector.
5. Round vial: indicates whether the base is vertical and level.

Using the Detector Mounting Base

With the detector mounting base, the detector can be secured to a vertical pillar with flat sides at 90° angles.. The maximum width the base can accommodate is 3.7".

1. Inert the 1/4" mounting thread screw into the 1/4" mounting hole at the back of the detector; tighten the screw to securely attach the detector (Fig. 21).

Fig. 21

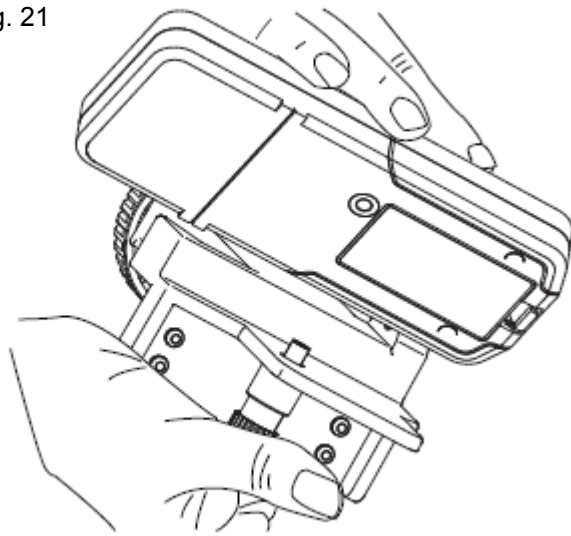

2. Press the two release buttons at the same time to slide the quick clamp and fit it onto the vertical pillar (Fig. 22)

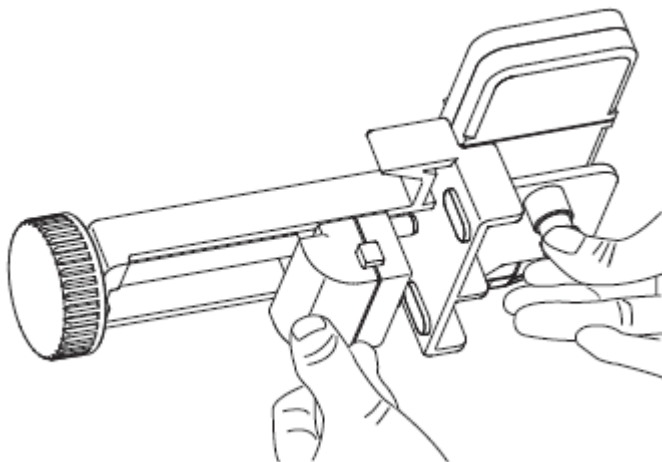

Wall mounting base

Description (Fig. 23)

Fig. 23



1. Trough with 1/2" width and 1-1/8" depth - Attaches the wall-mounting base to horizontal studs in a wall.
2. Lock screw - Secures the wall-mounting base to the stud.
3. Mounting hole - Used for hanging the wall-mounting base from a nail or screw on a wall.
4. Pole with Inch scale: Refer to The scales when adjusting the platform up and down.
5. Securing screw- Secures the platform to the pole.
6. Platform pivots – For easy storage of the wall mounting-base assembly.
7. Platform – Supports the Green Auto Leveling Rotary Laser Level.

8. 5/8" mounting thread screw – Attaches the Green Auto Leveling Rotary Laser Level to the base.
9. Balance screw – Adjusts the balance of the base.

Using the Wall Mounting Base

The wall mounting base can be hung from nails or screws on a wall or clamped onto a beam. By using the wall mounting base, you can easily adjust the height and direction of the laser to your reference object.

Hang from Nails or Screws:

The base has three mounting holes for secure attachment. Always use three screws or nails, and make sure that these screws or nails are securely in place in the wall.

Clamp onto a Horizontal Stud

The base can only be attached to a level, horizontal stud; **do not try to attach to a vertical stud.**

1. Turn the two lock screws counterclockwise (Fig. 24). Attach the wall mounting base to a level stud, making sure that the stud is fully inserted into the trough.

Fig. 24

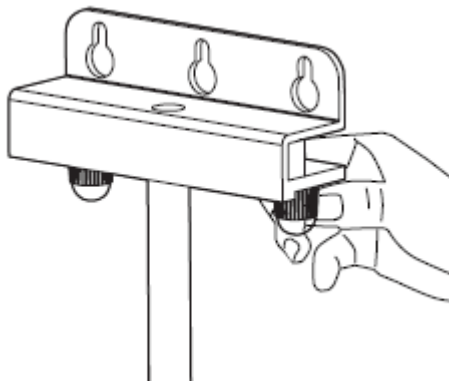

2. Turn the two lock screws clockwise to secure the clamp.
3. Adjust the balance screw until the rubber support touches the wall. Ensure that the platform is approximately level (Fig. 25).

Fig. 25

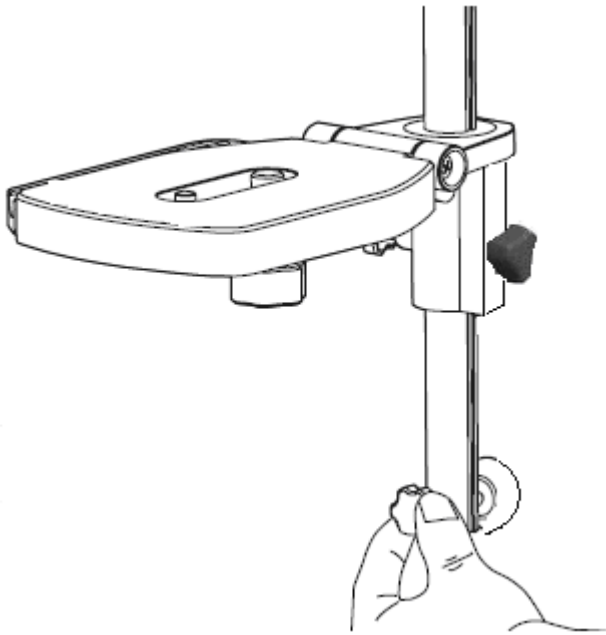

Mount the Green Auto Leveling Rotary Laser Level on the Wall Mounting Base

1. Align the 5/8" screw on the platform with the screw hole in the bottom base or side base of the tool.
2. Adjust the direction of the tool to your reference object.
3. Turn the screw clockwise to secure the tool on the base.

CAUTION! Whenever using the wall mounting base to secure the Green Auto Leveling Rotary Laser Level on a stud, be sure to place the tool on the base carefully, securing it with your hands at all times. Once you are certain that the tool is attached firmly on the base with the screw, and the base is fastened on the stud, you can safely remove your hands.

Adjust the Height of the Green Auto Leveling Rotary Laser Level

1. Support the base of the platform with one hand to hold the tool.
2. Turn the securing screw counterclockwise to loosen it.
3. Adjust the height of the platform to the desired position. The platform height is adjustable up to 11 inches.
4. Tighten the secure screw clockwise to fix the platform firmly.

Surveyor's tripod

Description (Fig. 26)

Fig. 26

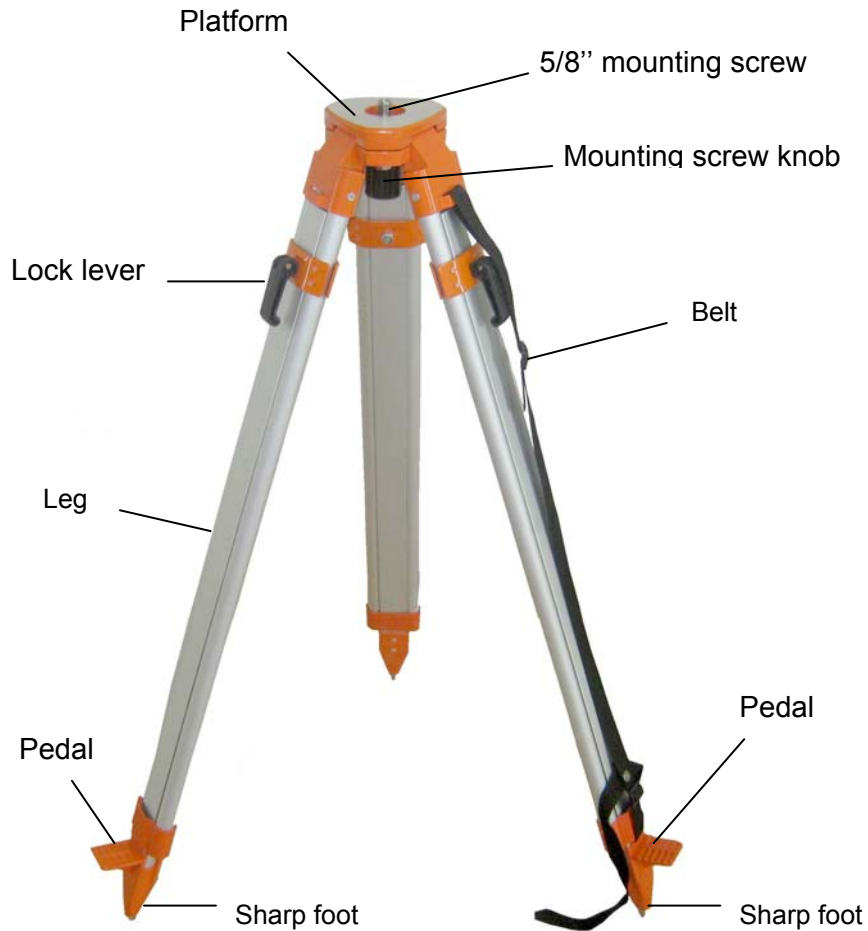

1. 5/8" mounting screw – attaches the Green Auto Leveling Rotary Laser Level to the tripod
2. Platform- supports the Green Auto Leveling Rotary Laser Level.
3. Lock lever- locks/unlocks the extension of the leg.
4. Belt- for convenient carrying or securing when not in use.
5. Leg- provides firm support.
6. Sharp foot- for stably stand in the working field
7. Pedal- step in the pedals to push the sharp feet into the ground.

Using the Surveyor's tripod

1. Expand the three legs of the tripod to a stable position; make sure the platform is close to horizontal.
2. Step on the pedals to push the sharp feet into the ground.
3. Place the Green Auto Leveling Rotary Laser Level on the tripod; holding it in place with your hand, adjust the direction of the tool to your reference object.
4. While holding the Green Auto Leveling Rotary Laser Level in place with your hand, align the 5/8" mounting screw in the platform with the screw hole in the bottom base or side base of the tool.
5. Continuing to hold the Green Auto Leveling Rotary Laser Level in place with your hand, turn the knob of the mounting screw clockwise to secure the Green Auto Leveling Rotary Laser Level the tripod platform.
6. Open the three lock levers to unlock the leg extension, adjust the height of the tripod to your reference.
7. Close the lock levers to lock the leg extension securely. Now you are ready to start the work.

Leveling rod

This leveling rod can be extended to a maximum of 8 feet. When not in use, it can be retracted to a length of 3 feet and 2 3/8 inches for storage.

Scales are printed on both surfaces: on one surface, the scales are in increments of 0.25-inch; on the reverse surface, the scales are in increments of 0.24 inch.

To extend the leveling rod, pull the components up.; to retract the, locate and press each release button (Fig. 27) to unlock the extension and permit the rod to be retracted.

Fig. 27

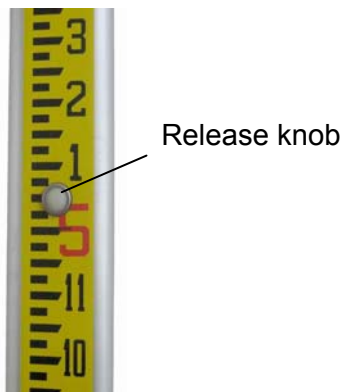

DANGER: DO NOT OPERATE the leveling rod during storms or near high voltage, leveling rod falling or touching to the high voltage will result in serious electric shock and/or bodily injury.

APPLICATION

Your Green Auto Leveling Rotary Laser Level is a highly versatile tool. Use it for the following applications, among others:

Outdoor Site Preparation, Grading & Excavating, Batter boards and Foundations, Masonry Work, Setting Concrete Forms, Marking elevation, Paving Roads, Checking Depth of Trenches, Landscaping, Fencing.

Indoor Drop Ceiling Installation, Floors, cabinets & Shelves, Carpentry, Decks & Patios, Tile Work, Partitions, Remodeling, Doors & Windows.

Mark the Height for Foundation Pit

1. Attach the Green Auto Leveling Rotary Laser Level to the surveyor's tripod, allow the level to self-level.
2. Use the Detector and Leveling Rod to read the height of the level based on the height datum.
3. Calculate the height difference of the level to the specified position. Set the leveling rod and mark it according to the calculation (Fig. 28).

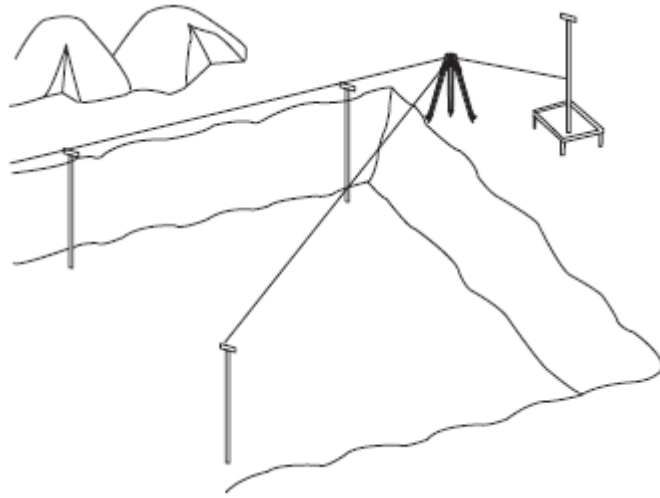

Drop Ceiling Applications

1. Attach the wall mounting base to the wall with screws or nails or clamp onto a horizontal stud. make sure the hanging trough of the base approximate to the level of ceiling grid.
2. Secure the Green Auto Leveling Rotary Laser Level on the wall mounting base; adjust the balance screw to ensure that the platform is approximately level.
3. Turn on the level; allow the laser to self-level.
4. Raise or lower the laser on the Wall Mounting Base until the rotating beam is at the same level as the perimeter ceiling grid. Use the line created by the laser as a reference to attach the perimeter grid to the wall.
5. Attach the magnetic laser target to the ceiling trim being installed. Adjust the height of the trim until the laser beam strikes the target, as Fig. 29 shown.

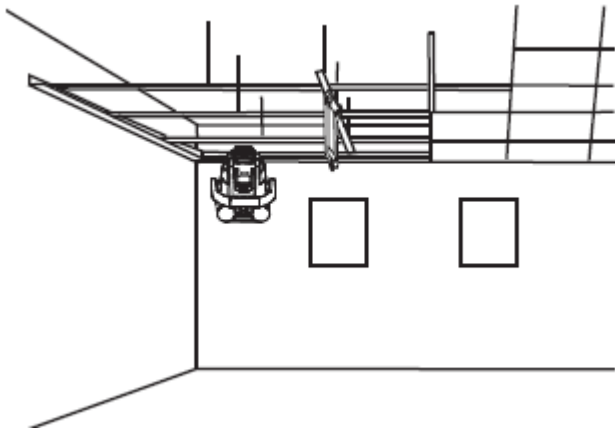

MAINTENANCE

This Green Auto Leveling Rotary Laser Level has been designed to be a low-maintenance tool.

However, in order to maintain its performance, you must always follow these simple directions.

- Always handle the level with care. Treat it as the fine optical device it is and as you would treat a camera or binoculars.
- Avoid exposing the level to shock, continuous vibration, or extreme hot or cold temperatures.
- Always store the level indoors. When not in use, always store the tool in its protective case.
- After you have finished using the level, always make sure that the level has been turned off.
- Always keep the level free of dust and liquids. If needed, only use a soft cloth or cotton swab and glass cleaner to clean the laser emitting window.
- Always wipe clean and thoroughly dry the level after each use.
- Check the batteries regularly to avoid deterioration.
- Always remove the batteries from the level, remote control and detector if they are not going to be used for an extended period of time.
- Always replace the batteries when the battery icon shows empty.

- Do not disassemble this green rotary laser level. This will not only void the warranty, but could expose the user to hazardous radiation exposure.
- Do not attempt to change any part of the laser lens.
- Tool service must be performed only by an authorized service center. Service or maintenance performed by unqualified personnel could result in risk of injury.

CHECKING ACCURACY AND CALIBRATION

This Green Auto Leveling Rotary Laser Level is a sealed level and is calibrated to precise accuracies at the factory. However, a calibration check is recommended before the initial use of your laser, and then periodically from that point forward. Be sure to allow enough time (up to 60 seconds) for the level to completely self-level before each check.

CAUTION: When performing a calibration, always use the remote control to adjust the level, pressing buttons on the level will bring small movements to the accurate electronic vials inside and result in incorrect calibration.

Checking Accuracy -X Axis

1. Mount the Green Auto Leveling Rotary Laser Level on a tripod or to a level, sturdy surface and place it approximately 100 feet (30m) away from a wall. Face the display toward you and “X+” to the target wall (Fig. 30 and Fig. 31).

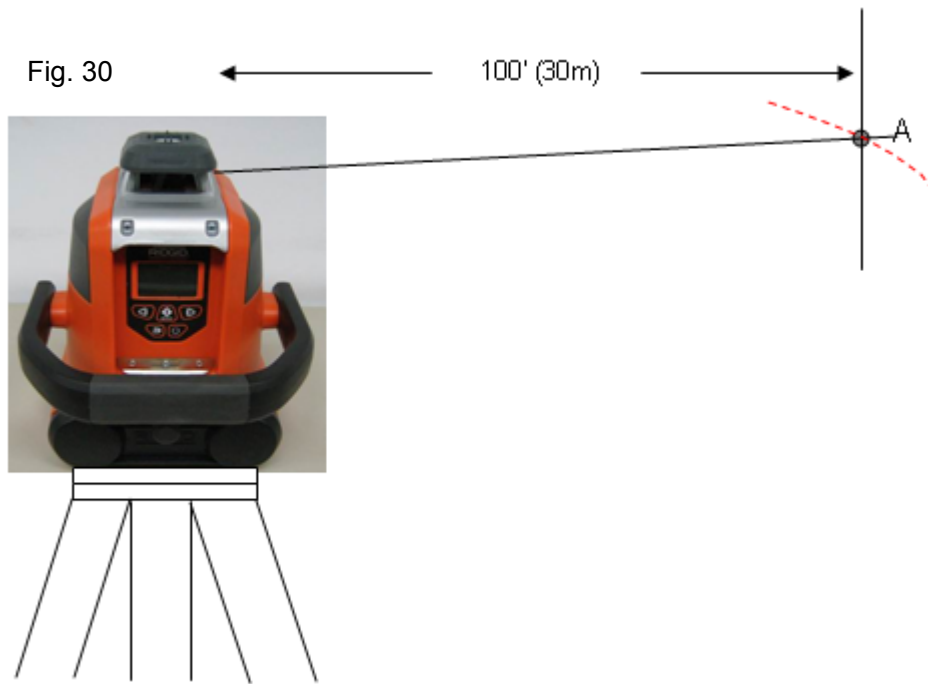

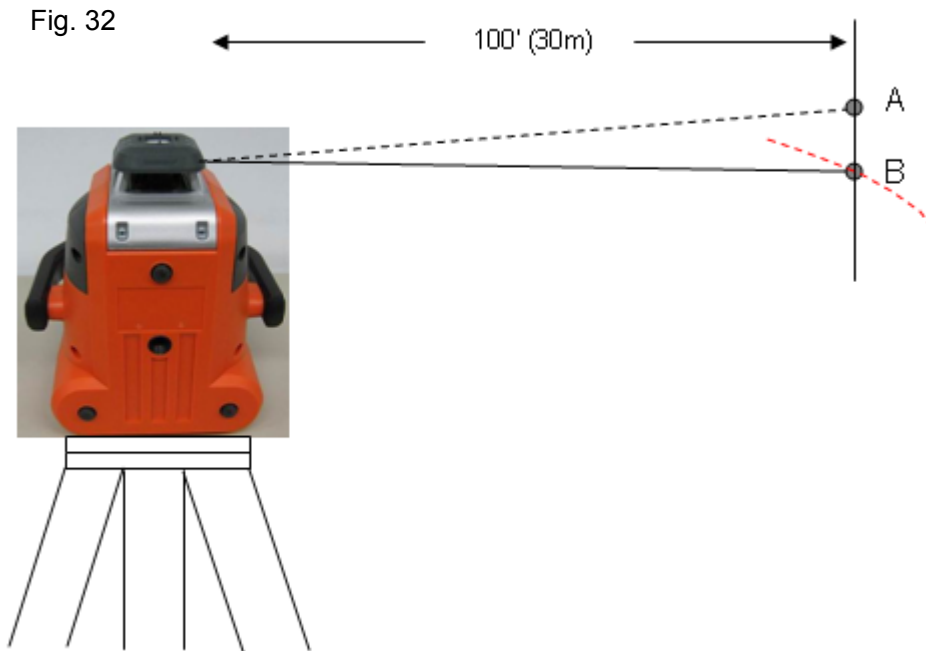

Fig. 31



2. Press the  button to turn on the Green Auto Leveling Rotary Laser Level and allow the tool to self-level. Draw a plumb line on the wall; mark the intersection of the plumb line and the laser beam as "A".
3. Loosen the Green Auto Leveling Rotary Laser Level from the tripod and rotate the Green Auto Leveling Rotary Laser Level 180°. Ensure that the height of the tripod does not change, as this will affect the results. Secure the Green Auto Leveling Rotary Laser (Fig. 32).



4. Allow the tool to self-level. Mark the intersection of the plumb line and the laser beam as “B”. No adjustment is necessary if the vertical difference between A and B is less than 1/4” (6.5mm)

Repeat the above steps to ensure a correct reading. If the distance is greater than 1/4”, you will need to calibrate the X axis.

Calibration- X Axis





1. Keeping the Green Auto Leveling Rotary Laser Level in its current position, turn the power off; turn the display toward you, and make X+ facing the target (i.e. wall, detector), as shown in Fig. 30 and Fig. 31..
2. Turn on the level and remote control, press the “” and “” button at the same time to activate calibration mode.(Fig. 33a)

Fig. 33a



Fig. 33b



3. Use the  button to select "Xad" (Fig. 33b); press the  button to access the X axis for calibration (Fig. 33c).

WARNING: A wrong choice of other options may result in error. Press the back



button  to exit and re-choose the correct option.

Fig. 33c





4. You must raise or lower the beam to center it between points A and B on the target. The level will react to "+" and "-" input within the X+ quadrant.

If A is above B, press the  button on the remote control to move the laser beam downward.

If A is below B, press the  button on the remote control to move the laser beam upward.

NOTE: The parameters displayed on the display on the Green Auto Leveling Rotary Laser Level can be ignored when performing the adjustment.

6. Press  button to save the calibration; press the  button repeatedly to exit from calibration mode.

7. Now repeat the X axis check to insure that you have made the correct

calibration.

Checking Accuracy and Calibration- Y Axis

To check the Y axis, mount the Green Auto Leveling Rotary Laser Level I on a tripod and place it approximately 100 feet (30m) away from the wall, with the Y+ quadrant facing the wall (Fig. 31); follow steps 2 through 4 of “**Checking Accuracy -X Axis**”. Calibration as in “**Calibration- X Axis**”, choosing the “Yad” to calibrate and adjusting “+” and “-“input as necessary within the Y+ quadrant (Fig. 34a and Fig. 34b).

Fig. 34a



Fig. 34b



Checking Accuracy - Z Axis

1. To check the Z axis, place the Green Auto Leveling Rotary Laser Level on its back (display facing up), 100 feet (30m) from a wall on a flat, level surface (Fig. 35).
2. Hang a plumb line down the wall at least 8 feet long.
3. Press the  button to turn on the level, allow the Green Auto Leveling Rotary Laser Level I to self-level. If necessary, adjust the rotation speed to easily view the laser beam on the wall.
4. Orient the Green Auto Leveling Rotary Laser Level parallel to the wall and attempt to align the laser with your plumb line. If the laser line does not align with the plumb line, then calibration is necessary.

Fig. 35



Calibration-Z Axis

Keep the Green Auto Leveling Rotary Laser Level in the current position, power off the level.

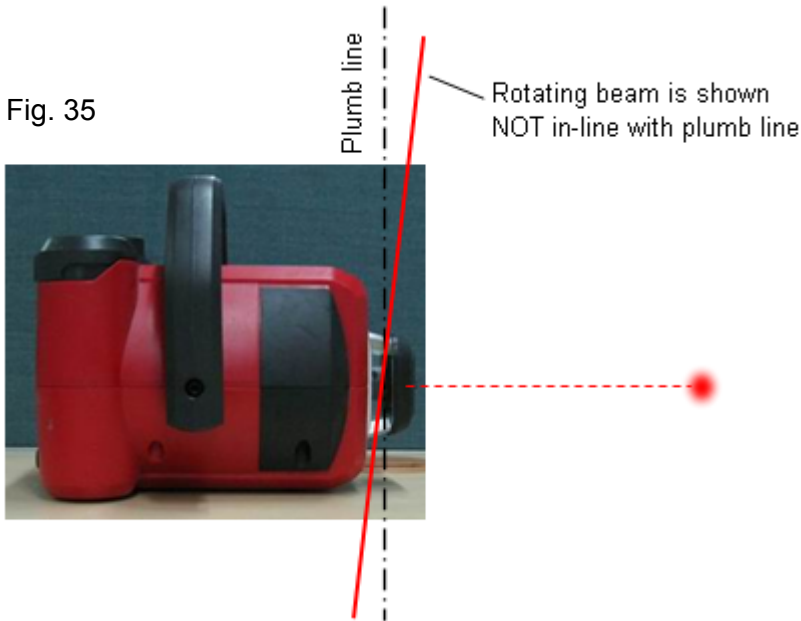





1. Turn on the level and the remote control;. Press the  and  button on the remote control at the same time to enter calibration mode (Fig. 33a).
2. Use  button to select "Zad" (Fig. 36a); press the  button to access the Z axis for calibration (Fig. 36b).

Fig. 36a





Fig. 36b



3. Press the  button on the remote control to rotate the laser beam counterclockwise, or press the  button on the remote control to rotate the laser beam clockwise into alignment with your plumb line. For example,

the laser beam must rotate counterclockwise to align with the plumb line, so

you need to press the  button.

4. Press the  button to save the calibration, press  button repeatedly to exit from calibration mode.
5. Now repeat the Z axis checking to insure you have made the correct calibration.

TROUBLESHOOTING

PROBLEM	POSSIBLE CAUTION	SOLUTION
Laser dot/line projected is weak, hard to see	<ol style="list-style-type: none"> 1. Battery is depleted. 2. The tool is out of the operating temperature range. 3. The tool is too far from the target. 4. Working condition is too bright. 	<ol style="list-style-type: none"> 1. Replace with new batteries or run it with AC/DC adapter. 2. Make sure that the tool operating temperature is within 32°F to 104°F. 3. Move the tool closer to the target. 4. Use green laser-enhancing glasses and green-laser detector to locate the laser position.
Laser dot/line is not projected	<ol style="list-style-type: none"> 1. The tool is put in sleep mode. 2. The tool is performing leveling adjustment automatically. 3. The tool suffers a sudden shock 4. The tool is out of the operating temperature range. 	<ol style="list-style-type: none"> 1. Wake up the tool with the remote control or turn off and on again. 2. Wait until the Auto leveling adjustment is finished. 3. Wait until the tool re-levels automatically. 4. Make sure the tool operating temperature is within 32°F to 104°F.

<p>The rotary laser stops spinning and the laser dot winks</p>	<ol style="list-style-type: none"> 1. The tool is out of leveling range. 2. The slope setting in slope mode is out of the adjustable range of the tool. 3. The tool is set ADS in Auto Level mode and suffers a sudden shock in working. 	<ol style="list-style-type: none"> 1. Adjust to make sure the support for the tool is close to horizontal. 2. Adjust to make sure the support for the tool is close to horizontal or reduce the slope setting. 3. Change the Auto Level mode to OFF first, recheck the reference and set to ADS again.
<p>Laser dot/line projected is not level</p>	<ol style="list-style-type: none"> 1. The tool is in slope mode. 2. The tool is set to OFF in Auto Level mode; it will NOT re-level if the tool was moved. 	<ol style="list-style-type: none"> 1. Press the Return button to go back to the rotation mode; the tool will re-level. 2. Set the tool to ON in Auto Level Mode, it will re-level.
<p>Detector cannot find the laser</p>	<ol style="list-style-type: none"> 1. It detects a red laser line. 2. the detector is out of its working range 3. Battery is depleted. 	<ol style="list-style-type: none"> 1. This detector can only detect green pulse laser. 2. Make sure the distance between tool and detector does not exceed 330 feet. 3. Replace with a new battery.
<p>The remote control cannot operate the tool, and LCD shows "LINK LOST"</p>	<ol style="list-style-type: none"> 1. The tool is shut off 2. The remote control is out of its working range 	<ol style="list-style-type: none"> 1. Press the ON/OFF button to turn on the tool first, then turn on the remote control to operate it. 2. Make sure the distance between tool and remote control does not exceed 133 feet.
<p>The tool emits continuous sound inside.</p>	<p>The adjusting mechanical inside is working automatically.</p>	<p>This is normal.</p>