



## Shenzhen Huaxia Testing Technology Co., Ltd.

1F., Block A of Tongsheng Technology Building, Huahui Road, Dalang Street, Longhua District, Shenzhen, China

Telephone: +86-755-26648640  
Fax: +86-755-26648637  
Website: [www.cqa-cert.com](http://www.cqa-cert.com)

Report Template Version: V05  
Report Template Revision Date: 2021-11-03

# Test Report

**Report No. :** CQASZ20220801354E-01  
**Applicant:** Chervon(China)Trading Co., Ltd  
**Address of Applicant:** No.99 Tianyuan West Road, Jiangning Economic & Technical Development Zone, nanjing, jiangsu, China

**Equipment Under Test (EUT):**

**Product:** Portable Hybrid Radio & Bluetooth Speaker  
**Model No.:** C1004, KJR1040-03  
**Test Model No.:** KJR1040-03  
**Brand Name:** KOBALT  
**FCC ID:** YWKKJR1040-03  
**Standards:** 47 CFR Part 15, Subpart C  
**Date of Receipt:** 2022-08-08  
**Date of Test:** 2022-08-08 to 2022-08-18  
**Date of Issue:** 2022-10-17  
**Test Result :** **PASS\***

\*In the configuration tested, the EUT complied with the standards specified above.

**Tested By:** Lewis Zhou  
( Lewis Zhou )

**Reviewed By:** Timo Lei  
( Timo Lei )

**Approved By:** Jack Ai  
( Jack Ai )



## 1 Version

### Revision History Of Report

Report No.	Version	Description	Issue Date
CQASZ20220801354E-01	Rev.01	Initial report	2022-10-17

## 2 Test Summary

Test Item	Test Requirement	Test method	Result
Antenna Requirement	47 CFR Part 15, Subpart C Section 15.203/15.247 (c)	ANSI C63.10 (2013)	PASS
AC Power Line Conducted Emission	47 CFR Part 15, Subpart C Section 15.207	ANSI C63.10 (2013)	PASS
Conducted Peak Output Power	47 CFR Part 15, Subpart C Section 15.247 (b)(1)	ANSI C63.10 (2013)	PASS
20dB Occupied Bandwidth	47 CFR Part 15, Subpart C Section 15.247 (a)(1)	ANSI C63.10 (2013)	PASS
Carrier Frequencies Separation	47 CFR Part 15, Subpart C Section 15.247 (a)(1)	ANSI C63.10 (2013)	PASS
Hopping Channel Number	47 CFR Part 15, Subpart C Section 15.247 (a)(1)	ANSI C63.10 (2013)	PASS
Dwell Time	47 CFR Part 15, Subpart C Section 15.247 (a)(1)	ANSI C63.10 (2013)	PASS
Pseudorandom Frequency Hopping Sequence	47 CFR Part 15, Subpart C Section 15.247(b)(4)	ANSI C63.10 (2013)	PASS
Band-edge for RF Conducted Emissions	47 CFR Part 15, Subpart C Section 15.247(d)	ANSI C63.10 (2013)	PASS
RF Conducted Spurious Emissions	47 CFR Part 15, Subpart C Section 15.247(d)	ANSI C63.10 (2013)	PASS
Radiated Spurious emissions	47 CFR Part 15, Subpart C Section 15.205/15.209	ANSI C63.10 (2013)	PASS
Restricted bands around fundamental frequency (Radiated Emission)	47 CFR Part 15, Subpart C Section 15.205/15.209	ANSI C63.10 (2013)	PASS

### 3 Contents

	Page
<b>1 VERSION .....</b>	<b>2</b>
<b>2 TEST SUMMARY .....</b>	<b>3</b>
<b>3 CONTENTS .....</b>	<b>4</b>
<b>4 GENERAL INFORMATION .....</b>	<b>5</b>
4.1 CLIENT INFORMATION .....	5
4.2 GENERAL DESCRIPTION OF EUT .....	5
4.3 ADDITIONAL INSTRUCTIONS .....	7
4.4 TEST ENVIRONMENT .....	8
4.5 DESCRIPTION OF SUPPORT UNITS .....	8
4.6 STATEMENT OF THE MEASUREMENT UNCERTAINTY .....	9
4.7 TEST LOCATION .....	10
4.8 TEST FACILITY .....	10
4.9 ABNORMALITIES FROM STANDARD CONDITIONS .....	10
4.10 OTHER INFORMATION REQUESTED BY THE CUSTOMER .....	10
4.11 EQUIPMENT LIST .....	11
<b>5 TEST RESULTS AND MEASUREMENT DATA .....</b>	<b>12</b>
5.1 ANTENNA REQUIREMENT .....	12
5.2 CONDUCTED EMISSIONS .....	13
5.3 CONDUCTED PEAK OUTPUT POWER .....	17
5.4 20dB OCCUPY BANDWIDTH .....	24
5.5 CARRIER FREQUENCIES SEPARATION .....	30
5.6 HOPPING CHANNEL NUMBER .....	34
5.7 DWELL TIME .....	37
5.8 BAND-EDGE FOR RF CONDUCTED EMISSIONS .....	48
5.9 SPURIOUS RF CONDUCTED EMISSIONS .....	56
5.10 OTHER REQUIREMENTS FREQUENCY HOPPING SPREAD SPECTRUM SYSTEM .....	71
5.11 RADIATED SPURIOUS EMISSION & RESTRICTED BANDS .....	73
5.11.1 Radiated Emission below 1GHz .....	76
5.11.2 Transmitter Emission above 1GHz .....	78
<b>6 PHOTOGRAPHS - EUT TEST SETUP .....</b>	<b>81</b>
6.1 RADIATED EMISSION .....	81
6.2 CONDUCTED EMISSION .....	82
<b>7 PHOTOGRAPHS - EUT CONSTRUCTIONAL DETAILS .....</b>	<b>83</b>

## 4 General Information

### 4.1 Client Information

Applicant:	Chervon(China)Trading Co., Ltd
Address of Applicant:	No.99 Tianyuan West Road, Jiangning Economic & Technical Development Zone, nanjing, jiangsu, China
Manufacturer:	Chervon(China)Trading Co., Ltd
Address of Manufacturer:	No.99 Tianyuan West Road, Jiangning Economic & Technical Development Zone, nanjing, jiangsu, China
Factory:	Chervon(China)Trading Co., Ltd
Address of Factory:	No.99 Tianyuan West Road, Jiangning Economic & Technical Development Zone, nanjing, jiangsu, China

### 4.2 General Description of EUT

Product Name:	Portable Hybrid Radio & Bluetooth Speaker
Model No.:	C1004, KJR1040-03
Test Model No.:	KJR1040-03
Trade Mark:	KOBALT
Software Version:	1.0
Hardware Version:	20220620
Operation Frequency:	2402MHz~2480MHz
Bluetooth Version:	V5.0
Modulation Technique:	Frequency Hopping Spread Spectrum(FHSS)
Modulation Type:	GFSK, $\pi/4$ DQPSK, 8DPSK
Transfer Rate:	1Mbps/2Mbps/3Mbps
Number of Channel:	79
Hopping Channel Type:	Adaptive Frequency Hopping systems
Product Type:	<input type="checkbox"/> Mobile <input checked="" type="checkbox"/> Portable <input type="checkbox"/> Fix Location
Test Software of EUT:	FrequencyTool_v0.3.2
Antenna Type:	PCB antenna
Antenna Gain:	0dBi
Power Supply:	Adapter Model:MX65W1-4001500U INPUT:100-240V~50-60Hz 2A OUTOUT:40V 1.5A

Operation Frequency each of channel							
Channel	Frequency	Channel	Frequency	Channel	Frequency	Channel	Frequency
0	2402MHz	20	2422MHz	40	2442MHz	60	2462MHz
1	2403MHz	21	2423MHz	41	2443MHz	61	2463MHz
2	2404MHz	22	2424MHz	42	2444MHz	62	2464MHz
3	2405MHz	23	2425MHz	43	2445MHz	63	2465MHz
4	2406MHz	24	2426MHz	44	2446MHz	64	2466MHz
5	2407MHz	25	2427MHz	45	2447MHz	65	2467MHz
6	2408MHz	26	2428MHz	46	2448MHz	66	2468MHz
7	2409MHz	27	2429MHz	47	2449MHz	67	2469MHz
8	2410MHz	28	2430MHz	48	2450MHz	68	2470MHz
9	2411MHz	29	2431MHz	49	2451MHz	69	2471MHz
10	2412MHz	30	2432MHz	50	2452MHz	70	2472MHz
11	2413MHz	31	2433MHz	51	2453MHz	71	2473MHz
12	2414MHz	32	2434MHz	52	2454MHz	72	2474MHz
13	2415MHz	33	2435MHz	53	2455MHz	73	2475MHz
14	2416MHz	34	2436MHz	54	2456MHz	74	2476MHz
15	2417MHz	35	2437MHz	55	2457MHz	75	2477MHz
16	2418MHz	36	2438MHz	56	2458MHz	76	2478MHz
17	2419MHz	37	2439MHz	57	2459MHz	77	2479MHz
18	2420MHz	38	2440MHz	58	2460MHz	78	2480MHz
19	2421MHz	39	2441MHz	59	2461MHz		

Note:

In section 15.31(m), regards to the operating frequency range over 10 MHz, the Lowest frequency, the middle frequency, and the highest frequency of channel were selected to perform the test, and the selected channel see below:

Channel	Frequency
The Lowest channel	2402MHz
The Middle channel	2441MHz
The Highest channel	2480MHz

### 4.3 Additional Instructions

EUT Test Software Settings:		
Mode:	<input checked="" type="checkbox"/> Special software is used. <input type="checkbox"/> Through engineering command into the engineering mode. engineering command: <b>###3646633###</b>	
EUT Power level:	Class2 (Power level is built-in set parameters and cannot be changed and selected)	
Use test software to set the lowest frequency, the middle frequency and the highest frequency keep transmitting of the EUT.		
Mode	Channel	Frequency(MHz)
DH1/DH3/DH5	CH0	2402
	CH39	2441
	CH78	2480
2DH1/2DH3/2DH5	CH0	2402
	CH39	2441
	CH78	2480
3DH1/3DH3/3DH5	CH0	2402
	CH39	2441
	CH78	2480

#### Run Software:

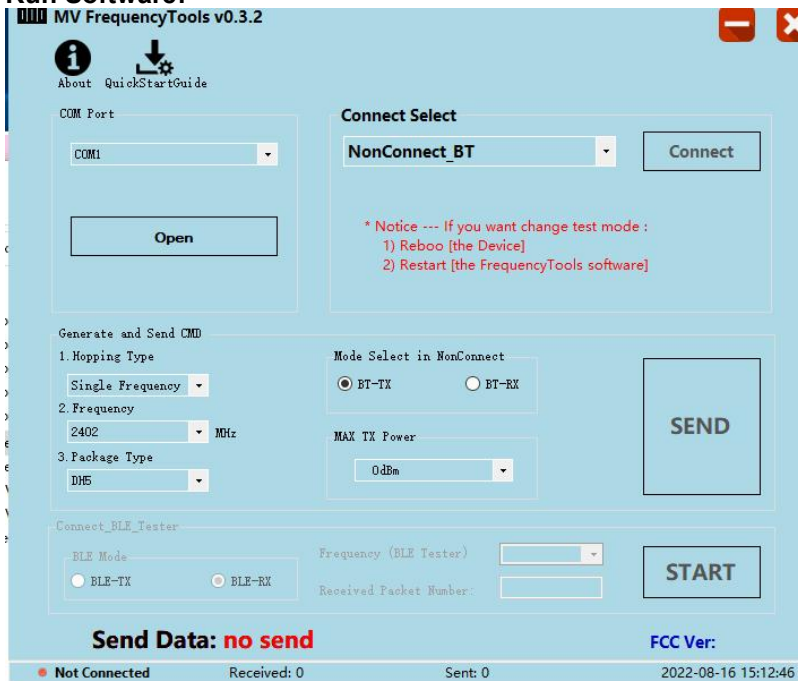

#### 4.4 Test Environment

Operating Environment:	
Temperature:	25 °C
Humidity:	54% RH
Atmospheric Pressure:	1009mbar
Test Mode:	Use test software to set the lowest frequency, the middle frequency and the highest frequency keep transmitting of the EUT.

#### 4.5 Description of Support Units

The EUT has been tested with associated equipment below.

Description	Manufacturer	Model No.	Remark	FCC certification
/	/	/	/	/



#### 4.6 Statement of the measurement uncertainty

The data and results referenced in this document are true and accurate.

The reader is cautioned that there may be errors within the calibration limits of the equipment and facilities.

The measurement uncertainty was calculated for all measurements listed in this test report acc. to CISPR 16 - 4 „Specification for radio disturbance and immunity measuring apparatus and methods – Part 4: Uncertainty in EMC Measurements“ and is documented in the **Shenzhen Huaxia Testing Technology Co., Ltd.** quality system acc. to DIN EN ISO/IEC 17025.

Furthermore, component and process variability of devices similar to that tested may result in additional deviation. The manufacturer has the sole responsibility of continued compliance of the device.

Hereafter the best measurement capability for CQA laboratory is reported:

No.	Item	Uncertainty
1	Radiated Emission (Below 1GHz)	5.12dB
2	Radiated Emission (Above 1GHz)	4.60dB
3	Conducted Disturbance (0.15~30MHz)	3.34dB
4	Radio Frequency	$3 \times 10^{-8}$
5	Duty cycle	0.6 %
6	Occupied Bandwidth	1.1%
7	RF conducted power	0.86dB
8	RF power density	0.74
9	Conducted Spurious emissions	0.86dB
10	Temperature test	0.8°C
11	Humidity test	2.0%
12	Supply voltages	0.5 %
13	Frequency Error	5.5 Hz

#### 4.7 Test Location

All tests were performed at:

Shenzhen Huaxia Testing Technology Co., Ltd.

1F., Block A of Tongsheng Technology Building, Huahui Road, Dalang Street, Longhua District, Shenzhen, China

#### 4.8 Test Facility

The test facility is recognized, certified, or accredited by the following organizations:

**IC Registration No.: 22984-1**

The 3m Semi-anechoic chamber of Shenzhen Huaxia Testing Technology Co., Ltd. has been registered by Certification and Engineering Bureau of Industry Canada for radio equipment testing

The test facility is recognized, certified, or accredited by the following organizations:

• **CNAS (No. CNAS L5785)**

CNAS has accredited Shenzhen Huaxia Testing Technology Co., Ltd. Shenzhen Branch EMC Lab to ISO/IEC 17025:2005 General Requirements for the Competence of Testing and Calibration Laboratories (CNAS-CL01 Accreditation Criteria for the Competence of Testing and Calibration Laboratories) for the competence in the field of testing.

• **A2LA (Certificate No. 4742.01)**

Shenzhen Huaxia Testing Technology Co., Ltd., Shenzhen EMC Laboratory is accredited by the American Association for Laboratory Accreditation(A2LA). Certificate No. 4742.01.

• **FCC Registration No.: 522263**

Shenzhen Huaxia Testing Technology Co., Ltd., Shenzhen EMC Laboratory has been registered and fully described in a report filed with the (FCC) Federal Communications Commission. The acceptance letter from the FCC is maintained in our files. Registration No.:522263

#### 4.9 Abnormalities from Standard Conditions

None.

#### 4.10 Other Information Requested by the Customer

None.

## 4.11 Equipment List

Test Equipment	Manufacturer	Model No.	Instrument No.	Calibration Date	Calibration Due Date
EMI Test Receiver	R&S	ESR7	CQA-005	2021/9/10	2022/9/9
Spectrum analyzer	R&S	FSU26	CQA-038	2021/9/10	2022/9/9
Preamplifier	MITEQ	AFS4-00010300-18-10P-4	CQA-035	2021/9/10	2022/9/9
Preamplifier	MITEQ	AMF-6D-02001800-29-20P	CQA-036	2021/9/10	2022/9/9
Loop antenna	Schwarzbeck	FMZB1516	CQA-087	2021/9/16	2024/9/15
Bilog Antenna	R&S	HL562	CQA-011	2021/9/16	2024/9/15
Horn Antenna	R&S	HF906	CQA-012	2021/9/16	2024/9/15
Horn Antenna	Schwarzbeck	BBHA 9170	CQA-088	2021/9/16	2024/9/15
Coaxial Cable (Above 1GHz)	CQA	N/A	C019	2021/9/10	2022/9/9
Coaxial Cable (Below 1GHz)	CQA	N/A	C020	2021/9/10	2022/9/9
Antenna Connector	CQA	RFC-01	CQA-080	2021/9/10	2022/9/9
RF cable(9KHz~40GHz)	CQA	RF-01	CQA-079	2021/9/10	2022/9/9
Power divider	MIDWEST	PWD-2533-02-SMA-79	CQA-067	2021/9/10	2022/9/9
EMI Test Receiver	R&S	ESPI3	CQA-013	2021/9/10	2022/9/9
LISN	R&S	ENV216	CQA-003	2021/9/10	2022/9/9
Coaxial cable	CQA	N/A	CQA-C009	2021/9/10	2022/9/9

Note:

The temporary antenna connector is soldered on the PCB board in order to perform conducted tests and this temporary antenna connector is listed in the equipment list.

## 5 Test results and Measurement Data

### 5.1 Antenna Requirement

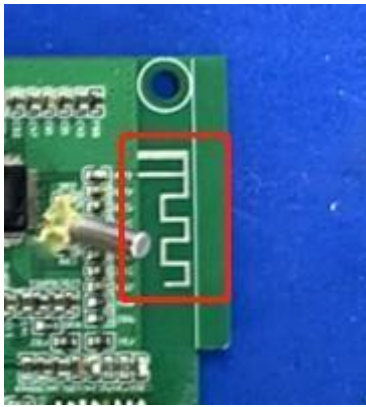
<b>Standard requirement:</b>	47 CFR Part 15C Section 15.203 /247(c)
<p>15.203 requirement:  An intentional radiator shall be designed to ensure that no antenna other than that furnished by the responsible party shall be used with the device. The use of a permanently attached antenna or of an antenna that uses a unique coupling to the intentional radiator, the manufacturer may design the unit so that a broken antenna can be replaced by the user, but the use of a standard antenna jack or electrical connector is prohibited.</p> <p>15.247(b) (4) requirement:  The conducted output power limit specified in paragraph (b) of this section is based on the use of antennas with directional gains that do not exceed 6 dBi. Except as shown in paragraph (c) of this section, if transmitting antennas of directional gain greater than 6 dBi are used, the conducted output power from the intentional radiator shall be reduced below the stated values in paragraphs (b)(1), (b)(2), and (b)(3) of this section, as appropriate, by the amount in dB that the directional gain of the antenna exceeds 6 dBi.</p>	
<b>EUT Antenna:</b>	
<p>The antenna is PCB antenna. The best case gain of the antenna is 0 dBi.</p>	

## 5.2 Conducted Emissions

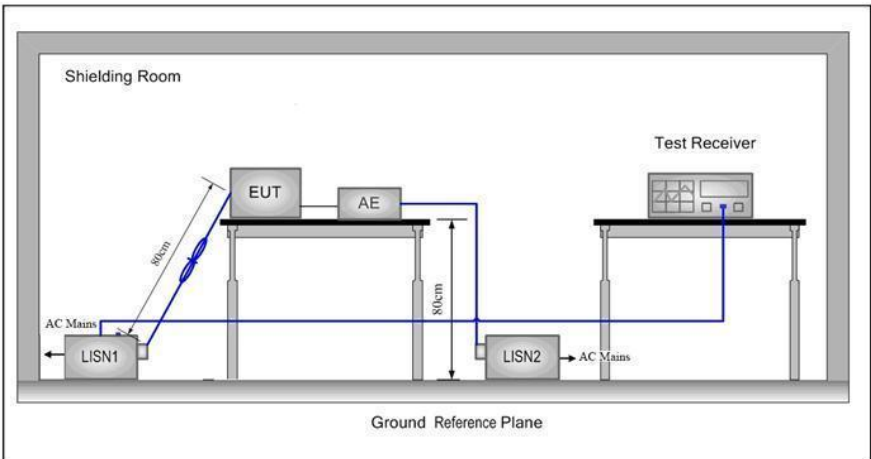
Test Requirement:	47 CFR Part 15C Section 15.207		
Test Method:	ANSI C63.10: 2013		
Test Frequency Range:	150kHz to 30MHz		
Limit:	Frequency range (MHz)	Limit (dBuV)	
		Quasi-peak	Average
	0.15-0.5	66 to 56*	56 to 46*
	0.5-5	56	46
	5-30	60	50
	* Decreases with the logarithm of the frequency.		
Test Procedure:	<ol style="list-style-type: none"> <li>1) The mains terminal disturbance voltage test was conducted in a shielded room.</li> <li>2) The EUT was connected to AC power source through a LISN 1 (Line Impedance Stabilization Network) which provides a <math>50\Omega/50\mu\text{H} + 5\Omega</math> linear impedance. The power cables of all other units of the EUT were connected to a second LISN 2, which was bonded to the ground reference plane in the same way as the LISN 1 for the unit being measured. A multiple socket outlet strip was used to connect multiple power cables to a single LISN provided the rating of the LISN was not exceeded.</li> <li>3) The tabletop EUT was placed upon a non-metallic table 0.8m above the ground reference plane. And for floor-standing arrangement, the EUT was placed on the horizontal ground reference plane,</li> <li>4) The test was performed with a vertical ground reference plane. The rear of the EUT shall be 0.4 m from the vertical ground reference plane. The vertical ground reference plane was bonded to the horizontal ground reference plane. The LISN 1 was placed 0.8 m from the boundary of the unit under test and bonded to a ground reference plane for LISNs mounted on top of the ground reference plane. This distance was between the closest points of the LISN 1 and the EUT. All other units of the EUT and associated equipment was at least 0.8 m from the LISN 2.</li> <li>5) In order to find the maximum emission, the relative positions of equipment and all of the interface cables must be changed according to ANSI C63.10: 2013 on conducted measurement.</li> </ol>		
Test Setup:			

---

Exploratory Test Mode:	Non-hopping transmitting mode with all kind of modulation and all kind of data type at the lowest, middle, high channel.
Final Test Mode:	Through Pre-scan, find the DH5 of data type and GFSK modulation at the lowest channel is the worst case. Only the worst case is recorded in the report.
Test Voltage:	AC 120V/60Hz
Test Results:	Pass

Measurement Data

Live line:

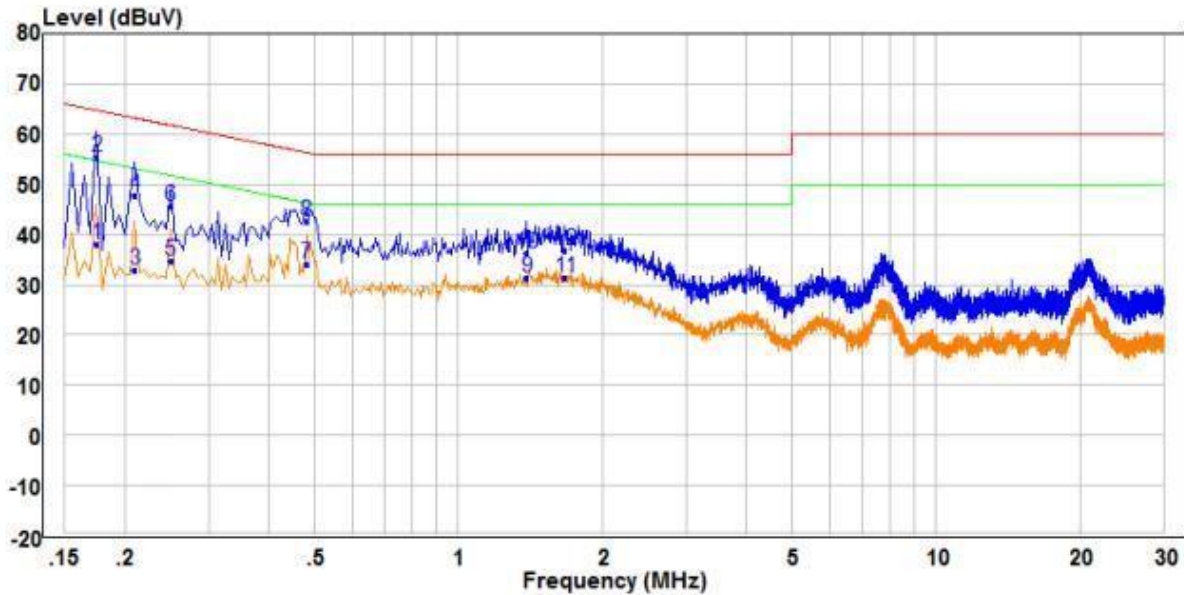

	Read Freq	Read Level	Factor	Level	Limit Line	Over Limit	Remark	Pol/Phase
	MHz	dBuV	dB	dBuV	dBuV	dB		
1	0.175	28.44	9.65	38.09	54.72	-16.63	Average	Line
2	PP	0.175	45.59	9.65	55.24	-9.48	QP	Line
3	0.210	23.18	9.60	32.78	53.21	-20.43	Average	Line
4	0.210	38.30	9.60	47.90	63.21	-15.31	QP	Line
5	0.250	25.28	9.55	34.83	51.76	-16.93	Average	Line
6	0.250	36.16	9.55	45.71	61.76	-16.05	QP	Line
7	AV	0.480	24.32	9.68	34.00	-12.34	Average	Line
8	0.480	32.94	9.68	42.62	56.34	-13.72	QP	Line
9	1.390	20.65	10.62	31.27	46.00	-14.73	Average	Line
10	1.390	25.68	10.62	36.30	56.00	-19.70	QP	Line
11	1.670	20.32	11.14	31.46	46.00	-14.54	Average	Line
12	1.670	25.76	11.14	36.90	56.00	-19.10	QP	Line

Remark:

1. The following Quasi-Peak and Average measurements were performed on the EUT:
2. Final Test Level = Receiver Reading + LISN Factor + Cable Loss.
3. If the Peak value under Average limit, the Average value is not recorded in the report.

Neutral line:

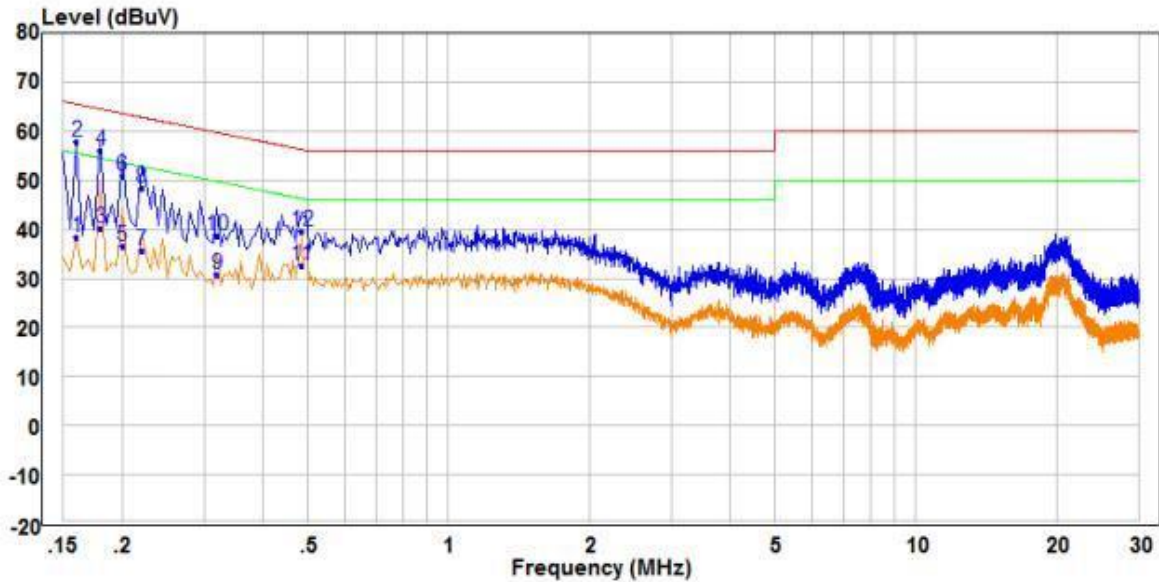

	Freq	Read Level	Factor	Level	Limit Line	Over Limit	Remark	Pol/Phase
	MHz	dBuV	dB	dBuV	dBuV	dB		
1	0.160	28.78	9.68	38.46	55.46	-17.00	Average	Neutral
2 PP	0.160	48.21	9.68	57.89	65.46	-7.57	QP	Neutral
3	0.180	30.61	9.64	40.25	54.49	-14.24	Average	Neutral
4	0.180	46.28	9.64	55.92	64.49	-8.57	QP	Neutral
5	0.200	27.04	9.61	36.65	53.61	-16.96	Average	Neutral
6	0.200	41.13	9.61	50.74	63.61	-12.87	QP	Neutral
7	0.220	25.93	9.58	35.51	52.82	-17.31	Average	Neutral
8	0.220	38.97	9.58	48.55	62.82	-14.27	QP	Neutral
9	0.320	21.35	9.51	30.86	49.71	-18.85	Average	Neutral
10	0.320	29.03	9.51	38.54	59.71	-21.17	QP	Neutral
11 AV	0.485	22.98	9.69	32.67	46.25	-13.58	Average	Neutral
12	0.485	29.92	9.69	39.61	56.25	-16.64	QP	Neutral

Remark:

1. The following Quasi-Peak and Average measurements were performed on the EUT:
2. Final Test Level = Receiver Reading + LISN Factor + Cable Loss.
3. If the Peak value under Average limit, the Average value is not recorded in the report.

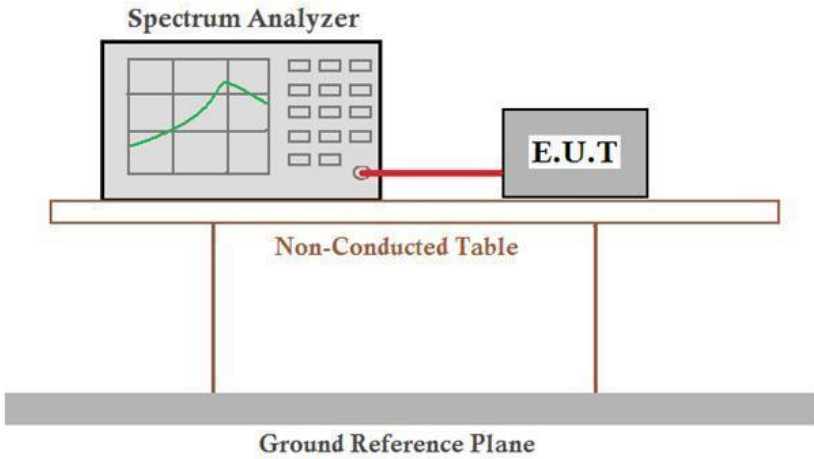

### 5.3 Conducted Peak Output Power

Test Requirement:	47 CFR Part 15C Section 15.247 (b)(1)
Test Method:	ANSI C63.10:2013
Test Setup:	 <p style="text-align: center;"><i>Remark: Offset=Cable loss+ attenuation factor.</i></p>
Limit:	21dBm
Exploratory Test Mode:	Non-hopping transmitting with all kind of modulation and all kind of data type
Final Test Mode:	Through Pre-scan, find the DH5 of data type is the worst case of GFSK modulation type, 2-DH5 of data type is the worst case of $\pi/4$ DQPSK modulation type, 3-DH5 of data type is the worst case of 8DPSK modulation type. Only the worst case is recorded in the report.
Test Results:	Pass

**Measurement Data**

GFSK mode			
Test channel	Peak Output Power (dBm)	Limit (dBm)	Result
Lowest	1.48	21.00	Pass
Middle	2.82	21.00	Pass
Highest	0.36	21.00	Pass
$\pi/4$ DQPSK mode			
Test channel	Peak Output Power (dBm)	Limit (dBm)	Result
Lowest	0.88	21.00	Pass
Middle	2.12	21.00	Pass
Highest	2.37	21.00	Pass
8DPSK mode			
Test channel	Peak Output Power (dBm)	Limit (dBm)	Result
Lowest	1.21	21.00	Pass
Middle	2.19	21.00	Pass
Highest	2.85	21.00	Pass

Test plot as follows:

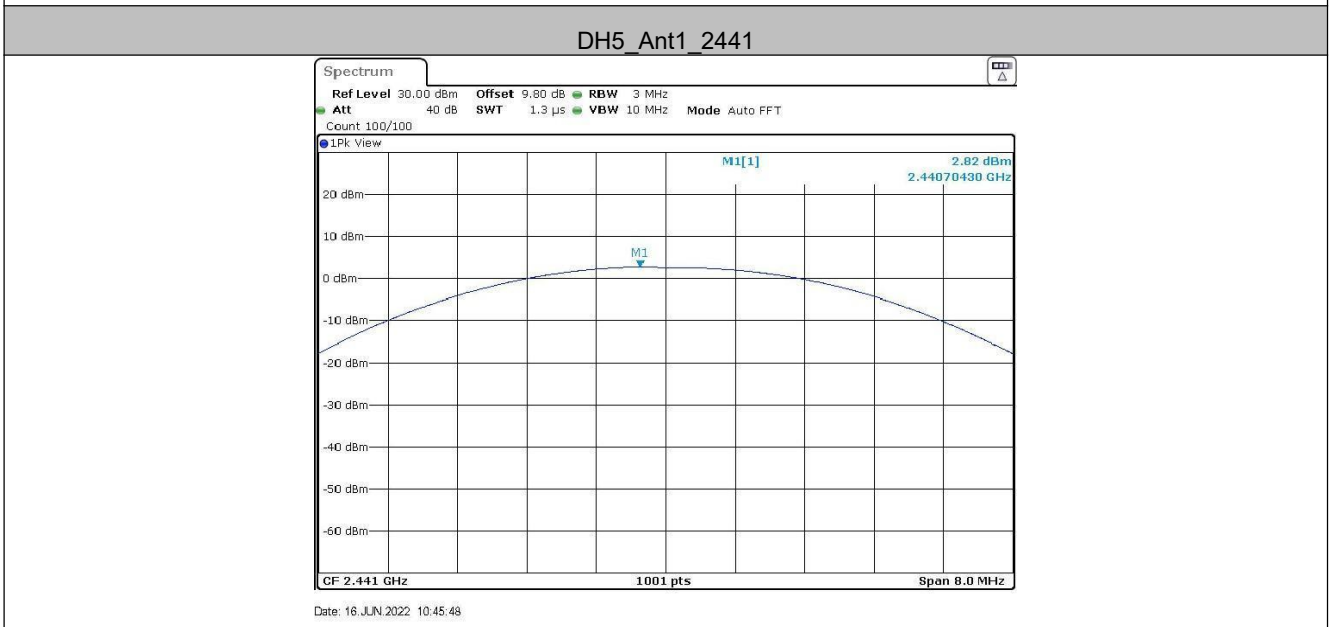
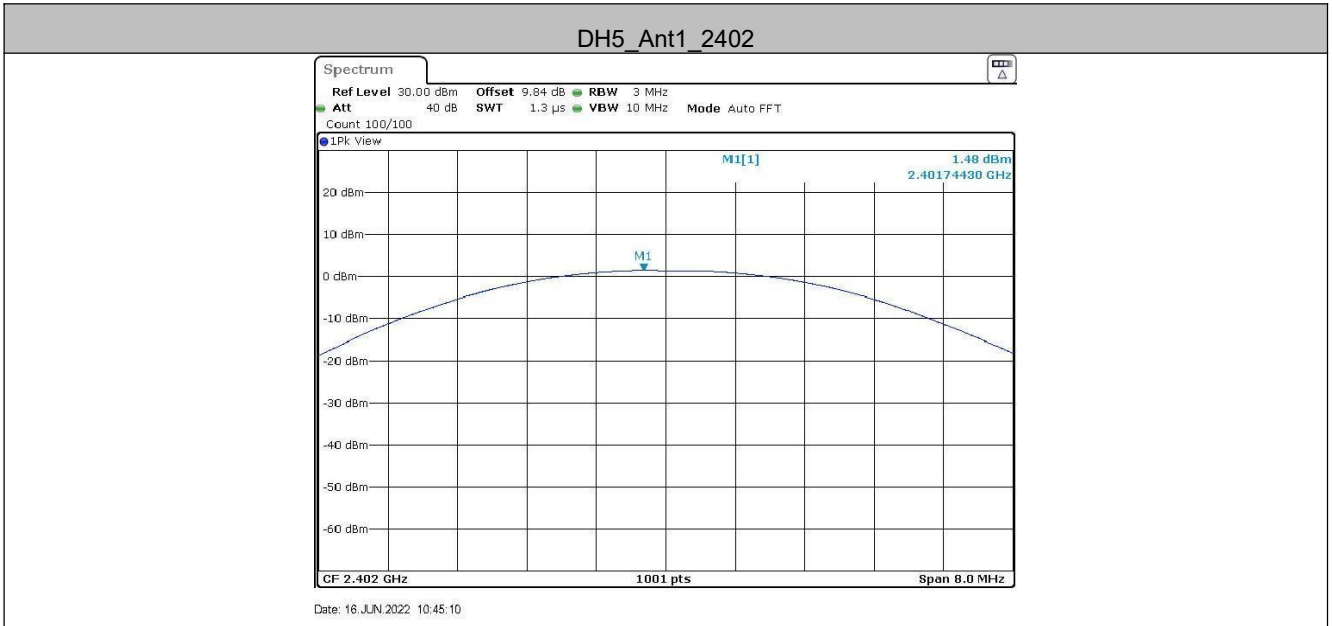

DH5\_Ant1\_2480

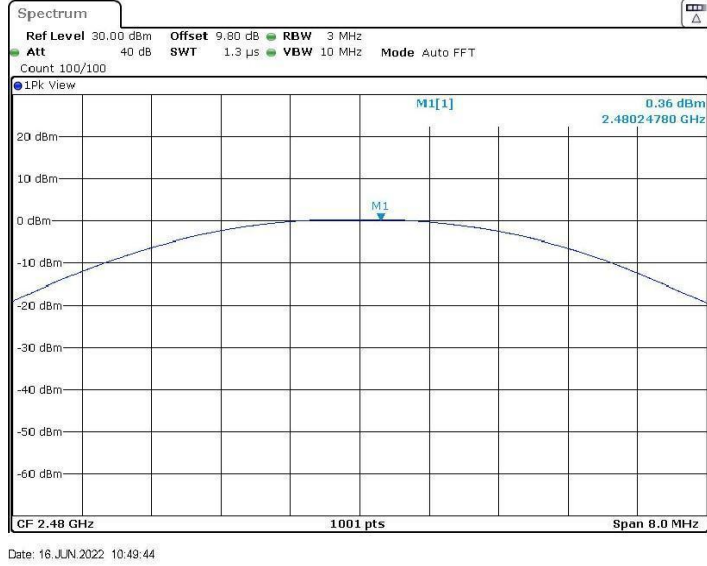

2DH5\_Ant1\_2402

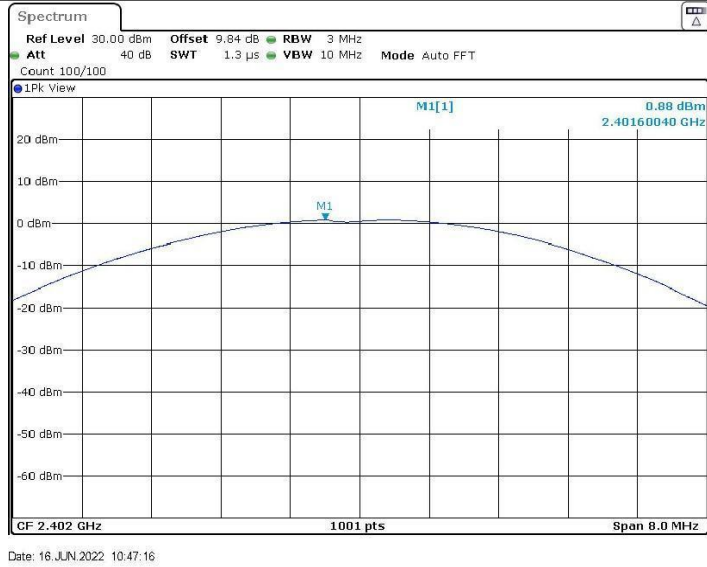

2DH5\_Ant1\_2441



2DH5\_Ant1\_2480

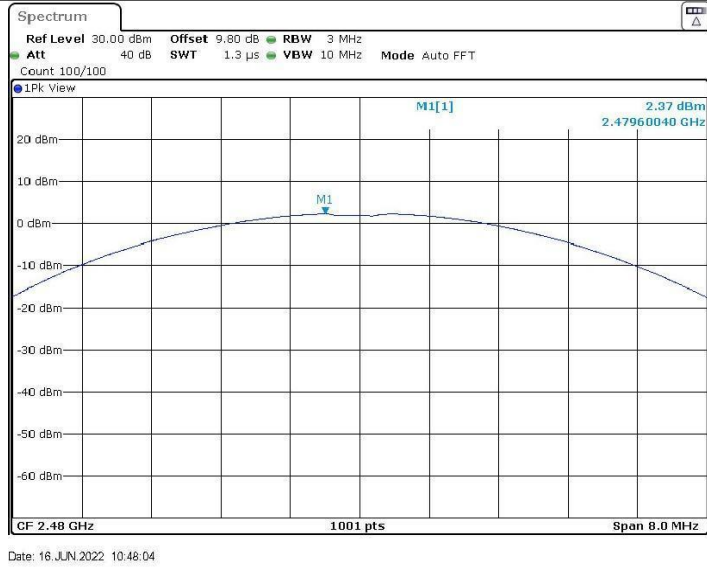

3DH5\_Ant1\_2402

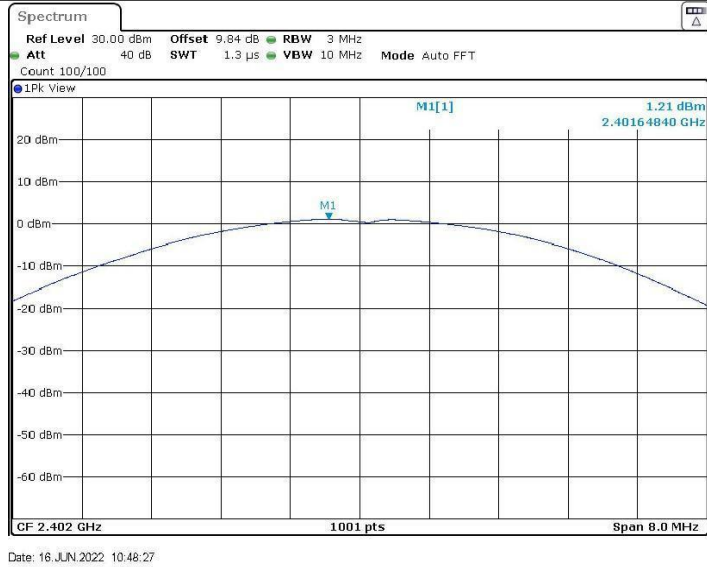

3DH5\_Ant1\_2441

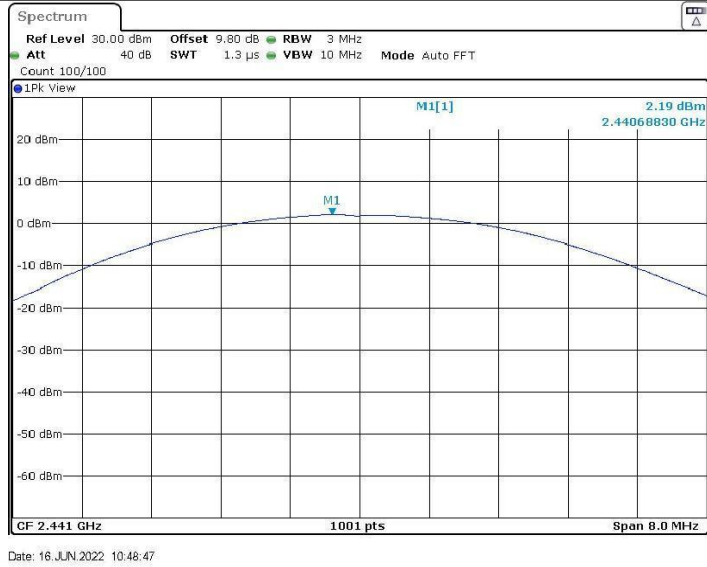

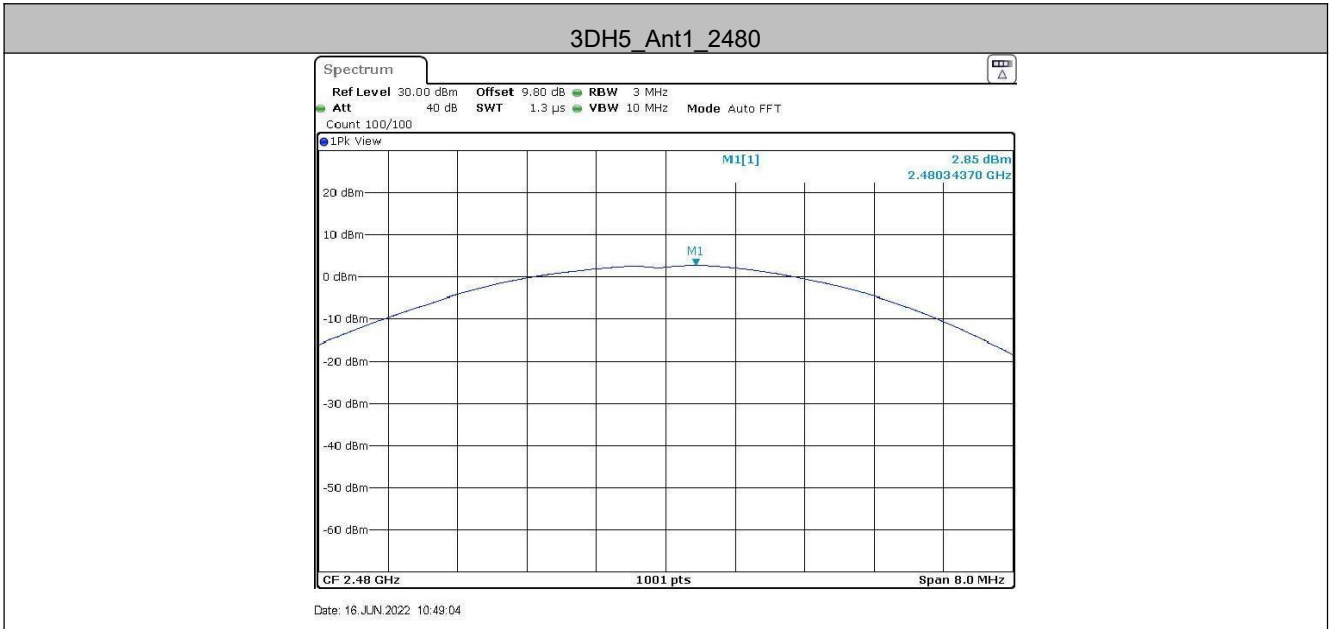

## 5.4 20dB Occupy Bandwidth

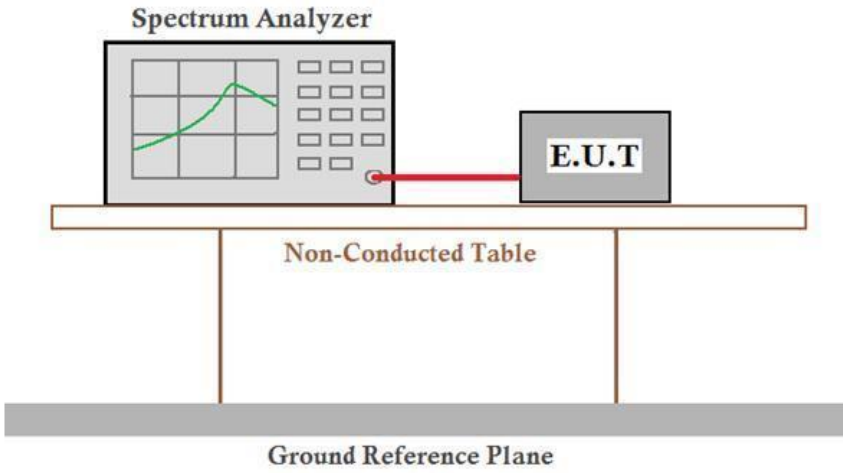
Test Requirement:	47 CFR Part 15C Section 15.247 (a)(1)
Test Method:	ANSI C63.10:2013
Test Setup:	 <p>Remark: Offset=Cable loss+ attenuation factor.</p>
Limit:	NA
Exploratory Test Mode:	Non-hopping transmitting with all kind of modulation and all kind of data type
Final Test Mode:	Through Pre-scan, find the DH5 of data type is the worst case of GFSK modulation type, 2-DH5 of data type is the worst case of $\pi/4$ DQPSK modulation type, 3-DH5 of data type is the worst case of 8DPSK modulation type. Only the worst case is recorded in the report.
Test Results:	Pass

### Measurement Data

Test channel	20dB Occupy Bandwidth (MHz)		
	GFSK	$\pi/4$ DQPSK	8DPSK
Lowest	0.888	1.326	1.296
Middle	0.924	1.326	1.296
Highest	0.924	1.326	1.296



Test plot as follows:



DH5\_Ant1\_2480

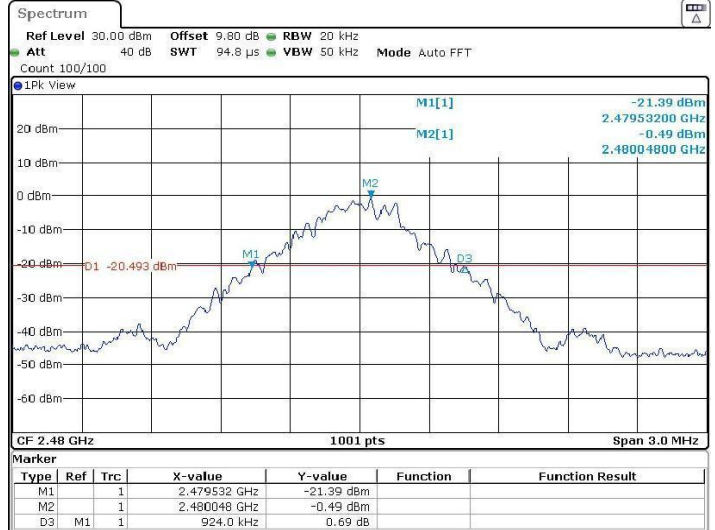

Date: 16 JUN 2022 09:14:19

2DH5\_Ant1\_2402

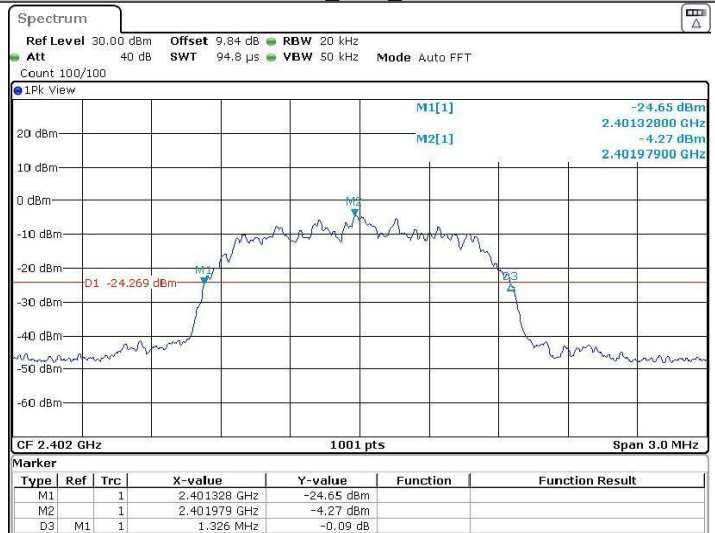

Date: 16 JUN 2022 09:32:40

2DH5\_Ant1\_2441

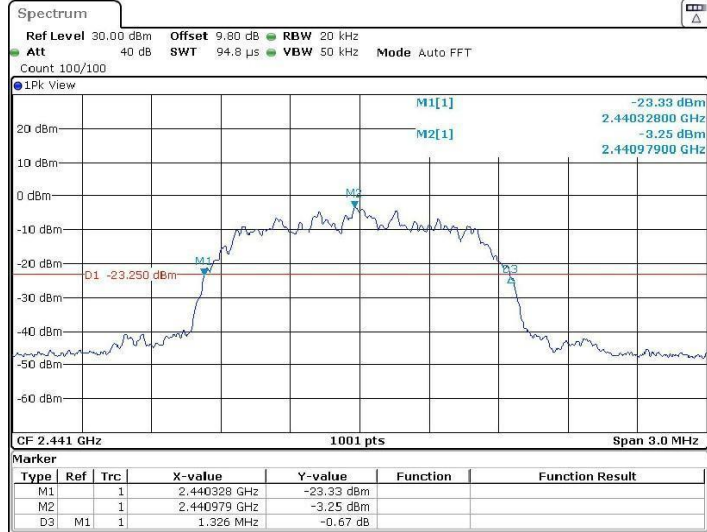

Date: 16 JUN 2022 09:39:13

2DH5\_Ant1\_2480

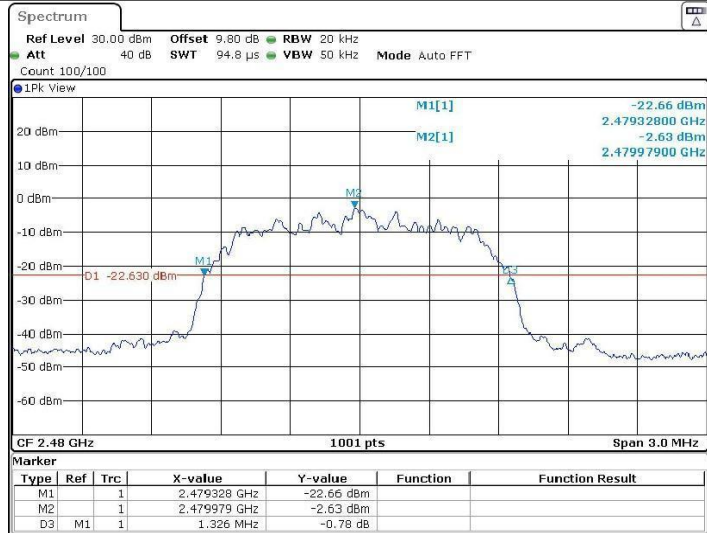

Date: 16 JUN 2022 09:40:24

3DH5\_Ant1\_2402

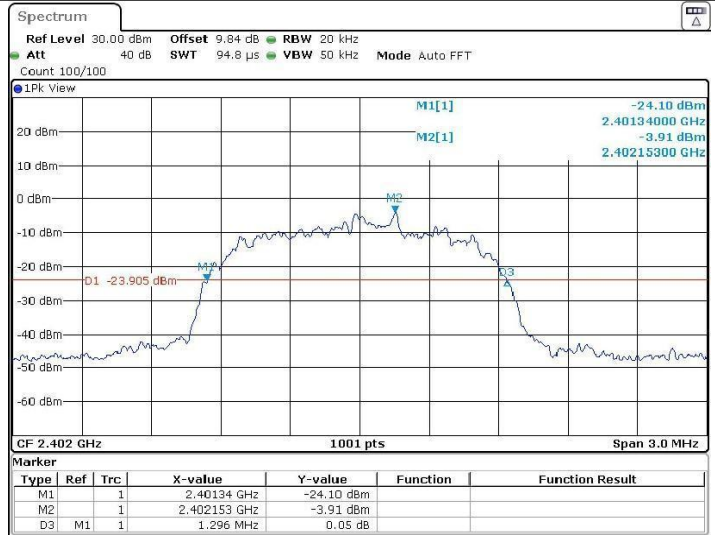

Date: 16 JUN 2022 09:44:32

3DH5\_Ant1\_2441



Date: 16 JUN 2022 09:47:46

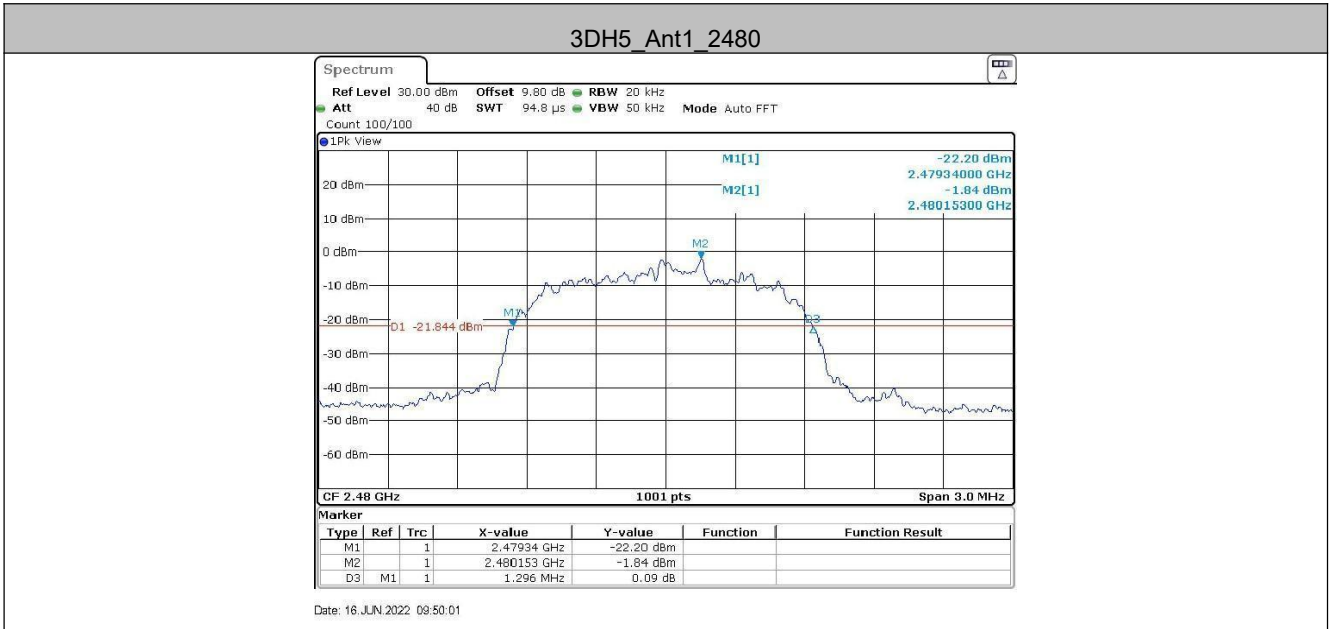

## 5.5 Carrier Frequencies Separation

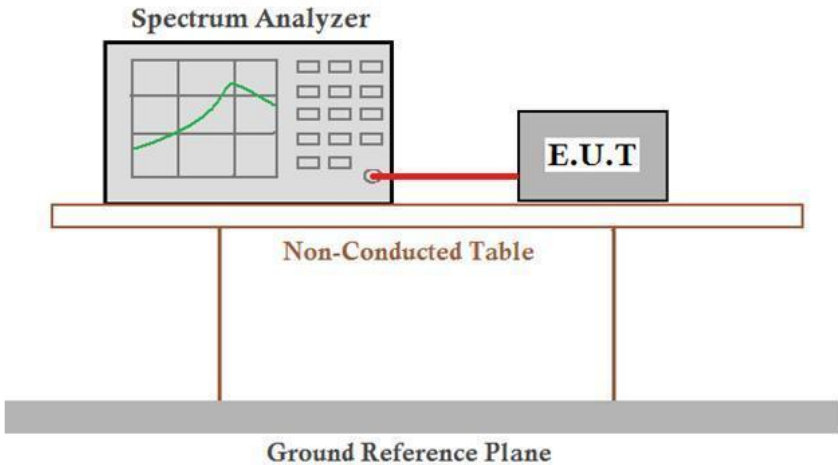
Test Requirement:	47 CFR Part 15C Section 15.247 (a)(1)
Test Method:	ANSI C63.10:2013
Test Setup:	 <p>Remark: Offset=Cable loss+ attenuation factor.</p>
Limit:	2/3 of the 20dB bandwidth
	Remark: the transmission power is less than 0.125W.
Exploratory Test Mode:	Hopping transmitting with all kind of modulation and all kind of data type
Final Test Mode:	Through Pre-scan, find the DH5 of data type is the worst case of GFSK modulation type, 2-DH5 of data type is the worst case of $\pi/4$ DQPSK modulation type, 3-DH5 of data type is the worst case of 8DPSK modulation type. Only the worst case is recorded in the report.
Test Results:	Pass

Measurement Data

TestMode	Antenna	Channel	Result[MHz]	Limit[MHz]	Verdict
DH5	Ant1	Hop	1.145	≥0.616	PASS
2DH5	Ant1	Hop	1.003	≥0.884	PASS
3DH5	Ant1	Hop	1.151	≥0.864	PASS

Mode	20dB bandwidth (MHz) (worse case)	Limit (MHz) (Carrier Frequencies Separation)
GFSK	0.924	0.616
$\pi/4$ DQPSK	1.326	0.884
8DPSK	1.296	0.864

Test plot as follows:





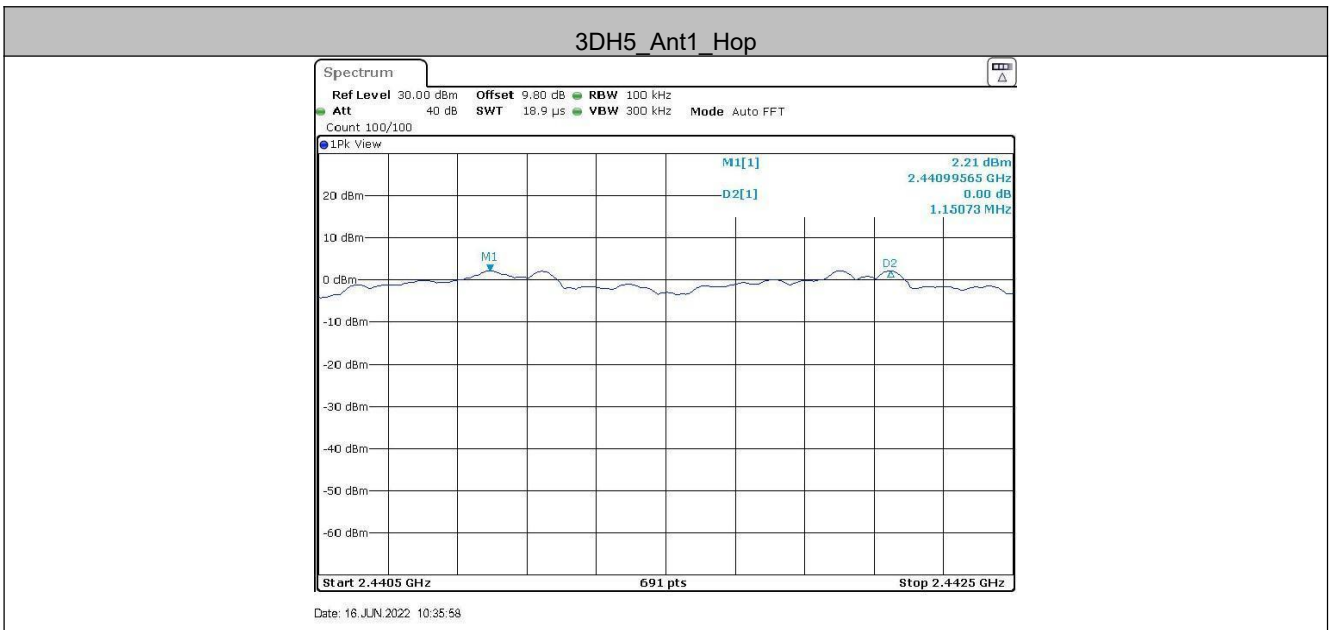

## 5.6 Hopping Channel Number

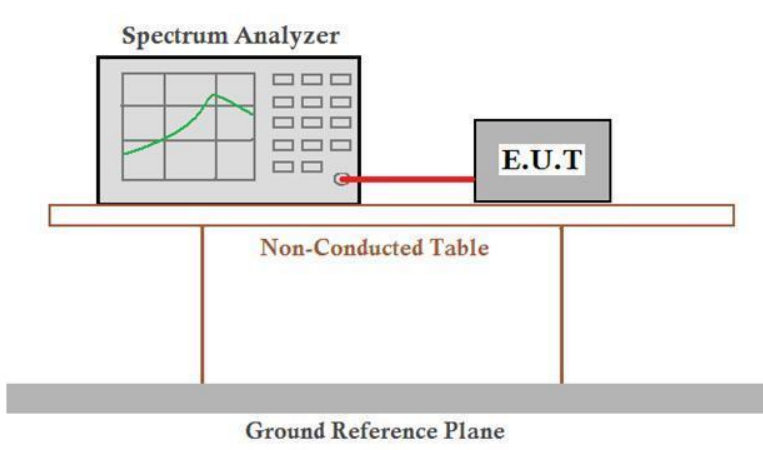
Test Requirement:	47 CFR Part 15C Section 15.247 (a)(1)
Test Method:	ANSI C63.10:2013
Test Setup:	 <p style="text-align: center;"><i>Remark: Offset=Cable loss+ attenuation factor.</i></p>
Limit:	At least 15 channels
Exploratory Test Mode:	hopping transmitting with all kind of modulation and all kind of data type
Final Test Mode:	Through Pre-scan, find the DH5 of data type is the worst case of GFSK modulation type, 2-DH5 of data type is the worst case of $\pi/4$ DQPSK modulation type, 3-DH5 of data type is the worst case of 8DPSK modulation type. Only the worst case is recorded in the report.
Test Results:	Pass

### Measurement Data

Mode	Hopping channel numbers	Limit
GFSK	79	$\geq 15$
$\pi/4$ DQPSK	79	$\geq 15$
8DPSK	79	$\geq 15$

Test plot as follows:

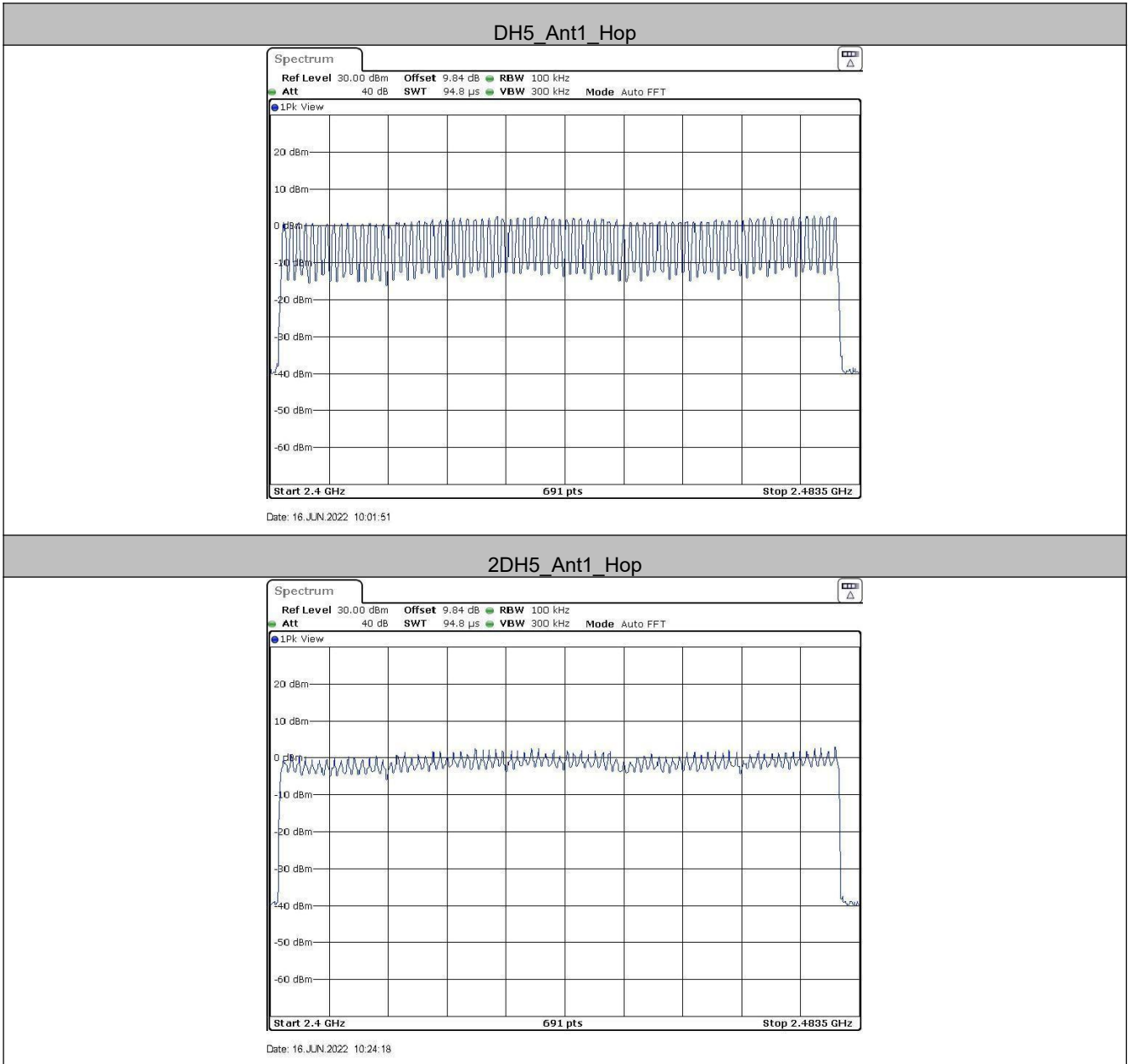

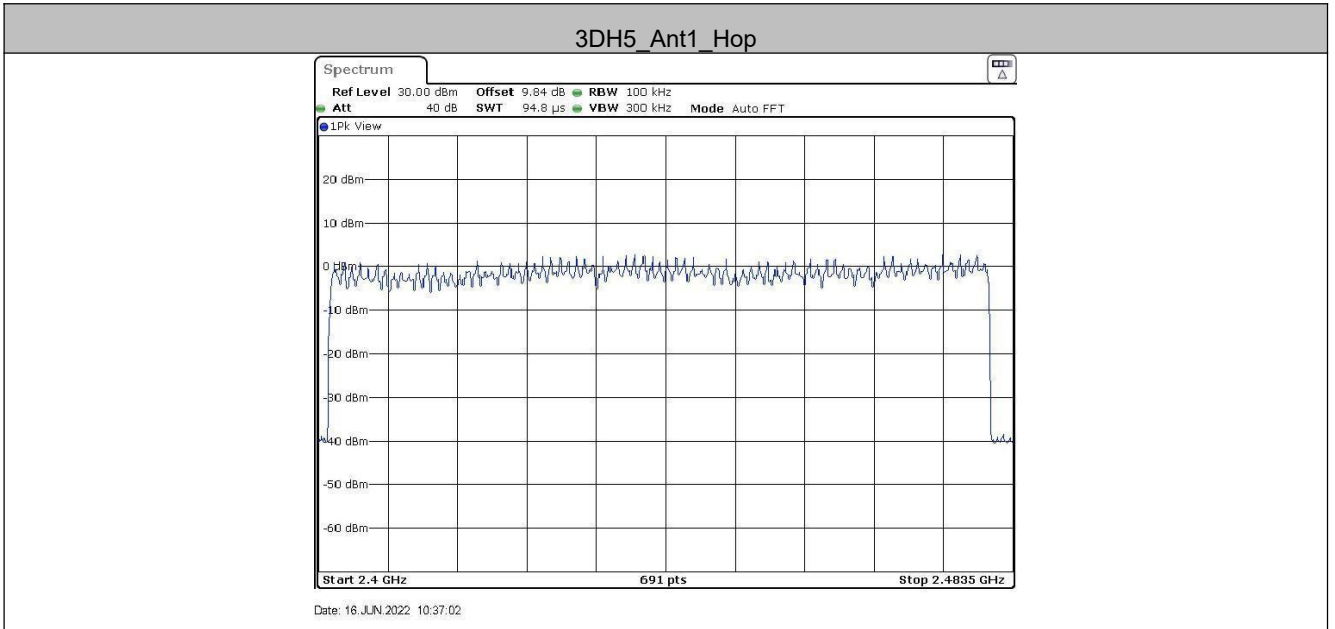

### 5.7 Dwell Time

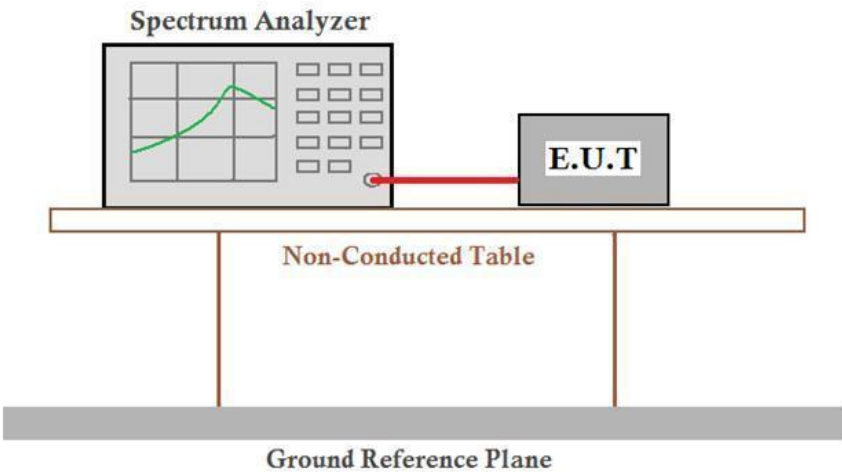
Test Requirement:	47 CFR Part 15C Section 15.247 (a)(1)
Test Method:	ANSI C63.10:2013
Test Setup:	 <p style="text-align: center;"><i>Remark: Offset=Cable loss+ attenuation factor.</i></p>
Test Mode:	Hopping transmitting with all kind of modulation and all kind of data type.
Limit:	0.4 Second
Test Results:	Pass

**Measurement Data**

TestMode	Antenna	Channel	BurstWidth [ms]	TotalHops [Num]	Result[s]	Limit[s]	Verdict
DH1	Ant1	Hop	0.37	330	0.123	≤0.4	PASS
DH3	Ant1	Hop	1.62	150	0.243	≤0.4	PASS
DH5	Ant1	Hop	2.86	120	0.344	≤0.4	PASS
2DH1	Ant1	Hop	0.39	330	0.127	≤0.4	PASS
2DH3	Ant1	Hop	1.63	170	0.277	≤0.4	PASS
2DH5	Ant1	Hop	2.87	90	0.258	≤0.4	PASS
3DH1	Ant1	Hop	0.39	320	0.123	≤0.4	PASS
3DH3	Ant1	Hop	1.63	200	0.326	≤0.4	PASS
3DH5	Ant1	Hop	2.87	90	0.258	≤0.4	PASS

**Remark:**

The test period:  $T = 0.4 \text{ Second/Channel} \times 79 \text{ Channel} = 31.6 \text{ s}$

DH1/2DH1/3DH1 Dwell time = Burst Width(ms)\*[1600/ (2\*79)]\*31.6

DH3/2DH3/3DH3 Dwell time = Burst Width (ms)\*[1600/ (4\*79)]\*31.6

DH5/2DH5/3DH5 Dwell time = Burst Width (ms)\*[1600/ (6\*79)]\*31.6

Test plot as follows:

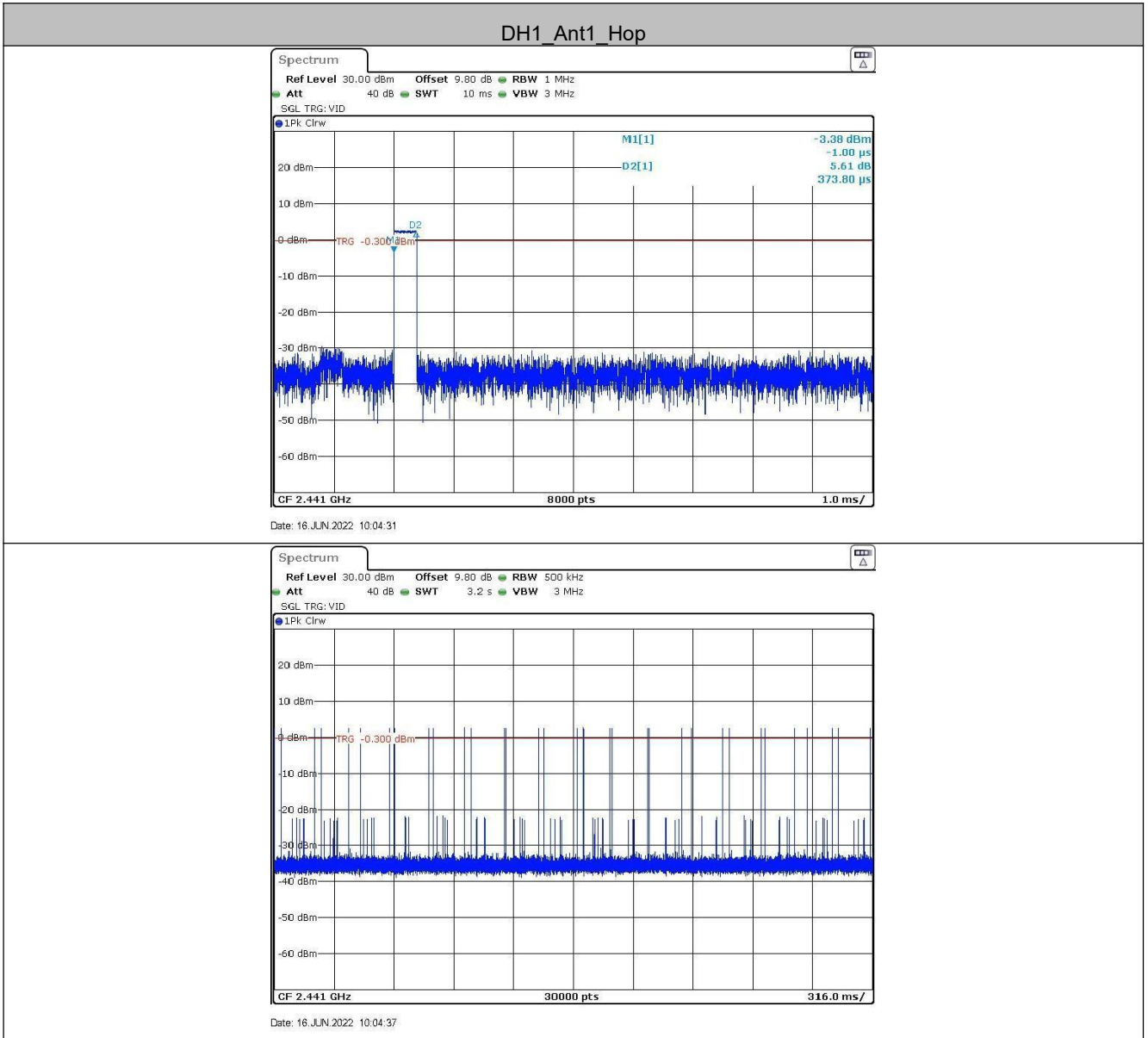

DH3\_Ant1\_Hop

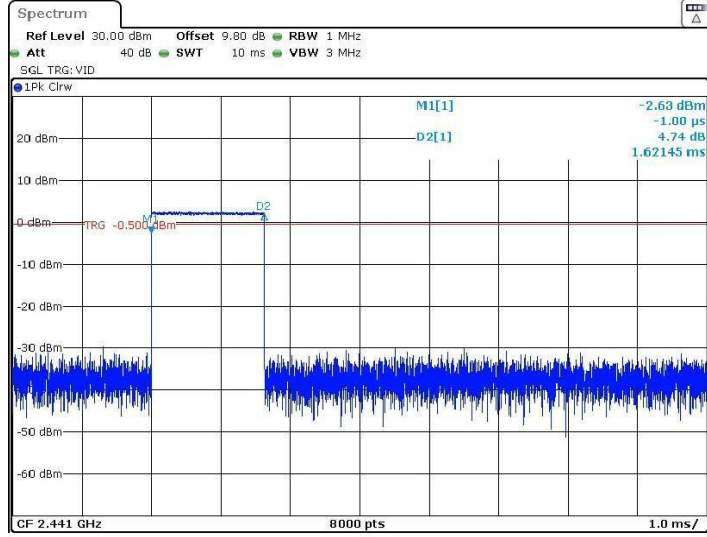

Date: 16 JUN 2022 10:05:56

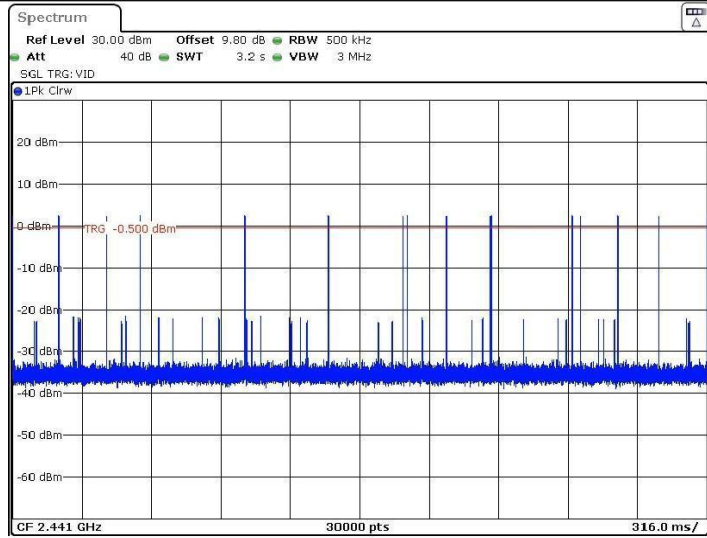

Date: 16 JUN 2022 10:06:02



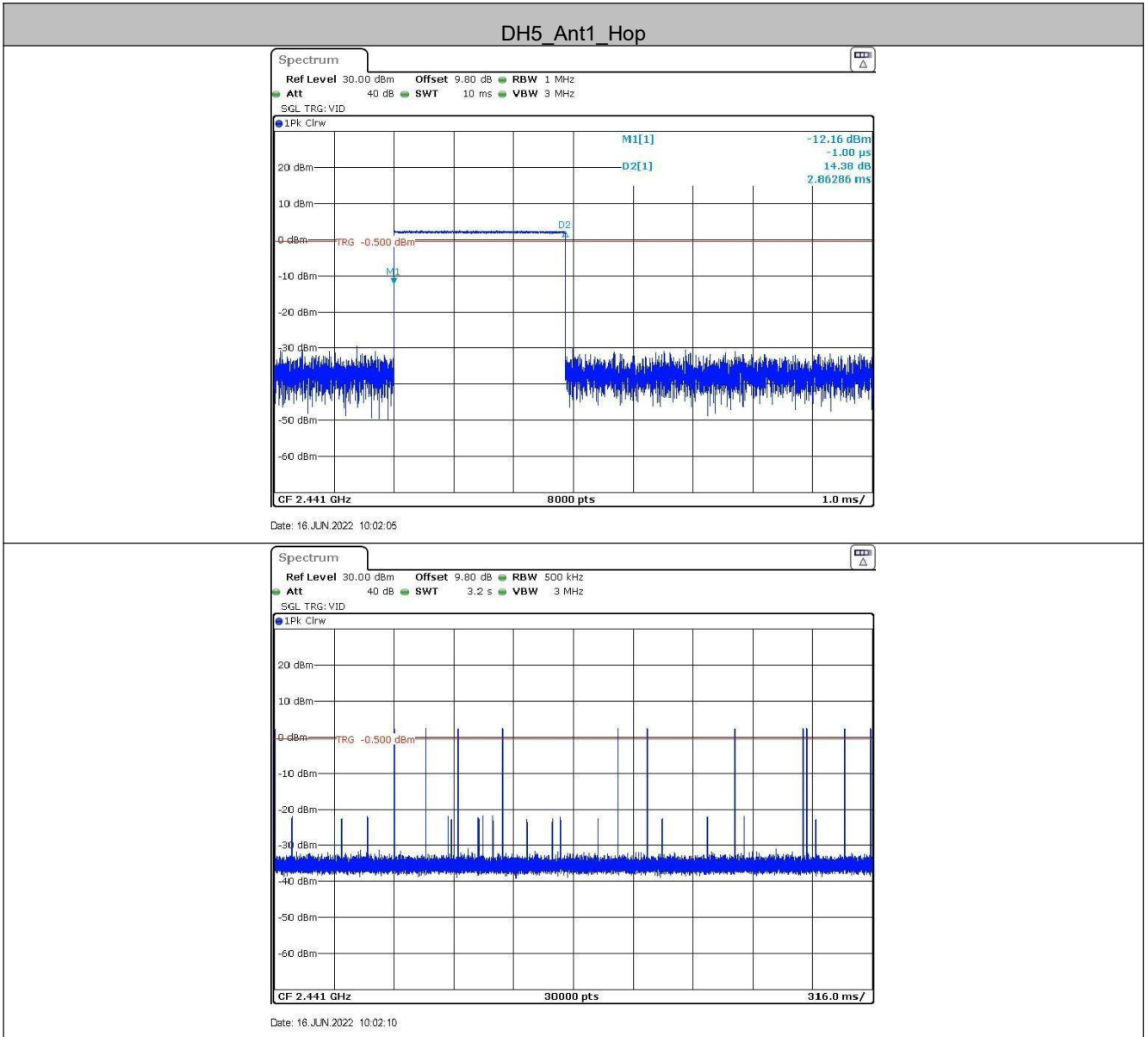

2DH1\_Ant1\_Hop

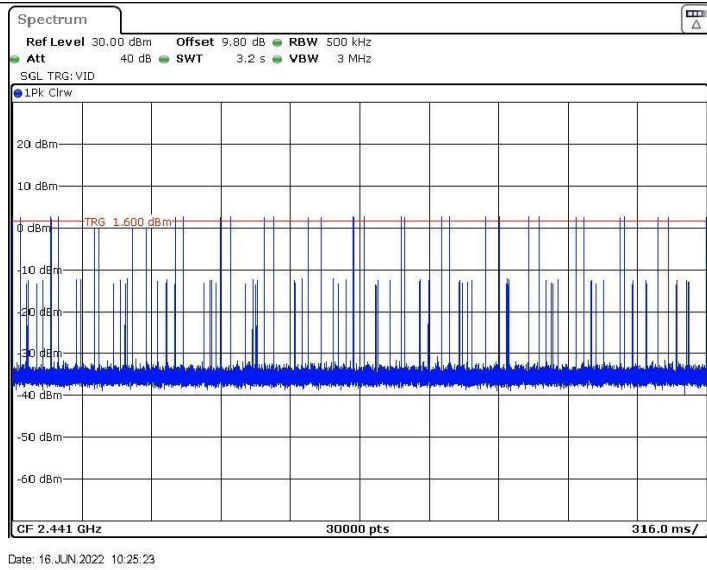
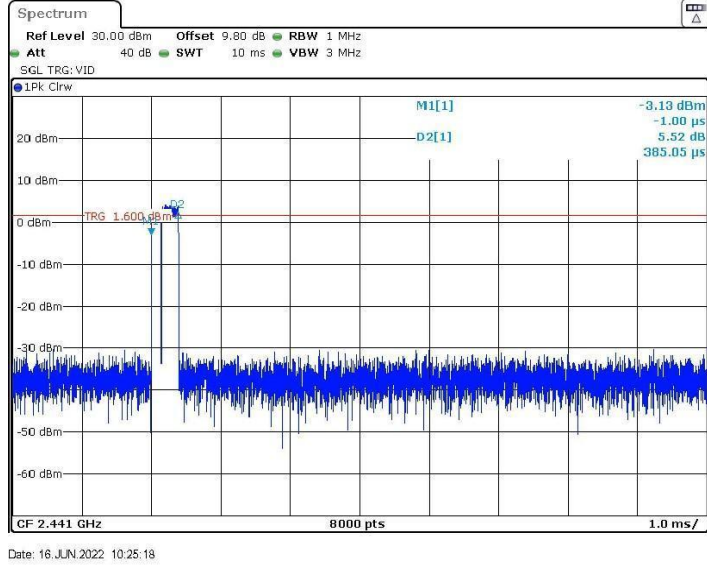

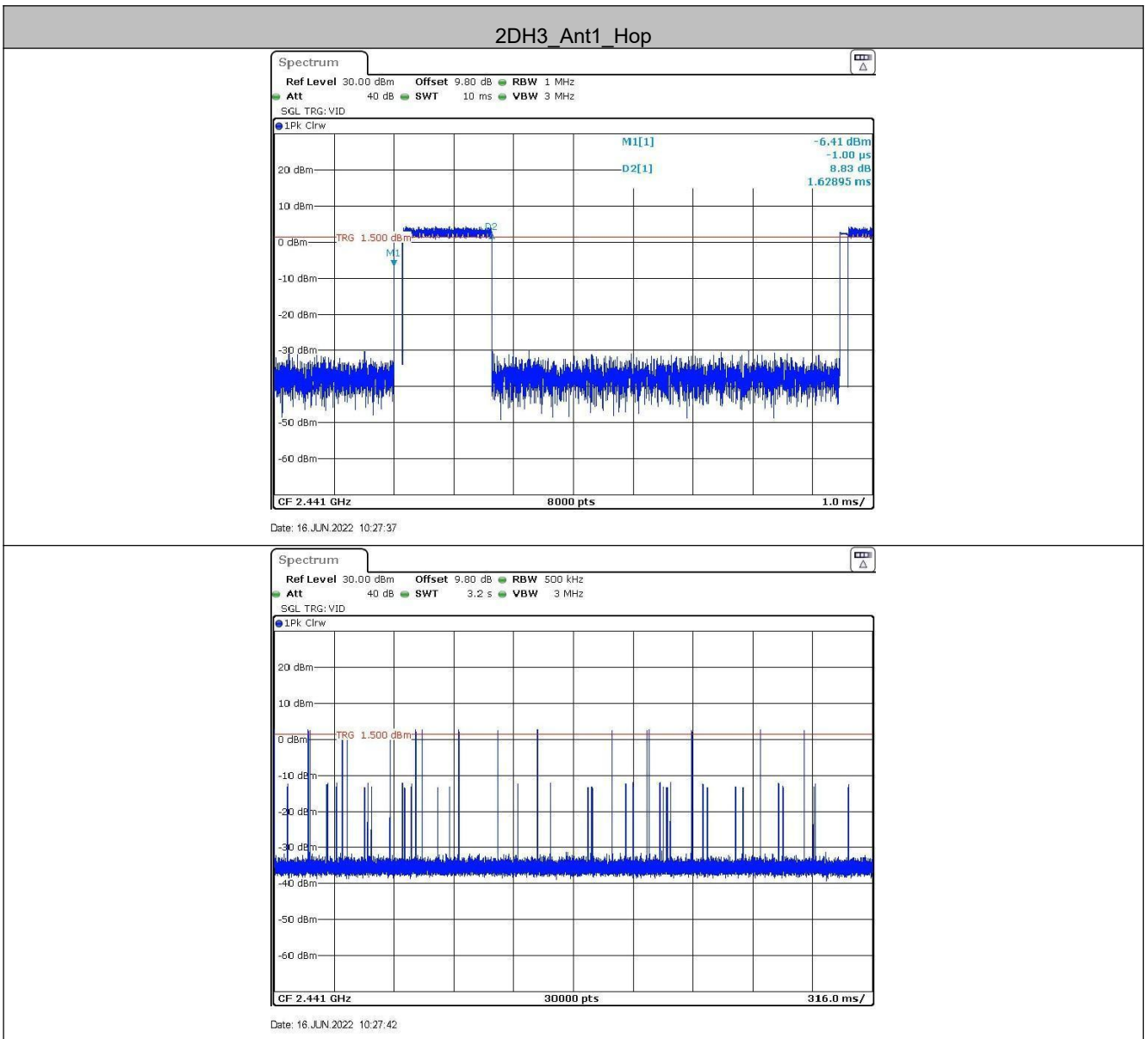

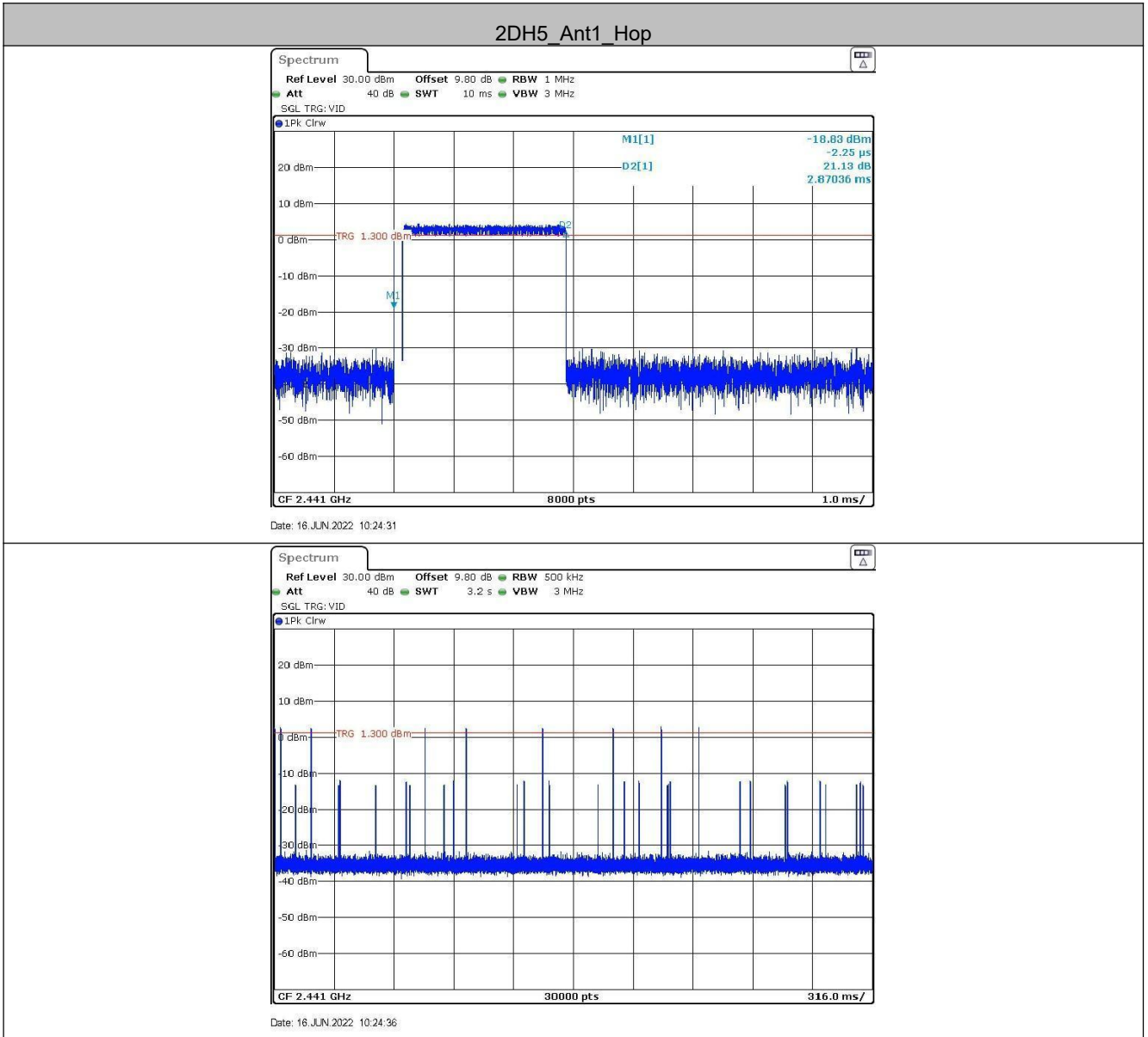

3DH1\_Ant1\_Hop

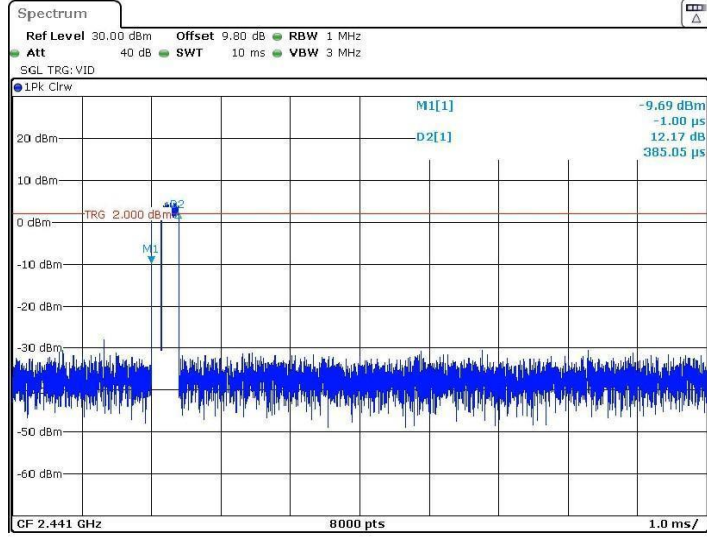

Date: 16 JUN 2022 10:39:10

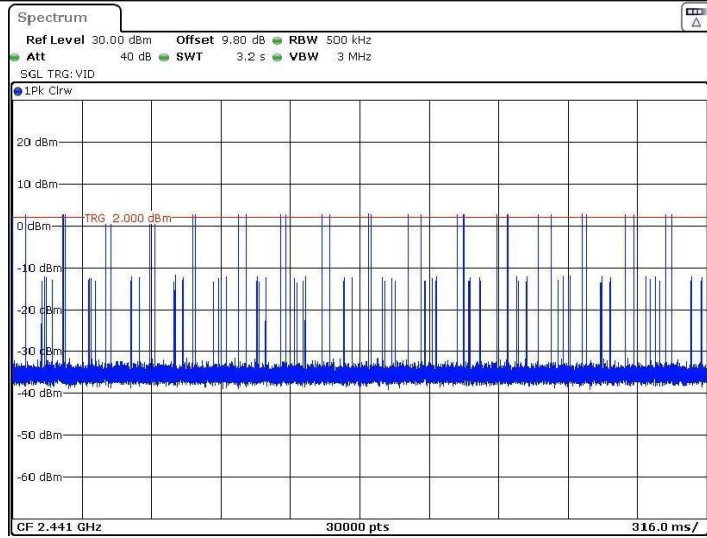

Date: 16 JUN 2022 10:39:15

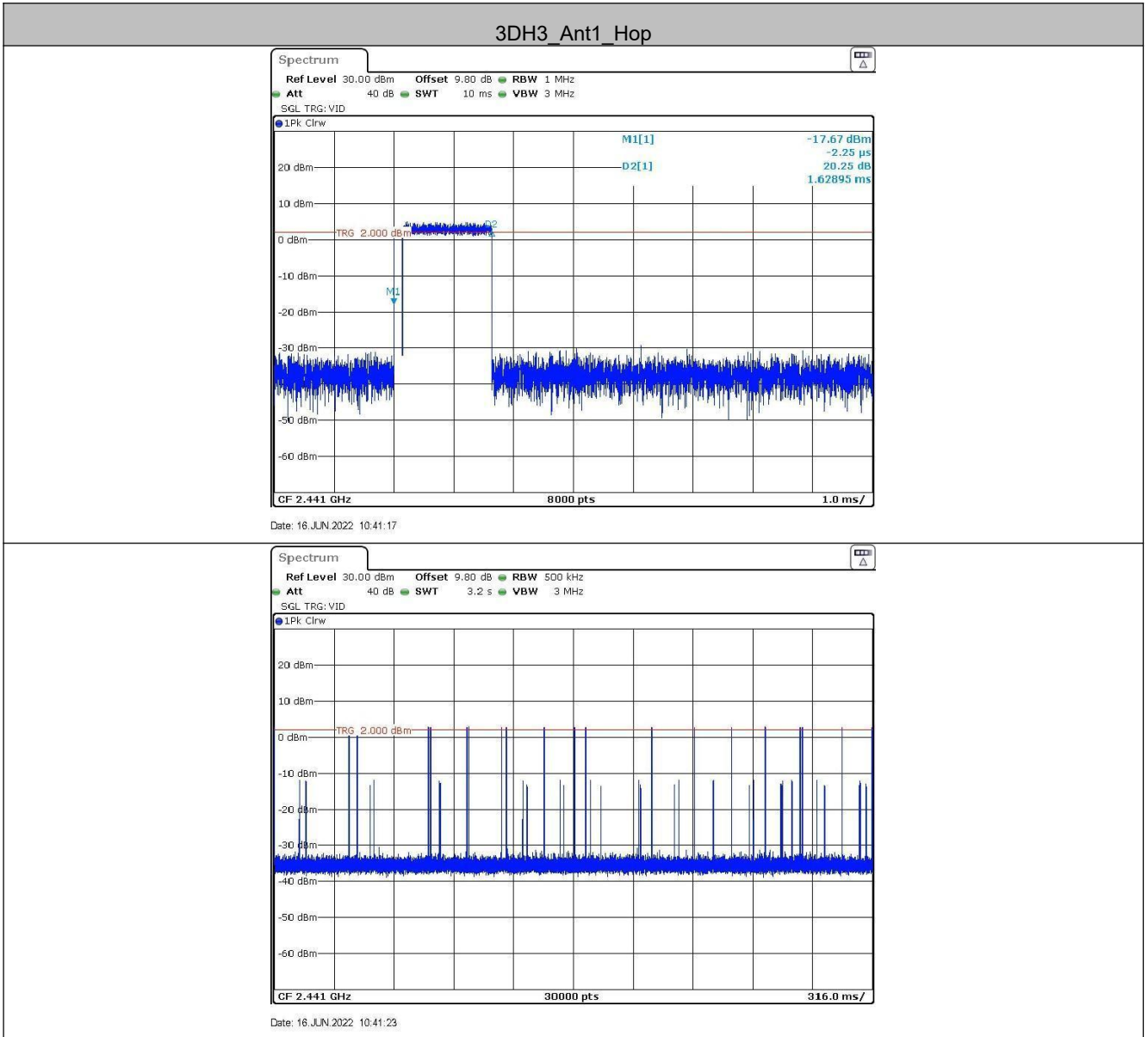

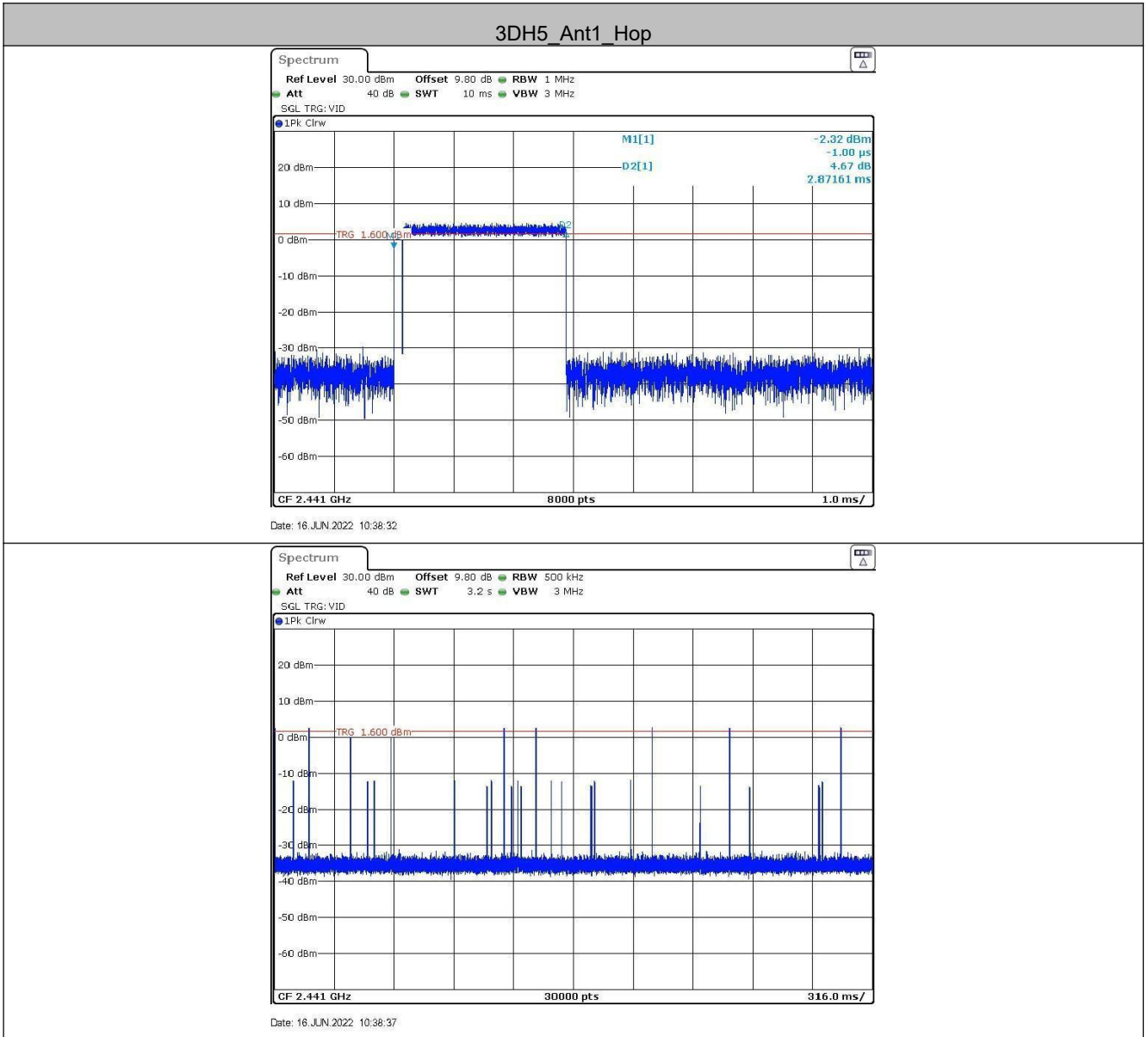

## 5.8 Band-edge for RF Conducted Emissions

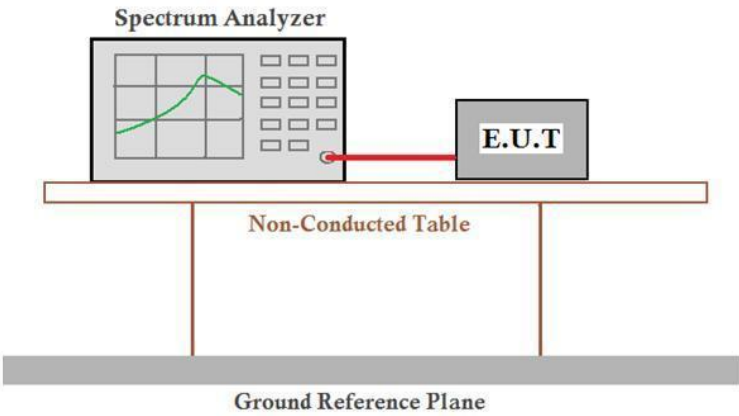
Test Requirement:	47 CFR Part 15C Section 15.247 (d)
Test Method:	ANSI C63.10:2013
Test Setup:	 <p style="text-align: center;"><i>Remark: Offset=cable loss+ attenuation factor.</i></p>
Limit:	In any 100 kHz bandwidth outside the frequency band in which the spread spectrum intentional radiator is operating, the radio frequency power that is produced by the intentional radiator shall be at least 20 dB below that in the 100 kHz bandwidth within the band that contains the highest level of the desired power, based on either an RF conducted or a radiated measurement.
Exploratory Test Mode:	Hopping and Non-hopping transmitting with all kind of modulation and all kind of data type
Final Test Mode:	Through Pre-scan, find the DH5 of data type is the worst case of GFSK modulation type, 2-DH5 of data type is the worst case of $\pi/4$ DQPSK modulation type, 3-DH5 of data type is the worst case of 8DPSK modulation type. Only the worst case is recorded in the report.
Test Results:	Pass



Measurement Data

TestMode	Antenna	ChName	Channel	RefLevel [dBm]	Result [dBm]	Limit [dBm]	Verdict
DH5	Ant1	Low	2402	1.03	-48.48	≤-18.97	PASS
		High	2480	3.00	-47.27	≤-17	PASS
		Low	Hop_2402	0.30	-48.82	≤-19.7	PASS
		High	Hop_2480	2.29	-47.25	≤-17.71	PASS
2DH5	Ant1	Low	2402	1.10	-48.73	≤-18.9	PASS
		High	2480	2.70	-47.68	≤-17.3	PASS
		Low	Hop_2402	-1.06	-48.59	≤-21.06	PASS
		High	Hop_2480	2.08	-47.47	≤-17.92	PASS
3DH5	Ant1	Low	2402	1.02	-48.22	≤-18.98	PASS
		High	2480	2.76	-47.7	≤-17.24	PASS
		Low	Hop_2402	0.33	-49.1	≤-19.67	PASS
		High	Hop_2480	2.71	-46.73	≤-17.29	PASS

Test plot as follows:

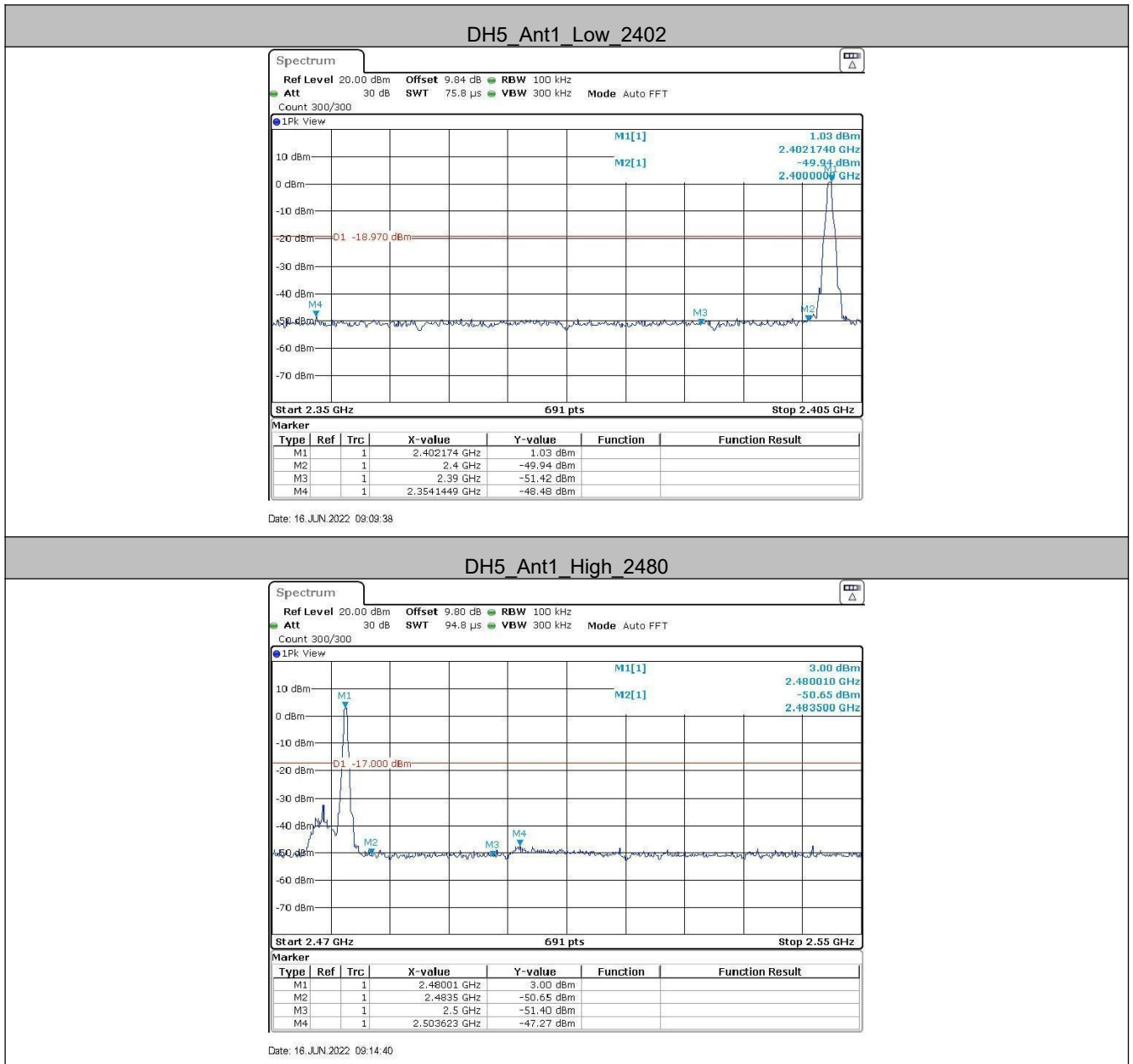

DH5\_Ant1\_Low\_Hop\_2402

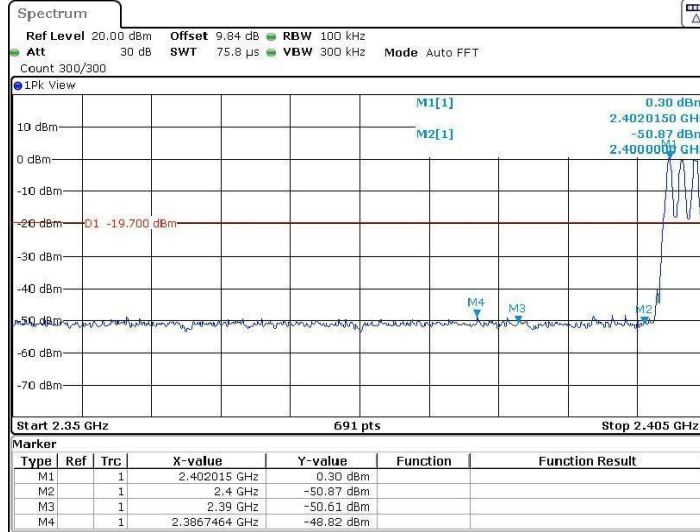

Date: 16 JUN 2022 09:56:37

DH5\_Ant1\_High\_Hop\_2480

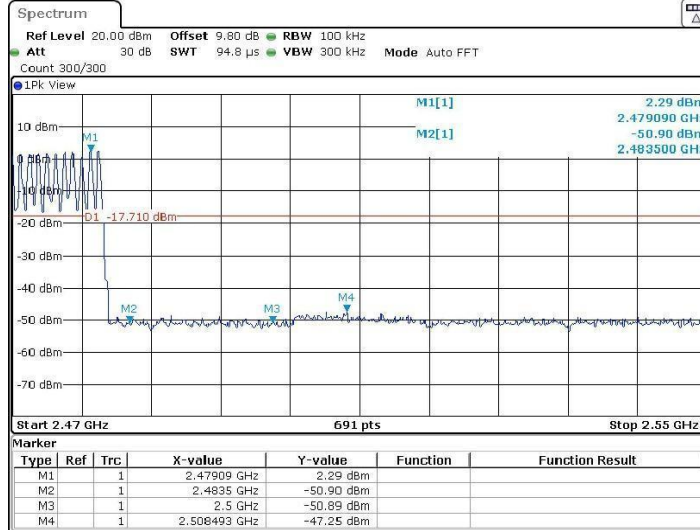

Date: 16 JUN 2022 10:09:05

2DH5\_Ant1\_Low\_2402

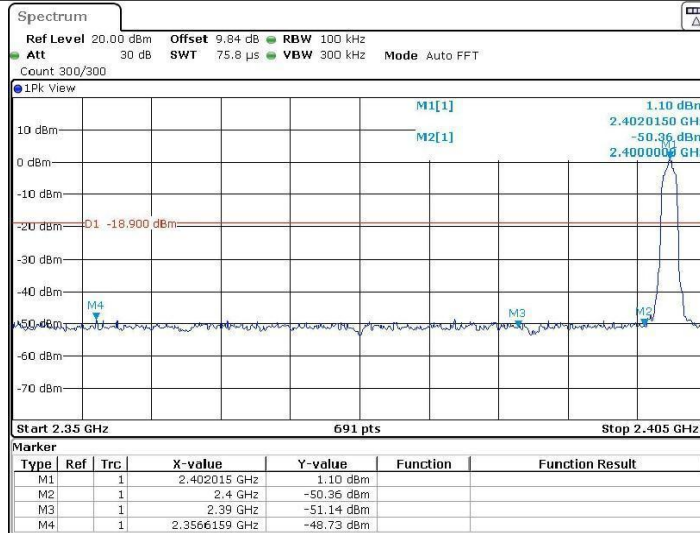

Date: 16 JUN 2022 09:33:01

2DH5\_Ant1\_High\_2480

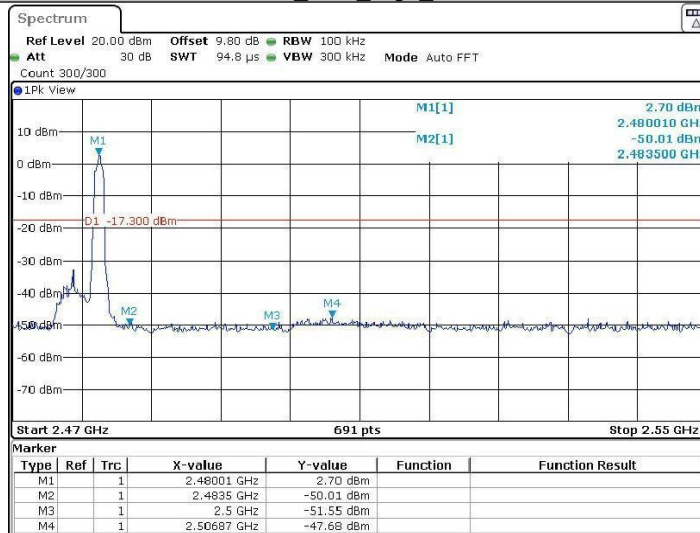

Date: 16 JUN 2022 09:40:45

2DH5\_Ant1\_Low\_Hop\_2402

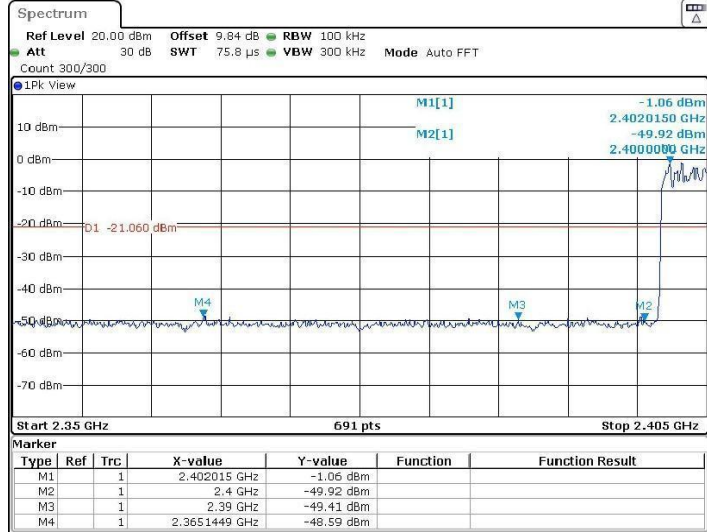

Date: 16 JUN 2022 10:18:30

2DH5\_Ant1\_High\_Hop\_2480

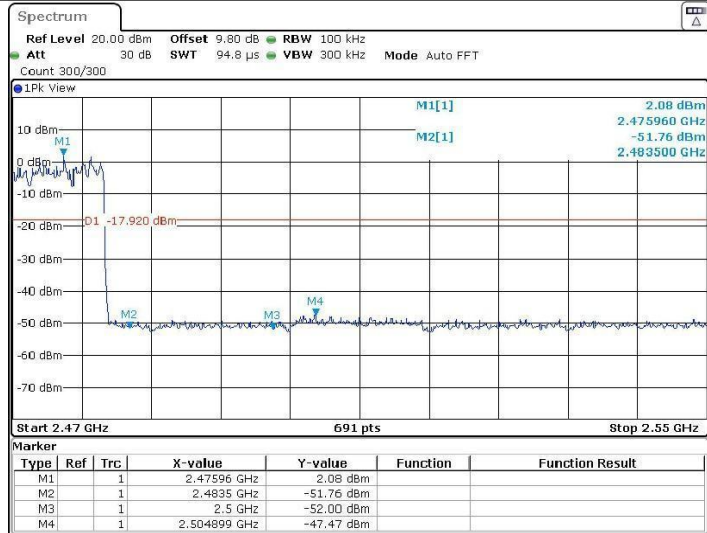

Date: 16 JUN 2022 10:28:50

3DH5\_Ant1\_Low\_2402

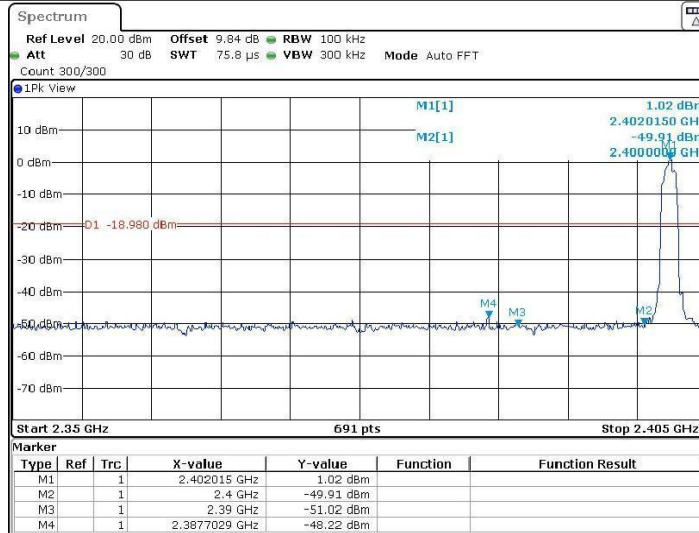

Date: 16 JUN 2022 09:44:54

3DH5\_Ant1\_High\_2480

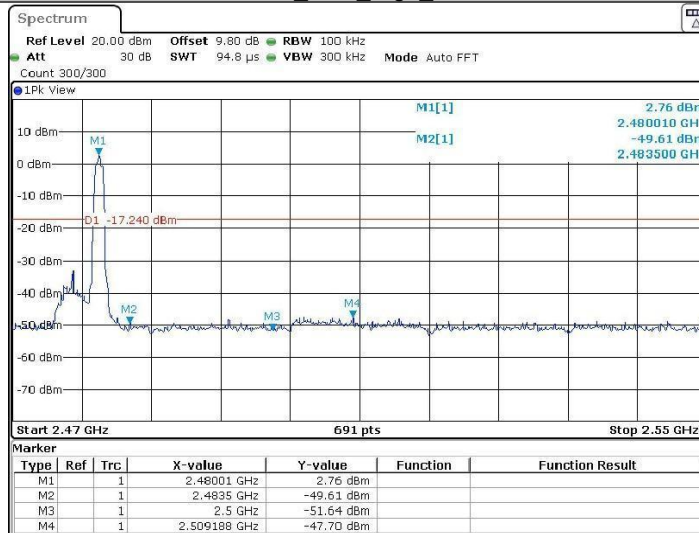

Date: 16 JUN 2022 09:50:22

3DH5\_Ant1\_Low\_Hop\_2402

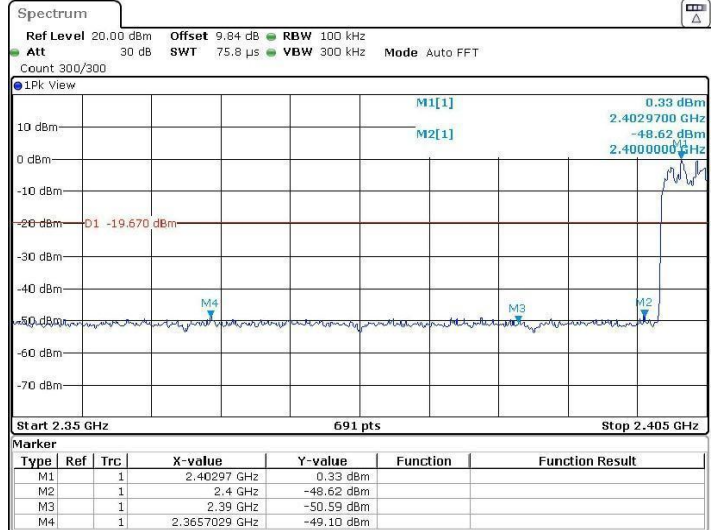

Date: 16 JUN 2022 10:33:24

3DH5\_Ant1\_High\_Hop\_2480

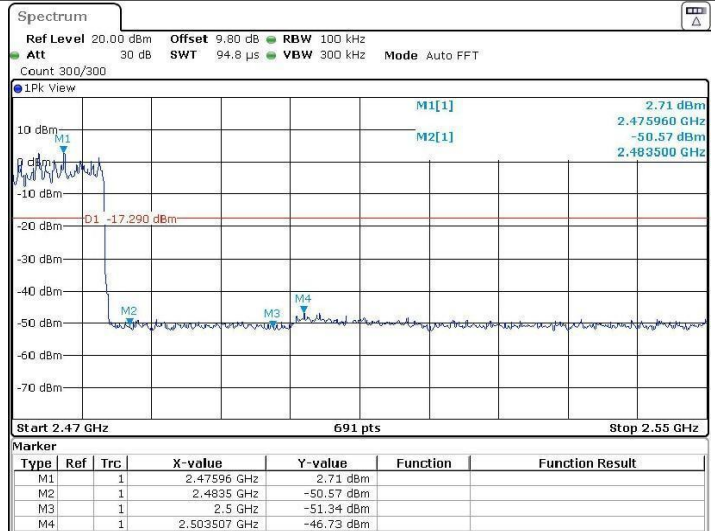

Date: 16 JUN 2022 10:42:37

## 5.9 Spurious RF Conducted Emissions

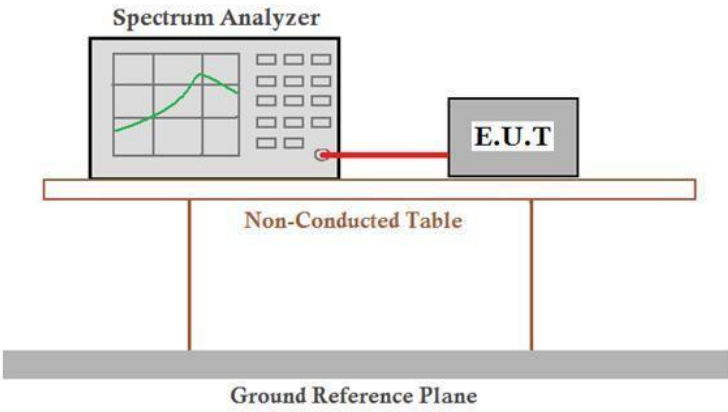
Test Requirement:	47 CFR Part 15C Section 15.247 (d)
Test Method:	ANSI C63.10:2013
Test Setup:	 <p style="text-align: center;"><i>Remark: Offset=cable loss+ attenuation factor.</i></p>
Limit:	In any 100 kHz bandwidth outside the frequency band in which the spread spectrum intentional radiator is operating, the radio frequency power that is produced by the intentional radiator shall be at least 20 dB below that in the 100 kHz bandwidth within the band that contains the highest level of the desired power, based on either an RF conducted or a radiated measurement.
Exploratory Test Mode:	Non-hopping transmitting with all kind of modulation and all kind of data type
Final Test Mode:	Through Pre-scan, find the DH5 of data type is the worst case of GFSK modulation type, 2-DH5 of data type is the worst case of $\pi/4$ DQPSK modulation type, 3-DH5 of data type is the worst case of 8DPSK modulation type.
Test Results:	Pass



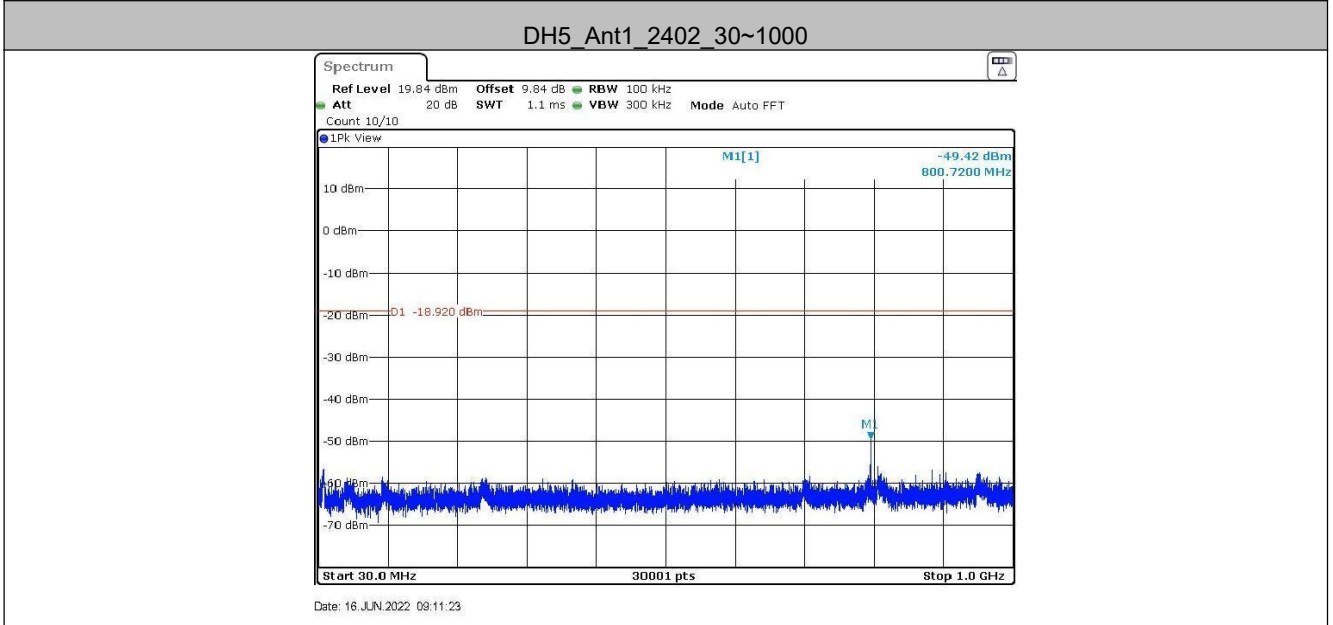
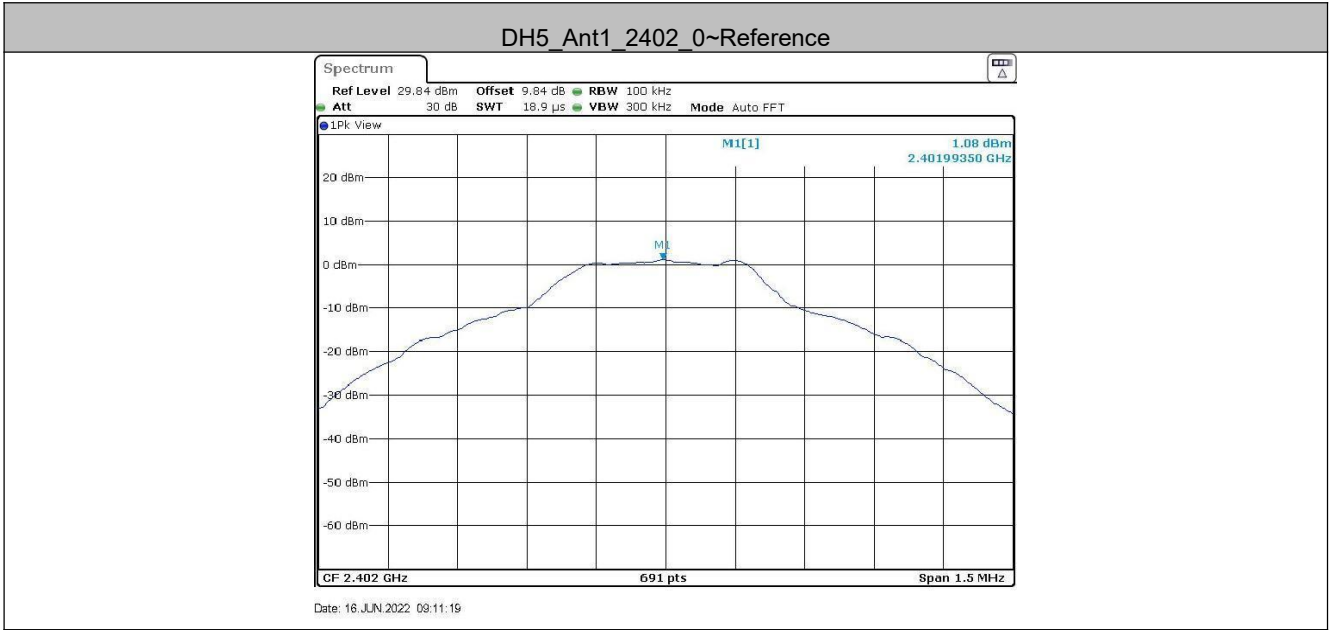

DH5\_Ant1\_2402\_1000~26500

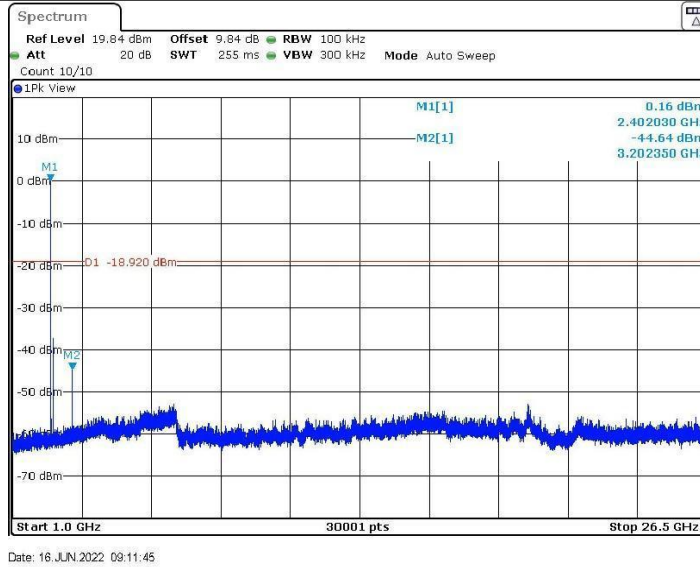

DH5\_Ant1\_2441\_0~Reference

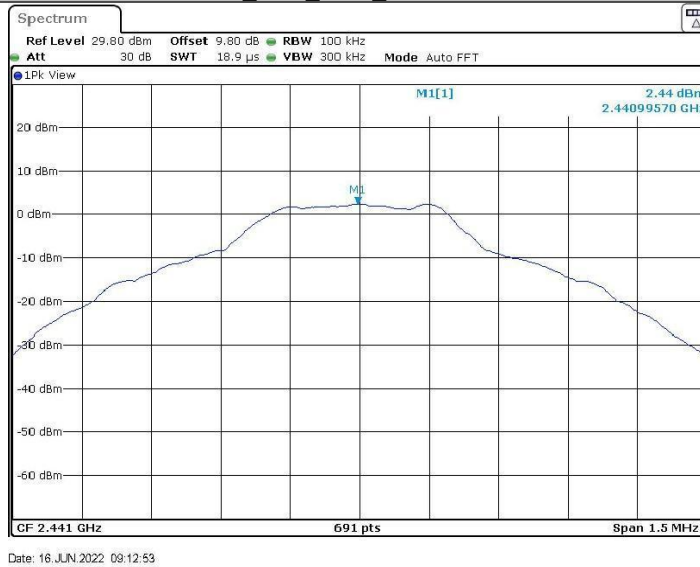

DH5\_Ant1\_2441\_30~1000

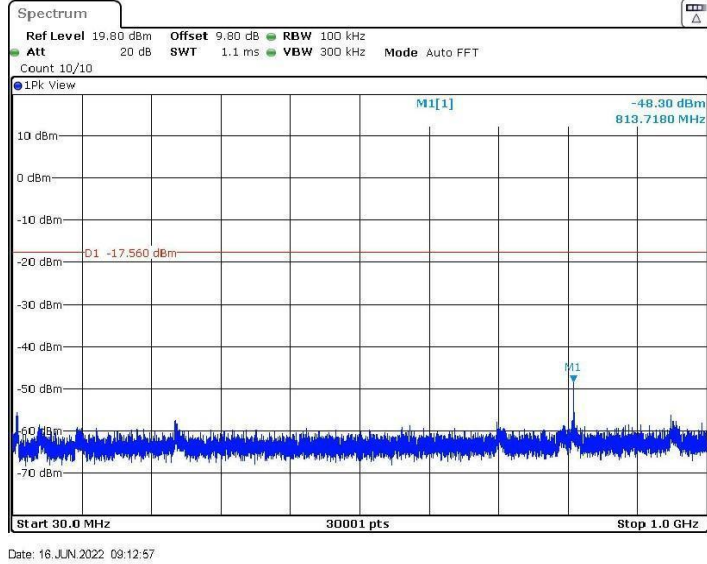

DH5\_Ant1\_2441\_1000~26500

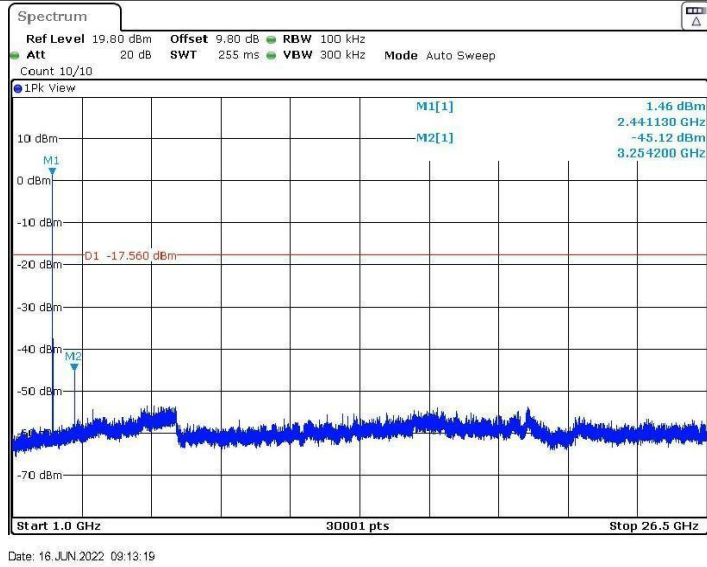

DH5\_Ant1\_2480\_0~Reference

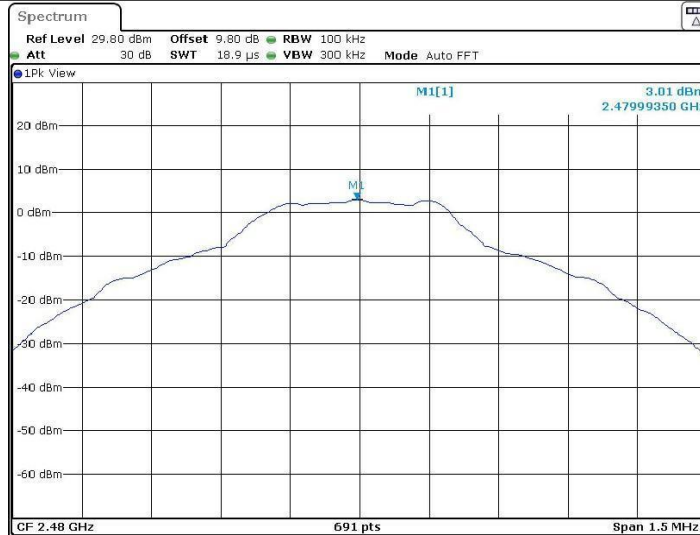

Date: 16 JUN 2022 09:16:11

DH5\_Ant1\_2480\_30~1000

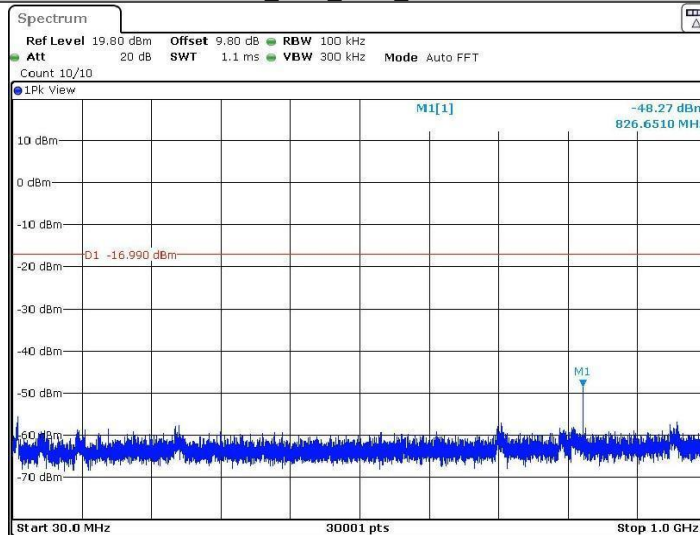

Date: 16 JUN 2022 09:16:16