

Test Report of FCC CFR 47 Part 15 Subpart C

On Behalf of

KeyOvation LLC

1320 Arrow Point Dr Bldg 1 Ste 101, Cedar Park, Texas 78613, United States

Product Name:	Goldtouch Wireless Mouse
Model/Type No.:	KOV-GTM-100W
FCC ID:	YVL-KOVGTM100W
Prepared By:	Shenzhen Hongcai Testing Technology Co., Ltd. 1st-3rd Floor, Building C, Shuanghuan Xin Yi Dai Hi-Tech Industrial Park, No.8 Baoqing Road, Baolong Industrial Zone, Longgang District, Shenzhen, Guangdong, China Tel: +86-755-86337020 Fax: +86-755-86337028
Report Number:	HCT17CR062E-1
Tested Date:	March 21~23, 2017
Issued Date:	March 23, 2017
Tested By:	Jerry Zhao/ <i>Jerry Zhao</i>

Reviewed By:

Owen Yang

Approved By:

Tony Wu

Owen.Yang

EMC Technical Supervisor

Tony Wu

EMC Technical Manager

TABLE OF CONTENTS

1. GENERAL INFORMATION 3

 1.1 Product Description for Equipment Under Test (EUT).....3

 1.2 Test standards4

 1.3 Test Facility4

 1.4 Test Methodology4

2. SYSTEM TEST CONFIGURATION..... 5

 2.1 EUT Configuration5

 2.2 EUT Exercise5

 2.3 General Test Procedures5

 2.4 Measurement Uncertainty5

 2.5 Measure Results Explanation Example6

 2.6. Block diagram of EUT configuration for test7

 2.7 List of Measuring Equipments Used8

3. SUMMARY OF TEST RESULTS..... 8

4. TEST OF CONDUCTED EMISSION 9

 4.1 Applicable Standard.....9

 4.2 Test Setup Diagram.....9

5. BAND EDGES MEASUREMENT 10

 5.1 Limit of Band Edges Measurement10

 5.2 EUT Setup10

 5.3 Test Procedure11

 5.4 Test Result.....11

6. SPURIOUS EMISSIONS..... 13

 6.1 Limit of Spurious Emissions13

 6.2 EUT Setup14

 6.3 Test Procedure15

 6.4 Spurious Emissions Test Result.....15

7. 20DB BANDWIDTH 26

 7.1. Limits.....26

 7.2. Test setup26

 7.3 Test Result.....26

8. ANTENNA REQUIREMENT 29

 8.1 Standard Applicable.....29

 8.2 Antenna Connected Construction29

1. GENERAL INFORMATION

1.1 Product Description for Equipment Under Test (EUT)

Client Information

Applicant:	KeyOvation LLC
Address of Applicant:	1320 Arrow Point Dr Bldg 1 Ste 101, Cedar Park, Texas 78613, United States
Manufacturer:	Minicute Limited
Address of Manufacturer:	14F, Huafeng Xin'an Youth Entrepreneurship Building, NO.31 Jia'an Road, Xin'an St., Bao'an District, Shenzhen, China

General Description of E.U.T

Items	Description
EUT Description:	Goldtouch Wireless Mouse
Model No.:	KOV-GTM-100W
Supplementary Model:	N/A
Frequency Band:	2406MHz~2476MHz
Number of Channels:	16 Channels
Antenna Type:	PCB antenna
Antenna Gain:	2.2dBi
Power Rating:	DC 3V from Battery

Remark: * The test data gathered are from the production sample provided by the manufacturer.

1.2 Test standards

This submittal(s) is a test report based on the Electromagnetic Interference (EMI) tests performed on the EUT. The EMI measurements were performed according to the measurement procedure described in ANSI C63.10 - 2013.

The tests were performed in order to determine compliance with Section 15.203,15.205,15.207 15.209, 15.215,15.249 under the FCC Rules Part 15 Subpart C.

1.3 Test Facility

All measurement required was performed at laboratory of Shenzhen CTL Testing Technology Co., Ltd. Floor 1-A, Baisha Technology Park, No. 3011, Shahexi Road, Nanshan, Shenzhen 518055 China. There is one 3m semi-anechoic chamber and two line conducted labs for final test. The Test Sites meet the requirements in documents ANSI C63.10-2013 and CISPR 22/EN 55022 requirements.

FCC – Registration No.: 970318

Shenzhen CTL Testing Technology Co., Ltd. EMC Laboratory has been registered and fully described in a report filed with the (FCC) Federal Communications Commission. The acceptance letter from the FCC is maintained in our files. Registration 970318, December, 2013.

IC Registration No.: 9618B

The 3m alternate test site of Shenzhen CTL Testing Technology Co., Ltd. EMC Laboratory has been registered by Certification and Engineer Bureau of Industry Canada for the performance of with Registration No.: 9618B on November 13, 2013.

1.4 Test Methodology

The tests documented in this report were performed in accordance with ANSI C63.10:2013 and FCC Part 15 C, Paragraph 15.249.

2. SYSTEM TEST CONFIGURATION

2.1 EUT Configuration

The EUT configuration for testing is installed on RF field strength measurement to meet the Commissions requirement and operating in a manner that intends to maximize its emission characteristics in a continuous normal application.

2.2 EUT Exercise

The calibrated antennas used to sample the radiated field strength are mounted on a non-conductive, motorized antenna mast 3 or 10 meters from the leading edge of the turntable.

2.3 General Test Procedures

Conducted Emissions: The EUT is placed on the table, which is 0.8 m above ground plane According to the requirements in ANSI C63.10-2013 Conducted emissions from the EUT measured in the frequency range between 0.15 MHz and 30MHz using CISPR Quasi-Peak detector mode.

Radiated Emissions: The EUT is a placed on as turntable, which is 0.8 m above ground plane. The turntable shall rotate 360 degrees to determine the position of maximum emission level. EUT is set 3m away from the receiving antenna, which varied from 1m to 4m to find out the highest emission. And also, each emission was to be maximized by changing the polarization of receiving antenna both horizontal and vertical. In order to find out the maximum emissions, exploratory radiated emission measurements were made according to the requirements in ANSI C63.10-2013.

2.4 Measurement Uncertainty

The data and results referenced in this document are true and accurate. The reader is cautioned that there may be errors within the calibration limits of the equipment and facilities. The measurement uncertainty was calculated for all measurements listed in this test report acc. to CISPR 16 - 4 "Specification for radio disturbance and immunity measuring apparatus and methods – Part 4: Uncertainty in EMC Measurements" and is documented in the Shenzhen CTL Testing Technology Co., Ltd. quality system acc. to DIN EN ISO/IEC 17025. Furthermore, component and process variability of devices similar to that tested may result in additional deviation. The manufacturer has the sole responsibility of continued compliance of the device.

Where relevant, the following measurement uncertainty levels have been estimated for tests performed on the apparatus:

Parameter	Uncertainty
Transmitter power conducted	+/- 0.57 dB
Transmitter power Radiated	+/- 2.20 dB
Conducted spurious emission 9KHz-40 GHz	+/- 2.20 dB
Occupied Bandwidth	+/- 0.01 dB
Power Line Conducted Emission	+/- 3.20 dB
Radiated Emission	+/- 4.32 dB

Note: This uncertainty represents an expanded uncertainty expressed at approximately the 95% confidence level using a coverage factor of k=2.

2.5 Measure Results Explanation Example

For all conducted test items:

The offset level is set in the spectrum analyzer to compensate the RF cable loss and attenuator factor between EUT conducted output port and spectrum analyzer. With the offset compensation, the spectrum analyzer reading level is exactly the EUT RF output level.

The spectrum analyzer offset is derived from RF cable loss and attenuator factor.
 $\text{Offset} = \text{RF cable loss} + \text{attenuator factor}$.

Note: Using a temporary antenna connector for the EUT when the conducted measurements are performed.

Equipment	Manufacturer	Model No.	Frequency range(GHz)	Attenuation values(dBm)
Line	Zhenjiang south electronic	RG316	1-12	0.08
			<1G	0.03
			>12G	1.00
Connector	Zhenjiang south electronic	SMA-K/N-J	1-12	0.01
			<1G	0.005
			>12G	0.03

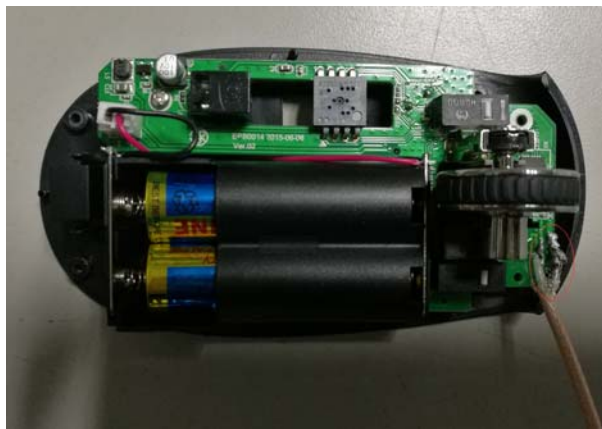
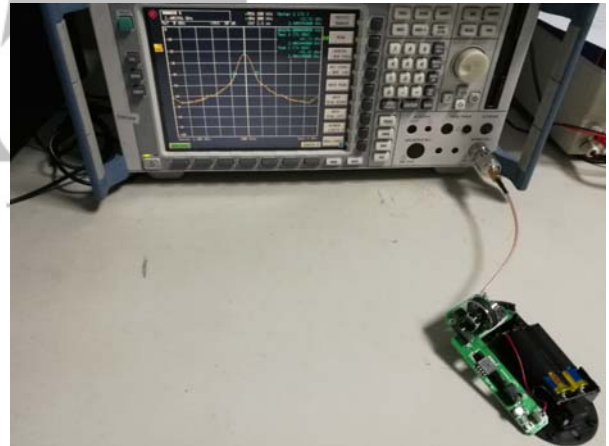
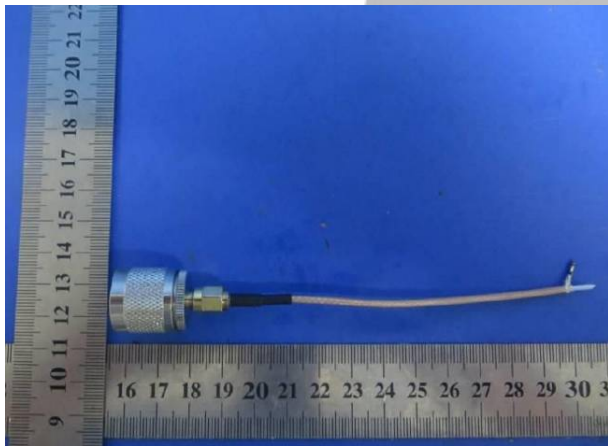

2.6. Block diagram of EUT configuration for test

The EUT has been tested under operating condition. Manual control the EUT for staying in continuous transmitting mode. Channel Low(2406MHz),Channel Middle(2447MHz) and Channel High(2476MHz) are chosen for the final testing.

Channels List:

Channel	Freq.(MHz)	Channel	Freq.(MHz)
1	2406	9	2414
2	2424	10	2433
3	2447	11	2455
4	2467	12	2473
5	2411	13	2417
6	2429	14	2436
7	2451	15	2459
8	2469	16	2476

2.7 List of Measuring Equipments Used

Test equipments list of Shenzhen CTL Testing Technology Co., Ltd.

No.	Equipment	Manufacturer	Model No.	S/N	Last Calculator	Due Calculator
1	EMI Test Receiver	R&S	ESCI	100687	2016-7-25	2017-7-24
2	EMI Test Receiver	R&S	ESPI	100097	2016-10-1	2017-10-31
3	Amplifier	HP	8447D	1937A02492	2016-7-25	2017-7-24
4	TRILOG Broadband Test-Antenna	SCHWARZBECK	VULB9163	9163-324	2016-7-25	2017-7-24
5	Triple-Loop Antenna	EVERFINE	LLA-2	711002	2016-10-1	2017-10-31
6	RF POWER AMPLIFIER	FRANKONIA	FLL-75	1020A1109	2016-7-25	2017-7-24
7	6DB Attenuator	FRANKONIA	N/A	1001698	2016-7-25	2017-7-24
8	10dB attenuator	ELECTRO-METRICS	EM-7600	836	2016-7-25	2017-7-24
9	Spectrum Analyzer	R&S	FSP	100397	2016-10-1	2017-10-31
10	Broadband preamplifier	SCHWARZBECK	BBV9718	9718-182	2016-7-25	2017-7-24
11	Horn Antenna	SCHWARZBECK	BBHA 9120D	0437	2016-7-25	2017-7-24
12	Horn Antenna	SCHWARZBECK	BBHA9170	0483	2016-7-25	2017-7-24

3. SUMMARY OF TEST RESULTS

Standard	Description of Test	Result
§ 15.207	Conducted Emission	N/A , without AC main
§ 15.205	Restricted Band of Operation	Pass
§ 15.249	Band Edges Measurement	Pass
§ 15.209 § 15.249	Spurious Emission	Pass
§ 15.215	20dB Bandwidth	Pass
§ 15.203	Antenna Requirement	Pass

Note: N/A is not applicable.

4. TEST OF CONDUCTED EMISSION

4.1 Applicable Standard

Section 15.207: For a Low-power Radio-frequency Device is designed to be connected to the AC power line, the radio frequency voltage that is conducted back onto the AC power line on any frequency or frequencies within the band 150 kHz to 30 MHz shall not exceed below limits table.

Frequency Range (MHz)	Limits (dBuV)	
	Quasi-Peak	Average
0.150~0.500	66~56	56~46
0.500~5.000	56	46
5.000~30.00	60	50

4.2 Test Setup Diagram

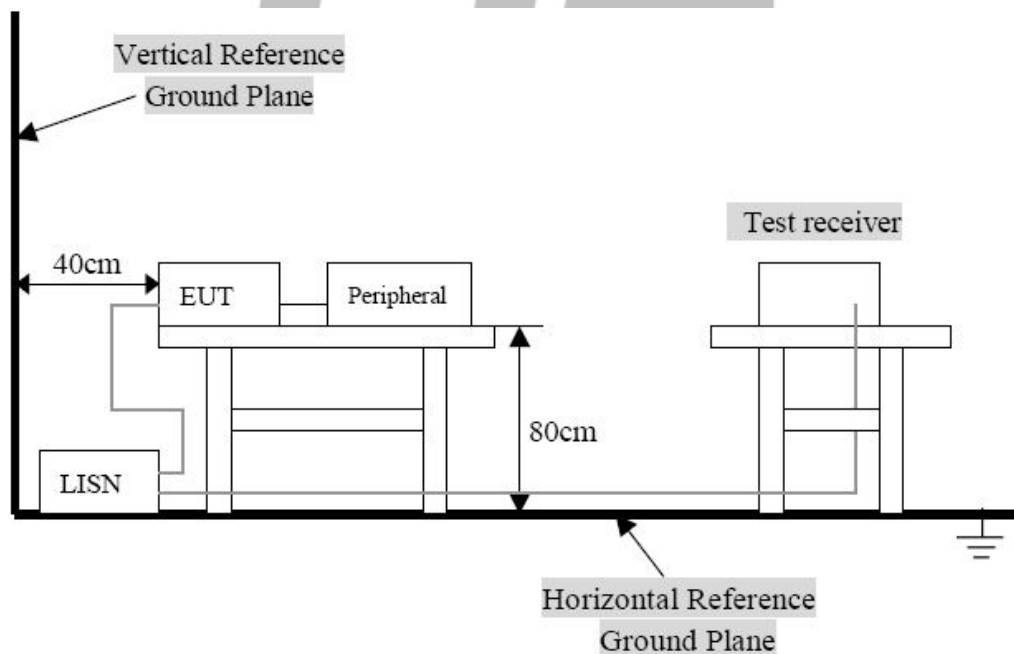

Remark: 1. The setup of EUT is according with per ANSI C63.10:2013 measurement procedure. The specification used was with the FCC 15.207 limits.

Notes: The EUT is powered by DC 3V from battery without AC mains, this test is not applicable..

5. BAND EDGES MEASUREMENT

5.1 Limit of Band Edges Measurement

1. In the above emission table, the tighter limit applies at the band edges.
2. As shown in Section 15.35(b), for frequencies above 1000 MHz, the above field strength limits in paragraphs (a) and (b) of this section are based on average limits. However, the peak field strength of any emission shall not exceed the maximum permitted average limits specified above by more than 20 dB under any condition of modulation. For point-to-point operation under paragraph (b) of this section, the peak field strength shall not exceed 2500 millivolts/meter at 3 meters along the antenna azimuth.

Frequency (MHz)	Field Strength ($\mu\text{V}/\text{m}$ at 3-meter)	Field Strength ($\text{dB}\mu\text{V}/\text{m}$ at 3-meter)
30-88	100	40
88-216	150	43.5
216-960	200	46
Above 960	500	54

Note: (1) The tighter limit shall apply at the edge between two frequency bands.

- (2) The emission limits shown in the above table are based on measurement employing a CISPR quasi-peak detector and above 1000MHz are based on measurements employing an average detector.

5.2 EUT Setup

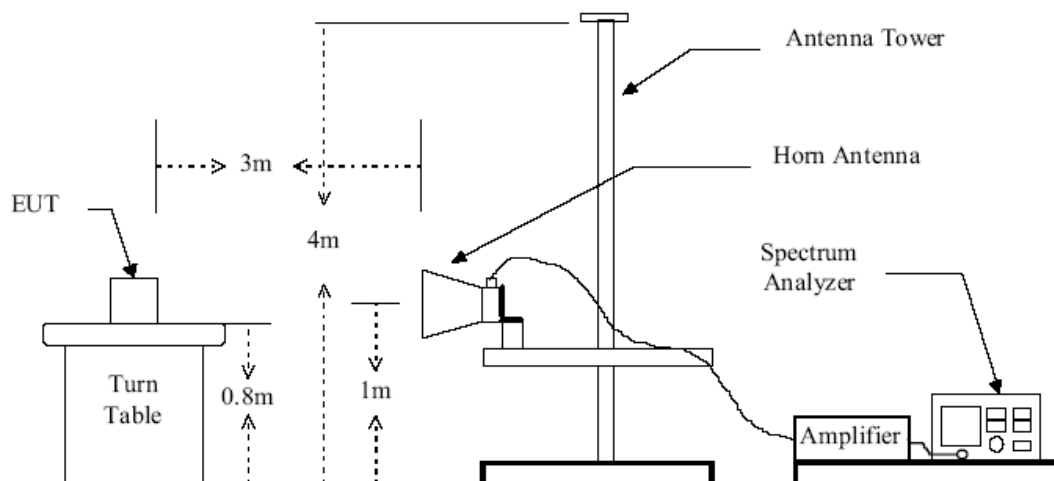

Figure 2 : Frequencies measured above 1 GHz configuration

5.3 Test Procedure

Maximizing procedure was performed on the highest emissions to ensure that the EUT complied with all installation combinations.

- 1). Configure the EUT according to ANSI C63.10:2013.
- 2). The EUT was placed on the top of the turntable 0.8 meter above ground.
- 3). The receiving antenna was placed 3 meters far away from the turntable.
- 4). The turntable was rotated by 360 degrees to determine the position of the highest radiation.
- 5). The height of the broadband receiving antenna was varied between one meter and four meters above ground to find the maximum emission field strength of both horizontal and vertical polarization. For each suspected emission, the antenna tower was scanned (from 1 M to 4 M) and then the turntable was rotated (from 0 degree to 360 degrees) to find the maximum reading.

5.4 Test Result

Temperature (°C) : 22~23	EUT: Goldtouch Wireless Mouse
Humidity (%RH) : 50~54	M/N: KOV-GTM-100W
Barometric Pressure (mbar) : 950~1000	Operation Condition: Continuous transmitting

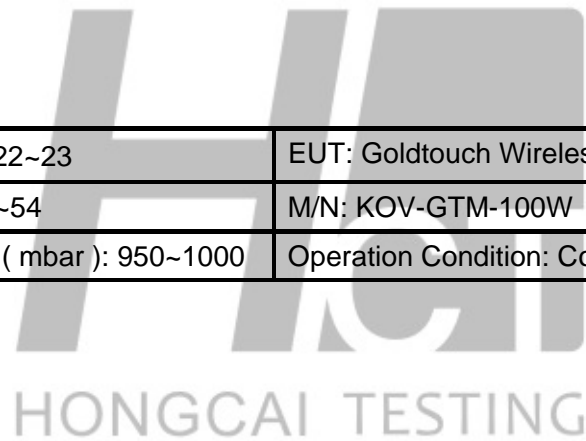

Low Channel (2.406GHz):

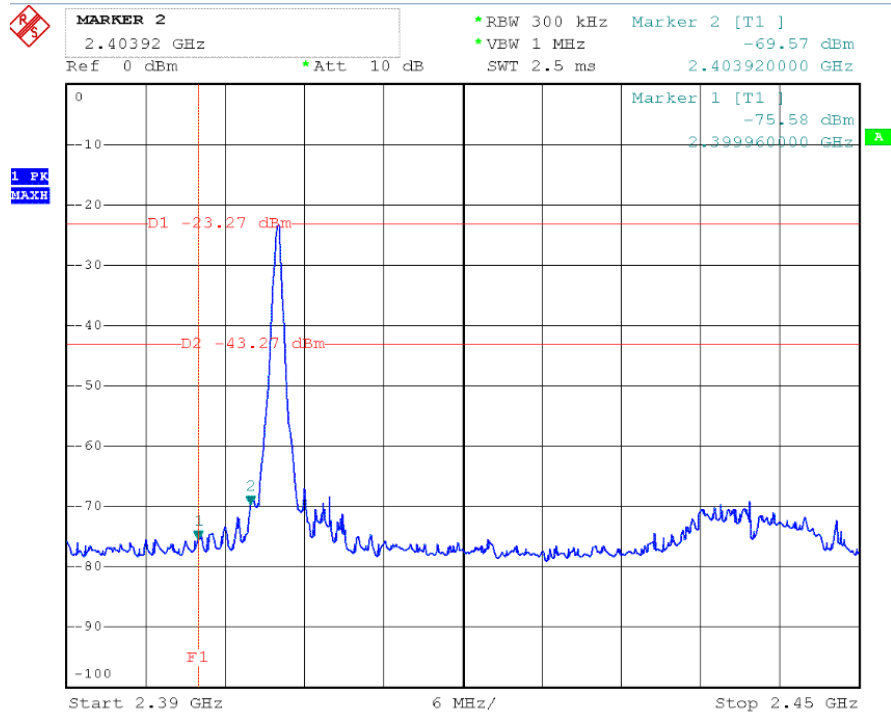

High Channel (2.476GHz):

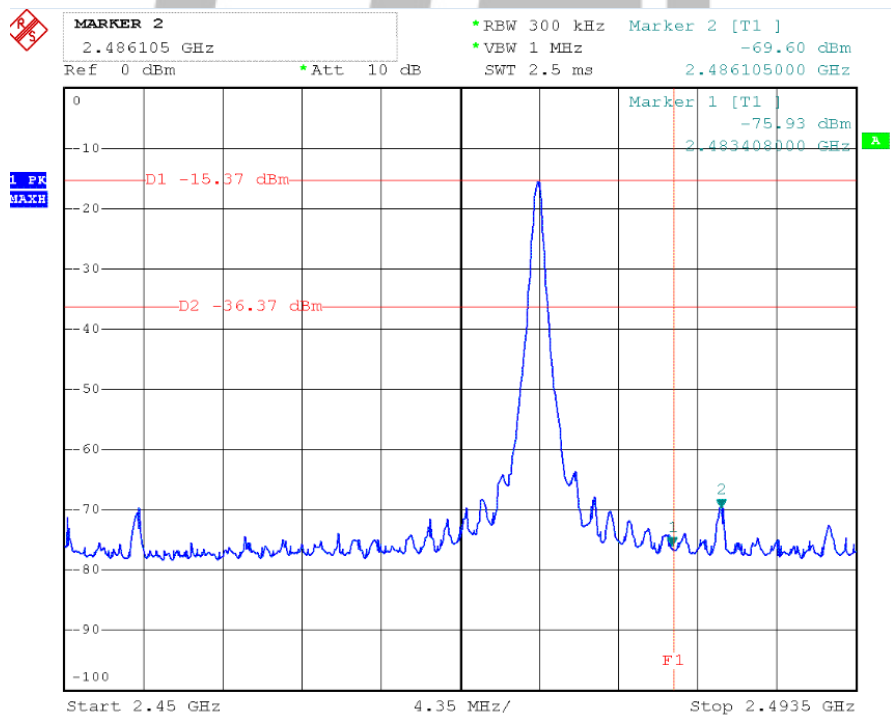

6. SPURIOUS EMISSIONS

6.1 Limit of Spurious Emissions

1. In the section 15.249(a): Except as provided in paragraph (b) of this section, the field strength of emissions from intentional radiators operated within these frequency bands shall comply with the following:
2. Except as provided elsewhere in this Subpart, the emissions from an intentional radiator shall not exceed the field strength levels specified in the following table:

Fundamental Frequency (MHz)	Field Strength of Fundamental Field Strength (mV/m)	Field Strength of Harmonics ($\mu\text{V/m}$)
902-928 MHz	50	500
2400 - 2483.5 MHz	50	500
5725 - 5875 MHz	50	500
24.0 - 24.25 GHz	250	2500

Frequency (MHz)	Field Strength ($\mu\text{V/m}$)	Measurement Distance (m)
30-88	100*	3
88-216	150*	3
216-960	200*	3
Above 960	500	3

Remark: Except as provided in paragraph (g), fundamental emissions from intentional radiators operating under this Section shall not be located in the frequency bands 54-72 MHz, 76-88 MHz, 174-216 MHz or 470-806 MHz. However, operation within these frequency bands is permitted under other sections of this Part, e.g., Sections 15.231 and 15.241.

3. In the above emission table, the tighter limit applies at the band edges.

Frequency (MHz)	Field Strength ($\mu\text{V/m}$ at 3-meter)	Field Strength (dB $\mu\text{V/m}$ at 3-meter)
30-88	100	40
88-216	150	43.5
216-960	200	46
Above 960	500	54

6.2 EUT Setup

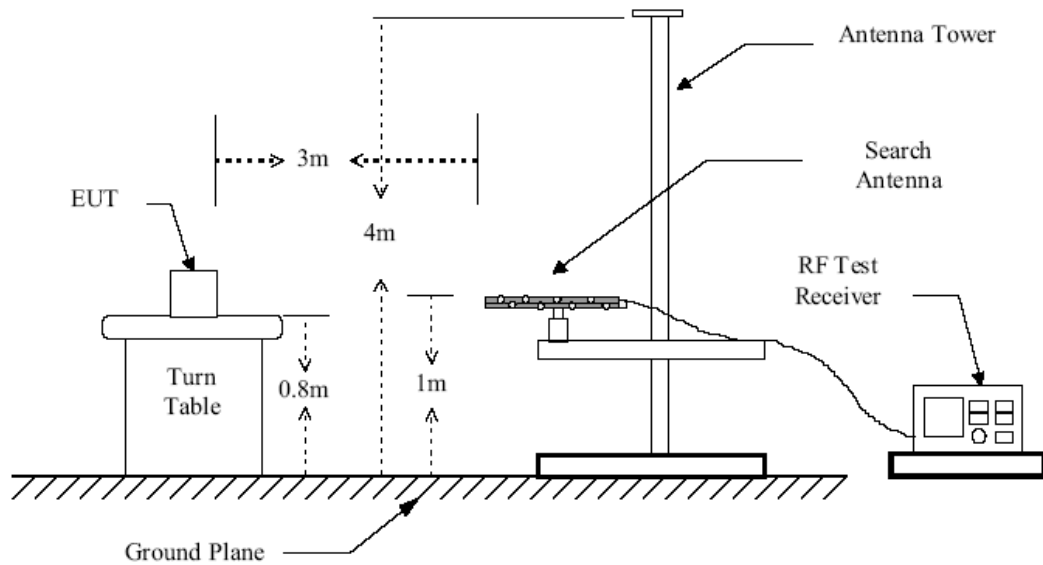

Figure 1 : Frequencies measured below 1 GHz configuration

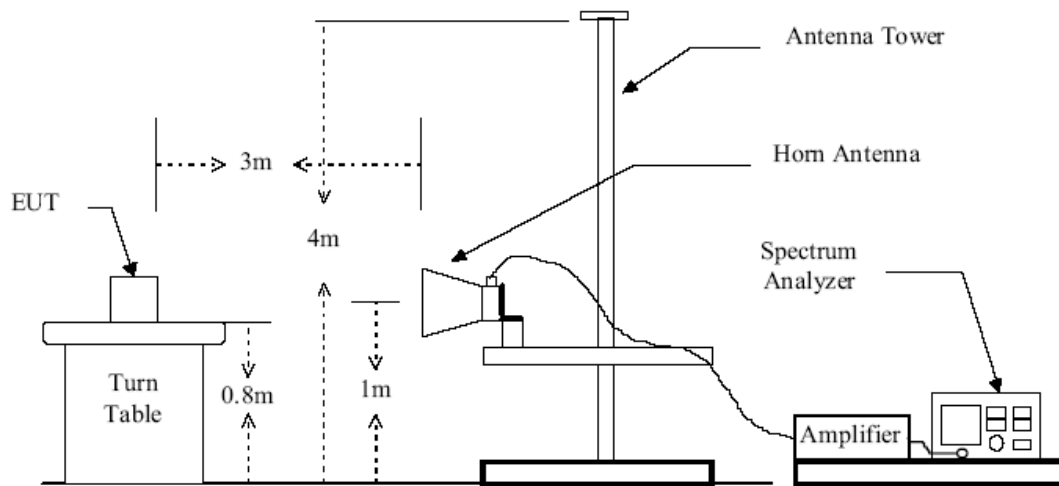

Figure 2 : Frequencies measured above 1 GHz configuration

6.3 Test Procedure

Maximizing procedure was performed on the highest emissions to ensure that the EUT complied with all installation combinations.

- 1). Configure the EUT according to ANSI C63.10:2013
- 2). The EUT was placed on the top of the turntable 0.8 meter above ground.
- 3). The receiving antenna was placed 3 meters far away from the turntable.
- 4). The turntable was rotated by 360 degrees to determine the position of the highest radiation.
- 5). The height of the broadband receiving antenna was varied between one meter and four meters above ground to find the maximum emission field strength of both horizontal and vertical polarization. For each suspected emission, the antenna tower was scanned (from 1 M to 4 M) and then the turntable was rotated (from 0 degree to 360 degrees) to find the maximum reading.

6.4 Spurious Emissions Test Result

Temperature (°C) : 22~23	EUT: Goldtouch Wireless Mouse
Humidity (%RH) : 50~54	M/N: KOV-GTM-100W
Barometric Pressure (mbar) : 950~1000	Operation Condition: Continuous transmitting

HONGCAI TESTING

RADIATED EMISSION BELOW 30 MHz

(CH Low) operating Mode:2406MHz

Frequency	Meter Reading	Antenna Factor	Cable Loss	Emission Levels	Limits	Margin	Detector Mode
(MHz)	(dB μ V)	(dB/M)	(dB)	(dB μ V/M)	(dB μ V/M)	(dB)	PK/QP
5.39	21.98	8.24	1.03	31.25	72.9	-38.65	QP
17.25	21.14	9.36	1.08	31.58	69.5	-37.92	QP
24.36	20.69	9.24	1.06	30.99	69.5	-38.51	QP
28.21	24.21	9.12	1.09	34.42	69.5	-35.08	QP

(CH Middle) operating Mode:2447MHz

Frequency	Meter Reading	Antenna Factor	Cable Loss	Emission Levels	Limits	Margin	Detector Mode
(MHz)	(dB μ V)	(dB/M)	(dB)	(dB μ V/M)	(dB μ V/M)	(dB)	PK/QP
5.02	22.88	8.26	1.01	32.15	73.5	-41.35	QP
16.89	20.13	9.19	1.06	30.38	69.5	-39.12	QP
23.68	20.36	9.18	1.07	30.61	69.5	-38.89	QP
27.13	23.69	9.10	1.04	33.83	69.5	-35.67	QP

(CH High) operating Mode:2476MHz

Frequency	Meter Reading	Antenna Factor	Cable Loss	Emission Levels	Limits	Margin	Detector Mode
(MHz)	(dB μ V)	(dB/M)	(dB)	(dB μ V/M)	(dB μ V/M)	(dB)	PK/QP
5.31	21.31	8.15	1.06	30.52	73.1	-42.58	QP
17.25	20.69	9.30	1.05	31.04	69.5	-38.46	QP
21.65	20.48	9.02	1.06	30.56	69.5	-38.94	QP
29.32	23.41	9.14	1.04	33.59	69.5	-35.91	QP

Low channel:2406MHz
The worst Spurious Emission Data Below 1GHz:

EUT: Goldtouch Wireless Mouse
M/N: KOV-GTM-100W
Operating Condition: Continuous transmitting
Test Site: 3m CHAMBER
Operator: Chen
Test Specification: DC 3V
Comment: Polarization: Horizontal

SWEEP TABLE: "test (30M-1G)"

Short Description:		Field Strength			
Start	Stop	Detector	Meas.	IF	Transducer
Frequency	Frequency		Time	Bandw.	
30.0 MHz	1.0 GHz	MaxPeak	Coupled	100 kHz	9163-2015

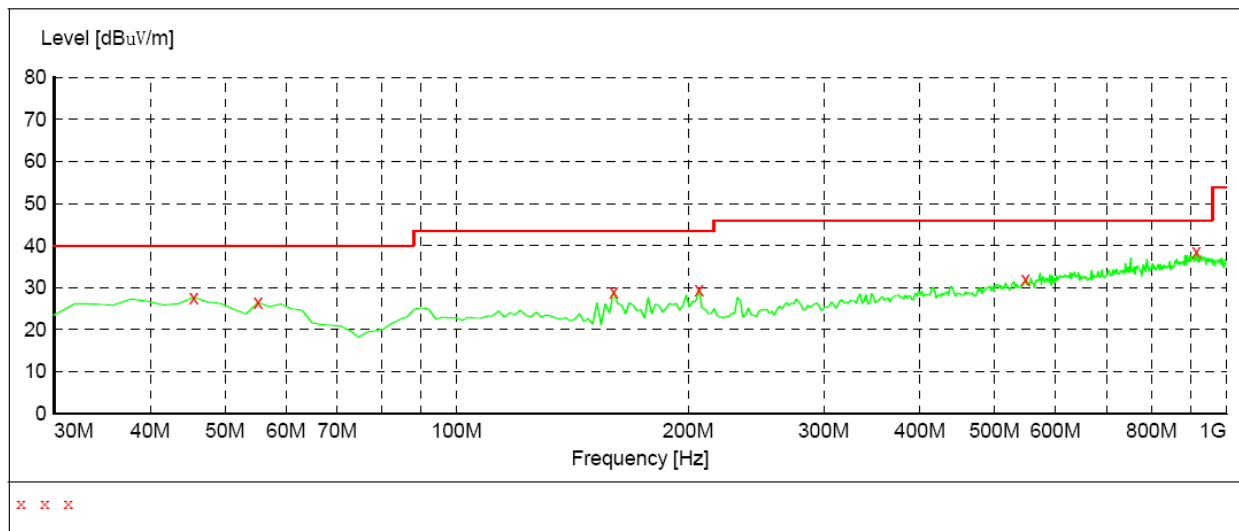

MEASUREMENT RESULT:

Frequency MHz	Level dBuV/m	Transd dB	Limit dBuV/m	Margin dB	Det.	Height cm	Azimuth deg	Polarization
45.520000	27.70	16.8	40.0	12.3	QP	300.0	0.00	HORIZONTAL
55.220000	26.40	15.1	40.0	13.6	QP	100.0	0.00	HORIZONTAL
159.980000	29.00	12.9	43.5	14.5	QP	100.0	0.00	HORIZONTAL
206.540000	29.40	14.1	43.5	14.1	QP	100.0	0.00	HORIZONTAL
547.980000	31.90	20.3	46.0	14.1	QP	100.0	0.00	HORIZONTAL
914.640000	38.50	25.8	46.0	7.5	QP	100.0	0.00	HORIZONTAL

The worst Spurious Emission Data Below 1GHz:

EUT: Goldtouch Wireless Mouse
M/N: KOV-GTM-100W
Operating Condition: Continuous transmitting
Test Site: 3m CHAMBER
Operator: Chen
Test Specification: DC 3V
Comment: Polarization: Vertical

SWEEP TABLE: "test (30M-1G)"

Short Description:		Field Strength			
Start	Stop	Detector	Meas. Time	IF Bandw.	Transducer
Frequency 30.0 MHz	Frequency 1.0 GHz	MaxPeak	Coupled	100 kHz	9163-2015

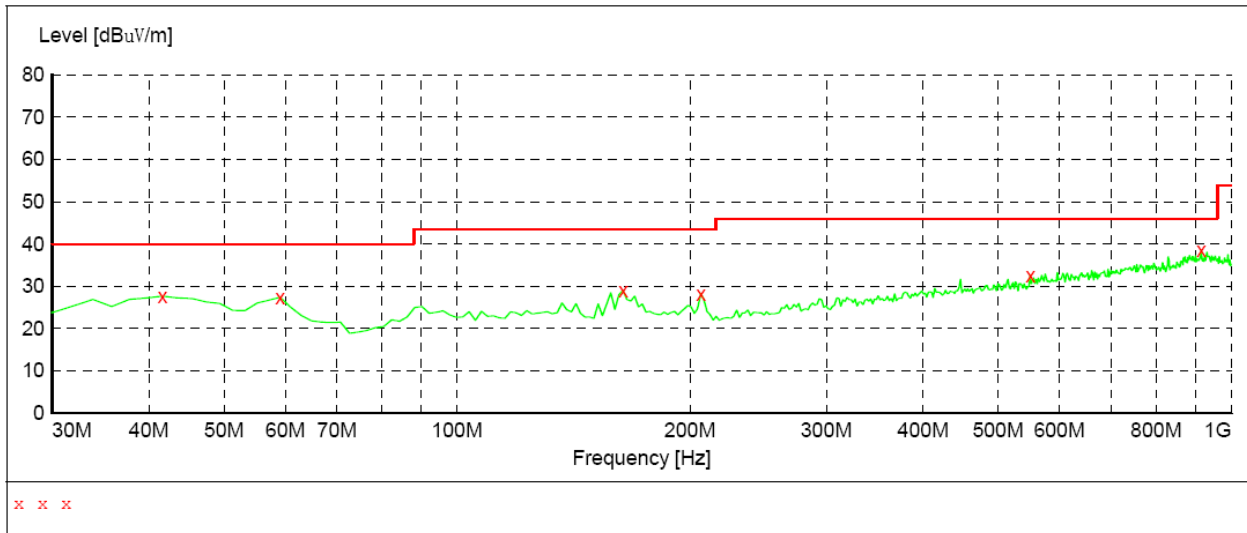

MEASUREMENT RESULT:

Frequency MHz	Level dBuV/m	Transd dB	Limit dBuV/m	Margin dB	Det.	Height cm	Azimuth deg	Polarization
41.640000	27.70	15.4	40.0	12.3	QP	100.0	0.00	VERTICAL
59.100000	27.40	15.7	40.0	12.6	QP	100.0	0.00	VERTICAL
163.860000	29.00	12.9	43.5	14.5	QP	100.0	0.00	VERTICAL
206.540000	28.30	14.1	43.5	15.2	QP	100.0	0.00	VERTICAL
549.920000	32.60	20.5	46.0	13.4	QP	100.0	0.00	VERTICAL
914.640000	38.60	25.8	46.0	7.4	QP	100.0	0.00	VERTICAL

Middle channel:2447MHz

The worst Spurious Emission Data Below 1GHz:

EUT: Goldtouch Wireless Mouse
M/N: KOV-GTM-100W
Operating Condition: Continuous transmitting
Test Site: 3m CHAMBER
Operator: Chen
Test Specification: DC 3V
Comment: Polarization: Horizontal

SWEEP TABLE: "test (30M-1G)"

Short Description:		Field Strength			
Start Frequency	Stop Frequency	Detector	Meas. Time	IF Bandw.	Transducer
30.0 MHz	1.0 GHz	MaxPeak	Coupled	100 kHz	9163-2015

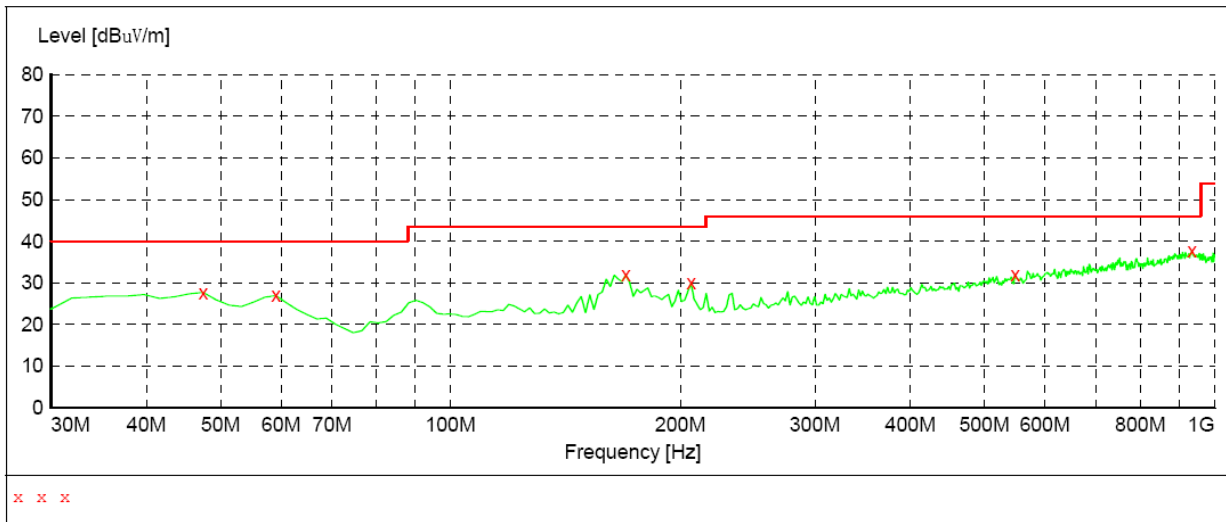

MEASUREMENT RESULT:

Frequency MHz	Level dBuV/m	Transd dB	Limit dBuV/m	Margin dB	Det.	Height cm	Azimuth deg	Polarization
47.460000	27.70	16.7	40.0	12.3	QP	100.0	0.00	HORIZONTAL
59.100000	27.00	15.7	40.0	13.0	QP	300.0	0.00	HORIZONTAL
169.680000	31.90	12.6	43.5	11.6	QP	100.0	0.00	HORIZONTAL
206.540000	29.90	14.1	43.5	13.6	QP	100.0	0.00	HORIZONTAL
547.980000	32.00	20.3	46.0	14.0	QP	100.0	0.00	HORIZONTAL
934.040000	37.70	25.7	46.0	8.3	QP	100.0	0.00	HORIZONTAL

The worst Spurious Emission Data Below 1GHz:

EUT: Goldtouch Wireless Mouse
 M/N: KOV-GTM-100W
 Operating Condition: Continuous transmitting
 Test Site: 3m CHAMBER
 Operator: Chen
 Test Specification: DC 3V
 Comment: Polarization: Vertical

SWEEP TABLE: "test (30M-1G)"

Short Description:		Field Strength			
Start	Stop	Detector	Meas. Time	IF Bandw.	Transducer
Frequency	Frequency				
30.0 MHz	1.0 GHz	MaxPeak	Coupled	100 kHz	9163-2015

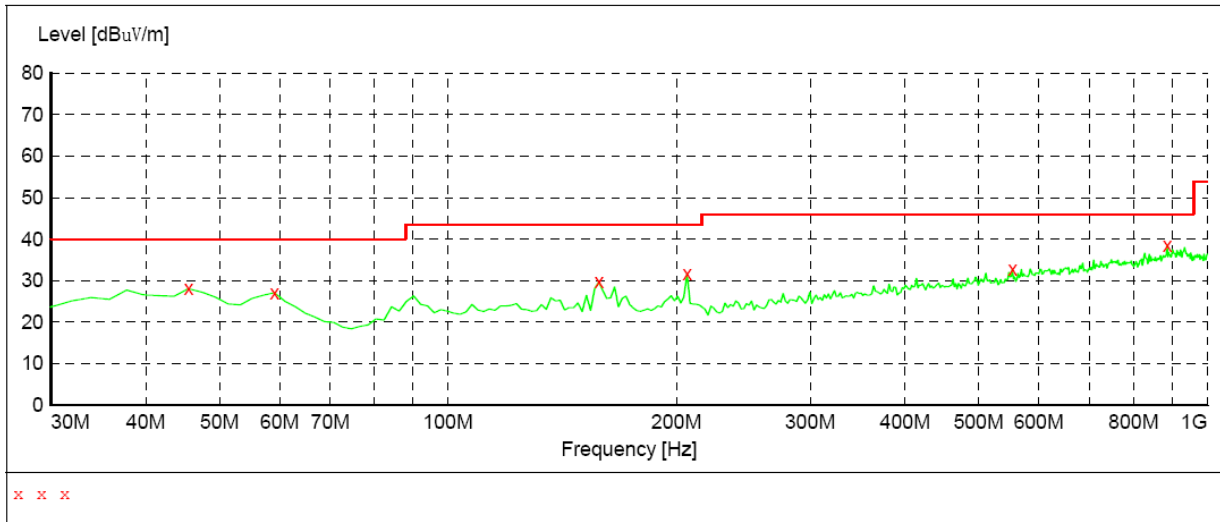

MEASUREMENT RESULT:

Frequency MHz	Level dBuV/m	Transd dB	Limit dBuV/m	Margin dB	Det.	Height cm	Azimuth deg	Polarization
45.520000	28.10	16.8	40.0	11.9	QP	100.0	0.00	VERTICAL
59.100000	27.10	15.7	40.0	12.9	QP	100.0	0.00	VERTICAL
158.040000	29.70	12.3	43.5	13.8	QP	100.0	0.00	VERTICAL
206.540000	31.70	14.1	43.5	11.8	QP	100.0	0.00	VERTICAL
553.800000	32.70	20.4	46.0	13.3	QP	100.0	0.00	VERTICAL
885.540000	38.60	25.4	46.0	7.4	QP	100.0	0.00	VERTICAL

High channel:2476MHz

The worst Spurious Emission Data Below 1GHz:

EUT: Goldtouch Wireless Mouse
M/N: KOV-GTM-100W
Operating Condition: Continuous transmitting
Test Site: 3m CHAMBER
Operator: Chen
Test Specification: DC 3V
Comment: Polarization: Horizontal

SWEEP TABLE: "test (30M-1G)"

Short Description:		Field Strength			
Start	Stop	Detector	Meas. Time	IF Bandw.	Transducer
30.0 MHz	1.0 GHz	MaxPeak	Coupled	100 kHz	9163-2015

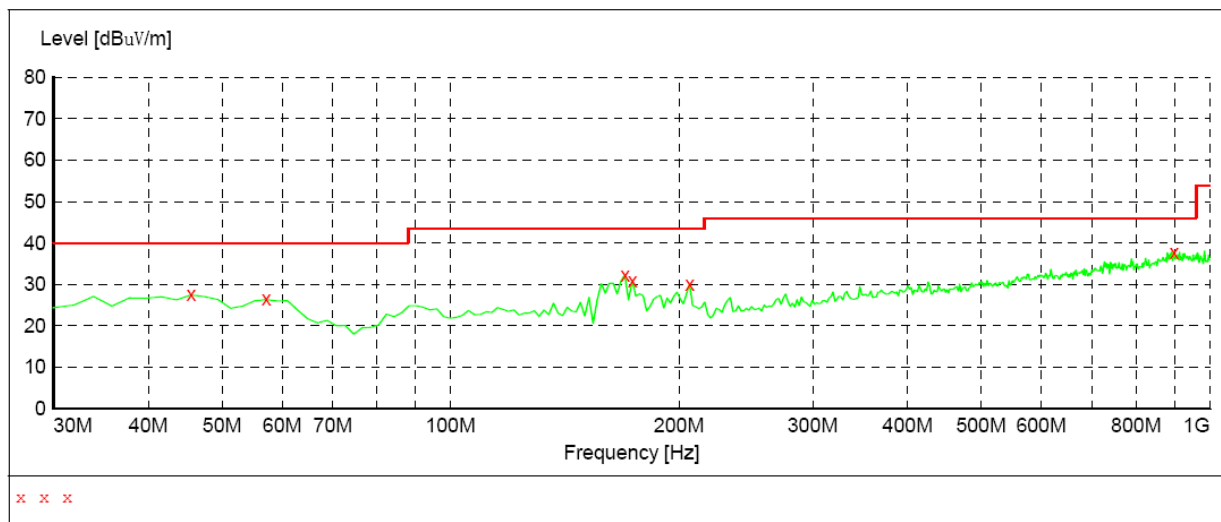

MEASUREMENT RESULT:

Frequency MHz	Level dBuV/m	Transd dB	Limit dBuV/m	Margin dB	Det.	Height cm	Azimuth deg	Polarization
45.520000	27.50	16.8	40.0	12.5	QP	300.0	0.00	HORIZONTAL
57.160000	26.40	15.7	40.0	13.6	QP	300.0	0.00	HORIZONTAL
169.680000	32.30	12.6	43.5	11.2	QP	100.0	0.00	HORIZONTAL
173.560000	31.00	12.4	43.5	12.5	QP	100.0	0.00	HORIZONTAL
206.540000	30.00	14.1	43.5	13.5	QP	100.0	0.00	HORIZONTAL
897.180000	37.80	25.7	46.0	8.2	QP	100.0	0.00	HORIZONTAL

The worst Spurious Emission Data Below 1GHz:

EUT: Goldtouch Wireless Mouse
M/N: KOV-GTM-100W
Operating Condition: Continuous transmitting
Test Site: 3m CHAMBER
Operator: Chen
Test Specification: DC 3V
Comment: Polarization: Vertical

SWEEP TABLE: "test (30M-1G)"

Short Description:		Field Strength			
Start	Stop	Detector	Meas. Time	IF Bandw.	Transducer
30.0 MHz	1.0 GHz	MaxPeak	Coupled	100 kHz	9163-2015

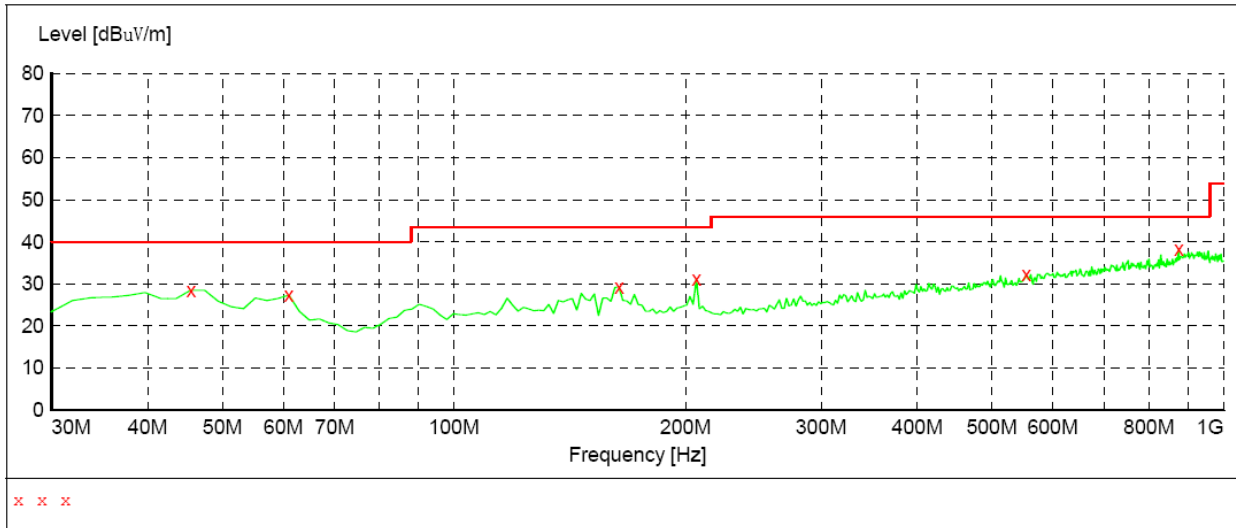

MEASUREMENT RESULT:

Frequency MHz	Level dBuV/m	Transd dB	Limit dBuV/m	Margin dB	Det.	Height cm	Azimuth deg	Polarization
45.520000	28.50	16.8	40.0	11.5	QP	100.0	0.00	VERTICAL
61.040000	27.30	14.9	40.0	12.7	QP	100.0	0.00	VERTICAL
163.860000	29.20	12.9	43.5	14.3	QP	100.0	0.00	VERTICAL
206.540000	31.20	14.1	43.5	12.3	QP	100.0	0.00	VERTICAL
553.800000	32.10	20.4	46.0	13.9	QP	100.0	0.00	VERTICAL
873.900000	38.10	25.1	46.0	7.9	QP	100.0	0.00	VERTICAL

RADIATED EMISSION ABOVE 1 GHz

CH Low

Channel Low (2406MHz)								
Maximum Frequency (MHz)	Polarity and Level					Limit (dB μ V/m)	Margin (dB μ V/m)	Mark (P/Q/A)
	Polarity	Height (m)	Reading dB μ V	Transd	Result dB μ V/m			
1380.66	H	1	47.52	-7.17	40.35	74	-33.65	P
			32.54	-7.17	25.37	54	-28.63	A
1380.22	V	1	49.12	-7.17	41.95	74	-32.05	P
			32.15	-7.17	24.98	54	-29.02	A
2406	H	1	99.68	-5.67	94.01	114	-19.99	P
			78.61	-5.67	72.94	94	-24.06	A
2406	V	1	101.25	-5.67	95.58	114	-18.42	P
			95.25	-5.67	89.58	94	-4.42	A
4812	H	1	40.21	1.32	41.53	74	-32.47	P
			32.25	1.32	33.57	54	-20.43	A
4812	V	1	39.21	1.32	40.53	74	-33.47	P
			31.26	1.32	32.58	54	-21.42	A
7218	H	1	46.28	8.21	54.49	74	-19.51	P
			31.26	8.21	39.47	54	-14.53	A
7218	V	1	41.36	8.21	49.57	74	-24.43	P
			35.24	8.21	43.45	54	-10.55	A
11145.34	H	1	----	----	----	----	----	----
16327.65	----	----	----	----	----	----	----	----
25376.32	----	----	----	----	----	----	----	----

Remark: 1. Transd=Antenna Factor + Cable Loss - Pre-amplifier
Margin = Level-Limit
Mark: P means Peak Value, Q means Quasi Peak Value, A means Average Value
2. Data of measurement within this frequency range shown " - " in the table above means the reading of emissions are attenuated more than 20dB below the permissible limits or the field strength is too small to be measured.
3. Spectrum analyzer setting P(Peak): RBW=1MHz, VBW=3MHz, A(Average): RBW=1MHz, VBW=3MHz.
4. The test limit distance is 3m limit

CH Middle

Channel Middle (2447MHz)								
Maximum Frequency (MHz)	Polarity and Level					Limit (dBµV/m)	Margin (dBµV/m)	Mark (P/Q/A)
	Polarity	Height (m)	Reading dBµV	Transd	Result dBµV/m			
1326.33	H	1	46.22	-7.18	39.04	74	-34.96	P
			33.21	-7.18	26.03	54	-27.97	A
1326.22	V	1	46.21	-7.18	39.03	74	-34.97	P
			33.11	-7.18	25.93	54	-28.07	A
2447	H	1	97.65	-5.68	91.97	114	-22.03	P
			72.31	-5.68	66.63	94	-27.37	A
2447	V	1	102.31	-5.68	96.63	114	-17.37	P
			95.31	-5.68	89.63	94	-4.37	A
4894	H	1	39.21	1.31	40.52	74	-33.48	P
			30.15	1.31	31.46	54	-22.54	A
4894	V	1	37.26	1.31	38.57	74	-35.43	P
			33.11	1.31	34.42	54	-19.58	A
7341	H	1	44.26	8.2	52.46	74	-21.54	P
			30.15	8.2	38.35	54	-15.65	A
7341	V	1	42.31	8.2	50.51	74	-23.49	P
			34.26	8.2	42.46	54	-11.54	A
11238.52	H	1	----	----	----	----	----	----
16327.71	----	----	----	----	----	----	----	----
25376.58	----	----	----	----	----	----	----	----

Remark: 1. Transd=Antenna Factor + Cable Loss - Pre-amplifier
Margin = Level-Limit
Mark: P means Peak Value, Q means Quasi Peak Value, A means Average Value
2. Data of measurement within this frequency range shown " - " in the table above means the reading of emissions are attenuated more than 20dB below the permissible limits or the field strength is too small to be measured.
3. Spectrum analyzer setting P(Peak): RBW=1MHz, VBW=3MHz, A(Average): RBW=1MHz, VBW=3MHz.
4. The test limit distance is 3m limit

(CH High)

Channel High (2476MHz)								
Maximum Frequency (MHz)	Polarity and Level					Limit (dB μ V/m)	Margin (dB μ V/m)	Mark (P/Q/A)
	Polarity	Height (m)	Reading dB μ V	Transd	Result dB μ V/m			
1312.66	H	1	47.23	-8.77	38.46	74	-35.54	P
			34.21	-8.77	25.44	54	-28.56	A
1311.67	V	1	48.12	-8.77	39.35	74	-34.65	P
			36.21	-8.77	27.44	54	-26.56	A
2476	H	1	103.11	-6.82	96.29	114	-17.71	P
			93.23	-6.82	86.41	94	-7.59	A
2476	V	1	96.31	-6.82	89.49	114	-24.51	P
			94.25	-6.82	87.43	94	-6.57	A
4952	H	1	42.21	0.43	42.64	74	-31.36	P
			32.61	0.43	33.04	54	-20.96	A
4952	V	1	48.21	0.43	48.64	74	-25.36	P
			32.65	0.43	33.08	54	-20.92	A
7428	H	1	41.89	7.02	48.91	74	-25.09	P
			30.63	7.02	37.65	54	-16.35	A
7428	V	1	41.28	7.02	48.3	74	-25.70	P
			31.29	7.02	38.31	54	-15.69	A
11243.58	H	1	----	----	----	----	----	----
			----	----	----	----	----	----
16327.45	----	----	----	----	----	----	----	----
25376.26	----	----	----	----	----	----	----	----

Remark: 1. Transd=Antenna Factor + Cable Loss - Pre-amplifier
Margin = Level-Limit
Mark: P means Peak Value, Q means Quasi Peak Value, A means Average Value
2. Data of measurement within this frequency range shown " - " in the table above means the reading of emissions are attenuated more than 20dB below the permissible limits or the field strength is too small to be measured.
3. Spectrum analyzer setting P(Peak): RBW=1MHz, VBW=3MHz,
A(Average): RBW=1MHz, VBW=3MHz.
4. The test limit distance is 3m limit

7. 20DB BANDWIDTH

7.1. Limits

Intentional radiators operating under the alternative provisions to the general emission limits, as contained in §§ 15.217 through 15.257 and in Subpart E of this part, must be designed to ensure that the 20 dB bandwidth of the emission, or whatever bandwidth may otherwise be specified in the specific rule section under which the equipment operates, is contained within the frequency band designated in the rule section under which the equipment is operated.

7.2. Test setup

1. Set the RBW =30kHz.
2. Set the VBW = 100kHz
3. Span=3MHz
4. Detector = peak.
5. Sweep time = auto couple.
6. Allow trace to fully stabilize, and view the plot.
7. Measure and record the result in the test report.

7.3 Test Result

Channel	Channel Frequency (MHz)	20dB Bandwidth (MHz)	Pass / Fail
Low	2406	0.112	PASS
Middle	2447	0.108	PASS
High	2476	0.084	PASS

Test plot as follows:

Low Channel:

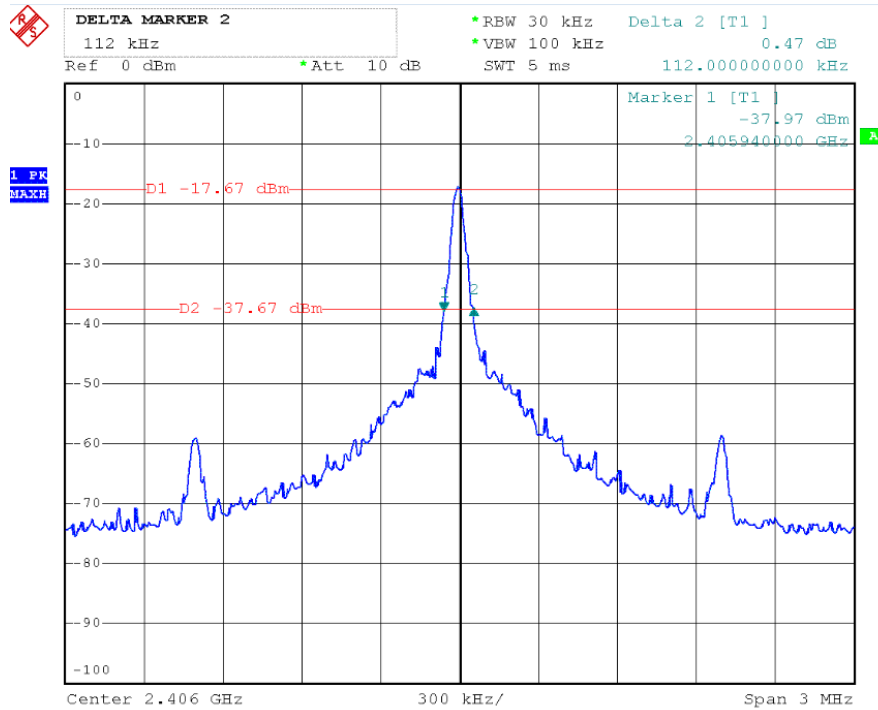

Middle Channel:

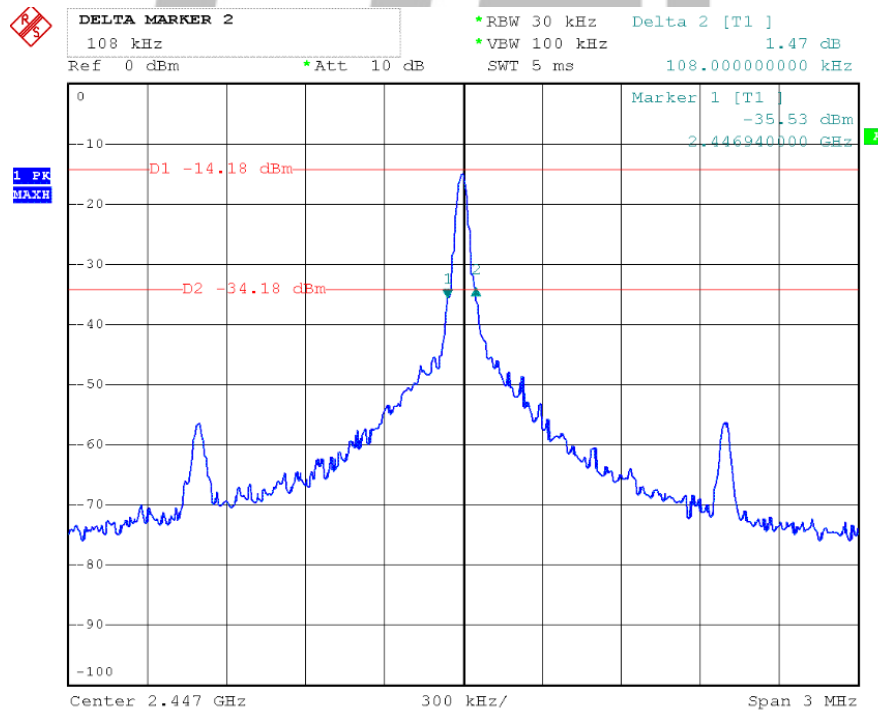

High Channel:

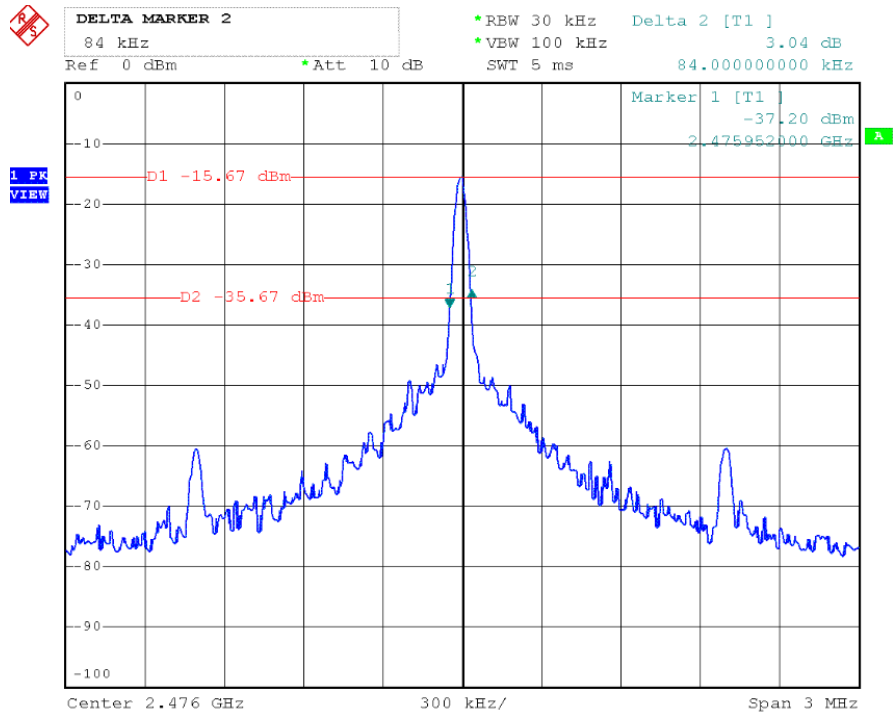

8. ANTENNA REQUIREMENT

8.1 Standard Applicable

Section 15.203:

An intentional radiator shall be designed to ensure that no antenna other than that furnished by the responsible party shall be used with the device. The use of a permanently attached antenna or of an antenna that uses a unique coupling to the intentional radiator shall be considered sufficient to comply with the provisions of this Section. The manufacturer may design the unit so that a broken antenna can be replaced by the user, but the use of a standard antenna jack or electrical connector is prohibited.

8.2 Antenna Connected Construction

The antenna connector is designed with permanent attachment and no consideration of replacement.

