

ELECTRONIC SNAP CIRCUITS™

RC SNAP ROVER™

Projects 1-23



Instruction Manual



Elenco® Electronics, Inc.

Table of Contents

Basic Troubleshooting.....	1
Parts List	2
How to Use It	3
About Your Snap Circuits Parts.....	4
How It Works.....	5, 6
General Operating Instructions.....	6
DO's and DON'Ts of Building Circuits.....	7
Advanced Troubleshooting.....	8
Project 1.....	9
Project 2.....	10
Projects 3, 4.....	11
Projects 5, 6.....	12
Project 7, 8.....	13
Projects 9, 10.....	14
Projects 11, 12.....	15
Projects 13, 14.....	16
Projects 15, 16.....	17
Projects 17, 18.....	18
Project 19, 20.....	19
Projects 21-23.....	20
Other Snap Circuits Products.....	21
Bonus Projects B1-B3.....	22



WARNING: SHOCK HAZARD - Never connect Snap Circuits to the electrical outlets in your home in any way!

Basic Troubleshooting

1. Most circuit problems are due to incorrect assembly, always double-check that your circuit exactly matches the drawing for it.
2. Be sure that parts with positive/negative markings are positioned as per the drawing.
3. Be sure that all connections are securely snapped.
4. Try replacing the batteries in the Rover body and remote control unit.
5. Keep the wheels clean and free of lint, thread, or dirt.

Elenco® Electronics is not responsible for parts damaged due to incorrect wiring.

Note: If you suspect you have damaged parts, you can follow the Advanced Troubleshooting procedure on page 8 to determine which ones need replacing.

WARNING: Always check your wiring before turning on a circuit. Never leave a circuit unattended while the batteries are installed. Never connect additional batteries or any other power sources to your circuits.

BATTERIES:

Use only 1.5V AA type in the Rover body and 9V in the remote control (not included). Insert batteries with correct polarity. Non-rechargeable batteries should not be recharged. Rechargeable batteries should only be charged under adult supervision, and should not be recharged while in the product. Do not mix alkaline, standard (carbon-zinc), or rechargeable (nickel-cadmium) batteries. Remove batteries when they are used up. Do not short circuit the battery terminals. Never throw batteries in a fire or attempt to open its outer casing. Batteries are harmful if swallowed, so keep away from small children.

























Warning to Snap Circuits Owners: Do not use parts from other Snap Circuits sets with this kit. The Snap Rover uses higher voltage which could damage those parts. Page 22 and our web site www.snapcircuits.net has approved circuits that you can use.

Parts List (Colors and styles may vary) Symbols and Numbers

Note: If you have a more advanced model, there are additional part lists in the other project manuals.

Important: If any parts are missing or damaged, **DO NOT RETURN TO RETAILER.** Call toll-free (800) 533-2441 or e-mail us at: help@elenco.com. Customer Service • 150 Carpenter Ave. • Wheeling, IL 60090 U.S.A.

Qty.	ID	Name	Symbol	Part #	Qty.	ID	Name	Symbol	Part #
□ 1		Rover Body		6SCRB	□ 2	Ⓒ5	470μF Capacitor		6SCC5
□ 1		Remote Control Unit Antenna		6SCTX1 6SCTX1A	□ 1	Ⓓ4	White LED		6SCD4
□ 1		Base Grid (11.0" x 7.7")		6SCBG	□ 1	Ⓓ1	100Ω Resistor		6SCR1
□ 2	①	1-Snap Wire		6SC01	□ 4	Ⓓ2	1KΩ Resistor		6SCR2
□ 6	②	2-Snap Wire		6SC02	□ 1	ⒹX1	R/C Receiver		6SCRX1
□ 2	③	3-Snap Wire		6SC03	□ 1	ⒹS1	Slide Switch		6SCS1
□ 1	④	4-Snap Wire		6SC04	□ 1	ⒹU8	Motor Control IC		6SCU8
□ 1	⑤	5-Snap Wire		6SC05	□ 1	ⒹW1	Horn		6SCW1
□ 1	⑥	6-Snap Wire		6SC06	□ 1 □ 1 □ 1	Note: Colors may vary and are interchangeable.	Jumper Wire (Orange)		6SCJ3A
					Jumper Wire (Yellow)			6SCJ3B	
					Jumper Wire (Green)			6SCJ3C	
□ 1	⑦	7-Snap Wire		6SC07	□ 1 □ 1 □ 1		Jumper Wire (Purple)		6SCJ3D
							Jumper Wire (Gray)		6SCJ3E
							Jumper Wire (White)		6SCJ3F
□ 1	Ⓒ1	0.02μF Capacitor		6SCC1	□ 1		Decorative Decal		721053

You may order additional / replacement parts at our web site: www.snapcircuits.net

How To Use It

Install six "AA" batteries (not included) into the bottom of the Rover body and one 9V battery (not included) into the remote control unit. Install the antenna into the remote control unit by screwing it in.

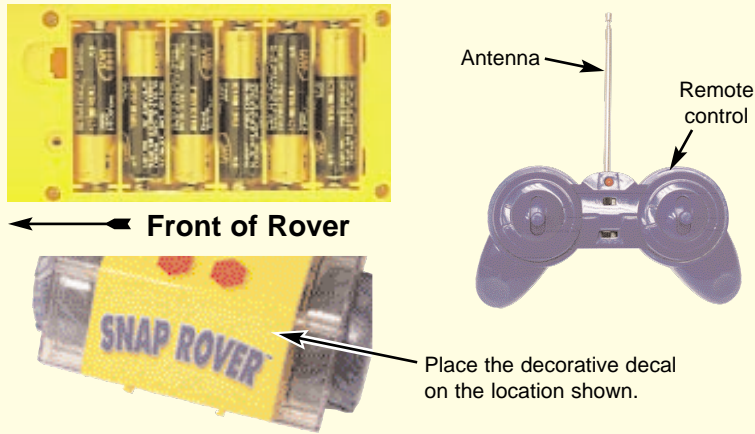

The R/C Snap Rover Kit uses building blocks with snaps to build the different electrical and electronic circuits in the projects. Each block has a function: there are switch blocks, LED blocks, different length wire blocks, etc. These blocks are in different colors and have numbers on them so that you can easily identify them. The circuit you will build is shown in color and numbers, identifying the blocks that you will use and snap together to form a circuit.

For Example:

This is the switch block which is green and has the marking **S1** on it.



This is a wire block which is blue and offers 7 wire lengths. This one has the number 2 on it depending on the length of the wire connection required.

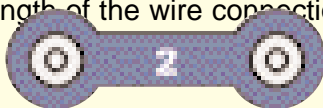

There is also a 1-snap wire that is used as a spacer or for interconnection between different layers.



A large clear plastic base grid is included with this kit to keep the circuit blocks together, it fits on top of the Rover body. You will see evenly spaced posts that the different blocks snap into, these keep your circuit together. The base has rows labeled A-G and columns labeled 1-10.

Next to each part in every circuit drawing is a small number in black. This tells you which level the component is placed at. Place all parts on level 1 first, then all of the parts on level 2, then all of the parts on level 3, etc.

Jumper wires are used to connect your circuits to the batteries and motors in the Rover body. Snap them on as shown in the projects. The colors are interchangeable, so it doesn't matter which color you use.

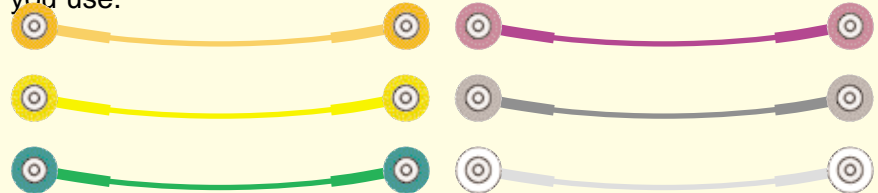

Note: While building the projects, be careful not to accidentally make a direct electrical connection across the + and - snaps for the batteries (a "short circuit"), as this may damage and/or quickly drain the batteries.

Warning to Snap Circuits owners: Do not use parts from other Snap Circuits sets with this kit unless directed to do so. The Snap Rover uses higher voltage which could damage those parts. Page 22 and our web site www.snapcircuits.net has approved circuits that you can use.

About Your Snap Circuits Parts



Warning to Snap Circuits owners: Do not use parts from other Snap Circuits sets with this kit. The Snap Rover uses higher voltage which could damage those parts. Page 22 and our web site www.snapcircuits.net has approved circuits that you can

(Part designs are subject to change without notice).

Note: If you have a more advanced Model, there is additional information in your other project manual(s).

The **base grid** functions like the printed circuit boards found in most electronic products. It is a platform for mounting parts and wires (though the wires are usually “printed” on the board).

The blue **snap wires** are just wires used to connect other components, they are used to transport electricity and do not affect circuit performance. They come in different lengths to allow orderly arrangement of connections on the base grid.

The white, orange, yellow, green, gray, and purple **jumper wires** make flexible connections for times when using the snap wires would be difficult. They also are used to make connections off the base grid. The different colored wires all work the same way, and are interchangeable.

The **batteries** (in the Rover body) produce an electrical voltage using a chemical reaction. This “voltage” can be thought of as electrical pressure, pushing electrical “current” through a circuit. This voltage is much lower and much safer than that used in your house wiring. Using more batteries increases the “pressure” and so more electricity flows.

The **slide switch (S1)** connects (ON) or disconnects (OFF) the wires in a circuit. When ON it has no effect on circuit performance.

Resistors, such as the **100Ω resistor (R1)** and **1KΩ resistor (R2)**, “resist” the flow of electricity and are used to control or limit the electricity in a circuit. Increasing circuit resistance reduces the flow of electricity.

The **LED (D4)** is a light emitting diode, and may be thought of as a special one-way light bulb. In the “forward” direction (indicated by the “arrow” in the symbol) electricity flows if the voltage exceeds a turn-on threshold (about 3V); brightness then increases. A high current will burn out the LED, so the current must be limited by other components in the circuit. LEDs block electricity in the “reverse” direction.

The **0.02μF (C1)** and **470μF (C5) capacitors** are components that can store electrical pressure (voltage) for periods of time, higher values have more storage. Because of this storage ability they block unchanging voltage signals and pass fast changing voltages. Capacitors are used for filtering and delay circuits.

The **horn (W1)** converts electricity into sound by making mechanical vibrations. These vibrations create variations in air pressure which travel across the room. You “hear” sound when your ears feel these air pressure variations.

The **R/C Receiver (RX1)** is a complex module containing a radio receiver circuit, a specialized radio decoder integrated circuit, and other supporting components. It includes resistors, capacitors, inductors, and transistors that are always needed together. This was done to simplify the connections you need to make, otherwise this circuitry would not fit on the base grid. A description for this module is given here for those interested, see project 1 for a connection example:

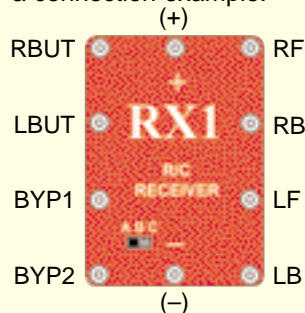

R/C Receiver:

- (+) - power from batteries
- (-) - power return to batteries
- RBUT - right button function (active low)
- LBUT - left button function (active low)
- BYP1 - low frequency bypass
- BYP2 - high frequency bypass
- RF - right forward output (active high)
- RB - right backward output (active high)
- LF - left forward output (active high)
- LB - left backward output (active high)
- ABC switch - selects radio channel



Only connect this part as shown in the projects!

The **Motor Control (U8)** module contains 16 transistors and resistors that are usually needed to control the motors. A description for this module is given here for those interested, see project 1 for a connection example:

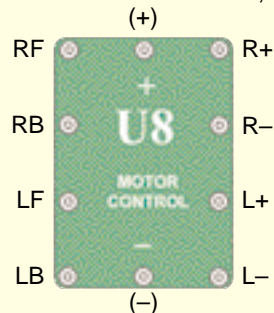

Motor Control:

- (+) - power from batteries
- (-) - power return to batteries
- RF - right forward control input
- RB - right backward control input
- LF - left forward control input
- LB - left backward control input
- R+ - right forward motor drive
- R- - right backward motor drive
- L+ - left forward motor drive
- L- - left backward motor drive



Only connect this part as shown in the projects!

The **motors** (in the Rover body) convert electricity into mechanical motion. Electricity is closely related to magnetism, and an electric current flowing in a wire has a magnetic field similar to that of a very, very tiny magnet. Inside the motor is a coil of wire with many loops wrapped around metal plates. If a large electric current flows through the loops, it will turn ordinary metal into a magnet. The motor shell also has a magnet on it. When electricity flows through the coil, it magnetizes the metal plates and they repel from the magnet on the motor shell - spinning the shaft. A small gear is on the end of the shaft and spins with it.

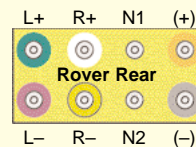

Rover Rear:

- (+) - power from batteries
- (-) - power return to batteries
- L+ - left forward motor drive
- L- - left backward motor drive
- R+ - right forward motor drive
- R- - right backward motor drive
- N1, N2 - not used

How It Works

Remote Control Transmitter:

When the levers in the Remote Control Unit are pushed, electrical contacts are made connecting the 9V battery power to the transmitter, indicating which commands the user wants sent to the Rover. Forwards/Backwards commands for each set of wheels and two extra functions are controlled by different levers or buttons. Each of these use a different set of electrical contacts which encode a sequence of electrical pulses; the pulse sequence depends on which command(s) are being sent. Some of the pulses in the sequence represent which channel setting (A-B-C) the remote control is on. This allows three units to use the same operating frequency in the same room at the same time without interfering with each other. An electrical circuit that is tuned to a frequency of 27 MHz creates a signal that is sent to the antenna when the pulses are active. The antenna converts this electrical energy into radio energy, creating a stream of radio energy bursts, which travel through the air and are picked up by, and understood by, the radio receiver in the car. The frequency of 27 MHz was selected for your Rover with the approval of the FCC (the US government) to minimize radio interference between this product and all other electrical products.

Radio Receiver:

The Rover antenna collects radio energy and converts it back into electrical energy. If the Rover is turned on, then the radio receiver in the Rover is continuously monitoring the radio energy from its antenna. The receiver is basically a filter which is tuned to amplify any energy around 27 MHz and block energy the antenna picks up outside this region. If the Remote Control Transmitter is sending commands, then its radio signal

will be picked up by the receiver and converted back into the original pulse sequence. Decoding circuitry then determines which commands were sent by examining the pulses in the sequence. Signals are then sent to motors that drive the wheels to execute the commands, or the other R/C Receiver outputs to control other functions. Commands sent to other receivers using a different channel setting (A-B-C) are ignored.

Characteristics of Radio Reception:

Many factors affect the ability of the Rover to receive commands from its Remote Control Transmitter. A weak battery in the Transmitter will result in a weaker transmitted signal; if the battery is very weak then the Transmitter may not function at all. The Transmitter's ability to convert electrical energy to radio energy is best when its antenna is fully extended and degrades as the antenna length is reduced. The same thing also applies to the Rover antenna's ability to convert the radio signal back into electrical energy for the receiver. The Transmitter's antenna transmits energy in all directions so as the range between it and the Rover is increased, less energy is received at the Rover. When operated with strong batteries and in an open area, the range will be at least 25 ft. Obstacles such as walls, furniture, and trees will degrade the radio signal's ability to travel through air and reduce the operating range, but will never block it completely. In some cases more radio energy may travel from the Transmitter to the Rover by going around obstacles than by going through them. In the Rover, weak batteries will reduce power to the motor and degrade the receiver's ability to filter, amplify, and decode commands from the Transmitter.

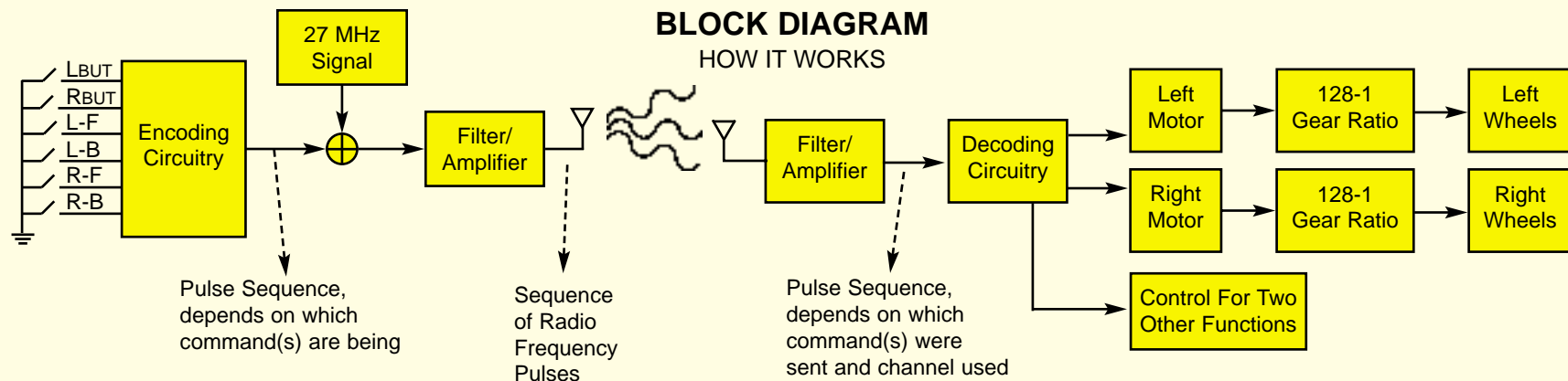

How It Works (continued)

Rover Drive Mechanism:

The small gear on the Motor drives a larger gear, which drives a larger gear, which drives two larger gears (one on each side), which drive larger gears. The last, largest gears are fixed on shafts that are attached to the front and back wheels, making them move. Note that interlocking gears spin in opposite directions. Also notice that in the sets of interlocking gears between the Motor and the gears on the wheel shafts, the number of “teeth” is increased each time (40-8, 44-8, 64-44, and 64-20), for 128:1 gear ratio overall. This means the Motor must rotate 128 times to rotate the wheels once. The reason for this is that if the Motor were to drive the wheels directly then the Rover would be so fast that it would be impossible to control. Using the gears to reduce the speed also makes the wheels move with much greater force, preventing the Rover from getting stuck in rough terrain and allowing it to carry heavy loads uphill.

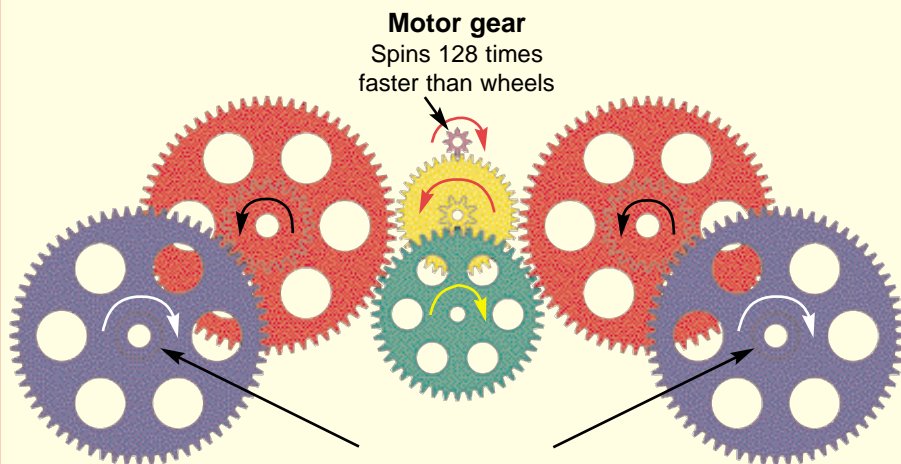

THE FCC

The Federal Communications Commission (FCC) regulates use of the radio frequency spectrum in the United States to prevent products from interfering with each other.

FCC regulations for your Rover require you to accept any interference from authorized sources and that you shut down if you are causing interference with other authorized products. Contact Elenco® Electronics if you need assistance.

You should never modify the electrical circuit components inside your car or Remote Control transmitter as this may cause malfunctions or violate FCC regulations for this product.

General Operating Instructions

Build the circuit for projects 1 or 2. Set the channel switches on the remote control unit and R/C Receiver module (RX1) to the same setting (A, B, or C). Place the Rover on a flat, open area, turn the ON/OFF switch on the remote control unit and the slide switch (S1) to ON, and extend the antenna on the Remote Control.

Push both levers forward to make Snap Rover go forward.

Push both levers backward to go backward.

Push the left lever backward and the right lever forward to turn left.

Push the left lever forward and the right lever backward to turn right.

The buttons on the remote control unit are used to control sounds or lights (or other special functions) as described in the projects.

Never operate Snap Rover in the street.

Never drive your Rover in rain, snow, mud, sand, dirt, or on a wet floor, as damage may result.

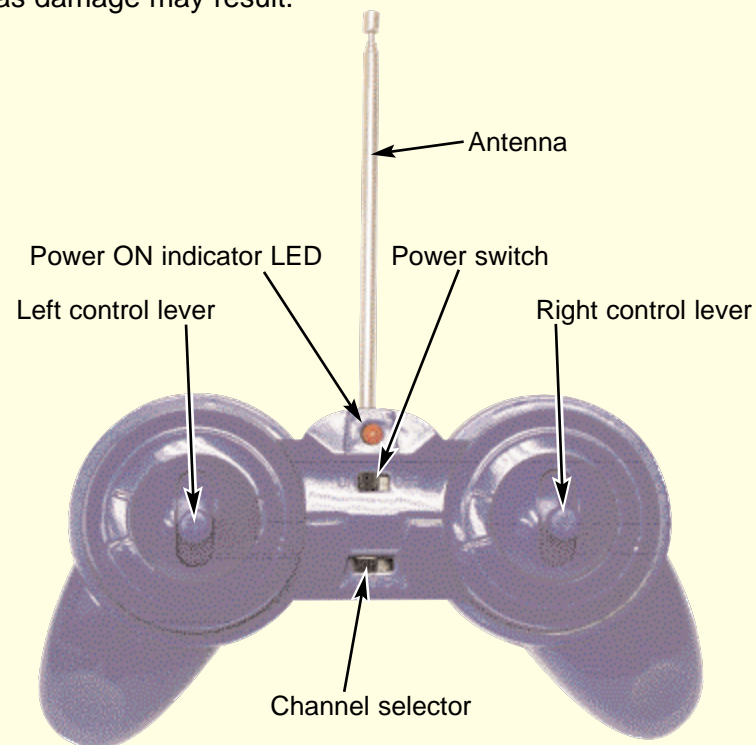

DO's and DON'Ts of Building Circuits

After building the circuits given in this booklet, you may wish to experiment on your own. Use the projects in this booklet as a guide, as many important design concepts are introduced throughout them. Every circuit will include a power source (the batteries), a resistance (which might be a resistor, motor, integrated circuit, etc.), and wiring paths between them and back. **You must be careful not to create "short circuits" (very low-resistance paths across the batteries, see examples below) as this will damage components and/or quickly drain your batteries.** Only connect the ICs using configurations given in the projects, incorrectly doing so may damage them. **Elenco® Electronics is not responsible for parts damaged due to incorrect wiring.**

Here are some important guidelines:

- ALWAYS** use eye protection when experimenting on your own.
- ALWAYS** include at least one component that will limit the current through a circuit, such as a resistor, motor, horn, or the RX1 and U8 modules (which must be connected properly).
- ALWAYS** use the LED and switches in conjunction with other components that will limit the current through them. Failure to do so will create a short circuit and/or damage those parts.
- ALWAYS** disconnect your batteries immediately and check your wiring if something appears to be getting hot.
- ALWAYS** check your wiring before turning on a circuit.
- ALWAYS** connect the RX1 and U8 modules using configurations given in the projects or as per the connection descriptions for the parts.
- NEVER** connect to an electrical outlet in your home in any way.
- NEVER** leave a circuit unattended when it is turned on.

Note: If you have a more advanced model, there are additional guidelines in your other project manual(s).

For all of the projects given in this book, the parts may be arranged in different ways without changing the circuit. For example, the order of parts connected in series or in parallel does not matter — what matters is how combinations of these sub-circuits are arranged together.

WARNING: SHOCK HAZARD - Never connect Snap Circuits to the electrical outlets in your home in any way!

Examples of SHORT CIRCUITS - NEVER DO THESE!!!

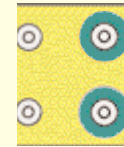

Placing a jumper wire directly across the battery snaps is a SHORT CIRCUIT.

When the switch (S1) is turned on, this large circuit has a SHORT CIRCUIT path (as shown by the arrows). The short circuit prevents any other portions of the circuit from ever working.

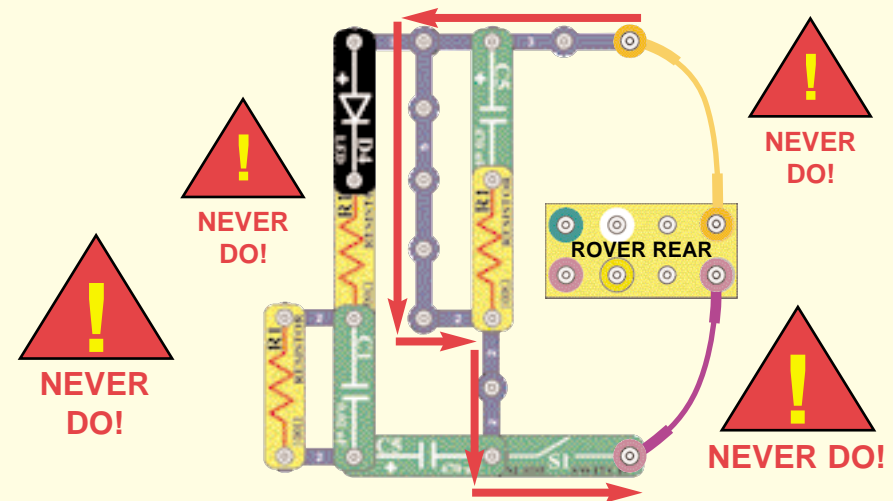

You are encouraged to tell us about new circuits you create. Upon review, we will post them with your name in a special section on our web site. If we use them in future manual revisions, we will send you a copy of the manual so you can show your family and friends. Send your suggestions to Elenco® Electronics.

Warning to Snap Circuits owners: Do not use parts from other Snap Circuits sets with this kit except for the circuits on page 22. The Snap Rover uses higher voltage which could damage those parts. Our web site www.snapcircuits.net also

CAUTION: Do not mix alkaline, standard (carbon-zinc), or rechargeable (nickel-cadmium) batteries.

Advanced Troubleshooting (Adult supervision recommended)

Elenco® Electronics is not responsible for parts damaged due to incorrect wiring.

If you suspect you have damaged parts, you can follow this procedure to systematically determine which ones need replacing:

1. **Rover body and jumper wires:** Flip the Rover body upside down and make sure the wheel mechanisms are clean. Install batteries in the Rover body and connect jumper wires to the Rover rear as shown; two wheels should move. Replace the orange and gray jumper wires with each of the other colors to see if any of the jumpers are damaged. If the wheels don't move for any combination of wires, then the Rover body is damaged. Remove the gray wire; four LEDs on the side should light.

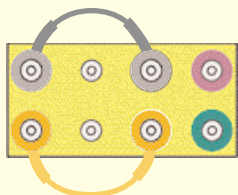

Now move the jumper wires to test the other two wheels, if they don't move then the Rover body is damaged. Remove the gray wire, four LEDs on the side should light.

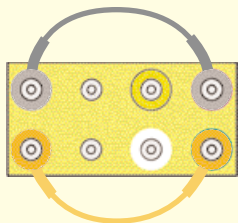

2. **Slide switch (S1):** Build project 23 (Helpless Rover) and test the switch by making it turn the wheels on/off.
3. **Snap wires:** Build project 23 but replace the switch with each of the snap wires (including the 1-snaps), test them one at a time.
4. **Horn (W1), LED (D4), 100Ω and 1KΩ resistors (R1, R2):** Build this mini-circuit and turn on the switch, the horn should make a loud noise or it is damaged. Replace the 3-snap with the 100Ω resistor, the sound should be a little less loud or the resistor is defective. Replace the horn with the LED ("+" side on left, and keep the resistor in), the LED should be bright or it is damaged. Now replace the 100Ω resistor with each of the 1KΩ resistors (one at a time), the LED should still be bright or the resistor is damaged.

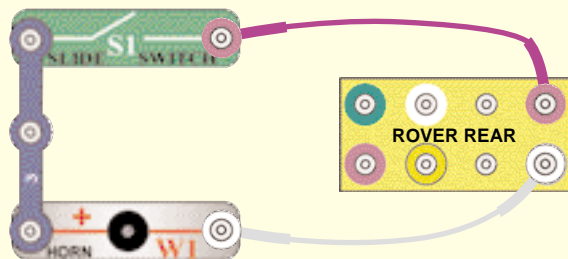

5. **Motor Control (U8) module:** Build this circuit and turn it on, both sets of wheels should turn forward. Now shift the 1KΩ resistors (R2) to be across points A-B and C-D; the wheels should turn backwards.

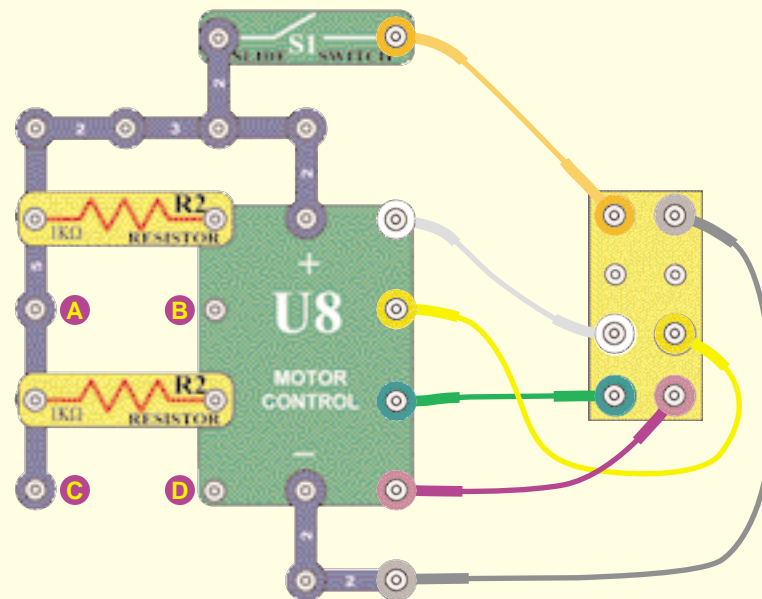

6. **0.02μF and 470μF capacitors (C1, C5):** Build project 14. Charge each of the 470μF capacitors as directed and test that it lights the LED, if it doesn't then it is damaged. Now do this using the 0.02μF capacitor but look closely at the front of the LED, you should see a brief dim flash if the capacitor is working.
7. **Remote control unit and R/C Receiver (RX1):** Build project 1 and test that the wheels, horn (W1), and LED (D4) can be controlled by the remote control unit as described. Be sure you have built the circuit correctly and have good batteries in both the Rover and remote control. Have the A-B-C switches on the remote control and R/C receiver set to the same channel, have turned on the remote control turned on and its antenna extended, and make sure it is not being interfered with by other remote control transmitters.

Note: If you have a more advanced model, there are additional tests in your other

Elenco® Electronics, Inc.

150 Carpenter Avenue • Wheeling, IL 60090 U.S.A.
Phone: (847) 541-3800 • Fax: (847) 520-0085
e-mail: help@elenco.com • Web site: www.elenco.com

**You may order additional / replacement parts at:
www.snapcircuits.net**



Project #1

Remote Control Rover

OBJECTIVE: To build a remote control vehicle.

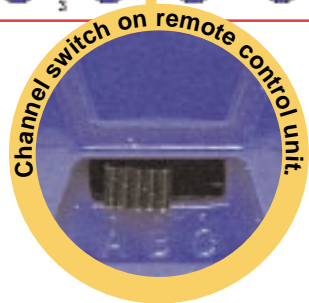
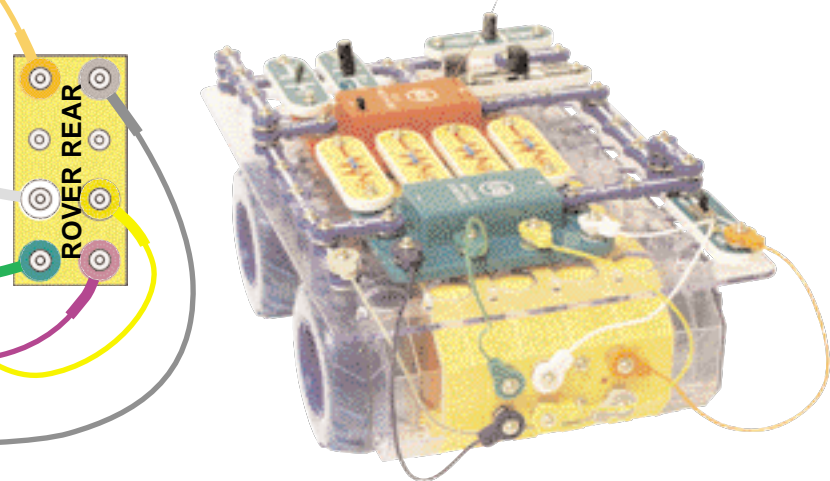
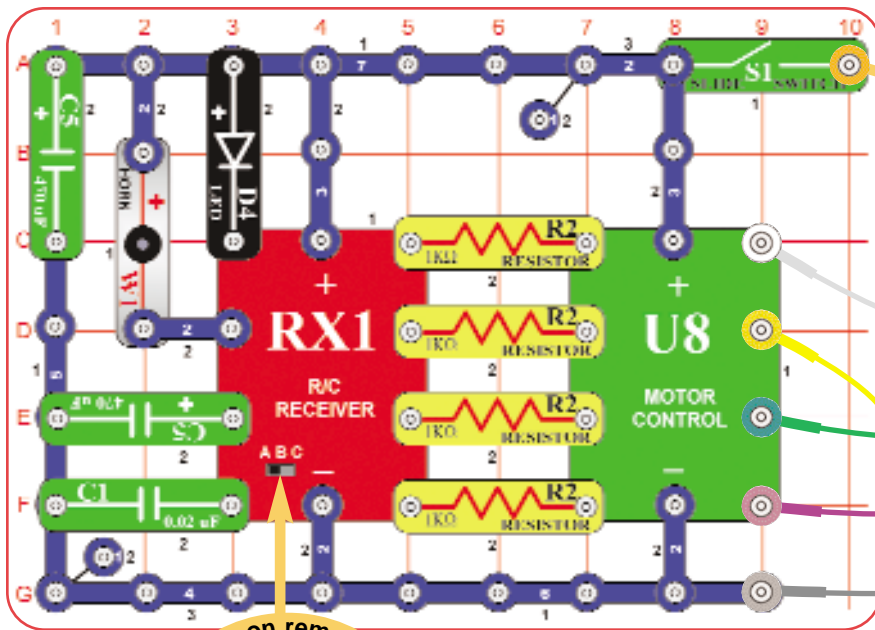

The Snap Circuits Kit uses electronic blocks that snap onto a clear plastic base grid to build different circuits. These blocks have different colors and numbers on them so that you can easily identify them.

Install six (6) "AA" batteries into the bottom of the Rover body and one 9V battery into the remote control unit (batteries not included). Install the antenna into the remote control unit by screwing it in. Place the base grid on the Rover body; you may lock it into position by turning the hexagonal alignment posts (shown here), if desired.

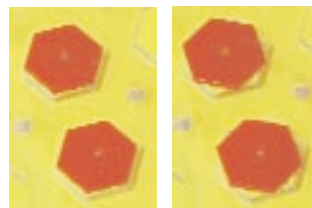

Build the circuit shown by placing all the parts with a black 1 next to them on the clear plastic base grid first. Then, assemble parts marked with a 2, and finally the parts marked with a 3. Be sure to place the C5 (green), U8 (green), RX1 (red), D4 (black), and W1 (clear) parts with their (+) side oriented as shown. Connect the colored jumper wires to the rear of the body as shown (the colors are interchangeable). Set the channel switches on the remote control unit and R/C Receiver module (RX1) to the same setting (A, B, or C). Place the decorative stickers on the front of the Rover body and the antenna on the R/C receiver (RX1).

Turn on the slide switch (S1). Turn on the remote control unit, extend the antenna, and use the levers to drive the Rover around. The buttons on the remote control activate a horn (W1) or a light (the D4 LED).

Project #2

Night Rover

OBJECTIVE: To build a remote control vehicle that you can drive in the dark.

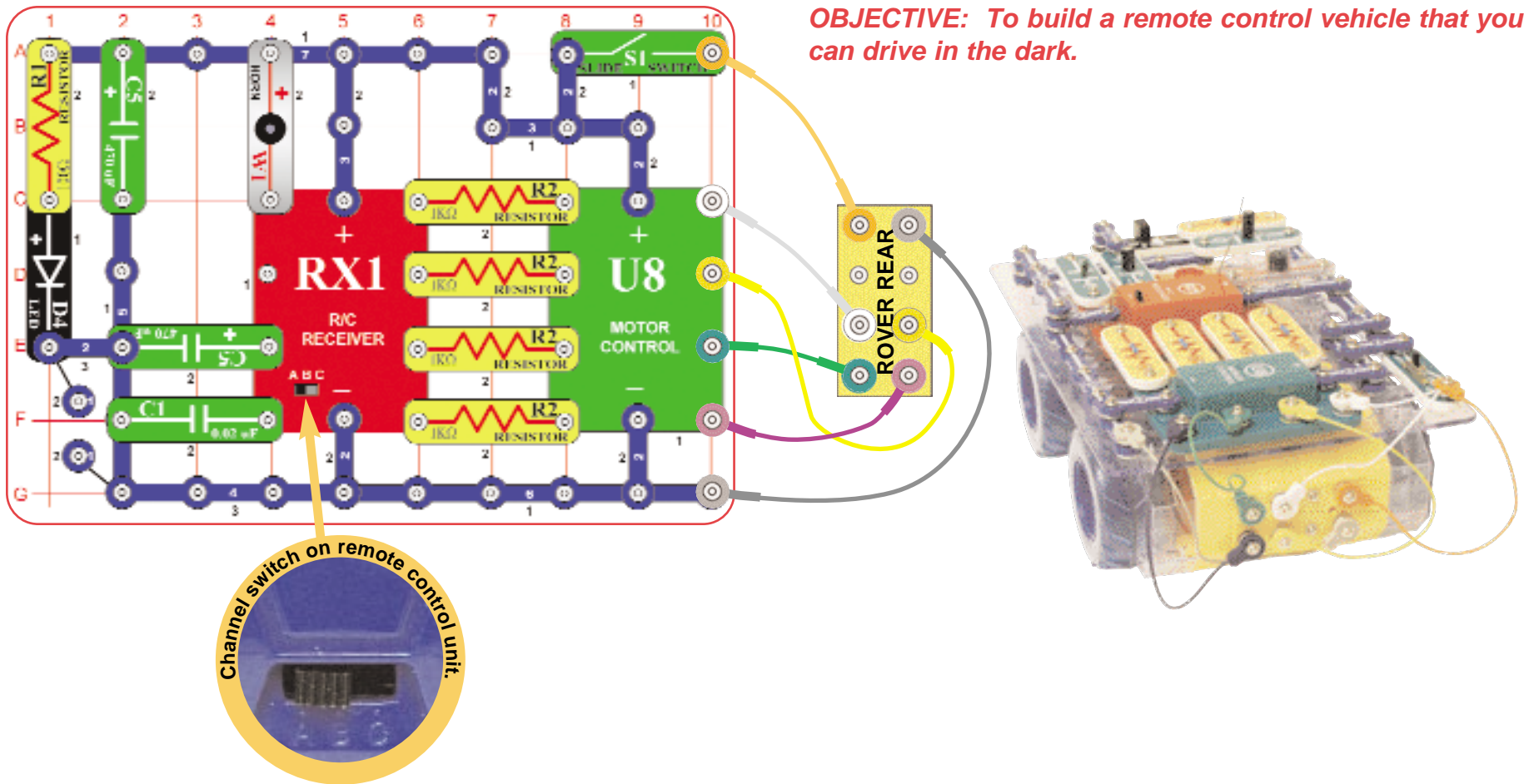

Install six (6) "AA" batteries into the bottom of the Rover body and one 9V battery into the remote control unit (batteries not included). Install the antenna in to the remote control unit by screwing it in. Place the base grid on the Rover body; you may lock it into position by turning the hexagonal alignment posts (shown here), if desired.

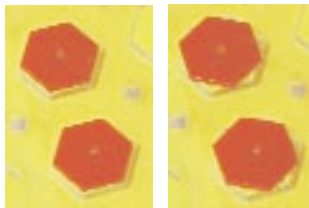

Build the circuit shown by placing all the parts with a black 1 next to them on the clear plastic base grid first. Then, assemble parts marked with a 2, and finally the parts marked with a 3. Be sure to place the C5 (green), U8

(green), RX1 (red), D4 (black), and W1 (clear) parts with their (+) side oriented as shown. Connect the colored jumper wires to the rear of the body as shown (the colors are interchangeable). Set the channel switches on the remote control unit and R/C Receiver module (RX1) to the same setting (A, B, or C).

Turn on the slide switch (S1), the LED (D4) shines. Turn on the remote control unit, extend the antenna, and use the levers to drive the Rover around. The right button on the remote control activates the horn (W1).

You can use Snap Rover in a dark room since the LED (D4) is positioned as a headlight. Spin Snap Rover around and use caution when backing up.



Project #3

Lighthouse

OBJECTIVE: To make a rotating light.

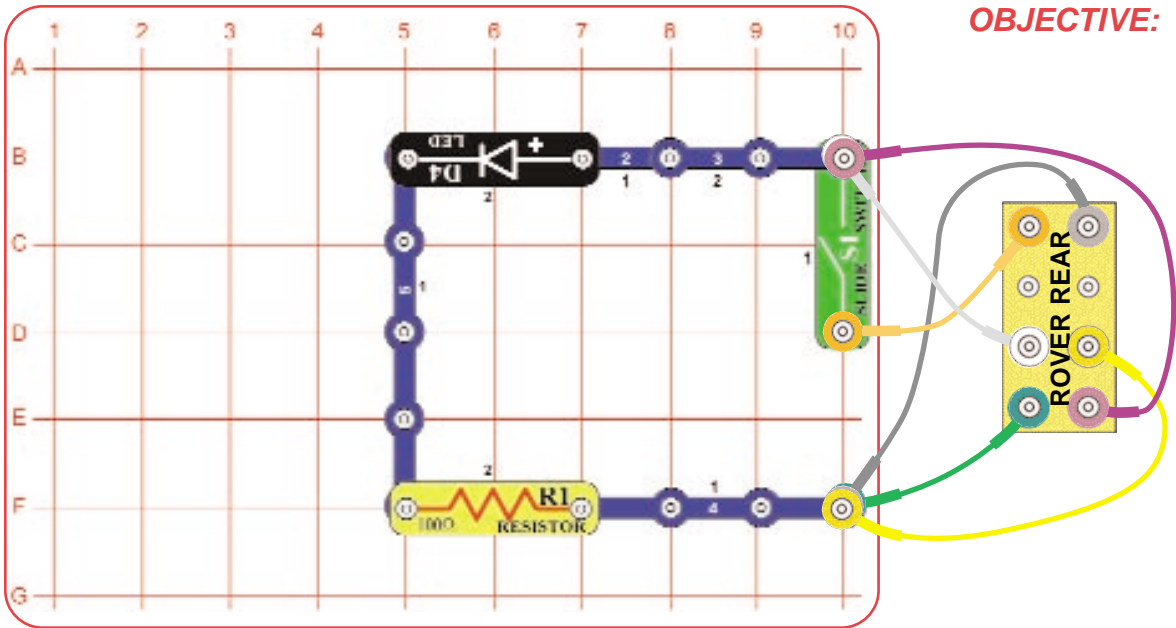

Build the circuit, place the base grid centered on the Rover body, and connect the jumper wires as shown. Place the Snap Rover in the middle of a dimly lit room and turn on the slide switch (S1). The light will shine around the room as Snap Rover spins.



Project #4

Backwards Rover

OBJECTIVE: To see if you can adapt to unusual

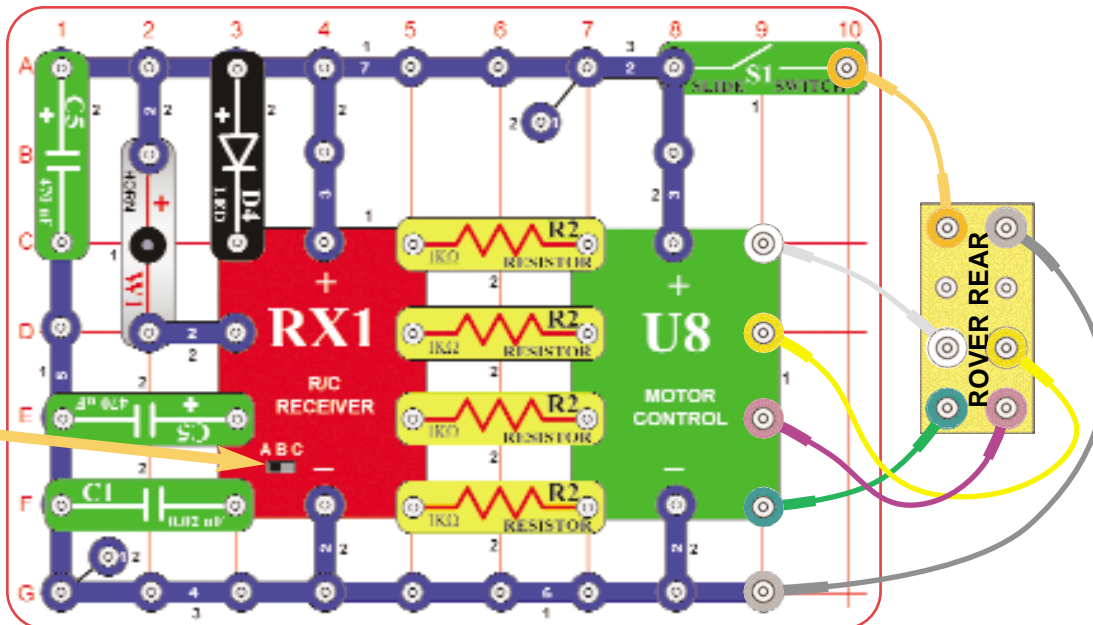
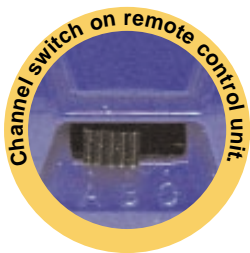

Build the circuit shown and turn on the slide switch (S1). Turn on the remote control unit, extend the antenna, and use the levers try to drive the Rover around. The wiring has been changed so that the levers do not control the Snap Rover in the ways you'd expect, see how long it takes you to adjust.

Option A: Swap the connection points of the white and yellow jumper wires on the motor control module (U8).



Project #5

Two-Sound Rover

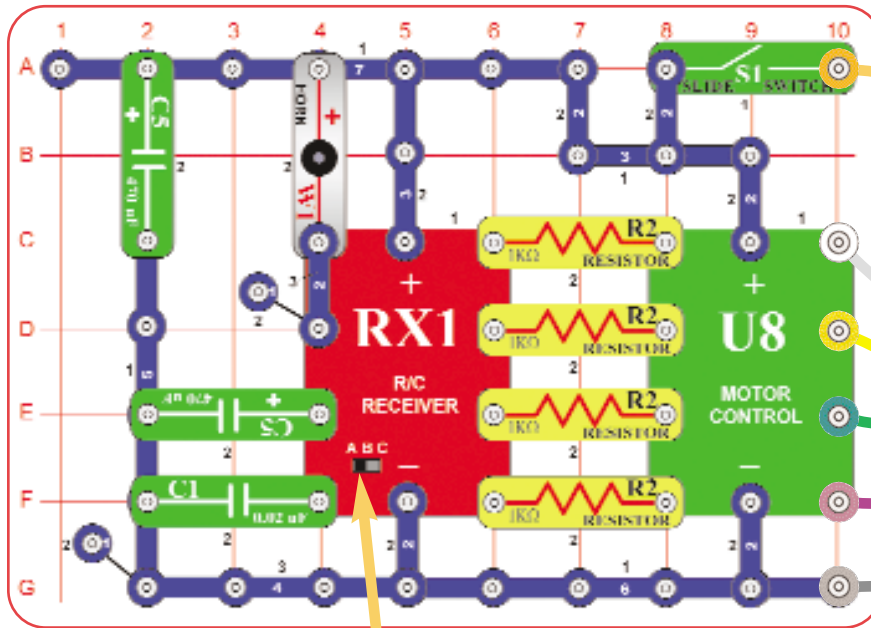

OBJECTIVE: To build a remote control vehicle with two sound levels.

Build the circuit shown and turn on the slide switch (S1). Turn on the remote control unit, extend the antenna, and use the levers try to drive the Rover around. Press the left or right buttons to activate the horn (W1); press both for a louder sound.

Option A: Replace the horn (W1) with the LED (D4). Now the remote control buttons shine a light.

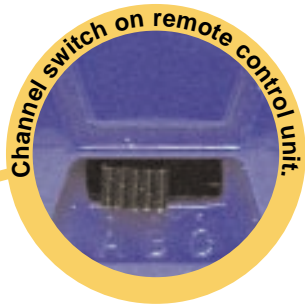

Project #6

Helpless Rover

OBJECTIVE: To look at the gears.

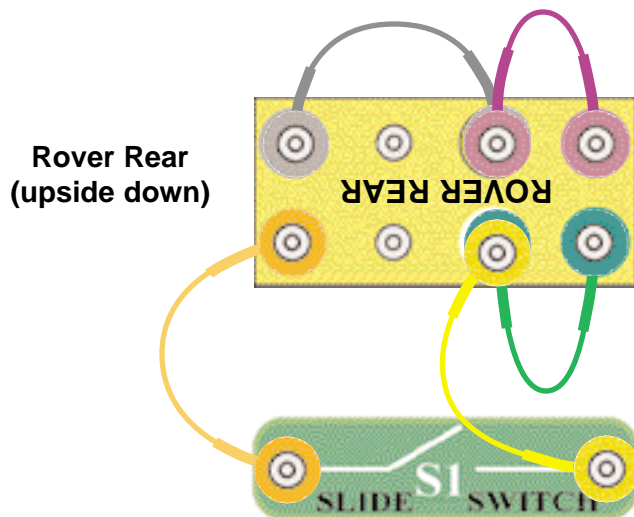

Flip the Rover body so it is upside down and connect the jumper wires to the body and slide switch (S1) as shown. Turn on the switch to watch the wheels and gears move.

Notice that the smaller gears are spinning much faster than the larger gears and wheels. The smallest gears (on the motor) are actually spinning 128 times faster than the wheels. See page 6 for more information about the gears.

Option A: Swap the connection points of the gray and orange jumper wires on the Rover rear. Now the wheels and gears spin in the opposite direction.



Project #7

Morse Code

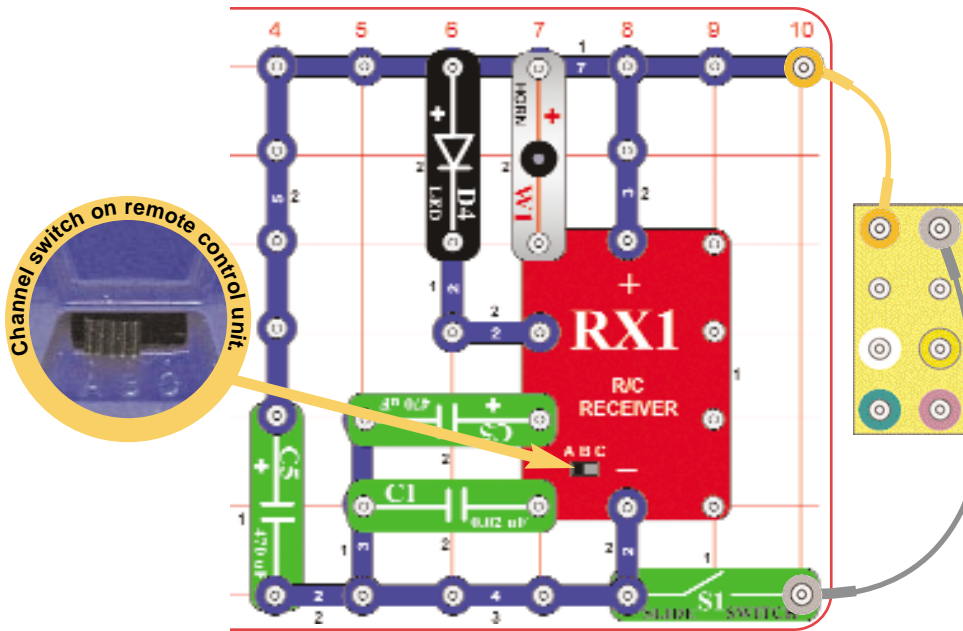

OBJECTIVE: To learn about Morse code.

Build the circuit, connect the jumper wires, and turn on the slide switch (S1). Turn on the remote control unit and extend the antenna. Press the buttons on the remote control to generate long or short bursts of sound (from the W1 horn) or light (from the D4 LED).

You can send secret messages to friends using Morse code, which uses a series of long and short bursts of sound or light to represent letters and numbers. A short burst is represented by a "•", and a long burst by a "—", as shown in this chart:

A •—	M ——	Y —•—
B •••	N •—	Z ••••
C ••••	O —•—	1 ••••—
D —••	P —•—	2 ••••—
E •—	Q —•—•	3 ••••—
F ••••	R •••	4 ••••—
G —••	S •••	5 •••••
H ••••	T —	6 ••••—
I ••—	U ••—	7 —••••
J •—•—	V ••••	8 —••••
K ••—	W ••—	9 —••••
L ••••	X ••••	0 —••••

Morse code was developed in the 19th century to send information over long distances using telegraph wires and early radios. This equipment had only two states - on or off (that is, transmitting or not transmitting), and could not send the range of frequencies contained in human voices or music. The code sent letters as a sequence of short or long transmit bursts.

During World War II Navy ships sometimes communicated by flashing Morse Code messages between ships using searchlights (they did this because radio transmissions might reveal their presence or position to the enemy).

You can find more information about Morse code at websites such as http://en.wikipedia.org/wiki/Morse_code. You can also find websites that will translate and play back Morse code messages, such as <http://www.omnicron.com/~ford/java/NMorse.html>.



Project #8

Generator

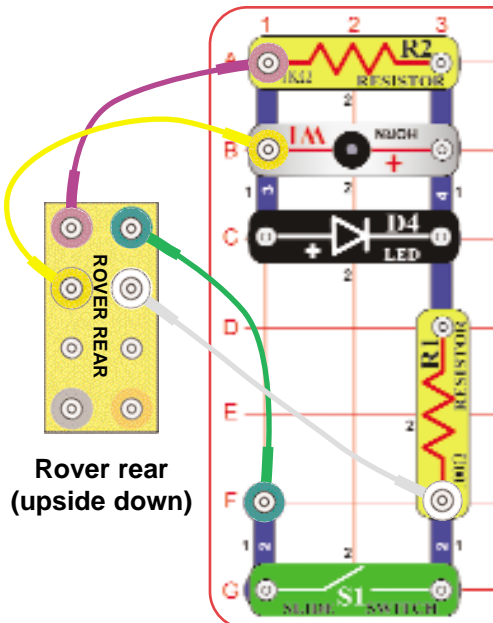

OBJECTIVE: To produce electricity by spinning the

Flip the Rover body so it is upside down and connect the jumper wires to the body and circuit as shown. Turn off the slide switch (S1) for the time being.

Spin the right wheels with your hands. Depending on how fast you spin and in which direction, you may light the LEDs in the car body and the white LED (D4), or hear sound from the horn (W1).

Now turn on the slide switch (S1) and spin the right wheels again. The wheels now take more effort to spin, and cause the left wheels to also spin.

Spinning the right wheels makes all the inter-connected gears spin, and spins the shaft on the right motor. The spinning motor shaft creates electricity using magnetism (opposite to how electricity through the motor spins the shaft), which powers the LEDs and horn. With the switch on, the electricity created in the right motor also powers the left motor, which spins the left wheels. The wheels are harder to spin now because magnetic fields in both motors must be overcome. No batteries are used.

WARNING: Do not use excessive force to spin the wheels at abnormally high speeds. This may burn out the motors or LEDs.



Project #9

Slow Turn-Off

OBJECTIVE: To show how capacitors slow things down.

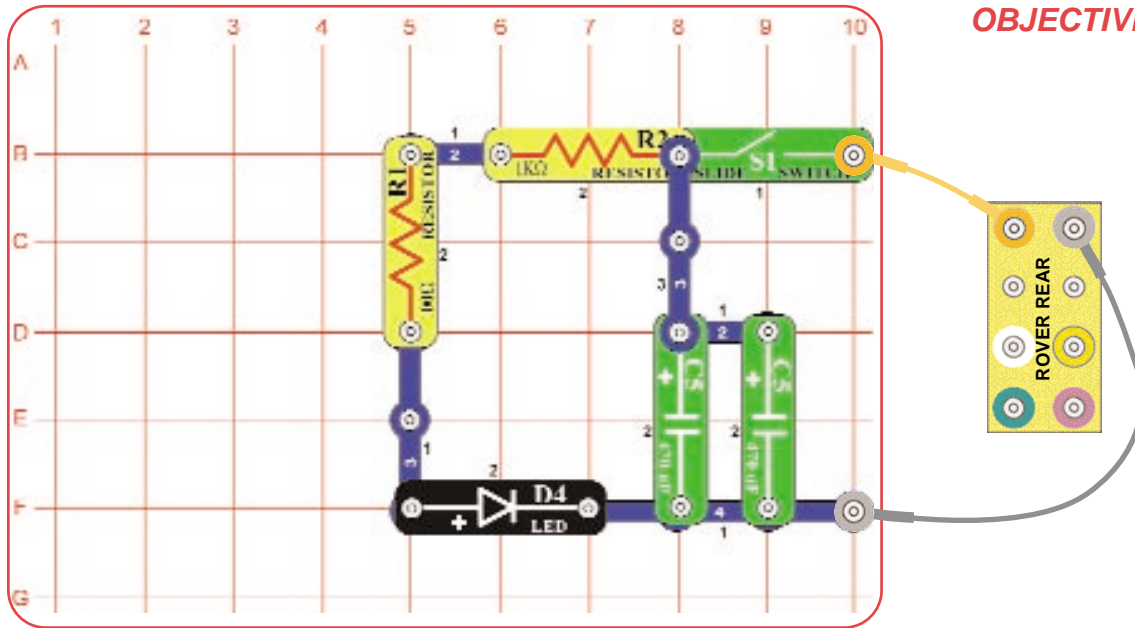

Build the circuit, place the base grid on the Rover body, and connect the jumper wires as shown. Turn the switch (S1) on and the LED is on. Turn the switch off, and the LED goes out slowly. Electricity stored in the 470µF capacitors (C5) keeps the LED on after the batteries have been disconnected.

If you remove one of the capacitors then the LED will turn off faster, because you aren't storing as much electricity. If you remove both capacitors, the LED will turn off immediately when the switch is turned off.



Project #10

Series Capacitors

OBJECTIVE: To compare types of circuits.

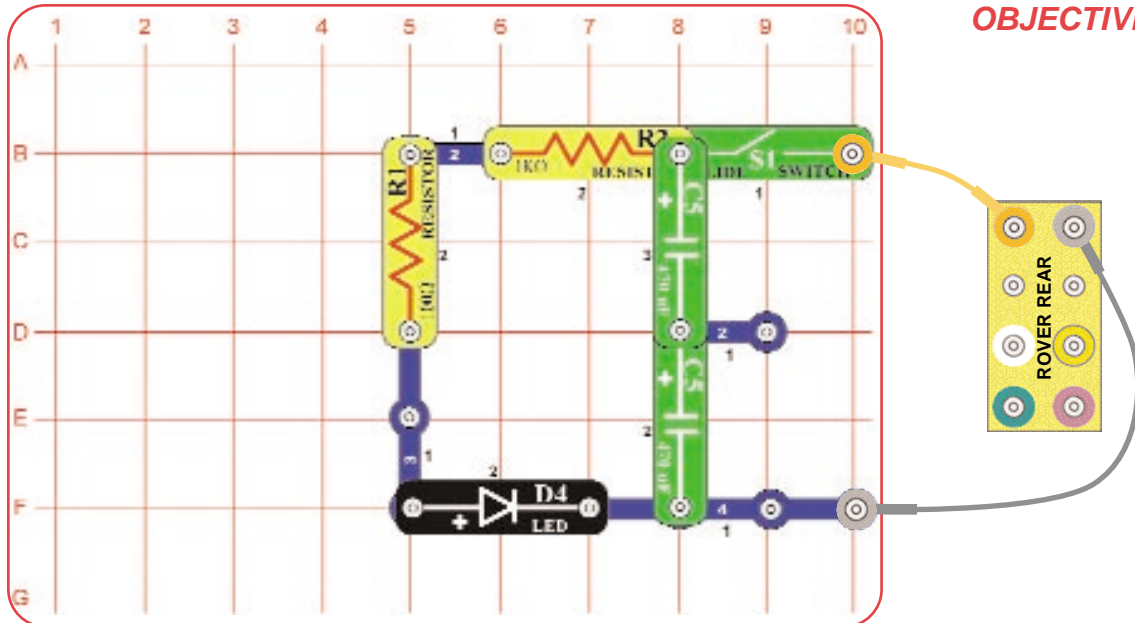

This is the same circuit as project 9, but with the capacitors connected differently. Build the circuit and connect the jumper wires as shown. Turn the switch on and off, and watch how quickly the LED turns off.

The LED doesn't stay on as long with this circuit than it did in project 9, because two capacitors connected in *series* store less electricity than just one (half as much). This may seem like a bad way to connect capacitors, but it allows them to be used with higher voltages.



Project #11

Sound & Light

OBJECTIVE: To build a circuit with sound and light.

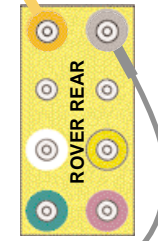
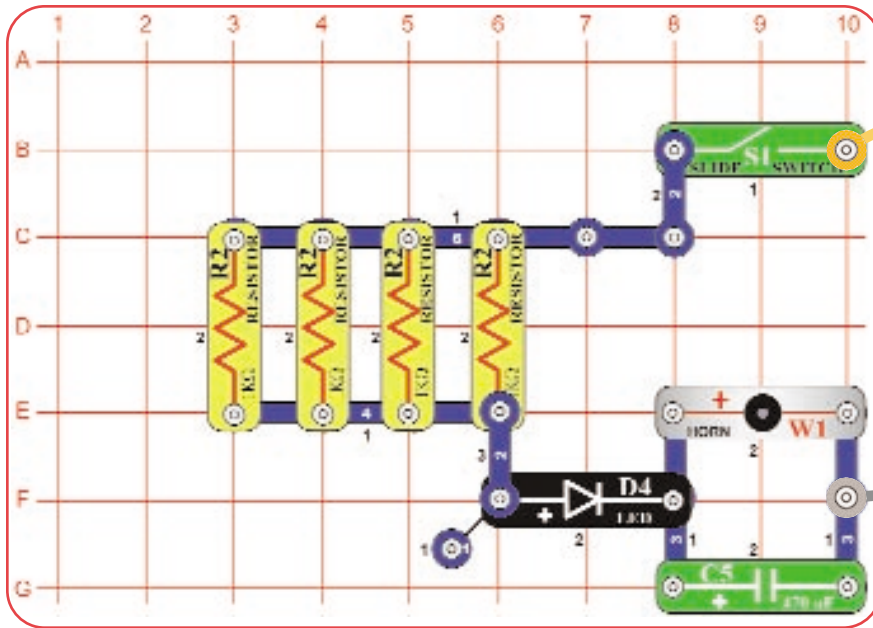

Build the circuit, place the base grid centered on the Rover body, and connect the jumper wires as shown. Turn on the switch (S1) and electricity flows from the batteries through the circuit. The horn (W1) converts electricity into sound and the LED (D4) converts electricity into light. The four 1KΩ resistors (R2) are connected in parallel, to act as a 250Ω resistance.



Project #12

Electricity Bank

OBJECTIVE: To show how capacitors store electrical

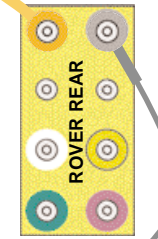
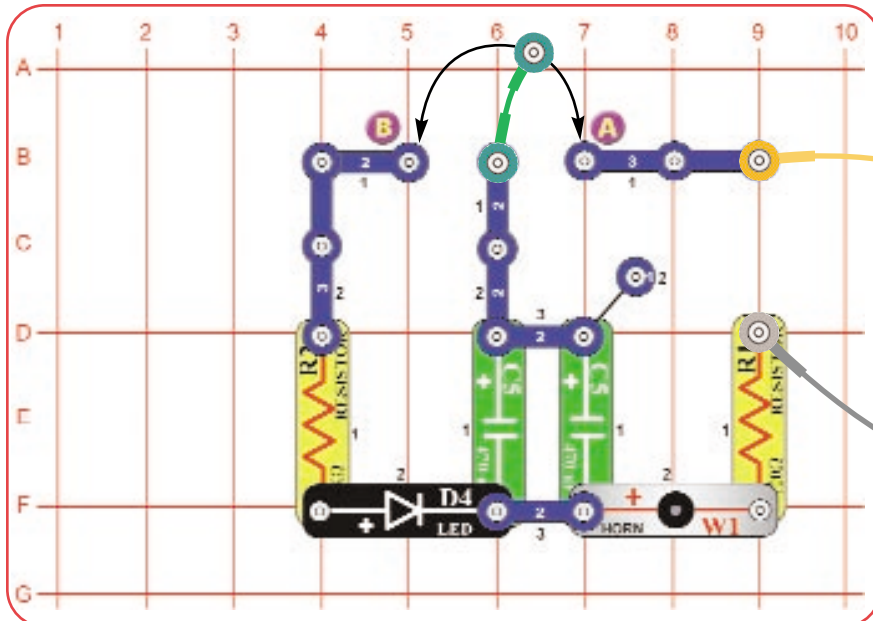

Build the circuit and connect the jumper wires, leaving one end of the green jumper off as shown. Touch the loose end of the green jumper to point A on the 3-snap wire for a moment. The horn (W1) makes noise while the 470µF capacitors (C5) fill up with electricity.

Now move the green jumper from point A to point B on the 2-snap wire. The LED (D4) lights for a few seconds using the electricity stored in the capacitors. Move the green jumper back to A to refill with electricity, and then to B several times.



Project #13

Slow R/C Flashlight

OBJECTIVE: To build a remote control light.

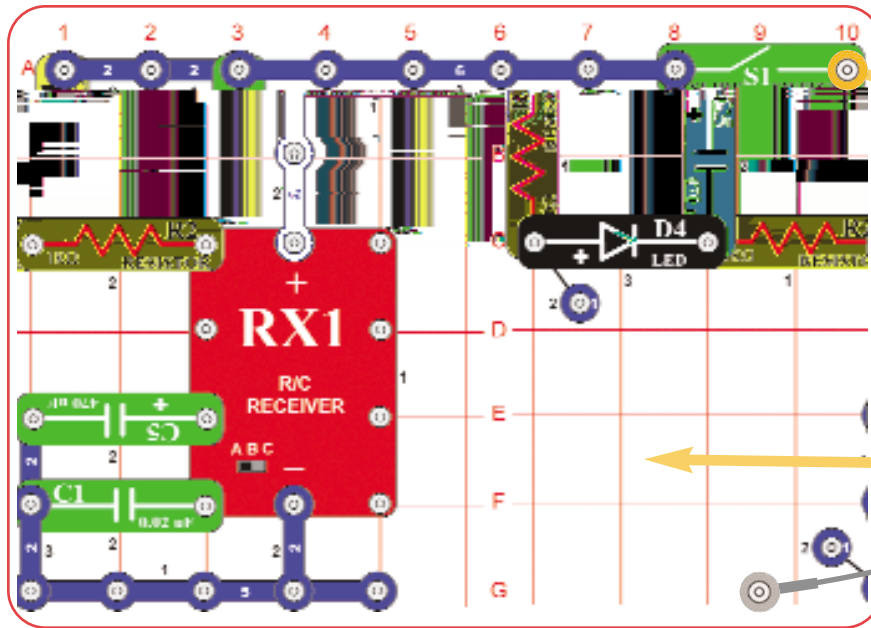

Build the circuit shown and turn on the slide switch (S1). Turn on the remote control unit, extend the antenna, and press the right button. If you hold it down for a few seconds the LED (D4) will turn on.

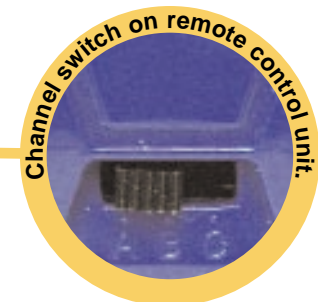
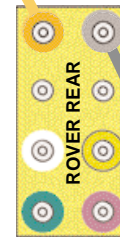

Project #14

Capacitor Battery

OBJECTIVE: To show how capacitors store electrical

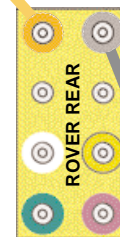
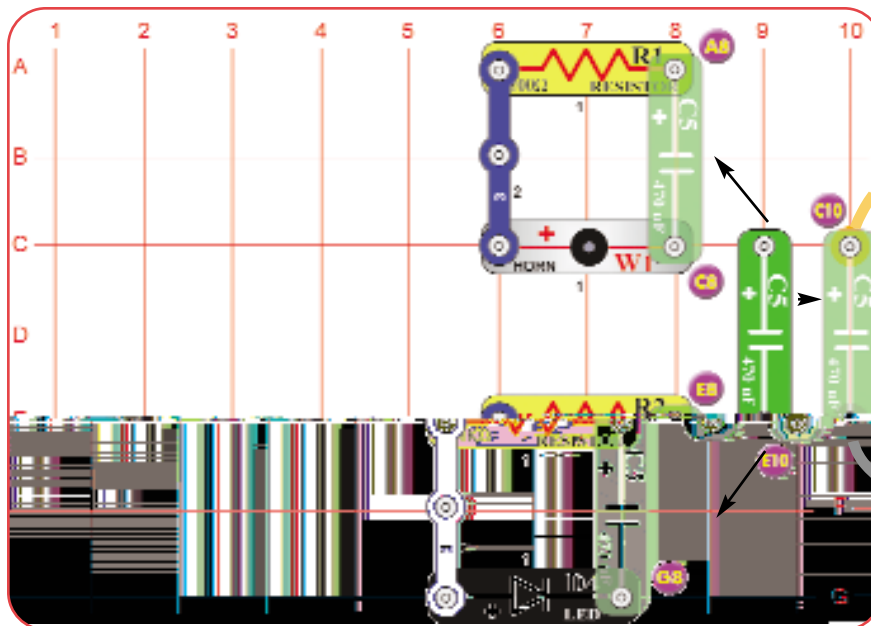

Build the circuit shown but leave the 470 μ F capacitor (C5) unconnected. The orange and gray jumper wires are placed on the base grid at points C10 and E10.

Touch the capacitor across the jumper wires at points C10-E10 to fill it with electricity. Now place it across points A8-C8 to make noise, or across points E8-G8 to flash a light. Move the capacitor back to C10-E10 to refill it, then to A8-C8 or E8-G8 again.

The 470 μ F capacitor acts like a battery. It can store electricity for a while, then release it when you need it. But a capacitor is a very weak battery, and can only make noise or light for a few seconds.



Project #15

When More Are Less

OBJECTIVE: To compare types of circuits.

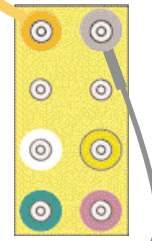
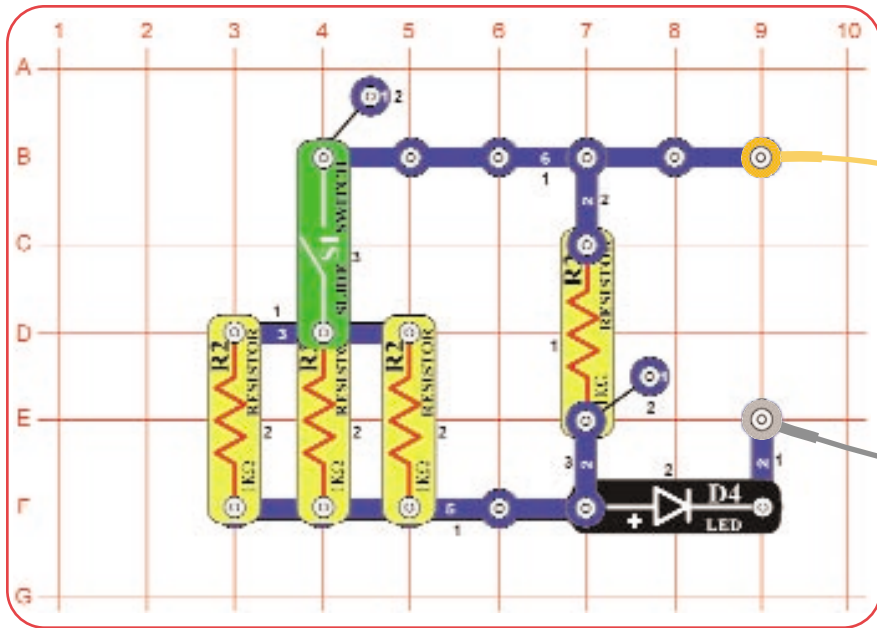

Build the circuit and connect the jumper wires as shown. The LED (D4) will be on but the resistor is limiting the electricity through it.

Turn on the switch (S1) to place three other resistors in *parallel* with the first one. This increases the flow of electricity to the LED, and makes it brighter. Placing other resistors in parallel reduces the total resistance (to 333Ω here), so more are less.



Project #16

When More Are More

OBJECTIVE: To compare types of circuits.

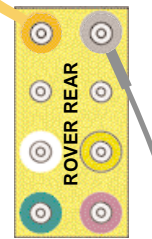
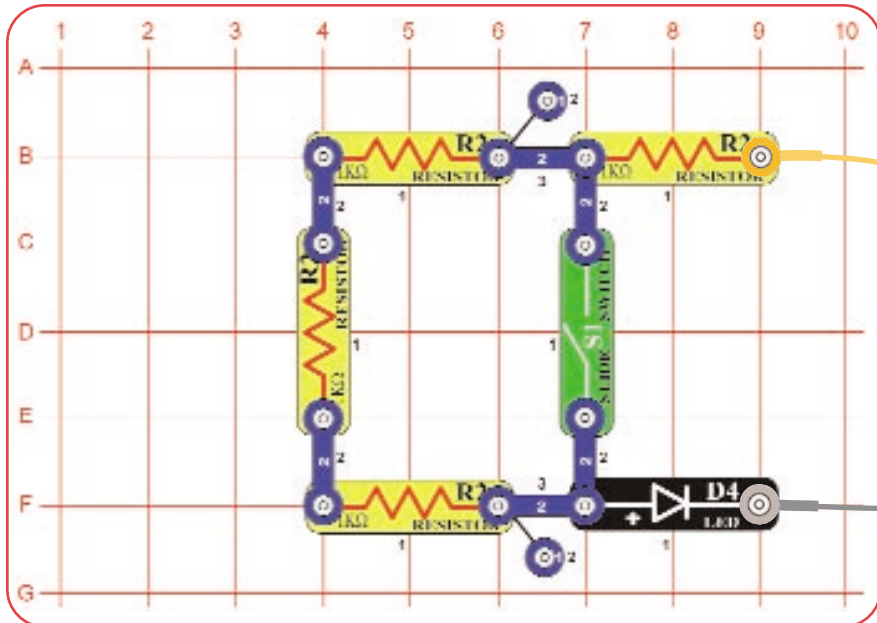

Build the circuit and connect the jumper wires as shown. The LED (D4) will be on but the four resistors are limiting the electricity through it.

Turn on the switch (S1) to bypass three resistors that are in *series* with the first one. This increases the flow of electricity to the LED, and makes it brighter. Placing other resistors in series increases the total resistance, so more are more.



Project #17

Pencil Buzz

OBJECTIVE: To draw a missing component.

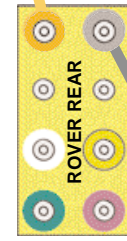
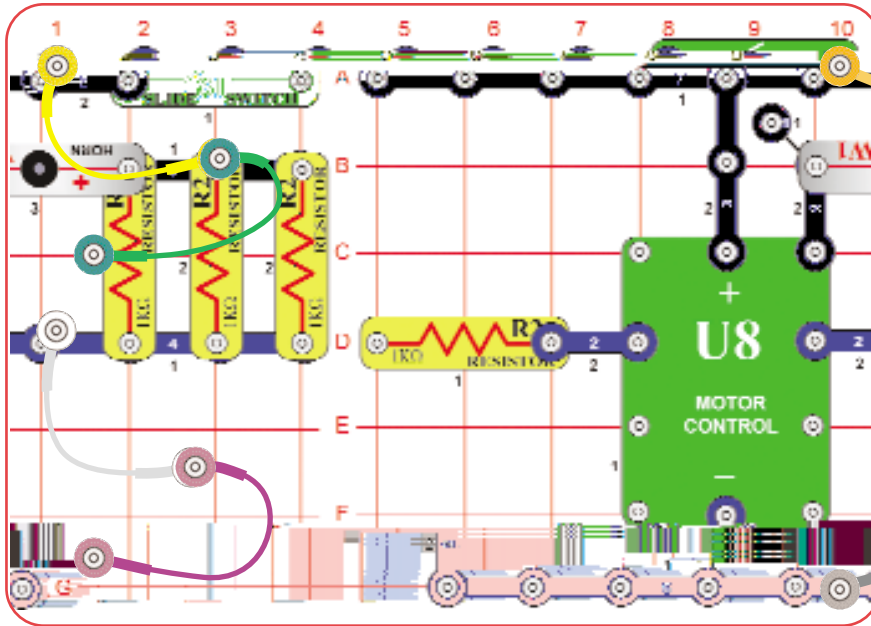

Build the circuit at left and connect the jumper wires to it, but leave the loose ends of the green and purple jumpers unconnected for now. There is one more part you need and you are going to draw it. Take a pencil (No. 2 lead is best but other types will also work). **SHARPEN IT**, and fill in the shape below. You will get better results if you place a **hard**, flat surface directly beneath this page while you are drawing. Press **hard** (but don't rip the paper), and fill in the shape **several times** to be sure you have a **thick, even layer** of pencil lead.



Turn on the switch and take the loose ends of the jumpers, press them to the shape and move them around over the drawing. If you don't hear any sound then add another layer of pencil lead, or put a drop of water on the jumper ends to get better contact. You can draw different shapes if you like.

Option A: Replace the horn (W1) with the LED (D4, "+" side on the right), to shine a light instead of making noise.

Option B: Instead of using a pencil drawing, place the loose ends of the jumper wires into a cup of water to make a water alarm!



Project #18

Stay-on Pencil Light

OBJECTIVE: To draw a missing component.

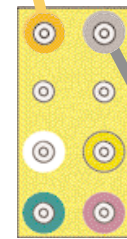
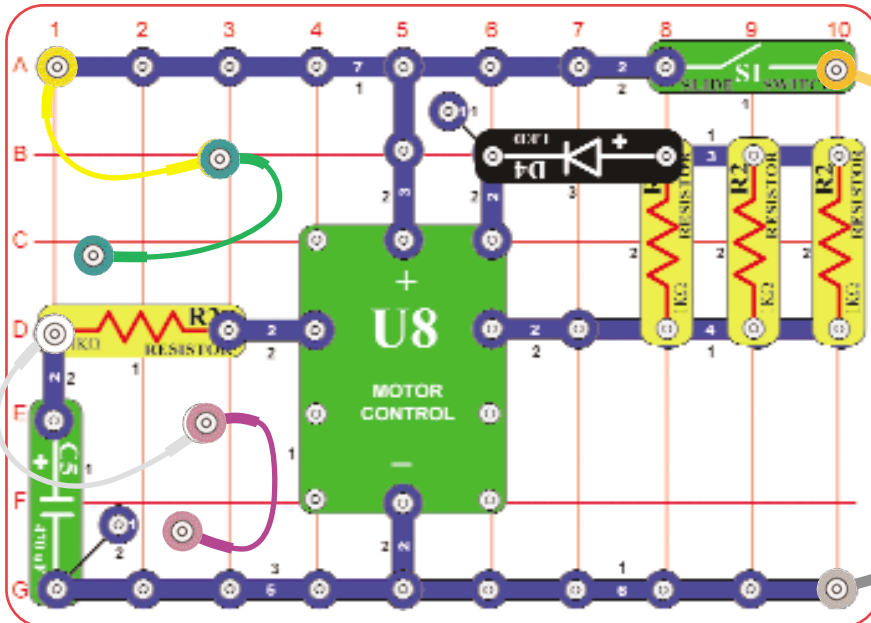

This is the same circuit as project 17, but it stays on if you turn it off. Build the circuit at left and connect the jumper wires to it, but leave the loose ends of the green and purple jumpers unconnected for now. There is one more part you need and you are going to draw it. Take a pencil (No. 2 lead is best but other types will also work). **SHARPEN IT**, and fill in the shape below. You will get better results if you place a **hard**, flat surface directly beneath this page while you are drawing. Press **hard** (but don't rip the paper), and fill in the shape **several times** to be sure you have a **thick, even layer** of pencil lead.

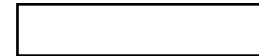

Turn on the switch and take the loose ends of the jumpers, press them to the shape and move them around over the drawing. It will take a few seconds for the LED (D4) to turn on, but then it will stay on for a long time after you remove the jumper wires from the drawing. If the light never comes on then add another layer of pencil lead, or put a drop of water on the jumper ends to get better contact.

Option A: Replace the LED (D4) with the horn (W1, "+" side on the right), to make noise instead of shining a light!

Option B: Instead of using a pencil drawing, place the loose ends of the jumper wires into a cup of water to make a water alarm!



Project #19

Water Detector

OBJECTIVE: To show how water conducts electricity.

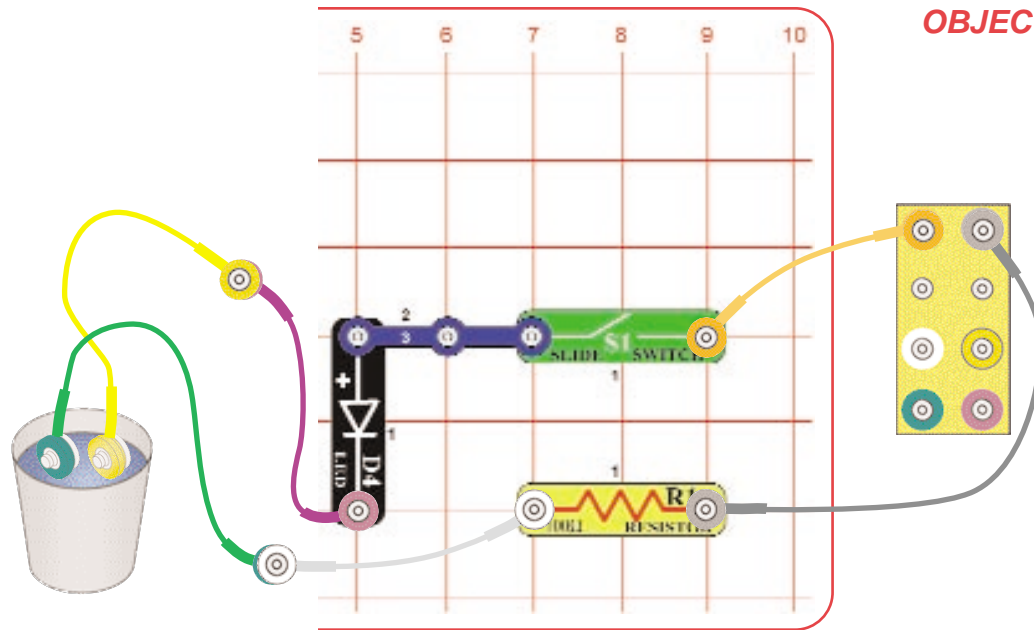

Build the circuit at left and connect the jumper wires to it, but leave the loose ends of the green and yellow jumpers lying on the table initially. Turn on the slide switch (S1) - the LED (D4) will be dark because the air separating the jumpers has very high resistance. Touch the loose jumper ends to each other and the LED will be bright, because with a direct connection there is no resistance separating the jumpers.

Now take the loose ends of the green and yellow jumpers and place them in a cup of water, without letting them touch each other. The LED should be lit, indicating you have detected water!

For this experiment, your LED brightness may vary depending upon your local water supply. Pure water (like distilled water) has very high resistance, but drinking water has impurities mixed in that increase electrical conduction.



Project #20

Salt Water Detector

OBJECTIVE: To show how adding salt to water changes water's electrical characteristics.

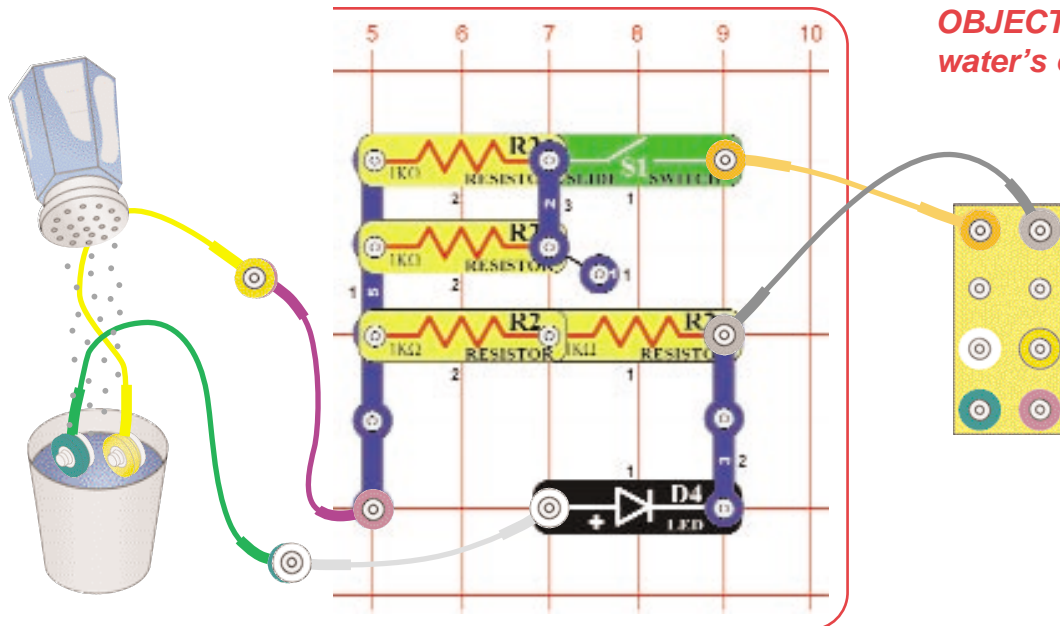

Build the circuit at left and connect the jumper wires to it, but place the loose ends of the green and yellow jumpers in a cup of water as in the preceding project. Turn on the slide switch (S1), the LED (D4) should be dimly lit. Slowly add salt to the water and see how the LED brightness changes, mix it a little so it dissolves. It will become very bright as you add more salt. You can use this bright LED condition as a saltwater detector! You can then reduce the LED brightness by adding more water to dilute the salt.

Take another cup of water and try adding other household substances like sugar to see if they increase the LED brightness as the salt did.

Project #21 One-Way Light

OBJECTIVE: To show how an LED works.

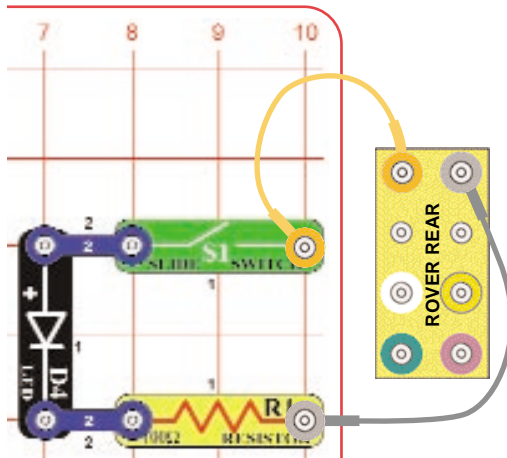

Build the circuit, place the base grid centered on the Rover body, and connect the jumper wires as shown. When you close the slide switch (S1), electricity flows from the batteries through the switch (S1), the LED (D4), the resistor (R1), and back to the battery.

The switch controls the electricity and the LED (light emitting diode) converts electricity into light. The resistor limits how much electricity can flow - without it the batteries would overload the LED and damage it! LEDs are used in all types of electronic equipment to indicate conditions and pass information to the user of that equipment.

Reverse the position of the LED (so that the "+" side is next to the resistor). Turn on the switch - nothing happens. LEDs only allow electricity to flow in one direction, so the circuit doesn't work if the LED is backwards.

Project #22 Conduction Detector

OBJECTIVE: To make a circuit that detects the conduction of electricity in different materials.

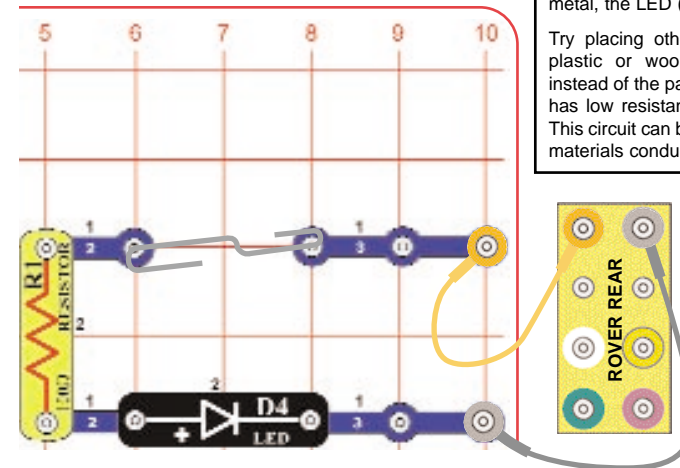

Build the circuit, place the base grid centered on the Rover body, and connect the jumper wires as shown. To complete the circuit, place a paperclip across the snaps as shown in the picture. If the paperclip is made of metal, the LED (D4) will be bright.

Try placing other materials (such as plastic or wood) across the snaps instead of the paperclip. If the material has low resistance, the LED will light. This circuit can be used to detect which materials conduct electricity.

Project #23

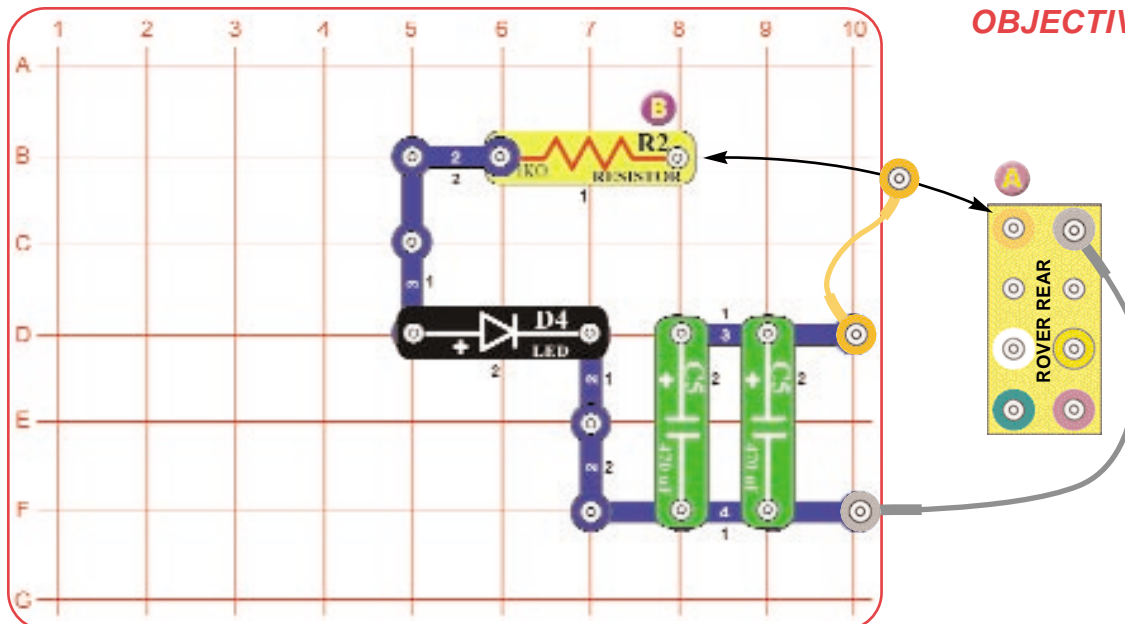

Make Your Own Battery

OBJECTIVE: To show how capacitors can store

Build the circuit and place the base grid centered on the Rover body. Connect the jumper wires, leaving one end of the orange jumper off as shown. Touch the loose end of the orange jumper to point A on the Rover rear for a moment. This fills up the 470 μ F capacitors (C5) with electricity.

Now move the orange jumper from point A to point B on the 1K Ω resistor (R2). The LED (D4) lights for a few seconds using the electricity stored in the capacitors. Move the orange jumper back to A to refill with electricity, and then to B several times.

Notice that a capacitor is not very efficient at storing electricity - compare how long the 470 μ Fs kept the LED lit for with how your batteries run all of your projects! That is because capacitors store electrical energy while a battery stores chemical energy.

OTHER SNAP CIRCUITS PRODUCTS!

Contact Elenco® to find out where you can purchase these products.

Snap Circuits Jr. Model SC-100



Build over 100 projects

Including:

- Flying saucer
- Spin draw
- Sound activated switch
- Alarm circuit

Contains over 30 parts

Including:

- Photoresistor
- Motor
- Music IC
- Space War IC

Snap Circuits Model SC-300



Build over 300 projects

Including:

- AM radio
- Motion detector
- Lie detector
- Burglar alarm

Contains over 60 parts

Including:

- Two transistors
- Microphone
- Power amplifier IC
- Variable capacitor

Snap Circuits Pro Model SC-500



Build over 500 projects

Including:

- Digitally tuned FM radio
- Adjustable light control
- Digital voice recorder
- AC generator

Contains over 75 parts

Including:

- Recording IC
- FM module
- Transformer
- Analog meter

Snap Circuits Extreme Model SC-750



Build over 750 projects

Including:

- Strobe light
- Transistor AM radio
- Electromagnetism
- Rechargeable battery

Contains over 80 parts

Including:

- Solar cell
- Electromagnet
- Vibration switch
- Relay

Snap Circuits Mini Kits

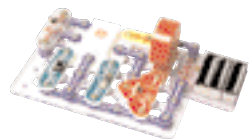

Musical Recorder
Model SCP-01

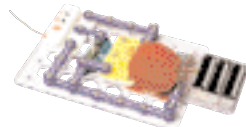

FM Radio
Model SCP-02



Motion Detector
Model SCP-03

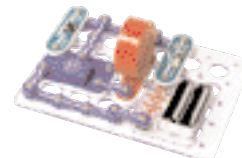

Music Box
Model SCP-04

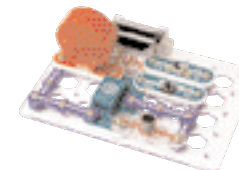

Space Battle
Model SCP-05

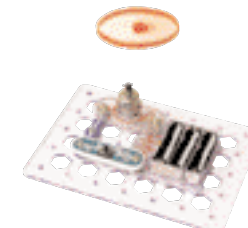

Flying Saucer
Model SCP-06

BONUS CIRCUITS FOR SNAP CIRCUITS OWNERS

If you own Snap Circuits Models SC-300, SC-500, or SC-750 (with 300+ experiments), then you may also build these circuits. Our web site (www.snapcircuits.net) has additional circuits. DO NOT use parts from other Snap Circuits kits with your Snap Rover except in our approved circuits - the Snap Rover uses higher voltage which could damage those parts.

Project #B1 Night Sound Rover

Use the remote control levers to drive Rover around. If the room is dark (or if you cover the phototresistor (RP), the the LED (D4) will flash and the speaker (SP) will make a machine gun sound. The photoresistor (RP) measures the light in the room, and controls the alarm IC (U2).

Project #B2 Six Function R/C

The remote control levers and buttons activate six functions: three LEDs (D1, D2, & D4), a horn (W1), a lamp, and a siren (U2 with SP).

Project #B3 R/C Motor

The remote control activates the LEDs (D1 & D2) and the horn (W1), and spins the motor (M1).

WARNING:
Moving parts.
Do not touch the fan or motor during operation.

WARNING:
Do not lean

SCROV-10 Snap Rover Block Layout

Important: If any parts are missing or damaged, **DO NOT RETURN TO RETAILER.** Call toll-free (800) 533-2441 or e-mail us at: help@elenco.com. Customer Service • 150 Carpenter Ave. • Wheeling, IL 60090 U.S.A.

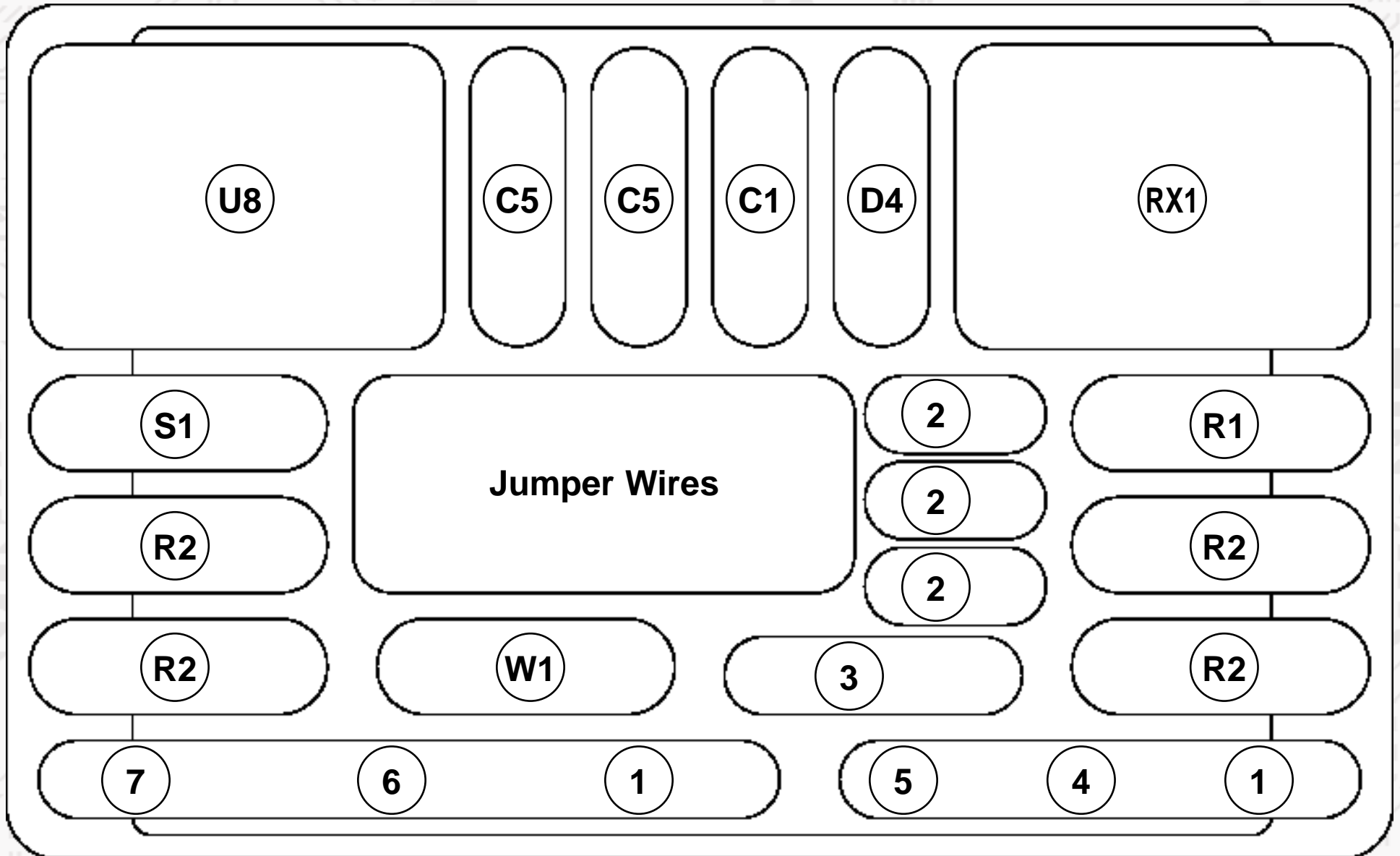

Elenco® Electronics, Inc.

150 Carpenter Avenue • Wheeling, IL 60090

(847) 541-3800 • Fax: (847) 520-0085 • Web site: www.elenco.com • e-mail: elenco@elenco.com