



EMC TEST REPORT for UNII Device
No. 141200187SHA-003

Applicant : Pass & Seymour, Inc., d/b/a Legrand
301 Fulling Mill Road, Suite G, Middletown,
Pennsylvania 17057 USA

Manufacturer : Hangzhou Samko Electronics Co. Ltd.
No.8,Jiaqi Road,Xianlin Street,Yuhang District, Hangzhou
City, Zhejiang Province, 311122, China

Equipment : Wireless Zone Player

Type/Model : NV-P100

SUMMARY

The equipment complies with the requirements according to the following standard(s):

47CFR Part 15 (2014): Radio Frequency Devices

ANSI C63.4 (2003): American National Standard for Methods of Measurement of Radio-Noise Emissions from Low-Voltage Electrical and Electronic Equipment in the Range of 9 kHz to 40 GHz

Date of issue: Dec 22, 2014

Prepared by:

Wakeyou Wang (*Project Engineer*)

Reviewed by:

Daniel Zhao (*Reviewer*)



FCC ID: YV8-NVP100
IC: 9922A- NVP100

Description of Test Facility

Name: Intertek Testing Services Limited Shanghai
Address: Building 86, No. 1198 Qinzhou Rd., North, Shanghai 200233, P.R. China

FCC Registration Number: 236597
IC Assigned Code: 2042B-1

Name of contact: Jonny Jing
Tel: +86 21 61278271
Fax: +86 21 54262353

Content

SUMMARY	1
DESCRIPTION OF TEST FACILITY	2
1. GENERAL INFORMATION	4
1.1 Applicant Information.....	4
1.2 Identification of the EUT	4
1.3 Technical specification	5
1.4 Mode of operation during the test / Test peripherals used.....	6
2. TEST SPECIFICATION	7
2.1 Instrument list	7
2.2 Test Standard	7
3. MAXIMUM CONDUCTED OUTPUT POWER & EIRP	9
3.1 Test limit	9
3.2 Test Configuration	9
3.3 Test procedure and test setup.....	9
3.4 Test protocol	10
4. POWER SPECTRAL DENSITY	11
4.1 Test limit	11
4.2 Test Configuration	11
4.3 Test procedure and test setup.....	11
4.4 Test Protocol	12
5. MINIMUM 6dB BANDWIDTH	24
5.1 Limit.....	24
5.2 Test Configuration	24
5.3 Test Procedure and test setup.....	24
5.4 Test Protocol	25
6. RADIATED EMISSION	31
6.1 Test limit	31
6.2 Test Configuration	32
6.3 Test procedure and test setup.....	32
6.4 Test protocol	33
7. POWER LINE CONDUCTED EMISSION	38
7.1 Limit.....	38
7.2 Test configuration	38
7.3 Test procedure and test set up.....	39
7.4 Test protocol	40
8. 26 DB BANDWIDTH	41
8.1 Test limit	41
8.2 Test Configuration	41
8.3 Test procedure and test setup.....	41
8.4 Test protocol	42



1. General Information

1.1 Applicant Information

Applicant: Pass & Seymour, Inc., d/b/a Legrand
301 Fulling Mill Road, Suite G, Middletown,
Pennsylvania 17057 USA

Name of contact: Rick Kukulies

Tel: 1-859 817 7218

Fax: 1-859 817 7250

Manufacturer: Hangzhou Samko Electronics Co. Ltd.
No.8,Jiaqi Road,Xianlin Street,Yuhang District,
Hangzhou City, Zhejiang Province, 311122, China

Sample received date : June 1, 2014

Sample Identification No : /

Date of test : June 1, 2014 ~ Dec 10, 2014

1.2 Identification of the EUT

Equipment: Wireless Zone Player

Type/model: NV-P100

FCC ID: YV8-NVP100

IC: 9922A- NVP100



1.3 Technical specification

Operation Frequency Band: 5180 - 5240 MHz, 5745 – 5825MHz

Modulation: BPSK@6/9 Mbps
QPSK@12/18Mbps
16-QAM@24Mbps
64-QAM@48/54Mpb and above

Gain of Antenna: Internal antenna

Antenna Type	Applied Chain	Gain of antenna
P/N 1002985	1 (Front)	2.4GHz band: 3.7dBi
		5GHz band: 5.7dBi
P/N 1002988	2 (Right)	2.4GHz band: 4.4dBi
		5GHz band: 6.0dBi

Rating: AC 100-240V, 50-60Hz, 70W

Description of EUT: The EUT is a wireless audio device containing Wi-Fi module. There is one model only.

Port identification: Line in × 1; Line out × 1; L × 2; R × 2; USB × 1;
LAN × 1

Category of EUT: Class B

EUT type: Table top Floor standing

Used conduction: Indoor only Outdoor Indoor & Outdoor

EUT Modes: 802.11a/b/g/n20 (802.11a/n20 assessed in this report)

Channel Number: Channel 36 - 48, Channel 149 - 165

Channel Description: The channel spacing is 20MHz.

MIMO Function Description:

Freq. Band	Modulation	Transmission / Idle		Beam forming	Beam forming gain
		Chain 1	Chain 2		
5180 - 5240MHz	802.11a	Transmission	Idle	NO	0 dBi
5745 – 5825MHz	802.11 n20	Transmission	Transmission	NO	0 dBi



1.4 Mode of operation during the test / Test peripherals used

While testing transmitting mode of EUT, the internal modulation was applied.

The lowest, middle and highest channel were tested as representatives.

Test Peripherals:

PC: HP ProBook 6450b

Test software setting:

The power level setting for 802.11a/n is used with the software offered by the manufactory.

Mode	Frequency (MHz)	Software Setting	Duty Cycle
802.11a 802.11n20	5180	16.0	99%
	5200	16.0	99%
	5240	16.0	99%
	5745	16.0	99%
	5785	16.0	99%
	5825	16.0	99%

Data rate VS Power

The pre-scan for the conducted power with all rates in each modulation and bands was used, and the worst case was found and used in all test cases.

After this pre-scan,we choose the following table of the data rata as the worst case.

Mode	Worst case data rate
802.11a	6Mbps
802.11 n20	MCS8



2. Test Specification

2.1 Instrument list

Equipment	Type	Manu.	Internal no.	Cal. Date	Due date
Test Receiver	ESCS 30	R&S	EC 2107	2014-10-21	2015-10-20
Test Receiver	ESIB 26	R&S	EC 3045	2014-10-20	2015-10-19
A.M.N.	ESH2-Z5	R&S	EC 3119	2014-1-9	2015-1-8
Bilog Antenna	CBL 6112D	TESEQ	EC 4206	2013-4-28	2015-4-27
Horn antenna	HF 906	R&S	EC 3049	2013-4-28	2015-4-27
Pre-amplifier	Pre-amp 18	R&S	EC 3222	2014-4-12	2015-4-11
Semi-anechoic chamber	-	Albatross project	EC 3048	2014-5-12	2015-5-11
High Pass Filter	WHKX 1.0/15G-10SS	Wainwright	EC4297-1	2014-1-8	2015-1-7
Power sensor / Power meter	N1911A/N1921A	Agilent	EC4318	2014-04-12	2015-04-11
Loop Antenna	FMZB 1516	SCHWARZB ECK	/	2014-11-29	2015-11-28
Temperature Camber	SETH-E	tayasaf	EC4315	2014-4-9	2015-4-9

2.2 Test Standard

47CFR Part 15:2014

ANSI C63.4: 2003

KDB789033 D02 General UNII Test Procedures New Rules v01

2.3 Test Summary

This report applies to tested sample only. This report shall not be reproduced in part without written approval of Intertek Testing Service Shanghai Limited.

TEST ITEM	FCC REFERANCE	RESULT
Maximum Conducted Output Power & EIRP	15.407(a)	Pass
Power spectral density	15.407(a)	Pass
Minimum 6dB Bandwidth	15.407(e)	Pass
Radiated emission	15.407(b), 15.209	Pass
Power line conducted emission	15.207	Pass
26 dB Bandwidth	15.403(i)	Tested

3. Maximum Conducted Output Power & EIRP

Test result: Pass

3.1 Test limit

- For outdoor access point operating in 5150-5250MHz: 30dBm, Maximum EIRP at any elevation angle above 30 degrees ≤ 21 dBm;
- For indoor access point operating in 5150-5250MHz: 30dBm;
- For fixed point-to-point access point operating in 5150-5250MHz: 30dBm;
- For mobile and portable client devices operating in 5150-5250MHz: 24dBm;
- For device operating in 5.25-5.35 GHz and 5.47-5.725 GHz: 24dBm or 11dBm + 10logB (B is 26dB bandwidth);
- For device operating in 5.725-5.85 GHz: 30dBm

If the transmitting antenna of directional gain greater than 6dBi is used, the power shall be reduced by the amount in dB that the directional gain of the antenna exceeds 6dBi (For fixed point-to-point access point operating in 5150-5250MHz, replaced with 23dBi).

3.2 Test Configuration

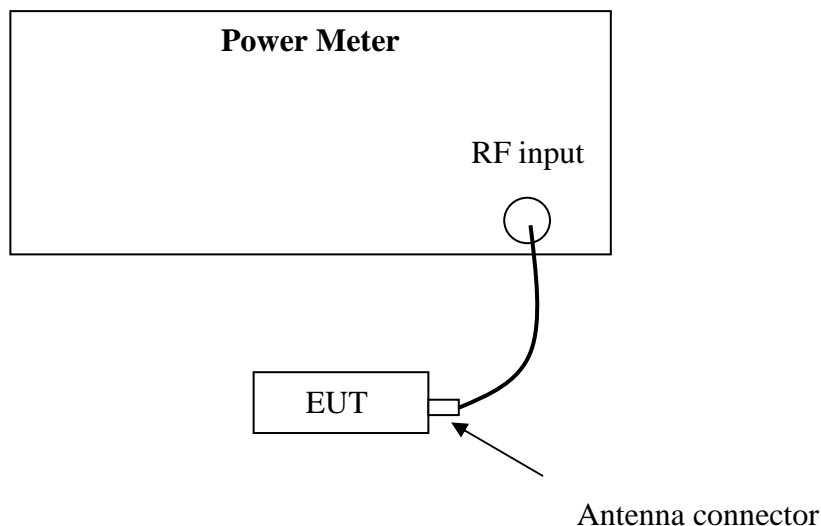

3.3 Test procedure and test setup

The power output per FCC §15.407(a) was measured on the EUT using a 50 ohm RF cable connected to spectrum analyzer and the measurement method refer to KDB 789033D02: Method PM.

3.4 Test protocol

Temperature : 25 °C
Relative Humidity : 55 %

Mode	Freq. (MHz)	Reading (dBm)		Total Conducted Power (dBm)	Limit (dBm)	Margin (dB)
		Chain 1	Chain 2			
802.11a	5180	12.90	-	12.90	24.00	11.10
	5200	13.00	-	13.00	24.00	11.00
	5240	13.00	-	13.00	24.00	11.00
	5745	13.80	-	13.80	30.00	16.20
	5785	13.60	-	13.60	30.00	16.40
	5825	13.10	-	13.10	30.00	16.90
802.11n20	5180	12.70	12.40	15.60	24.00	8.40
	5200	12.70	12.20	15.50	24.00	8.50
	5240	12.50	13.00	15.80	24.00	8.20
	5745	13.00	14.80	17.00	30.00	13.00
	5785	12.80	14.40	16.70	30.00	13.30
	5825	12.20	13.20	15.70	30.00	14.30

4. Power spectral density

Test result: Pass

4.1 Test limit

- For outdoor access point operating in 5150-5250MHz: 17dBm/MHz;
- For indoor access point operating in 5150-5250MHz: 17dBm/MHz;
- For fixed point-to-point access point operating in 5150-5250MHz: 17dBm/MHz;
- For mobile and portable client devices operating in 5150-5250MHz: 11dBm/MHz;
- For device operating in 5.25-5.35 GHz and 5.47-5.725 GHz: 11dBm/MHz;
- For device operating in 5.725-5.85 GHz: 30dBm/500kHz;

If the transmitting antenna of directional gain greater than 6dBi is used, the power shall be reduced by the amount in dB that the directional gain of the antenna exceeds 6dBi (For fixed point-to-point access point operating in 5150-5250MHz, replaced with 23dBi).

4.2 Test Configuration

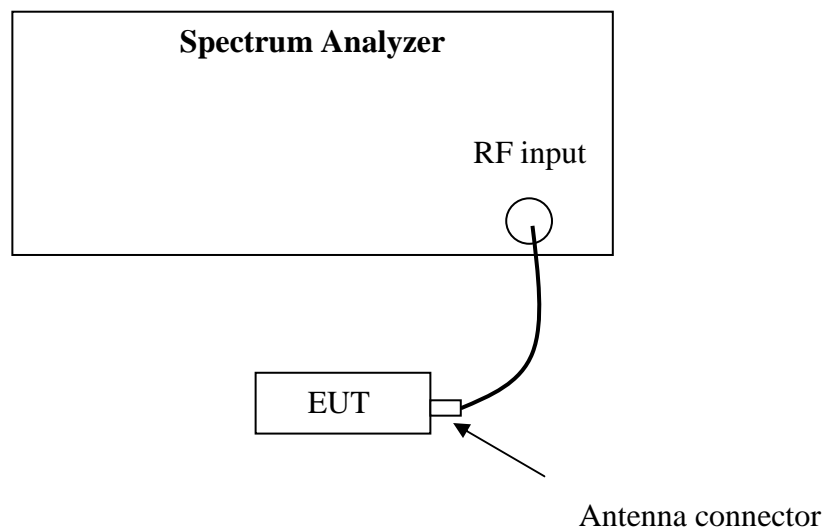

4.3 Test procedure and test setup

The power spectral density per FCC §15.407(a) was measured from the antenna port of the EUT using a 50 ohm spectrum analyzer with the resolution bandwidth set at 1MHz, the video bandwidth set >RBW (measurement method refer to KDB 789033D02: section F).



4.4 Test Protocol

Temperature : 25 °C
Relative Humidity : 55 %

Mode	Freq. (MHz)	PSD (dBm/MHz)		Total PSD (dBm/MHz)	Limit (dBm/MHz)
		Chain 1	Chain 2		
802.11a	5180	0.83	-	0.83	11.00
	5200	0.46	-	0.46	11.00
	5240	-0.22	-	-0.22	11.00

Frequency L – Chain 1

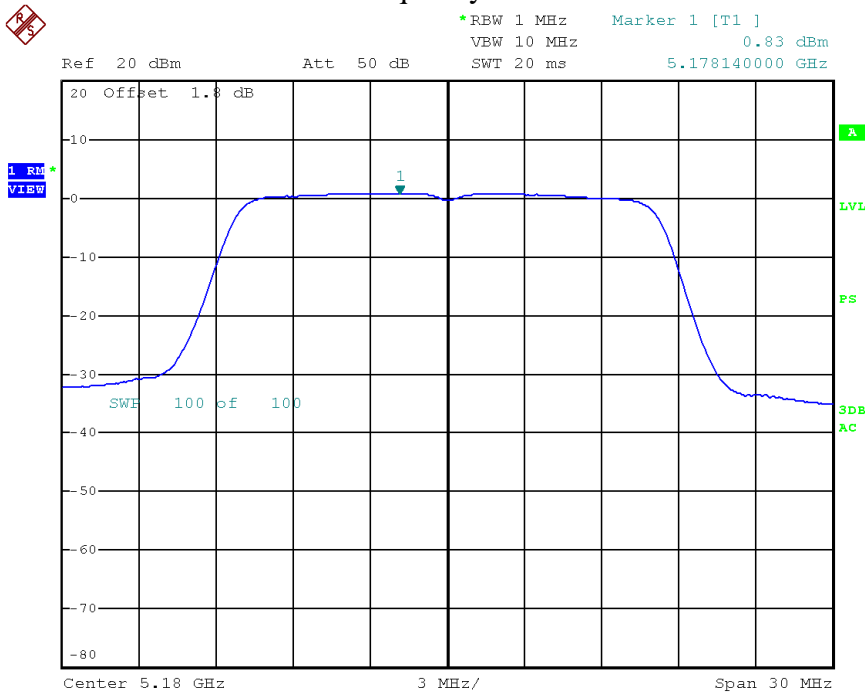

Date: 26.JUN.2014 14:51:35

Frequency M – Chain 1

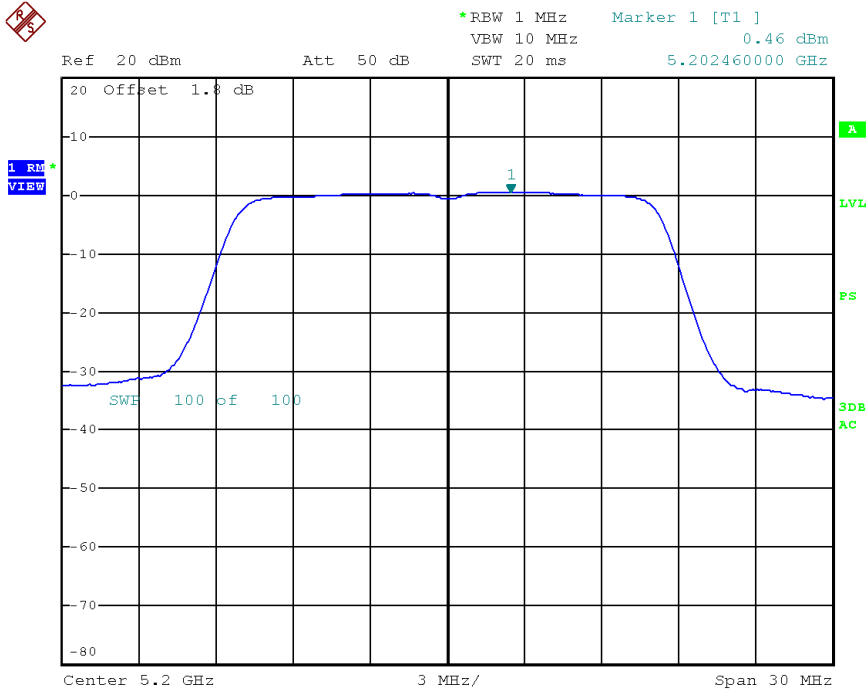

Date: 26.JUN.2014 14:52:12

Frequency H – Chain 1

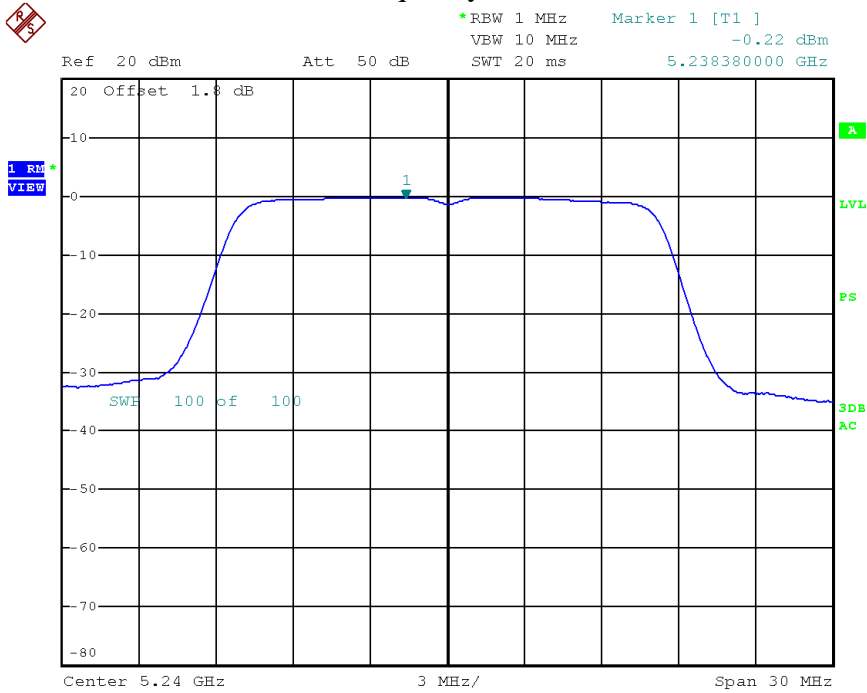

Date: 26.JUN.2014 14:53:01

Mode	Freq. (MHz)	PSD (dBm/MHz)		Total PSD (dBm/MHz)	Limit (dBm/500kHz)
		Chain 1	Chain 2		
802.11a	5745	-0.44	-	-0.44	30.00
	5785	-0.18	-	-0.18	30.00
	5825	0.49	-	0.49	30.00

Frequency L – Chain 1

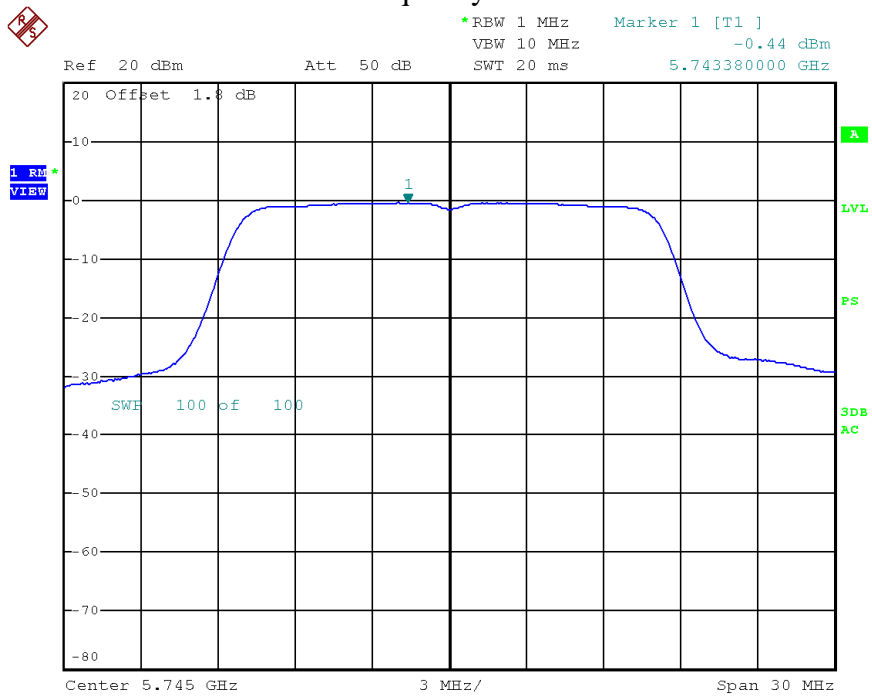

Date: 26.JUN.2014 14:54:12

Frequency M – Chain 1

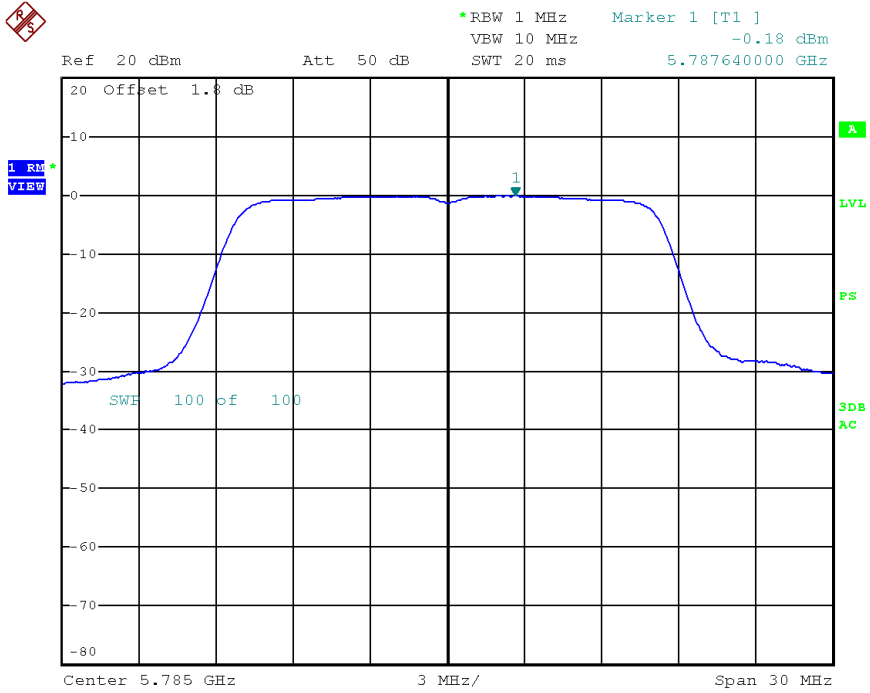

Date: 26.JUN.2014 14:54:46

Frequency H – Chain 1

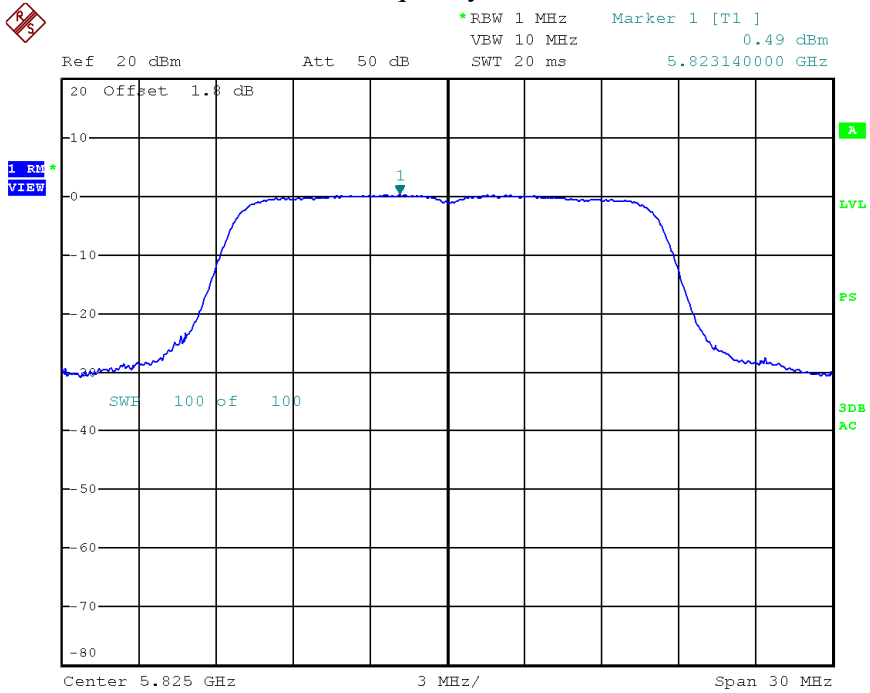

Date: 26.JUN.2014 14:55:25

Mode	Freq. (MHz)	PSD (dBm/MHz)		Total PSD (dBm/MHz)	Limit (dBm/MHz)
		Chain 1	Chain 2		
802.11n20	5180	-0.48	1.16	3.43	11.00
	5200	-0.61	0.66	3.08	11.00
	5240	-1.04	-0.44	2.28	11.00

Frequency L – Chain 1

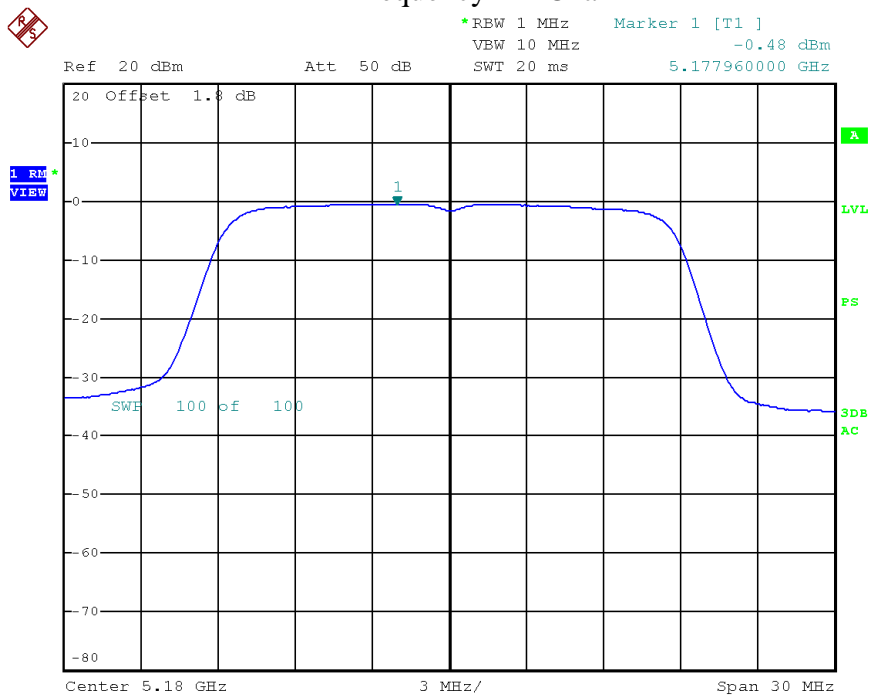

Date: 26.JUN.2014 14:56:34

Frequency M – Chain 1

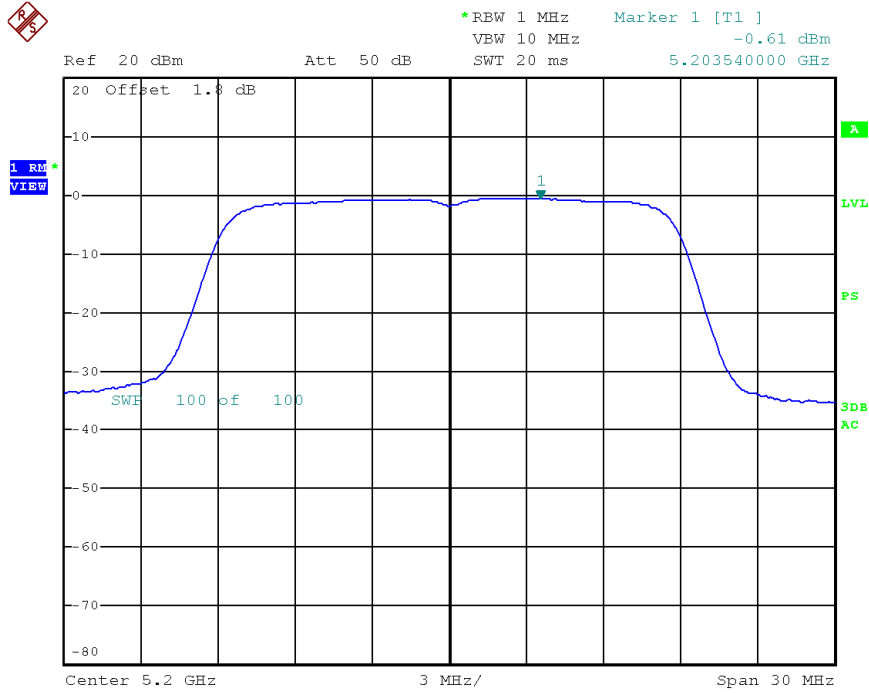

Date: 26.JUN.2014 14:57:04

Frequency H – Chain 1

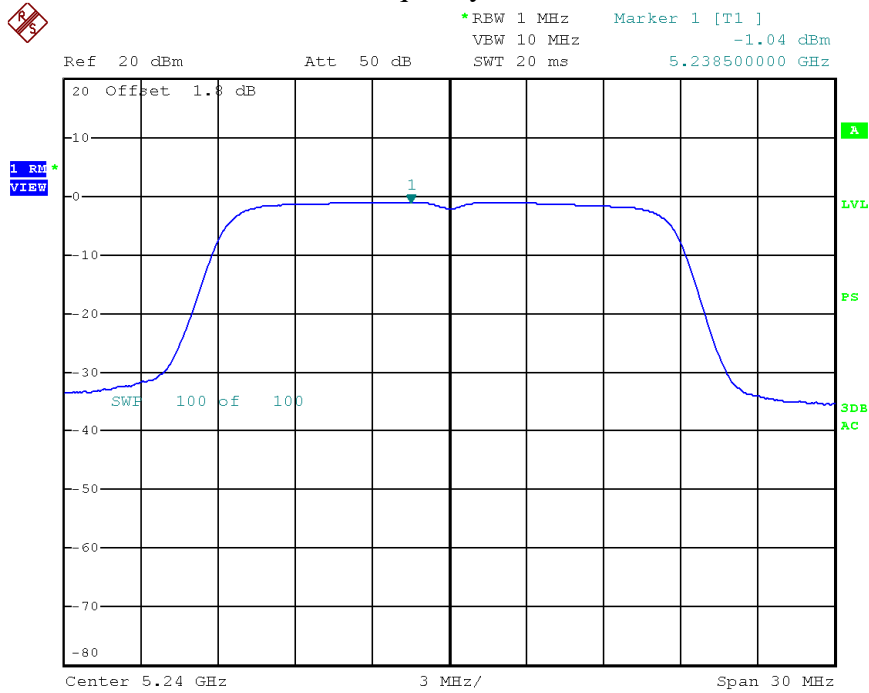

Date: 26.JUN.2014 14:58:07

Frequency L – Chain 2

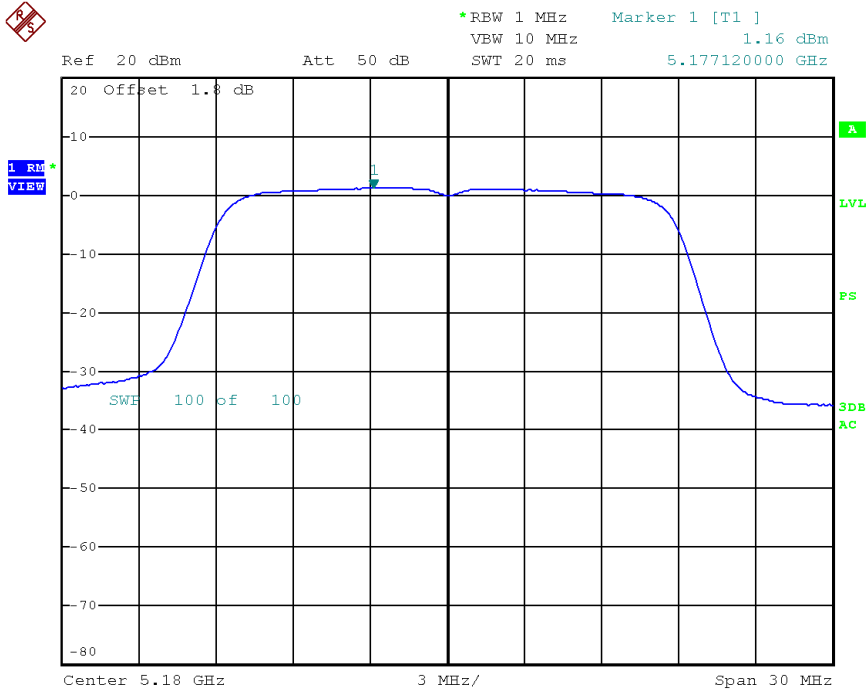

Date: 26.JUN.2014 14:33:37

Frequency M – Chain 2

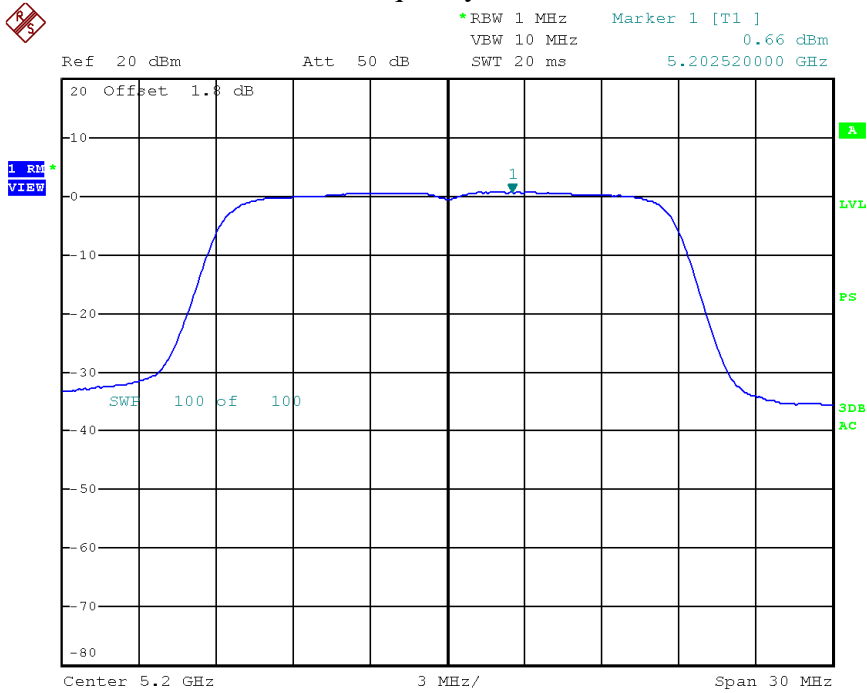

Date: 26.JUN.2014 14:34:16



Frequency H – Chain 2

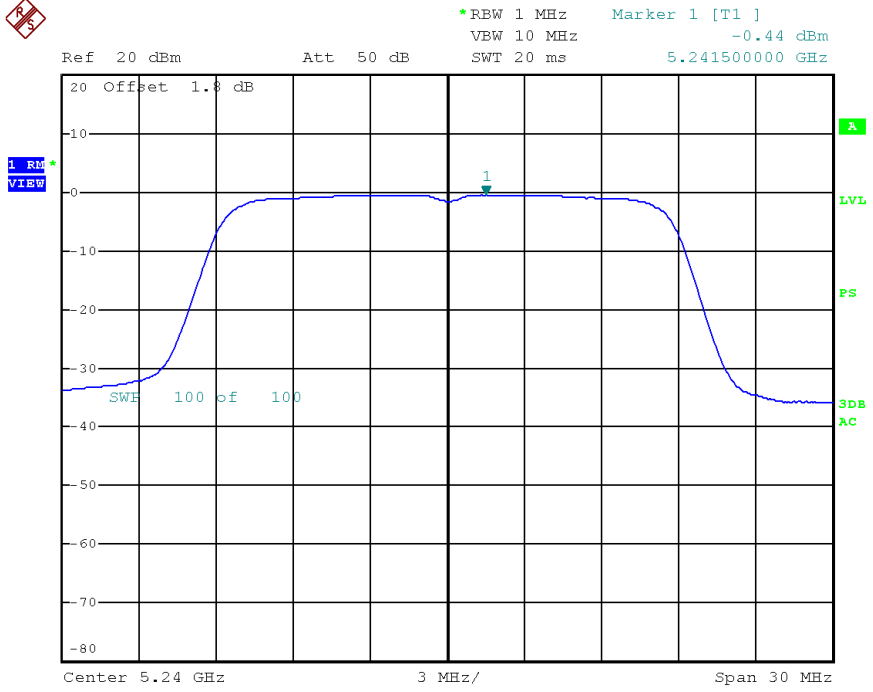

Date: 26.JUN.2014 14:35:06

Mode	Freq. (MHz)	PSD (dBm/MHz)		Total PSD (dBm/MHz)	Limit (dBm/500kHz)
		Chain 1	Chain 2		
802.11n20	5745	-0.38	2.73	4.46	30.00
	5785	-0.01	1.66	3.92	30.00
	5825	-0.48	1.23	3.47	30.00

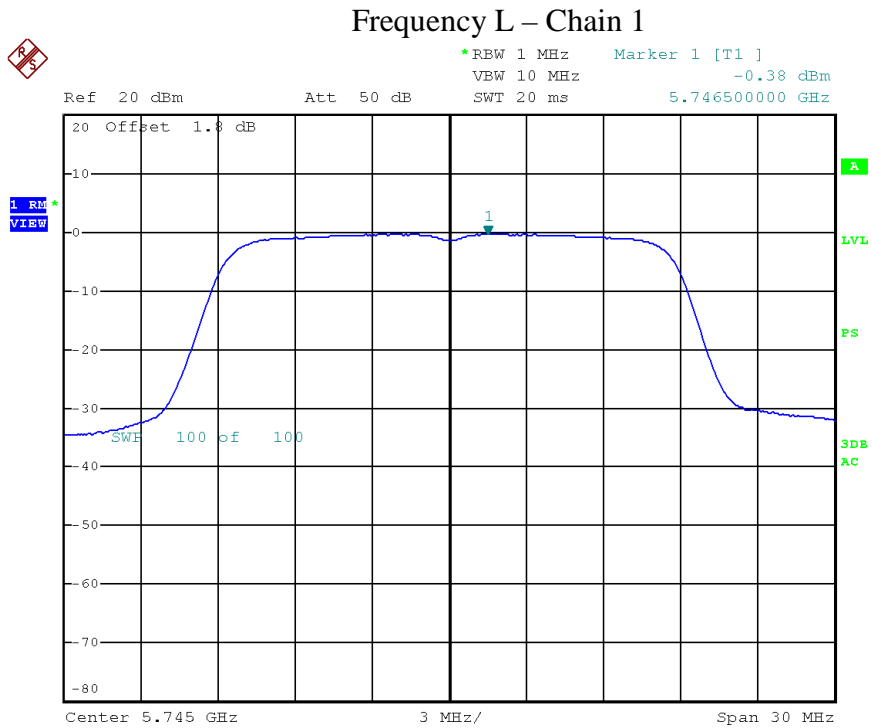

Date: 26.JUN.2014 14:58:58

Frequency M – Chain 1

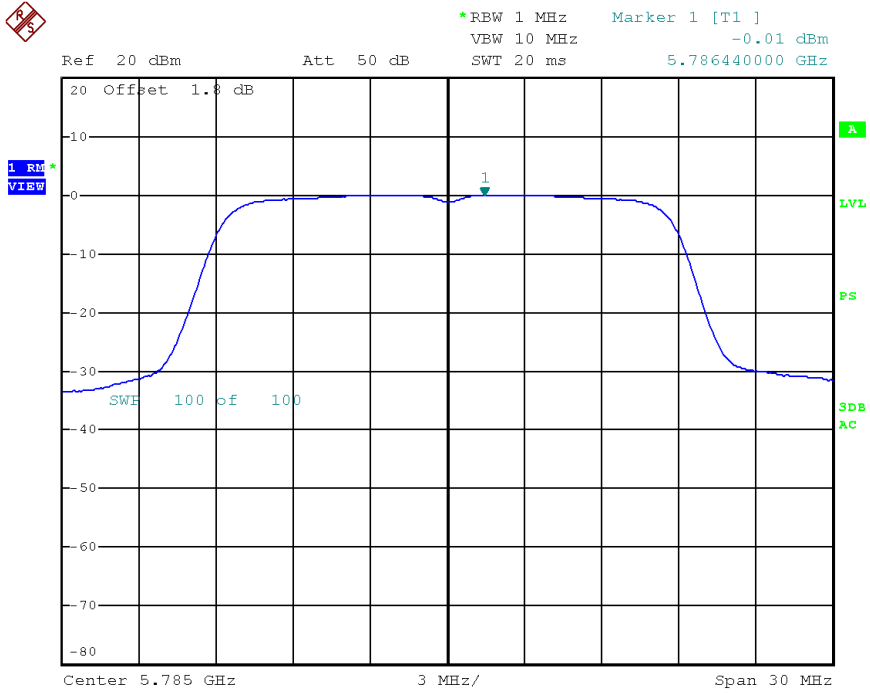

Date: 26.JUN.2014 14:59:43

Frequency H – Chain 1

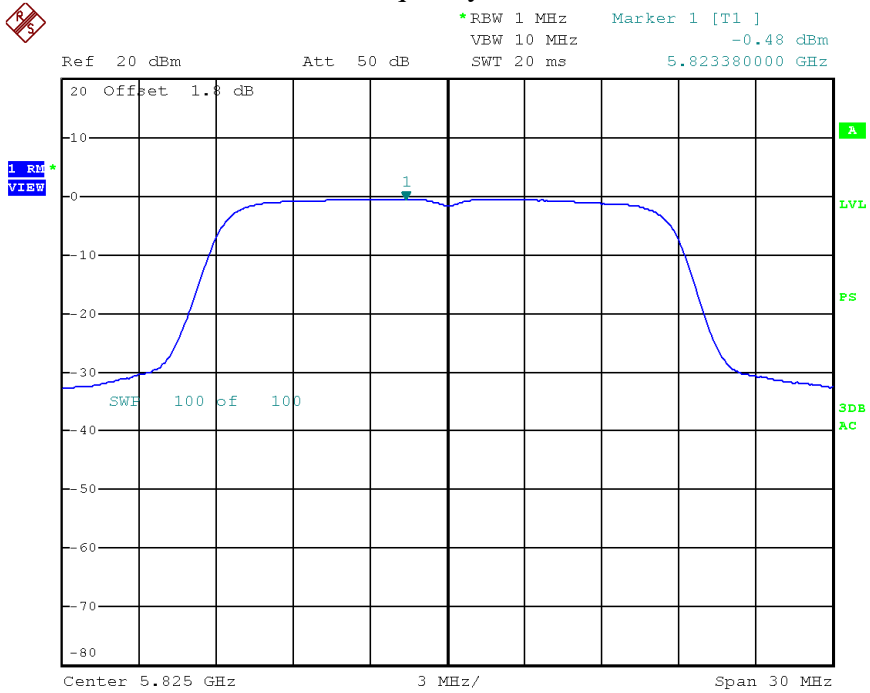

Date: 26.JUN.2014 15:00:18

Frequency L – Chain 2

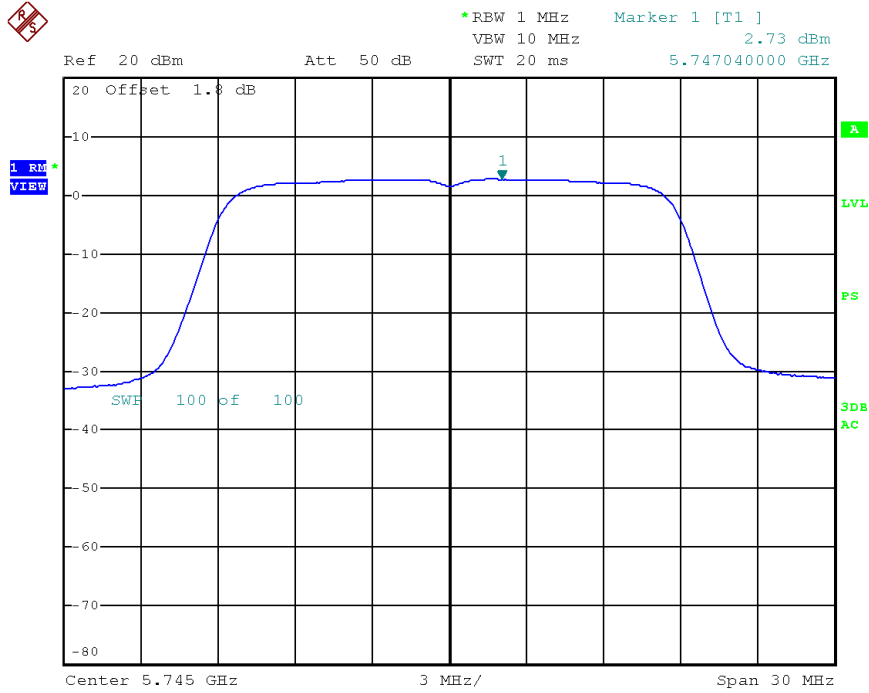

Date: 26.JUN.2014 14:36:00

Frequency M – Chain 2

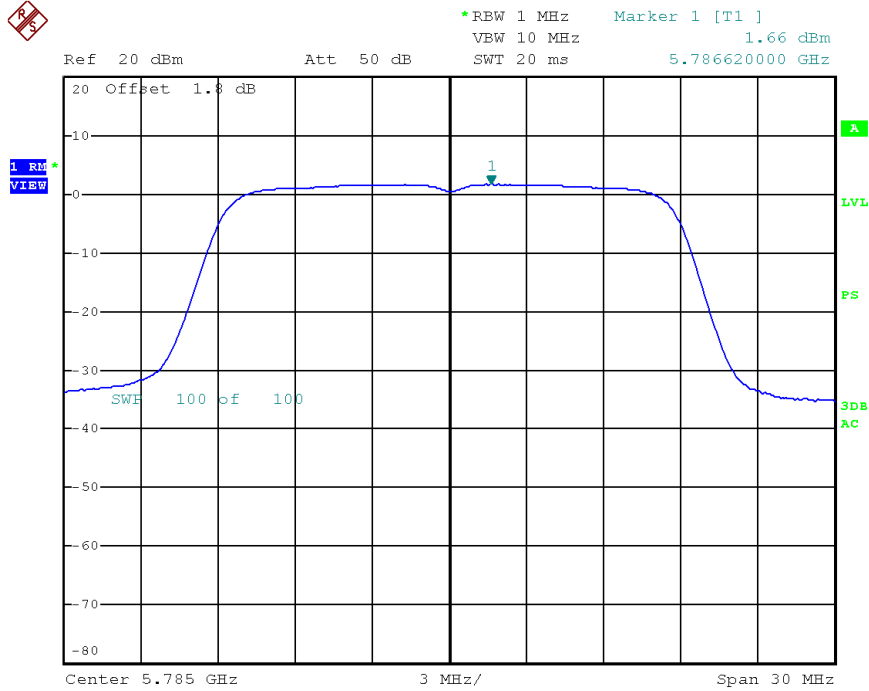

Date: 26.JUN.2014 14:36:40

Frequency H – Chain 2

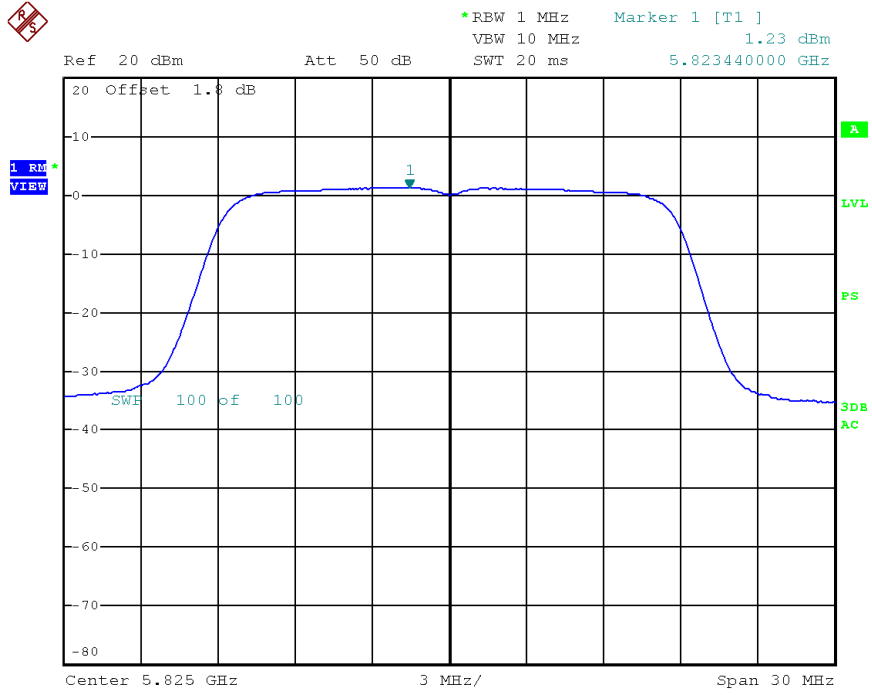

Date: 26.JUN.2014 14:37:37

5. Minimum 6dB Bandwidth

Test result: PASS

5.1 Limit

For systems using digital modulation techniques that may operate in the 5725 - 5850 MHz band, the minimum 6 dB bandwidth shall be at least 500 kHz.

5.2 Test Configuration

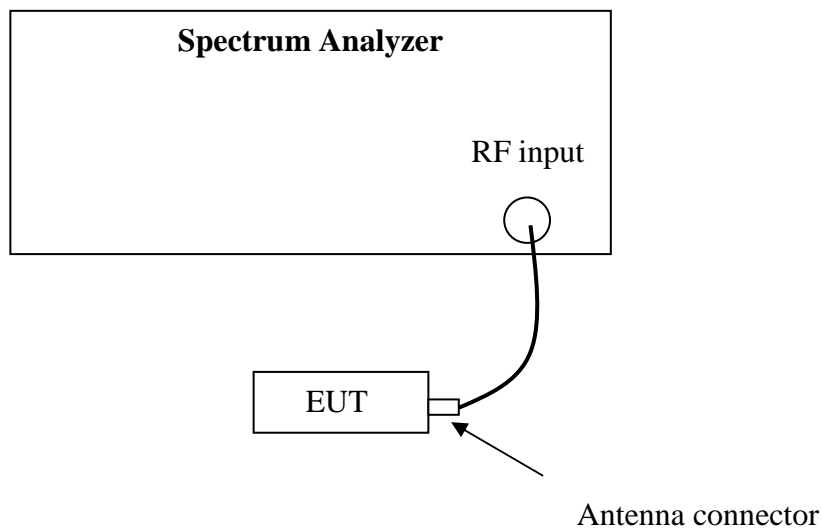

5.3 Test Procedure and test setup

The power spectrum density per FCC §15.407(a)(6) was measured from the antenna port of the EUT. Using a 50ohm spectrum analyzer (measurement method refers to KDB 789033D02: Section C).

5.4 Test Protocol

Temperature : 25 °C
Relative Humidity : 55 %

Mode	Freq. (MHz)	Chain 1 (MHz)	Chain 2 (MHz)	Limit (MHz)
802.11a	5745	16.44	-	≥0.5
	5785	16.36	-	
	5825	16.36	-	

Frequency L – Chain 1

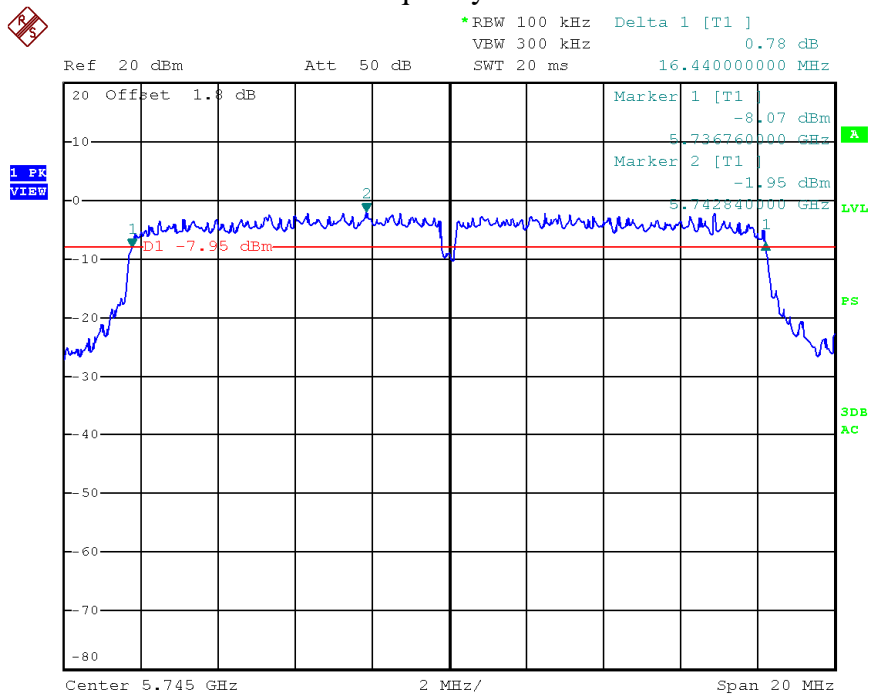

Date: 24.JUN.2014 16:40:57

Frequency M – Chain 1

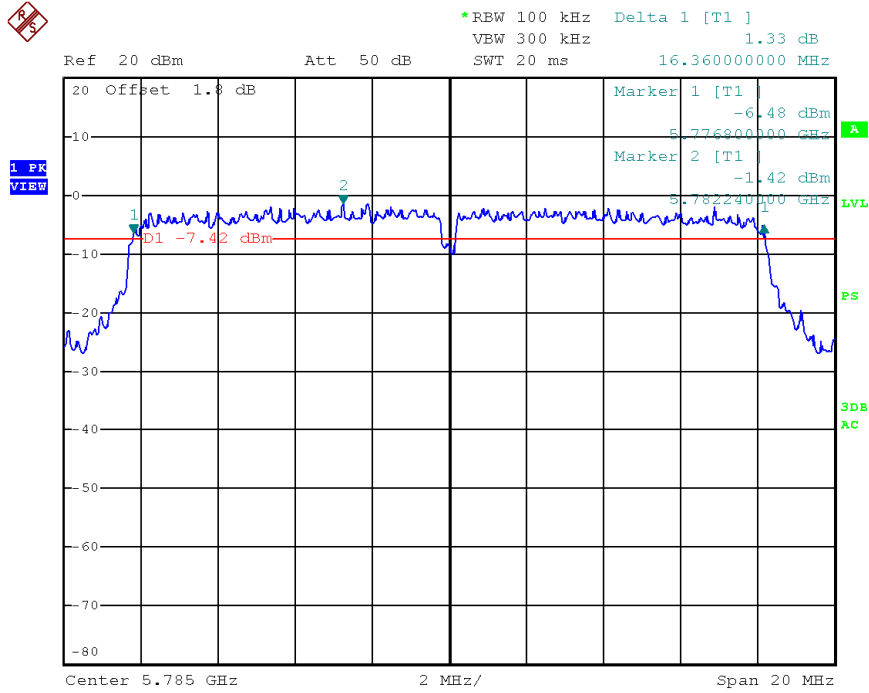

Date: 24.JUN.2014 16:41:53

Frequency H – Chain 1

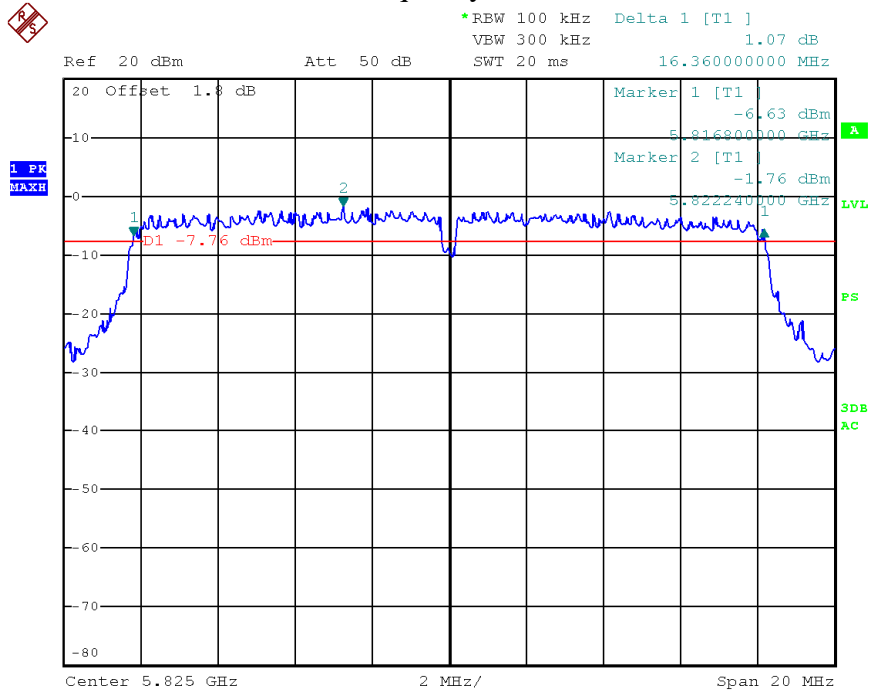

Date: 24.JUN.2014 16:42:52

Mode	Freq. (MHz)	Chain 1 (MHz)	Chain 2 (MHz)	Limit (MHz)
802.11n20	5745	17.60	16.96	≥0.5
	5785	17.60	17.52	
	5825	17.56	16.92	

Frequency L – Chain 1

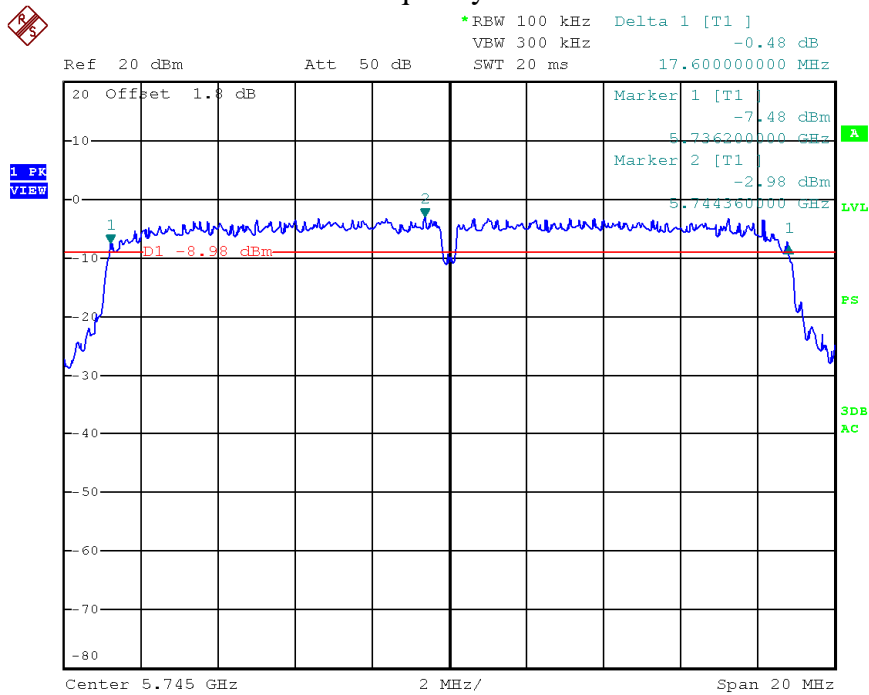

Date: 24.JUN.2014 16:44:55

Frequency M – Chain 1

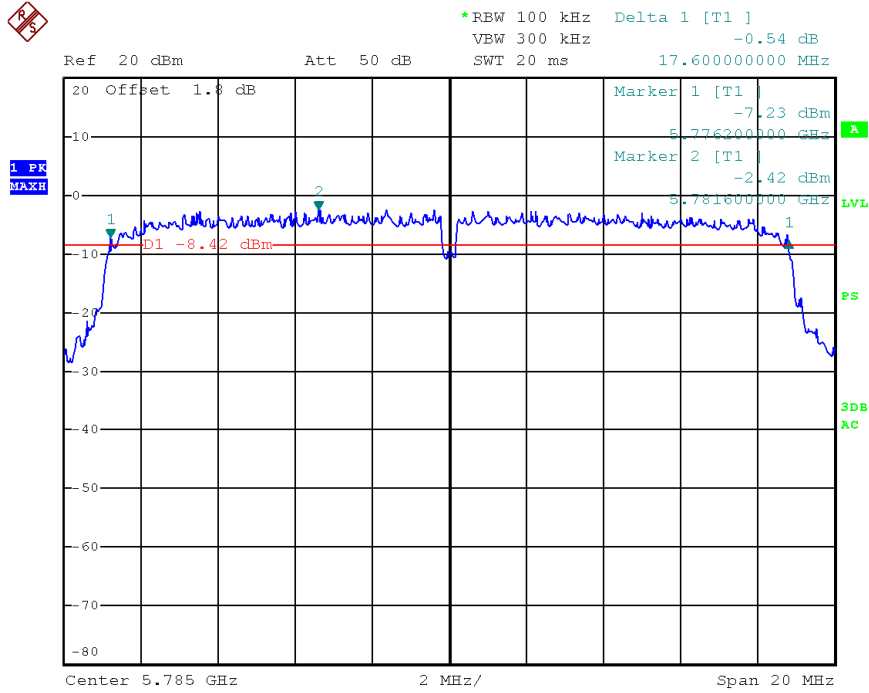

Date: 24.JUN.2014 16:45:45

Frequency H – Chain 1

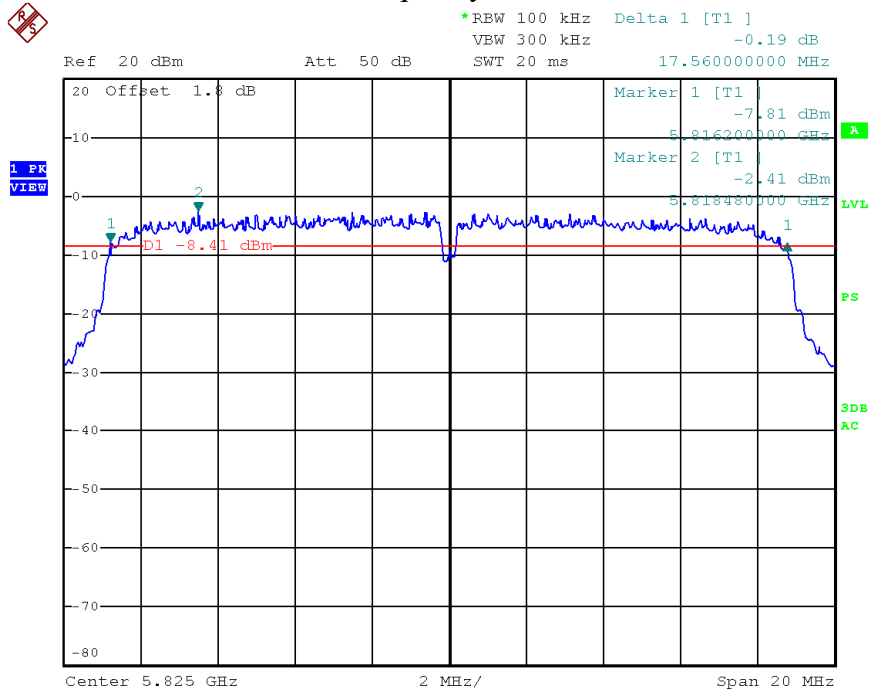

Date: 24.JUN.2014 16:46:34

Frequency L – Chain 2

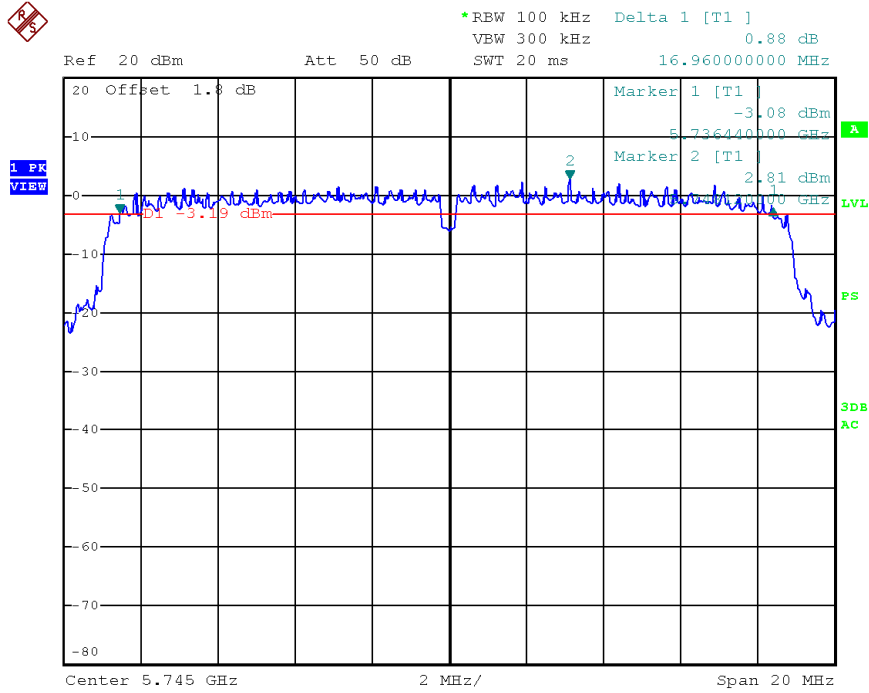

Date: 24.JUN.2014 16:27:17

Frequency M – Chain 2

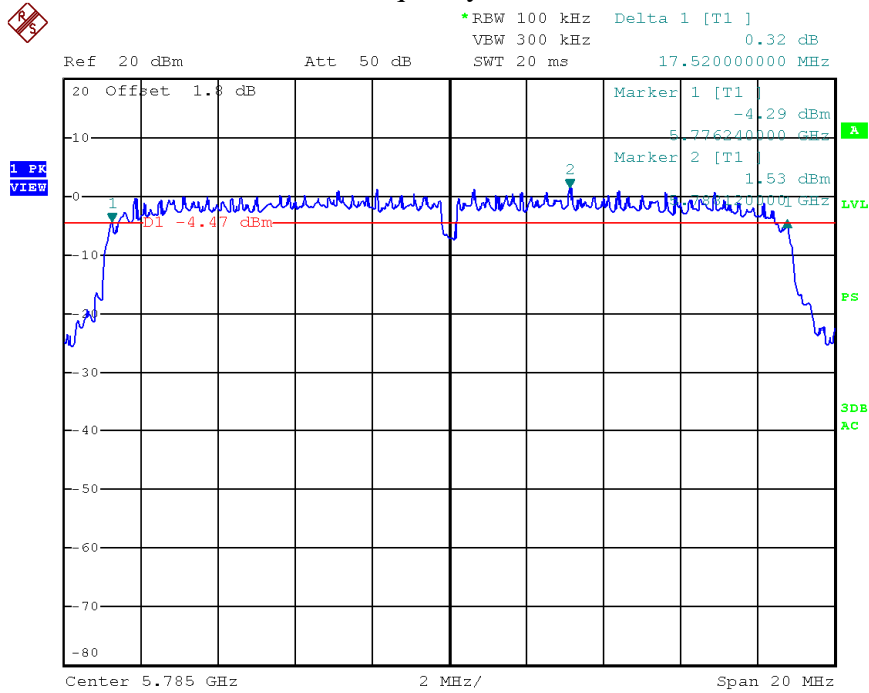

Date: 24.JUN.2014 16:28:24

Frequency H – Chain 2

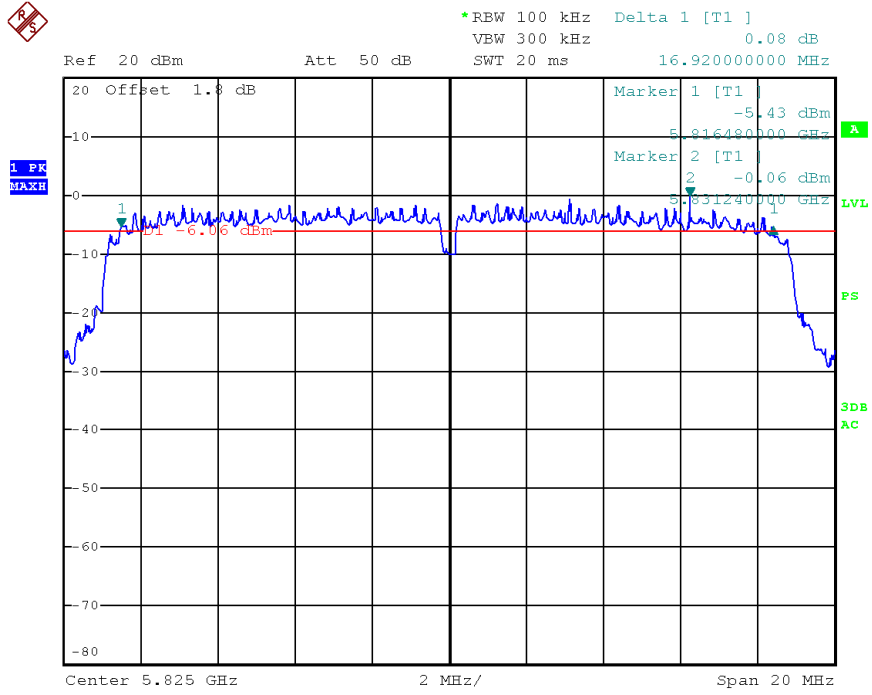

Date: 24.JUN.2014 16:31:05

6. Radiated emission

Test result: PASS

6.1 Test limit

6.1.1 The radiated emissions which are lower than 1GHz or fall in the restricted bands, as defined in §15.205(a), must also comply with the radiated emission limits specified in § 15.209(a) showed as below:

Frequency (MHz)	Field Strength (dBuV/m)	Measurement Distance (m)
30 - 88	40.0	3
88 - 216	43.5	3
216 - 960	46.0	3
Above 960	54.0	3

6.1.2 The emission which is outside the restrict bands, should comply with the EIRP limit as below:

For transmitters operating in the 5.15–5.25 / 5.25 – 5.35 / 5.47 – 5.725 GHz band: all emissions outside of the 5.15–5.35 / 5.47 – 5.725 GHz band shall not exceed an EIRP of -27dBm/MHz.

EIRP Limit (dBm)	Equivalent Field Strength (3m) (dBμV/m)
-27	68.20

For transmitters operating in the 5.725 – 5.85GHz band: emission among 5.715 – 5.725GHz & 5.85 – 5.86GHz shall not exceed an EIRP of -17dBm/MHz all emissions outside band shall not exceed an EIRP of -27dBm/MHz.

EIRP Limit (dBm)	Equivalent Field Strength (3m) (dBμV/m)
-27	68.20
-17	78.20

Assessed with 15.209(a):

Frequency (MHz)	Field Strength (dBuV/m)	Measurement Distance (m)
30 - 88	40.0	3
88 - 216	43.5	3
216 - 960	46.0	3
Above 960	54.0	3

6.2 Test Configuration

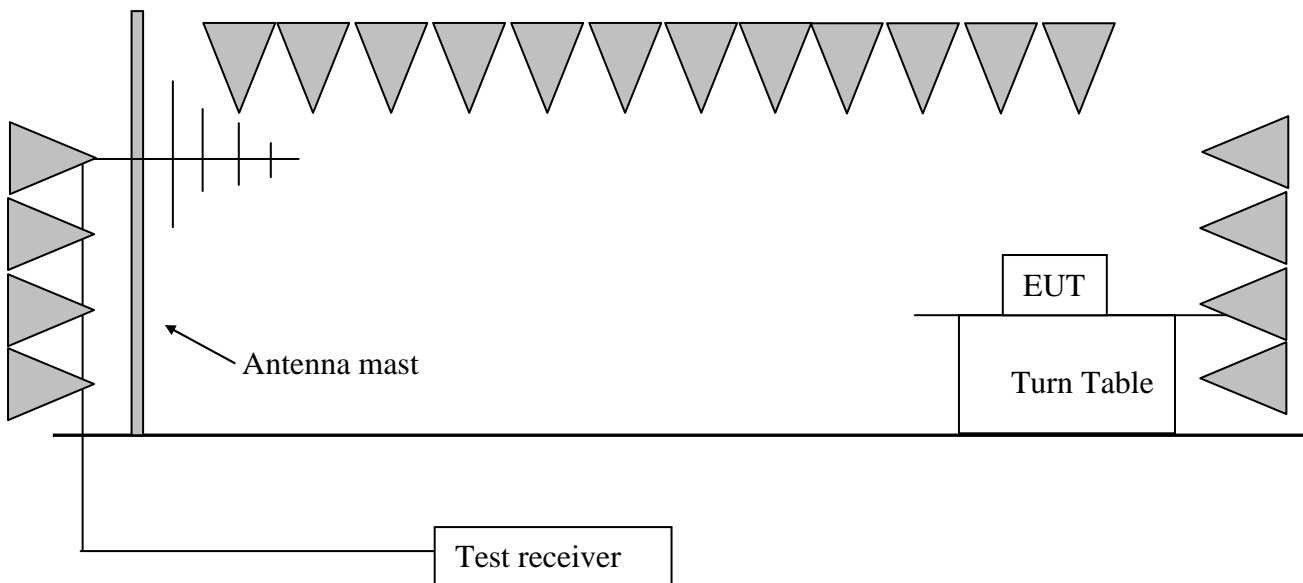

6.3 Test procedure and test setup

The measurement was applied in a semi-anechoic chamber. While testing for spurious emission higher than 1GHz, if applied, the pre-amplifier would be equipped just at the output terminal of the antenna.

The EUT and simulators were placed on a 0.8m high wooden turntable above the horizontal metal ground plane. The turn table rotated 360 degrees to determine the position of the maximum emission level. The EUT was set 3 meters away from the receiving antenna which was mounted on an antenna mast. The antenna moved up and down between from 1meter to 4 meters to find out the maximum emission level.

The EUT was tested according to KDB 789033D02: Section G.

The radiated emission was measured using the Spectrum Analyzer with the resolutions bandwidth set as:

RBW = 100kHz, VBW = 300kHz (30MHz~1GHz)

RBW = 1MHz, VBW = 3MHz (>1GHz for PK);

RBW = 1MHz, VBW = 10Hz (>1GHz for AV);

6.4 Test protocol

Temperature : 25 °C
 Relative Humidity : 55 %

Mode 802.11a

CH (MHz)	Antenna	Frequency (MHz)	Correct Factor (dB/m)	Corrected Reading (dBuV/m)	Limit (dBuV/m)	Margin (dB)	Detector
5180	H	5178.15	42.80	99.30	/	/	PK
	V	53.32	10.40	38.20	40.00	1.80	QP
	H	125.25	16.00	37.60	43.50	5.90	PK
	H	356.57	17.10	39.30	46.00	6.70	PK
	H	5150.00	43.70	63.90	74.00	10.10	PK
	H	5150.00	43.70	49.50	54.00	6.50	AV
	V	10344.68	6.10	51.50	54.00	2.50	PK
	V	15635.27	10.50	48.70	54.00	5.30	PK
5200	H	5203.62	42.90	99.50	/	/	PK
	V	53.32	10.40	38.20	40.00	1.80	QP
	H	125.25	16.00	37.60	43.50	5.90	PK
	H	356.57	17.10	39.30	46.00	6.70	PK
	H	5150.00	43.70	63.80	74.00	10.20	PK
	H	5150.00	43.70	49.20	54.00	4.80	AV
	V	10384.76	6.20	52.20	54.00	1.80	PK
	V	13791.58	10.20	47.10	54.00	6.90	PK
5240	H	5240.30	43.00	99.80	/	/	PK
	V	53.32	10.40	38.20	40.00	1.80	QP
	H	125.25	16.00	37.60	43.50	5.90	PK
	H	356.57	17.10	39.30	46.00	6.70	PK
	V	10484.96	6.50	53.70	74.00	20.30	PK
	V	10484.96	6.50	43.10	54.00	10.90	AV
	V	16597.19	11.60	48.60	54.00	5.40	PK

CH (MHz)	Antenna	Frequency (MHz)	Correct Factor (dB/m)	Corrected Reading (dBuV/m)	Limit (dBuV/m)	Margin (dB)	Detector
5745	H	5746.09	43.90	105.10	/	/	PK
	V	53.32	10.40	38.20	40.00	1.80	QP
	H	125.25	16.00	37.60	43.50	5.90	PK
	H	356.57	17.10	39.30	46.00	6.70	PK
	H	5460.00	-2.10	41.90	54.00	12.10	PK
	V	11486.97	7.40	60.60	74.00	13.40	PK
	V	11486.97	7.40	50.00	54.00	4.00	AV
	V	17238.47	12.40	54.30	74.00	19.70	PK
	V	17238.47	12.40	44.80	54.00	8.80	AV
5785	H	5786.45	43.90	105.30	/	/	PK
	V	53.32	10.40	38.20	40.00	1.80	QP
	H	125.25	16.00	37.60	43.50	5.90	PK
	H	356.57	17.10	39.30	46.00	6.70	PK
	H	5460.00	-2.10	41.70	54.00	12.30	PK
	V	11567.13	7.40	54.60	74.00	19.40	PK
	V	11567.13	7.40	45.10	54.00	8.90	AV
	V	17353.18	12.60	53.50	74.00	20.50	PK
	V	17353.18	12.60	43.70	54.00	10.30	AV
5825	H	5822.24	44.00	105.30	/	/	PK
	V	53.32	10.40	38.20	40.00	1.80	QP
	H	125.25	16.00	37.60	43.50	5.90	PK
	H	356.57	17.10	39.30	46.00	6.70	PK
	H	7250.00	2.40	45.40	54.00	8.60	PK
	V	11647.29	7.30	54.10	74.00	19.90	PK
	V	11647.29	7.30	44.40	54.00	9.60	AV
	V	17472.33	13.10	52.40	74.00	21.60	PK
	V	17472.33	13.10	42.00	54.00	12.00	AV



Mode 802.11 n20

CH (MHz)	Antenna	Frequency (MHz)	Correct Factor (dB/m)	Corrected Reading (dBuV/m)	Limit (dBuV/m)	Margin (dB)	Detector
5180	H	5182.36	42.80	101.70	/	/	PK
	V	53.32	10.40	38.20	40.00	1.80	QP
	H	125.25	16.00	37.60	43.50	5.90	PK
	H	356.57	17.10	39.30	46.00	6.70	PK
	H	5150.00	43.70	64.20	74.00	9.80	PK
	H	5150.00	43.70	49.50	54.00	4.50	AV
	V	10344.68	6.10	51.80	54.00	2.20	PK
	V	15635.27	10.50	49.00	54.00	5.00	PK
5200	H	5202.19	42.90	101.50	/	/	PK
	V	53.32	10.40	38.20	40.00	1.80	QP
	H	125.25	16.00	37.60	43.50	5.90	PK
	H	356.57	17.10	39.30	46.00	6.70	PK
	H	5150.00	43.70	63.80	74.00	10.20	PK
	H	5150.00	43.70	49.20	54.00	6.80	AV
	V	10384.76	6.20	52.60	54.00	1.40	PK
	V	13791.58	10.20	47.60	54.00	6.40	PK
5240	H	5242.63	43.00	101.10	/	/	PK
	V	53.32	10.40	38.20	40.00	1.80	QP
	H	125.25	16.00	37.60	43.50	5.90	PK
	H	356.57	17.10	39.30	46.00	6.70	PK
	V	10484.96	6.50	54.20	74.00	19.80	PK
	V	10484.96	6.50	43.50	54.00	10.50	AV
	V	16597.19	11.60	48.80	54.00	5.20	PK

CH (MHz)	Antenna	Frequency (MHz)	Correct Factor (dB/m)	Corrected Reading (dBuV/m)	Limit (dBuV/m)	Margin (dB)	Detector
5745	H	5743.28	43.90	106.80	/	/	PK
	V	53.32	10.40	38.20	40.00	1.80	QP
	H	125.25	16.00	37.60	43.50	5.90	PK
	H	356.57	17.10	39.30	46.00	6.70	PK
	H	5460.00	-2.10	41.90	54.00	12.10	PK
	V	11486.97	7.40	62.50	74.00	11.50	PK
	V	11486.97	7.40	48.20	54.00	5.80	AV
	V	17238.47	12.40	55.60	74.00	18.40	PK
	V	17238.47	12.40	41.00	54.00	13.00	AV
5785	H	5784.39	43.90	106.30	/	/	PK
	V	53.32	10.40	38.20	40.00	1.80	QP
	H	125.25	16.00	37.60	43.50	5.90	PK
	H	356.57	17.10	39.30	46.00	6.70	PK
	H	5460.00	-2.10	41.60	54.00	12.40	PK
	V	11567.13	7.40	55.90	74.00	18.10	PK
	V	11567.13	7.40	41.30	54.00	12.70	AV
	V	17353.18	12.60	54.70	74.00	19.30	PK
	V	17353.18	12.60	40.10	54.00	13.90	AV
5825	H	5822.24	44.00	106.10	/	/	PK
	V	53.32	10.40	38.20	40.00	1.80	QP
	H	125.25	16.00	37.60	43.50	5.90	PK
	H	356.57	17.10	39.30	46.00	6.70	PK
	H	7250.00	2.40	45.30	54.00	8.70	PK
	V	11647.29	7.30	55.50	74.00	18.50	PK
	V	11647.29	7.30	41.60	54.00	12.40	AV
	V	17472.33	13.10	52.30	74.00	21.70	PK
	V	17472.33	13.10	38.40	54.00	15.60	AV

- Remark:
1. Correct Factor = Antenna Factor + Cable Loss (-Amplifier, is employed)
 2. Corrected Reading = Original Receiver Reading + Correct Factor
 3. Margin = limit – Corrected Reading
 4. The QP detector is applied only while the Pulse-repetition frequency of assessed frequency is higher than 20Hz.

Example: Assuming Antenna Factor = 30.20dB/m, Cable Loss = 2.00dB,
Original Receiver Reading = 10dBuV.
Then Correct Factor = 30.20 + 2.00 = 32.20dB/m; Corrected Reading = 10dBuV +
32.20dB/m = 42.20dBuV/m
Assuming limit = 54dBuV/m, Corrected Reading = 42.20dBuV/m, then Margin =
54 -42.20 = 11.80dBuV/m

7. Power line conducted emission

Test result: Pass

7.1 Limit

Frequency of Emission (MHz)	Conducted Limit (dBuV)	
	QP	AV
0.15-0.5	66 to 56*	56 to 46 *
0.5-5	56	46
5-30	60	50

* Decreases with the logarithm of the frequency.

7.2 Test configuration

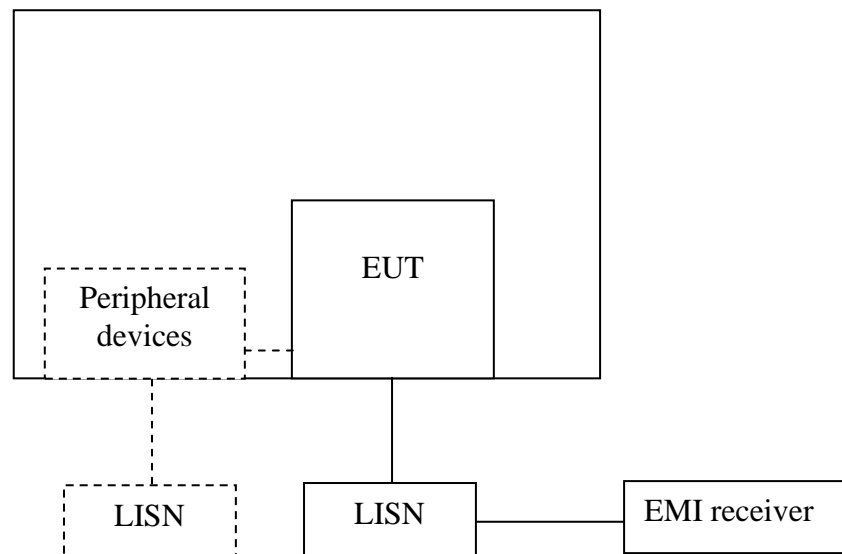

For table top equipment, wooden support is 0.8m height table

For floor standing equipment, wooden support is 0.1m height rack.

7.3 Test procedure and test set up

The EUT are connected to the main power through a line impedance stabilization network (LISN). This provides a $50\Omega/50\mu\text{H}$ coupling impedance for the measuring equipment. The peripheral devices are also connected to the main power through a LISN that provides a $50\Omega/50\mu\text{H}$ coupling impedance with 50Ω termination.

Both sides (Line and Neutral) of AC line are checked for maximum conducted interference. In order to find the maximum emission, the relative positions of equipment and all of the interface cables must be changed according to ANSI C63.4 on conducted measurement. The bandwidth of the test receiver is set at 9 kHz.

7.4 Test protocol

Temperature : 25 °C
Relative Humidity : 55 %

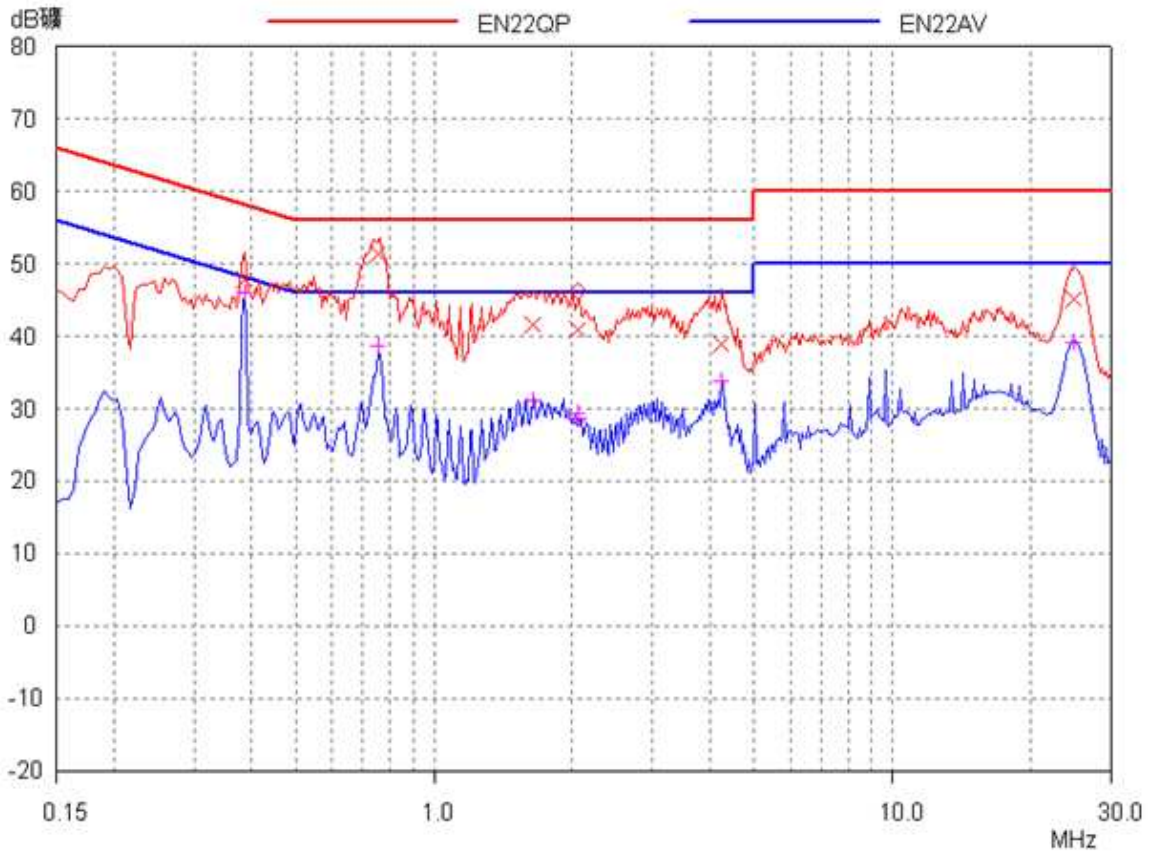

Frequency	Correct Factor (dB)	Corrected Reading (dBuV)		Limit (dBuV)		Margin (dB)	
		QP	AV	QP	AV	QP	AV
0.38 (N)	3.00	47.82	46.13	58.19	48.19	10.37	2.06
0.76 (N)	3.00	51.46	38.78	56.00	46.00	4.54	7.22
1.64 (L)	3.00	41.58	31.15	56.00	46.00	14.42	14.85
2.07 (N)	3.00	40.95	29.32	56.00	46.00	15.05	16.68
4.22 (L)	3.00	38.94	33.72	56.00	46.00	17.06	12.28
24.74 (L)	3.00	45.19	39.06	60.00	50.00	14.81	10.94

Remark: 1. Correction Factor (dB) = LISN Factor (dB) + Cable Loss (dB).
2. Margin (dB) = Limit - Corrected Reading.

8. 26 dB Bandwidth

Test Status: Tested

8.1 Test limit

None

8.2 Test Configuration

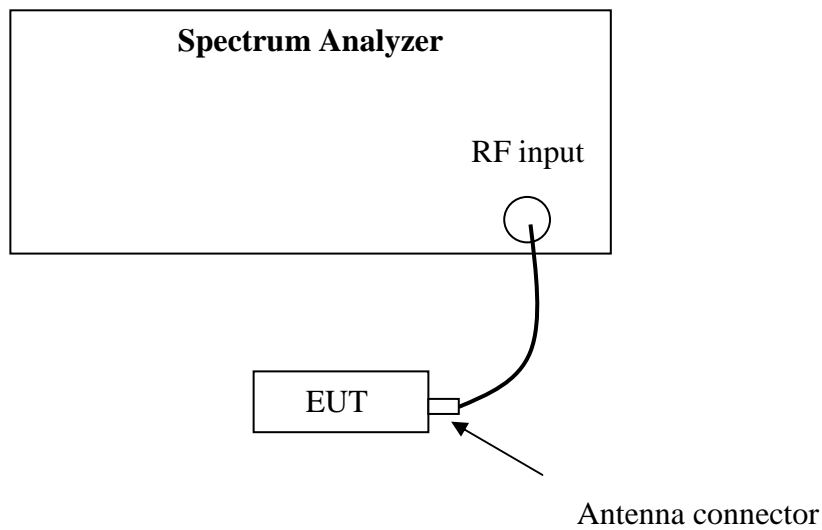

8.3 Test procedure and test setup

For 26dB bandwidth test:

The measurement methods refer to KDB 789033D02: section C.

8.4 Test protocol

Temperature : 25 °C
Relative Humidity : 55 %

Mode	Frequency (MHz)	26 dB Bandwidth (MHz)
802.11a	5180	19.80
	5200	20.58
	5240	19.86
	5745	22.32
	5785	21.96
	5825	20.40

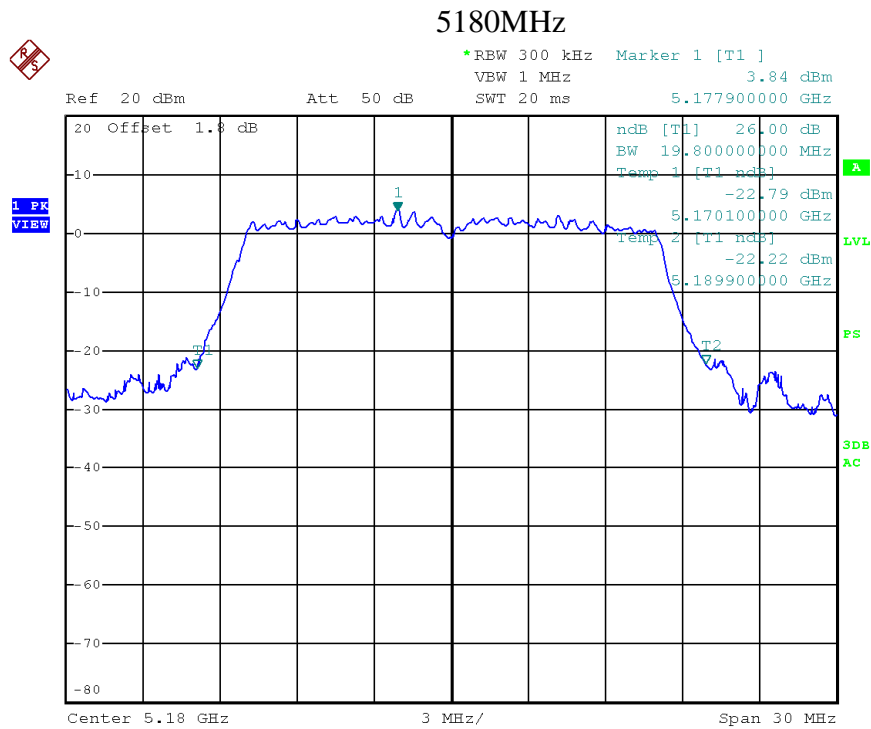

Date: 26.JUN.2014 12:22:43

5200MHz

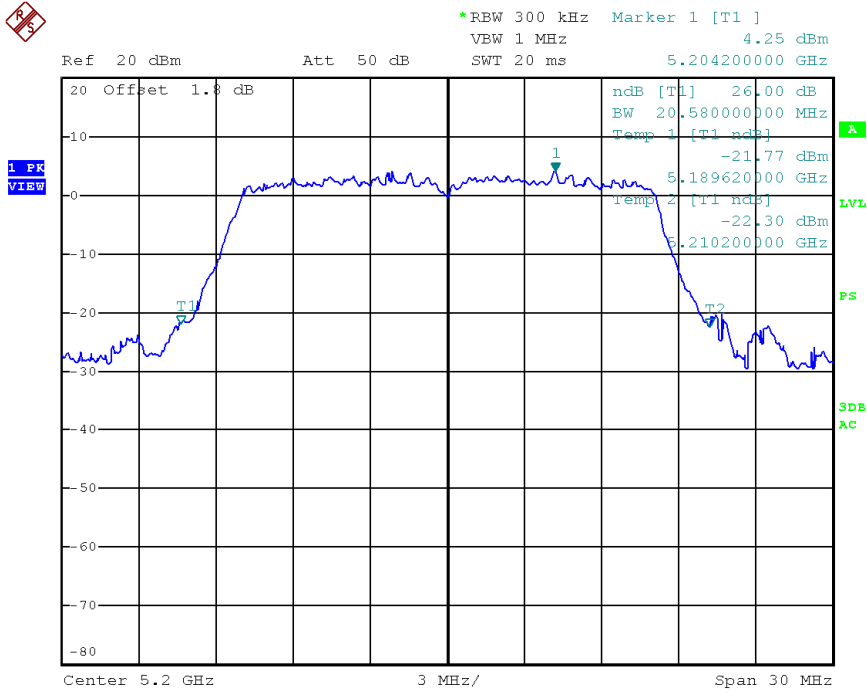

Date: 26.JUN.2014 12:23:32

5240MHz

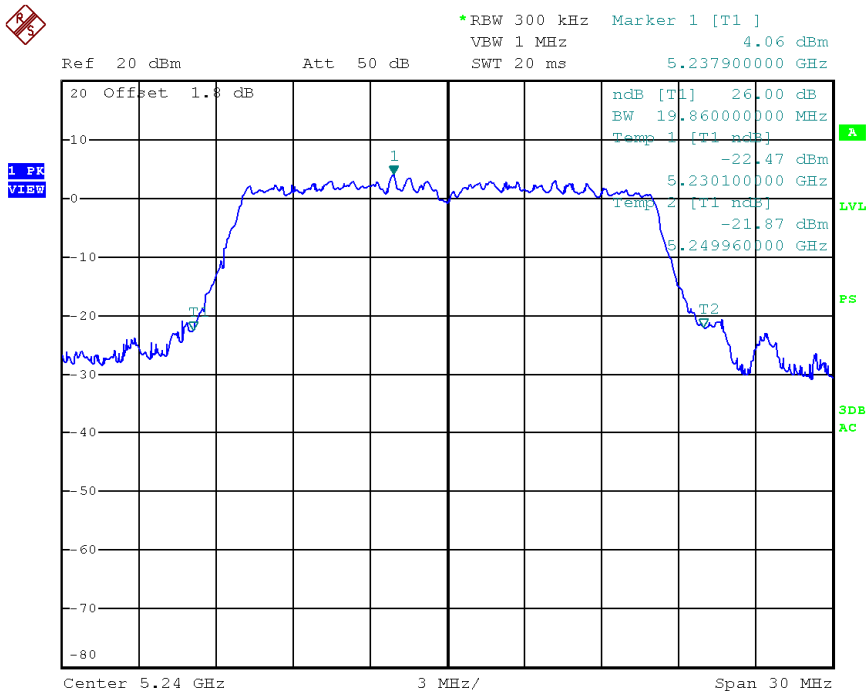

Date: 26.JUN.2014 12:25:07

5745MHz

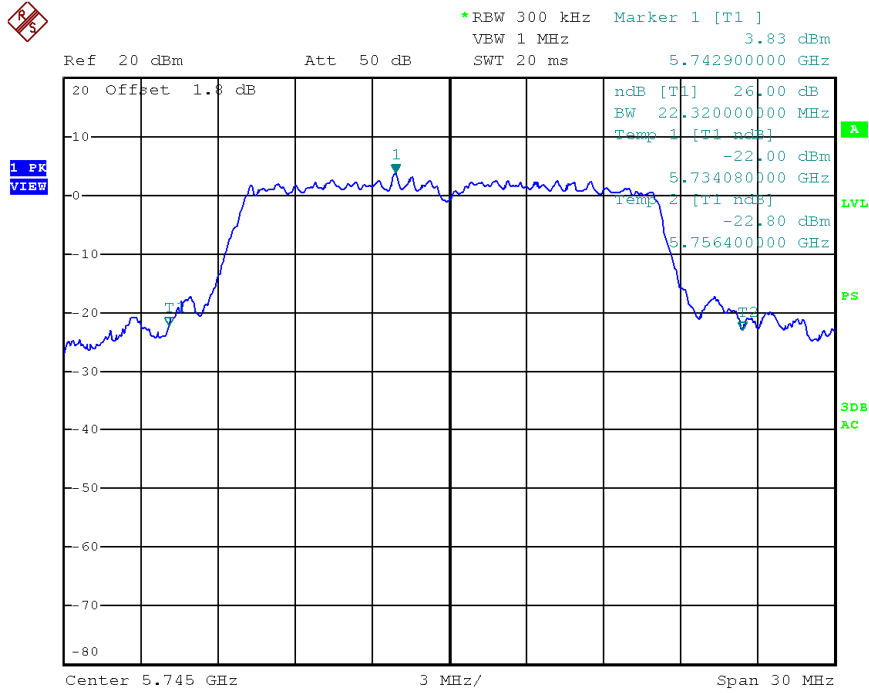

Date: 26.JUN.2014 14:09:24

5785MHz

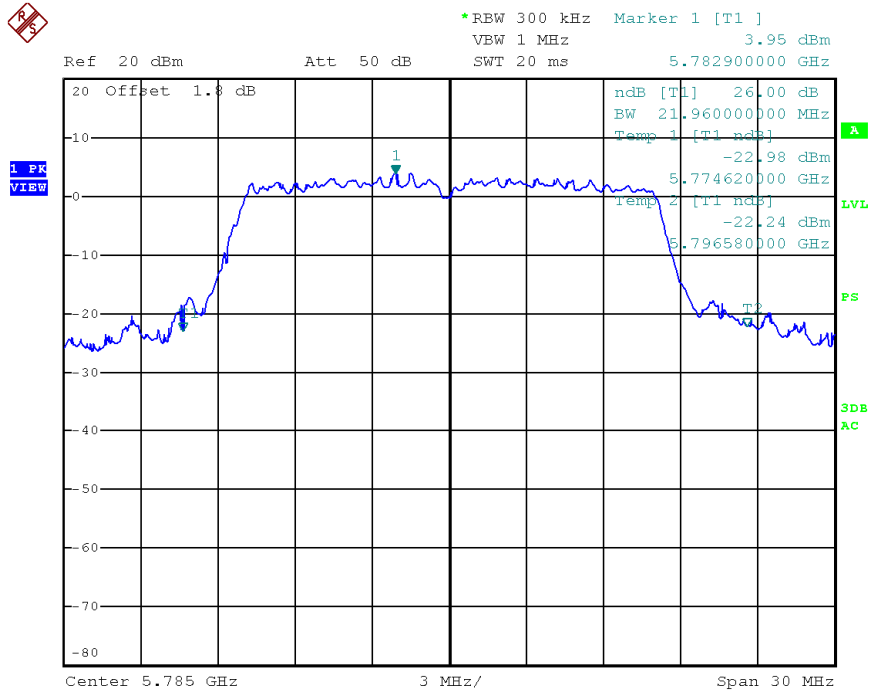

Date: 26.JUN.2014 14:10:26

5825MHz

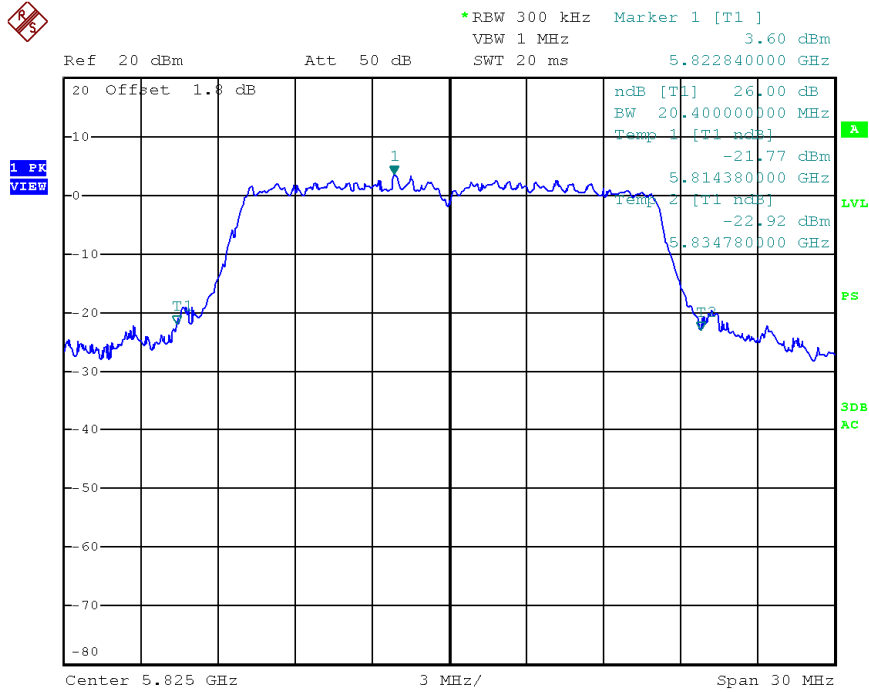

Date: 26.JUN.2014 14:11:32

Mode	Frequency (MHz)	26 dB Bandwidth (MHz)
802.11 n20	5180	20.28
	5200	20.34
	5240	20.28
	5745	24.24
	5785	20.82
	5825	20.70

5180MHz

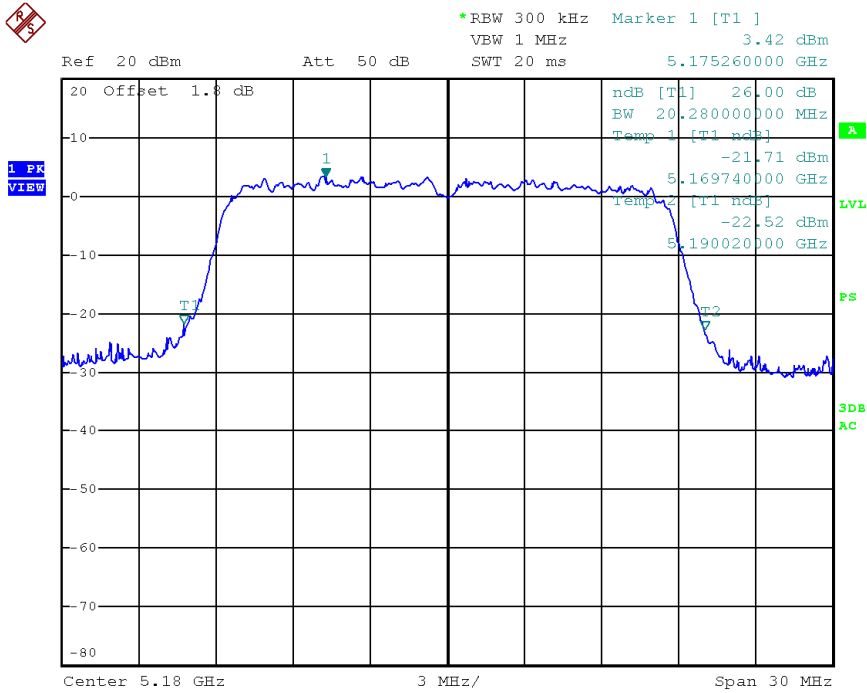

Date: 26.JUN.2014 14:03:45

5200MHz

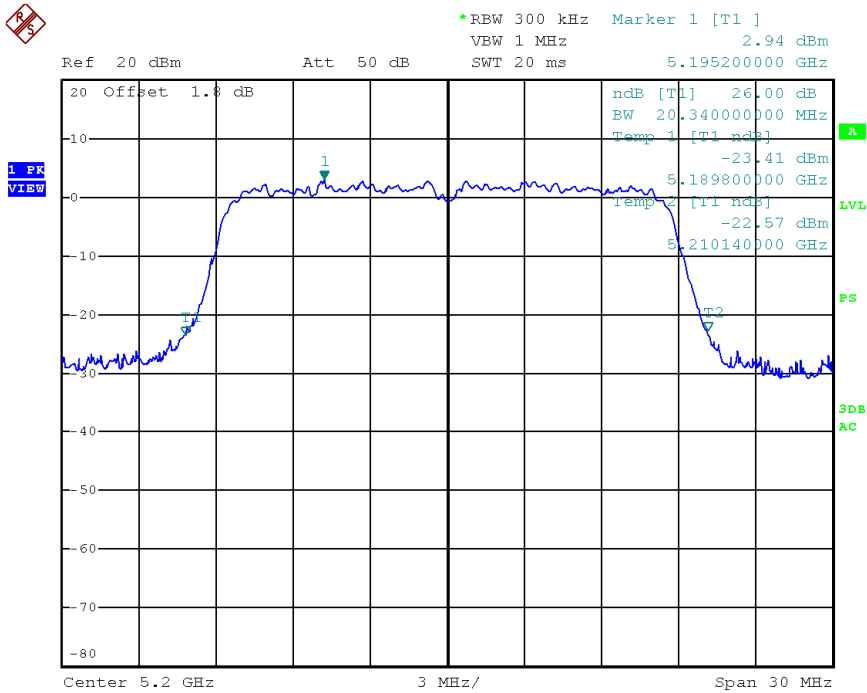

Date: 26.JUN.2014 14:05:40

5240MHz

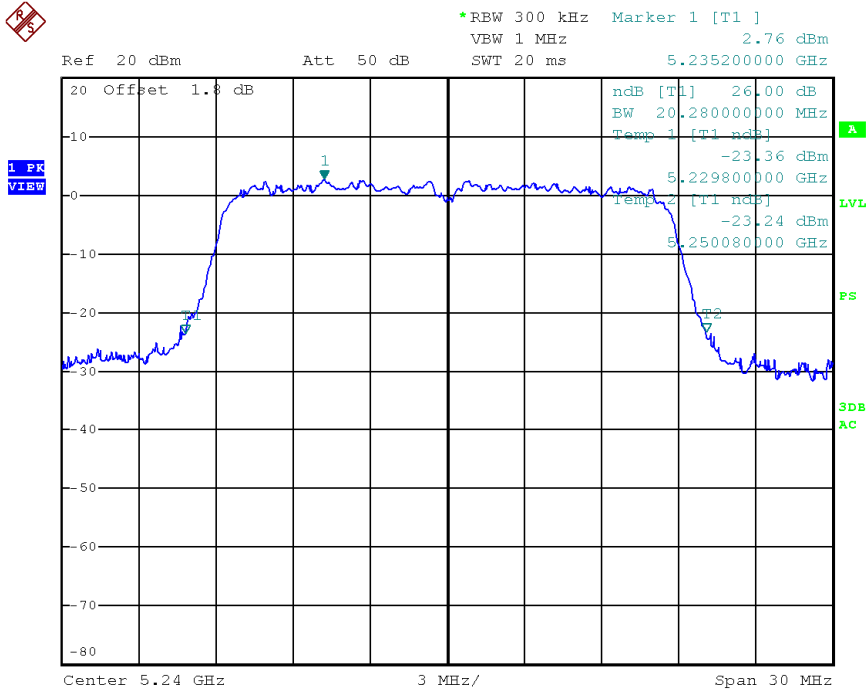

Date: 26.JUN.2014 14:06:14

5745MHz

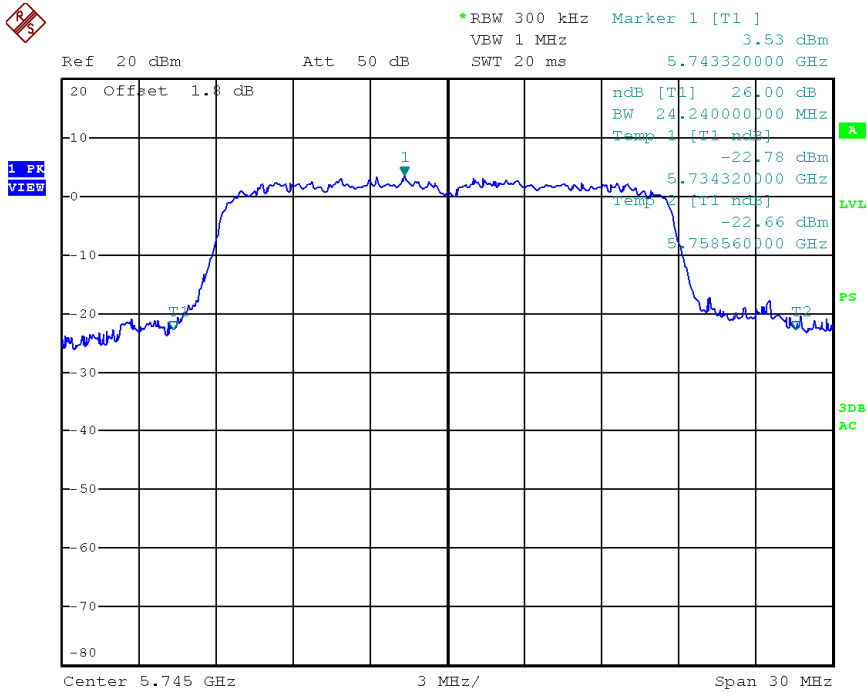

Date: 26.JUN.2014 14:17:18

5785MHz

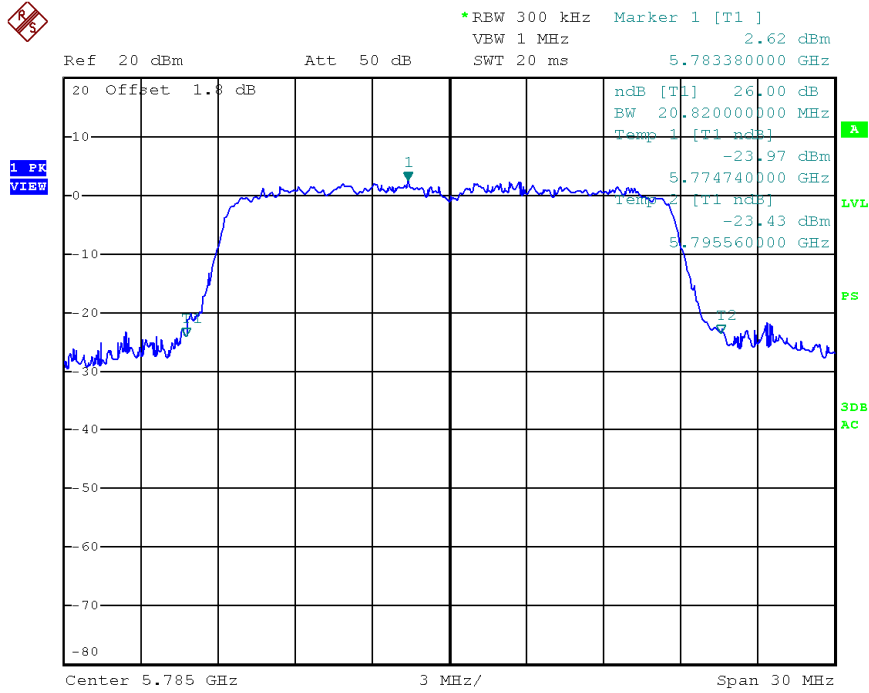

Date: 26.JUN.2014 14:18:34

5825MHz

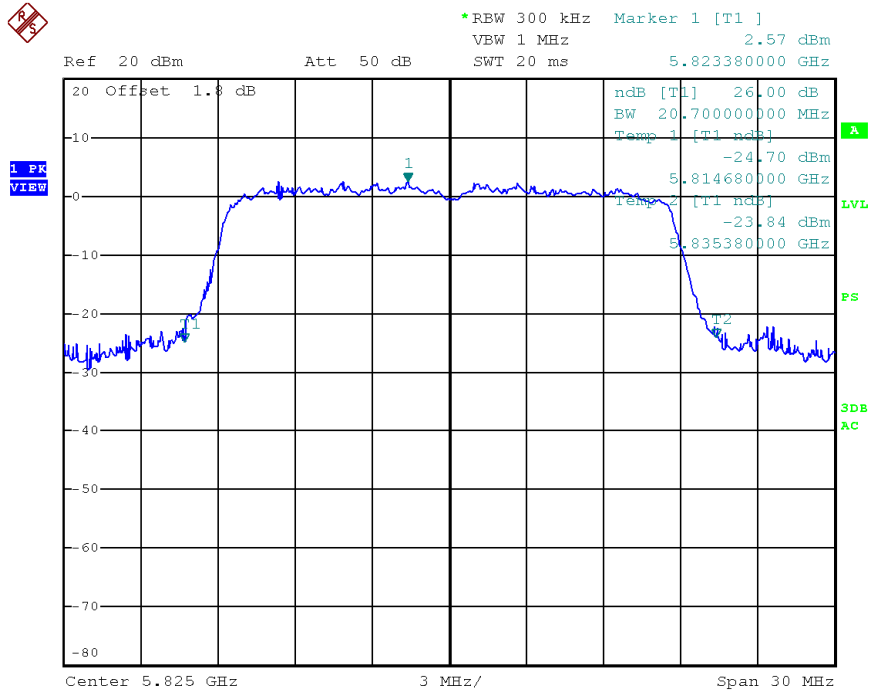

Date: 26.JUN.2014 14:19:58