



EMC TEST REPORT for DTS Device
No. 141200187SHA-001

Applicant : Pass & Seymour, Inc., d/b/a Legrand
301 Fulling Mill Road, Suite G, Middletown,
Pennsylvania 17057 USA

Manufacturer : Hangzhou Samko Electronics Co. Ltd.
No.8,Jiaqi Road,Xianlin Street,Yuhang District, Hangzhou
City, Zhejiang Province, 311122, China

Equipment : Wireless Zone Player

Type/Model : NV-P100

SUMMARY

The equipment complies with the requirements according to the following standard(s):

47CFR Part 15 (2014): Radio Frequency Devices

ANSI C63.4 (2003): American National Standard for Methods of Measurement of Radio-Noise Emissions from Low-Voltage Electrical and Electronic Equipment in the Range of 9 kHz to 40 GHz

Date of issue: Dec 22, 2014

Prepared by:

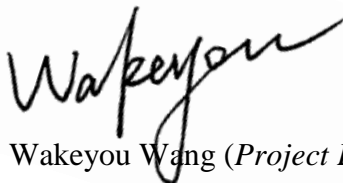

Wakeyou Wang (*Project Engineer*)

Reviewed by:



Daniel Zhao (*Reviewer*)



FCC ID: YV8-NVP100
IC: 9922A- NVP100

Description of Test Facility

Name: Intertek Testing Services Limited Shanghai
Address: Building 86, No. 1198 Qinzhou Rd., North, Shanghai 200233, P.R. China

FCC Registration Number: 236597
IC Assigned Code: 2042B-1

Name of contact: Jonny Jing
Tel: +86 21 61278271
Fax: +86 21 54262353

Content

SUMMARY	1
DESCRIPTION OF TEST FACILITY	2
1. GENERAL INFORMATION	4
1.1 Applicant Information.....	4
1.2 Identification of the EUT	4
1.3 Technical specification	5
1.4 Mode of operation during the test / Test peripherals used.....	6
2. TEST SPECIFICATION	7
2.1 Instrument list	7
2.2 Test Standard	7
2.3 Test Summary	8
3. MINIMUM 6dB BANDWIDTH	9
3.1 Limit.....	9
3.2 Test Configuration	9
3.3 Test Procedure and test setup.....	9
3.4 Test Protocol	10
4. MAXIMUM PEAK OUTPUT POWER	18
4.1 Test limit	18
4.2 Test Configuration	18
4.3 Test procedure and test setup.....	18
4.4 Test protocol	19
5. POWER SPECTRUM DENSITY	20
5.1 Test limit	20
5.2 Test Configuration	20
5.3 Test procedure and test setup.....	20
5.4 Test Protocol	21
6. RADIATED EMISSION IN THE RESTRICTED BANDS	29
6.1 Test limit	29
6.2 Test Configuration	29
6.3 Test procedure and test setup.....	30
6.4 Test protocol	31
7. EMISSION OUTSIDE THE FREQUENCY BAND	35
7.1 Limit.....	35
7.2 Test Configuration	35
7.3 Test procedure and test setup.....	35
7.4 Test protocol	36
8. POWER LINE CONDUCTED EMISSION	59
8.1 Limit.....	59
8.2 Test configuration	59
8.3 Test procedure and test set up.....	60
8.4 Test protocol	61



1. General Information

1.1 Applicant Information

Applicant: Pass & Seymour, Inc., d/b/a Legrand
301 Fulling Mill Road, Suite G, Middletown,
Pennsylvania 17057 USA

Name of contact: Rick Kukulies

Tel: 1-859 817 7218

Fax: 1-859 817 7250

Manufacturer: Hangzhou Samko Electronics Co. Ltd.
No.8,Jiaqi Road,Xianlin Street,Yuhang District,
Hangzhou City, Zhejiang Province, 311122, China

Sample received date : June 1, 2014

Sample Identification No : /

Date of test : June 1, 2014 ~ Dec 10, 2014

1.2 Identification of the EUT

Equipment: Wireless Zone Player

Type/model: NV-P100

FCC ID: YV8-NVP100

IC: 9922A- NVP100



1.3 Technical specification

Operation Frequency Band: 2412 - 2462 MHz
 Modulation: DBPSK @1Mbps
 DQPSK@2Mbp
 CCK@5.5/11Mbps
 BPSK@6/9 Mbps
 QPSK@12/18Mbps
 16-QAM@24Mbps
 64-QAM@48/54Mpb and above

Gain of Antenna: Internal antenna

Antenna Type	Applied Chain	Gain of antenna
P/N 1002985	1 (Front)	2.4GHz band: 3.7dBi
		5GHz band: 5.7dBi
P/N 1002988	2 (Right)	2.4GHz band: 4.4dBi
		5GHz band: 6.0dBi

Rating: AC 100-240V, 50-60Hz, 70W

Description of EUT: The EUT is a wireless audio device containing Wi-Fi module. There is one model only.

Port identification: Line in × 1; Line out × 1; L × 2; R × 2; USB × 1;
LAN × 1

Category of EUT: Class B

EUT type: Table top Floor standing

EUT Modes: 802.11a/b/g/n20 (802.11b/g/n20 assessed in this report)

Channel Number: Channel 1 - 11 for 2412MHz~2462MHz

Channel Description: The channel spacing is 5MHz.

MIMO Function Description:

Freq. Band	Modulation	Transmission / Idle		Beam forming	Beam forming gain
		Chain 1	Chain 2		
2412 – 2462 MHz	802.11b	Transmission	Idle	NO	0 dBi
	802.11g	Transmission	Idle	NO	0 dBi
	802.11 n20	Transmission	Transmission	NO	0 dBi



1.4 Mode of operation during the test / Test peripherals used

While testing transmitting mode of EUT, the internal modulation was applied.

The lowest, middle and highest channel were tested as representatives (2412MHz, 2437MHz and 2462MHz).

Test Peripherals:
PC: HP ProBook 6450b

Test software setting:

The power level setting for 802.11b/g/n is used with the software offered by the manufactory.

Mode 1	Frequency (MHz)	Software Setting	Note
802.11b	2412	15.0	
	2437	15.0	
	2462	15.0	
802.11g	2412	15.0	
	2437	15.0	
	2462	8.0	
802.11n20	2412	15.0	
	2437	15.0	
	2462	8.0	

Data rate VS Power

The pre-scan for the conducted power with all rates in each modulation and bands was used, and the worst case was found and used in all test cases.

After this pre-scan,we choose the following table of the data rata as the worst case.

Mode	Worst case data rate
802.11b	1Mbps
802.11g	6Mbps
802.11 n20	MCS8



2. Test Specification

2.1 Instrument list

Equipment	Type	Manu.	Internal no.	Cal. Date	Due date
Test Receiver	ESCS 30	R&S	EC 2107	2014-10-21	2015-10-20
Test Receiver	ESIB 26	R&S	EC 3045	2014-10-20	2015-10-19
A.M.N.	ESH2-Z5	R&S	EC 3119	2014-1-9	2015-1-8
Bilog Antenna	CBL 6112D	TESEQ	EC 4206	2013-4-28	2015-4-27
Horn antenna	HF 906	R&S	EC 3049	2013-4-28	2015-4-27
Pre-amplifier	Pre-amp 18	R&S	EC 3222	2014-4-12	2015-4-11
Semi-anechoic chamber	-	Albatross project	EC 3048	2014-5-12	2015-5-11
High Pass Filter	WHKX 1.0/15G-10SS	Wainwright	EC4297-1	2014-1-8	2015-1-7
Power sensor / Power meter	N1911A/N1921A	Agilent	EC4318	2014-04-12	2015-04-11
Loop Antenna	FMZB 1516	SCHWARZB ECK	/	2014-11-29	2015-11-28
Temperature Camber	SETH-E	tayasaf	EC4315	2014-4-9	2015-4-9

2.2 Test Standard

47CFR Part 15 (2014)
ANSI C63.4: 2003
KDB 558074 (V03R02)

2.3 Test Summary

This report applies to tested sample only. This report shall not be reproduced in part without written approval of Intertek Testing Service Shanghai Limited.

TEST ITEM	FCC REFERANCE	RESULT
Minimum 6dB Bandwidth	15.247(a)(2)	Pass
Maximum peak output power	15.247(b)	Pass
Power spectrum density	15.247(e)	Pass
Radiated emission	15.205 & 15.209	Pass
Emission outside the frequency band	15.247(d)	Pass
Power line conducted emission	15.207	Pass

3. Minimum 6dB Bandwidth

Test result: PASS

3.1 Limit

For systems using digital modulation techniques that may operate in the 902 - 928 MHz, 2400 - 2483.5 MHz and 5725 - 5850 MHz bands, the minimum 6 dB bandwidth shall be at least 500 kHz.

3.2 Test Configuration

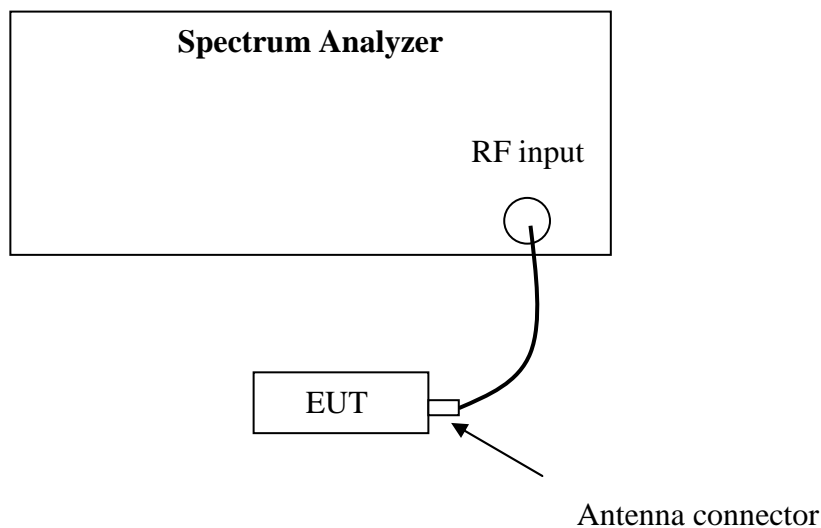

3.3 Test Procedure and test setup

The minimum 6dB bandwidth per FCC §15.247(a)(2) is measured using the Spectrum Analyzer according to DTS test procedure of “KDB558074 D01 DTS Meas Guidance v03r02” for compliance to FCC 47CFR 15.247 requirements (clause 8.2).

3.4 Test Protocol

Temperature : 25°C
Relative Humidity : 55%

Mode	CH	Chain 1 (MHz)	Chain 2 (MHz)	Limit (MHz)
802.11b	L	11.12	-	≥0.5
	M	11.12	-	
	H	11.20	-	

Frequency L – Chain 1

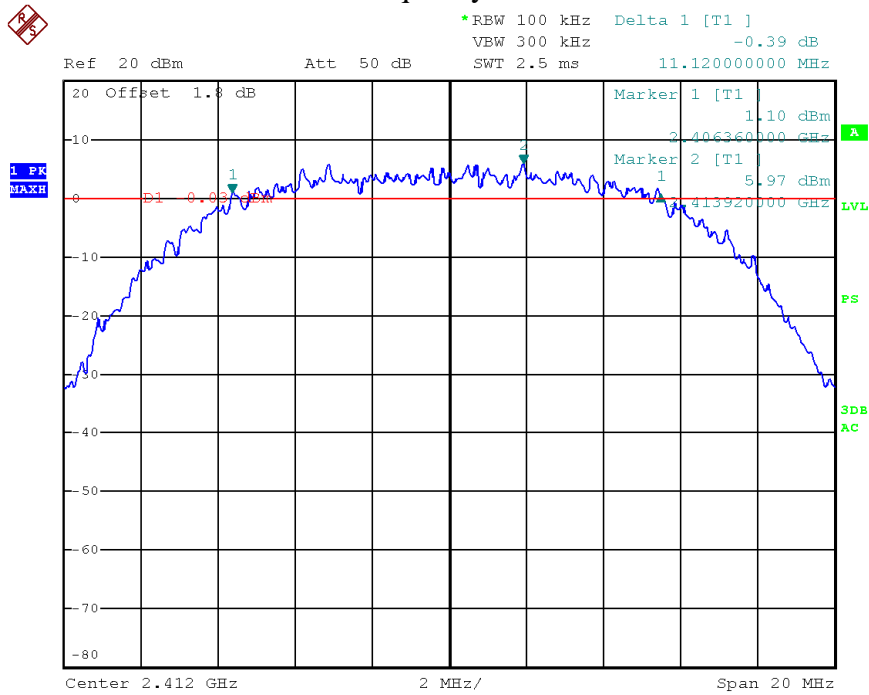

Date: 24.JUN.2014 16:04:34

Frequency M – Chain 1

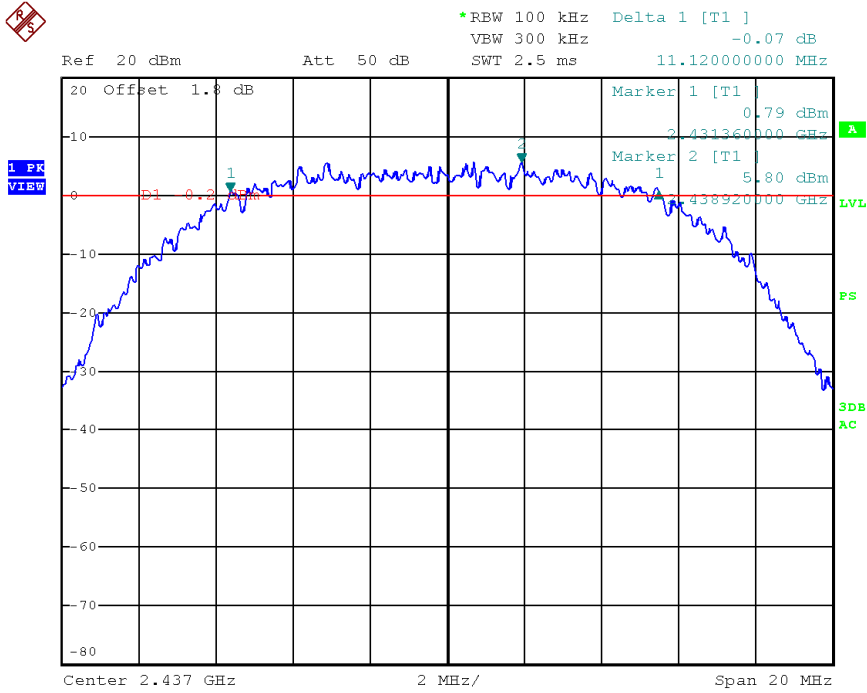

Date: 24.JUN.2014 16:05:34

Frequency H – Chain 1

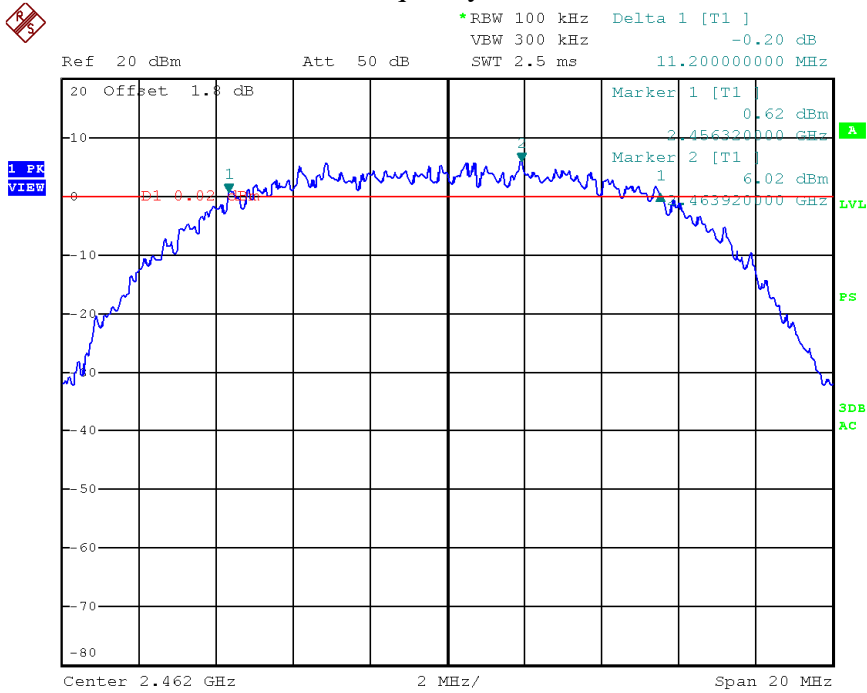

Date: 24.JUN.2014 16:06:38



Mode	CH	Chain 1 (MHz)	Chain 2 (MHz)	Limit (MHz)
802.11g	L	16.48	-	≥0.5
	M	16.44	-	
	H	16.48	-	

Frequency L – Chain 1

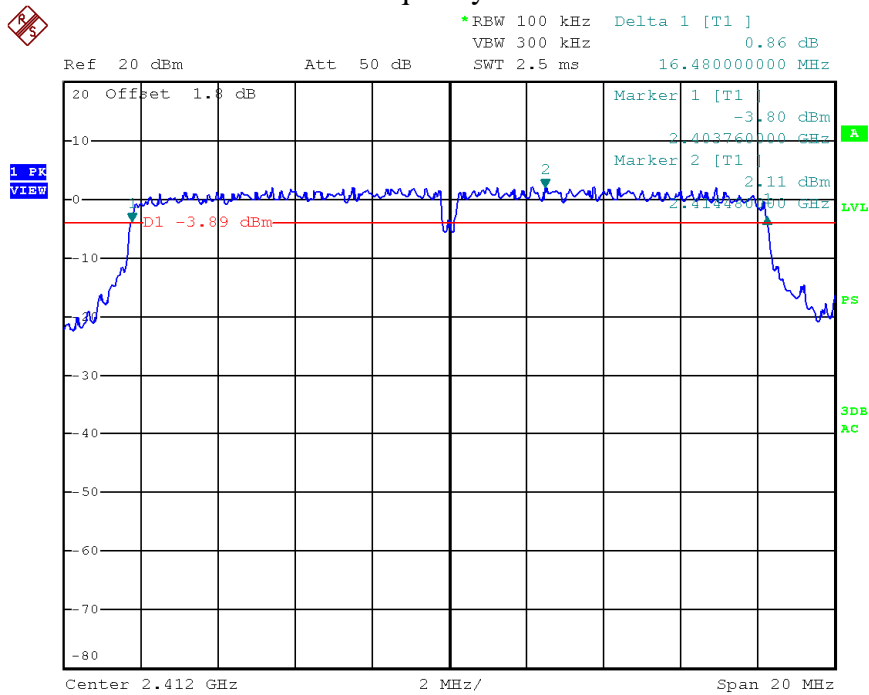

Date: 24.JUN.2014 16:09:11

Frequency M – Chain 1

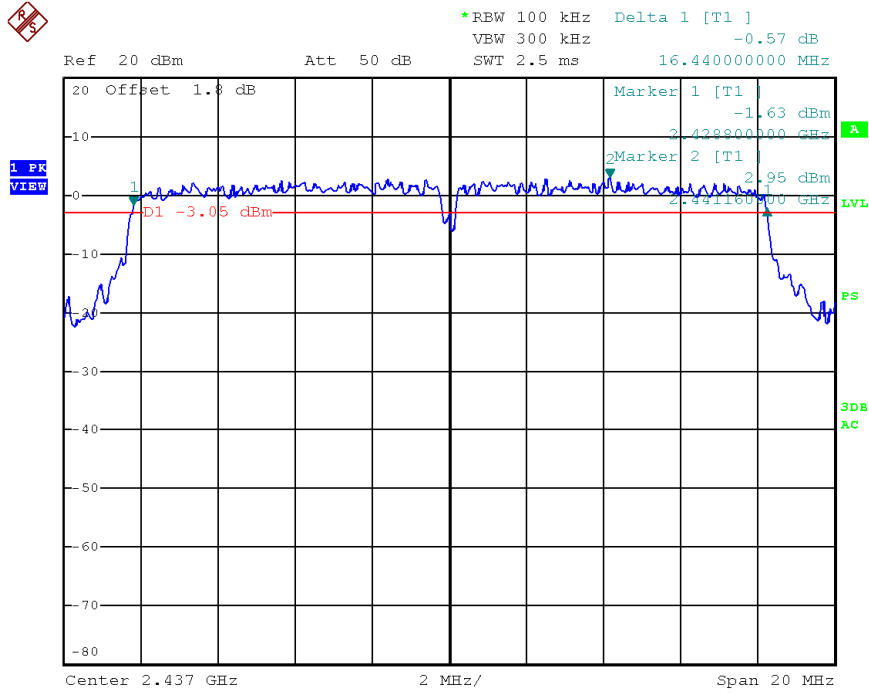

Date: 24.JUN.2014 16:10:02

Frequency H – Chain 1

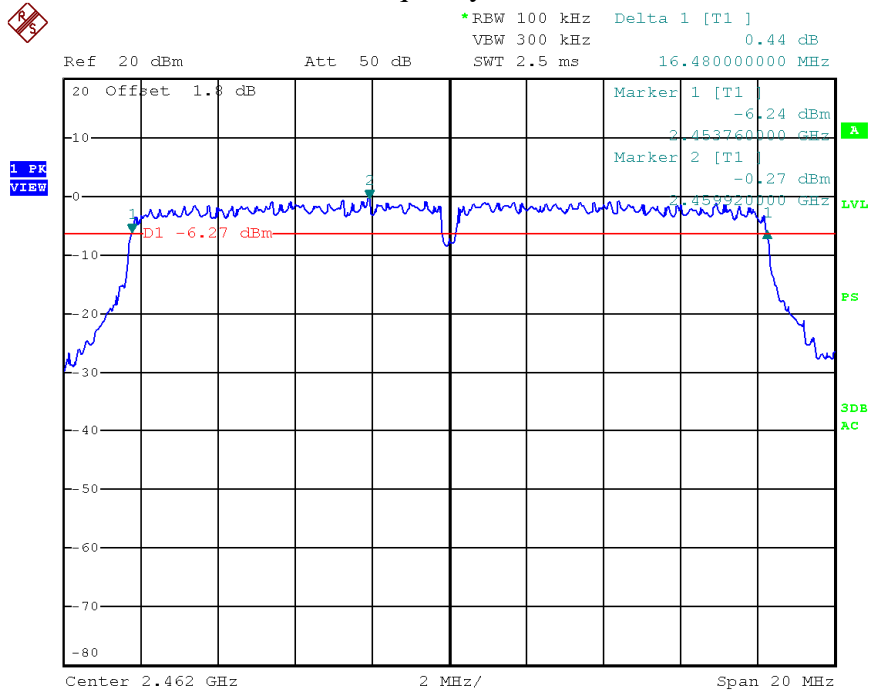

Date: 24.JUN.2014 16:10:48



Mode	CH	Chain 1 (MHz)	Chain 2 (MHz)	Limit (MHz)
802.11 n20	L	17.60	17.44	≥0.5
	M	17.60	17.52	
	H	17.60	17.60	

Frequency L – Chain 1

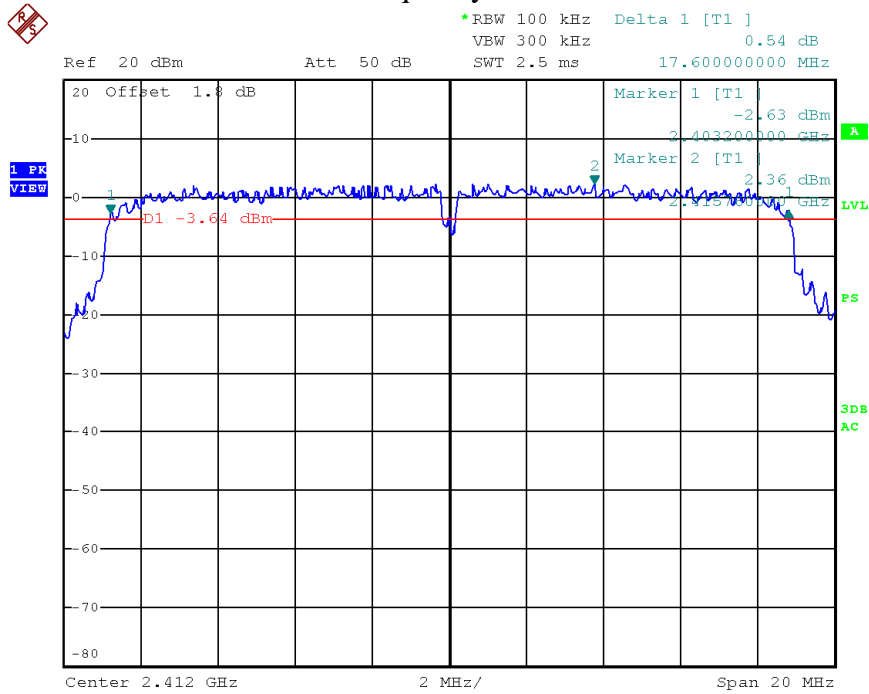

Date: 24.JUN.2014 16:12:33

Frequency M – Chain 1

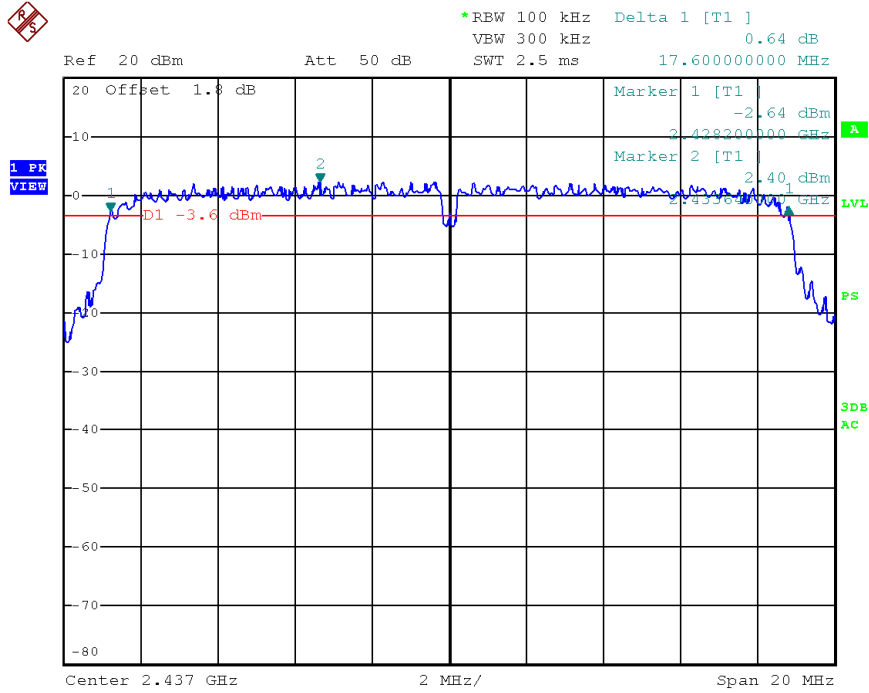

Date: 24.JUN.2014 16:13:17

Frequency H – Chain 1

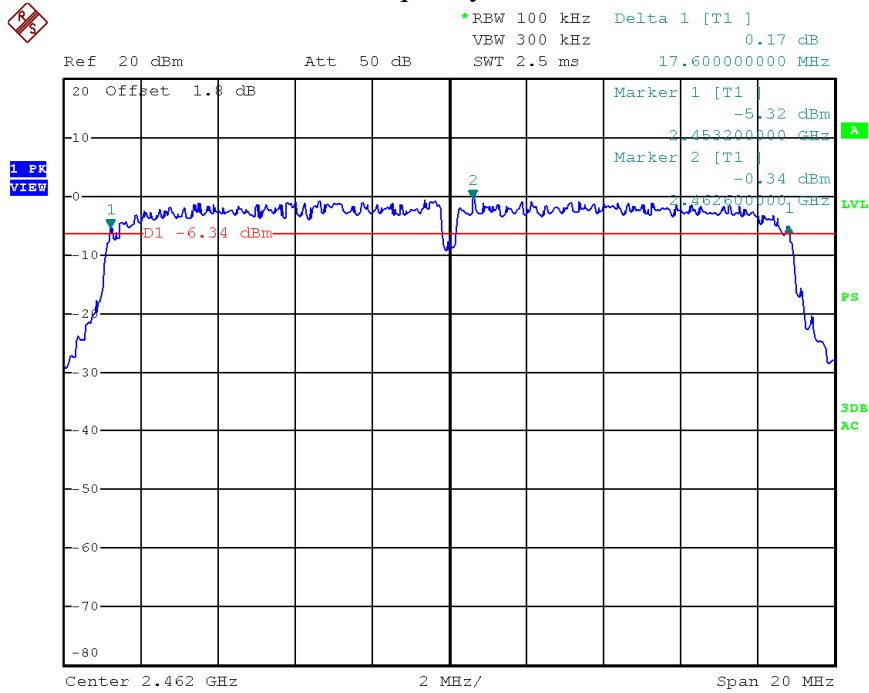

Date: 24.JUN.2014 16:14:24

Frequency L – Chain 2

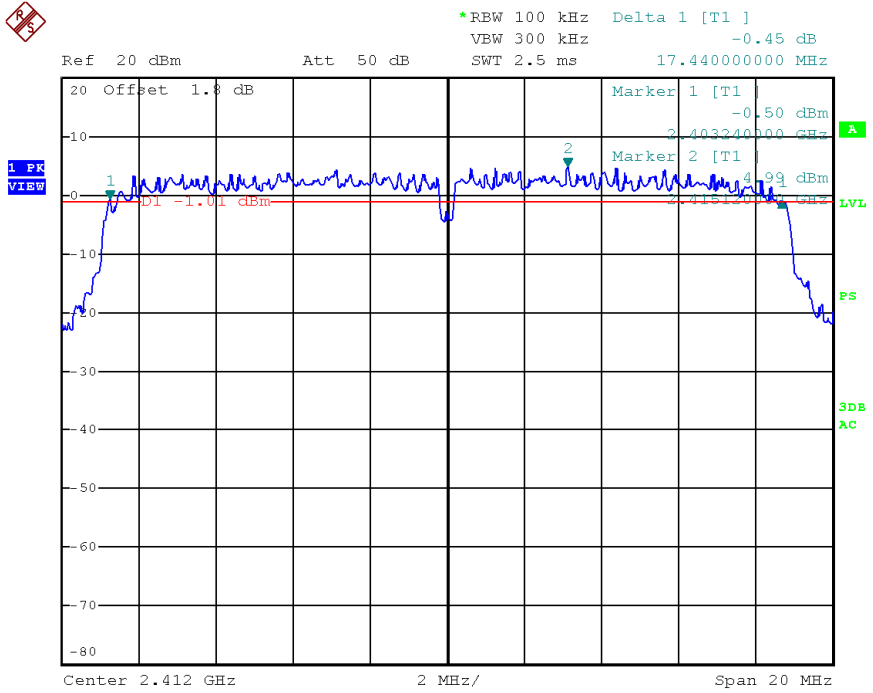

Date: 24.JUN.2014 16:20:26

Frequency M – Chain 2

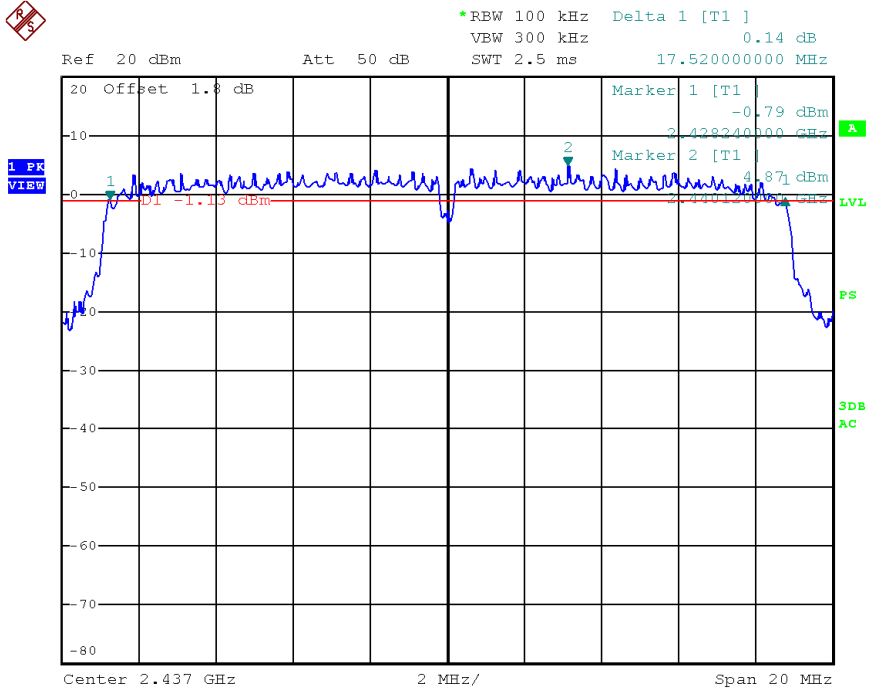

Date: 24.JUN.2014 16:21:20



Frequency H – Chain 2

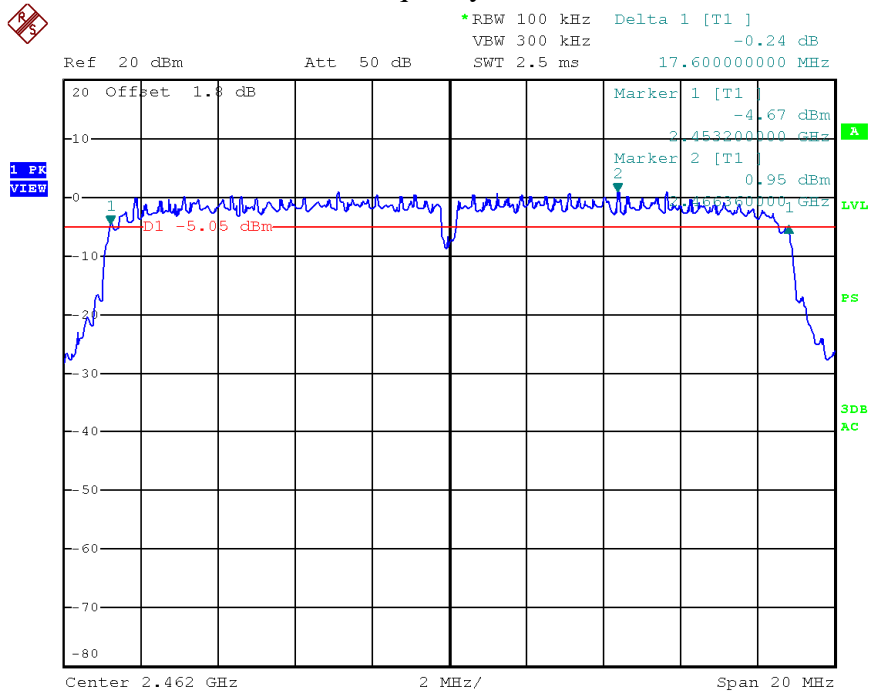

Date: 24.JUN.2014 16:22:12

4. Maximum peak output power

Test result: Pass

4.1 Test limit

- For frequency hopping systems operating in the 2400-2483.5 MHz band employing at least 75 non-overlapping hopping channels, and all frequency hopping systems in the 5725-5850 MHz band: 1 watt
- For all other frequency hopping systems in the 2400-2483.5 MHz band: 0.125 watts
- For systems using digital modulation in the 902-928 MHz, 2400-2483.5 MHz, and 5725-5850 MHz bands: 1 Watt.

If the transmitting antenna of directional gain greater than 6dBi is used, the power shall be reduced by the amount in dB that the directional gain of the antenna exceeds 6dBi.

4.2 Test Configuration

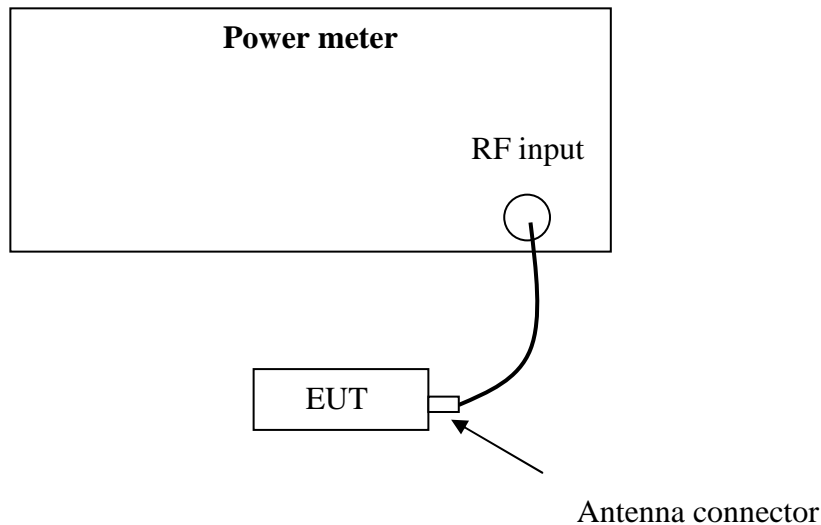

4.3 Test procedure and test setup

The EUT was tested according to DTS test procedure of “KDB558074 D01 DTS Meas Guidance v03r02” for compliance to FCC 47CFR 15.247 requirements (clause 9.1.2).

4.4 Test protocol

Temperature : 25 °C

Relative Humidity : 55 %

Mode	CH	Cable loss (dB)	Reading (dBm)		Total Peak power (dBm)	Limit (dBm)
			Chain 1	Chain 2		
802.11b	L	1.8	21.30	-	21.30	30.00
	M	1.8	21.40	-	21.40	30.00
	H	1.8	21.20	-	21.20	30.00
802.11g	L	1.8	25.70	-	25.70	30.00
	M	1.8	26.00	-	26.00	30.00
	H	1.8	24.50	-	24.50	30.00
802.11n20	L	1.8	25.70	26.40	29.10	30.00
	M	1.8	26.30	26.80	29.60	30.00
	H	1.8	23.80	23.90	26.90	30.00

5. Power spectrum density

Test result: Pass

5.1 Test limit

For digitally modulated systems, the power spectral density conducted from the intentional radiator to the antenna shall not be greater than 8dBm in any 3 kHz band during any time interval of continuous transmission.

5.2 Test Configuration

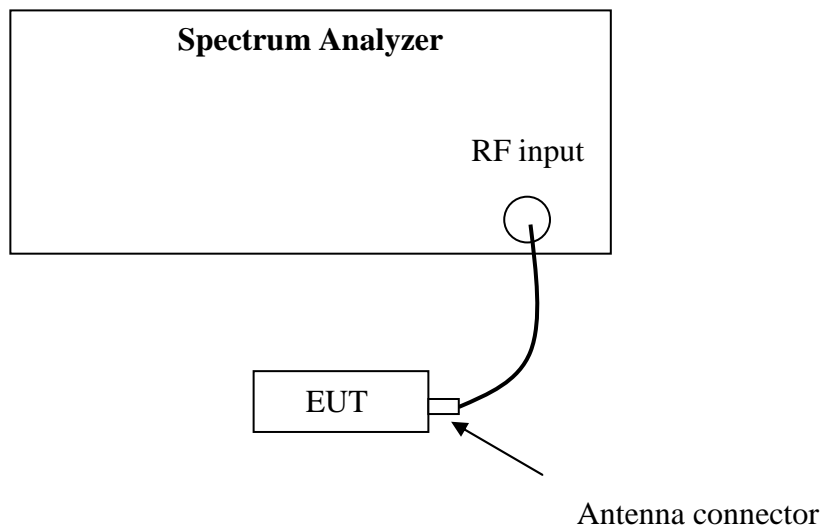

5.3 Test procedure and test setup

The power output per FCC §15.247(e) was tested according to DTS test procedure of “KDB558074 D01 DTS Meas Guidance v03r02” (clause 10.2) for compliance to FCC 47CFR 15.247 requirements.



5.4 Test Protocol

Temperature : 25 °C

Relative Humidity: 55 %

Mode	CH	Cable loss (dB)	PSD (dBm/100kHz)		Total PSD (dBm/100kHz)	Limit (dBm/3kHz)
			Chain 1	Chain 2		
802.11b	L	1.8	5.50	-	5.50	≤8.00
	M	1.8	5.48	-	5.48	
	H	1.8	5.77	-	5.77	

Frequency L – Chain 1

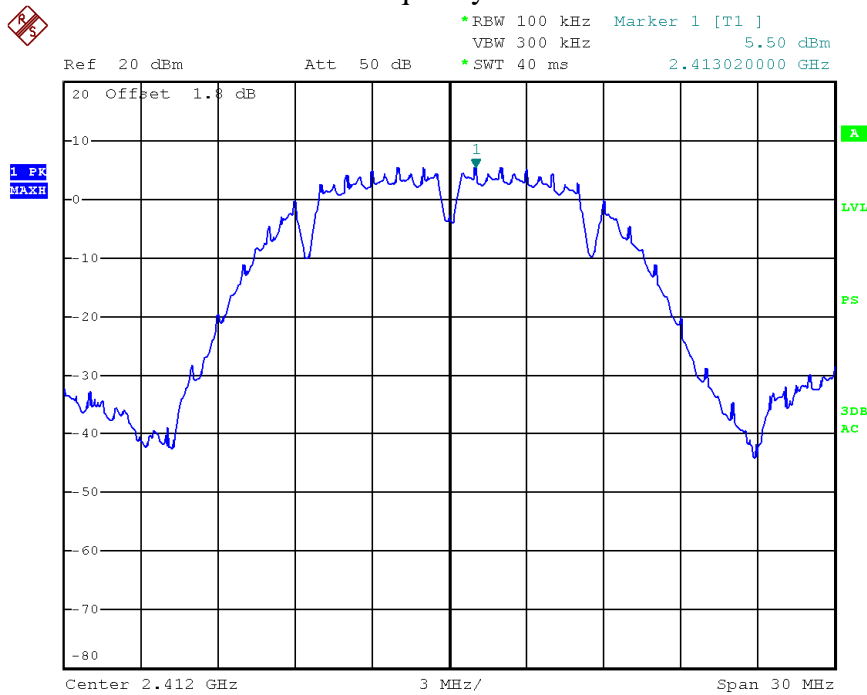

Date: 24.JUN.2014 17:06:11

Frequency M – Chain 1

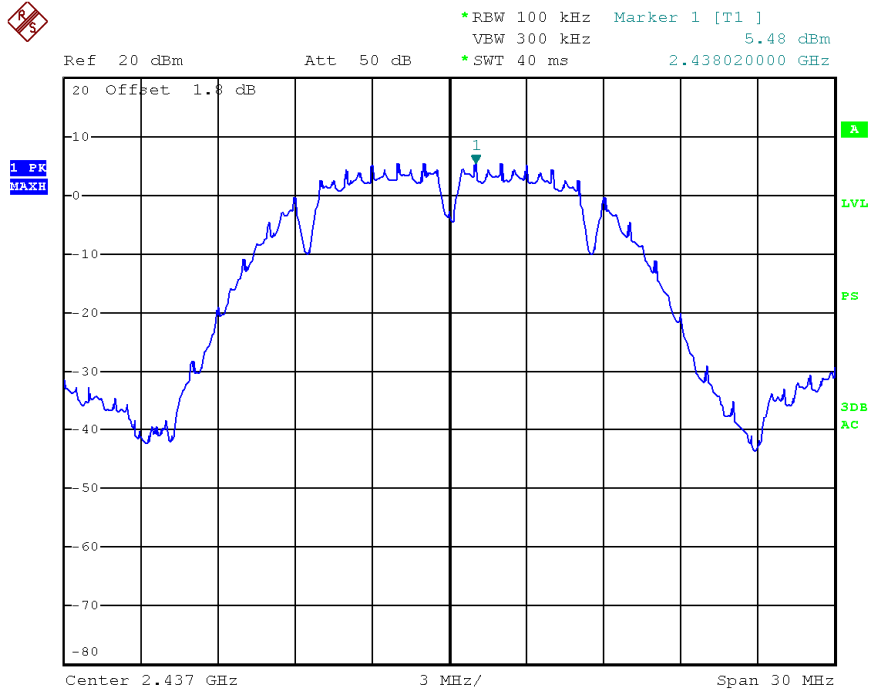

Date: 24.JUN.2014 17:06:36

Frequency H – Chain 1

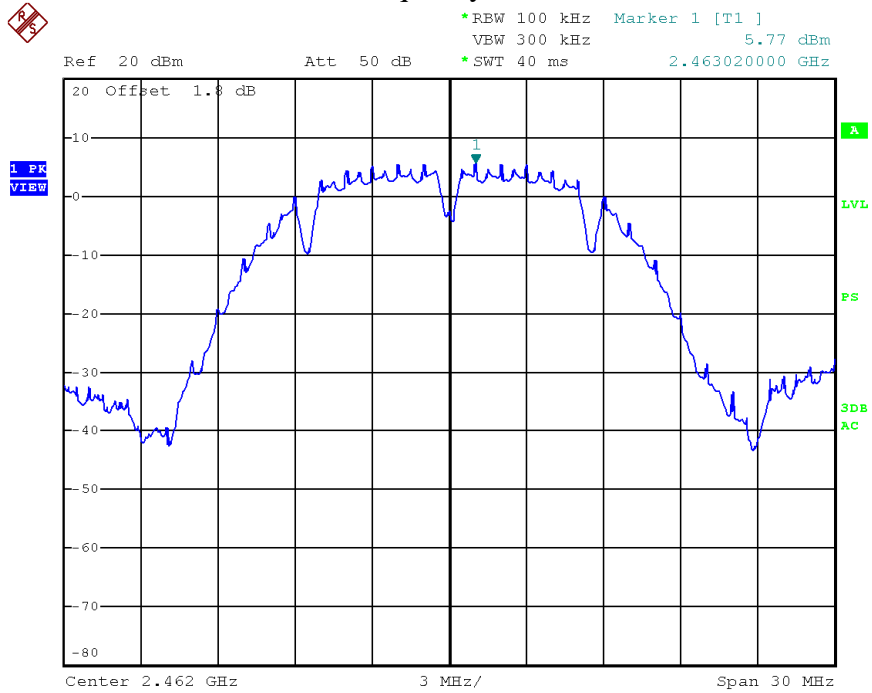

Date: 24.JUN.2014 17:07:09



Mode	CH	Cable loss (dB)	PSD (dBm/100kHz)		Total PSD (dBm/100kHz)	Limit (dBm/3kHz)
			Chain 1	Chain 2		
802.11g	L	1.8	3.03	-	3.03	≤8.00
	M	1.8	3.21	-	3.21	
	H	1.8	-0.10	-	-0.10	

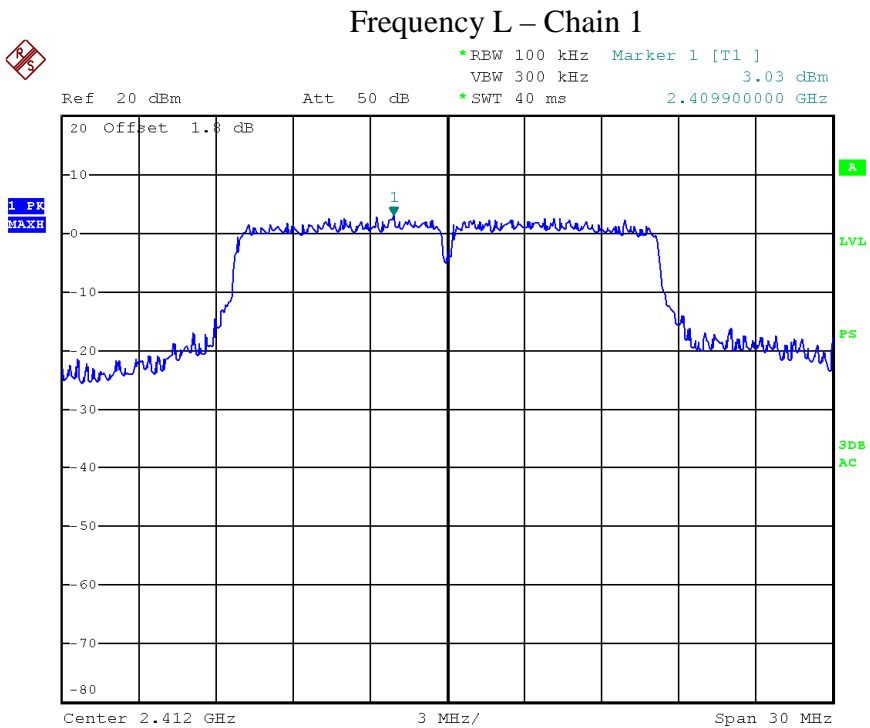

Date: 24.JUN.2014 17:07:48

Frequency M – Chain 1

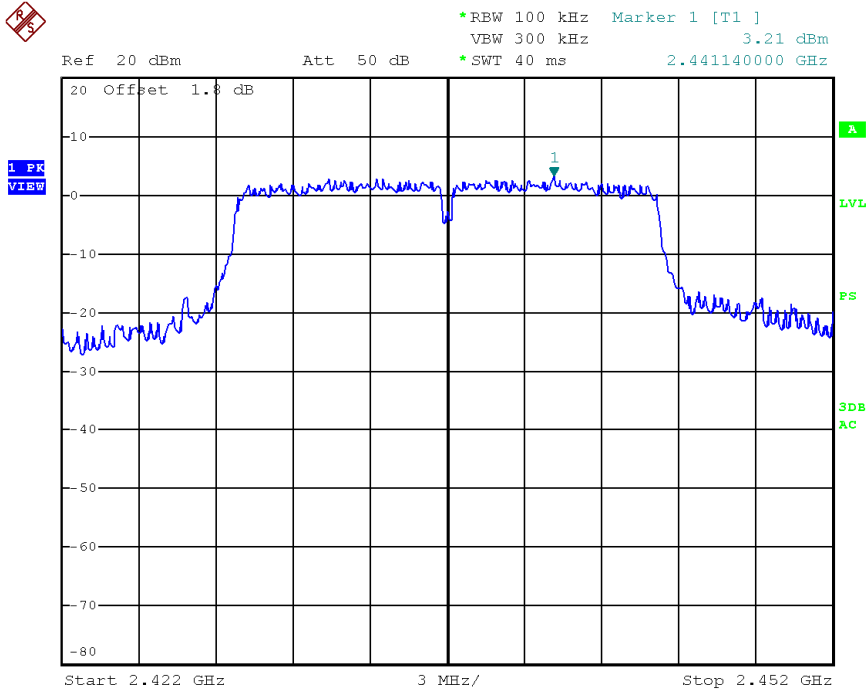

Date: 24.JUN.2014 17:09:13

Frequency H – Chain 1

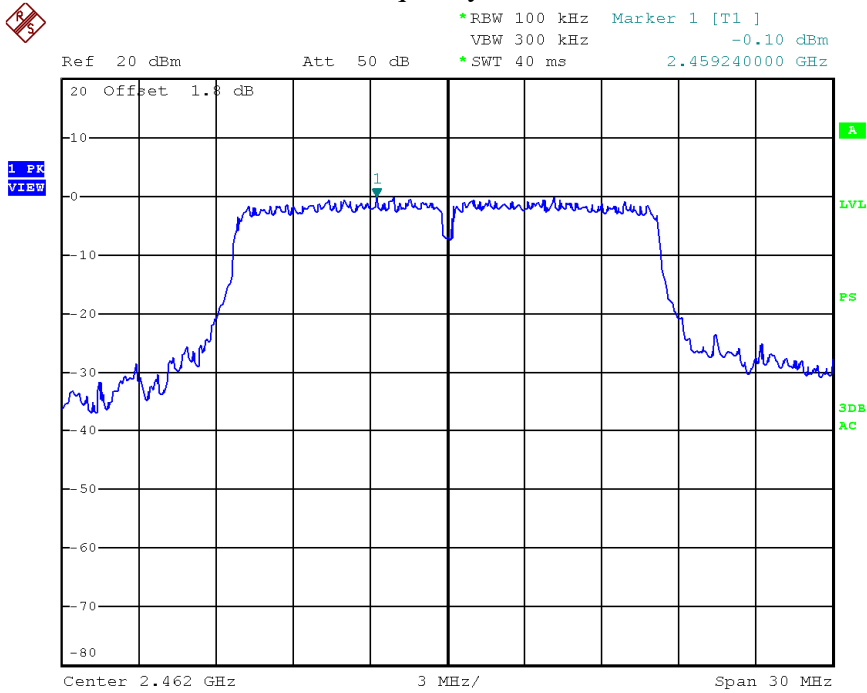

Date: 24.JUN.2014 17:09:47



Mode	CH	Cable loss (dB)	PSD (dBm/100kHz)		Total PSD (dBm/100kHz)	Limit (dBm/3kHz)
			Chain 1	Chain 2		
802.11n20	L	1.8	2.40	3.42	5.95	≤8.00
	M	1.8	2.79	4.02	6.46	
	H	1.8	-0.32	0.35	3.04	

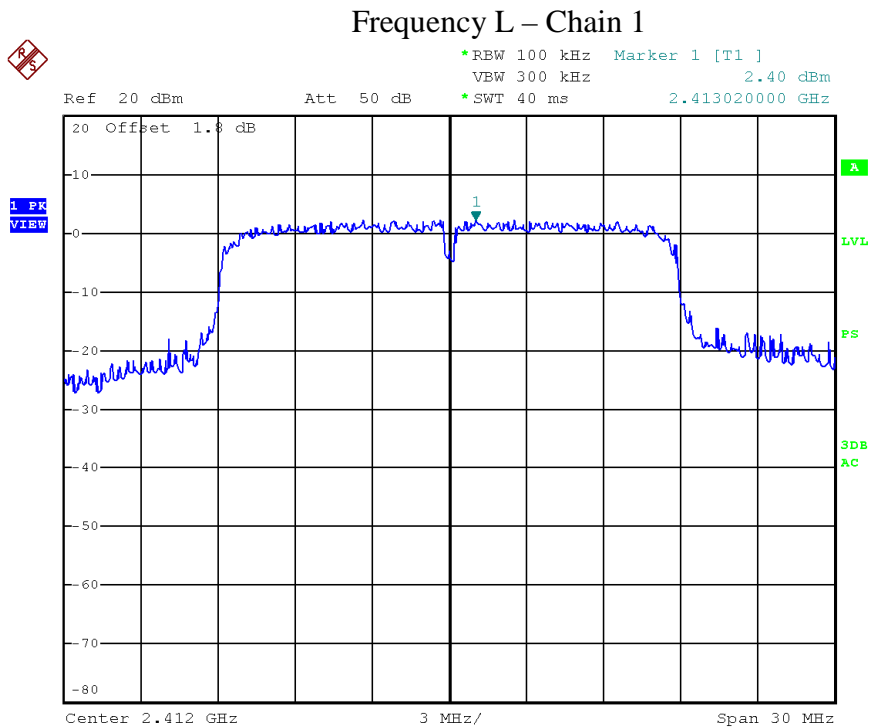

Date: 24.JUN.2014 17:10:43

Frequency M – Chain 1

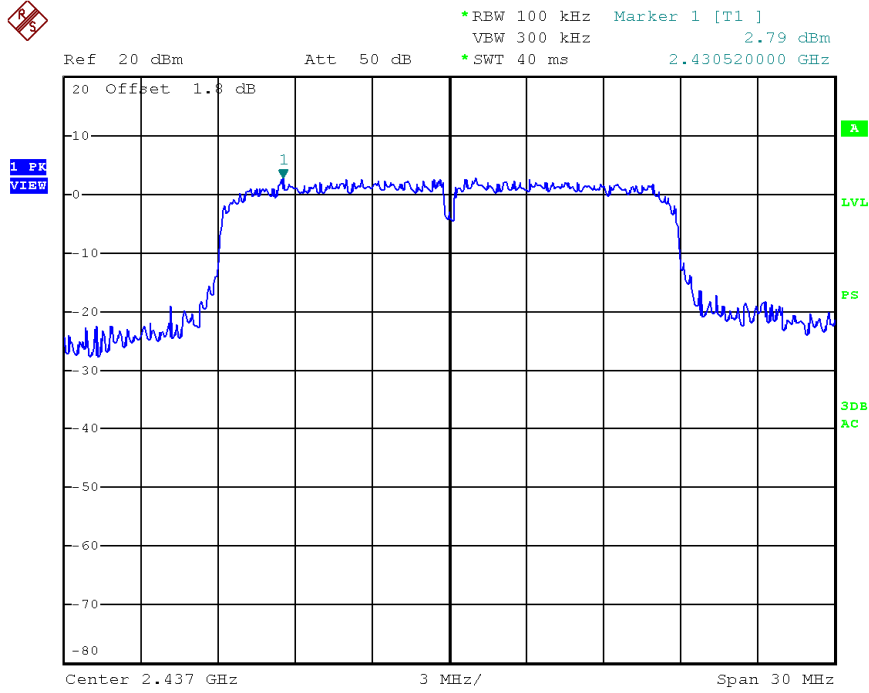

Date: 24.JUN.2014 17:11:10

Frequency H – Chain 1

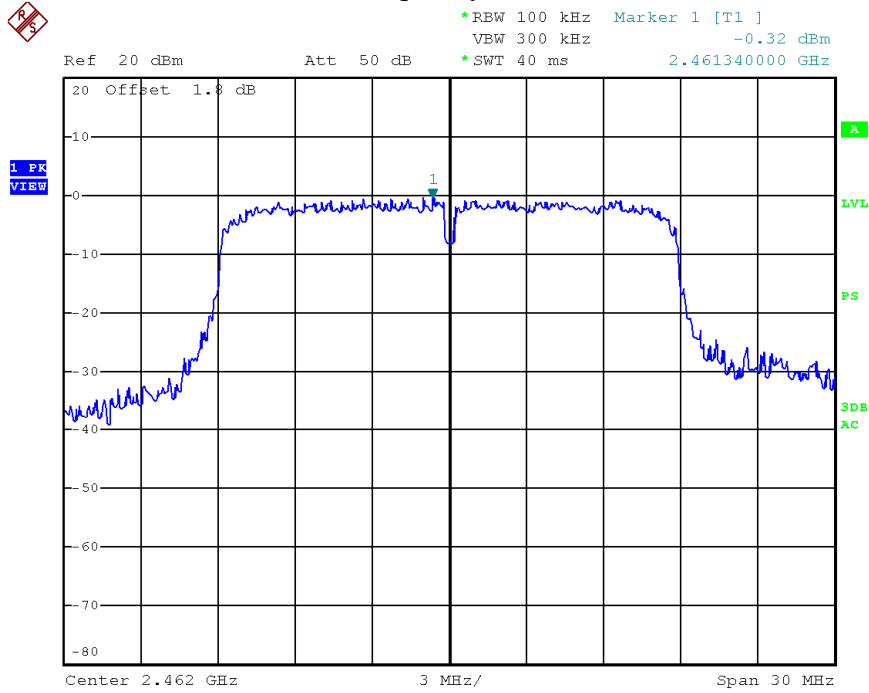

Date: 24.JUN.2014 17:11:34

Frequency L – Chain 2

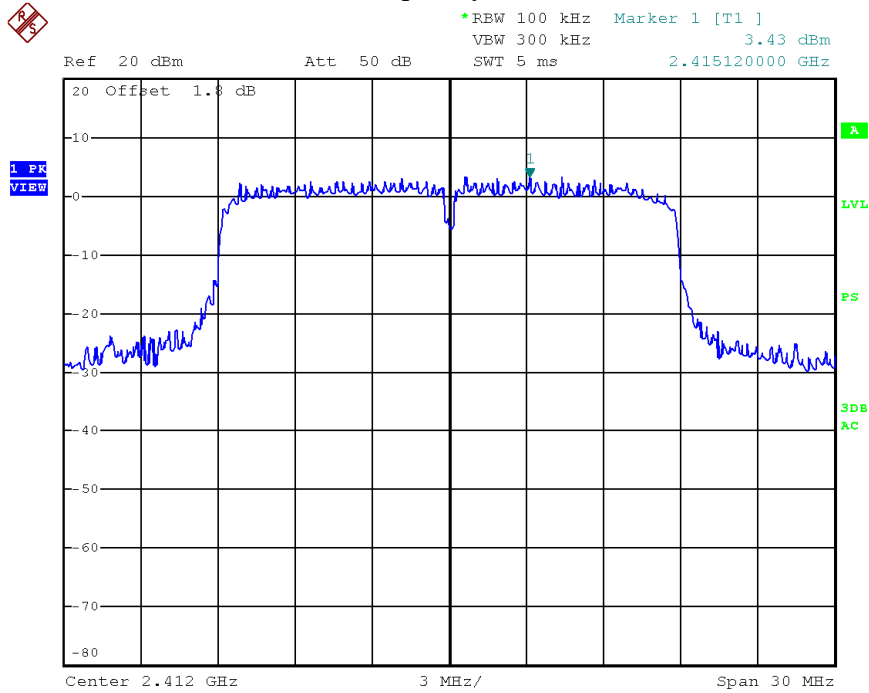

Date: 24.JUN.2014 17:27:57

Frequency M – Chain 2

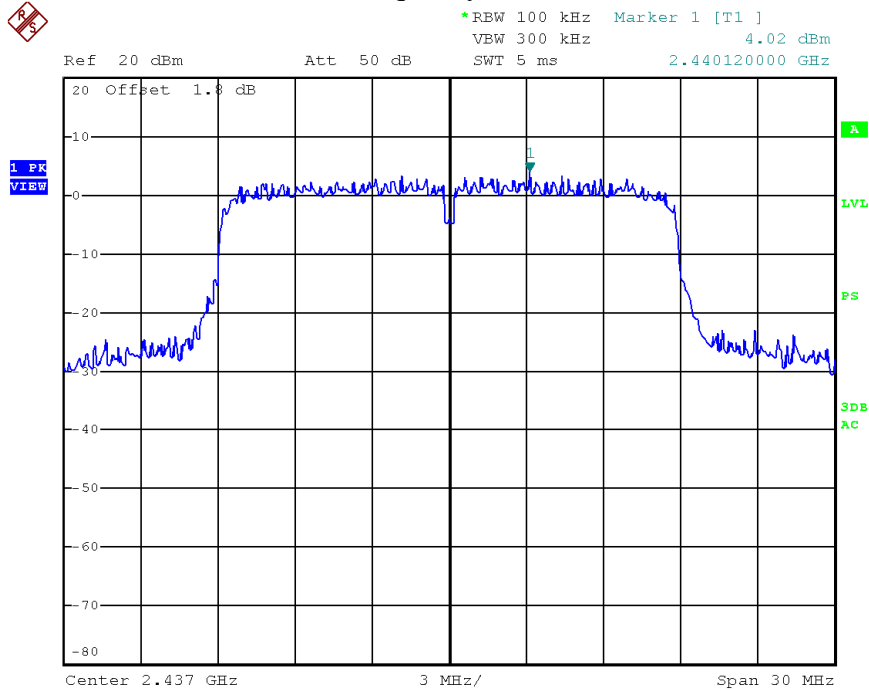

Date: 24.JUN.2014 17:29:26

Frequency H – Chain 2

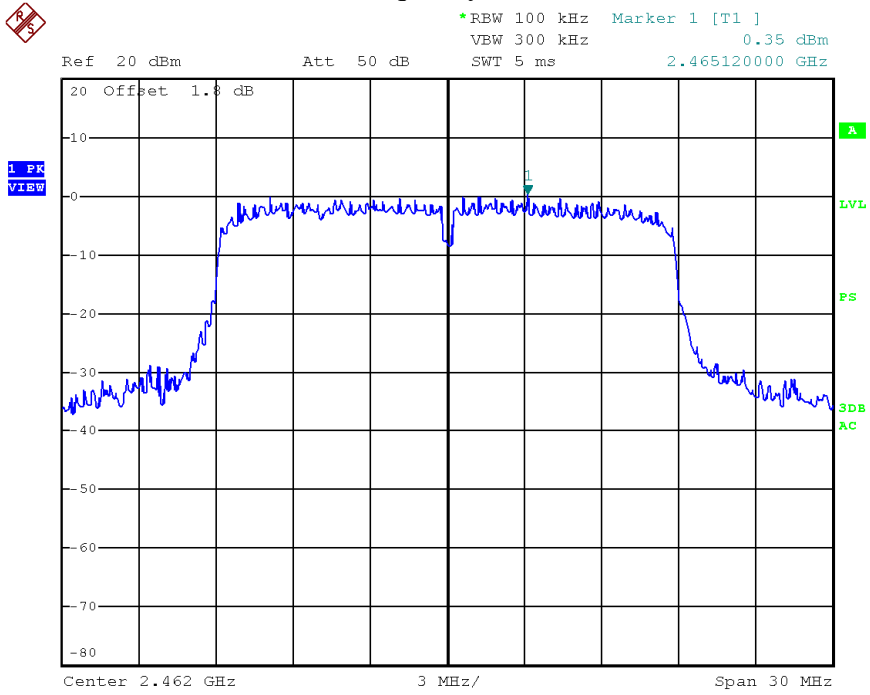

Date: 24.JUN.2014 17:30:01

6. Radiated emission in the restricted bands

Test result: **PASS**

6.1 Test limit

The radiated emissions which fall in the restricted bands, as defined in §15.205(a), must also comply with the radiated emission limits specified in §15.209(a) showed as below:

Frequency (MHz)	Field Strength (dBuV/m)	Measurement Distance (m)
30 - 88	40.0	3
88 - 216	43.5	3
216 - 960	46.0	3
Above 960	54.0	3

6.2 Test Configuration

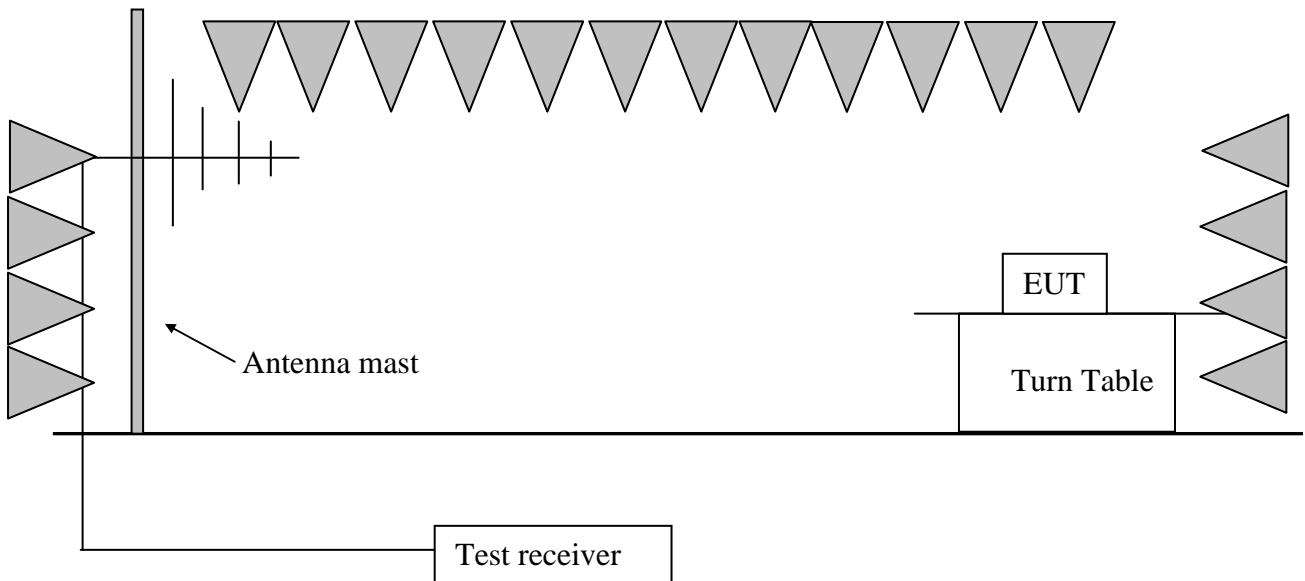



6.3 Test procedure and test setup

The measurement was applied in a semi-anechoic chamber. While testing for spurious emission higher than 1GHz, if applied, the pre-amplifier would be equipped just at the output terminal of the antenna.

The EUT and simulators were placed on a 0.8m high wooden turntable above the horizontal metal ground plane. The turn table rotated 360 degrees to determine the position of the maximum emission level. The EUT was set 3 meters away from the receiving antenna which was mounted on an antenna mast. The antenna moved up and down between from 1meter to 4 meters to find out the maximum emission level.

The EUT was tested according to DTS test procedure of KDB558074 D01 DTS “Meas Guidance v03r02” (clause 12) for compliance to FCC 47CFR 15.247 requirements.



6.4 Test protocol

Temperature : 25 °C
Relative Humidity : 55 %

Mode 802.11b

CH	Antenna	Frequency (MHz)	Correct Factor (dB/m)	Corrected Reading (dBuV/m)	Limit (dBuV/m)	Margin (dB)	Detector
L	H	2413.43	34.50	101.50	/	/	PK
	V	53.32	10.40	38.20	40.00	1.80	QP
	H	125.25	16.00	37.60	43.50	5.90	PK
	H	356.57	17.10	39.30	46.00	6.70	PK
	H	2390.00	34.40	64.00	74.00	10.00	PK
	H	2390.00	34.40	44.30	54.00	9.70	AV
	H	3210.42	-8.00	52.60	54.00	1.40	PK
	H	4823.64	-3.50	56.20	74.00	17.80	PK
	H	4823.53	-3.50	52.10	54.00	1.90	AV
M	H	2438.66	34.60	102.30	/	/	PK
	V	53.32	10.40	38.20	40.00	1.80	QP
	H	125.25	16.00	37.60	43.50	5.90	PK
	H	356.57	17.10	39.30	46.00	6.70	PK
	H	3244.93	-7.80	51.50	54.00	2.50	PK
	H	4881.90	-3.40	56.70	74.00	17.30	PK
	H	4881.90	-3.40	52.50	54.00	1.50	AV
	V	7390.78	2.60	44.00	54.00	10.00	PK
H	H	2460.72	34.70	103.50	/	/	PK
	V	53.32	10.40	38.20	40.00	1.80	QP
	H	125.25	16.00	37.60	43.50	5.90	PK
	H	356.57	17.10	39.30	46.00	6.70	PK
	H	2483.50	34.70	64.20	74.00	9.80	PK
	H	2483.50	34.70	44.60	54.00	9.40	AV
	H	3280.56	-7.70	51.00	54.00	3.00	PK
	H	4921.84	-3.30	57.10	74.00	16.90	PK



	H	4921.67	-3.30	52.90	54.00	1.10	AV
--	---	---------	-------	-------	-------	------	----

Mode 802.11g

CH	Antenna	Frequency (MHz)	Correct Factor (dB/m)	Corrected Reading (dBUV/m)	Limit (dBUV/m)	Margin (dB)	Detector
L	H	2413.83	34.50	104.70	/	/	PK
	V	53.32	10.40	38.20	40.00	1.80	QP
	H	125.25	16.00	37.60	43.50	5.90	PK
	H	356.57	17.10	39.30	46.00	6.70	PK
	H	2390.00	34.40	67.70	74.00	6.30	PK
	H	2390.00	34.40	47.90	54.00	6.10	AV
	H	3210.42	-8.00	51.30	54.00	2.70	PK
	H	4823.64	-3.50	56.20	74.00	17.80	PK
	H	4823.53	-3.50	45.40	54.00	8.60	AV
M	H	2440.29	34.60	105.10	/	/	PK
	V	53.32	10.40	38.20	40.00	1.80	QP
	H	125.25	16.00	37.60	43.50	5.90	PK
	H	356.57	17.10	39.30	46.00	6.70	PK
	H	3244.93	-7.80	51.90	54.00	2.10	PK
	H	4881.90	-3.40	56.70	74.00	17.30	PK
	H	4881.90	-3.40	45.50	54.00	8.50	AV
	V	7348.69	2.50	44.30	54.00	9.70	PK
H	H	2463.53	34.70	104.50	/	/	PK
	V	53.32	10.40	38.20	40.00	1.80	QP
	H	125.25	16.00	37.60	43.50	5.90	PK
	H	356.57	17.10	39.30	46.00	6.70	PK
	H	2483.50	34.70	73.20	74.00	0.80	PK
	H	2483.50	34.70	53.40	54.00	0.60	AV
	H	3280.56	-7.70	50.50	54.00	3.50	PK
	H	4921.84	-3.30	52.30	74.00	21.70	PK



Mode 802.11n20

CH	Antenna	Frequency (MHz)	Correct Factor (dB/m)	Corrected Reading (dBUV/m)	Limit (dBUV/m)	Margin (dB)	Detector
L	H	2410.22	34.50	106.00	/	/	PK
	V	53.32	10.40	38.20	40.00	1.80	QP
	H	125.25	16.00	37.60	43.50	5.90	PK
	H	356.57	17.10	39.30	46.00	6.70	PK
	H	2390.00	34.40	67.30	74.00	6.70	PK
	H	2390.00	34.40	47.50	54.00	6.50	AV
	H	3210.42	-8.00	53.00	54.00	1.00	PK
	H	4823.64	-3.50	55.00	74.00	19.00	PK
	H	4823.53	-3.50	40.60	54.00	13.40	AV
M	H	2440.29	34.60	105.10	/	/	PK
	V	53.32	10.40	38.20	40.00	1.80	QP
	H	125.25	16.00	37.60	43.50	5.90	PK
	H	356.57	17.10	39.30	46.00	6.70	PK
	H	3244.93	-7.80	51.90	54.00	2.10	PK
	H	4881.90	-3.40	55.20	74.00	18.80	PK
	H	4881.90	-3.40	44.80	54.00	9.20	AV
	V	7390.78	2.60	44.70	54.00	9.30	PK
H	H	2460.32	34.70	105.70	/	/	PK
	V	53.32	10.40	38.20	40.00	1.80	QP
	H	125.25	16.00	37.60	43.50	5.90	PK
	H	356.57	17.10	39.30	46.00	6.70	PK
	H	2483.50	34.70	73.30	74.00	0.70	PK
	H	2483.50	34.70	53.10	54.00	0.90	AV
	H	3280.56	-7.70	53.00	54.00	1.00	PK
	H	4921.84	-3.30	50.80	74.00	23.20	PK

- Remark: 1. Correct Factor = Antenna Factor + Cable Loss (-Amplifier, is employed)
 2. Corrected Reading = Original Receiver Reading + Correct Factor
 3. Margin = limit – Corrected Reading



4. The QP detector is applied only while the Pulse-repetition frequency of assessed frequency is higher than 20Hz.

Example: Assuming Antenna Factor = 30.20dB/m, Cable Loss = 2.00dB,

Original Receiver Reading = 10dBuV.

Then Correct Factor = $30.20 + 2.00 = 32.20\text{dB/m}$; Corrected Reading = $10\text{dBuV} + 32.20\text{dB/m} = 42.20\text{dBuV/m}$

Assuming limit = 54dBuV/m, Corrected Reading = 42.20dBuV/m, then Margin = $54 - 42.20 = 11.80\text{dBuV/m}$

7. Emission outside the frequency Band

Test result: PASS

7.1 Limit

In any 100 kHz bandwidth outside the frequency band in which the spread spectrum intentional radiator is operating, the radio frequency power that is produced by the intentional radiator shall be at least 20 dB below that in the 100 kHz bandwidth within the band that contains the highest level of the desired power.

7.2 Test Configuration

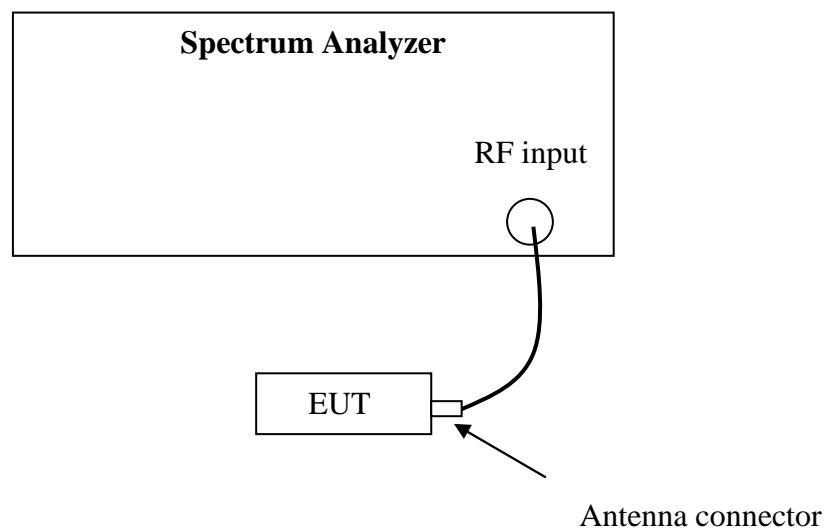

7.3 Test procedure and test setup

The Emission outside the frequency Band per FCC §15.247(d) is measured using the Spectrum Analyzer with the resolutions bandwidth set at 100kHz, the video bandwidth set at 300kHz, and the SPAN>>RBW.

The EUT was tested according to DTS test procedure of “KDB558074 D01 DTS Meas Guidance v03r02” (clause 11.0) for compliance to FCC 47CFR 15.247 requirements.



7.4 Test protocol

Temperature : 25 °C
Relative Humidity : 55 %

802.11b Out-of-Band Emissions – Chain 1

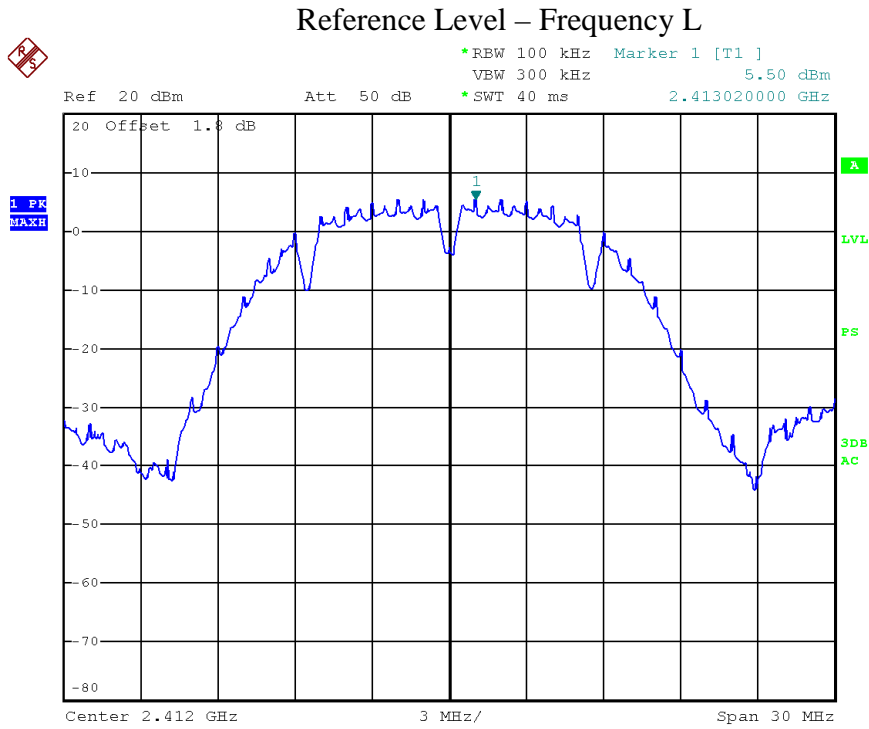

Date: 24.JUN.2014 17:06:11

Conducted emission - Frequency L

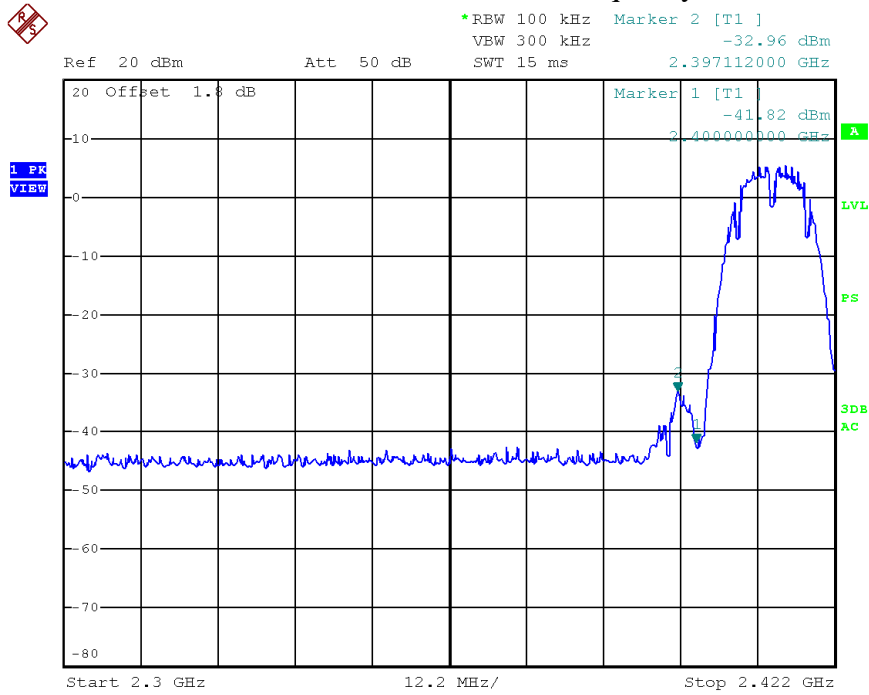

Date: 24.JUN.2014 17:41:37

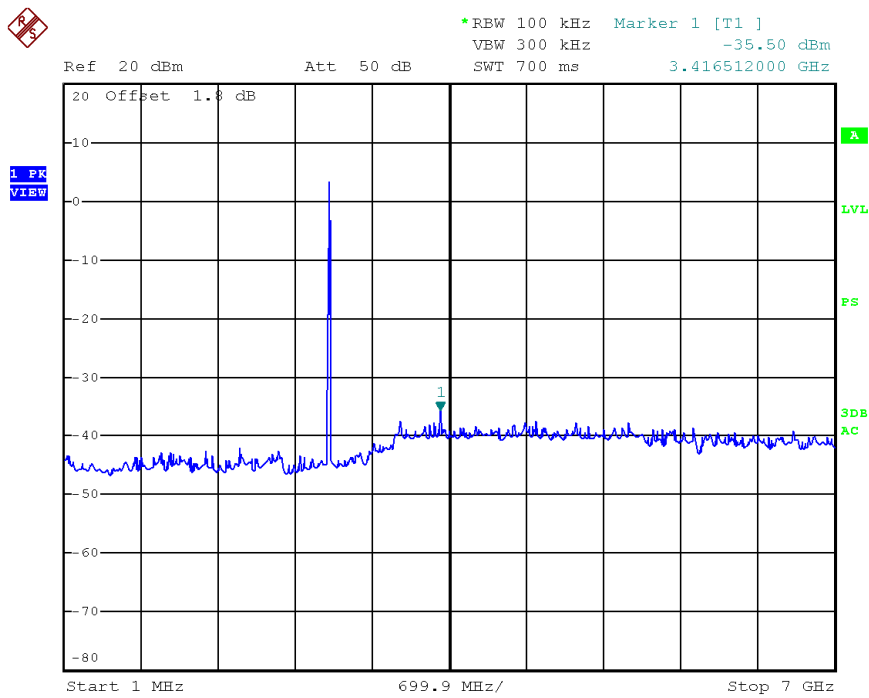

Date: 24.JUN.2014 17:42:26

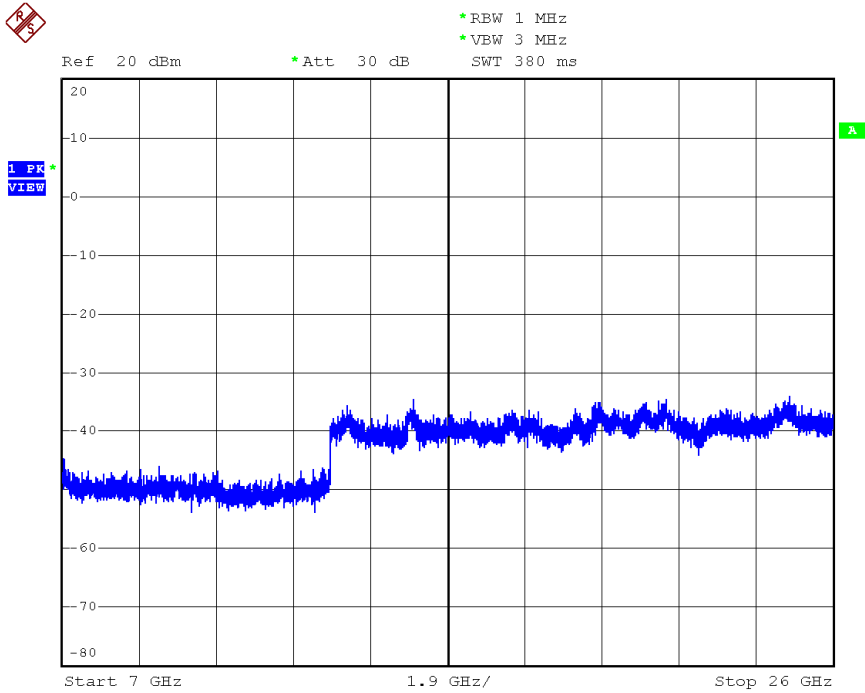

Date: 3.JUN.2014 14:45:29

Reference Level – Frequency M

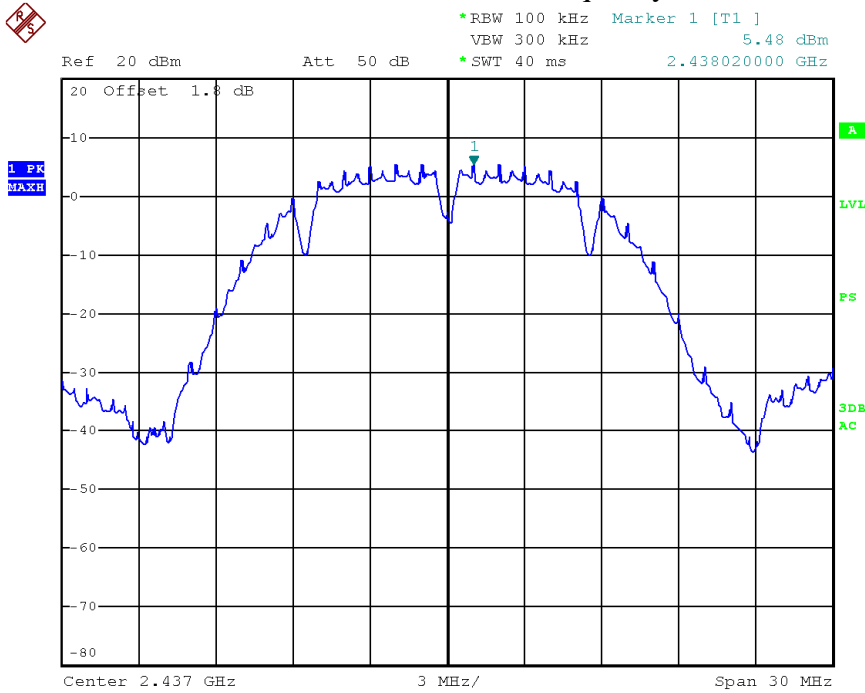

Date: 24.JUN.2014 17:06:36

Conducted emission – Frequency M

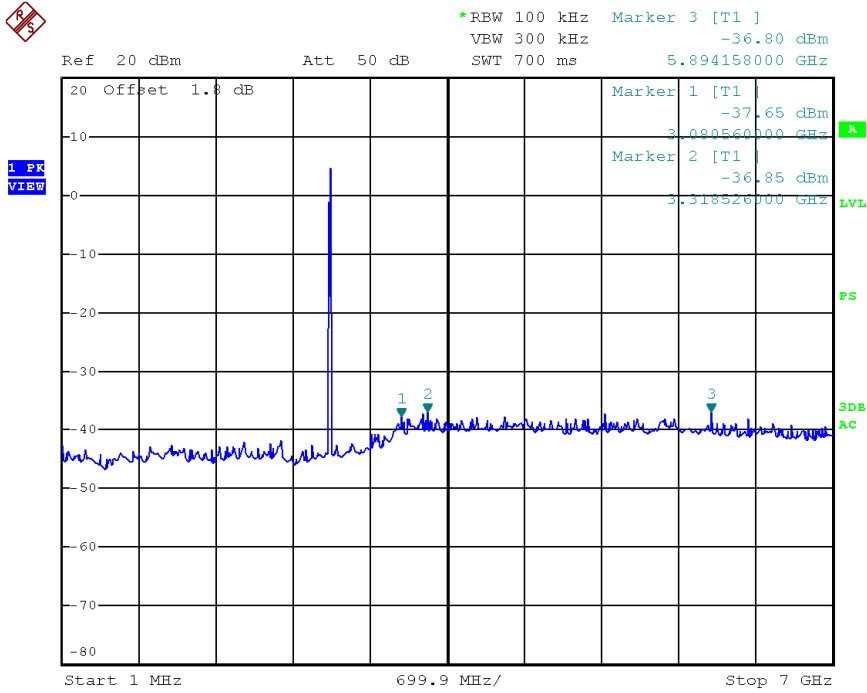

Date: 25.JUN.2014 21:16:43

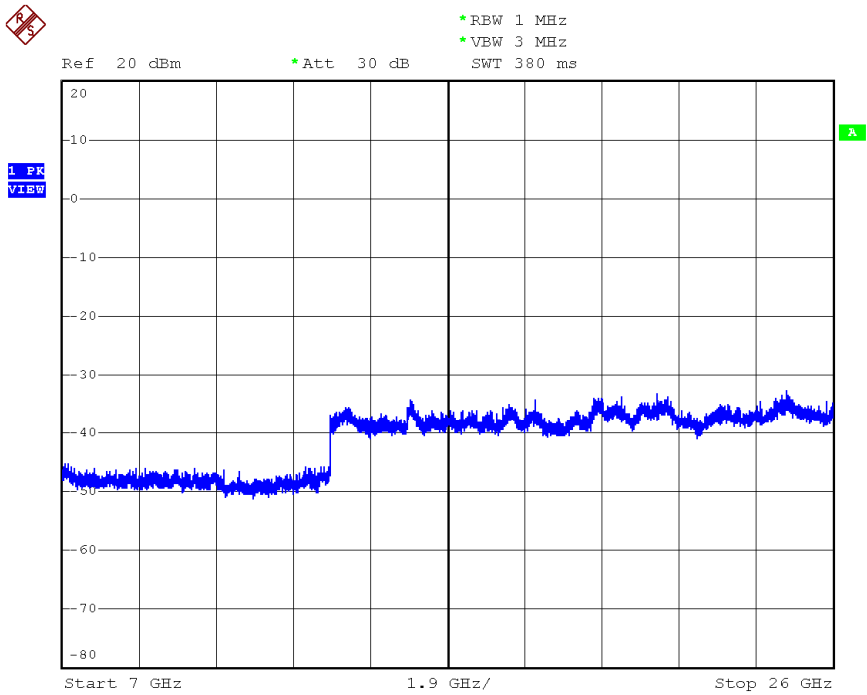

Date: 3.JUN.2014 14:35:08

Reference Level – Frequency H

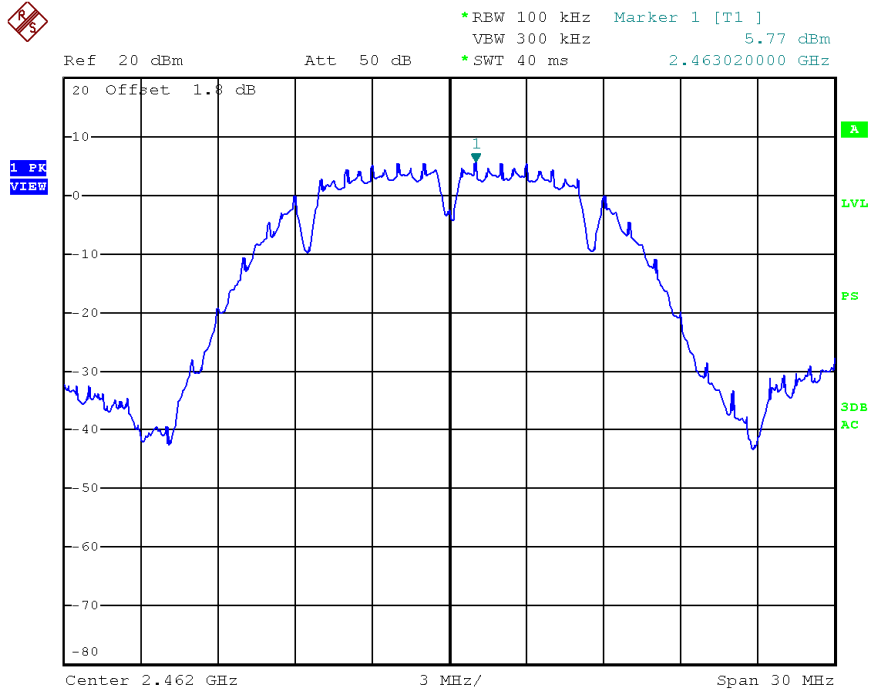

Date: 24.JUN.2014 17:07:09

Conducted emission - Frequency H

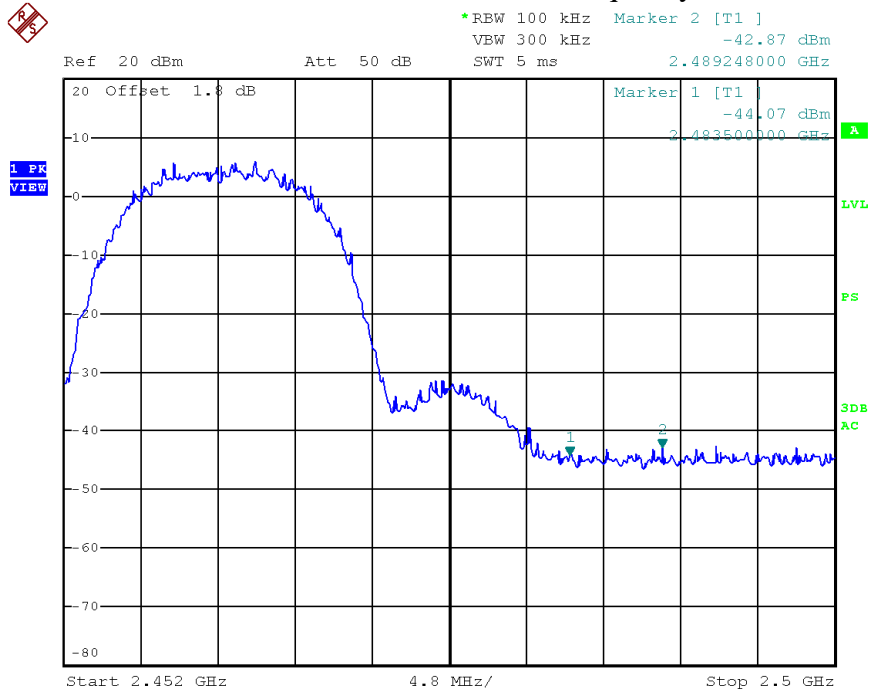

Date: 24.JUN.2014 17:47:20

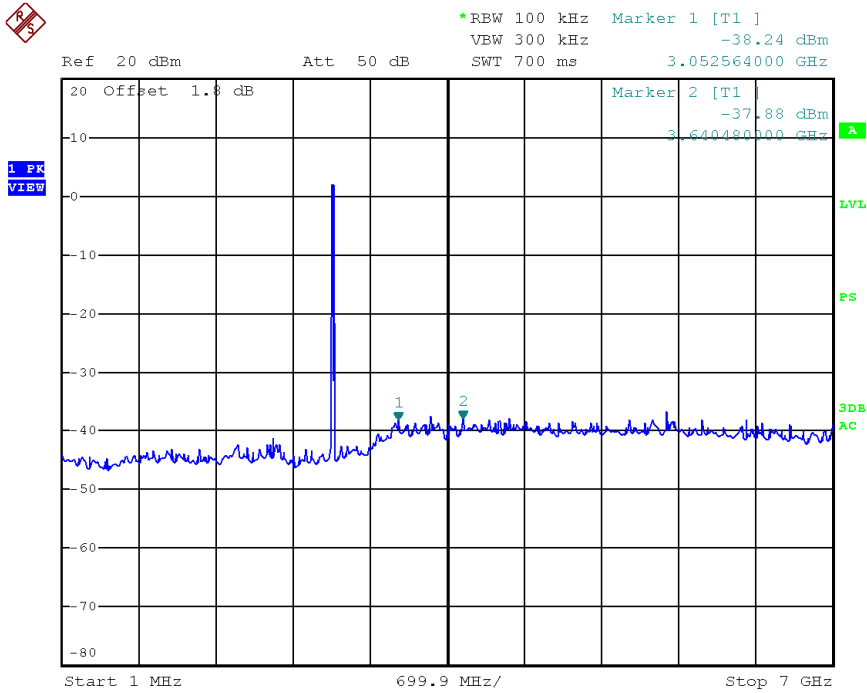

Date: 25.JUN.2014 21:17:30

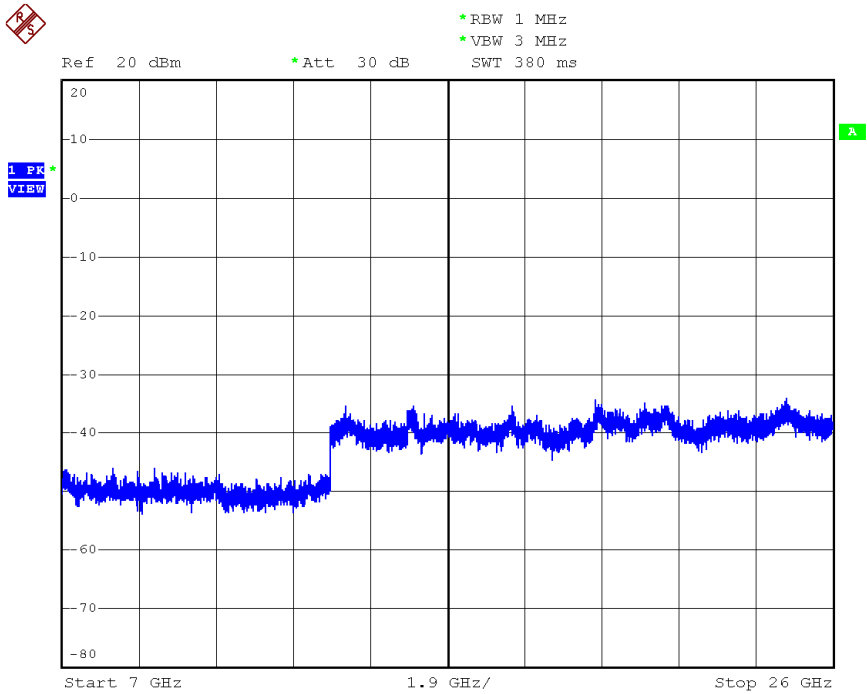

Date: 3.JUN.2014 14:45:45

802.11g Out-of-Band Emissions – Chain 1

Reference Level – Frequency L

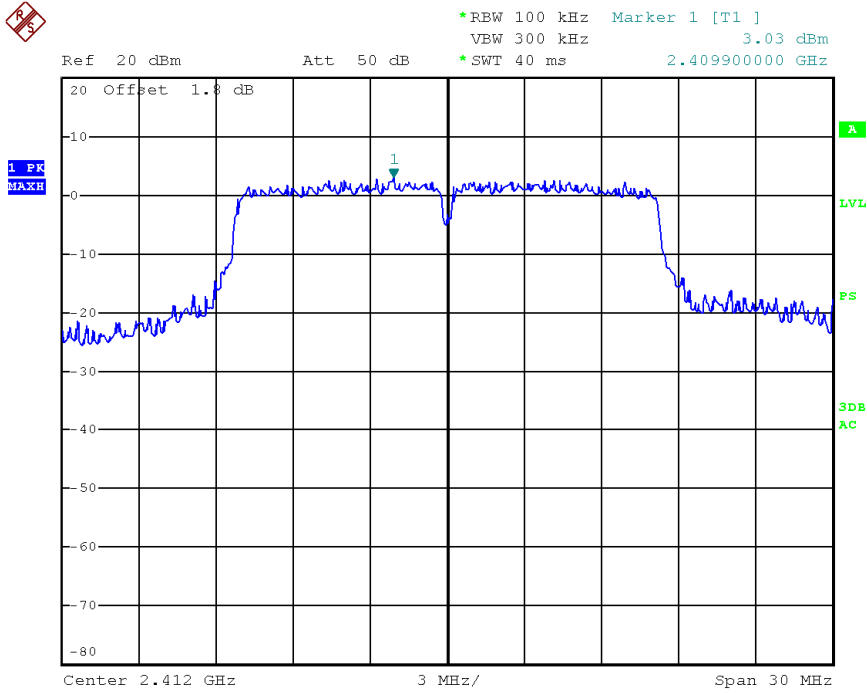

Date: 24.JUN.2014 17:07:48

Conducted emission - Frequency L

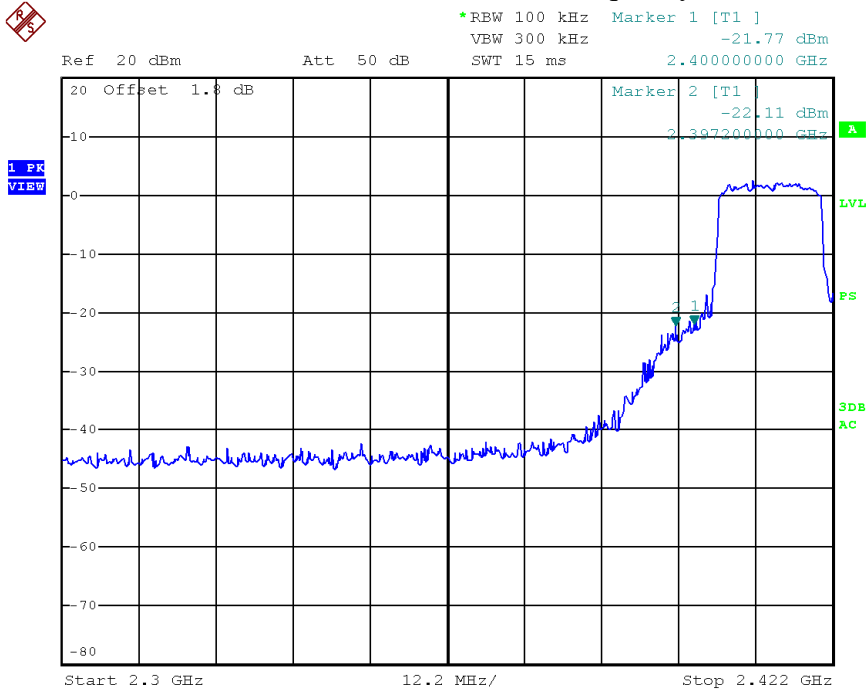

Date: 24.JUN.2014 17:48:43

Reference Level – Frequency M

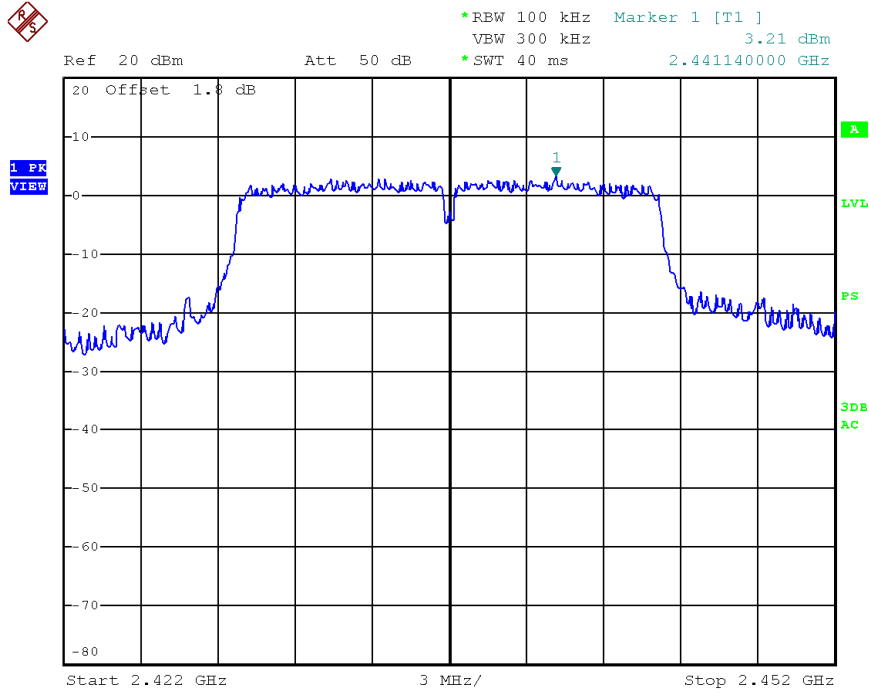

Date: 24.JUN.2014 17:09:13

Conducted emission – Frequency M

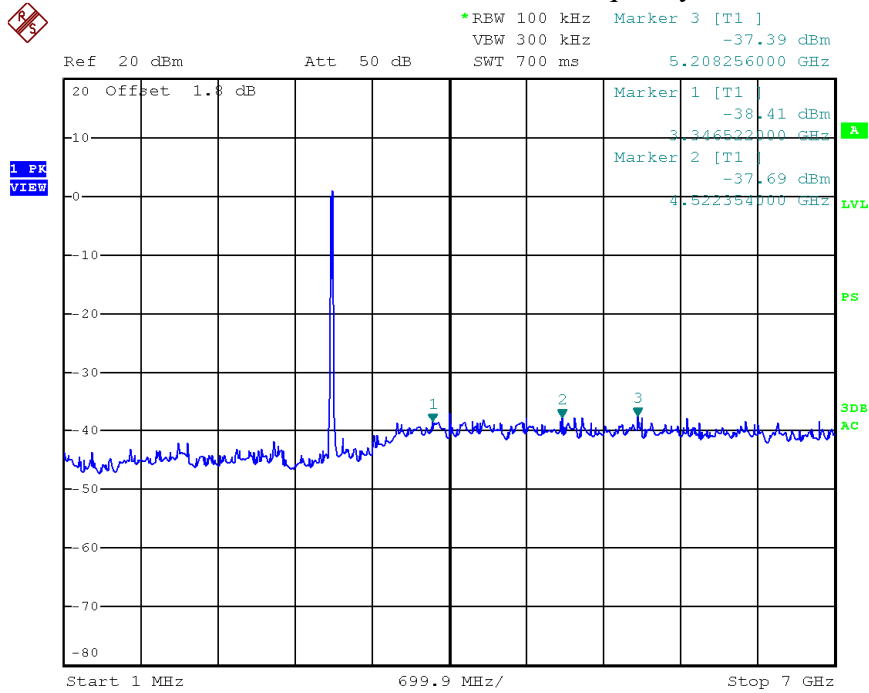

Date: 24.JUN.2014 17:51:06

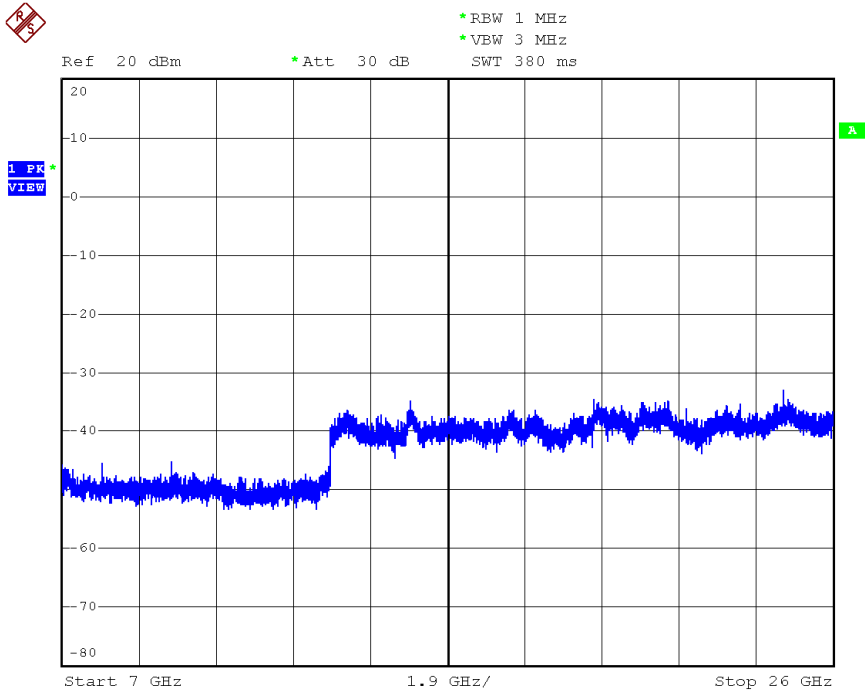

Date: 3.JUN.2014 14:46:26

Reference Level – Frequency H

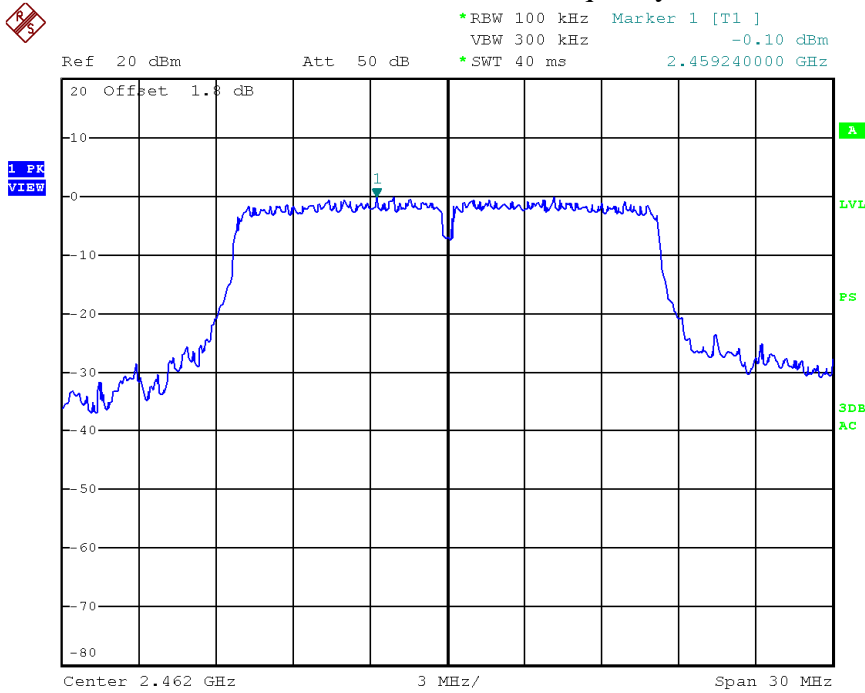

Date: 24.JUN.2014 17:09:47

Conducted emission - Frequency H

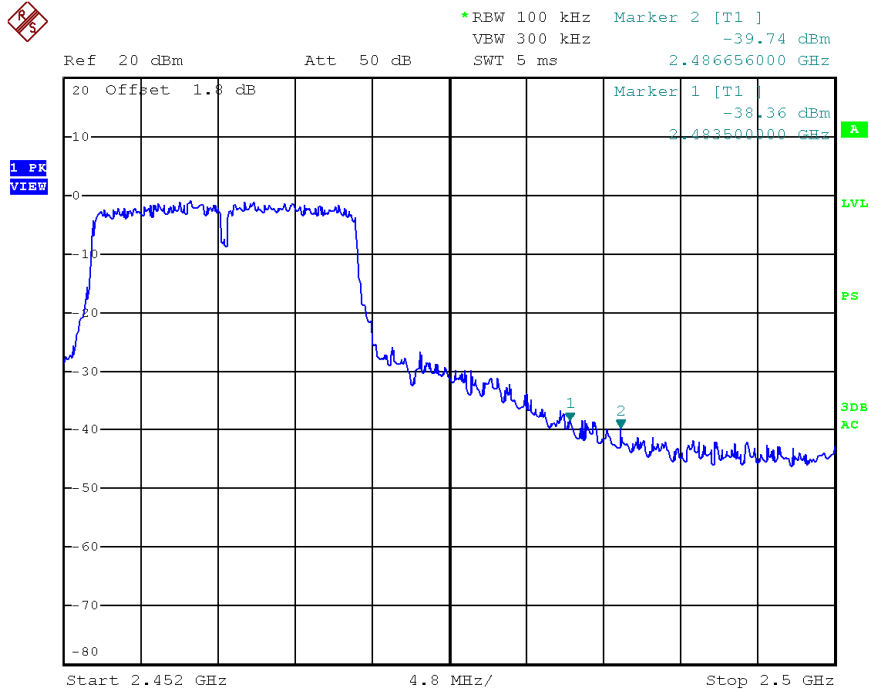

Date: 24.JUN.2014 17:52:10

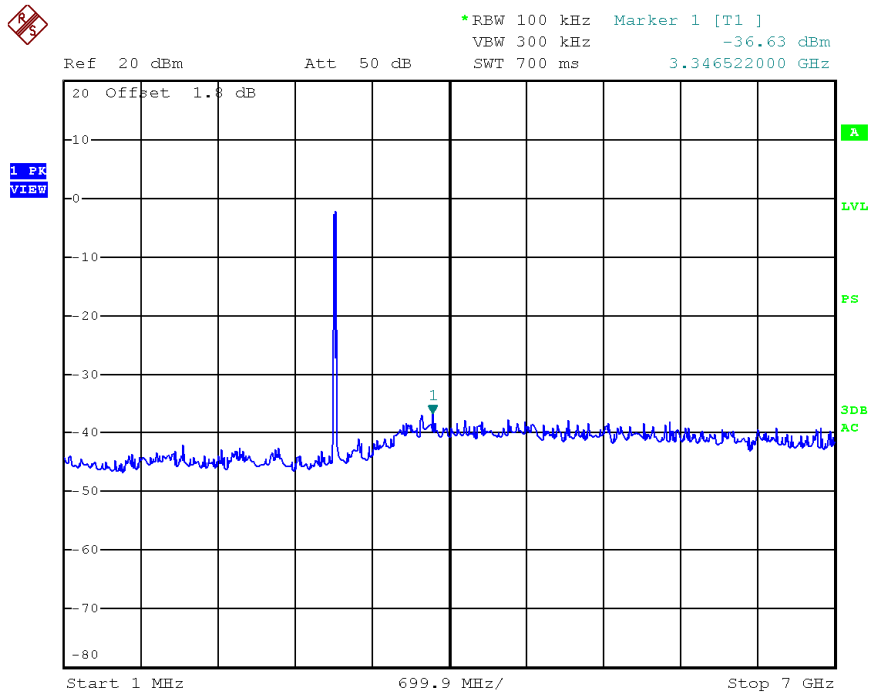

Date: 24.JUN.2014 17:51:37

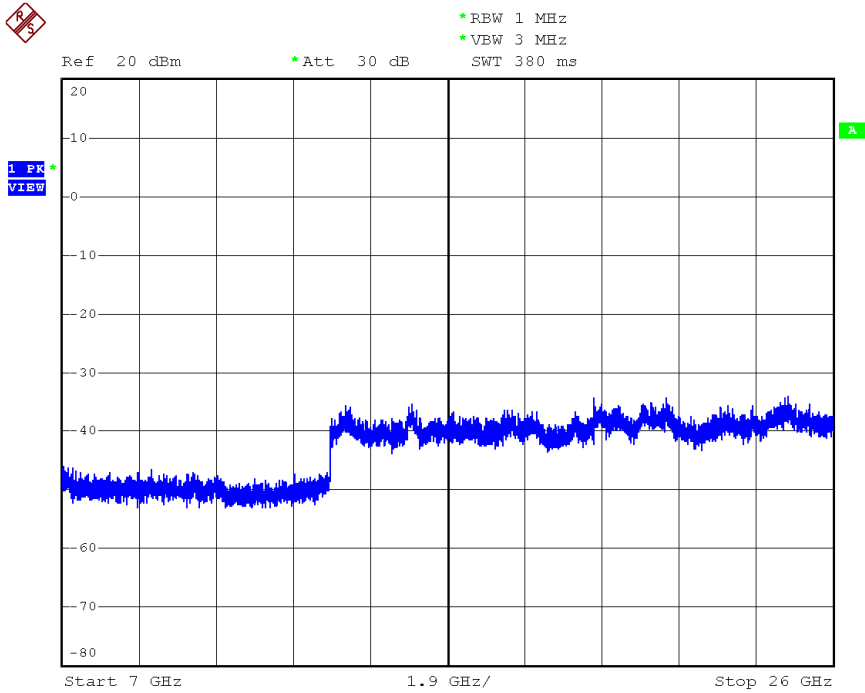

Date: 3.JUN.2014 14:46:41

802.11n20 Out-of-Band Emissions – Chain 1

Reference Level – Frequency L

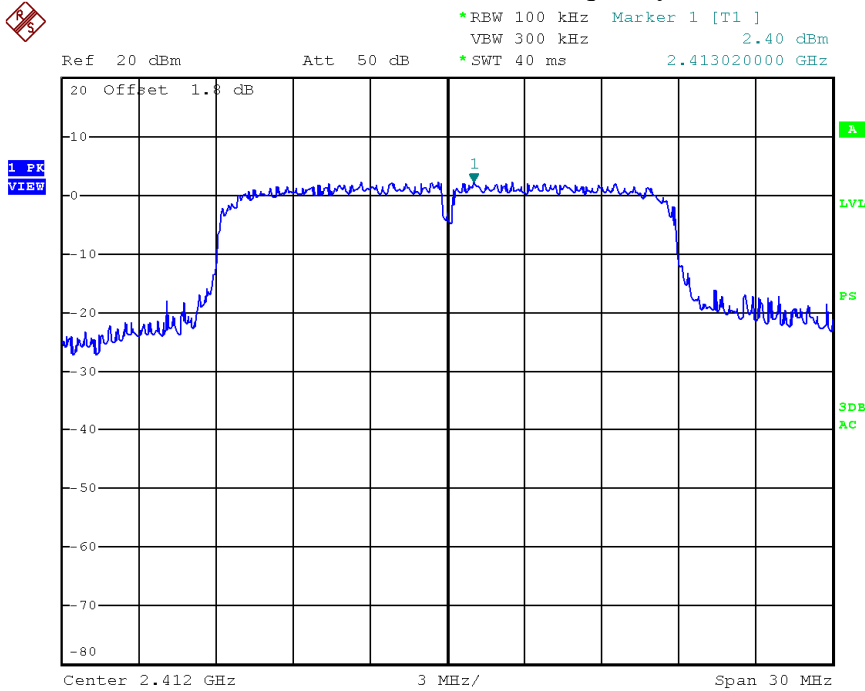

Date: 24.JUN.2014 17:10:43

Conducted emission - Frequency L

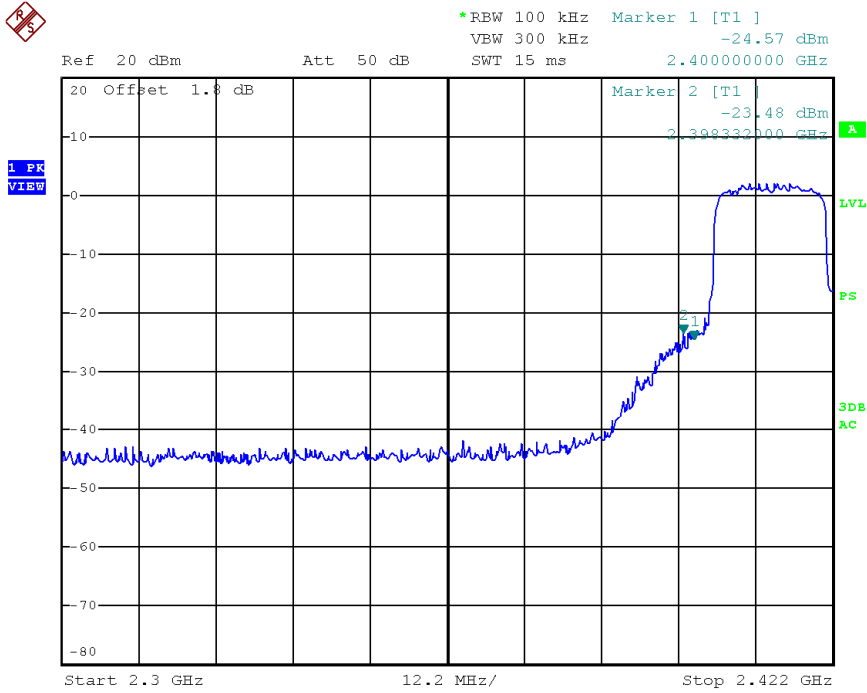

Date: 25.JUN.2014 21:19:42

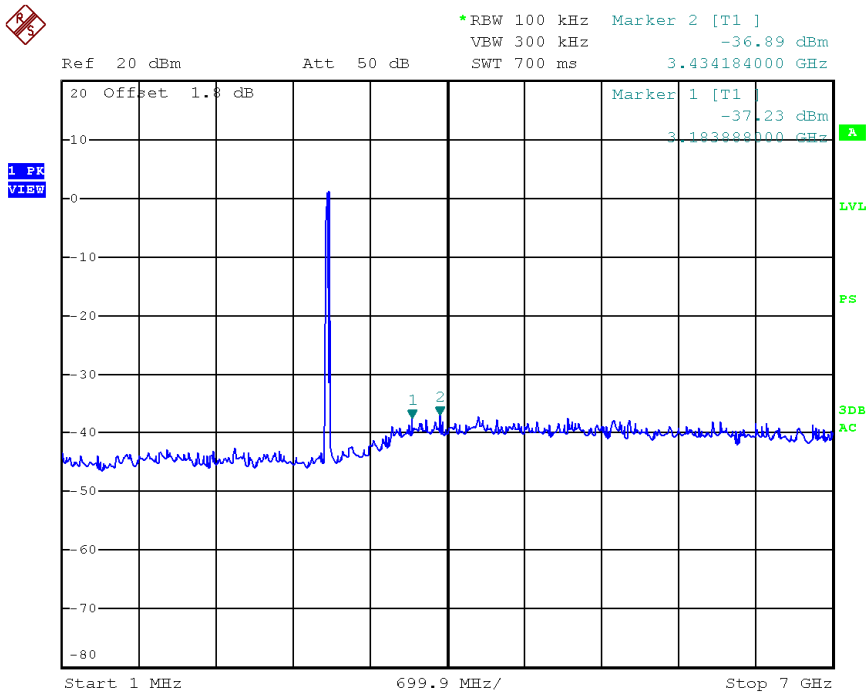

Date: 25.JUN.2014 21:20:33

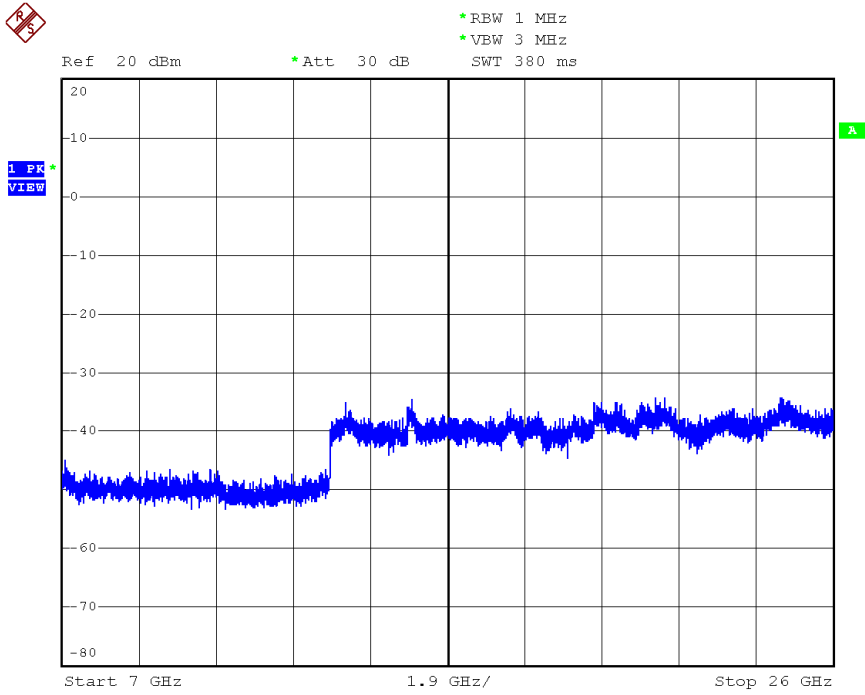

Date: 3.JUN.2014 14:47:15

Reference Level – Frequency M

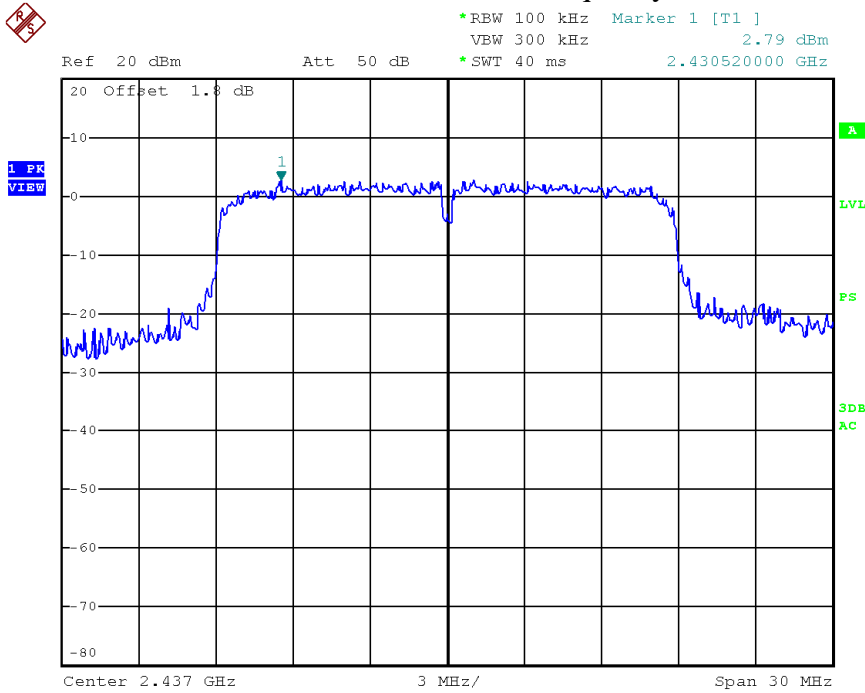

Date: 24.JUN.2014 17:11:10

Conducted emission – Frequency M

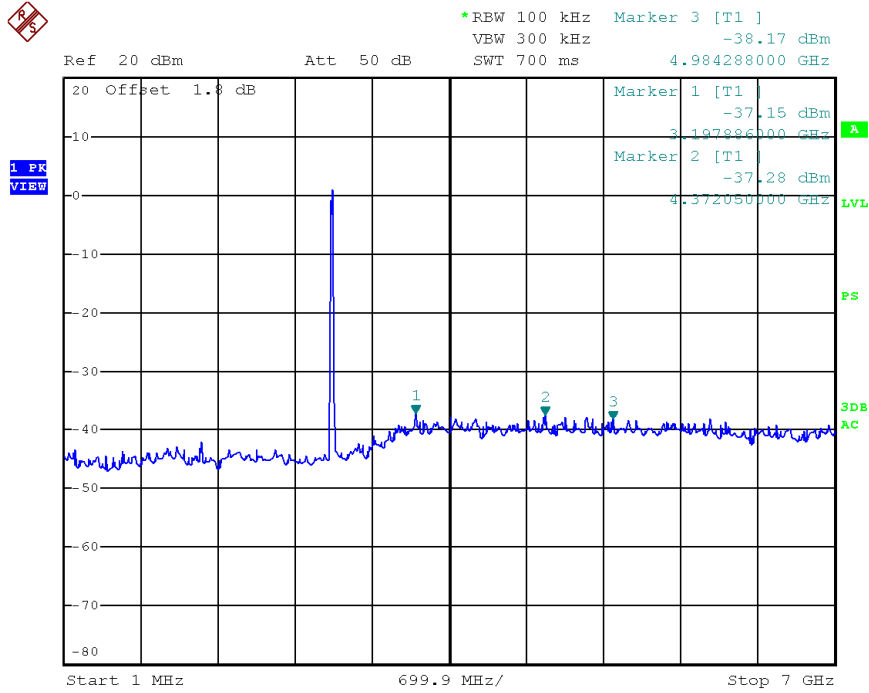

Date: 25.JUN.2014 21:21:20

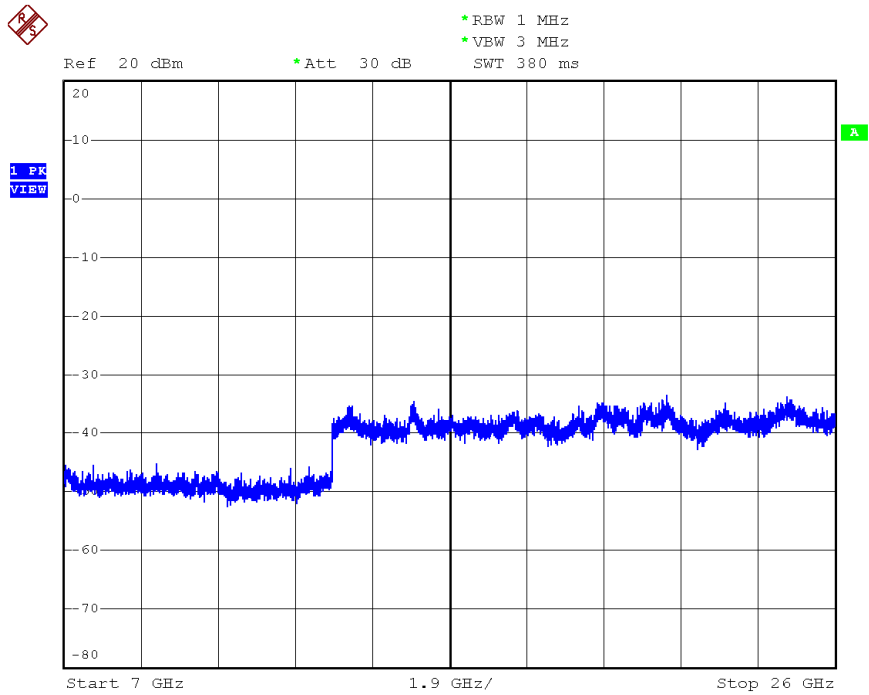

Date: 3.JUN.2014 14:35:37

Reference Level – Frequency H

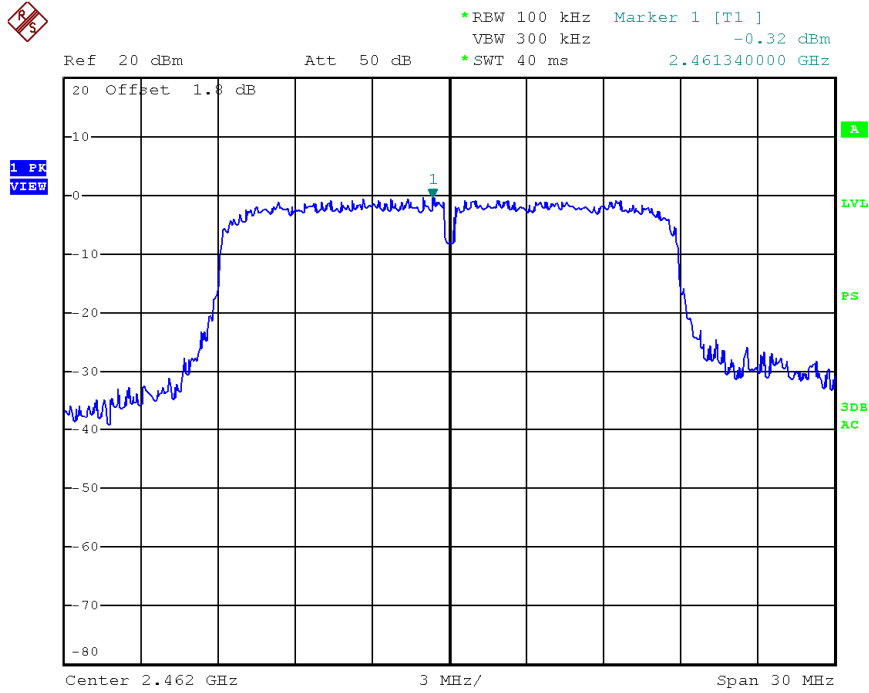

Date: 24.JUN.2014 17:11:34

Conducted emission - Frequency H

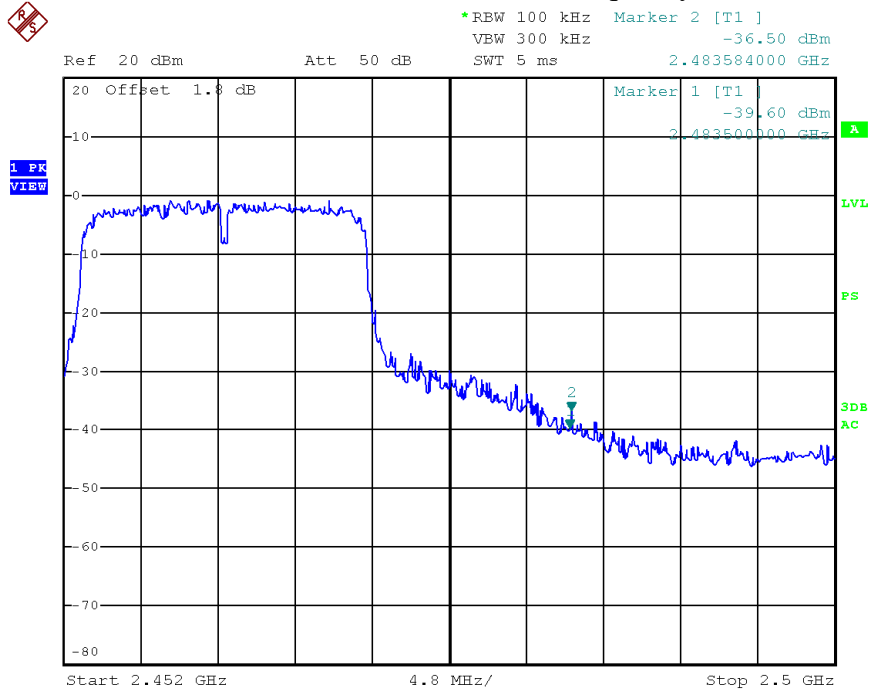

Date: 25.JUN.2014 21:22:43

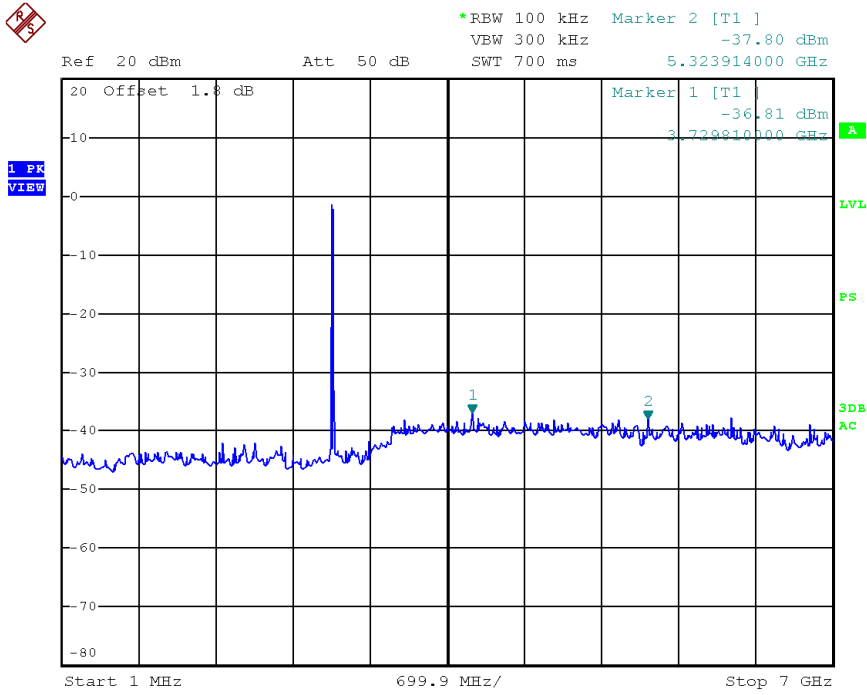

Date: 25.JUN.2014 21:22:00

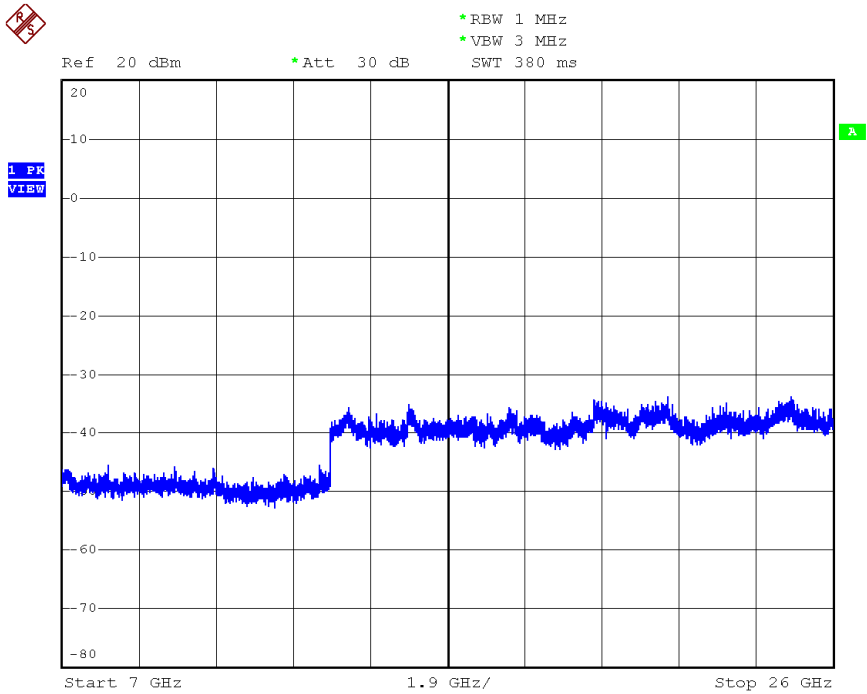

Date: 3.JUN.2014 14:41:11

802.11n20 Out-of-Band Emissions – Chain 2

Reference Level – Frequency L

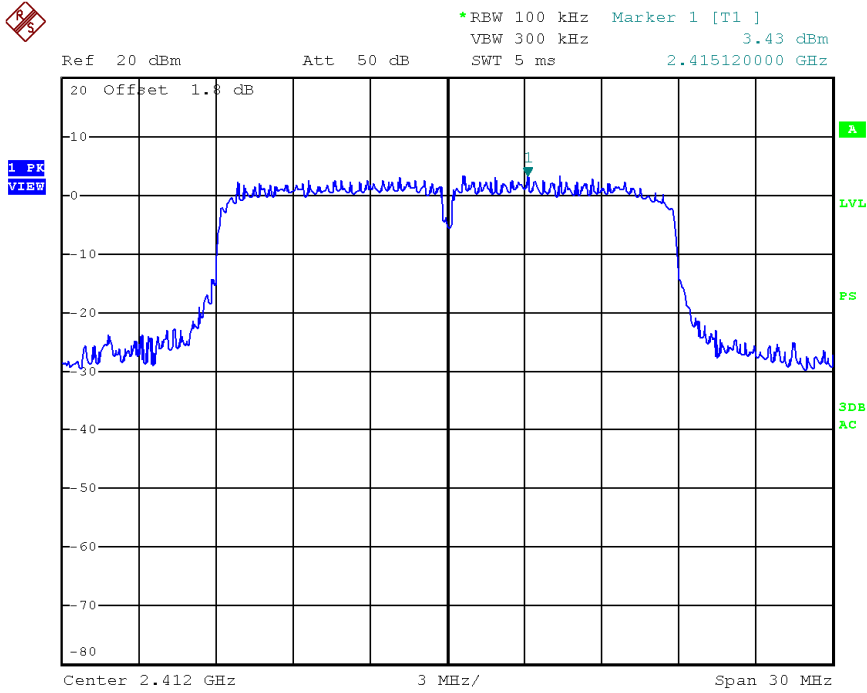

Date: 24.JUN.2014 17:27:57

Conducted emission - Frequency L

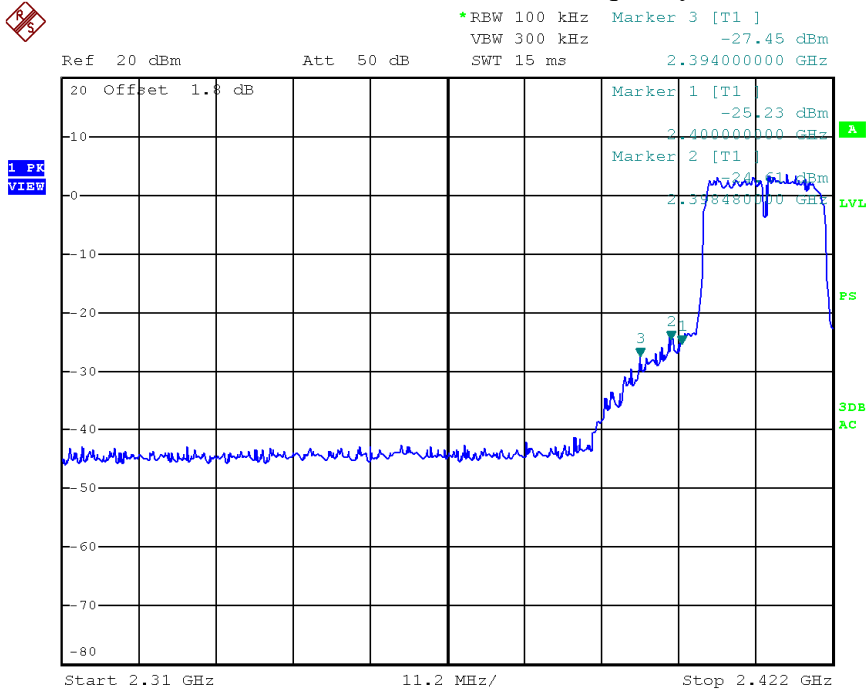

Date: 24.JUN.2014 17:33:51

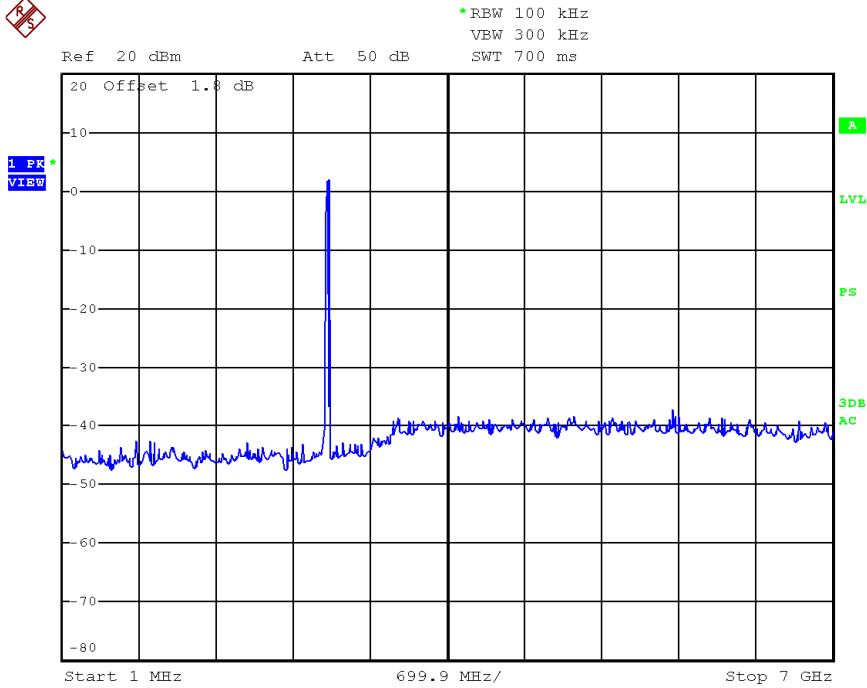

Date: 24.JUN.2014 17:34:44

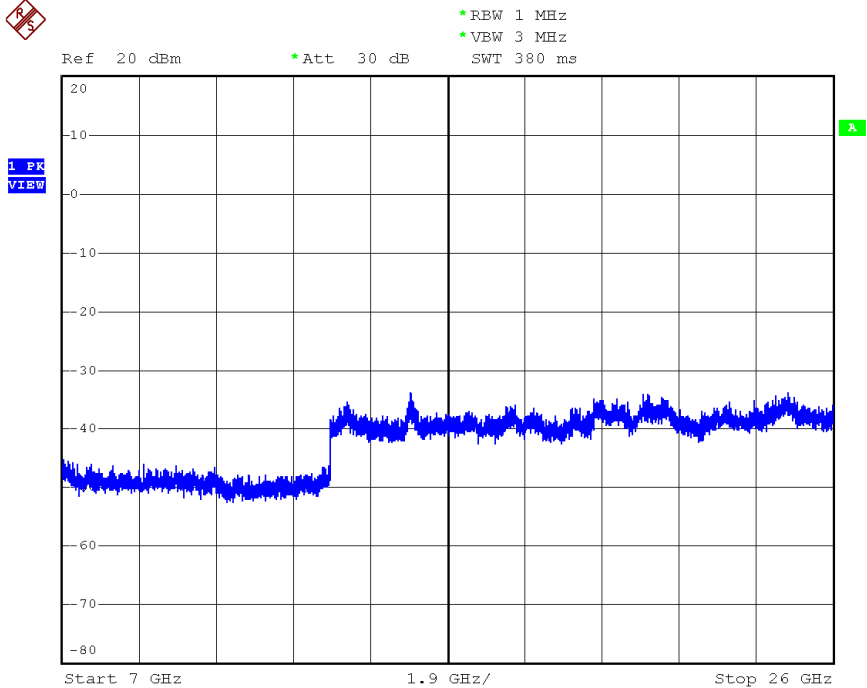

Date: 3.JUN.2014 14:41:24

Reference Level – Frequency M

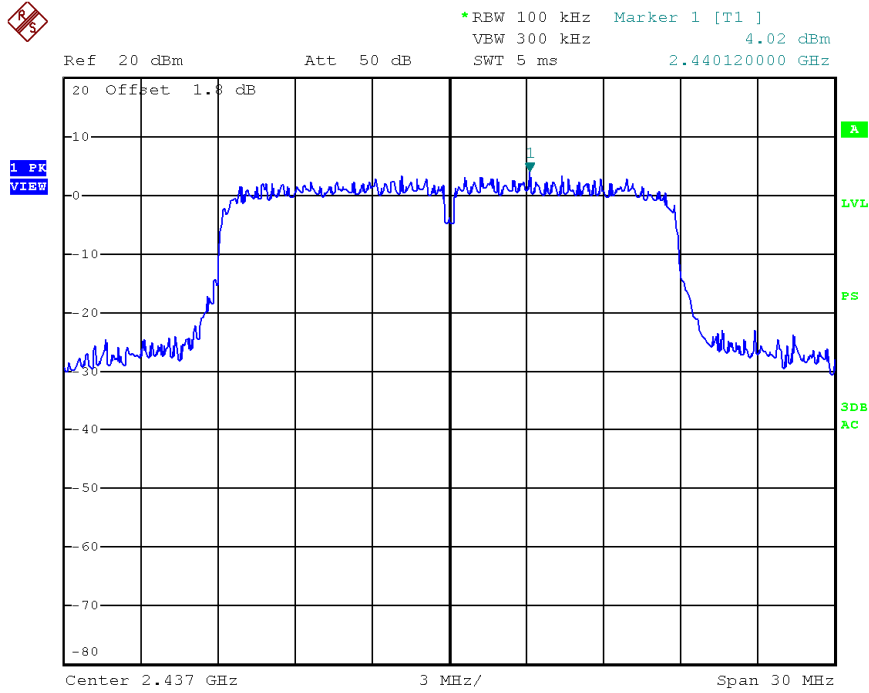

Date: 24.JUN.2014 17:29:26

Conducted emission – Frequency M

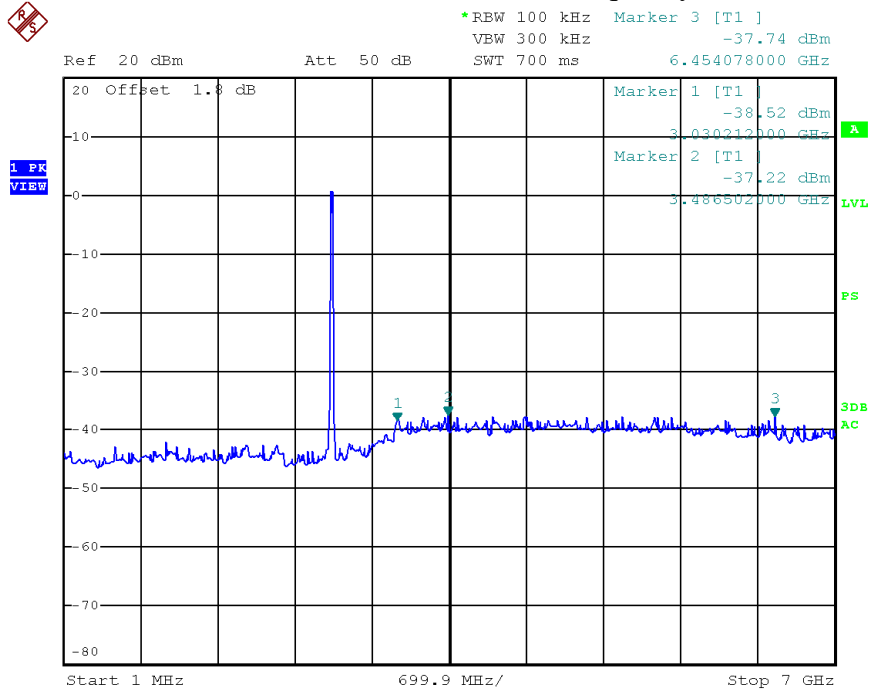

Date: 24.JUN.2014 17:37:08

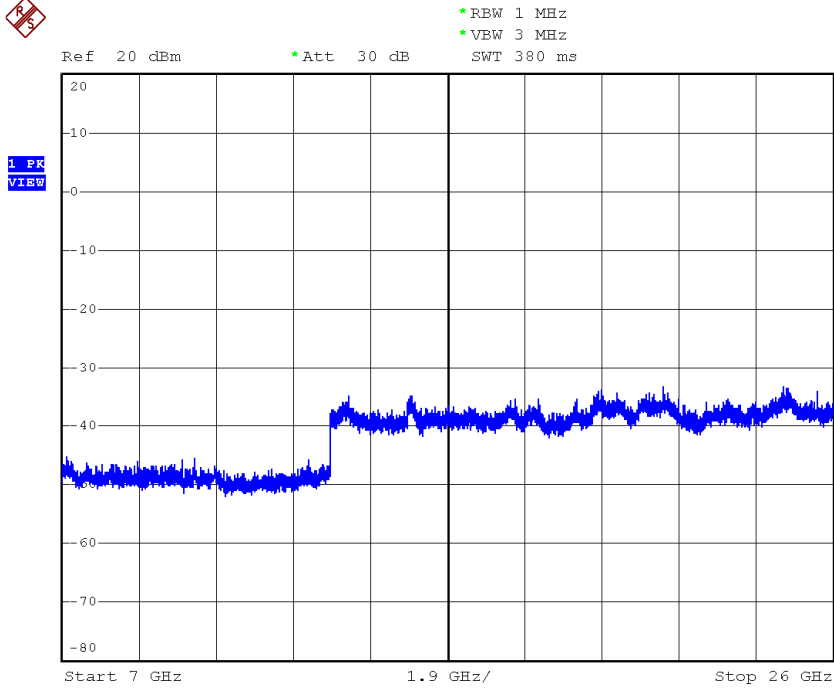

Date: 3.JUN.2014 14:41:40

Reference Level – Frequency H

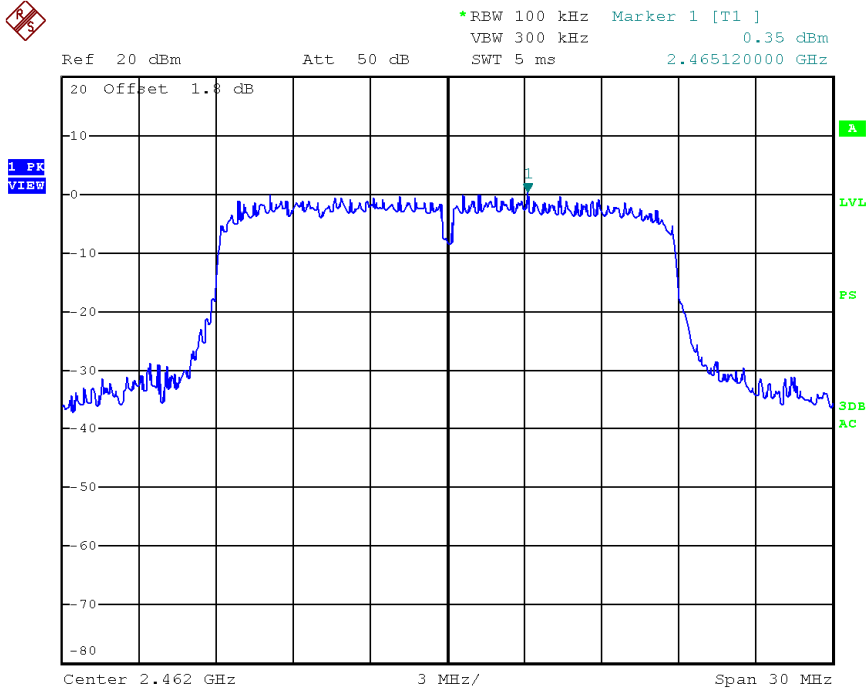

Date: 24.JUN.2014 17:30:01

Conducted emission - Frequency H

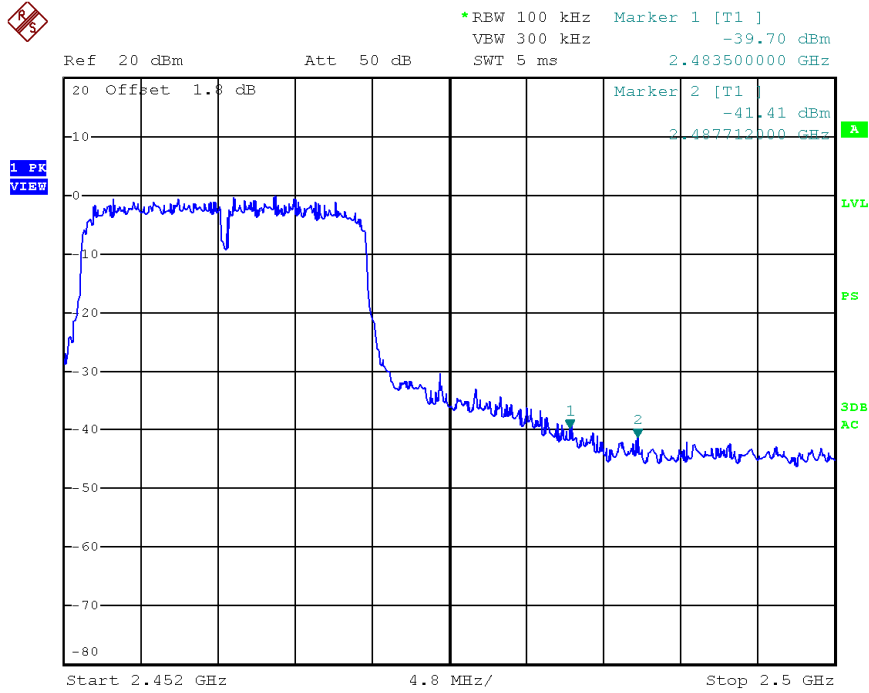

Date: 24.JUN.2014 17:39:05

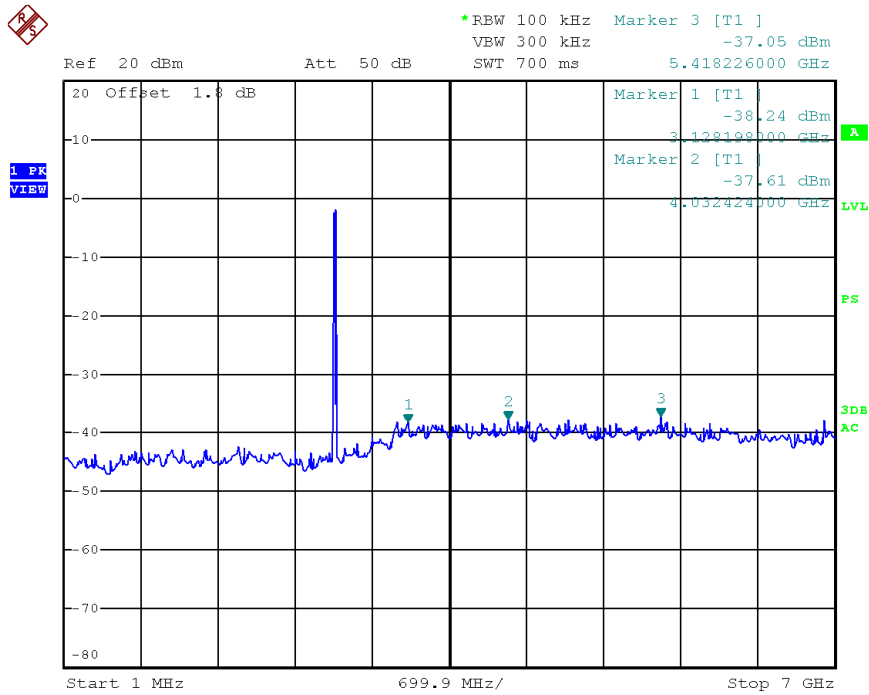

Date: 24.JUN.2014 17:38:13

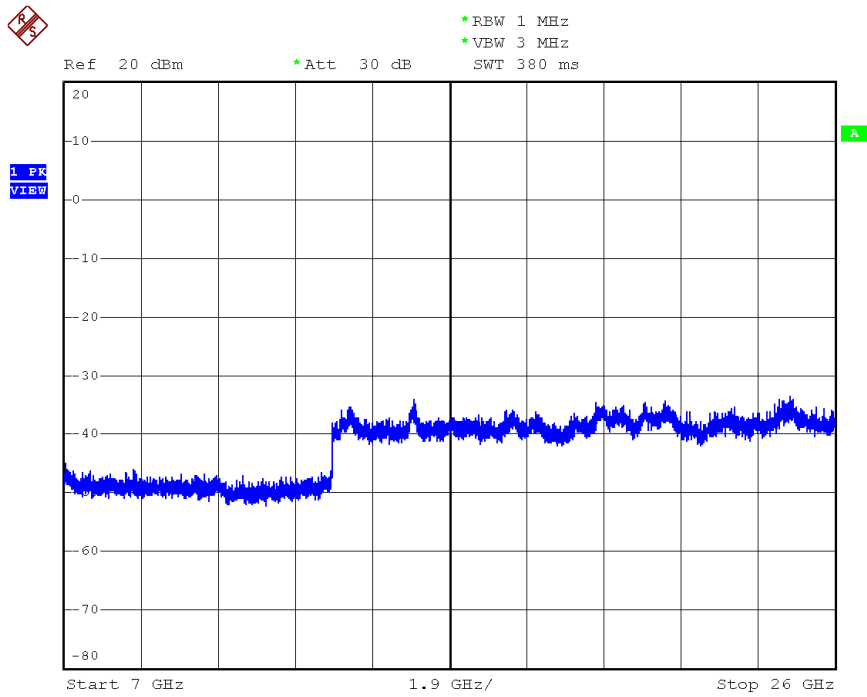

Date: 3.JUN.2014 14:42:06

8. Power line conducted emission

Test result: Pass

8.1 Limit

Frequency of Emission (MHz)	Conducted Limit (dBuV)	
	QP	AV
0.15-0.5	66 to 56*	56 to 46 *
0.5-5	56	46
5-30	60	50

* Decreases with the logarithm of the frequency.

8.2 Test configuration

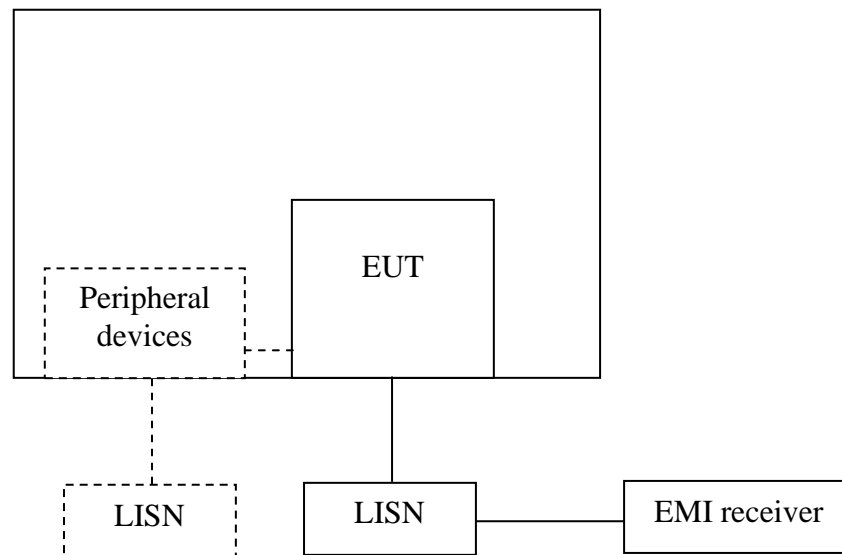

For table top equipment, wooden support is 0.8m height table

For floor standing equipment, wooden support is 0.1m height rack.

8.3 Test procedure and test set up

The EUT are connected to the main power through a line impedance stabilization network (LISN). This provides a $50\Omega/50\mu\text{H}$ coupling impedance for the measuring equipment. The peripheral devices are also connected to the main power through a LISN that provides a $50\Omega/50\mu\text{H}$ coupling impedance with 50Ω termination.

Both sides (Line and Neutral) of AC line are checked for maximum conducted interference. In order to find the maximum emission, the relative positions of equipment and all of the interface cables must be changed according to ANSI C63.4 on conducted measurement. The bandwidth of the test receiver is set at 9 kHz.

8.4 Test protocol

Temperature : 25 °C
Relative Humidity : 55 %

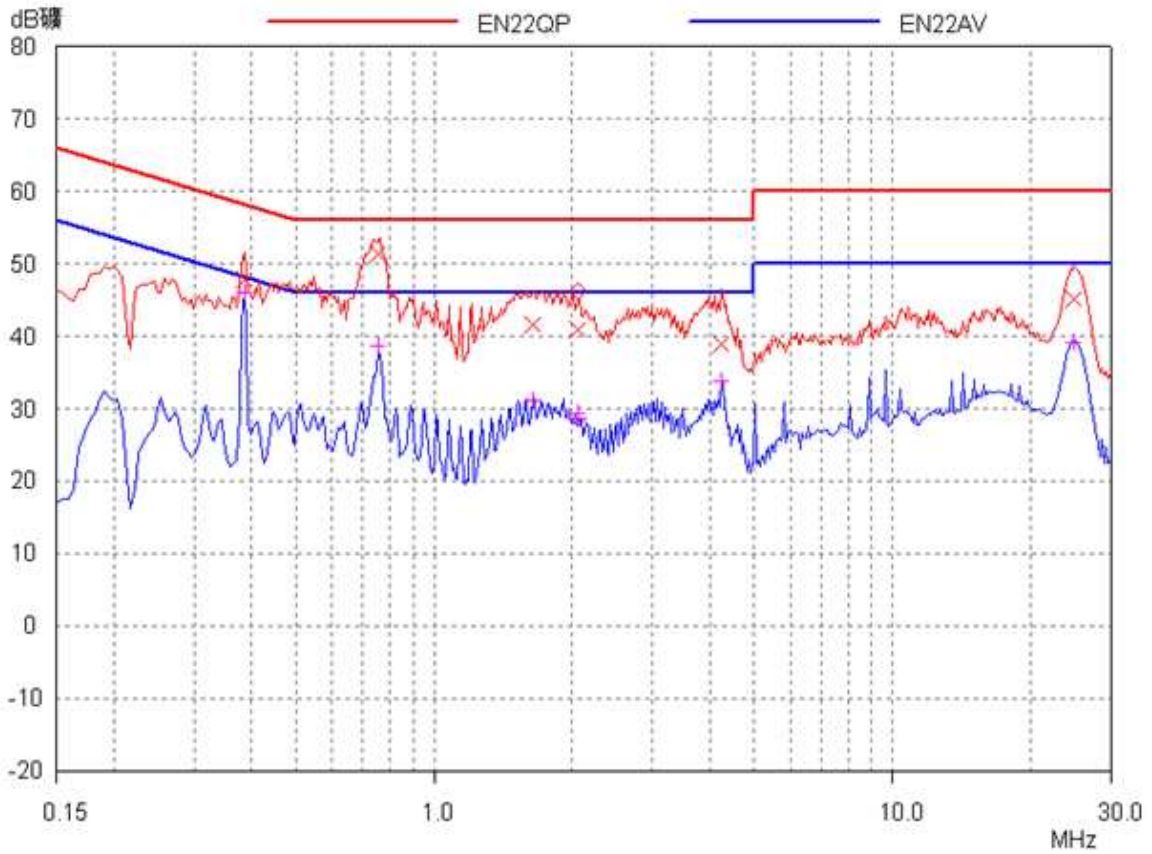

Frequency	Correct Factor (dB)	Corrected Reading (dBuV)		Limit (dBuV)		Margin (dB)	
		QP	AV	QP	AV	QP	AV
0.38 (N)	3.00	47.82	46.13	58.19	48.19	10.37	2.06
0.76 (N)	3.00	51.46	38.78	56.00	46.00	4.54	7.22
1.64 (L)	3.00	41.58	31.15	56.00	46.00	14.42	14.85
2.07 (N)	3.00	40.95	29.32	56.00	46.00	15.05	16.68
4.22 (L)	3.00	38.94	33.72	56.00	46.00	17.06	12.28
24.74 (L)	3.00	45.19	39.06	60.00	50.00	14.81	10.94

Remark: 1. Correction Factor (dB) = LISN Factor (dB) + Cable Loss (dB).
2. Margin (dB) = Limit - Corrected Reading.