



**FCC 47 CFR PART 15 SUBPART E**

**TEST REPORT**

**For**

**802.11ac Dual Band In Ceiling WAP**

**Model: DA1104**

**Trade Name: legrand**

*Issued to*

**Pass & Seymour, Inc. d/b/a Legrand**  
**301 Fulling Mill Road Suite G Middletown Pennsylvania 17057 United States**

*Issued by*

**Compliance Certification Services Inc.**  
**No.11, Wugong 6th Rd., Wugu Dist.,**  
**New Taipei City 24891, Taiwan. (R.O.C.)**  
**<http://www.ccsrf.com>**  
**[service@ccsrf.com](mailto:service@ccsrf.com)**  
**Issued Date: December 22, 2014**



---

*Note: This report shall not be reproduced except in full, without the written approval of Compliance Certification Services Inc. This document may be altered or revised by Compliance Certification Services Inc. personnel only, and shall be noted in the revision section of the document.*



**Revision History**

Rev.	Issue Date	Revisions	Effect Page	Revised By
00	December 22, 2014	Initial Issue	ALL	Doris Chu



## **TABLE OF CONTENTS**

<b>1. TEST RESULT CERTIFICATION.....</b>	<b>4</b>
<b>2. EUT DESCRIPTION .....</b>	<b>5</b>
<b>3. TEST METHODOLOGY .....</b>	<b>7</b>
3.1 EUT CONFIGURATION .....	7
3.2 EUT EXERCISE .....	7
3.3 GENERAL TEST PROCEDURES.....	7
3.4 FCC PART 15.205 RESTRICTED BANDS OF OPERATIONS.....	8
3.5 DESCRIPTION OF TEST MODES.....	9
<b>4. INSTRUMENT CALIBRATION.....</b>	<b>10</b>
4.1 MEASURING INSTRUMENT CALIBRATION .....	10
4.2 MEASUREMENT EQUIPMENT USED.....	10
4.3 MEASUREMENT UNCERTAINTY.....	11
<b>5. FACILITIES AND ACCREDITATIONS .....</b>	<b>12</b>
5.1 FACILITIES .....	12
5.2 EQUIPMENT .....	12
5.3 TABLE OF ACCREDITATIONS AND LISTINGS .....	13
<b>6. SETUP OF EQUIPMENT UNDER TEST .....</b>	<b>14</b>
6.1 SETUP CONFIGURATION OF EUT .....	14
6.2 SUPPORT EQUIPMENT .....	14
<b>7. FCC PART 15 REQUIREMENTS.....</b>	<b>15</b>
7.1 26 DB EMISSION BANDWIDTH .....	15
7.2 PEAK POWER .....	33
7.3 AVERAGE POWER.....	36
7.4 BAND EDGES MEASUREMENT .....	39
7.5 PEAK POWER SPECTRAL DENSITY .....	48
7.6 RADIATED UNDESIRABLE EMISSION.....	66
7.7 POWERLINE CONDUCTED EMISSIONS .....	89
7.8 FREQUENCY STABILITY .....	92
<b>APPENDIX I PHOTOGRAPHS OF TEST SETUP .....</b>	<b>108</b>



# 1. TEST RESULT CERTIFICATION

**Applicant:** Pass & Seymour, Inc. d/b/a Legrand  
 301 Fulling Mill Road Suite G Middletown Pennsylvania 17057  
 United States

**Equipment Under Test:** 802.11ac Dual Band In Ceiling WAP

**Trade Name:** legrand

**Model:** DA1104

**Date of Test:** October 6~10, 2014

APPLICABLE STANDARDS	
STANDARD	TEST RESULT
FCC 47 CFR Part 15 Subpart E	No non-compliance noted

### We hereby certify that:

Compliance Certification Services Inc. tested the above equipment. The test data, data evaluation, test procedures, and equipment configurations shown in this report were made in accordance with the procedures given in ANSI C63.4: 2009 and the energy emitted by the sample EUT tested as described in this report is in compliance with conducted and radiated emission limits of FCC Rules Part 15.407.

The test results of this report relate only to the tested sample identified in this report.

Approved by:

Reviewed by:

---

Miller Lee  
 Section Manager  
 Compliance Certification Services Inc.

---

Angel Cheng  
 Section Manager  
 Compliance Certification Services Inc.



## 2. EUT DESCRIPTION

<b>Product</b>	802.11ac Dual Band In Ceiling WAP			
<b>Trade Name</b>	legrand			
<b>Model Number</b>	DA1104			
<b>Model Discrepancy</b>	N/A			
<b>Received Date</b>	October 21, 2014			
<b>Power Supply</b>	Powered from POE. (DC 48V, 0.5A)			
<b>Operating Frequency Range &amp; Number of Channels</b>	UNII Band I	IEEE 802.11a	5180 – 5240	4 Channels
		IEEE 802.11n HT 20 mode	5180 – 5240	4 Channels
		IEEE 802.11n HT 40 mode	5190 – 5230	2 Channels
		IEEE 802.11 ac80 mode	5210	1 Channels
	UNII Band IV	IEEE 802.11a	5745 – 5825	5 Channels
		IEEE 802.11n HT 20 mode	5745 – 5825	5 Channels
		IEEE 802.11n HT 40 mode	5755 – 5795	2 Channels
		IEEE 802.11 ac80 mode	5775	1 Channels
<b>Transmit Power</b>	IEEE 802.11a mode / 5180 ~ 5240MHz: 11.56dBm IEEE 802.11n HT 20 mode / 5180 ~ 5240MHz: 15.35dBm IEEE 802.11n HT 40 mode / 5190 ~ 5230MHz: 15.26dBm IEEE 802.11 ac80 mode / 5210MHz: 15.17dBm IEEE 802.11a mode / 5745 ~ 5825MHz: 11.62dBm IEEE 802.11n HT 20 mode / 5745 ~ 5825MHz: 15.24dBm IEEE 802.11n HT 40 mode / 5755 ~ 5795MHz: 15.19dBm IEEE 802.11 ac80 mode / 5775MHz: 15.18dBm			
<b>Modulation Technique</b>	OFDM (QPSK, BPSK, 16-QAM, 64-QAM)			
<b>Transmit Data Rate</b>	IEEE 802.11a mode: 54, 48, 36, 24, 18, 12, 9, 6 Mbps IEEE 802.11n HT 20 mode: OFDM (6.50, 13.00, 19.50, 26.00, 39.00, 52.00, 58.50, 65.00, 78.00, 104.0, 117.0, 130.0, 156.0, 175.5, 195.0Mbps) IEEE 802.11n HT 40 mode: OFDM (13.50, 27.00, 40.50, 54.00, 81.00, 108.0, 121.5, 135.0, 162.0, 216.0, 243.0, 270.0, 324.0, 364.5, 405.0Mbps) IEEE 802.11 ac80 mode: OFDM (29.3, 58.5, 87.8, 117, 175.5, 234, 263.3, 292.5, 351, 390, 468, 526.5, 585, 702, 780 Mbps)			
<b>Antenna Designation</b>	PCB Antenna / Gain: 4dBi MIMO: Total ANT=4+10*LOG(2)=7dBi			



**Operation Frequency**

UNLICENSED NATIONAL INFORMATION INFRASTRUCTURE (U-NII)	
CHANNEL	MHz
36	5180
38	5190
40	5200
46	5230
48	5240
52	5260
54	5270
62	5310
64	5350
149	5745
153	5765
157	5785
161	5805
165	5825

**Remark:**

1. The sample selected for test was engineering sample that approximated to production product and was provided by manufacturer.
2. This submittal(s) (test report) is intended for FCC ID: **YV8-DA1104** filing to comply with Section 15.407 of the FCC Part 15, Subpart E Rules.



### **3. TEST METHODOLOGY**

Both conducted and radiated testing was performed according to the procedures in ANSI C63.4. Radiated testing was performed at an antenna to EUT distance 3 meters.

#### **3.1 EUT CONFIGURATION**

The EUT configuration for testing is installed for RF field strength measurement to meet the Commissions requirement, and is operated in a manner intended to generate the maximum emission in a continuous normal application.

#### **3.2 EUT EXERCISE**

The EUT is operated in the engineering mode to fix the Tx frequency for the purposes of measurement.

According to its specifications, the EUT must comply with the requirements of Section 15.407 under the FCC Rules Part 15 Subpart E.

#### **3.3 GENERAL TEST PROCEDURES**

##### **Conducted Emissions**

The EUT is placed on the turntable, which is positioned at 0.8 m above the ground plane. According to the requirements in Section 13.1.4.1 of ANSI C63.4, the conducted emission from the EUT is measured in the frequency range between 0.15 MHz and 30MHz, using the CISPR Quasi-Peak detector mode.

##### **Radiated Emissions**

The EUT is placed on the turntable, which is 0.8 m above the ground plane. The turntable is then rotated for 360 degrees to determine the proper orientation for the maximum emission level. The EUT is set 3m away from the receiving antenna, which is varied from 1m to 4m to find out the highest emission level. And, each emission is to be maximized by changing the horizontal and vertical polarization of the receiving antenna. In order to find out the maximum emissions, exploratory radiated emission measurements were made according to the requirements in Section 13.1.4.1 of ANSI C63.4.



### 3.4 FCC PART 15.205 RESTRICTED BANDS OF OPERATIONS

(a) Except as shown in paragraph (d) of this section, only spurious emissions are permitted in any of the frequency bands listed below:

MHz	MHz	MHz	GHz
0.090 - 0.110	16.42 - 16.423	399.9 - 410	4.5 - 5.15
<sup>1</sup> 0.495 - 0.505	16.69475 - 16.69525	608 - 614	5.35 - 5.46
2.1735 - 2.1905	16.80425 - 16.80475	960 - 1240	7.25 - 7.75
4.125 - 4.128	25.5 - 25.67	1300 - 1427	8.025 - 8.5
4.17725 - 4.17775	37.5 - 38.25	1435 - 1626.5	9.0 - 9.2
4.20725 - 4.20775	73 - 74.6	1645.5 - 1646.5	9.3 - 9.5
6.215 - 6.218	74.8 - 75.2	1660 - 1710	10.6 - 12.7
6.26775 - 6.26825	108 - 121.94	1718.8 - 1722.2	13.25 - 13.4
6.31175 - 6.31225	123 - 138	2200 - 2300	14.47 - 14.5
8.291 - 8.294	149.9 - 150.05	2310 - 2390	15.35 - 16.2
8.362 - 8.366	156.52475 -	2483.5 - 2500	17.7 - 21.4
8.37625 - 8.38675	156.52525	2655 - 2900	22.01 - 23.12
8.41425 - 8.41475	156.7 - 156.9	3260 - 3267	23.6 - 24.0
12.29 - 12.293	162.0125 - 167.17	3332 - 3339	31.2 - 31.8
12.51975 - 12.52025	167.72 - 173.2	3345.8 - 3358	36.43 - 36.5
12.57675 - 12.57725	240 - 285	3600 - 4400	( <sup>2</sup> )
13.36 - 13.41	322 - 335.4		

<sup>1</sup> Until February 1, 1999, this restricted band shall be 0.490-0.510 MHz.

<sup>2</sup> Above 38.6

(b) Except as provided in paragraphs (d) and (e), the field strength of emissions appearing within these frequency bands shall not exceed the limits shown in Section 15.209. At frequencies equal to or less than 1000 MHz, compliance with the limits in Section 15.209 shall be demonstrated using measurement instrumentation employing a CISPR quasi-peak detector. Above 1000 MHz, compliance with the emission limits in Section 15.209 shall be demonstrated based on the average value of the measured emissions. The provisions in Section 15.35 apply to these measurements.





### 3.5 DESCRIPTION OF TEST MODES

The EUT (model: DA1104) had been tested under operating condition.

The EUT is a 2x2 configuration spatial MIMO (2Tx & 2Rx) without beam forming function that operate in double TX chains and double RX chains. The 2x2 configuration is implemented with two outside TX & RX chains (Chain 0 and 1).

Software used to control the EUT for staying in continuous transmitting mode was programmed.

After verification, all tests were carried out with the worst case test modes as shown below except radiated spurious emission below 1GHz and power line conducted emissions below 30MHz, which worst case was in normal link mode only.

#### **UNII Band I:**

##### **IEEE 802.11a mode / 5180 ~ 5240MHz:**

Channel Low (5180MHz), Channel Mid (5220MHz) and Channel High (5240MHz) with 6Mbps data rate were chosen for full testing.

##### **IEEE 802.11n HT 20 mode / 5180 ~ 5240MHz:**

Channel Low (5180MHz), Channel Mid (5220MHz) and Channel High (5240MHz) with 6Mbps data rate were chosen for full testing.

##### **IEEE 802.11n HT 40 mode / 5190 ~ 5230MHz:**

Channel Low (5190MHz) and Channel High (5230MHz) with 13.5Mbps data rate were chosen for full testing.

##### **IEEE 802.11n ac80 MHz Channel for 5210MHz:**

Channel Low(5210MHz) with 29.3Mbps data rate were chosen for full testing.

#### **UNII Band VI:**

##### **IEEE 802.11a mode:**

Channel Low (5745MHz), Channel Mid (5785MHz) and Channel High (5825MHz) with 6Mbps data rate were chosen for full testing.

##### **IEEE 802.11n HT 20 mode:**

Channel Low(5745MHz), Channel Mid(5785MHz) and Channel High(5825MHz) with 6.5Mbps data rate were chosen for full testing.

##### **IEEE 802.11n HT 40 mode:**

Channel Low(5755MHz) and Channel High(5795MHz) with 13.5Mbps data rate were chosen for full testing.

##### **IEEE 802.11 ac80 mode:**

Channel Low(5775MHz) with 29.3Mbps data rate were chosen for full testing.



## 4. INSTRUMENT CALIBRATION

### 4.1 MEASURING INSTRUMENT CALIBRATION

The measuring equipment, which was utilized in performing the tests documented herein, has been calibrated in accordance with the manufacturer's recommendations for utilizing calibration equipment, which is traceable to recognized national standards.

### 4.2 MEASUREMENT EQUIPMENT USED

#### Equipment Used for Emissions Measurement

*Remark: Each piece of equipment is scheduled for calibration once a year and Loop Antenna is scheduled for calibration once three years.*

Conducted Emissions Test Site				
Name of Equipment	Manufacturer	Model	Serial Number	Calibration Due
Spectrum Analyzer	Agilent	E4446A	MY43360131	03/26/2015
Power Meter	Anritsu	ML2495A	1012009	06/03/2015
Power Sensor	Anritsu	MA2411A	0917072	06/03/2015

3M Chamber Test Site				
Name of Equipment	Manufacturer	Model	Serial Number	Calibration Due
Spectrum Analyzer	Agilent	E4446A	US42510268	11/04/2015
EMI Test Receiver	R&S	ESCI	100064	02/27/2015
Pre-Amplifier	Mini-Circuits	ZFL-1000LN	SF350700823	01/11/2015
Pre-Amplifier	MITEQ	AFS44-00102650-42-10P-44	1415367	11/17/2015
Bilog Antenna	Sunol Sciences	JB3	A030105	09/30/2015
Horn Antenna	EMCO	3117	00055165	02/12/2015
Horn Antenna	EMCO	3116	2487	10/08/2015
Loop Antenna	EMCO	6502	8905/2356	06/08/2015
Turn Table	CCS	CC-T-1F	N/A	N.C.R
Antenna Tower	CCS	CC-A-1F	N/A	N.C.R
Controller	CCS	CC-C-1F	N/A	N.C.R
Site NSA	CCS	N/A	N/A	12/20/2015
Test S/W	EZ-EMC (CCS-3A1RE)			

Conducted Emission room # A				
Name of Equipment	Manufacturer	Model	Serial Number	Calibration Due
EMI Test Receiver	R&S	ESI	101203	09/11/2015
LISN	R&S	ESH3-Z5	848773/014	12/04/2015
Coaxial Cable	Commate	CFD300-NL	NA	12/04/2015
Test S/W	CCS-3A1-CE			



### 4.3 MEASUREMENT UNCERTAINTY

PARAMETER	UNCERTAINTY
Powerline Conducted Emission	+/- 1.2159
3M Semi Anechoic Chamber / <200M	+/- 4.0138
3M Semi Anechoic Chamber / 200M~1000M	+/- 3.9483
3M Semi Anechoic Chamber / 1G~8G	+/- 2.5975
3M Semi Anechoic Chamber / 8G~18G	+/- 2.6112
3M Semi Anechoic Chamber / 18G~26G	+/- 2.7389
3M Semi Anechoic Chamber / 26G~40G	+/- 2.9683

**Remark:** This uncertainty represents an expanded uncertainty expressed at approximately the 95% confidence level using a coverage factor of  $k=2$ .



## 5. FACILITIES AND ACCREDITATIONS

### 5.1 FACILITIES

All measurement facilities used to collect the measurement data are located at

No.199, Chunghsen Road, Hsintien City, Taipei Hsien, Taiwan, R.O.C.

Tel: 886-2-2217-0894 / Fax: 886-2-2217-1029

No.11, Wugong 6th Rd., Wugu Dist., New Taipei City 24891, Taiwan. (R.O.C.)

Tel: 886-2-2299-9720 / Fax: 886-2-2298-4045

No.81-1, Lane 210, Bade 2nd Rd., Lujhu Township, Taoyuan County 33841, TAIWAN, R.O.C.

Tel: 886-3-324-0332 / Fax: 886-3-324-5235

The sites are constructed in conformance with the requirements of ANSI C63.7, ANSI C63.4 and CISPR Publication 22.

### 5.2 EQUIPMENT

Radiated emissions are measured with one or more of the following types of linearly polarized antennas: tuned dipole, biconical, log periodic, bi-log, and/or ridged waveguide, horn. Spectrum analyzers with pre-selectors and quasi-peak detectors are used to perform radiated measurements.



Conducted emissions are measured with Line Impedance Stabilization Networks and EMI Test Receivers.

Calibrated wideband preamplifiers, coaxial cables, and coaxial attenuators are also used for making measurements.

All receiving equipment conforms to CISPR Publication 16-1, "Radio Interference Measuring Apparatus and Measurement Methods."



### 5.3 TABLE OF ACCREDITATIONS AND LISTINGS

Country	Agency	Scope of Accreditation	Logo
USA	FCC	3M Semi Anechoic Chamber (FCC MRA: TW1039) to perform FCC Part 15 measurements	 FCC MRA: TW1039
Taiwan	TAF	LP0002, RTTE01, FCC Method-47 CFR Part 15 Subpart C, D, E, RSS-210, RSS-310 IDA TS SRD, AS/NZS 4268, AS/NZS 4771, TS 12.1 & 12.2, ETSI EN 300 440-1, ETSI EN 300 440-2, ETSI EN 300 328, ETSI EN 300 220-1, ETSI EN 300 220-2, ETSI EN 301 893, ETSI EN 301 489-1/3/7/17 FCC OET Bulletin 65 + Supplement C, EN 50360, EN 50361, EN 50371, RSS 102, EN 50383, EN 50385, EN 50392, IEC 62209, CNS 14958-1, CNS 14959 FCC Method -47 CFR Part 15 Subpart B IEC / EN 61000-3-2, IEC / EN 61000-3-3, IEC / EN 61000-4-2/3/4/5/6/8/11	
Canada	Industry Canada	3M Semi Anechoic Chamber (IC 2324G-1 / IC 2324G-2) to perform	

\* No part of this report may be used to claim or imply product endorsement by A2LA or any agency of the US Government.



## 6. SETUP OF EQUIPMENT UNDER TEST

### 6.1 SETUP CONFIGURATION OF EUT

See test photographs attached in Appendix II for the actual connections between EUT and support equipment.

### 6.2 SUPPORT EQUIPMENT

No	Equipment	Brand	Model	Series No.	FCC ID	Data Cable	Power Cord
1	Notebook PC	TOSHIBA	Satellite M840	N/A	PPD-AR5B225	N/A	AC I/P: Unshielded, 1.8m DC O/P: Unshielded, 1.8m with a core

**Remark:**

1. All the equipment/cables were placed in the worst-case configuration to maximize the emission during the test.
2. Grounding was established in accordance with the manufacturer's requirements and conditions for the intended use.



## 7. FCC PART 15 REQUIREMENTS

### 7.1 26 DB EMISSION BANDWIDTH

#### LIMIT

According to §15.303(c), for purposes of this subpart the emission bandwidth shall be determined by measuring the width of the signal between two points, one below the carrier center frequency and one above the carrier center frequency, that are 26 dB down relative to the maximum level of the modulated carrier. Compliance with the emissions limits is based on the use of measurement instrumentation employing a peak detector function with an instrument resolutions bandwidth approximately equal to 1.0 percent of the emission bandwidth of the device under measurement.

#### Test Configuration

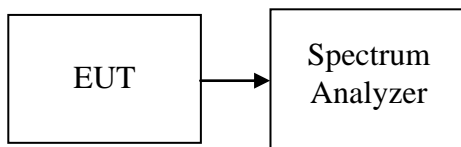

#### TEST PROCEDURE

1. Place the EUT on the table and set it in the transmitting mode.
2. Remove the antenna from the EUT and then connect a low-loss RF cable from the antenna port to the spectrum analyzer.
3. Set the spectrum analyzer as  $RBW = 1\%EBW$ ,  $VBW = RBW$ ,  $Span = 50MHz$ , and  $Sweep = auto$ .  
Or Set the spectrum analyzer as  $RBW > 1\%EBW$ ,  $VBW > RBW$ ,  $Span > 26dB$  bandwidth, and  $Sweep = auto$ .
4. Mark the peak frequency and  $-26dB$  (upper and lower) frequency.
5. Repeat until all the rest channels were investigated.



### **TEST RESULTS**

*No non-compliance noted*

#### **Test Data**

##### **Test mode: IEEE 802.11a mode / 5180 ~ 5240MHz**

Channel	Frequency (MHz)	Bandwidth (MHz)
Low	5180	21.946
Mid	5220	21.752
High	5240	21.527

##### **Test mode: IEEE 802.11n HT 20 mode / 5180 ~ 5240MHz / Chain 0**

Channel	Frequency (MHz)	Bandwidth (MHz)
Low	5180	22.298
Mid	5220	22.139
High	5240	22.337

##### **Test mode: IEEE 802.11n HT 20 mode / 5180 ~ 5240MHz / Chain 1**

Channel	Frequency (MHz)	Bandwidth (MHz)
Low	5180	21.503
Mid	5220	21.680
High	5240	21.502

##### **Test mode: IEEE 802.11n HT 40 mode / 5190 ~ 5230MHz / Chain 0**

Channel	Frequency (MHz)	Bandwidth (MHz)
Low	5190	44.415
High	5230	43.820

##### **Test mode: IEEE 802.11n HT 40 mode/ 5190 ~ 5230MHz / Chain 1**

Channel	Frequency (MHz)	Bandwidth (MHz)
Low	5190	43.315
High	5230	43.214

##### **Test mode: IEEE 802.11 ac80 mode / 5210MHz / Chain 0**

Channel	Frequency (MHz)	Bandwidth (B) (MHz)
Mid	5210	82.774

##### **Test mode: IEEE 802.11 ac80 mode/ 5210MHz / Chain 1**

Channel	Frequency (MHz)	Bandwidth (B) (MHz)
Mid	5210	82.061





**Test mode: IEEE 802.11a mode / 5745 ~ 5825MHz**

Channel	Frequency (MHz)	Bandwidth (MHz)
Low	5745	16.574
Mid	5785	16.570
High	5825	16.573

**Test mode: IEEE 802.11n HT 20 mode / 5745 ~ 5825MHz / Chain 0**

Channel	Frequency (MHz)	Bandwidth (MHz)
Low	5745	17.784
Mid	5785	17.762
High	5825	17.709

**Test mode: IEEE 802.11n HT 20 mode / 5745 ~ 5825MHz / Chain 1**

Channel	Frequency (MHz)	Bandwidth (MHz)
Low	5745	17.699
Mid	5785	17.675
High	5825	17.697

**Test mode: IEEE 802.11n HT 40 mode / 5755 ~ 5795MHz / Chain 0**

Channel	Frequency (MHz)	Bandwidth (MHz)
Low	5755	36.196
High	5795	36.683

**Test mode: IEEE 802.11n HT 40 mode/ 5755 ~ 5795MHz / Chain 1**

Channel	Frequency (MHz)	Bandwidth (MHz)
Low	5755	36.022
High	5795	36.089

**Test mode: IEEE 802.11 ac80 mode / 5775MHz / Chain 0**

Channel	Frequency (MHz)	Bandwidth (B) (MHz)
Mid	5290	75.593

**Test mode: IEEE 802.11 ac80 mode/ 5775MHz / Chain 1**

Channel	Frequency (MHz)	Bandwidth (B) (MHz)
Mid	5290	75.529



**Test Plot**

**IEEE 802.11a mode / 5180 ~ 5240MHz**

**CH Low**

Agilent

R T

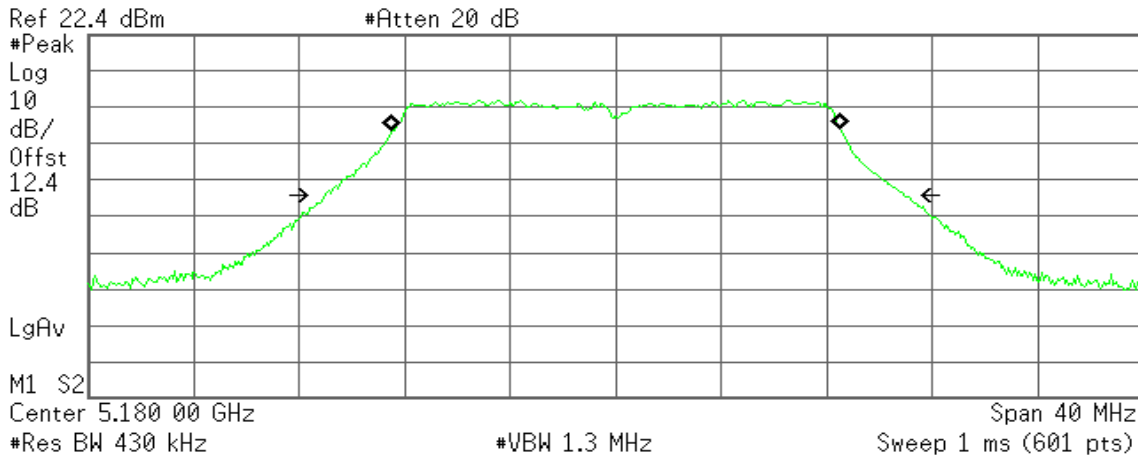

**Occupied Bandwidth**

**17.0602 MHz**

**Occ BW % Pwr 99.00 %**  
**x dB -26.00 dB**

**Transmit Freq Error 11.063 kHz**  
**x dB Bandwidth 21.946 MHz**

**CH Mid**

Agilent

R T

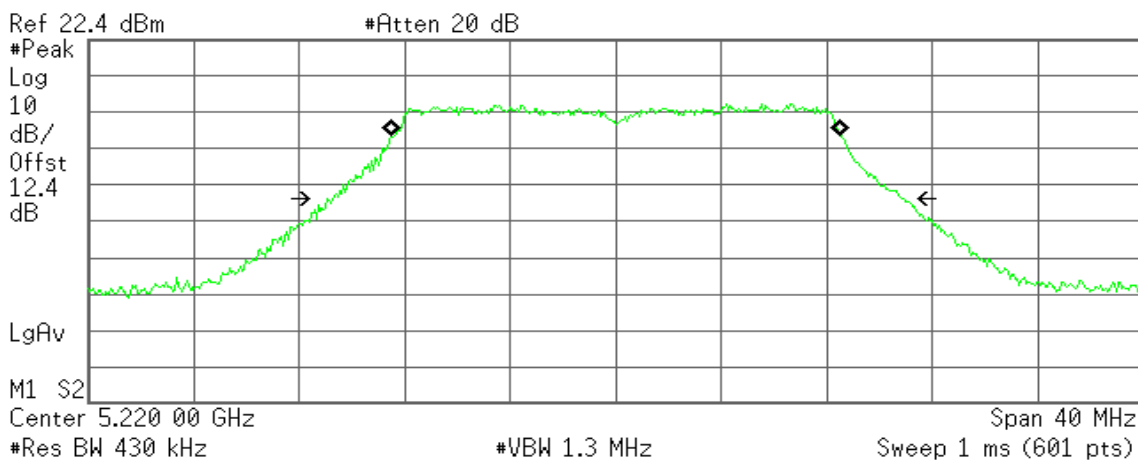

**Occupied Bandwidth**

**17.0782 MHz**

**Occ BW % Pwr 99.00 %**  
**x dB -26.00 dB**

**Transmit Freq Error 23.451 kHz**  
**x dB Bandwidth 21.752 MHz**



### CH High

Agilent

R T

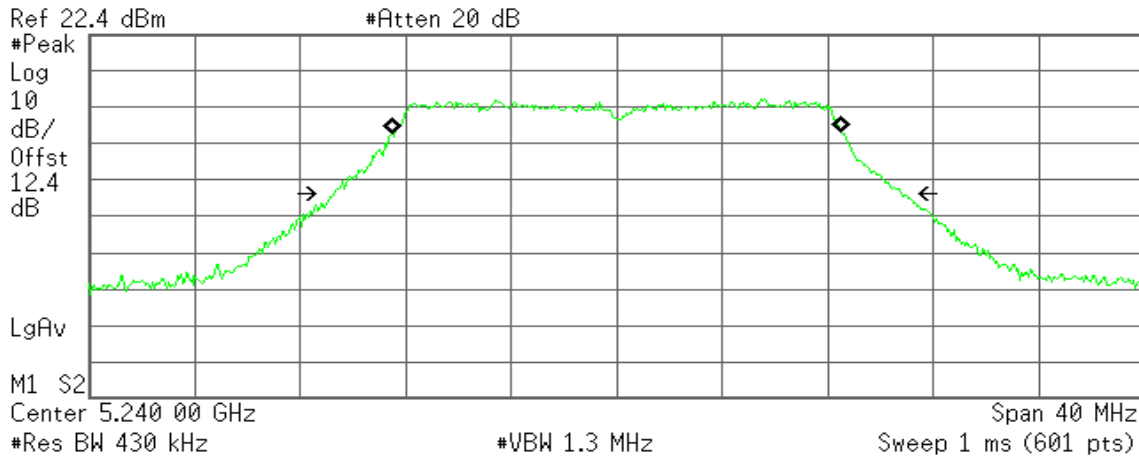

Occupied Bandwidth  
17.0733 MHz

Occ BW % Pwr 99.00 %  
x dB -26.00 dB

Transmit Freq Error 16.551 kHz  
x dB Bandwidth 21.527 MHz

### IEEE 802.11n HT 20 mode / 5180 ~ 5240MHz / Chain 0

### CH Low

Agilent

R T

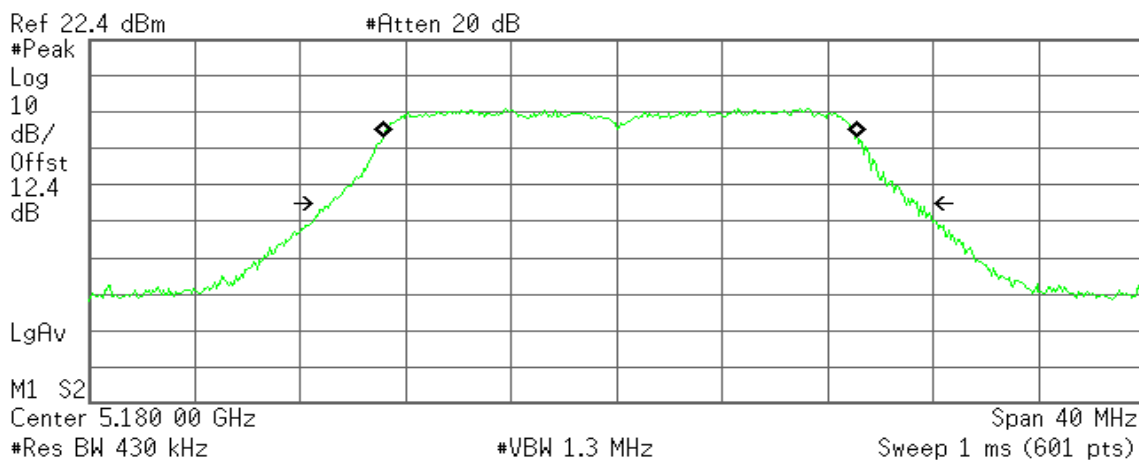

Occupied Bandwidth  
18.0245 MHz

Occ BW % Pwr 99.00 %  
x dB -26.00 dB

Transmit Freq Error 143.511 kHz  
x dB Bandwidth 22.298 MHz



### CH Mid

Agilent

R T

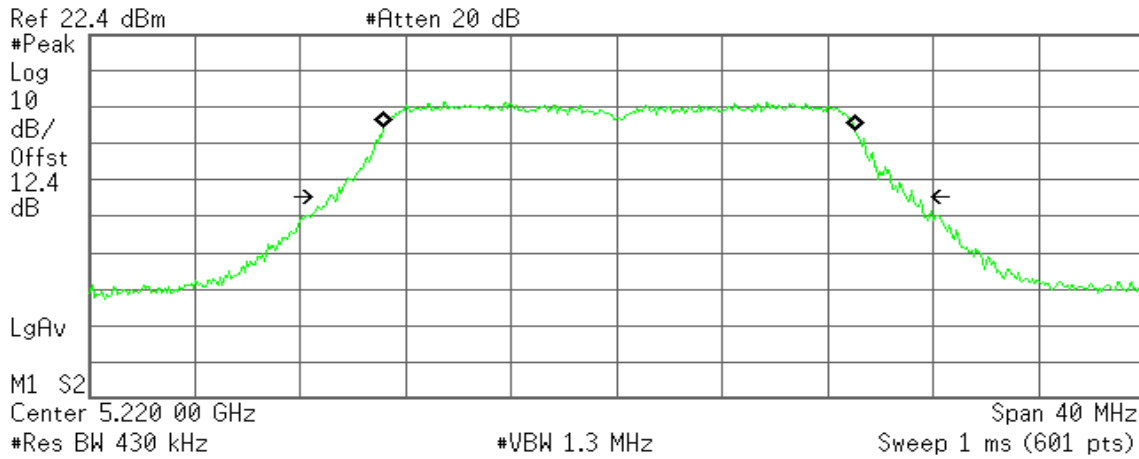

Occupied Bandwidth  
17.9282 MHz

Occ BW % Pwr 99.00 %  
x dB -26.00 dB

Transmit Freq Error 107.168 kHz  
x dB Bandwidth 22.139 MHz

### CH High

Agilent

R T

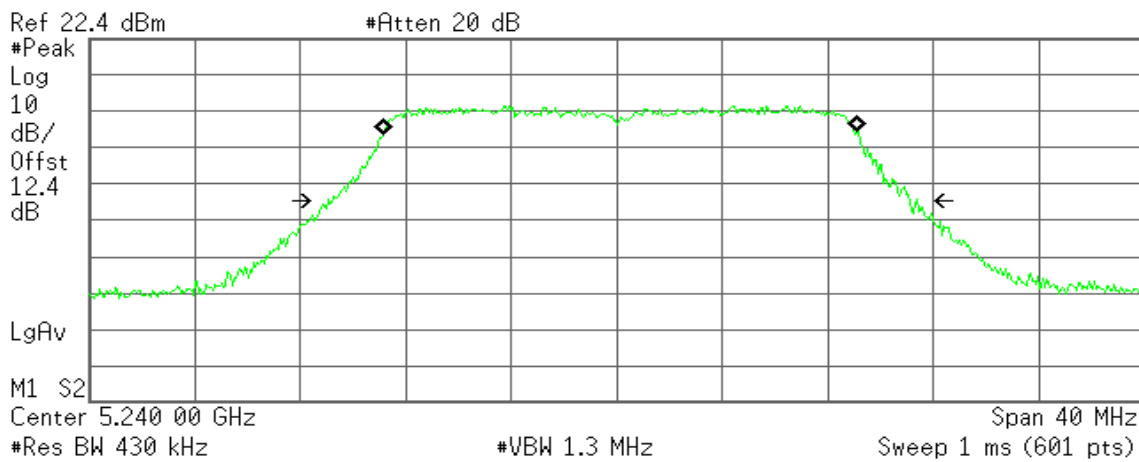

Occupied Bandwidth  
18.0082 MHz

Occ BW % Pwr 99.00 %  
x dB -26.00 dB

Transmit Freq Error 146.174 kHz  
x dB Bandwidth 22.337 MHz



**IEEE 802.11n HT 20 mode / 5180 ~ 5240MHz / Chain 1**

**CH Low**

Agilent

R T

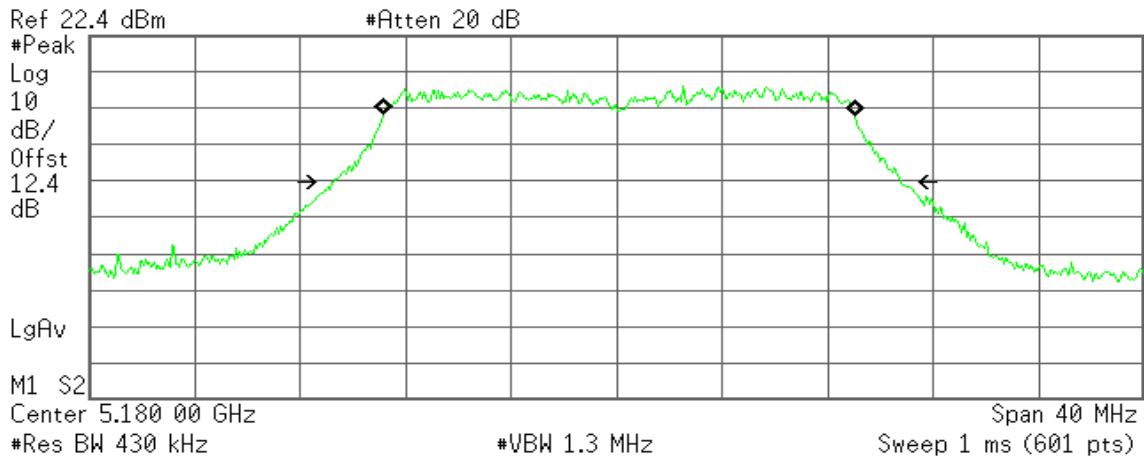

**Occupied Bandwidth**  
17.9013 MHz

**Occ BW % Pwr** 99.00 %  
**x dB** -26.00 dB

**Transmit Freq Error** 91.513 kHz  
**x dB Bandwidth** 21.503 MHz

**CH Mid**

Agilent

R T

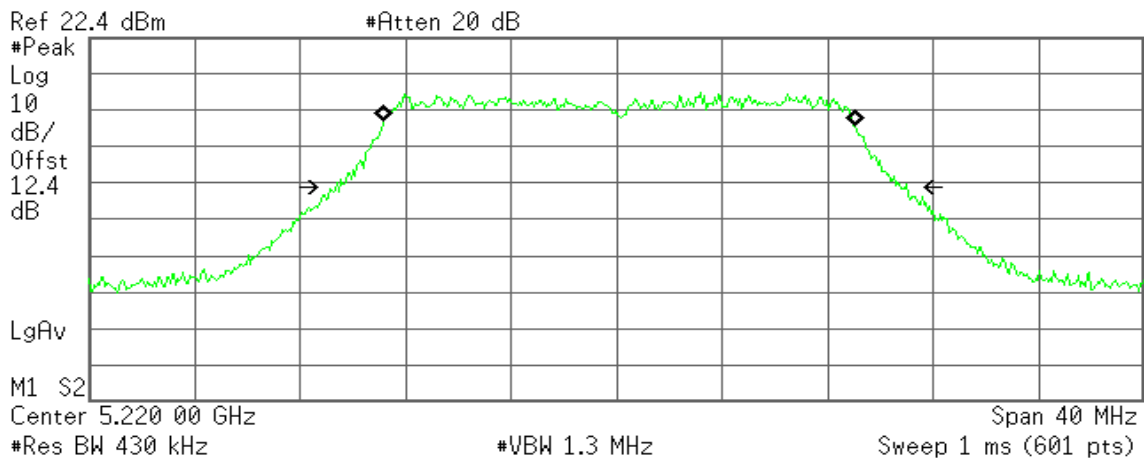

**Occupied Bandwidth**  
17.8895 MHz

**Occ BW % Pwr** 99.00 %  
**x dB** -26.00 dB

**Transmit Freq Error** 94.487 kHz  
**x dB Bandwidth** 21.680 MHz



### CH High

Agilent

R T

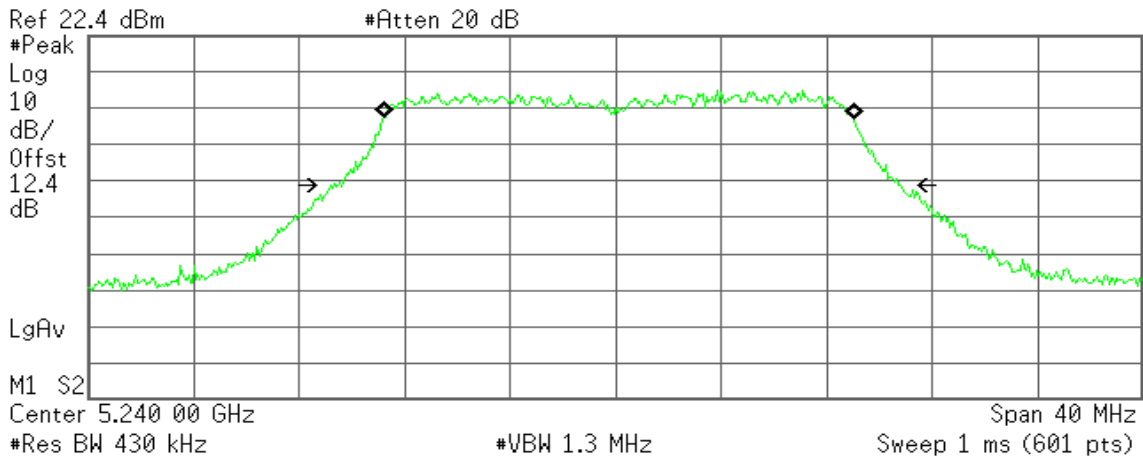

**Occupied Bandwidth**  
17.8613 MHz

**Occ BW % Pwr** 99.00 %  
**x dB** -26.00 dB

**Transmit Freq Error** 110.086 kHz  
**x dB Bandwidth** 21.502 MHz

### IEEE 802.11n HT 40 mode / 5190 ~ 5230MHz / Chain 0

#### CH Low

Agilent

R T

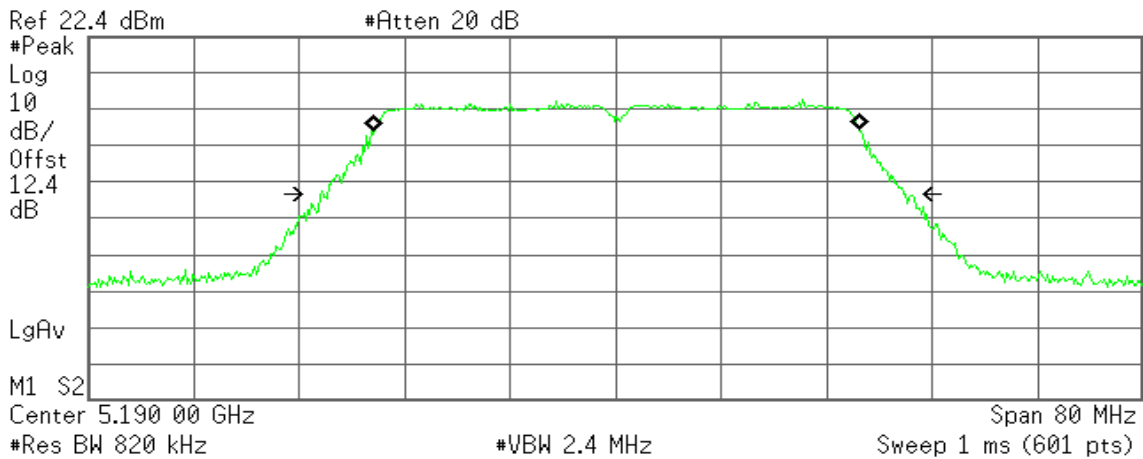

**Occupied Bandwidth**  
36.8020 MHz

**Occ BW % Pwr** 99.00 %  
**x dB** -26.00 dB

**Transmit Freq Error** 66.784 kHz  
**x dB Bandwidth** 44.415 MHz



### CH High

Agilent

R T

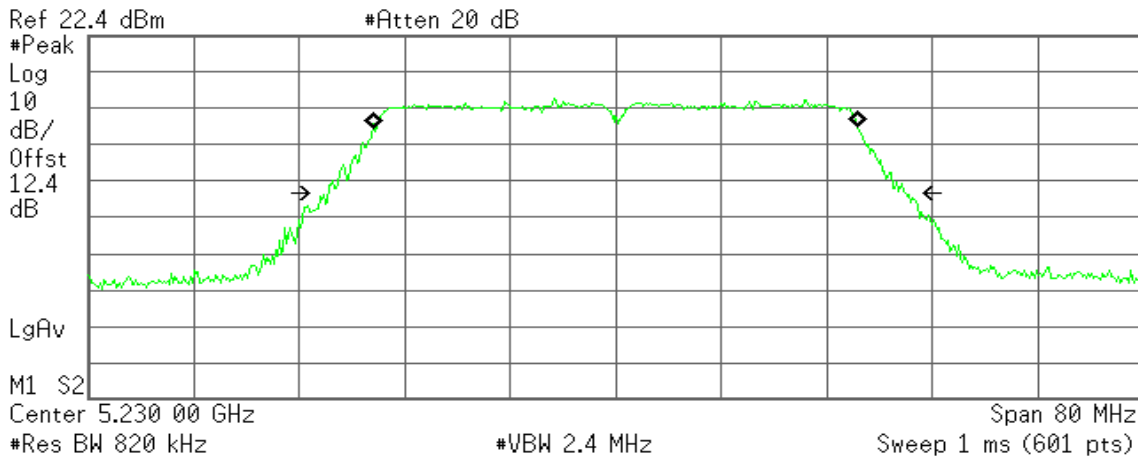

Occupied Bandwidth  
36.7230 MHz

Occ BW % Pwr 99.00 %  
x dB -26.00 dB

Transmit Freq Error 27.768 kHz  
x dB Bandwidth 43.820 MHz

### IEEE 802.11n HT 40 mode / 5190 ~ 5230MHz / Chain 1

#### CH Low

Agilent

R T

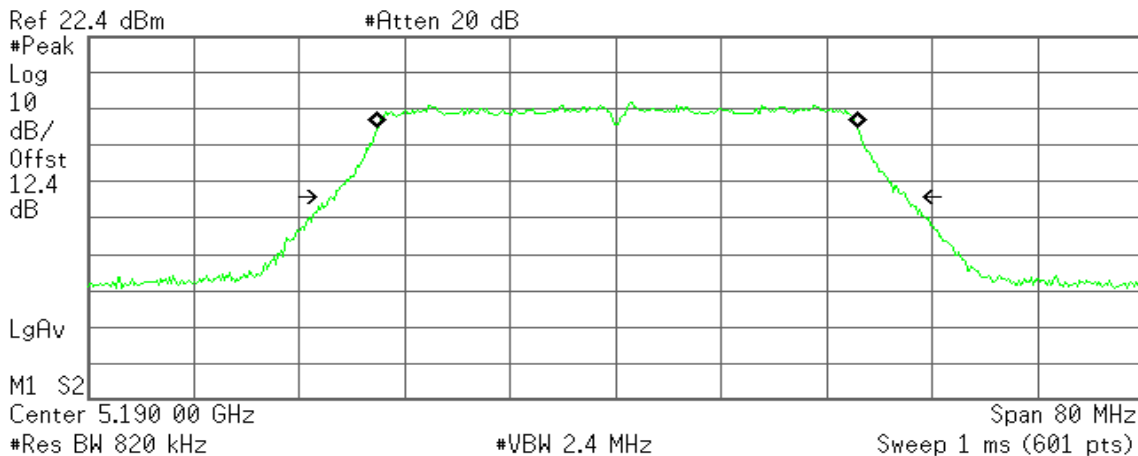

Occupied Bandwidth  
36.5022 MHz

Occ BW % Pwr 99.00 %  
x dB -26.00 dB

Transmit Freq Error 134.224 kHz  
x dB Bandwidth 43.315 MHz



### CH High

Agilent

R T

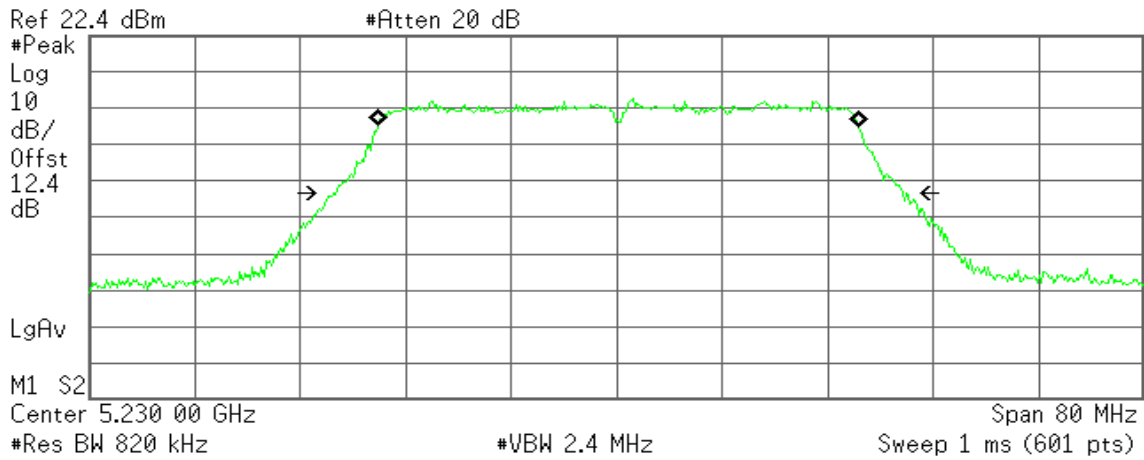

Occupied Bandwidth  
36.5131 MHz

Occ BW % Pwr 99.00 %  
x dB -26.00 dB

Transmit Freq Error 121.806 kHz  
x dB Bandwidth 43.214 MHz

### IEEE 802.11 ac80 mode / 5210MHz / Chain 0

Agilent

R T

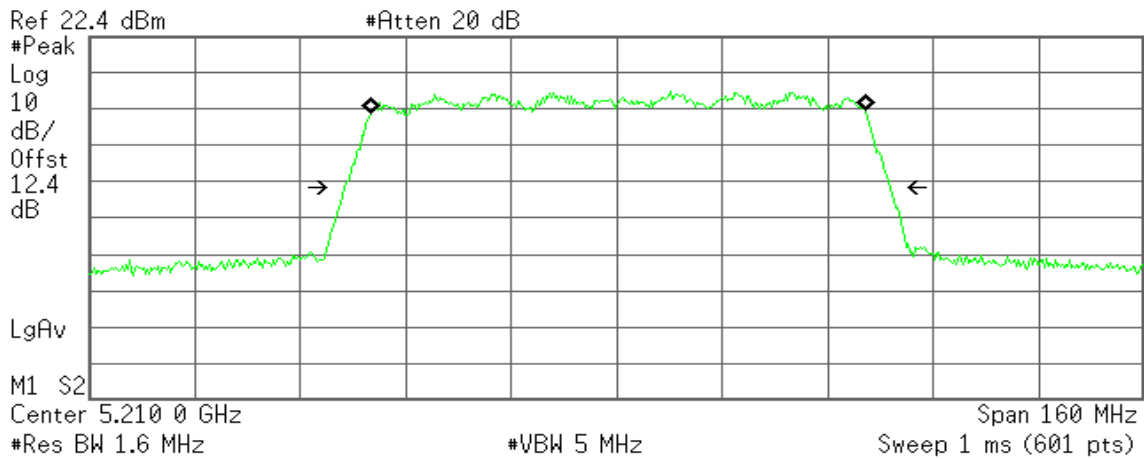

Occupied Bandwidth  
75.2190 MHz

Occ BW % Pwr 99.00 %  
x dB -26.00 dB

Transmit Freq Error 197.864 kHz  
x dB Bandwidth 82.774 MHz





**IEEE 802.11 ac80 mode / 5210MHz / Chain 1**

Agilent

R T

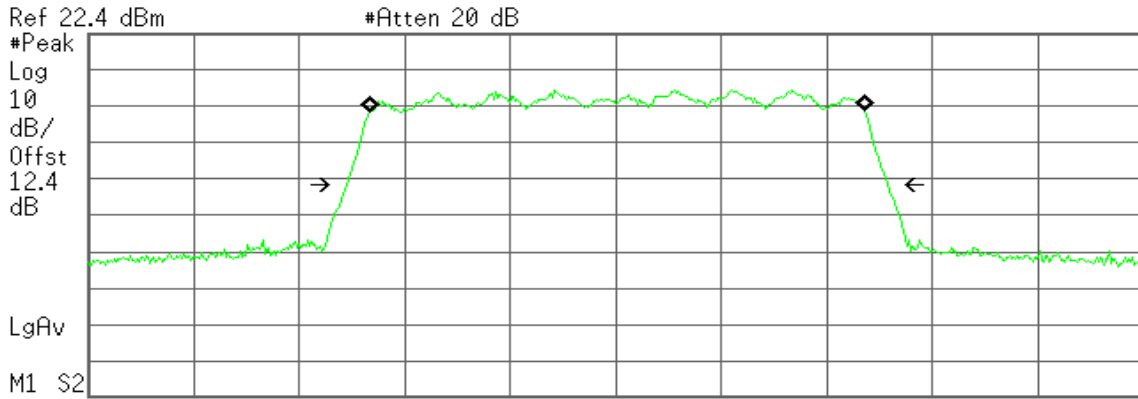

Ref 22.4 dBm #Atten 20 dB  
 #Peak Log  
 10 dB/ Offst 12.4 dB  
 LgAv  
 M1 S2  
 Center 5.210 00 GHz Span 160 MHz  
 #Res BW 1.6 MHz #VBW 5 MHz Sweep 1 ms (601 pts)

**Occupied Bandwidth**  
**75.1951 MHz**

**Occ BW % Pwr** 99.00 %  
**x dB** -26.00 dB

**Transmit Freq Error** 218.140 kHz  
**x dB Bandwidth** 82.061 MHz

**IEEE 802.11a mode / 5745 ~ 5825MHz**

CH Low

Agilent

R T

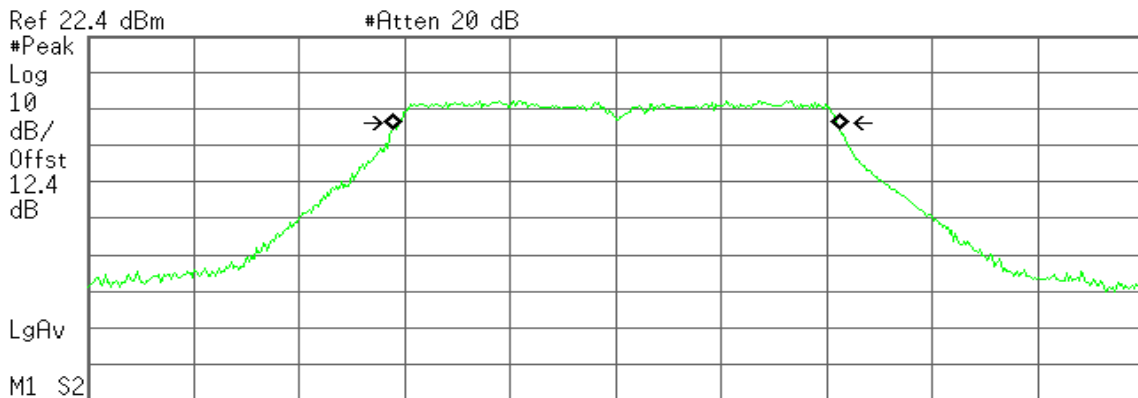

Ref 22.4 dBm #Atten 20 dB  
 #Peak Log  
 10 dB/ Offst 12.4 dB  
 LgAv  
 M1 S2  
 Center 5.745 00 GHz Span 40 MHz  
 #Res BW 430 kHz #VBW 1.3 MHz Sweep 1 ms (601 pts)

**Occupied Bandwidth**  
**17.0313 MHz**

**Occ BW % Pwr** 99.00 %  
**x dB** -6.00 dB

**Transmit Freq Error** 20.309 kHz  
**x dB Bandwidth** 16.574 MHz



### CH Mid

Agilent

R T

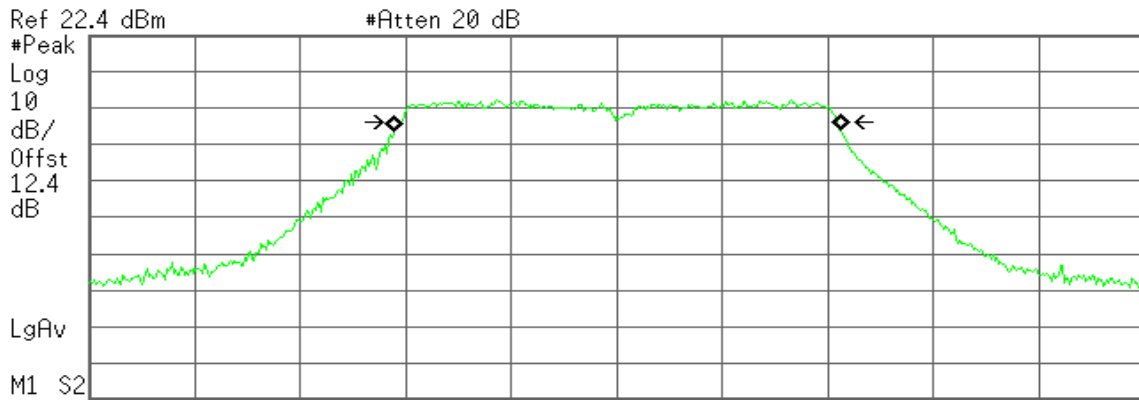

Center 5.785 00 GHz Span 40 MHz  
 #Res BW 430 kHz #VBW 1.3 MHz Sweep 1 ms (601 pts)

**Occupied Bandwidth**  
**16.9840 MHz**

**Occ BW % Pwr** 99.00 %  
**x dB** -6.00 dB

**Transmit Freq Error** 33.145 kHz  
**x dB Bandwidth** 16.570 MHz

### CH High

Agilent

R T

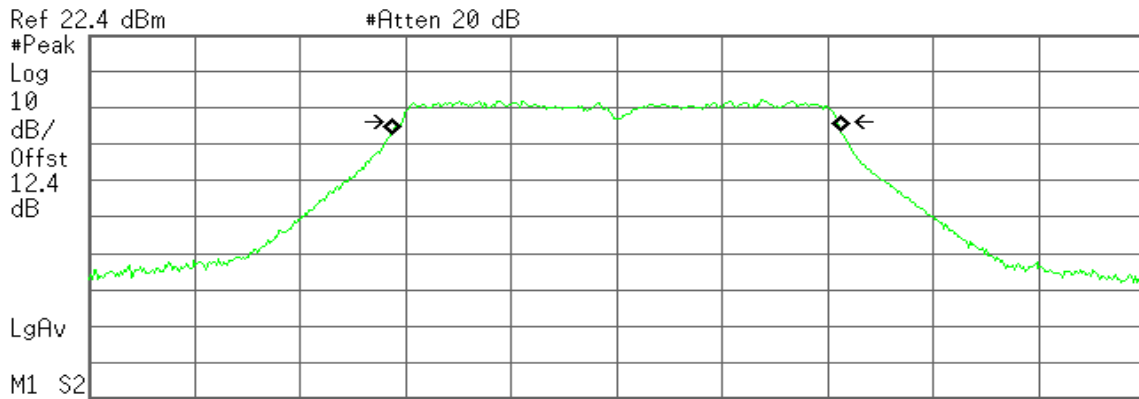

Center 5.825 00 GHz Span 40 MHz  
 #Res BW 430 kHz #VBW 1.3 MHz Sweep 1 ms (601 pts)

**Occupied Bandwidth**  
**17.0735 MHz**

**Occ BW % Pwr** 99.00 %  
**x dB** -6.00 dB

**Transmit Freq Error** -21.572 kHz  
**x dB Bandwidth** 16.573 MHz



**IEEE 802.11n HT 20 mode / 5745 ~ 5825MHz / Chain 0**

**CH Low**

Agilent

R T

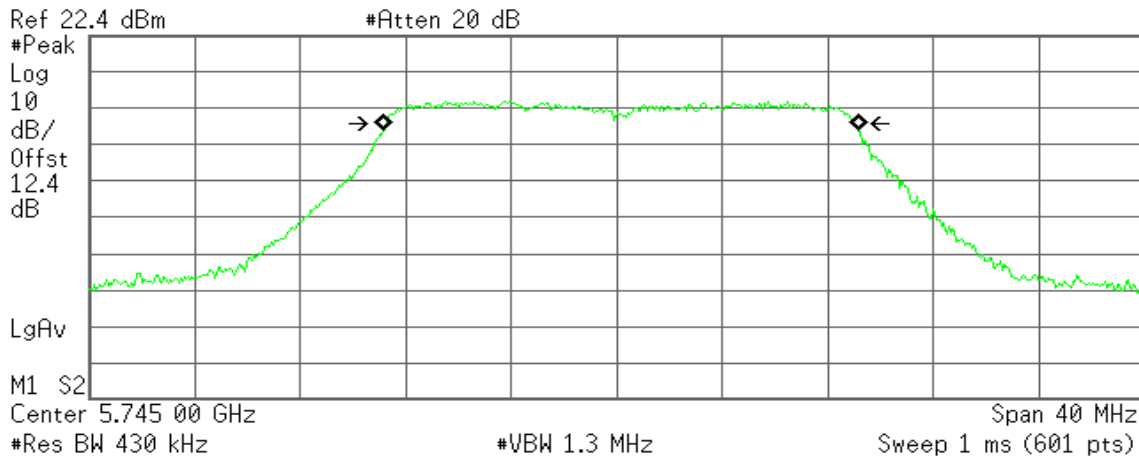

**Occupied Bandwidth**

**18.0332 MHz**

**Occ BW % Pwr** 99.00 %  
**x dB** -6.00 dB

**Transmit Freq Error** 156.520 kHz  
**x dB Bandwidth** 17.784 MHz

**CH Mid**

Agilent

R T

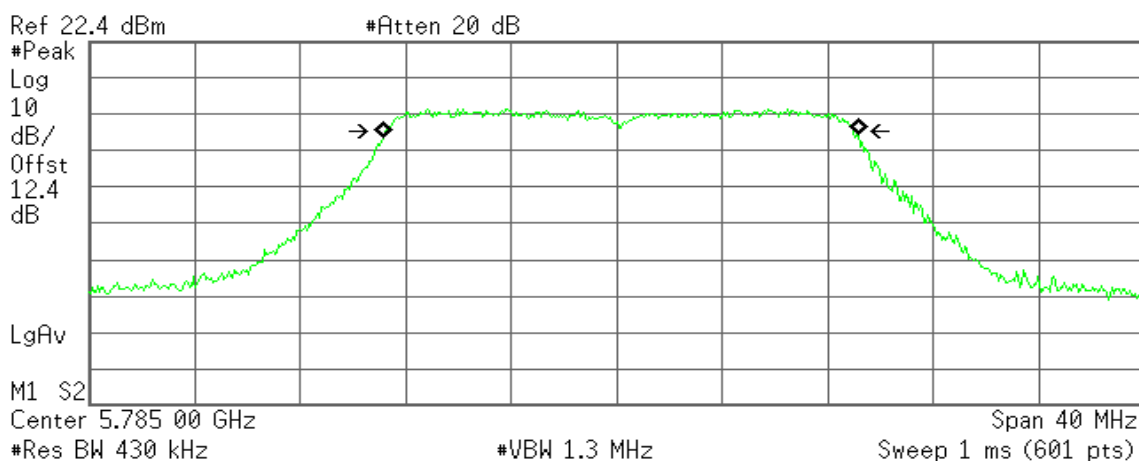

**Occupied Bandwidth**

**18.0420 MHz**

**Occ BW % Pwr** 99.00 %  
**x dB** -6.00 dB

**Transmit Freq Error** 160.073 kHz  
**x dB Bandwidth** 17.762 MHz



### CH High

Agilent

R T

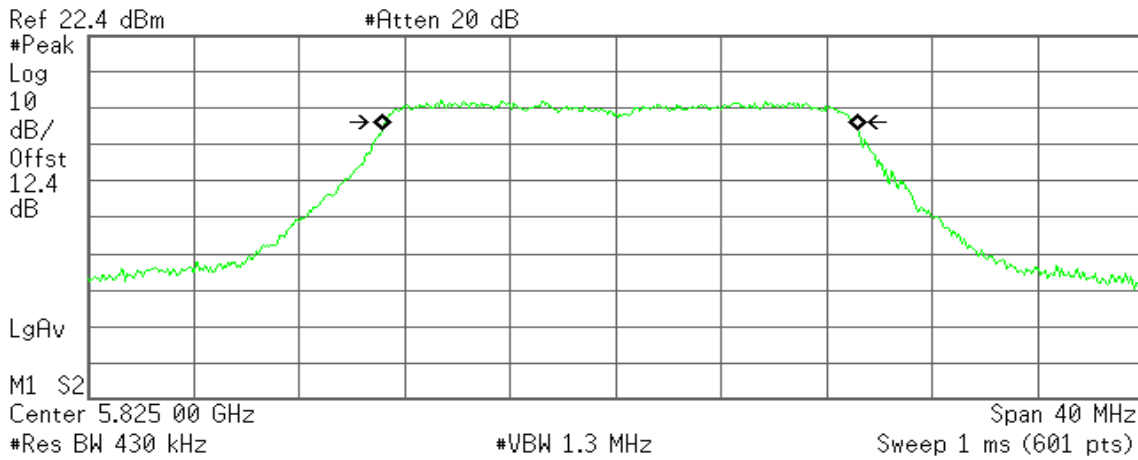

Occupied Bandwidth  
18.0491 MHz

Occ BW % Pwr 99.00 %  
x dB -6.00 dB

Transmit Freq Error 153.909 kHz  
x dB Bandwidth 17.709 MHz

### IEEE 802.11n HT 20 mode / 5745 ~ 5825MHz / Chain 1

### CH Low

Agilent

R T

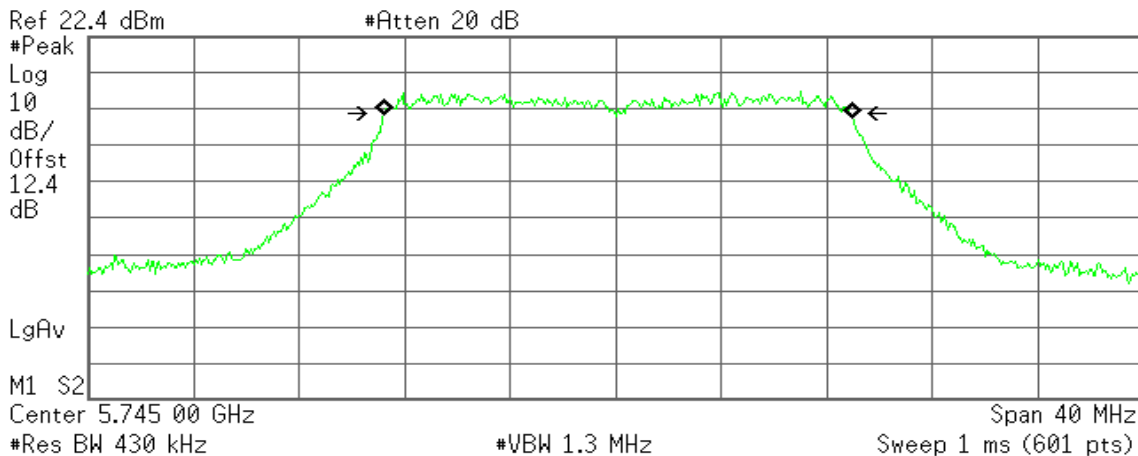

Occupied Bandwidth  
17.8420 MHz

Occ BW % Pwr 99.00 %  
x dB -6.00 dB

Transmit Freq Error 100.889 kHz  
x dB Bandwidth 17.699 MHz



### CH Mid

Agilent

R T

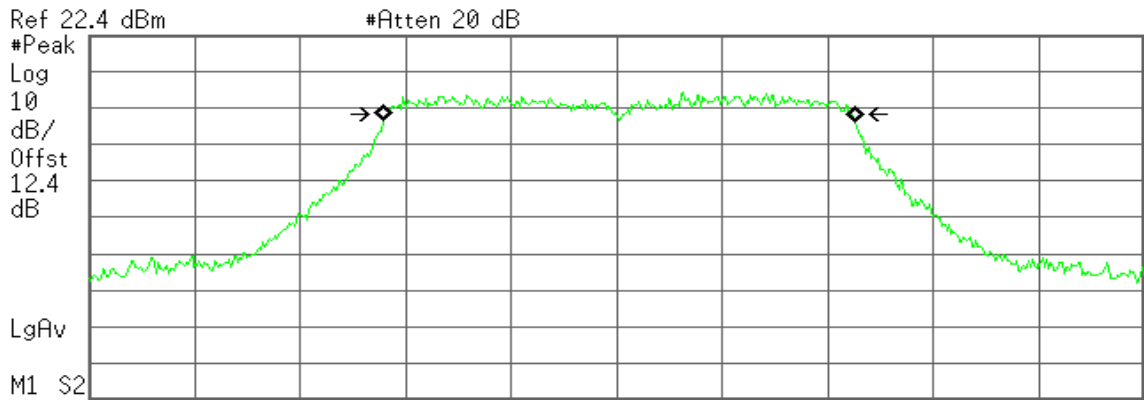

Occupied Bandwidth  
17.8969 MHz

Occ BW % Pwr 99.00 %  
x dB -6.00 dB

Transmit Freq Error 97.356 kHz  
x dB Bandwidth 17.675 MHz

### CH High

Agilent

R T

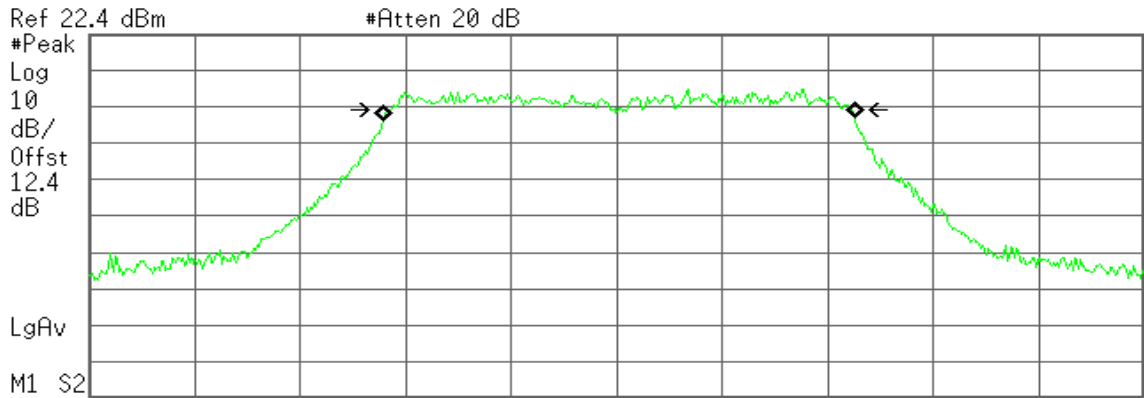

Occupied Bandwidth  
17.8901 MHz

Occ BW % Pwr 99.00 %  
x dB -6.00 dB

Transmit Freq Error 100.307 kHz  
x dB Bandwidth 17.697 MHz



**IEEE 802.11n HT 40 mode / 5755 ~ 5795MHz / Chain 0**

**CH Low**

Agilent

R T

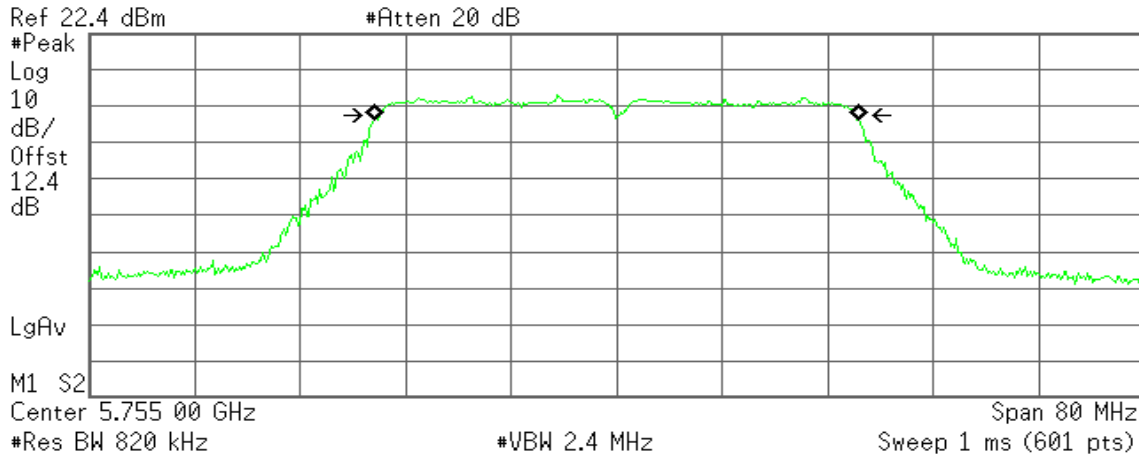

**Occupied Bandwidth**  
36.8819 MHz

**Occ BW % Pwr** 99.00 %  
**x dB** -6.00 dB

**Transmit Freq Error** -23.884 kHz  
**x dB Bandwidth** 36.196 MHz

**CH High**

Agilent

R T

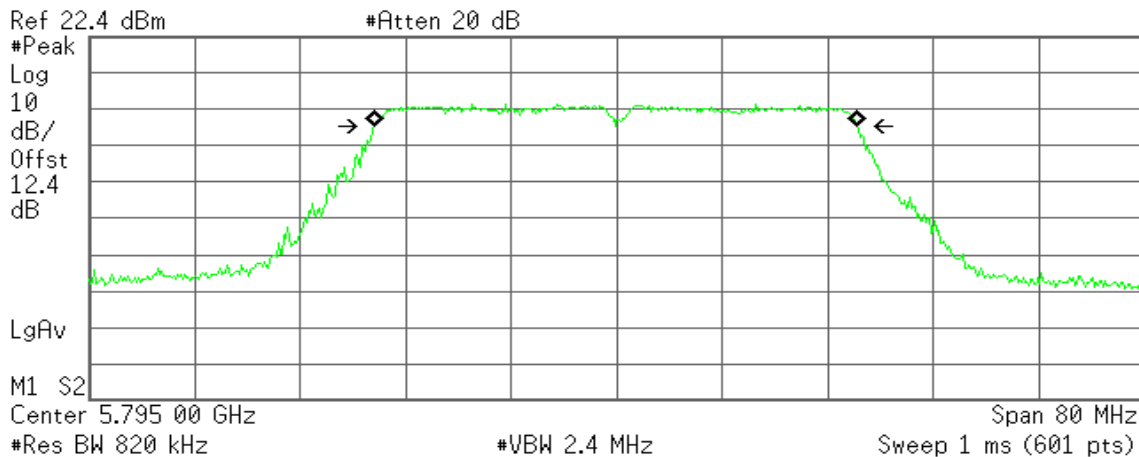

**Occupied Bandwidth**  
36.7353 MHz

**Occ BW % Pwr** 99.00 %  
**x dB** -6.00 dB

**Transmit Freq Error** -63.376 kHz  
**x dB Bandwidth** 36.683 MHz



**IEEE 802.11n HT 40 mode / 5755 ~ 5795MHz / Chain 1**

**CH Low**

Agilent

R T

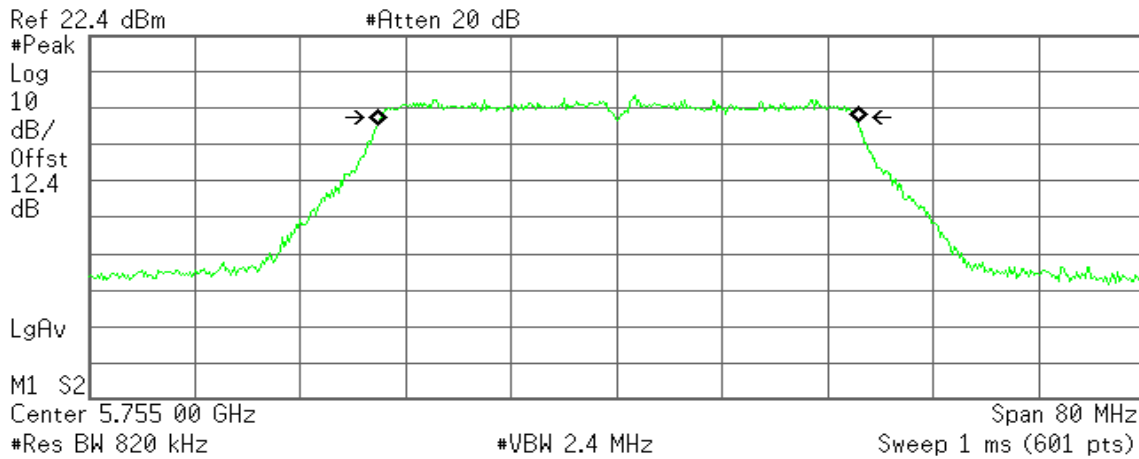

**Occupied Bandwidth**  
36.5087 MHz

**Occ BW % Pwr** 99.00 %  
**x dB** -6.00 dB

**Transmit Freq Error** 80.388 kHz  
**x dB Bandwidth** 36.022 MHz

**CH High**

Agilent

R T

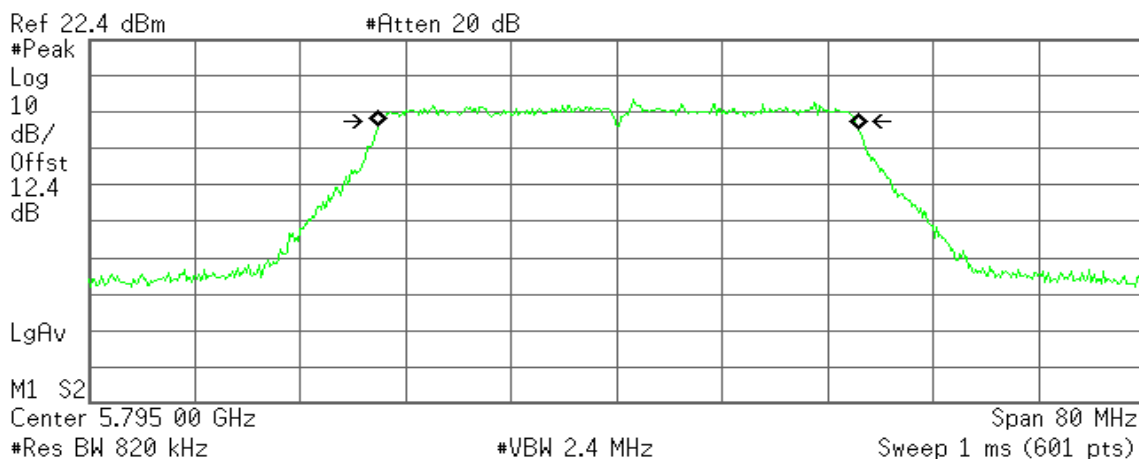

**Occupied Bandwidth**  
36.4994 MHz

**Occ BW % Pwr** 99.00 %  
**x dB** -6.00 dB

**Transmit Freq Error** 121.059 kHz  
**x dB Bandwidth** 36.089 MHz



**IEEE 802.11 ac80 mode / 5775MHz / Chain 0**

Agilent

R T

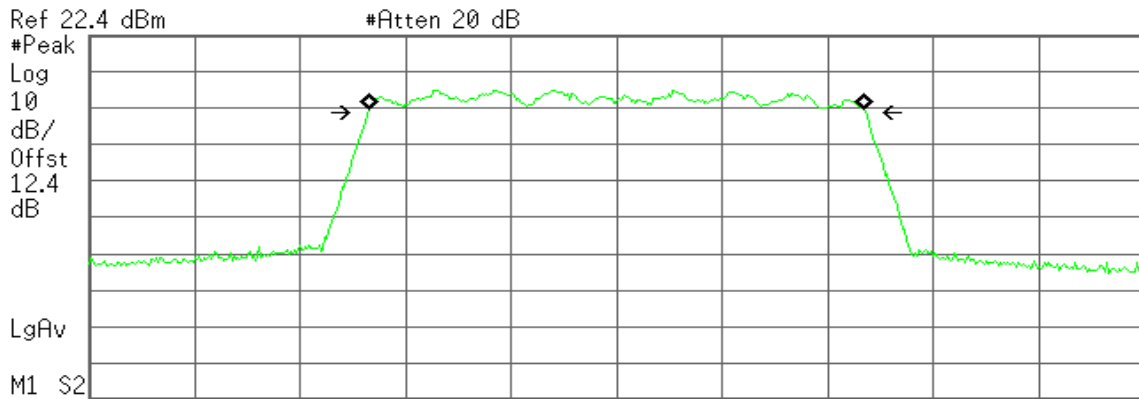

Center 5.775 0 GHz Span 160 MHz  
 #Res BW 1.6 MHz #VBW 5 MHz Sweep 1 ms (601 pts)

**Occupied Bandwidth**  
**75.2324 MHz**

**Occ BW % Pwr** 99.00 %  
**x dB** -6.00 dB

**Transmit Freq Error** 36.673 kHz  
**x dB Bandwidth** 75.593 MHz

**IEEE 802.11 ac80 mode / 5775MHz / Chain 1**

Agilent

R T

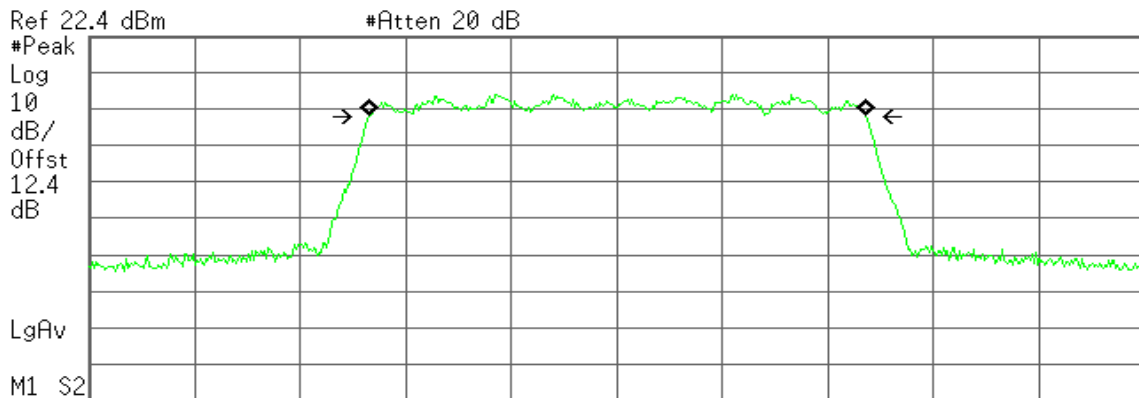

Center 5.775 0 GHz Span 160 MHz  
 #Res BW 1.6 MHz #VBW 5 MHz Sweep 1 ms (601 pts)

**Occupied Bandwidth**  
**75.2920 MHz**

**Occ BW % Pwr** 99.00 %  
**x dB** -6.00 dB

**Transmit Freq Error** 120.377 kHz  
**x dB Bandwidth** 75.529 MHz





## 7.2 PEAK POWER

### Test Configuration

The EUT was connected to a spectrum analyzer through a 50Ω RF cable.

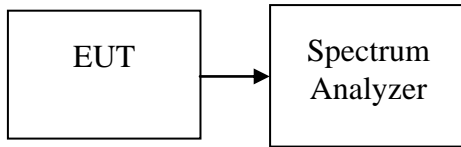

### TEST PROCEDURE

Set span to encompass the entire emission bandwidth (EBW) of the signal.

Set RBW = 1 MHz / Set VBW = 3 MHz.

Use sample detector mode if bin width (i.e., span/number of points in spectrum display) < 0.5 RBW. Otherwise use peak detector mode. Use a video trigger with the trigger level set to enable triggering only on full power pulses. Transmitter must operate at full control power for entire sweep of every sweep. If the device transmits continuously, with no off intervals or reduced power intervals, the trigger may be set to “free run”. Trace average 100 traces in power averaging mode. Compute power by integrating the spectrum across the 26 dB EBW of the signal. The integration can be performed using the spectrum analyzer’s band power measurement function with band limits set equal to the EBW band edges or by summing power levels in each 1 MHz band in linear power terms. The 1 MHz band power levels to be summed can be obtained by averaging, in linear power terms, power levels in each frequency bin across the 1 MHz.

### TEST RESULTS

*No non-compliance noted*



**Test Data**

**Test mode: IEEE 802.11a mode / 5180 ~ 5240MHz**

Channel	Frequency (MHz)	Maximum Conducted Output Power (dBm)	Limit (dBm)
Low	5180	21.85	30.00
Mid	5220	21.94	
High	5240	21.78	

**Test mode: IEEE 802.11n HT 20 mode / 5180 ~ 5240MHz**

Channel	Frequency (MHz)	Chain 0 Output Power (dBm)	Chain 1 Output Power (dBm)	Total Maximum Conducted Output Power (dBm)	Limit (dBm)
Low	5180	21.78	21.81	24.81	30.00
Mid	5220	21.93	21.44	24.70	
High	5240	21.98	21.70	24.85	

**Test mode: IEEE 802.11n HT 40 mode / 5190 ~ 5230MHz**

Channel	Frequency (MHz)	Chain 0 Output Power (dBm)	Chain 1 Output Power (dBm)	Total Maximum Conducted Output Power (dBm)	Limit (dBm)
Low	5190	21.77	21.55	24.67	30.00
High	5230	21.94	21.80	24.88	

**Test mode: IEEE 802.11n ac80 MHz mode / 5210MHz**

Channel	Frequency (MHz)	Chain 0 Output Power (dBm)	Chain 1 Output Power (dBm)	Total Maximum Conducted Output Power (dBm)	Limit (dBm)
Mid	5210	21.52	21.33	24.44	30.00

**Remark:** 1. Total PPSD (dBm) = 10\*LOG(10^(Chain 0 PPSD / 10)+10^(Chain 1 PPSD / 10))

**Test mode: IEEE 802.11a mode / 5745 ~ 5825MHz**

Channel	Frequency (MHz)	Maximum Conducted Output Power (dBm)	Limit (dBm)
Low	5745	21.97	30.00
Mid	5785	21.83	
High	5825	21.78	

**Test mode: IEEE 802.11n HT 20 mode / 5745 ~ 5825MHz**

Channel	Frequency (MHz)	Chain 0 Output Power (dBm)	Chain 1 Output Power (dBm)	Total Maximum Conducted Output Power (dBm)	Limit (dBm)
Low	5745	21.91	21.73	24.83	30.00
Mid	5785	21.63	21.49	24.57	
High	5825	21.35	21.93	24.66	

**Test mode: IEEE 802.11n HT 40 mode / 5755 ~ 5795MHz**

Channel	Frequency (MHz)	Chain 0 Output Power (dBm)	Chain 1 Output Power (dBm)	Total Maximum Conducted Output Power (dBm)	Limit (dBm)
Low	5755	21.72	21.86	24.80	30.00
High	5795	21.50	21.49	24.51	

**Test mode: IEEE 802.11n ac80 MHz mode / 5775MHz**

Channel	Frequency (MHz)	Chain 0 Output Power (dBm)	Chain 1 Output Power (dBm)	Total Maximum Conducted Output Power (dBm)	Limit (dBm)
Mid	5775	21.83	21.26	24.56	30.00

**Remark:** 1. Total PPSD (dBm) =  $10 * \text{LOG}(10^{(\text{Chain 0 PPSD} / 10)} + 10^{(\text{Chain 1 PPSD} / 10)})$



### 7.3 AVERAGE POWER

#### LIMIT

None; for reporting purposes only.

#### Test Configuration

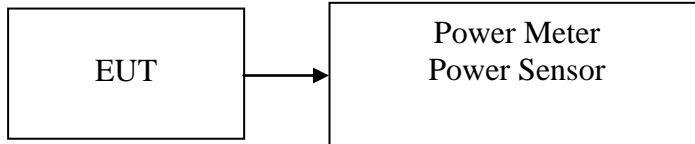

#### TEST PROCEDURE

The transmitter output is connected to the Power Meter. The Power Meter is set to the avg power detection.

#### TEST RESULTS

*No non-compliance noted.*

**Test Data****Test mode: IEEE 802.11a mode / 5180 ~ 5240MHz**

Channel	Frequency (MHz)	Maximum Conducted Output Power (dBm)	Limit (dBm)
Low	5180	11.48	30.00
Mid	5220	<b>*11.56</b>	
High	5240	11.40	

**Test mode: IEEE 802.11n HT 20 mode / 5180 ~ 5240MHz**

Channel	Frequency (MHz)	Chain 0 Output Power (dBm)	Chain 1 Output Power (dBm)	Total Maximum Conducted Output Power (dBm)	Limit (dBm)
Low	5180	11.78	12.51	15.17	30.00
Mid	5220	12.13	12.21	15.18	
High	5240	12.15	12.53	<b>*15.35</b>	

**Test mode: IEEE 802.11n HT 40 mode / 5190 ~ 5230MHz**

Channel	Frequency (MHz)	Chain 0 Output Power (dBm)	Chain 1 Output Power (dBm)	Total Maximum Conducted Output Power (dBm)	Limit (dBm)
Low	5190	12.03	12.09	15.07	30.00
High	5230	12.25	12.24	<b>*15.26</b>	

**Test mode: IEEE 802.11n ac80 MHz mode / 5210MHz**

Channel	Frequency (MHz)	Chain 0 Output Power (dBm)	Chain 1 Output Power (dBm)	Total Maximum Conducted Output Power (dBm)	Limit (dBm)
Mid	5210	12.27	12.05	<b>*15.17</b>	30.00

**Remark:** 1. Total PPSD (dBm) =  $10 * \text{LOG}(10^{(\text{Chain 0 PPSD} / 10)} + 10^{(\text{Chain 1 PPSD} / 10)})$

**Test mode: IEEE 802.11a mode / 5745 ~ 5825MHz**

Channel	Frequency (MHz)	Maximum Conducted Output Power (dBm)	Limit (dBm)
Low	5745	*11.62	30.00
Mid	5785	11.53	
High	5825	11.33	

**Test mode: IEEE 802.11n HT 20 mode / 5745 ~ 5825MHz**

Channel	Frequency (MHz)	Chain 0 Output Power (dBm)	Chain 1 Output Power (dBm)	Total Maximum Conducted Output Power (dBm)	Limit (dBm)
Low	5745	12.13	12.33	*15.24	30.00
Mid	5785	11.91	12.26	15.10	
High	5825	11.63	12.63	15.17	

**Test mode: IEEE 802.11n HT 40 mode / 5755 ~ 5795MHz**

Channel	Frequency (MHz)	Chain 0 Output Power (dBm)	Chain 1 Output Power (dBm)	Total Maximum Conducted Output Power (dBm)	Limit (dBm)
Low	5755	12.14	12.22	*15.19	30.00
High	5795	11.83	11.92	14.89	

**Test mode: IEEE 802.11n ac80 MHz mode / 5775MHz**

Channel	Frequency (MHz)	Chain 0 Output Power (dBm)	Chain 1 Output Power (dBm)	Total Maximum Conducted Output Power (dBm)	Limit (dBm)
Mid	5775	12.49	11.83	*15.18	30.00

**Remark:** 1. Total PPSD (dBm) =  $10 * \text{LOG}(10^{(\text{Chain 0 PPSD} / 10)} + 10^{(\text{Chain 1 PPSD} / 10)})$



## 7.4 BAND EDGES MEASUREMENT

### LIMIT

According to §15.407(b),

- (1) The provisions of Section 15.205 of this part apply to intentional radiators operating under this section.
- (2) When measuring the emission limits, the nominal carrier frequency shall be adjusted as close to the upper and lower frequency block edges as the design of the equipment permits.

### Test Configuration

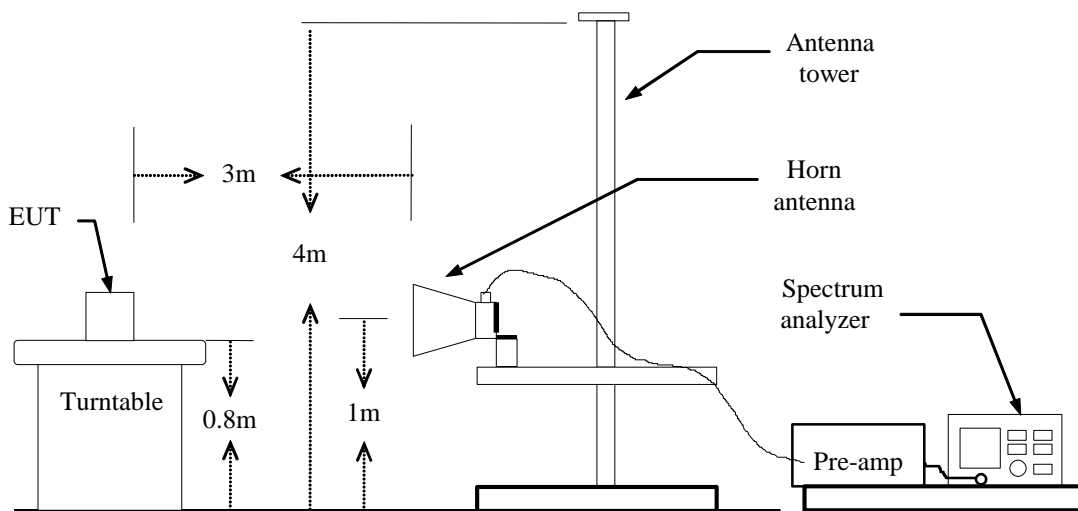

### TEST PROCEDURE

1. The EUT is placed on a turntable, which is 0.8m above the ground plane.
2. The turntable shall be rotated for 360 degrees to determine the position of maximum emission level.
3. EUT is set 3m away from the receiving antenna, which is varied from 1m to 4m to find out the highest emission.
4. Set the spectrum analyzer in the following setting in order to capture the lower and upper band-edges of the emission:
  - (a) PEAK: RBW=VBW=1MHz / Sweep=AUTO
  - (b) AVERAGE: RBW=1MHz / VBW=300Hz / Sweep=AUTO
5. Repeat the procedures until all the PEAK and AVERAGE versus POLARIZATION are measured.

### TEST RESULTS

Refer to attach spectrum analyzer data chart.



### Band Edges (IEEE 802.11a mode / 5180 MHz)

Detector mode: Peak

Polarity: Vertical

Agilent

R T

Mkr1 5.150 0 GHz

62.37 dB $\mu$ V/m

Ref 119 dB $\mu$ V/m

#Atten 16 dB

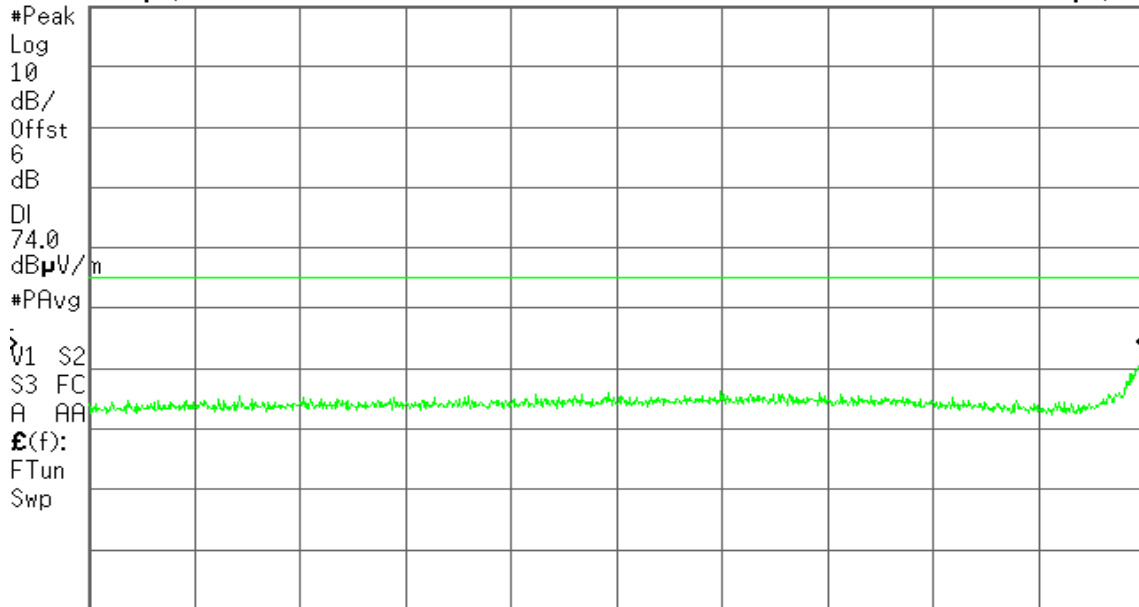

Start 4.500 0 GHz

Stop 5.150 0 GHz

#Res BW 1 MHz

#VBW 3 MHz

#Sweep 100 ms (1001 pts)

Detector mode: Average

Polarity: Vertical

Agilent

R T

Mkr1 5.150 0 GHz

48.51 dB $\mu$ V/m

Ref 119 dB $\mu$ V/m

#Atten 16 dB

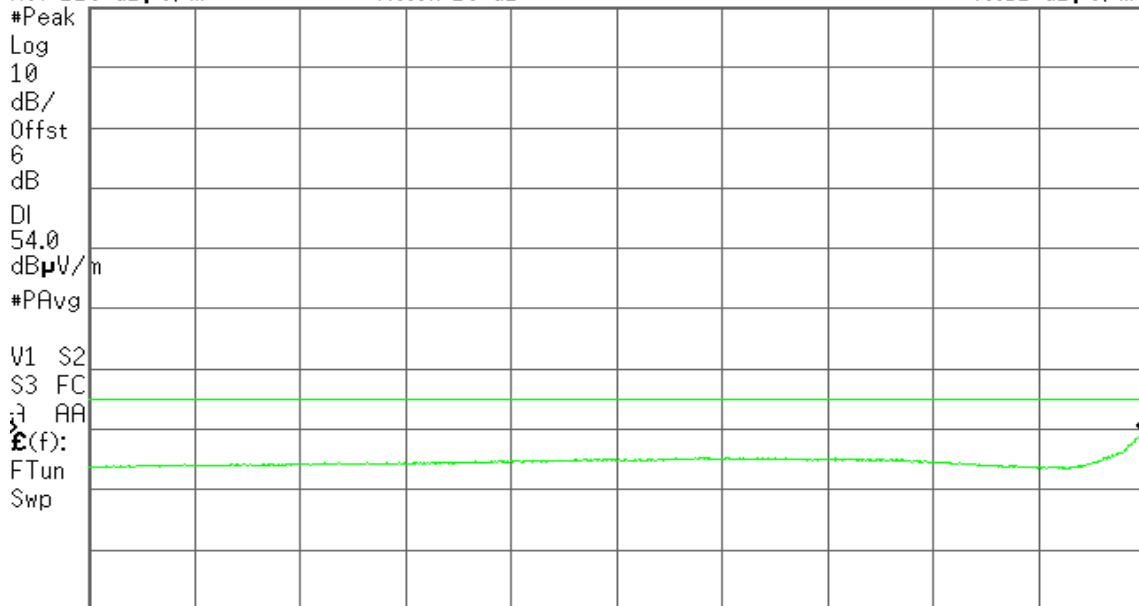

Start 4.500 0 GHz

Stop 5.150 0 GHz

#Res BW 1 MHz

#VBW 510 Hz

Sweep 993.8 ms (1001 pts)





**Detector mode: Peak**

**Polarity: Horizontal**

Agilent

R T

Mkr1 5.148 7 GHz  
64.14 dB $\mu$ V/m

Ref 119 dB $\mu$ V/m

#Atten 16 dB

#Peak  
Log  
10  
dB/  
Offst  
6  
dB  
DI  
74.0  
dB $\mu$ V/m  
#PAvg  
>  
M1 S2  
S3 FC  
A AA  
£(f):  
FTun  
Swp

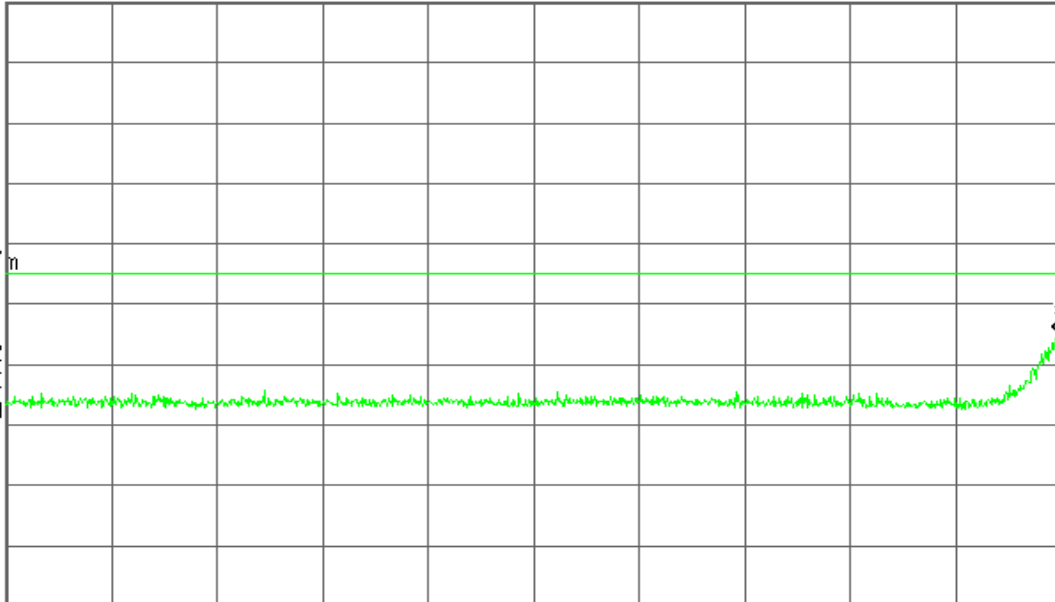

Start 4.500 0 GHz

Stop 5.150 0 GHz

#Res BW 1 MHz

#VBW 3 MHz

#Sweep 100 ms (1001 pts)

**Detector mode: Average**

**Polarity: Horizontal**

Agilent

R T

Mkr1 5.150 0 GHz  
53.08 dB $\mu$ V/m

Ref 119 dB $\mu$ V/m

#Atten 16 dB

#Peak  
Log  
10  
dB/  
Offst  
6  
dB  
DI  
54.0  
dB $\mu$ V/m  
#PAvg  
  
M1 S2  
S3 FC  
A AA  
£(f):  
FTun  
Swp

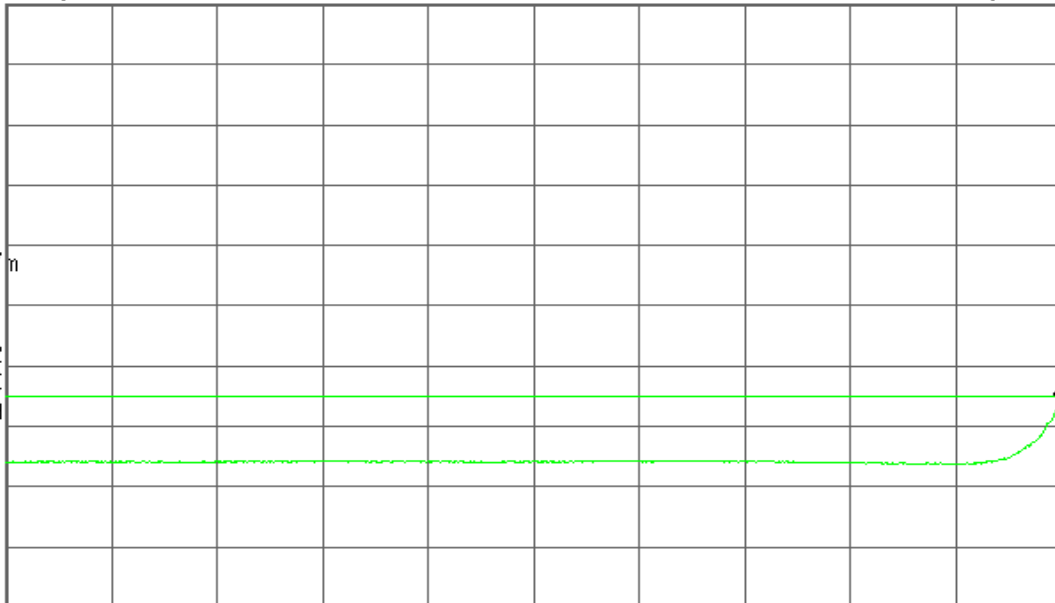

Start 4.500 0 GHz

Stop 5.150 0 GHz

#Res BW 1 MHz

#VBW 510 Hz

Sweep 993.8 ms (1001 pts)



Band Edges (IEEE 802.11n HT 20 mode / 5180 MHz)

Detector mode: Peak

Polarity: Vertical

Agilent

R T

Mkr1 5.148 7 GHz  
60.31 dBµV/m

Ref 119 dBµV/m

#Atten 16 dB

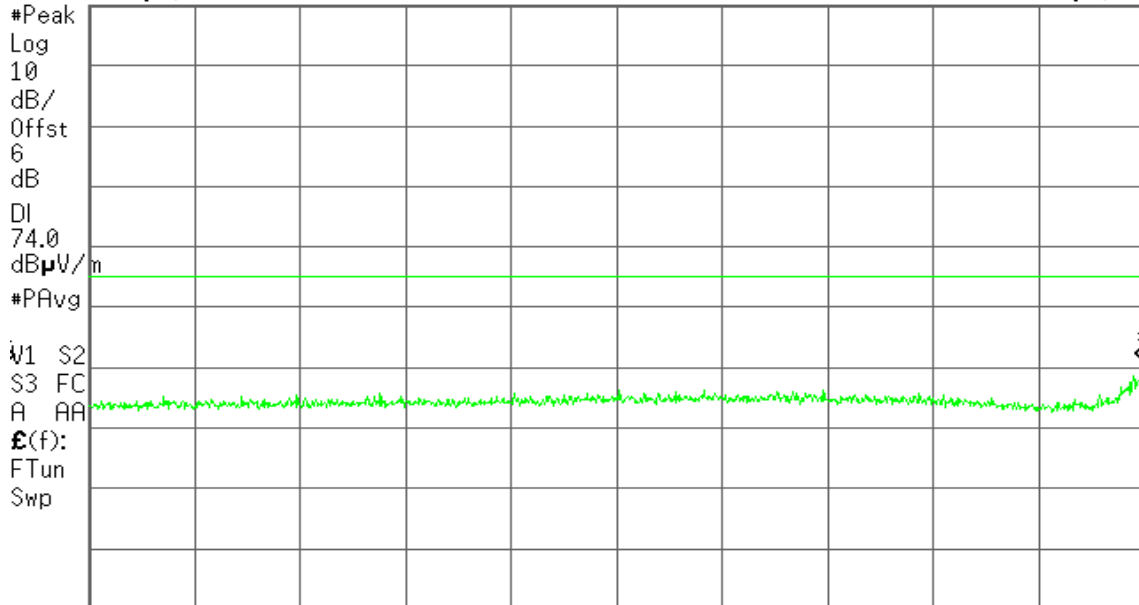

Start 4.500 0 GHz

Stop 5.150 0 GHz

#Res BW 1 MHz

#VBW 3 MHz

#Sweep 100 ms (1001 pts)

Detector mode: Average

Polarity: Vertical

Agilent

R T

Mkr1 5.149 4 GHz  
45.78 dBµV/m

Ref 119 dBµV/m

#Atten 16 dB

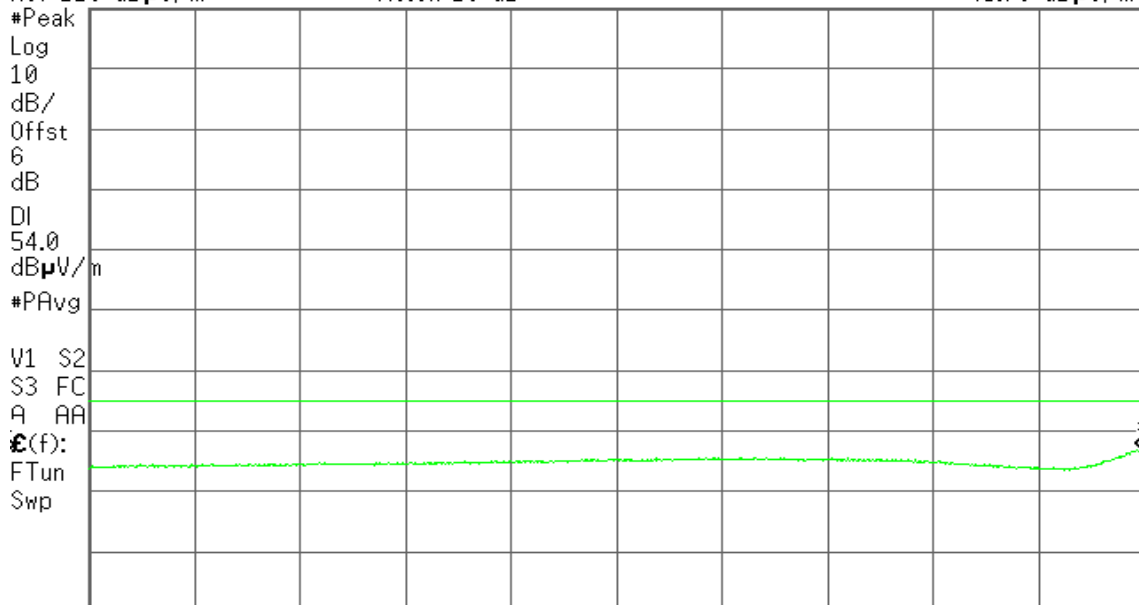

Start 4.500 0 GHz

Stop 5.150 0 GHz

#Res BW 1 MHz

#VBW 1.1 kHz

Sweep 460.8 ms (1001 pts)



Detector mode: Peak

Polarity: Horizontal

Agilent

R T

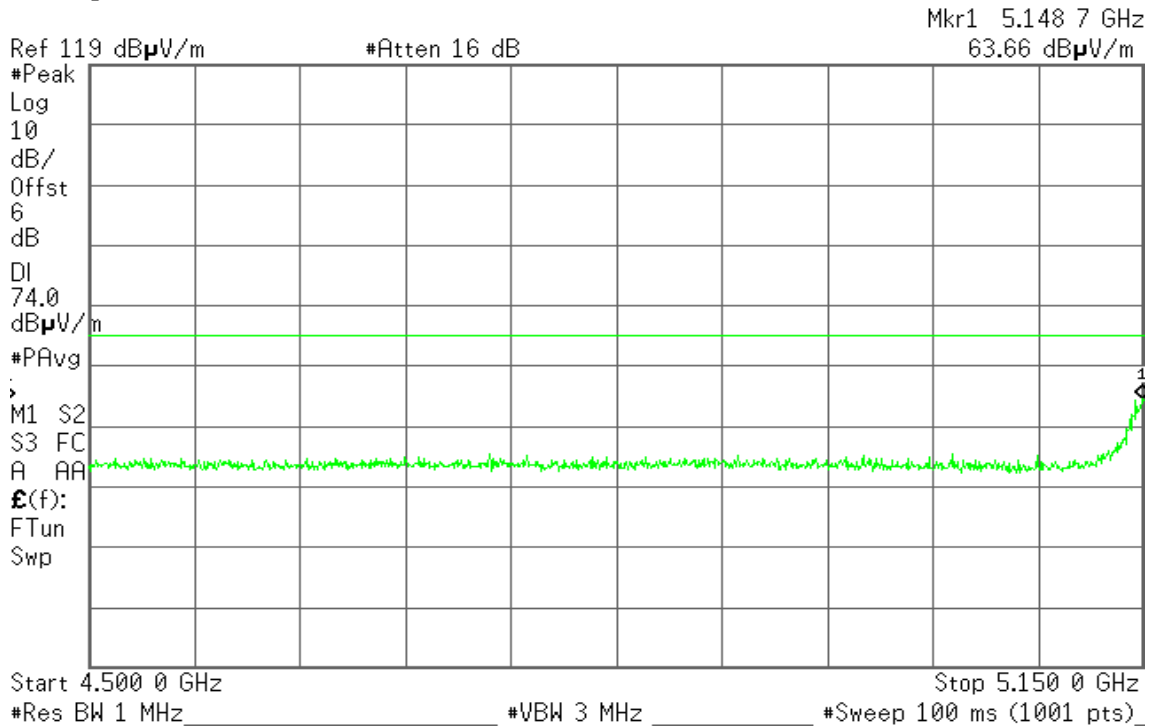

Detector mode: Average

Polarity: Horizontal

Agilent

R T

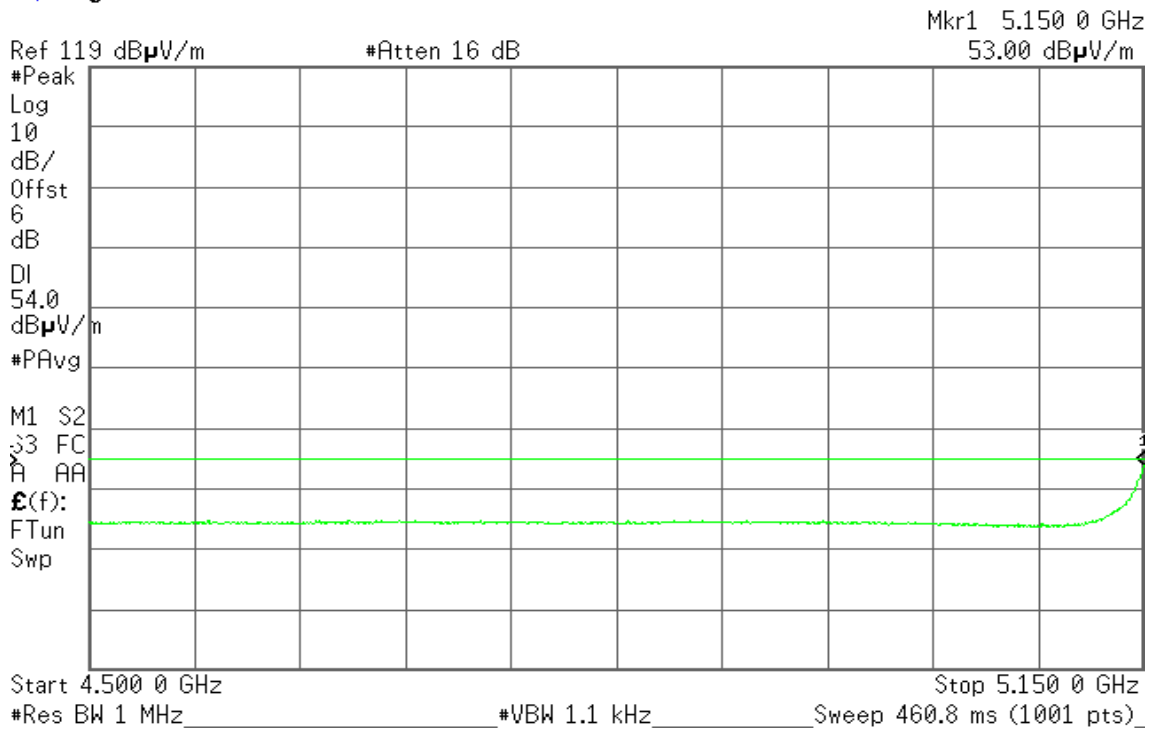



Band Edges (IEEE 802.11n HT 40 mode / 5190 MHz)

Detector mode: Peak

Polarity: Vertical

Agilent

R T

Mkr1 5.148 7 GHz  
65.99 dBμV/m

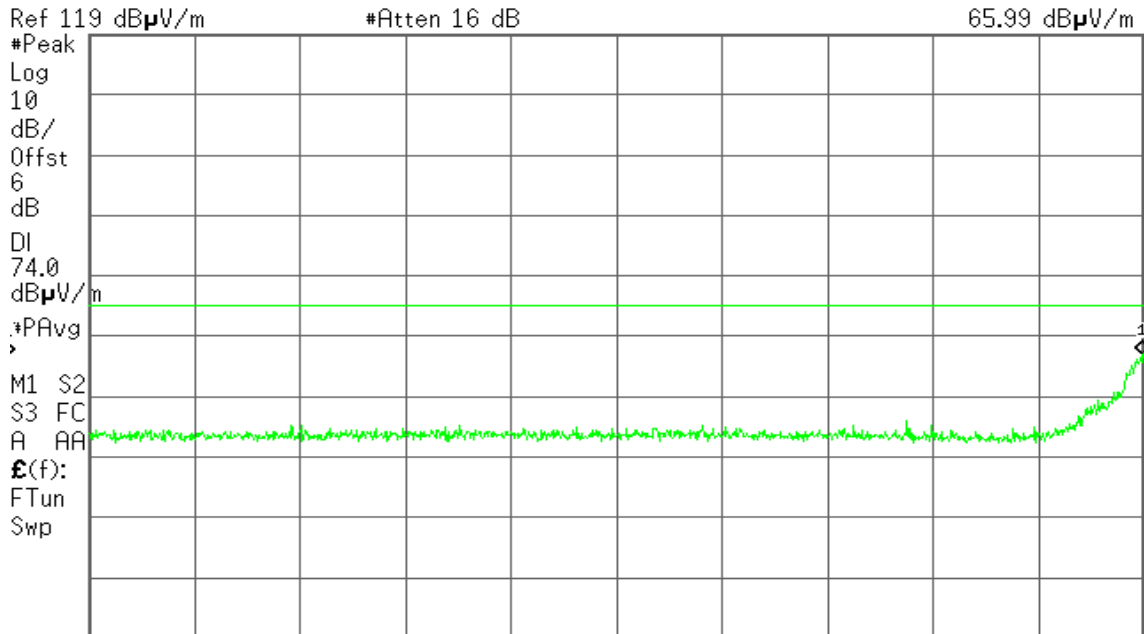

Start 4.500 0 GHz Stop 5.150 0 GHz  
#Res BW 1 MHz #VBW 3 MHz #Sweep 100 ms (1001 pts)

Detector mode: Average

Polarity: Vertical

Agilent

R T

Mkr1 5.149 4 GHz  
53.22 dBμV/m

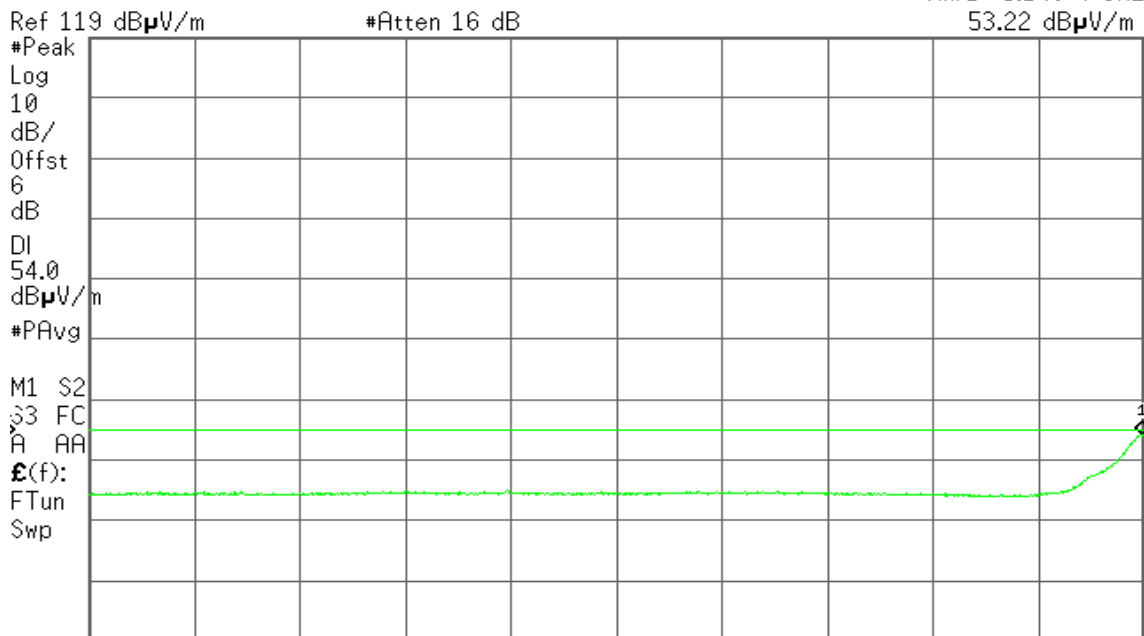

Start 4.500 0 GHz Stop 5.150 0 GHz  
#Res BW 1 MHz #VBW 1.1 kHz Sweep 460.8 ms (1001 pts)



Detector mode: Peak

Polarity: Horizontal

Agilent

R T

Mkr1 5.150 0 GHz  
62.63 dB $\mu$ V/m

Ref 119 dB $\mu$ V/m

#Atten 16 dB

#Peak  
Log  
10  
dB/  
Offst  
6  
dB  
DI  
74.0  
dB $\mu$ V/m  
#PAvg  
M1 S2  
S3 FC  
A AA  
£(f):  
FTun  
Swp

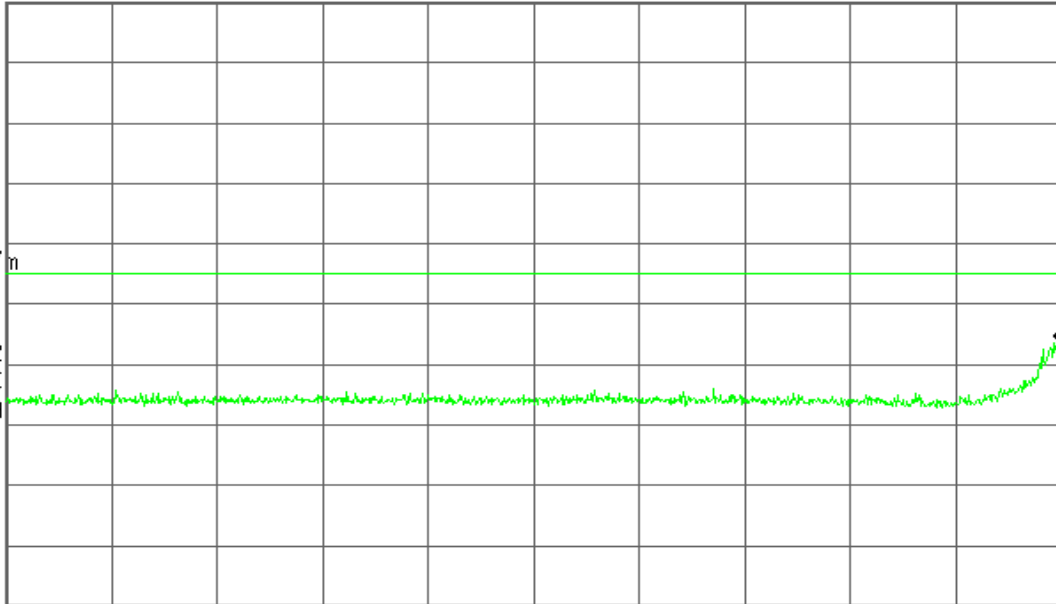

Start 4.500 0 GHz

Stop 5.150 0 GHz

#Res BW 1 MHz

#VBW 3 MHz

#Sweep 100 ms (1001 pts)

Detector mode: Average

Polarity: Horizontal

Agilent

R T

Mkr1 5.148 7 GHz  
49.99 dB $\mu$ V/m

Ref 119 dB $\mu$ V/m

#Atten 16 dB

#Peak  
Log  
10  
dB/  
Offst  
6  
dB  
DI  
54.0  
dB $\mu$ V/m  
#PAvg  
M1 S2  
S3 FC  
A AA  
£(f):  
FTun  
Swp

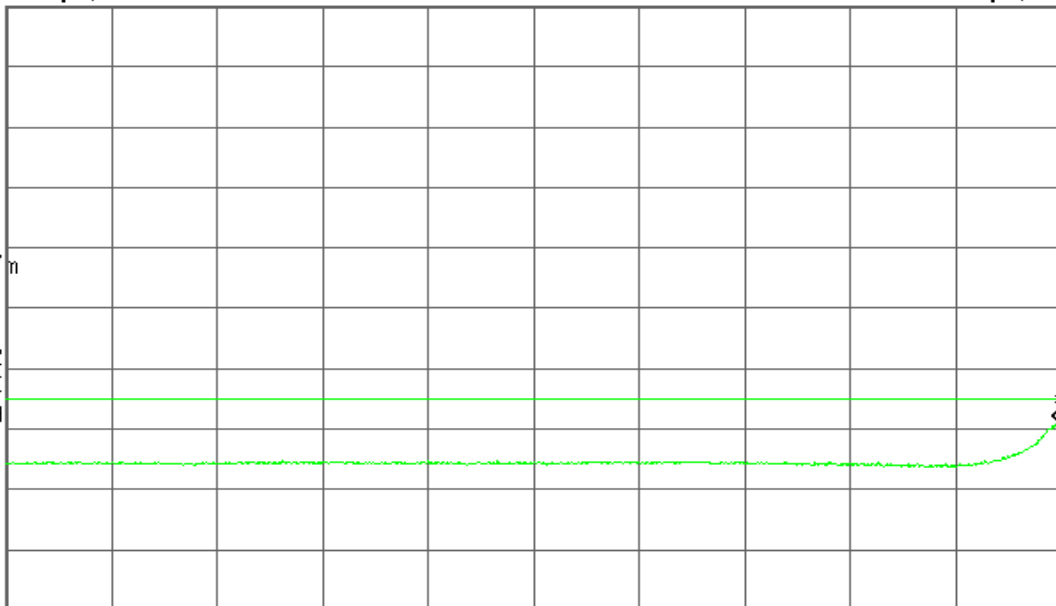

Start 4.500 0 GHz

Stop 5.150 0 GHz

#Res BW 1 MHz

#VBW 1.1 kHz

Sweep 460.8 ms (1001 pts)



Band Edges (IEEE 802.11n ac80 MHz mode / CH 5210 MHz)

Detector mode: Peak

Polarity: Vertical

Agilent

R T

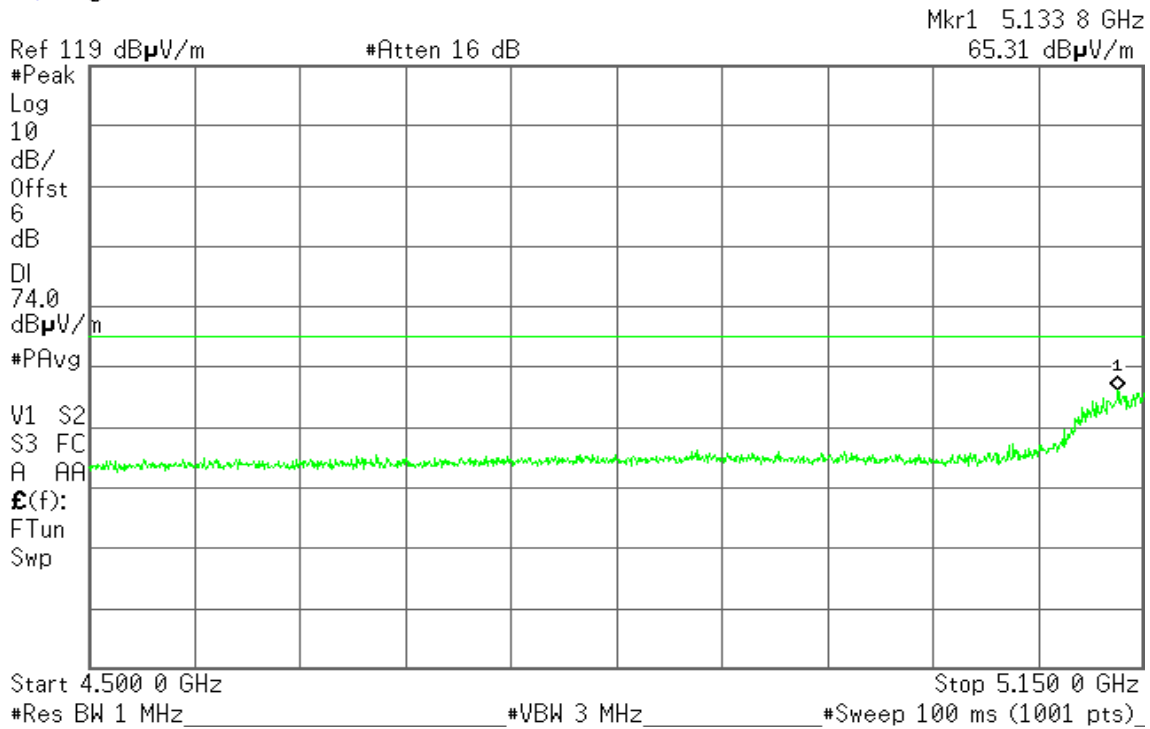

Detector mode: Average

Polarity: Vertical

Agilent

R T

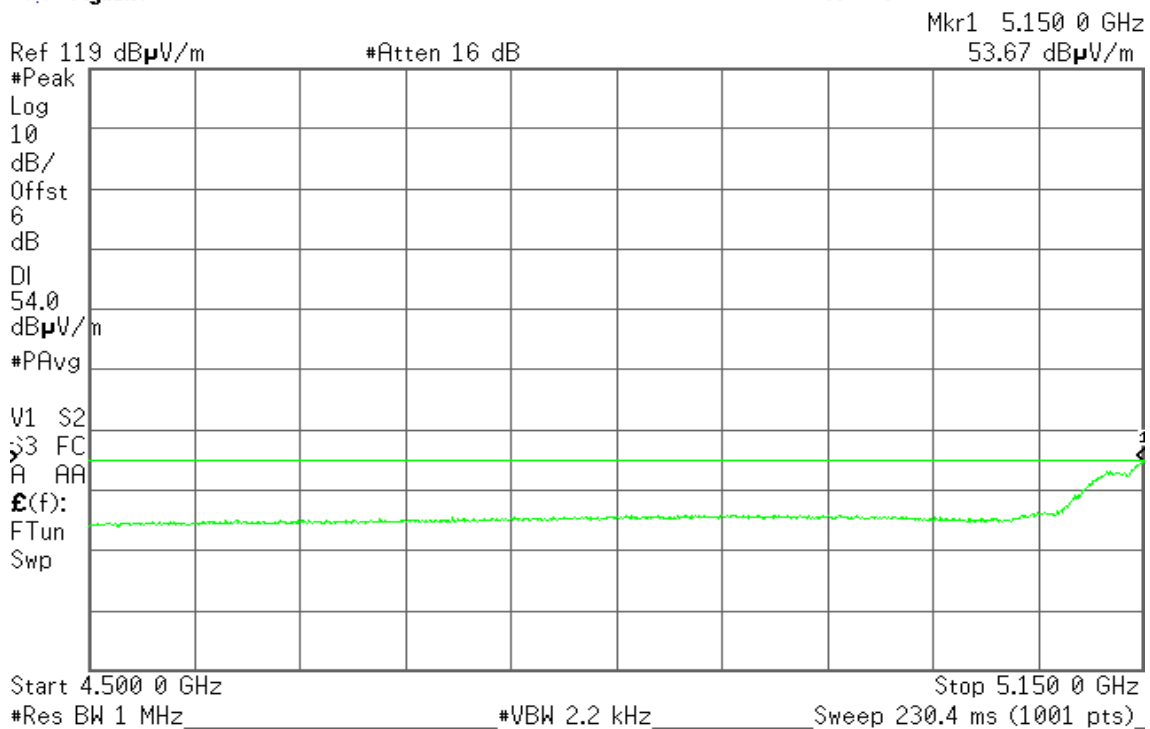



Detector mode: Peak

Polarity: Horizontal

Agilent

R T

Mkr1 5.137 6 GHz  
60.84 dB $\mu$ V/m

Ref 119 dB $\mu$ V/m

#Atten 16 dB

#Peak

Log

10

dB/

Offst

6

dB

DI

74.0

dB $\mu$ V/m

#PAvg

V1 S2

S3 FC

A AA

$\mathcal{E}(f)$ :

FTun

Swp

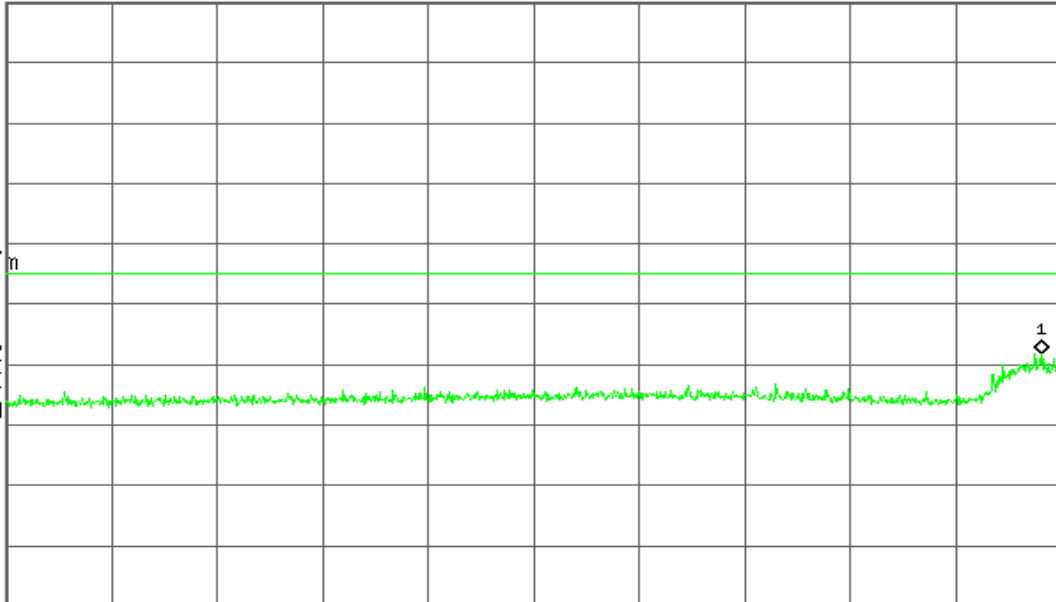

Start 4.500 0 GHz

Stop 5.150 0 GHz

#Res BW 1 MHz

#VBW 3 MHz

#Sweep 100 ms (1001 pts)

Detector mode: Average

Polarity: Horizontal

Agilent

R T

Mkr1 5.147 4 GHz  
49.48 dB $\mu$ V/m

Ref 119 dB $\mu$ V/m

#Atten 16 dB

#Peak

Log

10

dB/

Offst

6

dB

DI

54.0

dB $\mu$ V/m

#PAvg

V1 S2

S3 FC

A AA

$\mathcal{E}(f)$ :

FTun

Swp

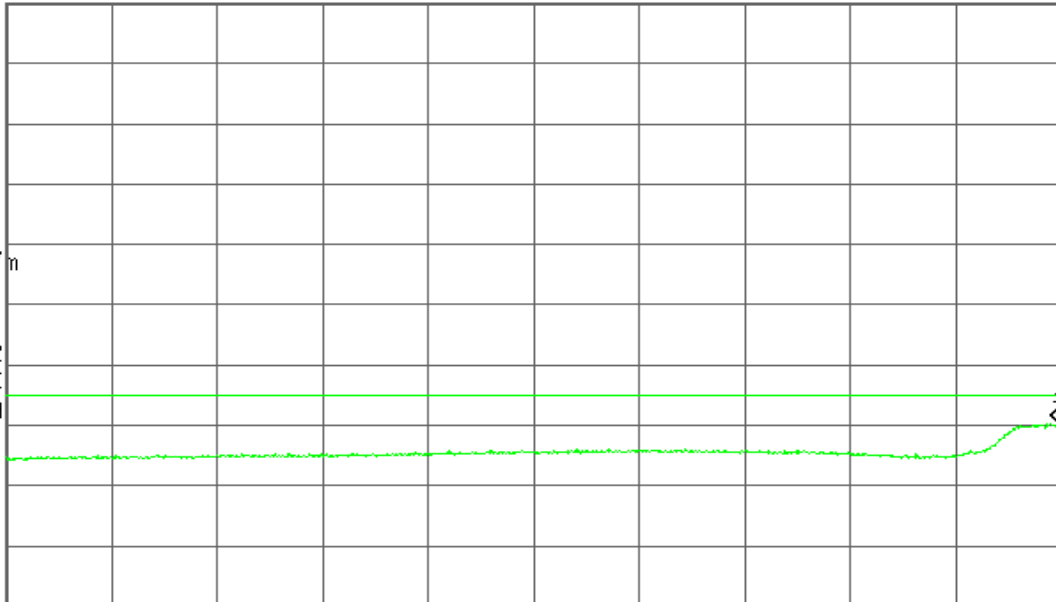

Start 4.500 0 GHz

Stop 5.150 0 GHz

#Res BW 1 MHz

#VBW 2.2 kHz

Sweep 230.4 ms (1001 pts)



## 7.5 PEAK POWER SPECTRAL DENSITY

### LIMIT

According to §15.407(a),

- (1) For the band 5.15-5.25 GHz, the peak power spectral density shall not exceed 4dBm in any 1MHz band.
- (2) For the band 5.25-5.35 GHz, the peak power spectral density shall not exceed 11dBm in any 1MHz band.

*If transmitting antennas of directional gain greater than 6dBi are used, both the peak transmit power and the peak power spectral density shall be reduced by the amount in dB that the directional gain of the antenna exceeds 6dBi.*

### Test Configuration

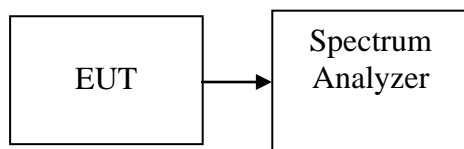

### TEST PROCEDURE

1. Place the EUT on the table and set it in transmitting mode.  
Remove the antenna from the EUT and then connect a low loss RF cable from the antenna port to the spectrum analyzer.
2. Set the spectrum analyzer as RBW = 1MHz, VBW = 3MHz, Span = 50MHz, Sweep=1ms
3. Record the max. reading.
4. Repeat the above procedure until the measurements for all frequencies are completed

### TEST RESULTS

*No non-compliance noted*



**Test Data****Test mode: IEEE 802.11a mode / 5180 ~ 5240MHz**

Channel	Frequency (MHz)	PPSD (dBm)	Limit (dBm)	Result
Low	5180	-0.58	4.00	PASS
Mid	5220	0		PASS
High	5240	0.85		PASS

**Test mode: IEEE 802.11n HT 20 mode / 5180 ~ 5240MHz**

Channel	Frequency (MHz)	Chain 0 PPSD (dBm)	Chain 1 PPSD (dBm)	PPSD (dBm)	Limit (dBm)	Result
Low	5180	-0.75	-2.54	1.46	32	PASS
Mid	5220	0.03	-1.81	2.22		PASS
High	5240	0.09	-1.53	2.37		PASS

**Test mode: IEEE 802.11n HT 40 mode / 5190 ~ 5230MHz**

Channel	Frequency (MHz)	Chain 0 PPSD (dBm)	Chain 1 PPSD (dBm)	PPSD (dBm)	Limit (dBm)	Result
Low	5190	-7.03	-3.66	-2.02	32	PASS
High	5230	-6.04	-3.07	-1.30		PASS

**Test mode: IEEE 802.11n ac80 MHz mode / 5210MHz**

Channel	Frequency (MHz)	Chain 0 PPSD (dBm)	Chain 1 PPSD (dBm)	PPSD (dBm)	Limit (dBm)	Result
Mid	5210	-4.18	-4.59	-1.37	32	PASS

**Remark:** 1. Total PPSD (dBm) =  $10 * \text{LOG}(10^{(\text{Chain 0 PPSD} / 10)} + 10^{(\text{Chain 1 PPSD} / 10)})$

2. The maximum antenna gain is 7dBi; therefore the reduction due to antenna gain is -2dBi, so the limit is 32dBm.

**Test mode: IEEE 802.11a mode/ 5745 ~ 5825MHz**

Channel	Frequency (MHz)	PPSD (dBm)	Limit (dBm)	Result
Low	5745	-2.04	8.00	PASS
Mid	5785	-2.39		PASS
High	5825	-2.50		PASS

**Test mode: IEEE 802.11n HT 20 mode / 5745 ~ 5825MHz**

Channel	Frequency (MHz)	Chain 0 PPSD (dBm)	Chain 1 PPSD (dBm)	PPSD (dBm)	Limit (dBm)	Result
Low	5745	-3.71	-3.02	-0.34	32	PASS
Mid	5785	-4.30	-2.95	-0.56		PASS
High	5825	-4.82	-2.24	-0.33		PASS

**Test mode: IEEE 802.11n HT 40 mode / 5755 ~ 5795MHz**

Channel	Frequency (MHz)	Chain 0 PPSD (dBm)	Chain 1 PPSD (dBm)	PPSD (dBm)	Limit (dBm)	Result
Low	5755	-7.38	-5.45	-3.30	32	PASS
High	5795	-7.76	-5.45	-3.44		PASS

**Test mode: IEEE 802.11n ac80 MHz mode / 5775MHz**

Channel	Frequency (MHz)	Chain 0 PPSD (dBm)	Chain 1 PPSD (dBm)	PPSD (dBm)	Limit (dBm)	Result
Mid	5775	-8.32	-8.33	-5.31	32	PASS

**Remark:** 1. Total PPSD (dBm) =  $10 * \text{LOG}(10^{(\text{Chain 0 PPSD} / 10)} + 10^{(\text{Chain 1 PPSD} / 10)})$

2. The maximum antenna gain is 7dBi; therefore the reduction due to antenna gain is -2dBi, so the limit is 32dBm.



**Test Plot**

**IEEE 802.11a mode / 5180 ~ 5240MHz**

**CH Low**

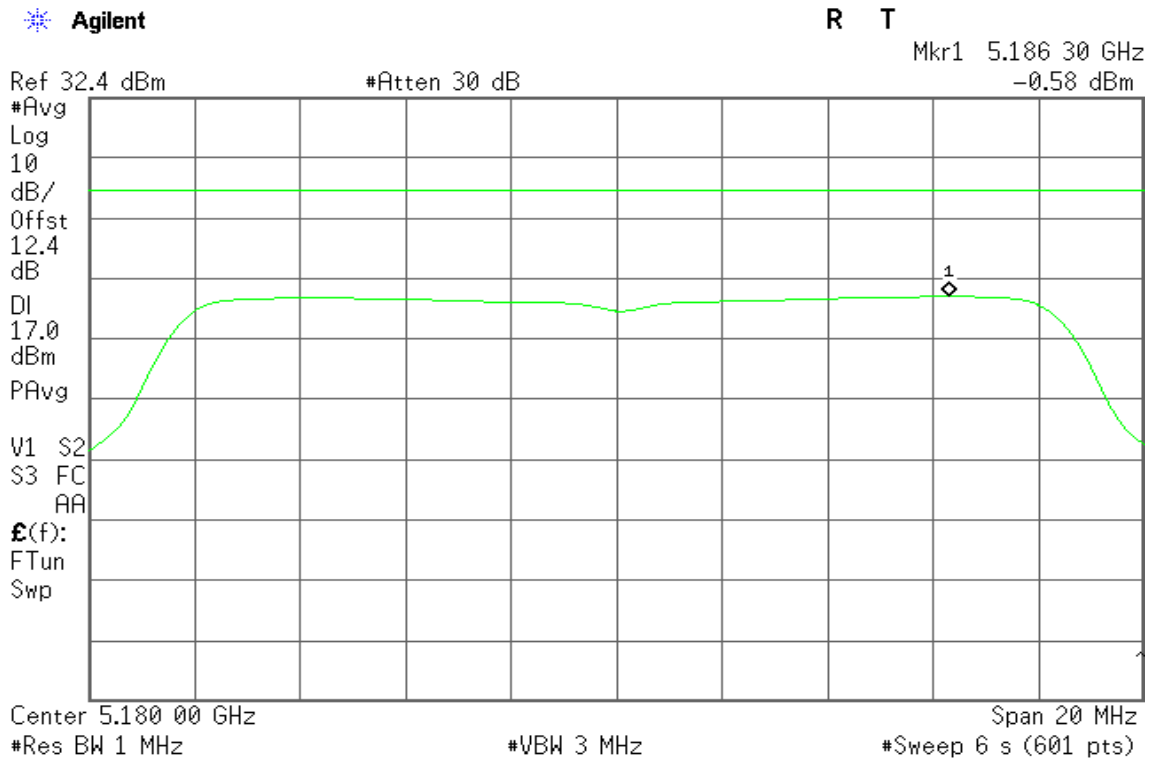

**CH Mid**

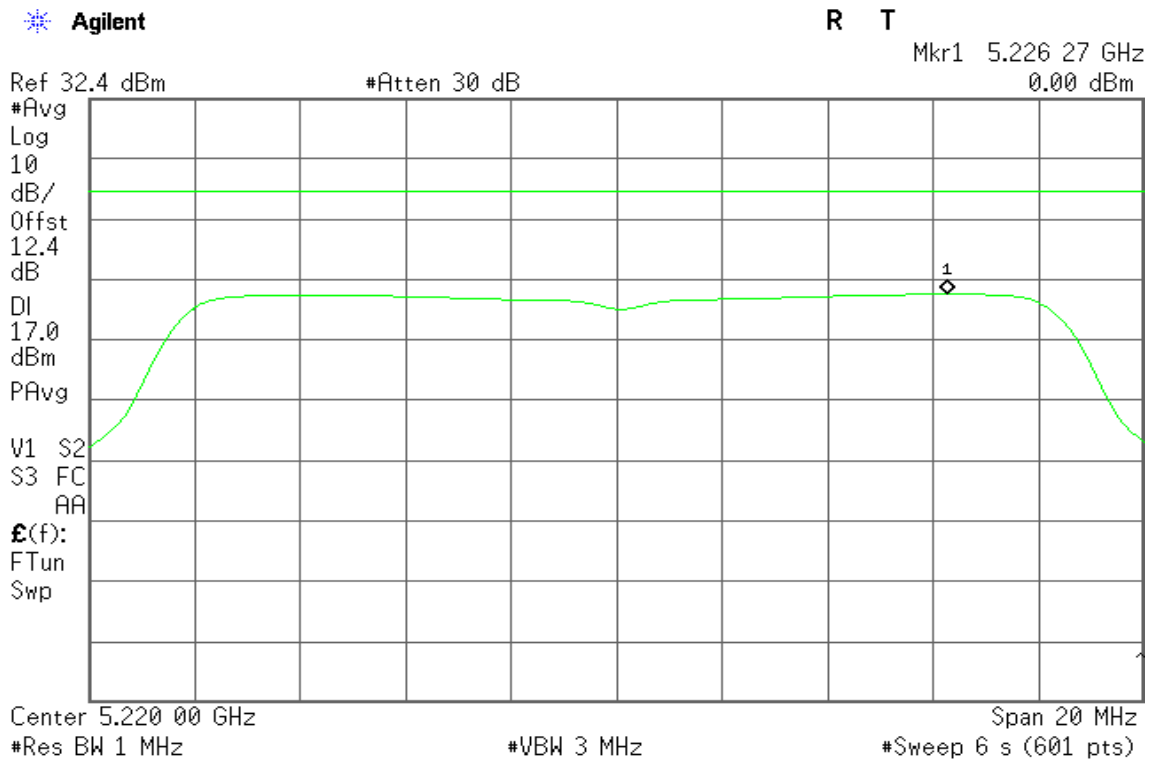



### CH High

Agilent

R T

Mkr1 5.246 30 GHz  
0.85 dBm

Ref 32.4 dBm

#Atten 30 dB

#Avg  
Log  
10  
dB/  
Offst  
12.4  
dB  
DI  
17.0  
dBm  
PAvg  
V1 S2  
S3 FC  
AA  
£(f):  
FTun  
Swp

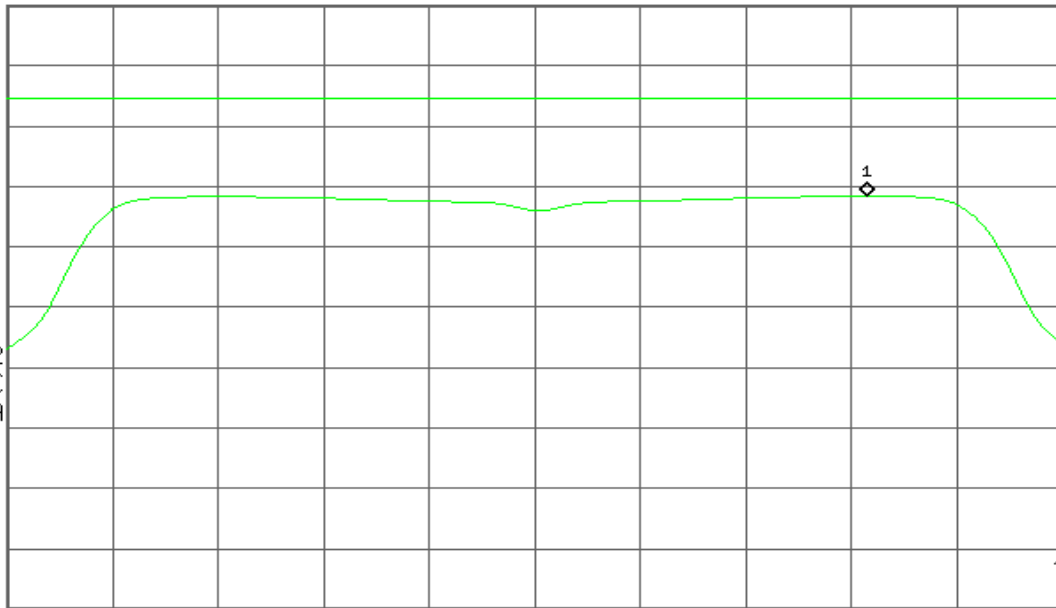

Center 5.240 00 GHz

Span 20 MHz

#Res BW 1 MHz

#VBW 3 MHz

#Sweep 6 s (601 pts)

### IEEE 802.11n HT 20 mode / 5180 ~ 5240MHz / Chain 0

### CH Low

Agilent

R T

Mkr1 5.186 20 GHz  
-0.75 dBm

Ref 32.4 dBm

#Atten 30 dB

#Avg  
Log  
10  
dB/  
Offst  
12.4  
dB  
DI  
17.0  
dBm  
PAvg  
V1 S2  
S3 FC  
AA  
£(f):  
FTun  
Swp

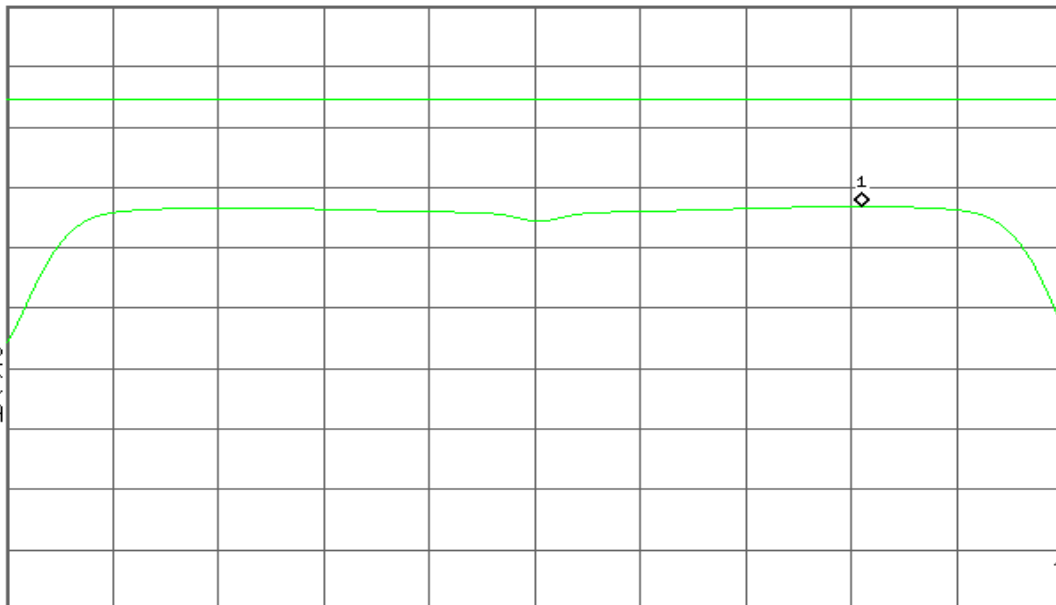

Center 5.180 00 GHz

Span 20 MHz

#Res BW 1 MHz

#VBW 3 MHz

#Sweep 6 s (601 pts)



### CH Mid

Agilent

R T

Mkr1 5.226 13 GHz  
0.03 dBm

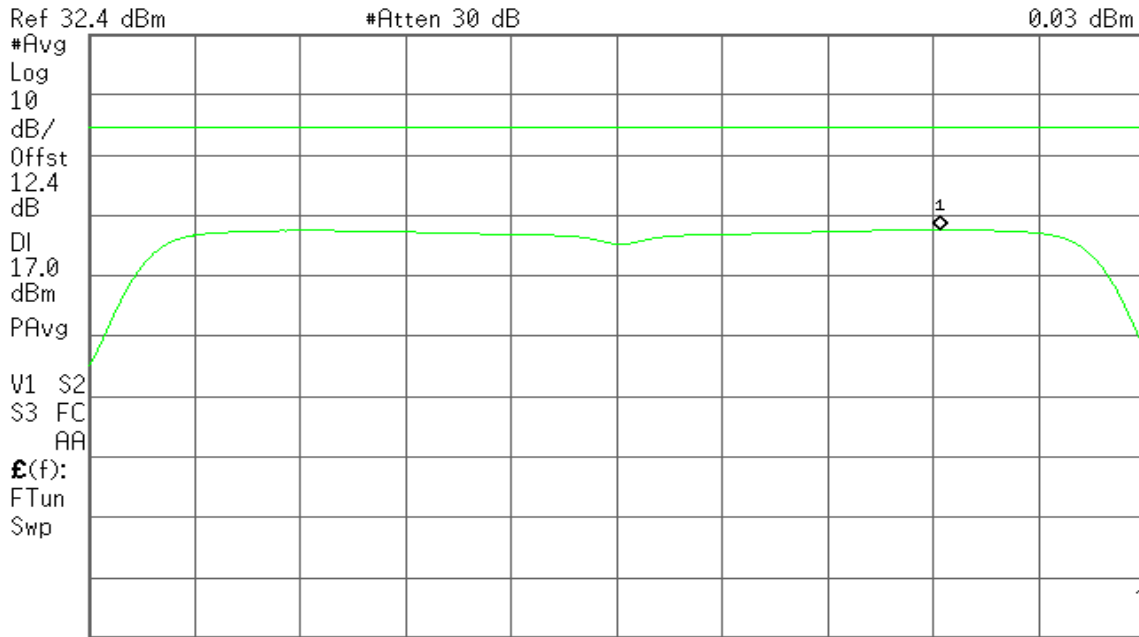

### CH High

Agilent

R T

Mkr1 5.246 17 GHz  
0.09 dBm

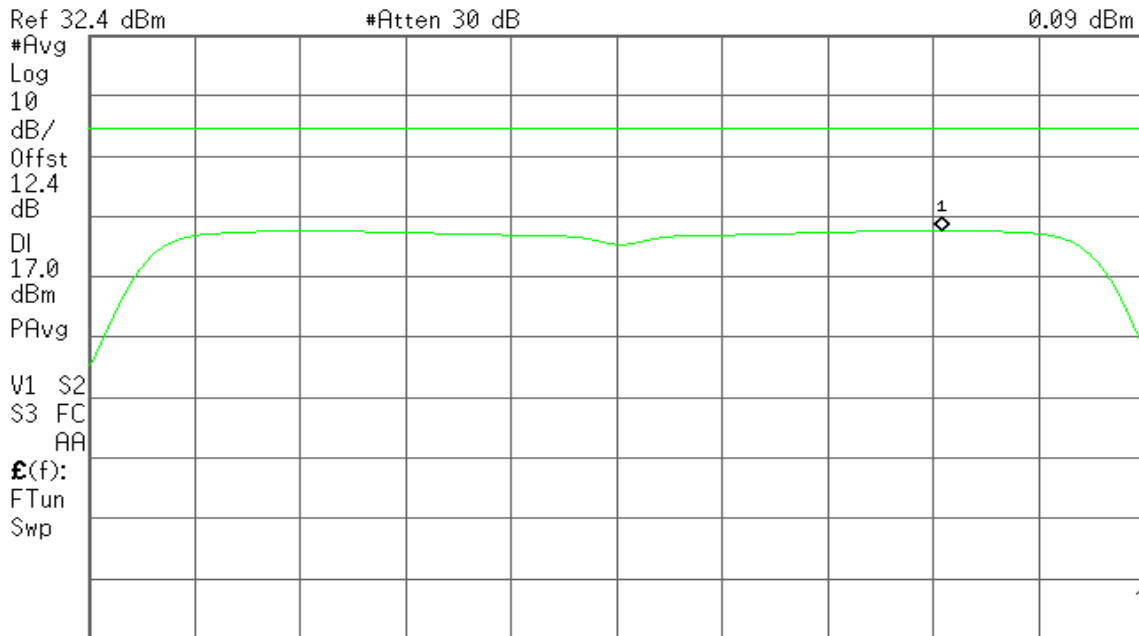



**IEEE 802.11n HT 20 mode / 5180 ~ 5240MHz / Chain 1**

**CH Low**

Agilent

R T

Mkr1 5.186 30 GHz  
-2.54 dBm

Ref 32.4 dBm

#Atten 30 dB

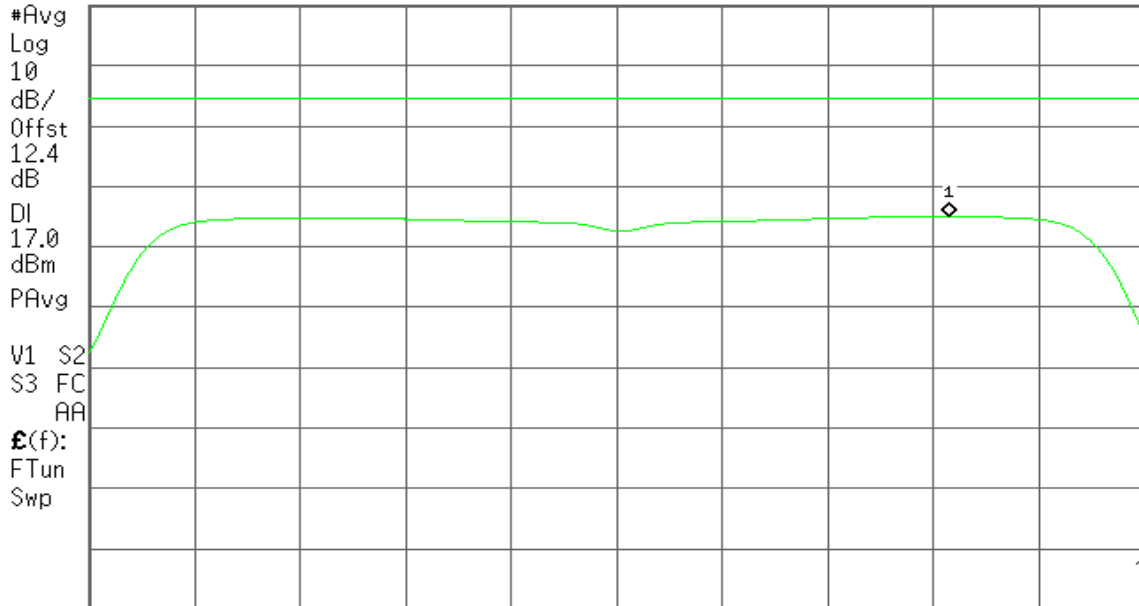

Center 5.180 00 GHz

Span 20 MHz

#Res BW 1 MHz

#VBW 3 MHz

#Sweep 6 s (601 pts)

**CH Mid**

Agilent

R T

Mkr1 5.226 23 GHz  
-1.81 dBm

Ref 32.4 dBm

#Atten 30 dB

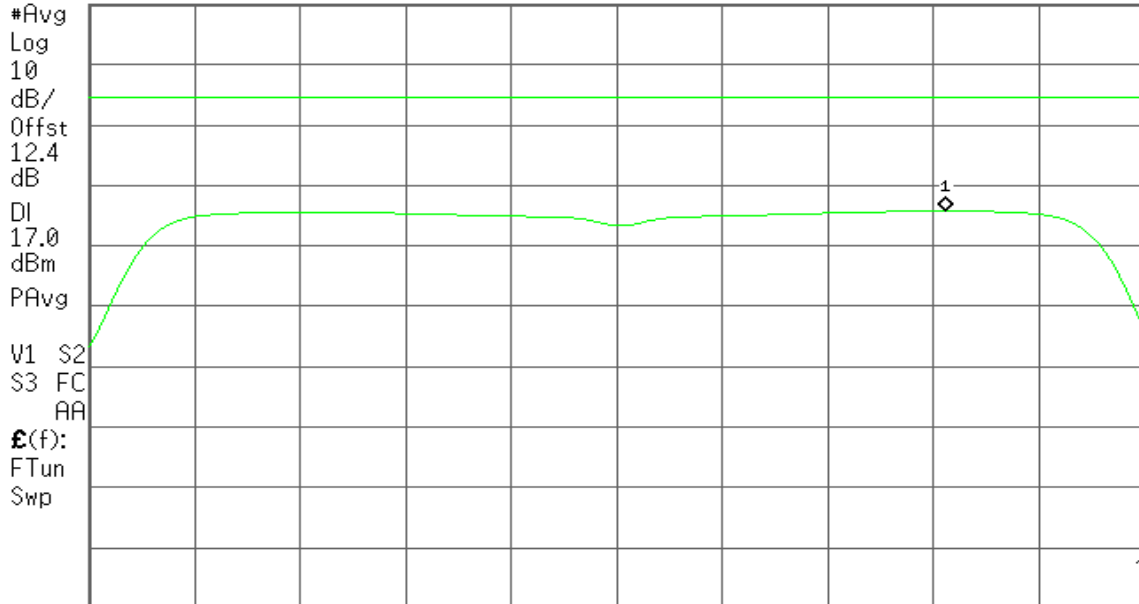

Center 5.220 00 GHz

Span 20 MHz

#Res BW 1 MHz

#VBW 3 MHz

#Sweep 6 s (601 pts)



### CH High

Agilent

R T

Mkr1 5.246 27 GHz  
-1.53 dBm

Ref 32.4 dBm

#Atten 30 dB

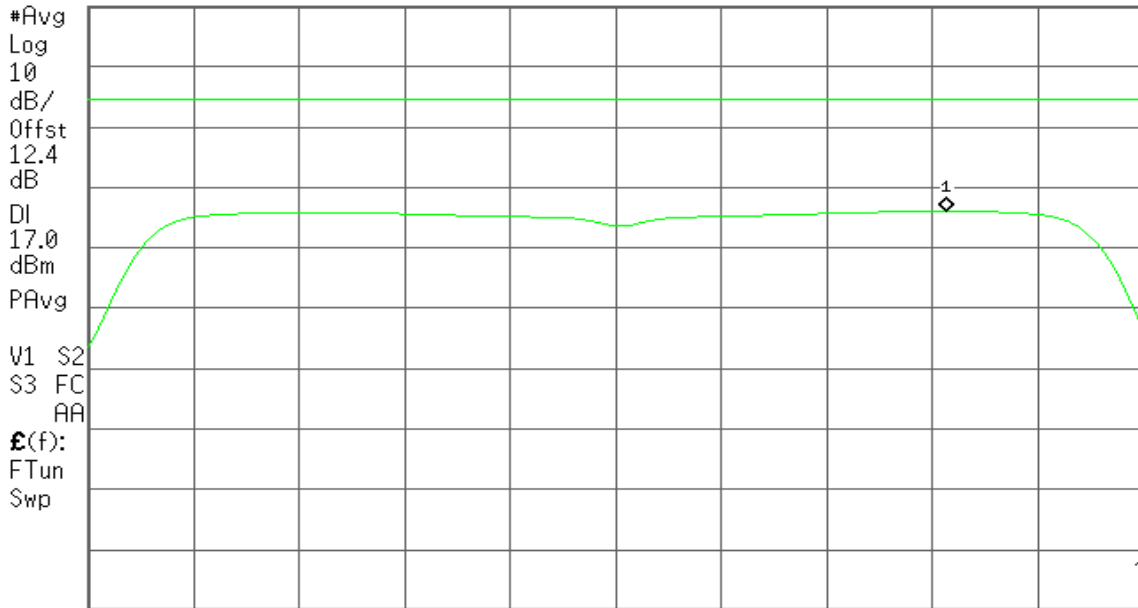

Center 5.240 00 GHz

#Res BW 1 MHz

#VBW 3 MHz

Span 20 MHz

#Sweep 6 s (601 pts)

### IEEE 802.11n HT 40 mode / 5190 ~ 5230MHz / Chain 0

### CH Low

Agilent

R T

Mkr1 5.191 60 GHz  
-7.03 dBm

Ref 32.4 dBm

#Atten 30 dB

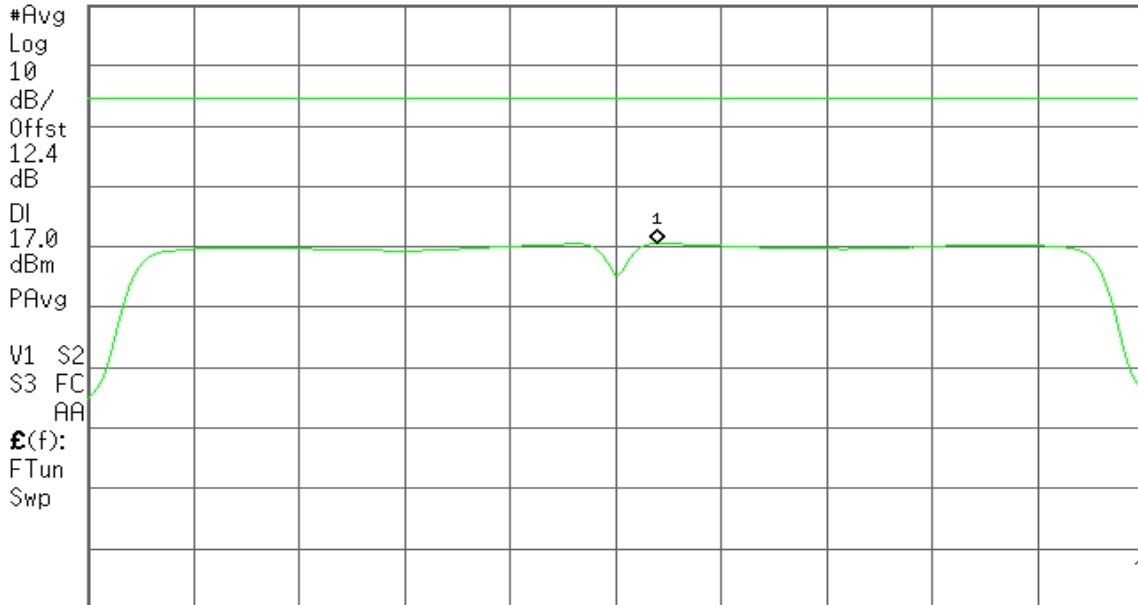

Center 5.190 00 GHz

#Res BW 1 MHz

#VBW 3 MHz

Span 40 MHz

#Sweep 6 s (601 pts)



### CH High

Agilent

R T

Mkr1 5.231 60 GHz  
-6.04 dBm

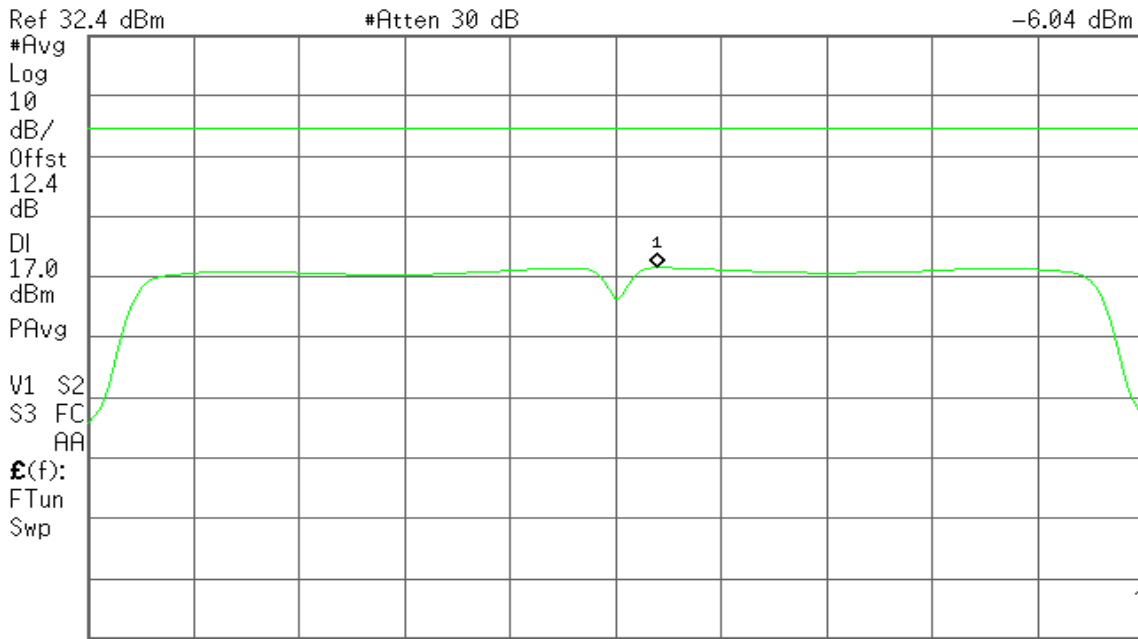

Center 5.230 00 GHz Span 40 MHz  
#Res BW 1 MHz #VBW 3 MHz #Sweep 6 s (601 pts)

### IEEE 802.11n HT 40 mode / 5190 ~ 5230MHz / Chain 1

### CH Low

Agilent

R T

Mkr1 5.191 67 GHz  
-3.66 dBm

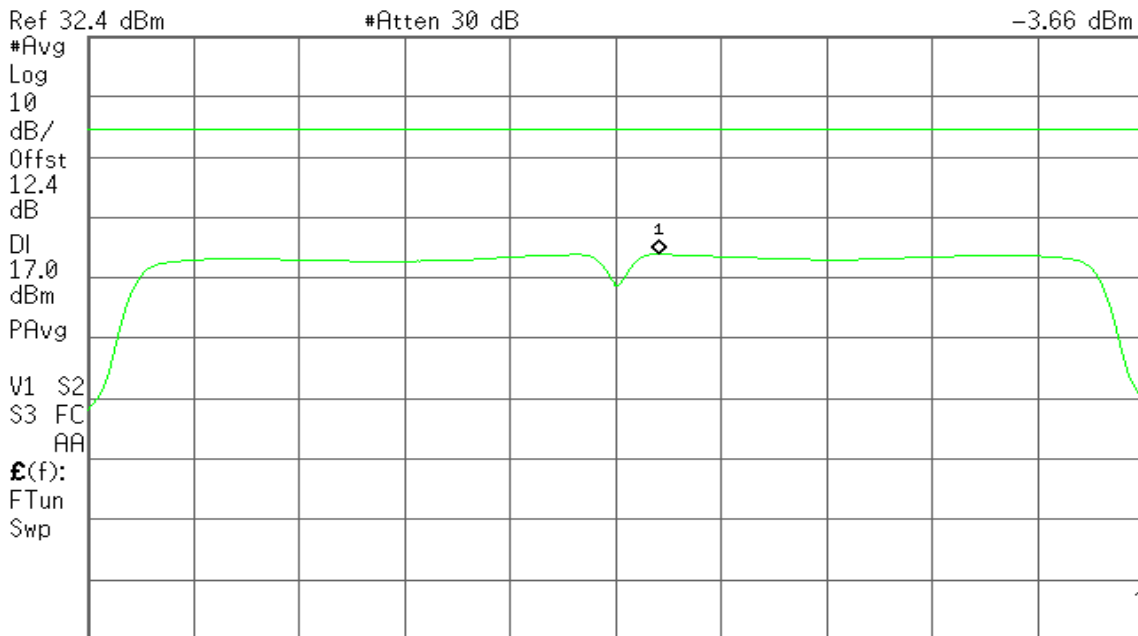

Center 5.190 00 GHz Span 40 MHz  
#Res BW 1 MHz #VBW 3 MHz #Sweep 6 s (601 pts)





### CH High

Agilent

R T

Mkr1 5.231 67 GHz  
-3.07 dBm

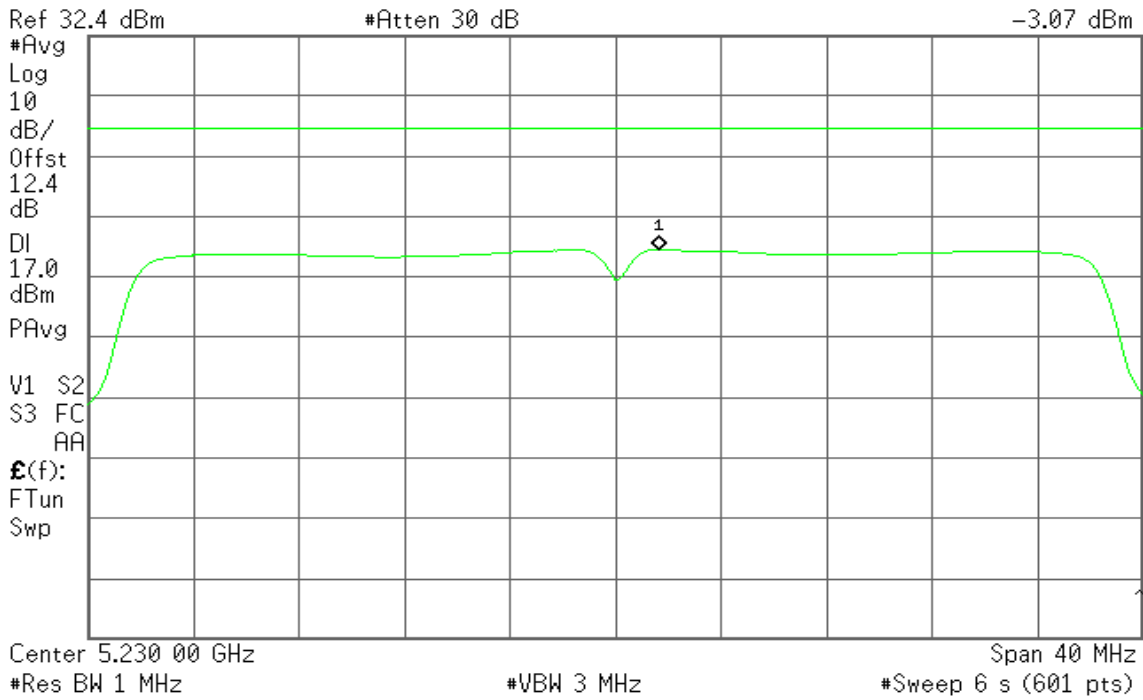

### IEEE 802.11n ac80 MHz mode / 5210MHz / Chain 0

#### CH Mid

Agilent

R T

Mkr1 5.218 93 GHz  
-4.18 dBm

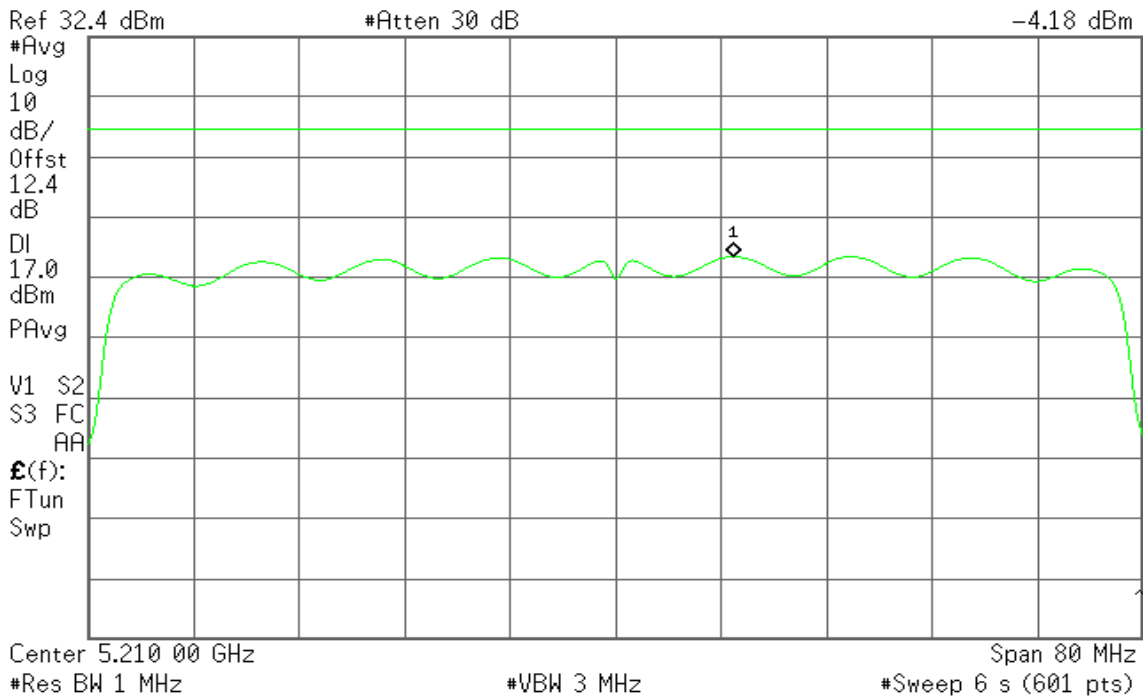



**IEEE 802.11n ac80 MHz mode / 5210MHz / Chain 1**

**CH Mid**

Agilent

R T

Mkr1 5.218 93 GHz  
-4.59 dBm

Ref 32.4 dBm

#Atten 30 dB

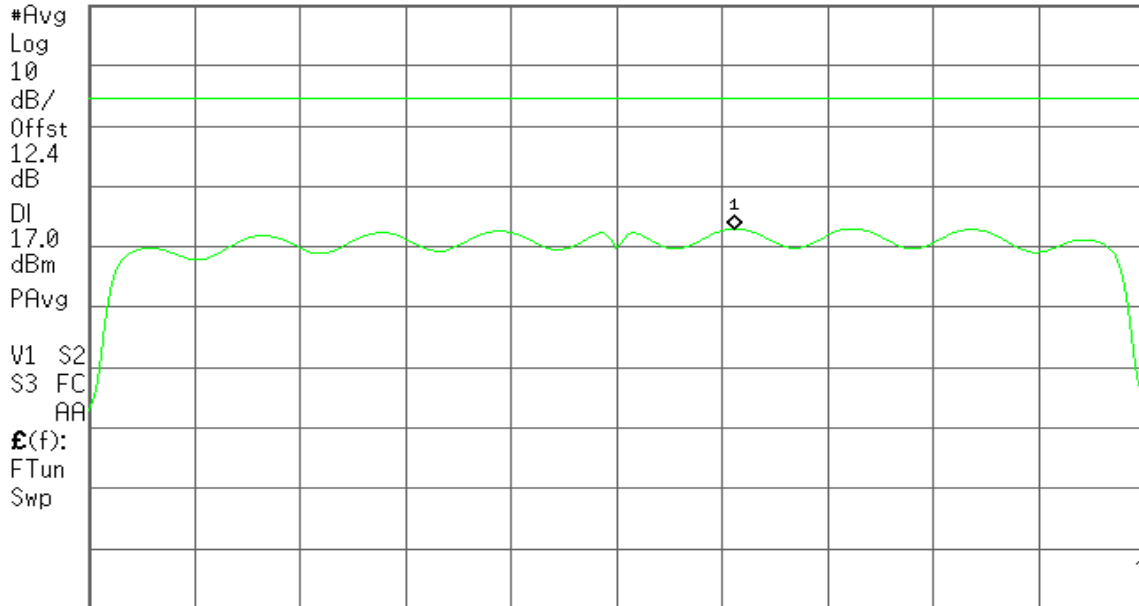

Center 5.210 00 GHz

Span 80 MHz

#Res BW 1 MHz

#VBW 3 MHz

#Sweep 6 s (601 pts)

**IEEE 802.11a mode / 5745 ~ 5825MHz**

**CH Low**

Agilent

R T

Mkr1 5.751 37 GHz  
-2.04 dBm

Ref 32.4 dBm

#Atten 30 dB

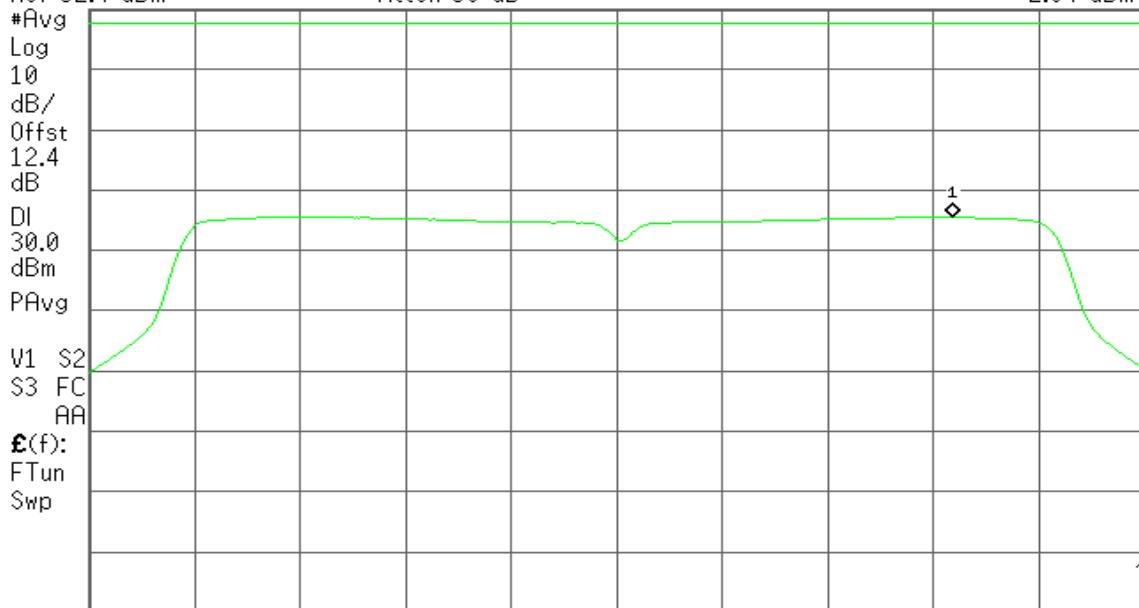

Center 5.745 00 GHz

Span 20 MHz

#Res BW 510 kHz

#VBW 1.6 MHz

#Sweep 6 s (601 pts)



### CH Mid

Agilent

R T

Mkr1 5.779 27 GHz  
-2.39 dBm

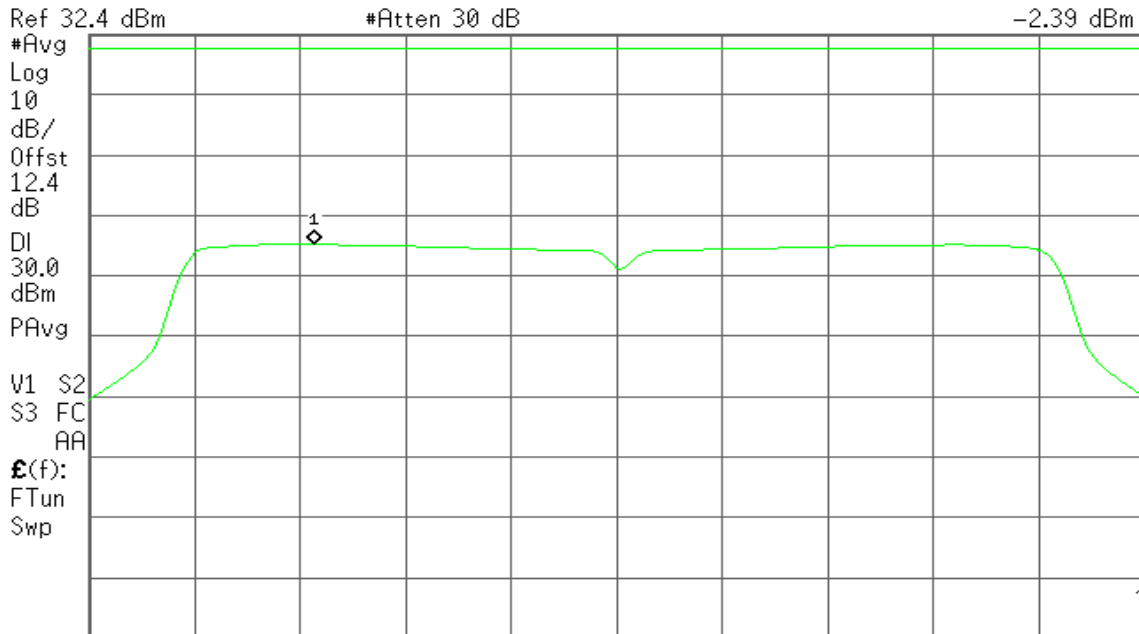

Center 5.785 00 GHz

Span 20 MHz

#Res BW 510 kHz

#VBW 1.6 MHz

#Sweep 6 s (601 pts)

### CH High

Agilent

R T

Mkr1 5.819 27 GHz  
-2.50 dBm

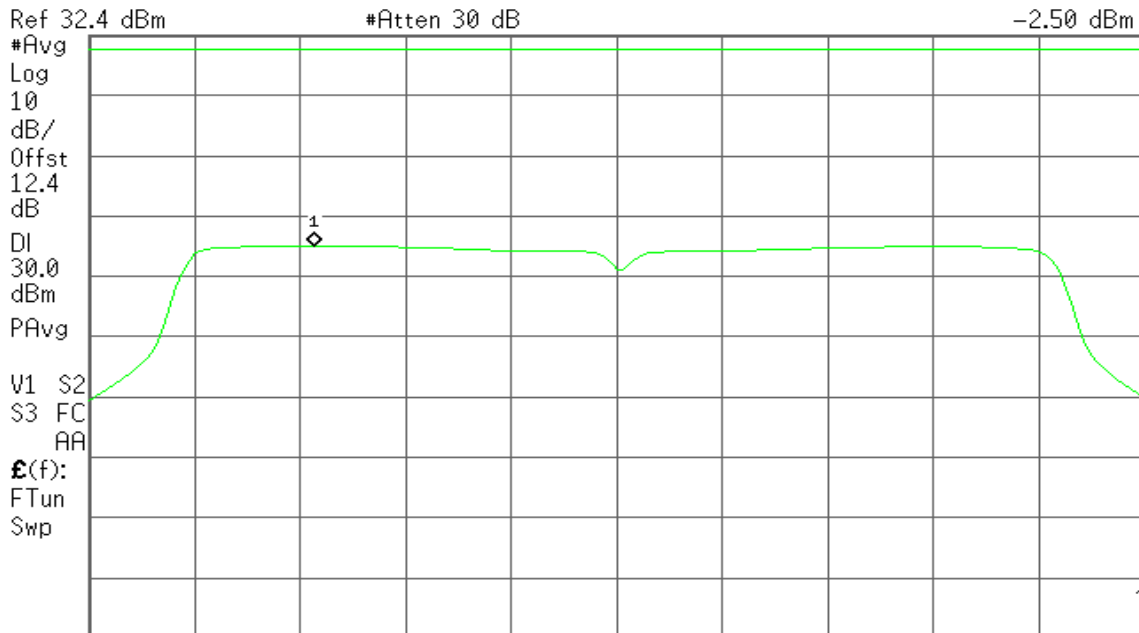

Center 5.825 00 GHz

Span 20 MHz

#Res BW 510 kHz

#VBW 1.6 MHz

#Sweep 6 s (601 pts)



**IEEE 802.11n HT 20 mode / 5745 ~ 5825MHz / Chain 0**

**CH Low**

Agilent

R T

Mkr1 5.738 73 GHz  
-3.71 dBm

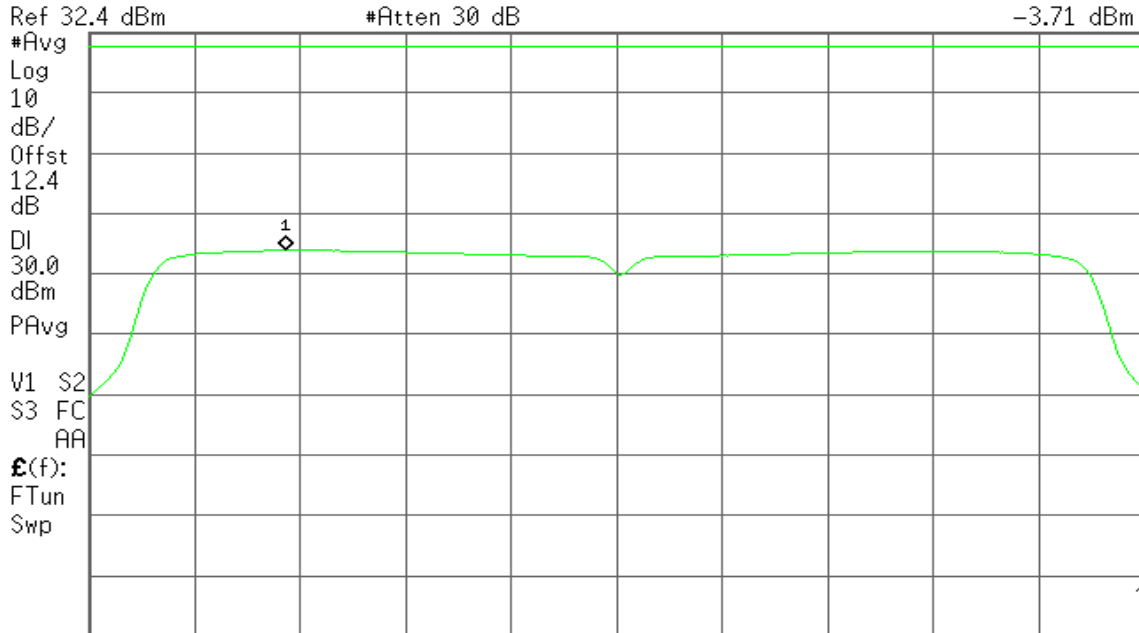

Center 5.745 00 GHz Span 20 MHz  
#Res BW 510 kHz #VBW 1.6 MHz #Sweep 6 s (601 pts)

**CH Mid**

Agilent

R T

Mkr1 5.778 73 GHz  
-4.30 dBm

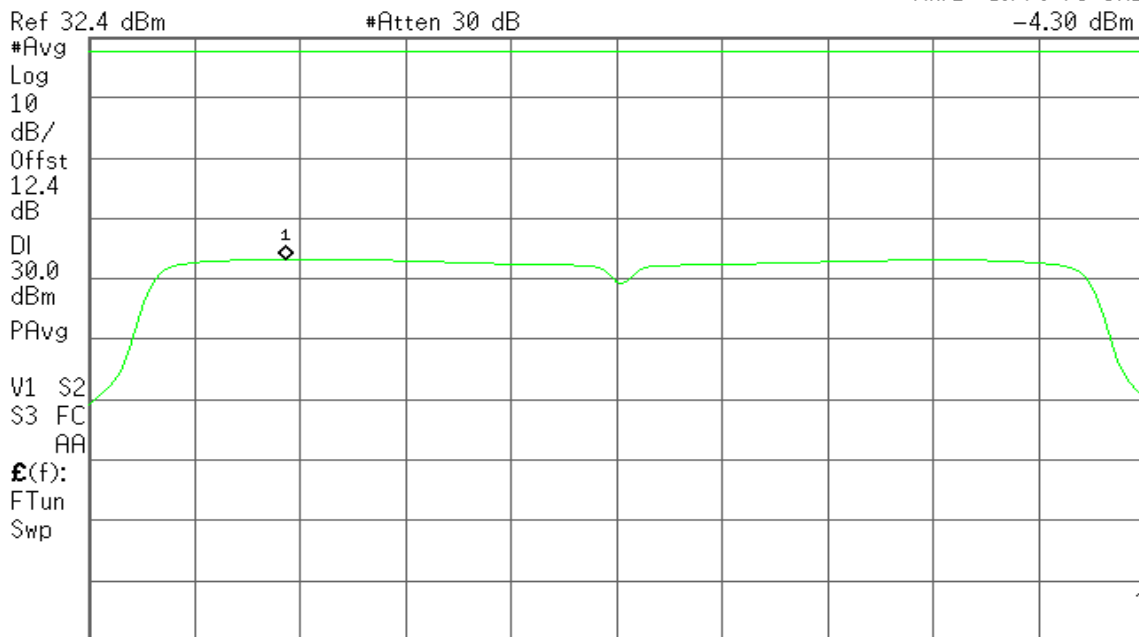

Center 5.785 00 GHz Span 20 MHz  
#Res BW 510 kHz #VBW 1.6 MHz #Sweep 6 s (601 pts)



### CH High

Agilent

R T

Mkr1 5.818 80 GHz  
-4.82 dBm

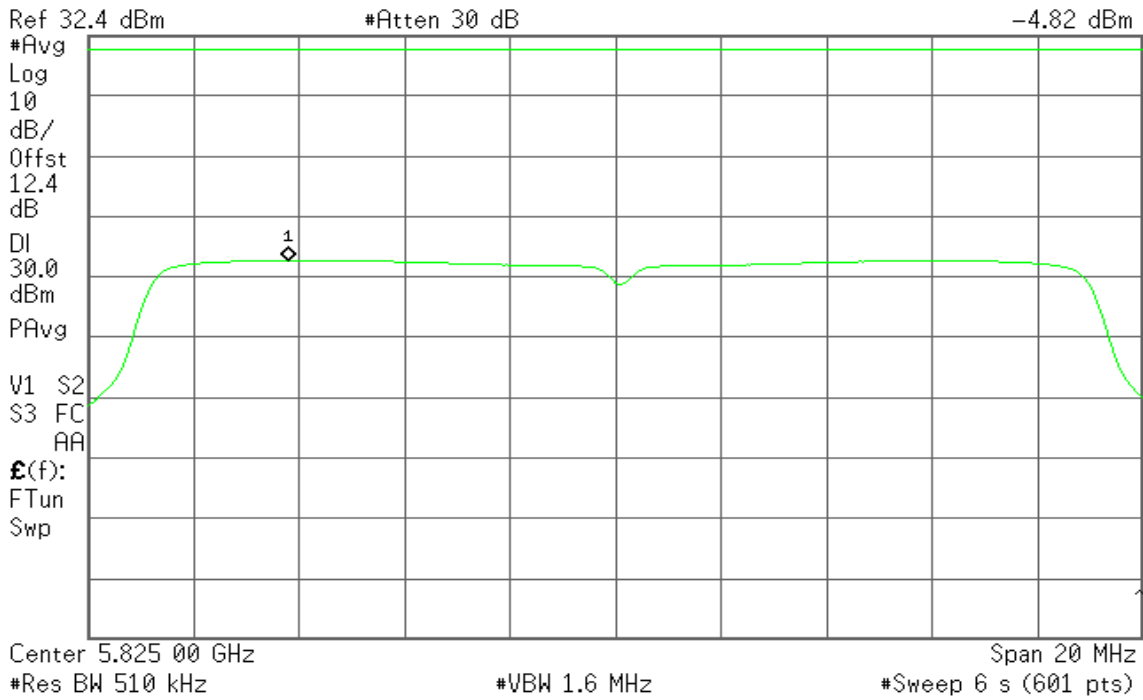

### IEEE 802.11n HT 20 mode / 5745 ~ 5825MHz / Chain 1

#### CH Low

Agilent

R T

Mkr1 5.739 33 GHz  
-3.02 dBm

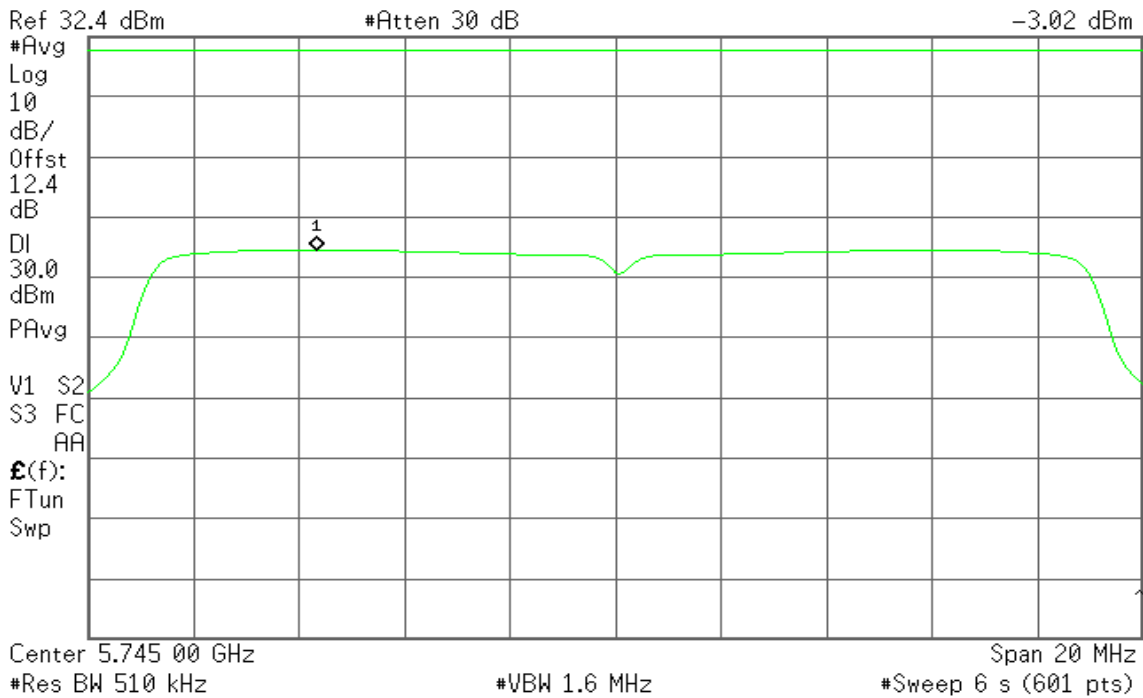



### CH Mid

Agilent

R T

Mkr1 5.790 90 GHz  
-2.95 dBm

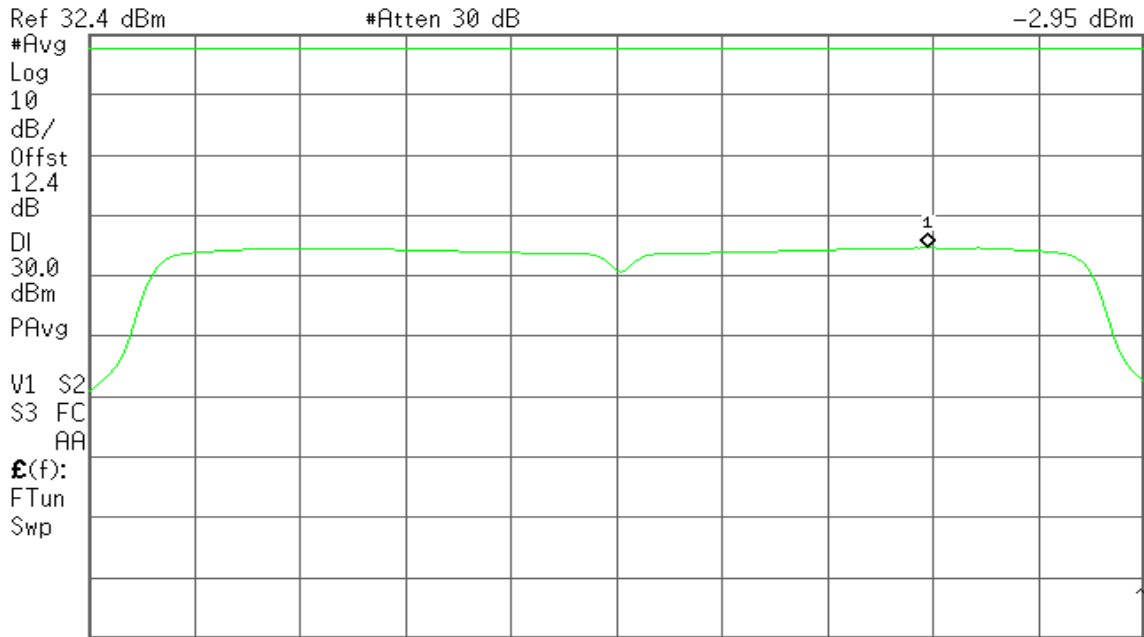

### CH High

Agilent

R T

Mkr1 5.830 93 GHz  
-2.24 dBm

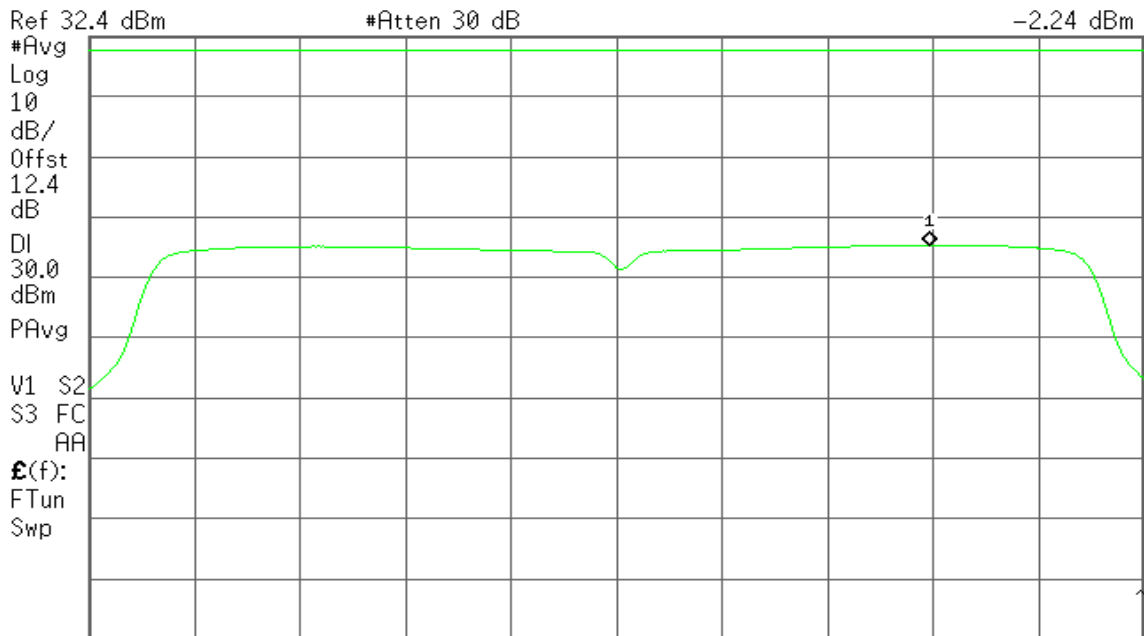



**IEEE 802.11n HT 40 mode / 5755 ~ 5795MHz / Chain 0**

**CH Low**

Agilent

R T

Mkr1 5.753 73 GHz  
-7.38 dBm

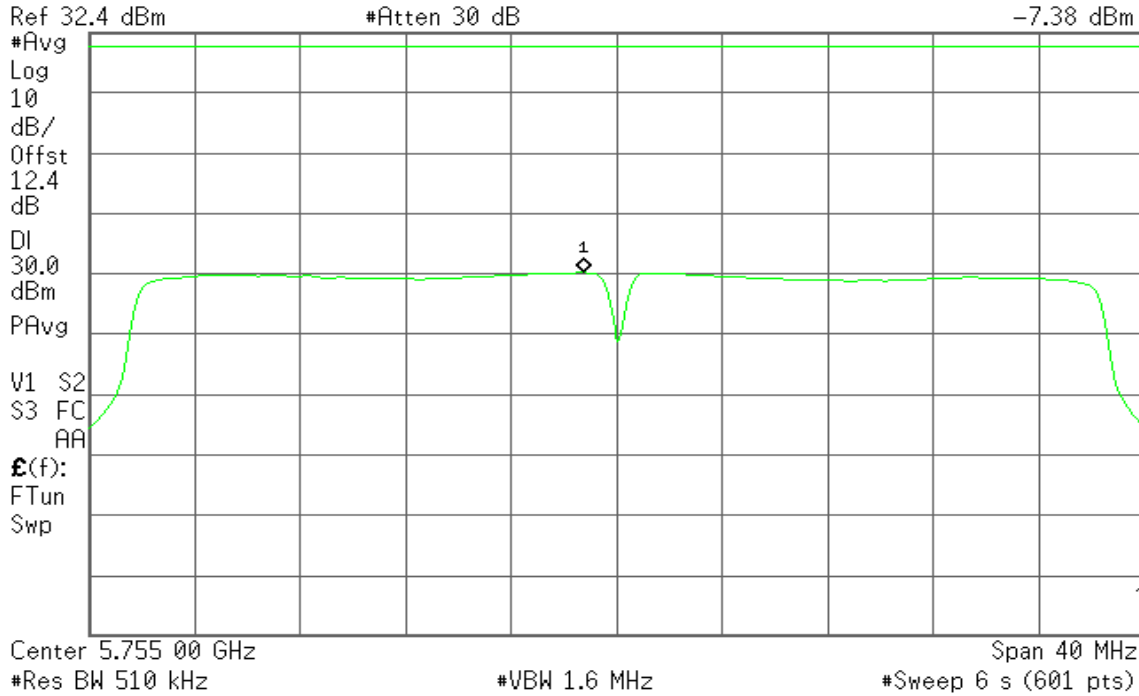

**CH High**

Agilent

R T

Mkr1 5.793 73 GHz  
-7.76 dBm

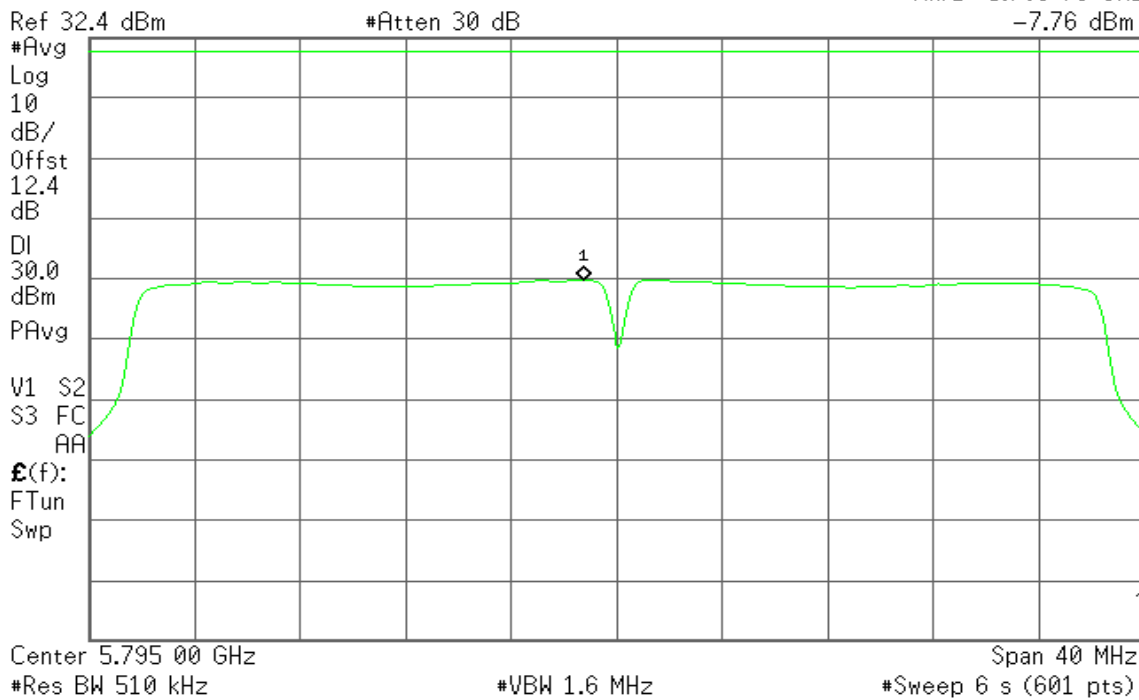



**IEEE 802.11n HT 40 mode / 5755 ~ 5795MHz / Chain 1**

**CH Low**

Agilent

R T

Mkr1 5.756 60 GHz  
-5.45 dBm

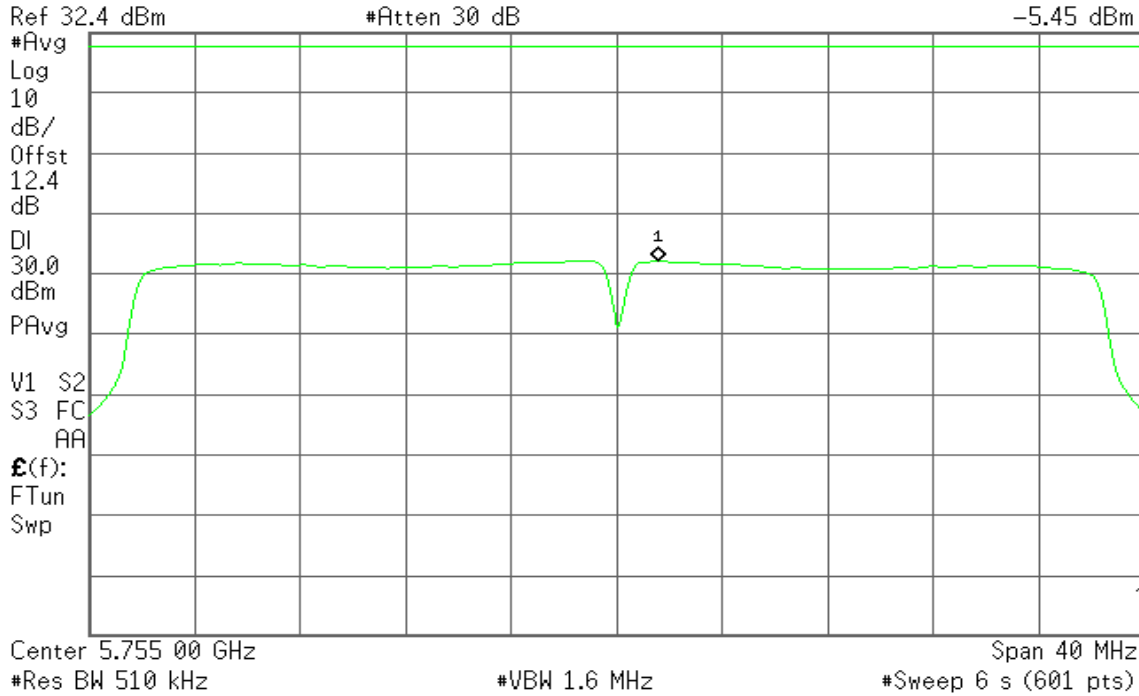

**CH High**

Agilent

R T

Mkr1 5.796 67 GHz  
-5.45 dBm

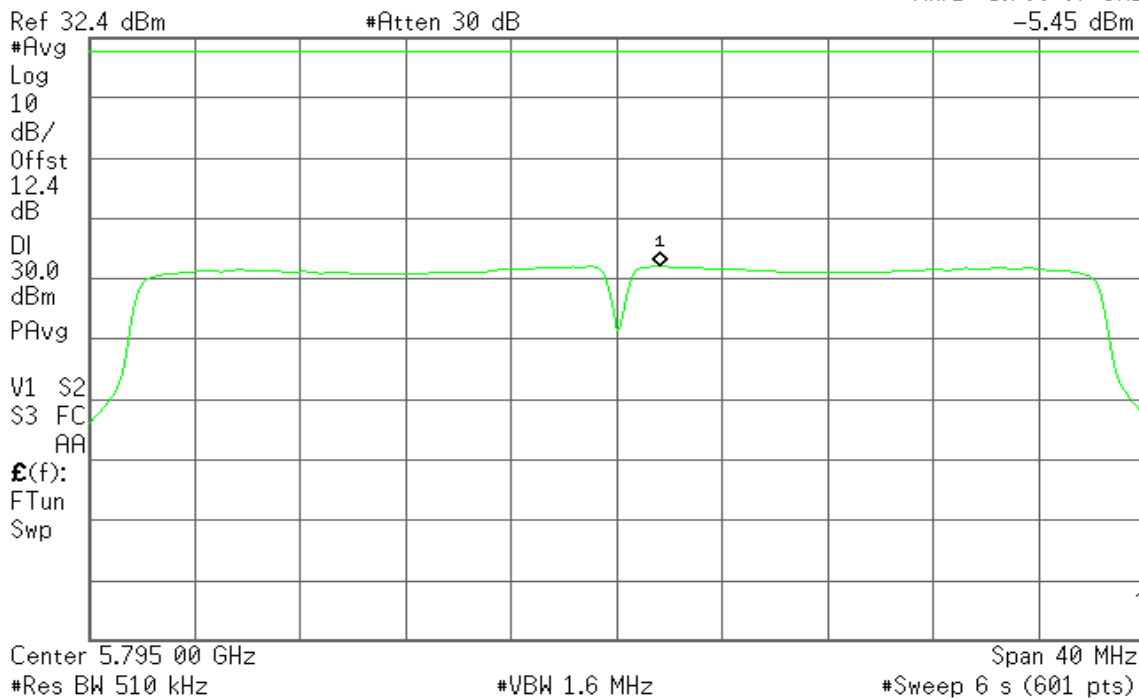





**IEEE 802.11n ac80 MHz mode / 5775MHz / Chain 0**

CH Mid

Agilent

R T

Mkr1 5.772 47 GHz  
-8.32 dBm

Ref 32.4 dBm

#Atten 30 dB

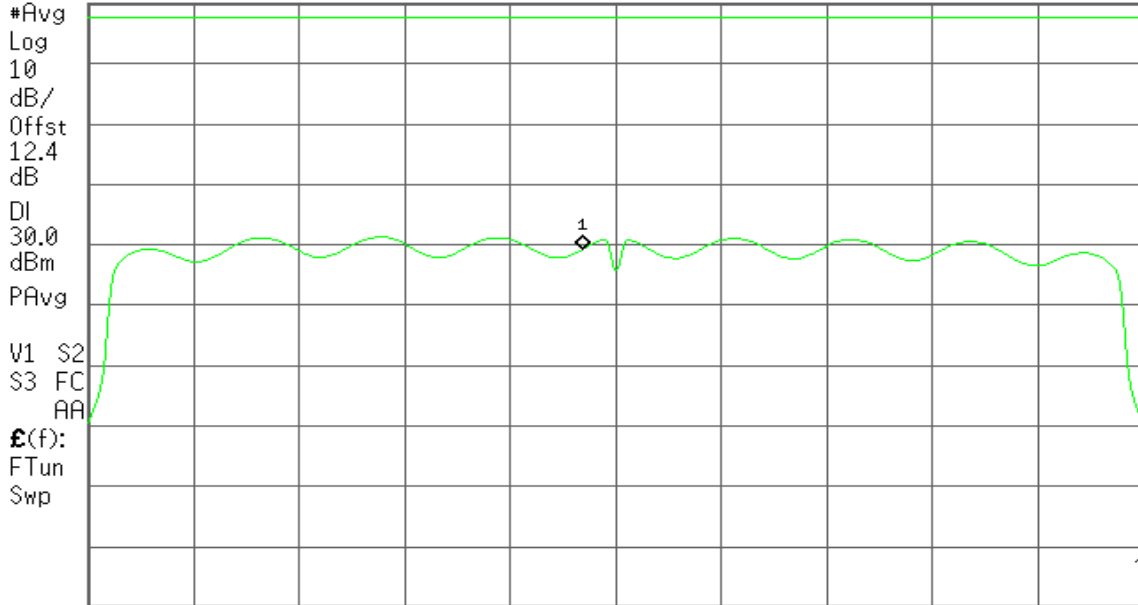

Center 5.775 00 GHz

#Res BW 510 kHz

#VBW 1.6 MHz

Span 80 MHz

#Sweep 6 s (601 pts)

**IEEE 802.11n ac80 MHz mode / 5775MHz / Chain 1**

CH Mid

Agilent

R T

Mkr1 5.784 07 GHz  
-8.33 dBm

Ref 32.4 dBm

#Atten 30 dB

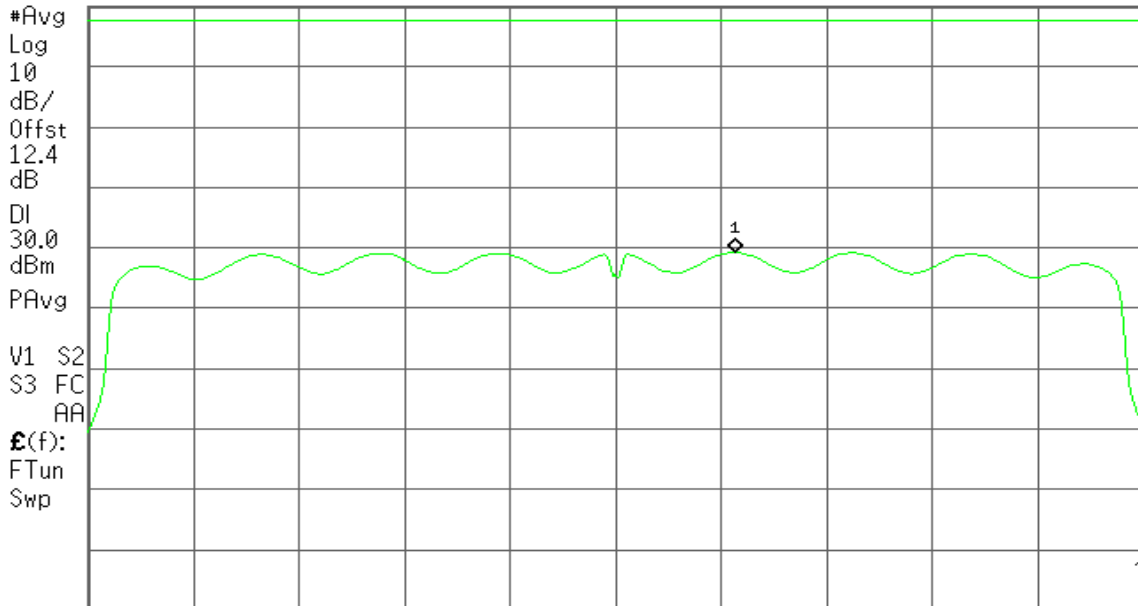

Center 5.775 00 GHz

#Res BW 510 kHz

#VBW 1.6 MHz

Span 80 MHz

#Sweep 6 s (601 pts)



### 7.6 RADIATED UNDESIRABLE EMISSION

1. According to §15.209(a), except as provided elsewhere in this Subpart, the emissions from an intentional radiator shall not exceed the field strength levels specified in the following table:

Frequency (MHz)	Field Strength (µV/m)	Measurement Distance (m)
0.009 - 0.490	2400/F(kHz)	300
0.490 - 1.705	24000/F(kHz)	30
1.705 – 30.0	30	30
30-88	100	3
88-216	150	3
216-960	200	3
Above 960	500	3

**Remark:** Except as provided in paragraph (g), fundamental emissions from intentional radiators operating under this Section shall not be located in the frequency bands 54-72 MHz, 76-88 MHz, 174-216 MHz or 470-806 MHz. However, operation within these frequency bands is permitted under other sections of this Part, e.g., Sections 15.231 and 15.241.

2. In the emission table above, the tighter limit applies at the band edges.

Frequency (MHz)	Field Strength (µV/m at 3-meter)	Field Strength (dBµV/m at 3-meter)
0.009 - 0.490	2400/F(kHz) +80	20LOG((2400/F(kHz))+80)
0.490 - 1.705	24000/F(kHz) +40	20LOG((24000/F(kHz))+40)
1.705 – 30.0	30	69.54
30-88	100	40
88-216	150	43.5
216-960	200	46
Above 960	500	54



### Test Configuration

#### 9kHz ~ 30MHz

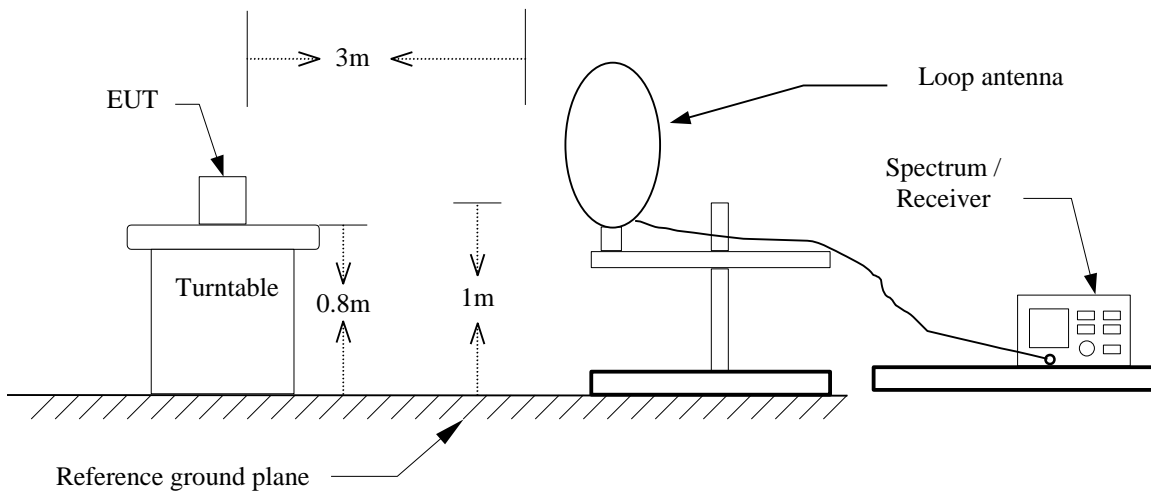

#### 30MHz ~ 1GHz

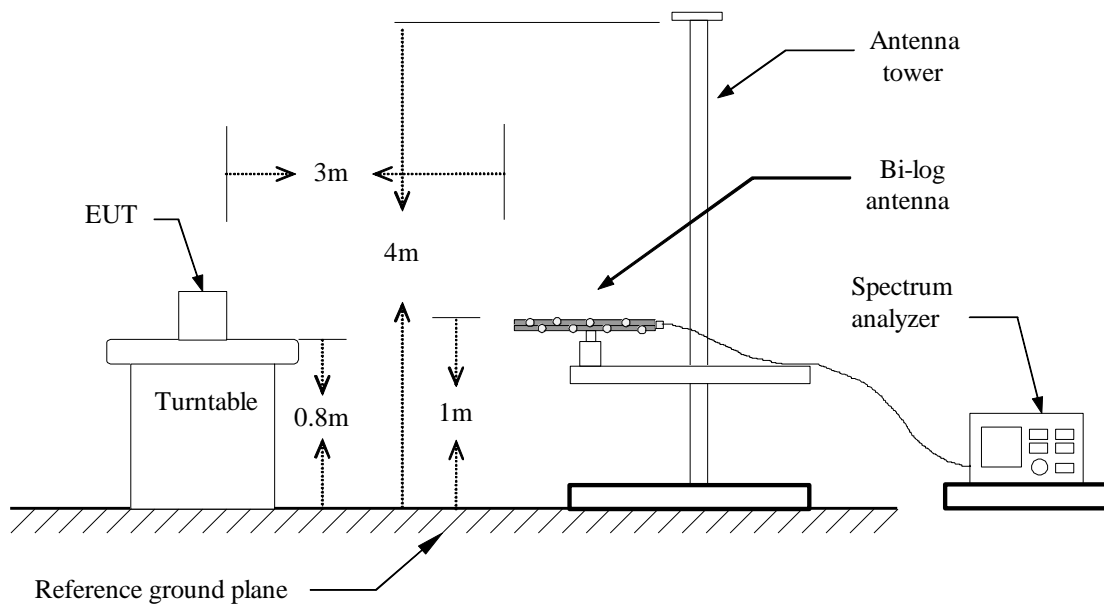



Above 1 GHz

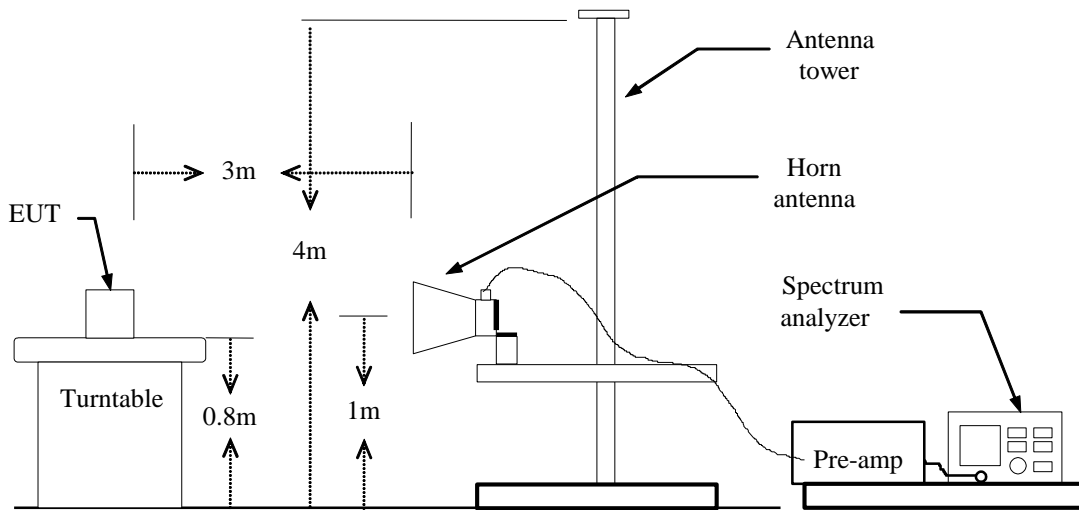



## **TEST PROCEDURE**

1. The EUT is placed on a turntable, which is 0.8m above ground plane.
2. The turntable shall be rotated for 360 degrees to determine the position of maximum emission level.
3. EUT is set 3m away from the receiving antenna, which is varied from 1m to 4m to find out the highest emissions.
4. Maximum procedure was performed on the six highest emissions to ensure EUT compliance.
5. And also, each emission was to be maximized by changing the polarization of receiving antenna both horizontal and vertical.
6. Set the spectrum analyzer in the following setting as:

Below 1GHz:

RBW=100kHz / VBW=300kHz / Sweep=AUTO

Above 1GHz:

(a) PEAK: RBW=VBW=1MHz / Sweep=AUTO

(b) AVERAGE: RBW=1MHz / VBW=300Hz / Sweep=AUTO

7. Repeat above procedures until the measurements for all frequencies are complete.

**Below 1 GHz****Operation Mode:** Normal Link**Test Date:** October 6, 2014**Temperature:** 27°C**Tested by:** Andy Shi**Humidity:** 53% RH**Polarity:** Ver. / Hor.

Frequency (MHz)	Reading (dBuV)	Correction Factor (dB/m)	Result (dBuV/m)	Limit (dBuV/m)	Margin (dB)	Remark	Ant.Pol. (H/V)
44.5500	51.46	-19.79	31.67	40.00	-8.33	peak	V
103.7200	49.32	-20.26	29.06	43.50	-14.44	peak	V
196.8400	49.57	-17.82	31.75	43.50	-11.75	peak	V
353.9800	49.97	-15.10	34.87	46.00	-11.13	peak	V
665.3500	38.78	-9.15	29.63	46.00	-16.37	peak	V
830.2500	39.48	-7.02	32.46	46.00	-13.54	peak	V
57.1600	52.73	-23.64	29.09	40.00	-10.91	peak	H
124.0900	46.24	-17.44	28.80	43.50	-14.70	peak	H
204.6000	52.15	-17.87	34.28	43.50	-9.22	peak	H
348.1600	50.87	-15.23	35.64	46.00	-10.36	peak	H
709.9700	36.27	-8.61	27.66	46.00	-18.34	peak	H
833.1600	44.15	-6.98	37.17	46.00	-8.83	peak	H

**Remark:**

1. No emission found between lowest internal used/generated frequency to 30MHz (9kHz~30MHz)
2. Radiated emissions measured in frequency range from 30 MHz to 1000MHz were made with an instrument using peak/quasi-peak detector mode.
3. Quasi-peak test would be performed if the peak result were greater than the quasi-peak limit.
4. Data of measurement within this frequency range shown " --- " in the table above means the reading of emissions are attenuated more than 20dB below the permissible limits or the field strength is too small to be measured.
5. Measurements above show only up to 6 maximum emissions noted, or would be lesser, with " N/A " remark, if no specific emissions from the EUT are recorded (ie: margin>20dB from the applicable limit) and considered that's already beyond the background noise floor.
6. Margin (dB) = Remark result (dBuV/m) – Quasi-peak limit (dBuV/m).



**Above 1 GHz**

**Operation Mode:** Tx / IEEE 802.11a mode / 5180 ~ 5240MHz / CH Low      **Test Date:** October 7, 2014

**Temperature:** 27°C      **Tested by:** Andy Shi

**Humidity:** 53% RH      **Polarity:** Ver. / Hor.

Frequency (MHz)	Reading (dBuV)	Correction (dB/m)	Result (dBuV/m)	Limit (dBuV/m)	Margin (dB)	Remark	Ant.Pol. (H/V)
1994.000	52.65	-4.91	47.74	74.00	-26.26	peak	V
N/A							
2001.000	52.07	-4.99	47.08	74.00	-26.92	peak	H
N/A							

**Remark:**

1. Measuring frequencies from 1 GHz to the 10th harmonic of highest fundamental frequency.
2. Radiated emissions measured in frequency above 1000MHz were made with an instrument using peak/average detector mode.
3. Average test would be performed if the peak result were greater than the average limit.
4. Data of measurement within this frequency range shown " --- " in the table above means the reading of emissions are attenuated more than 20dB below the permissible limits or the field strength is too small to be measured.
5. Measurements above show only up to 6 maximum emissions noted, or would be lesser, with " N/A " remark, if no specific emissions from the EUT are recorded (ie: margin>20dB from the applicable limit) and considered that's already beyond the background noise floor.
6.  $Margin (dB) = Remark\ result (dBuV/m) - Average\ limit (dBuV/m).$



**Operation Mode:** Tx / IEEE 802.11a mode / 5180 ~ 5240MHz /CH Mid      **Test Date:** October 7, 2014  
**Temperature:** 27°C      **Tested by:** Andy Shi  
**Humidity:** 53% RH      **Polarity:** Ver. / Hor.

Frequency (MHz)	Reading (dBuV)	Correction (dB/m)	Result (dBuV/m)	Limit (dBuV/m)	Margin (dB)	Remark	Ant.Pol. (H/V)
1196.000	59.31	-9.98	49.33	74.00	-24.67	peak	V
1595.000	56.90	-7.48	49.42	74.00	-24.58	peak	V
1791.000	56.87	-6.27	50.60	74.00	-23.40	peak	V
2421.000	53.97	-3.67	50.30	74.00	-23.70	peak	V
N/A							
1595.000	57.26	-7.48	49.78	74.00	-24.22	peak	H
N/A							

**Remark:**

1. Measuring frequencies from 1 GHz to the 10th harmonic of highest fundamental frequency.
2. Radiated emissions measured in frequency above 1000MHz were made with an instrument using peak/average detector mode.
3. Average test would be performed if the peak result were greater than the average limit.
4. Data of measurement within this frequency range shown “ --- ” in the table above means the reading of emissions are attenuated more than 20dB below the permissible limits or the field strength is too small to be measured.
5. Measurements above show only up to 6 maximum emissions noted, or would be lesser, with “ N/A ” remark, if no specific emissions from the EUT are recorded (ie: margin>20dB from the applicable limit) and considered that's already beyond the background noise floor.
6. Margin (dB) = Remark result (dBuV/m) – Average limit (dBuV/m).





Operation Mode: Tx / IEEE 802.11a mode / 5180 ~ 5240MHz /CH High

Test Date: October 7, 2014

Temperature: 27°C

Tested by: Andy Shi

Humidity: 53% RH

Polarity: Ver. / Hor.

Frequency (MHz)	Reading (dBuV)	Correction (dB/m)	Result (dBuV/m)	Limit (dBuV/m)	Margin (dB)	Remark	Ant.Pol. (H/V)
1196.000	57.70	-9.98	47.72	74.00	-26.28	peak	V
1798.000	55.62	-6.23	49.39	74.00	-24.61	peak	V
1994.000	53.96	-5.03	48.93	74.00	-25.07	peak	V
10490.000	41.47	14.94	56.41	74.00	-17.59	peak	V
10490.000	30.20	14.94	45.14	54.00	-8.86	AVG	V
N/A							
1602.000	56.68	-7.43	49.25	74.00	-24.75	peak	H
N/A							

Remark:

1. Measuring frequencies from 1 GHz to the 10th harmonic of highest fundamental frequency.
2. Radiated emissions measured in frequency above 1000MHz were made with an instrument using peak/average detector mode.
3. Average test would be performed if the peak result were greater than the average limit.
4. Data of measurement within this frequency range shown “ --- ” in the table above means the reading of emissions are attenuated more than 20dB below the permissible limits or the field strength is too small to be measured.
5. Measurements above show only up to 6 maximum emissions noted, or would be lesser, with “ N/A ” remark, if no specific emissions from the EUT are recorded (ie: margin>20dB from the applicable limit) and considered that's already beyond the background noise floor.
6. Margin (dB) = Remark result (dBuV/m) – Average limit (dBuV/m).



Operation Mode: Tx / IEEE 802.11n HT 20 mode / 5180 ~ 5240MHz / CH Low

Test Date: October 7, 2014

Temperature: 27°C

Tested by: Andy Shi

Humidity: 53% RH

Polarity: Ver. / Hor.

Frequency (MHz)	Reading (dBuV)	Correction (dB/m)	Result (dBuV/m)	Limit (dBuV/m)	Margin (dB)	Remark	Ant.Pol. (H/V)
4157.000	50.84	1.82	52.66	74.00	-21.34	peak	V
N/A							
1511.000	54.46	-7.99	46.47	74.00	-27.53	peak	H
N/A							

Remark:

1. Measuring frequencies from 1 GHz to the 10th harmonic of highest fundamental frequency.
2. Radiated emissions measured in frequency above 1000MHz were made with an instrument using peak/average detector mode.
3. Average test would be performed if the peak result were greater than the average limit.
4. Data of measurement within this frequency range shown “ --- ” in the table above means the reading of emissions are attenuated more than 20dB below the permissible limits or the field strength is too small to be measured.
5. Measurements above show only up to 6 maximum emissions noted, or would be lesser, with “ N/A ” remark, if no specific emissions from the EUT are recorded (ie: margin>20dB from the applicable limit) and considered that's already beyond the background noise floor.
6. Margin (dB) = Remark result (dBuV/m) – Average limit (dBuV/m).



Operation Mode: Tx / IEEE 802.11n HT 20 mode / 5180 ~ 5240MHz / CH Mid

Test Date: October 7, 2014

Temperature: 27°C

Tested by: Andy Shi

Humidity: 53% RH

Polarity: Ver. / Hor.

Frequency (MHz)	Reading (dBuV)	Correction (dB/m)	Result (dBuV/m)	Limit (dBuV/m)	Margin (dB)	Remark	Ant.Pol. (H/V)
1196.000	59.35	-9.98	49.37	74.00	-24.63	peak	V
1595.000	57.30	-7.48	49.82	74.00	-24.18	peak	V
1798.000	55.91	-6.23	49.68	74.00	-24.32	peak	V
1994.000	53.67	-5.03	48.64	74.00	-25.36	peak	V
N/A							
1595.000	60.89	-7.48	53.41	74.00	-20.59	peak	H
1595.000	45.57	-7.48	38.09	54.00	-15.91	AVG	H
N/A							

Remark:

1. Measuring frequencies from 1 GHz to the 10th harmonic of highest fundamental frequency.
2. Radiated emissions measured in frequency above 1000MHz were made with an instrument using peak/average detector mode.
3. Average test would be performed if the peak result were greater than the average limit.
4. Data of measurement within this frequency range shown “ --- ” in the table above means the reading of emissions are attenuated more than 20dB below the permissible limits or the field strength is too small to be measured.
5. Measurements above show only up to 6 maximum emissions noted, or would be lesser, with “ N/A ” remark, if no specific emissions from the EUT are recorded (ie: margin>20dB from the applicable limit) and considered that's already beyond the background noise floor.
6. Margin (dB) = Remark result (dBuV/m) – Average limit (dBuV/m).



Operation Mode: Tx / IEEE 802.11n HT 20 mode / 5180 ~ 5240MHz / CH High

Test Date: October 7, 2014

Temperature: 27°C

Tested by: Andy Shi

Humidity: 53% RH

Polarity: Ver. / Hor.

Frequency (MHz)	Reading (dBuV)	Correction (dB/m)	Result (dBuV/m)	Limit (dBuV/m)	Margin (dB)	Remark	Ant.Pol. (H/V)
1196.000	59.25	-9.98	49.27	74.00	-24.73	peak	V
1399.000	57.69	-8.70	48.99	74.00	-25.01	peak	V
1595.000	57.28	-7.48	49.80	74.00	-24.20	peak	V
1798.000	56.52	-6.23	50.29	74.00	-23.71	peak	V
1994.000	54.60	-5.03	49.57	74.00	-24.43	peak	V
N/A							
1595.000	57.66	-7.48	50.18	74.00	-23.82	peak	H
N/A							

Remark:

1. Measuring frequencies from 1 GHz to the 10th harmonic of highest fundamental frequency.
2. Radiated emissions measured in frequency above 1000MHz were made with an instrument using peak/average detector mode.
3. Average test would be performed if the peak result were greater than the average limit.
4. Data of measurement within this frequency range shown “ --- ” in the table above means the reading of emissions are attenuated more than 20dB below the permissible limits or the field strength is too small to be measured.
5. Measurements above show only up to 6 maximum emissions noted, or would be lesser, with “ N/A ” remark, if no specific emissions from the EUT are recorded (ie: margin>20dB from the applicable limit) and considered that's already beyond the background noise floor.
6. Margin (dB) = Remark result (dBuV/m) – Average limit (dBuV/m).



**Operation Mode:** Tx / IEEE 802.11n HT 40 mode / 5190 ~ 5230MHz / CH Low

**Test Date:** October 7, 2014

**Temperature:** 27°C

**Tested by:** Andy Shi

**Humidity:** 53% RH

**Polarity:** Ver. / Hor.

Frequency (MHz)	Reading (dBuV)	Correction (dB/m)	Result (dBuV/m)	Limit (dBuV/m)	Margin (dB)	Remark	Ant.Pol. (H/V)
1203.000	58.14	-9.93	48.21	74.00	-25.79	peak	V
1798.000	55.82	-6.23	49.59	74.00	-24.41	peak	V
N/A							
1238.000	53.27	-9.71	43.56	74.00	-30.44	peak	H
N/A							

**Remark:**

1. Measuring frequencies from 1 GHz to the 10th harmonic of highest fundamental frequency.
2. Radiated emissions measured in frequency above 1000MHz were made with an instrument using peak/average detector mode.
3. Average test would be performed if the peak result were greater than the average limit.
4. Data of measurement within this frequency range shown “ --- ” in the table above means the reading of emissions are attenuated more than 20dB below the permissible limits or the field strength is too small to be measured.
5. Measurements above show only up to 6 maximum emissions noted, or would be lesser, with “ N/A ” remark, if no specific emissions from the EUT are recorded (ie: margin>20dB from the applicable limit) and considered that's already beyond the background noise floor.
6. Margin (dB) = Remark result (dBuV/m) – Average limit (dBuV/m).



**Operation Mode:** Tx / IEEE 802.11n HT 40 mode / 5190 ~ 5230MHz / CH High

**Test Date:** October 7, 2014

**Temperature:** 27°C

**Tested by:** Andy Shi

**Humidity:** 53% RH

**Polarity:** Ver. / Hor.

Frequency (MHz)	Reading (dBuV)	Correction (dB/m)	Result (dBuV/m)	Limit (dBuV/m)	Margin (dB)	Remark	Ant.Pol. (H/V)
1595.000	55.80	-7.48	48.32	74.00	-25.68	peak	V
1980.000	54.82	-5.11	49.71	74.00	-24.29	peak	V
2421.000	52.90	-3.67	49.23	74.00	-24.77	peak	V
N/A							
1602.000	58.61	-7.43	51.18	74.00	-22.82	peak	H
1602.000	43.01	-7.43	35.58	54.00	-18.42	AVG	H
N/A							

**Remark:**

1. Measuring frequencies from 1 GHz to the 10th harmonic of highest fundamental frequency.
2. Radiated emissions measured in frequency above 1000MHz were made with an instrument using peak/average detector mode.
3. Average test would be performed if the peak result were greater than the average limit.
4. Data of measurement within this frequency range shown “ --- ” in the table above means the reading of emissions are attenuated more than 20dB below the permissible limits or the field strength is too small to be measured.
5. Measurements above show only up to 6 maximum emissions noted, or would be lesser, with “ N/A ” remark, if no specific emissions from the EUT are recorded (ie: margin>20dB from the applicable limit) and considered that's already beyond the background noise floor.
6. Margin (dB) = Remark result (dBuV/m) – Average limit (dBuV/m).



**Operation Mode:** Tx / IEEE 802.11 ac80 mode / 5210MHz

**Test Date:** October 7, 2014

**Temperature:** 27°C

**Tested by:** Andy Shi

**Humidity:** 53% RH

**Polarity:** Ver. / Hor.

Frequency (MHz)	Reading (dBuV)	Correction (dB/m)	Result (dBuV/m)	Limit (dBuV/m)	Margin (dB)	Remark	Ant.Pol. (H/V)
1994.000	52.67	-4.91	47.76	74.00	-26.24	peak	V
N/A							
2400.000	51.91	-3.69	48.22	74.00	-25.78	peak	H
N/A							

**Remark:**

1. Measuring frequencies from 1 GHz to the 10th harmonic of highest fundamental frequency.
2. Radiated emissions measured in frequency above 1000MHz were made with an instrument using peak/average detector mode.
3. Average test would be performed if the peak result were greater than the average limit.
4. Data of measurement within this frequency range shown “ --- ” in the table above means the reading of emissions are attenuated more than 20dB below the permissible limits or the field strength is too small to be measured.
5. Measurements above show only up to 6 maximum emissions noted, or would be lesser, with “ N/A ” remark, if no specific emissions from the EUT are recorded (ie: margin>20dB from the applicable limit) and considered that's already beyond the background noise floor.
6.  $Margin (dB) = Remark\ result (dBuV/m) - Average\ limit (dBuV/m)$ .



**Operation Mode:** Tx / IEEE 802.11a mode / 5745 ~ 5825MHz / CH Low      **Test Date:** October 7, 2014  
**Temperature:** 27°C      **Tested by:** Andy Shi  
**Humidity:** 53% RH      **Polarity:** Ver. / Hor.

Frequency (MHz)	Reading (dBuV)	Correction (dB/m)	Result (dBuV/m)	Limit (dBuV/m)	Margin (dB)	Remark	Ant.Pol. (H/V)
1196.000	58.98	-9.98	49.00	74.00	-25.00	peak	V
1798.000	55.64	-6.23	49.41	74.00	-24.59	peak	V
11490.000	43.28	15.30	58.58	74.00	-15.42	peak	V
11490.000	29.30	15.30	44.60	54.00	-9.40	AVG	V
N/A							
1595.000	56.40	-7.48	48.92	74.00	-25.08	peak	H
2001.000	54.73	-4.99	49.74	74.00	-24.26	peak	H
11500.000	42.61	15.30	57.91	74.00	-16.09	peak	H
11500.000	31.20	15.30	46.50	54.00	-7.50	AVG	H
N/A							

**Remark:**

1. Measuring frequencies from 1 GHz to the 10th harmonic of highest fundamental frequency.
2. Radiated emissions measured in frequency above 1000MHz were made with an instrument using peak/average detector mode.
3. Average test would be performed if the peak result were greater than the average limit.
4. Data of measurement within this frequency range shown “ --- ” in the table above means the reading of emissions are attenuated more than 20dB below the permissible limits or the field strength is too small to be measured.
5. Measurements above show only up to 6 maximum emissions noted, or would be lesser, with “ N/A ” remark, if no specific emissions from the EUT are recorded (ie: margin>20dB from the applicable limit) and considered that's already beyond the background noise floor.
6. Margin (dB) = Remark result (dBuV/m) – Average limit (dBuV/m).





**Operation Mode:** Tx / IEEE 802.11a mode / 5745 ~ 5825MHz /CH Mid **Test Date:** October 7, 2014  
**Temperature:** 27°C **Tested by:** Andy Shi  
**Humidity:** 53% RH **Polarity:** Ver. / Hor.

Frequency (MHz)	Reading (dBuV)	Correction (dB/m)	Result (dBuV/m)	Limit (dBuV/m)	Margin (dB)	Remark	Ant.Pol. (H/V)
1595.000	57.33	-7.48	49.85	74.00	-24.15	peak	V
1798.000	56.86	-6.23	50.63	74.00	-23.37	peak	V
2435.000	53.84	-3.60	50.24	74.00	-23.76	peak	V
11570.000	43.44	15.30	58.74	74.00	-15.26	peak	V
11570.000	30.40	15.30	45.70	54.00	-8.30	AVG	V
N/A							
1595.000	57.93	-7.48	50.45	74.00	-23.55	peak	H
N/A							

**Remark:**

1. Measuring frequencies from 1 GHz to the 10th harmonic of highest fundamental frequency.
2. Radiated emissions measured in frequency above 1000MHz were made with an instrument using peak/average detector mode.
3. Average test would be performed if the peak result were greater than the average limit.
4. Data of measurement within this frequency range shown “ --- ” in the table above means the reading of emissions are attenuated more than 20dB below the permissible limits or the field strength is too small to be measured.
5. Measurements above show only up to 6 maximum emissions noted, or would be lesser, with “ N/A ” remark, if no specific emissions from the EUT are recorded (ie: margin>20dB from the applicable limit) and considered that's already beyond the background noise floor.
6. Margin (dB) = Remark result (dBuV/m) – Average limit (dBuV/m).



**Operation Mode:** Tx / IEEE 802.11a mode / 5745 ~ 5825MHz /CH High

**Test Date:** October 7, 2014

**Temperature:** 27°C

**Tested by:** Andy Shi

**Humidity:** 53% RH

**Polarity:** Ver. / Hor.

Frequency (MHz)	Reading (dBuV)	Correction (dB/m)	Result (dBuV/m)	Limit (dBuV/m)	Margin (dB)	Remark	Ant.Pol. (H/V)
1595.000	57.46	-7.48	49.98	74.00	-24.02	peak	V
1791.000	55.91	-6.27	49.64	74.00	-24.36	peak	V
11650.000	41.16	15.31	56.47	74.00	-17.53	peak	V
11650.000	34.29	15.31	49.60	54.00	-4.40	AVG	V
N/A							
1602.000	57.55	-7.43	50.12	74.00	-23.88	peak	H
N/A							

**Remark:**

1. Measuring frequencies from 1 GHz to the 10th harmonic of highest fundamental frequency.
2. Radiated emissions measured in frequency above 1000MHz were made with an instrument using peak/average detector mode.
3. Average test would be performed if the peak result were greater than the average limit.
4. Data of measurement within this frequency range shown “ --- ” in the table above means the reading of emissions are attenuated more than 20dB below the permissible limits or the field strength is too small to be measured.
5. Measurements above show only up to 6 maximum emissions noted, or would be lesser, with “ N/A ” remark, if no specific emissions from the EUT are recorded (ie: margin>20dB from the applicable limit) and considered that's already beyond the background noise floor.
6. Margin (dB) = Remark result (dBuV/m) – Average limit (dBuV/m).



**Operation Mode:** Tx / IEEE 802.11n HT 20 mode / 5745 ~ 5825MHz / CH Low

**Test Date:** October 7, 2014

**Temperature:** 27°C

**Tested by:** Andy Shi

**Humidity:** 53% RH

**Polarity:** Ver. / Hor.

Frequency (MHz)	Reading (dBuV)	Correction (dB/m)	Result (dBuV/m)	Limit (dBuV/m)	Margin (dB)	Remark	Ant.Pol. (H/V)
1196.000	58.88	-9.98	48.90	74.00	-25.10	peak	V
1595.000	56.96	-7.48	49.48	74.00	-24.52	peak	V
1791.000	55.82	-6.27	49.55	74.00	-24.45	peak	V
2001.000	54.16	-4.99	49.17	74.00	-24.83	peak	V
11490.000	43.18	15.30	58.48	74.00	-15.52	peak	V
11490.000	33.40	15.30	48.70	54.00	-5.30	AVG	V
1595.000	54.12	-7.48	46.64	74.00	-27.36	peak	H
1994.000	55.18	-5.03	50.15	74.00	-23.85	peak	H
N/A							

**Remark:**

1. Measuring frequencies from 1 GHz to the 10th harmonic of highest fundamental frequency.
2. Radiated emissions measured in frequency above 1000MHz were made with an instrument using peak/average detector mode.
3. Average test would be performed if the peak result were greater than the average limit.
4. Data of measurement within this frequency range shown “ --- ” in the table above means the reading of emissions are attenuated more than 20dB below the permissible limits or the field strength is too small to be measured.
5. Measurements above show only up to 6 maximum emissions noted, or would be lesser, with “ N/A ” remark, if no specific emissions from the EUT are recorded (ie: margin>20dB from the applicable limit) and considered that's already beyond the background noise floor.
6. Margin (dB) = Remark result (dBuV/m) – Average limit (dBuV/m).



**Operation Mode:** Tx / IEEE 802.11n HT 20 mode / 5745 ~ 5825MHz / CH Mid

**Test Date:** October 7, 2014

**Temperature:** 27°C

**Tested by:** Andy Shi

**Humidity:** 53% RH

**Polarity:** Ver. / Hor.

Frequency (MHz)	Reading (dBuV)	Correction (dB/m)	Result (dBuV/m)	Limit (dBuV/m)	Margin (dB)	Remark	Ant.Pol. (H/V)
1595.000	57.84	-7.48	50.36	74.00	-23.64	peak	V
1791.000	55.24	-6.27	48.97	74.00	-25.03	peak	V
1994.000	55.50	-5.03	50.47	74.00	-23.53	peak	V
11570.000	45.62	15.30	60.92	74.00	-13.08	peak	V
11570.000	33.61	15.30	48.91	54.00	-5.09	AVG	V
N/A							
1595.000	56.71	-7.48	49.23	74.00	-24.77	peak	H
N/A							

**Remark:**

1. Measuring frequencies from 1 GHz to the 10th harmonic of highest fundamental frequency.
2. Radiated emissions measured in frequency above 1000MHz were made with an instrument using peak/average detector mode.
3. Average test would be performed if the peak result were greater than the average limit.
4. Data of measurement within this frequency range shown “ --- ” in the table above means the reading of emissions are attenuated more than 20dB below the permissible limits or the field strength is too small to be measured.
5. Measurements above show only up to 6 maximum emissions noted, or would be lesser, with “ N/A ” remark, if no specific emissions from the EUT are recorded (ie: margin>20dB from the applicable limit) and considered that's already beyond the background noise floor.
6. Margin (dB) = Remark result (dBuV/m) – Average limit (dBuV/m).



**Operation Mode:** Tx / IEEE 802.11n HT 20 mode / 5745 ~ 5825MHz / CH High

**Test Date:** October 7, 2014

**Temperature:** 27°C

**Tested by:** Andy Shi

**Humidity:** 53% RH

**Polarity:** Ver. / Hor.

Frequency (MHz)	Reading (dBuV)	Correction (dB/m)	Result (dBuV/m)	Limit (dBuV/m)	Margin (dB)	Remark	Ant.Pol. (H/V)
1791.000	55.19	-6.27	48.92	74.00	-25.08	peak	V
2400.000	54.35	-3.73	50.62	74.00	-23.38	peak	V
11650.000	43.84	15.31	59.15	74.00	-14.85	peak	V
11650.000	27.59	15.31	42.90	54.00	-11.10	AVG	V
N/A							
1602.000	57.27	-7.43	49.84	74.00	-24.16	peak	H
N/A							

**Remark:**

1. Measuring frequencies from 1 GHz to the 10th harmonic of highest fundamental frequency.
2. Radiated emissions measured in frequency above 1000MHz were made with an instrument using peak/average detector mode.
3. Average test would be performed if the peak result were greater than the average limit.
4. Data of measurement within this frequency range shown “ --- ” in the table above means the reading of emissions are attenuated more than 20dB below the permissible limits or the field strength is too small to be measured.
5. Measurements above show only up to 6 maximum emissions noted, or would be lesser, with “ N/A ” remark, if no specific emissions from the EUT are recorded (ie: margin>20dB from the applicable limit) and considered that's already beyond the background noise floor.
6. Margin (dB) = Remark result (dBuV/m) – Average limit (dBuV/m).



Operation Mode: Tx / IEEE 802.11n HT 40 mode / 5755 ~ 5795MHz / CH Low

Test Date: October 7, 2014

Temperature: 27°C

Tested by: Andy Shi

Humidity: 53% RH

Polarity: Ver. / Hor.

Frequency (MHz)	Reading (dBuV)	Correction (dB/m)	Result (dBuV/m)	Limit (dBuV/m)	Margin (dB)	Remark	Ant.Pol. (H/V)
1196.000	57.10	-9.98	47.12	74.00	-26.88	peak	V
1791.000	55.55	-6.27	49.28	74.00	-24.72	peak	V
2001.000	54.09	-4.99	49.10	74.00	-24.90	peak	V
N/A							
1595.000	56.31	-7.48	48.83	74.00	-25.17	peak	H
1994.000	54.53	-5.03	49.50	74.00	-24.50	peak	H
N/A							

Remark:

1. Measuring frequencies from 1 GHz to the 10th harmonic of highest fundamental frequency.
2. Radiated emissions measured in frequency above 1000MHz were made with an instrument using peak/average detector mode.
3. Average test would be performed if the peak result were greater than the average limit.
4. Data of measurement within this frequency range shown “ --- ” in the table above means the reading of emissions are attenuated more than 20dB below the permissible limits or the field strength is too small to be measured.
5. Measurements above show only up to 6 maximum emissions noted, or would be lesser, with “ N/A ” remark, if no specific emissions from the EUT are recorded (ie: margin>20dB from the applicable limit) and considered that's already beyond the background noise floor.
6. Margin (dB) = Remark result (dBuV/m) – Average limit (dBuV/m).



**Operation Mode:** Tx / IEEE 802.11n HT 40 mode / 5755 ~ 5795MHz / CH High

**Test Date:** October 7, 2014

**Temperature:** 27°C

**Tested by:** Andy Shi

**Humidity:** 53% RH

**Polarity:** Ver. / Hor.

Frequency (MHz)	Reading (dBuV)	Correction (dB/m)	Result (dBuV/m)	Limit (dBuV/m)	Margin (dB)	Remark	Ant.Pol. (H/V)
1196.000	58.80	-9.98	48.82	74.00	-25.18	peak	V
1602.000	57.78	-7.43	50.35	74.00	-23.65	peak	V
1798.000	55.49	-6.23	49.26	74.00	-24.74	peak	V
1994.000	55.18	-5.03	50.15	74.00	-23.85	peak	V
N/A							
1595.000	55.10	-7.48	47.62	74.00	-26.38	peak	H
1987.000	54.33	-5.07	49.26	74.00	-24.74	peak	H
N/A							

**Remark:**

1. Measuring frequencies from 1 GHz to the 10th harmonic of highest fundamental frequency.
2. Radiated emissions measured in frequency above 1000MHz were made with an instrument using peak/average detector mode.
3. Average test would be performed if the peak result were greater than the average limit.
4. Data of measurement within this frequency range shown “ --- ” in the table above means the reading of emissions are attenuated more than 20dB below the permissible limits or the field strength is too small to be measured.
5. Measurements above show only up to 6 maximum emissions noted, or would be lesser, with “ N/A ” remark, if no specific emissions from the EUT are recorded (ie: margin>20dB from the applicable limit) and considered that's already beyond the background noise floor.
6. Margin (dB) = Remark result (dBuV/m) – Average limit (dBuV/m).



Operation Mode: Tx / IEEE 802.11 ac80 mode / 5755MHz

Test Date: October 7, 2014

Temperature: 27°C

Tested by: Andy Shi

Humidity: 53% RH

Polarity: Ver. / Hor.

Frequency (MHz)	Reading (dBuV)	Correction (dB/m)	Result (dBuV/m)	Limit (dBuV/m)	Margin (dB)	Remark	Ant.Pol. (H/V)
2421.000	51.68	-3.67	48.01	74.00	-25.99	peak	V
N/A							
1595.000	53.69	-7.48	46.21	74.00	-27.79	peak	H
N/A							

**Remark:**

1. Measuring frequencies from 1 GHz to the 10th harmonic of highest fundamental frequency.
2. Radiated emissions measured in frequency above 1000MHz were made with an instrument using peak/average detector mode.
3. Average test would be performed if the peak result were greater than the average limit.
4. Data of measurement within this frequency range shown “ --- ” in the table above means the reading of emissions are attenuated more than 20dB below the permissible limits or the field strength is too small to be measured.
5. Measurements above show only up to 6 maximum emissions noted, or would be lesser, with “ N/A ” remark, if no specific emissions from the EUT are recorded (ie: margin>20dB from the applicable limit) and considered that's already beyond the background noise floor.
6.  $Margin (dB) = Remark\ result (dBuV/m) - Average\ limit (dBuV/m)$ .





## 7.7 POWERLINE CONDUCTED EMISSIONS

### LIMIT

According to §15.207(a), except as shown in paragraphs (b) and (c) of this section, for an intentional radiator that is designed to be connected to the public utility (AC) power line, the radio frequency voltage that is conducted back onto the AC power line on any frequency or frequencies within the band 150 kHz to 30 MHz shall not exceed the limits in the following table, as measured using a 50  $\mu$ H/50 ohms line impedance stabilization network (LISN). Compliance with the provisions of this paragraph shall be based on the measurement of the radio frequency voltage between each power line and ground at the power terminal. The lower limit applies at the boundary between the frequency ranges.

Frequency Range (MHz)	Limits (dB $\mu$ V)	
	Quasi-peak	Average
0.15 to 0.50	66 to 56*	56 to 46*
0.50 to 5	56	46
5 to 30	60	50

\* Decreases with the logarithm of the frequency.

### TEST CONFIGURATION

See test photographs attached in Appendix 1 for the actual connections between EUT and support equipment.

### TEST PROCEDURE

1. The EUT was placed on a table, which is 0.8m above ground plane.
2. Maximum procedure was performed on the six highest emissions to ensure EUT compliance.
3. Repeat above procedures until all frequency measured were complete.



## TEST RESULTS

The initial step in collecting conducted data is a spectrum analyzer peak scan of the measurement range. Significant peaks are then marked as shown on the following data page, and these signals are then quasi-peaked.

### Test Data

**Operation Mode:** Normal Link                      **Test Date:** October 10, 2014  
**Temperature:** 26°C                                      **Tested by:** Andy Shi  
**Humidity:** 60% RH

Freq. (MHz)	QP Reading (dBuV)	AV Reading (dBuV)	Corr. factor (dB)	QP Result (dBuV)	AV Result (dBuV)	QP Limit (dBuV)	AV Limit (dBuV)	QP Margin (dB)	AV Margin (dB)	Note
0.1780	49.17	49.17	0.00	49.17	49.17	64.58	54.58	-15.41	-5.41	L1
0.3580	37.03	37.03	0.00	37.03	37.03	58.77	48.77	-21.74	-11.74	L1
0.6620	33.83	33.83	0.00	33.83	33.83	56.00	46.00	-22.17	-12.17	L1
1.2620	37.76	37.76	0.00	37.76	37.76	56.00	46.00	-18.24	-8.24	L1
2.8740	35.85	35.85	0.00	35.85	35.85	56.00	46.00	-20.15	-10.15	L1
6.9540	28.42	28.42	0.00	28.42	28.42	60.00	50.00	-31.58	-21.58	L1
0.1780	43.30	43.30	0.00	43.30	43.30	64.58	54.58	-21.28	-11.28	L2
0.3580	36.12	36.12	0.00	36.12	36.12	58.77	48.77	-22.65	-12.65	L2
0.8900	35.46	35.46	0.00	35.46	35.46	56.00	46.00	-20.54	-10.54	L2
1.4460	33.41	33.41	0.00	33.41	33.41	56.00	46.00	-22.59	-12.59	L2
2.6580	36.51	36.51	0.00	36.51	36.51	56.00	46.00	-19.49	-9.49	L2
18.2420	32.57	32.57	0.00	32.57	32.57	60.00	50.00	-27.43	-17.43	L2

### **Remark:**

1. Measuring frequencies from 0.15 MHz to 30MHz.
2. The emissions measured in frequency range from 0.15 MHz to 30MHz were made with an instrument using Quasi-peak detector and average detector.
3. The IF bandwidth of SPA between 0.15MHz to 30MHz was 10kHz; the IF bandwidth of Test Receiver between 0.15MHz to 30MHz was 9kHz;
4. L1 = Line One (Live Line) / L2 = Line Two (Neutral Line)



**Test Plots**

**Conducted emissions (Line 1)**

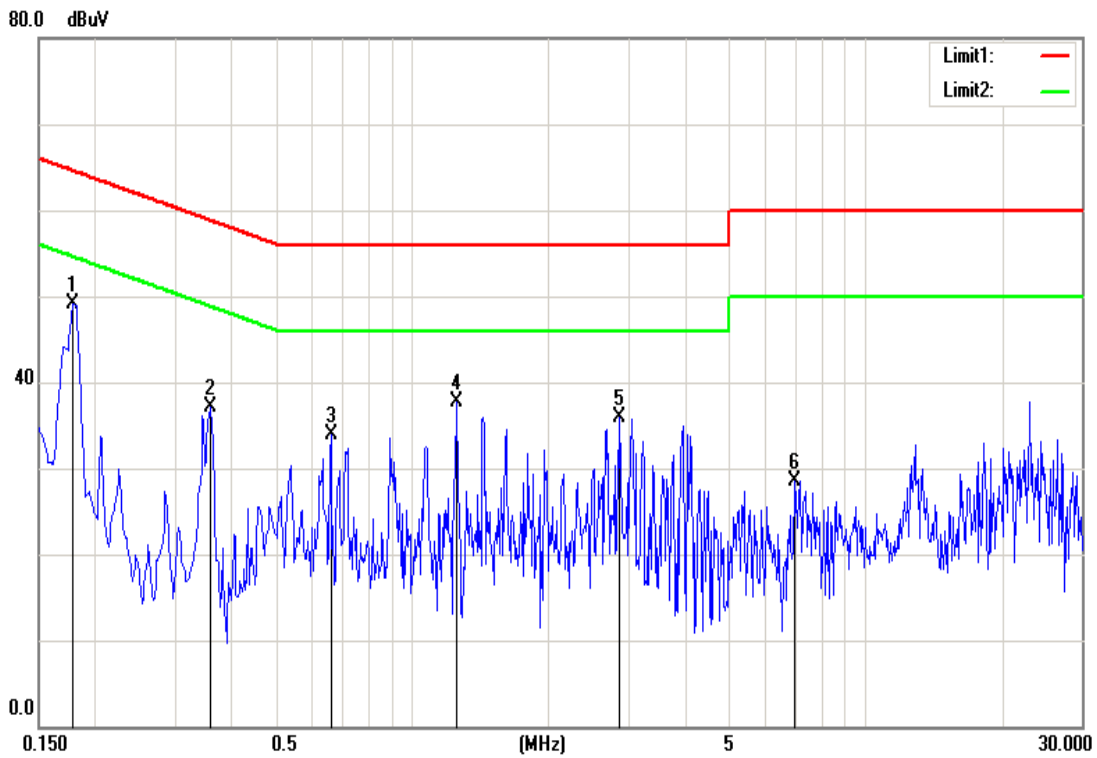

**Conducted emissions (Line 2)**

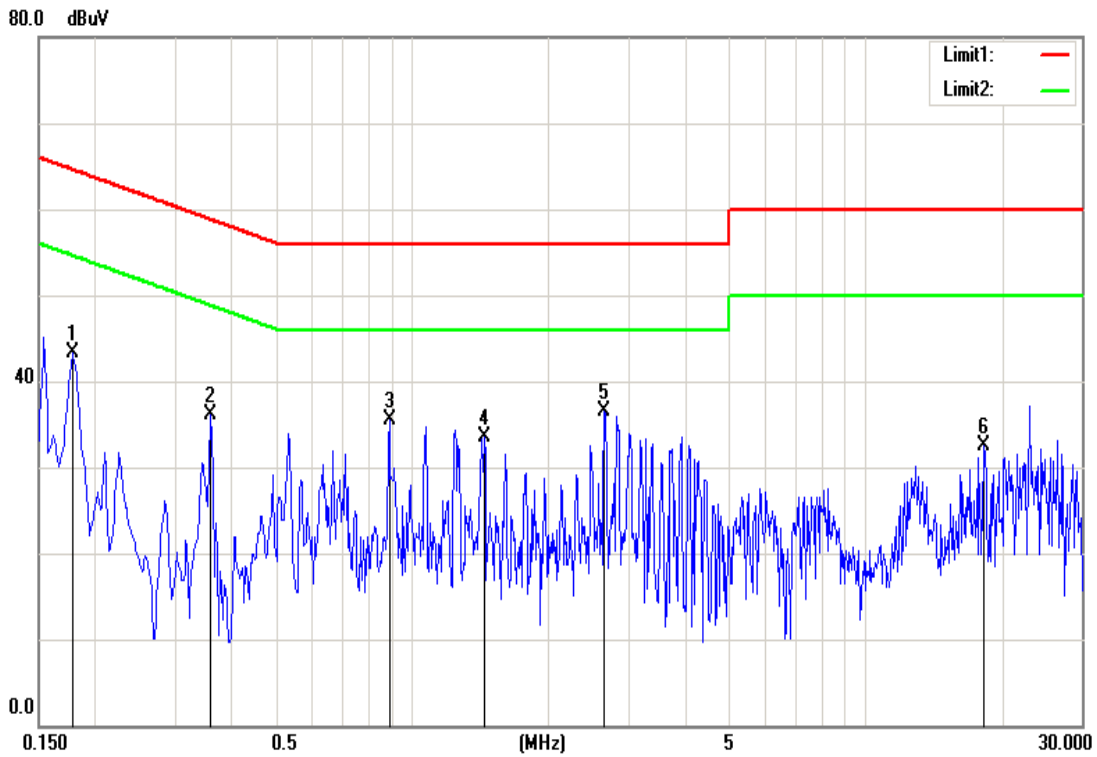



## 7.8 FREQUENCY STABILITY

### LIMIT

According to §15.407(g), manufacturers of U-NII devices are responsible for ensuring frequency stability such that an emission is maintained within the band of operation under all conditions of normal operation as specified in the user's manual.

### Test Configuration

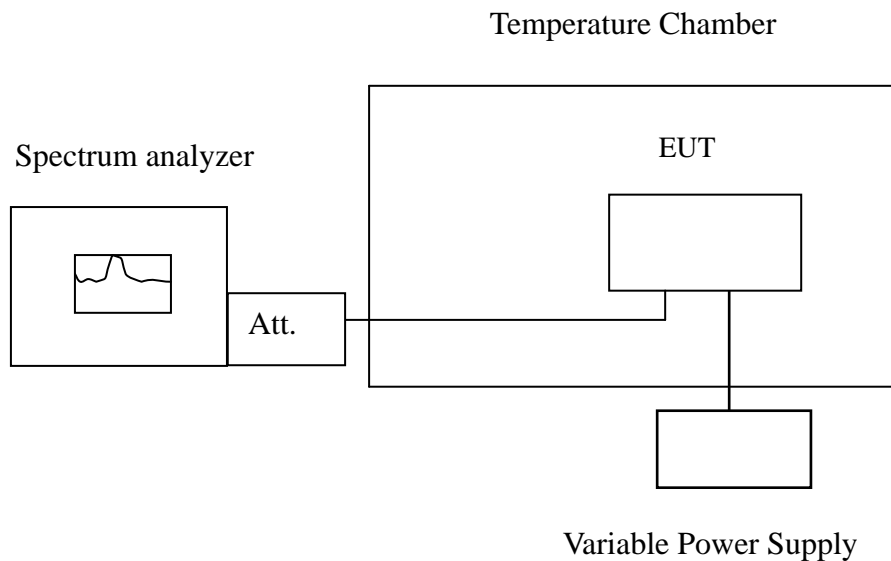

**Remark:** Measurement setup for testing on Antenna connector



### TEST PROCEDURE

The equipment under test was connected to an external AC or DC power supply and input rated voltage. RF output was connected to a frequency counter or spectrum analyzer via feed through attenuators. The EUT was placed inside the temperature chamber. Set the spectrum analyzer RBW low enough to obtain the desired frequency resolution and measure EUT 20°C operating frequency as reference frequency. Turn EUT off and set the chamber temperature to -20°C. After the temperature stabilized for approximately 30 minutes recorded the frequency. Repeat step measure with 10°C increased per stage until the highest temperature of +50°C reached.

### TEST RESULTS

*No non-compliance noted.*

#### **IEEE 802.11a mode / 5180 ~ 5240 MHz:**

##### CH Low

Operating Frequency: 5180 MHz				
Environment Temperature (°C)	Voltage (V)	Measured Frequency (MHz)	Limit Range	Test Result
50	110	5179.996452	5150~5250	Pass
40	110	5179.994115	5150~5250	Pass
30	110	5179.994372	5150~5250	Pass
20	110	5179.991272	5150~5250	Pass
10	110	5180.005031	5150~5250	Pass
0	110	5179.999159	5150~5250	Pass
-10	110	5180.010225	5150~5250	Pass
-20	110	5180.003929	5150~5250	Pass

Operating Frequency: 5180 MHz				
Environment Temperature (°C)	Voltage (V)	Measured Frequency (MHz)	Limit Range	Test Result
20	93.5	5180.007641	5150~5250	Pass
	110	5180.000449	5150~5250	Pass
	126.5	5180.008337	5150~5250	Pass



**CH Mid**

Operating Frequency: 5220 MHz				
Environment Temperature (°C)	Voltage (V)	Measured Frequency (MHz)	Limit Range	Test Result
50	110	5219.996134	5150~5250	Pass
40	110	5220.009473	5150~5250	Pass
30	110	5219.997023	5150~5250	Pass
20	110	5220.010949	5150~5250	Pass
10	110	5219.998929	5150~5250	Pass
0	110	5220.004872	5150~5250	Pass
-10	110	5219.993527	5150~5250	Pass
-20	110	5220.003980	5150~5250	Pass

Operating Frequency: 5220 MHz				
Environment Temperature (°C)	Voltage (V)	Measured Frequency (MHz)	Limit Range	Test Result
20	93.5	5220.003761	5150~5250	Pass
	110	5220.007711	5150~5250	Pass
	126.5	5219.995843	5150~5250	Pass



**CH High**

Operating Frequency: 5240 MHz				
Environment Temperature (°C)	Voltage (V)	Measured Frequency (MHz)	Limit Range	Test Result
50	110	5240.001422	5150~5250	Pass
40	110	5239.996994	5150~5250	Pass
30	110	5239.993952	5150~5250	Pass
20	110	5240.010237	5150~5250	Pass
10	110	5240.007036	5150~5250	Pass
0	110	5240.006670	5150~5250	Pass
-10	110	5239.990997	5150~5250	Pass
-20	110	5240.005808	5150~5250	Pass

Operating Frequency: 5240 MHz				
Environment Temperature (°C)	Voltage (V)	Measured Frequency (MHz)	Limit Range	Test Result
20	93.5	5240.001988	5150~5250	Pass
	110	5239.996416	5150~5250	Pass
	126.5	5240.002623	5150~5250	Pass



**IEEE 802.11n HT 20 mode / 5180 ~ 5240 MHz / Chain 0**

**CH Low**

Operating Frequency: 5180 MHz				
Environment Temperature (°C)	Voltage (V)	Measured Frequency (MHz)	Limit Range	Test Result
50	110	5180.000311	5150~5250	Pass
40	110	5180.010850	5150~5250	Pass
30	110	5179.996911	5150~5250	Pass
20	110	5180.009746	5150~5250	Pass
10	110	5180.008337	5150~5250	Pass
0	110	5179.993905	5150~5250	Pass
-10	110	5180.009564	5150~5250	Pass
-20	110	5180.010837	5150~5250	Pass

Operating Frequency: 5180 MHz				
Environment Temperature (°C)	Voltage (V)	Measured Frequency (MHz)	Limit Range	Test Result
20	93.5	5179.997911	5150~5250	Pass
	110	5179.993824	5150~5250	Pass
	126.5	5179.993152	5150~5250	Pass





**CH Mid**

Operating Frequency: 5220 MHz				
Environment Temperature (°C)	Voltage (V)	Measured Frequency (MHz)	Limit Range	Test Result
50	110	5220.003330	5150~5250	Pass
40	110	5220.003040	5150~5250	Pass
30	110	5220.007807	5150~5250	Pass
20	110	5219.994518	5150~5250	Pass
10	110	5219.999044	5150~5250	Pass
0	110	5220.004763	5150~5250	Pass
-10	110	5220.003466	5150~5250	Pass
-20	110	5220.008955	5150~5250	Pass

Operating Frequency: 5220 MHz				
Environment Temperature (°C)	Voltage (V)	Measured Frequency (MHz)	Limit Range	Test Result
20	93.5	5219.999816	5150~5250	Pass
	110	5220.008132	5150~5250	Pass
	126.5	5219.998225	5150~5250	Pass



**CH High**

Operating Frequency: 5240 MHz				
Environment Temperature (°C)	Voltage (V)	Measured Frequency (MHz)	Limit Range	Test Result
50	110	5240.005505	5150~5250	Pass
40	110	5239.995017	5150~5250	Pass
30	110	5240.001388	5150~5250	Pass
20	110	5240.006941	5150~5250	Pass
10	110	5240.004241	5150~5250	Pass
0	110	5239.994260	5150~5250	Pass
-10	110	5239.993383	5150~5250	Pass
-20	110	5239.993461	5150~5250	Pass

Operating Frequency: 5240 MHz				
Environment Temperature (°C)	Voltage (V)	Measured Frequency (MHz)	Limit Range	Test Result
20	93.5	5239.994392	5150~5250	Pass
	110	5240.003651	5150~5250	Pass
	126.5	5240.002186	5150~5250	Pass



**IEEE 802.11n HT 20 mode / 5180 ~ 5240 MHz / Chain 1**

**CH Low**

Operating Frequency: 5180 MHz				
Environment Temperature (°C)	Voltage (V)	Measured Frequency (MHz)	Limit Range	Test Result
50	110	5179.990461	5150~5250	Pass
40	110	5179.990120	5150~5250	Pass
30	110	5179.996984	5150~5250	Pass
20	110	5180.002203	5150~5250	Pass
10	110	5180.000348	5150~5250	Pass
0	110	5179.999489	5150~5250	Pass
-10	110	5179.993744	5150~5250	Pass
-20	110	5180.005713	5150~5250	Pass

Operating Frequency: 5180 MHz				
Environment Temperature (°C)	Voltage (V)	Measured Frequency (MHz)	Limit Range	Test Result
20	93.5	5180.005565	5150~5250	Pass
	110	5180.006199	5150~5250	Pass
	126.5	5179.996195	5150~5250	Pass



**CH Mid**

Operating Frequency: 5220 MHz				
Environment Temperature (°C)	Voltage (V)	Measured Frequency (MHz)	Limit Range	Test Result
50	110	5219.998351	5150~5250	Pass
40	110	5220.006960	5150~5250	Pass
30	110	5220.004080	5150~5250	Pass
20	110	5219.996554	5150~5250	Pass
10	110	5219.991619	5150~5250	Pass
0	110	5220.003743	5150~5250	Pass
-10	110	5219.990754	5150~5250	Pass
-20	110	5220.003445	5150~5250	Pass

Operating Frequency: 5220 MHz				
Environment Temperature (°C)	Voltage (V)	Measured Frequency (MHz)	Limit Range	Test Result
20	93.5	5219.993317	5150~5250	Pass
	110	5220.009665	5150~5250	Pass
	126.5	5220.003655	5150~5250	Pass



**CH High**

Operating Frequency: 5240 MHz				
Environment Temperature (°C)	Voltage (V)	Measured Frequency (MHz)	Limit Range	Test Result
50	110	5239.999712	5150~5250	Pass
40	110	5240.006100	5150~5250	Pass
30	110	5239.992314	5150~5250	Pass
20	110	5240.004588	5150~5250	Pass
10	110	5239.991881	5150~5250	Pass
0	110	5239.993251	5150~5250	Pass
-10	110	5240.003933	5150~5250	Pass
-20	110	5239.996613	5150~5250	Pass

Operating Frequency: 5240 MHz				
Environment Temperature (°C)	Voltage (V)	Measured Frequency (MHz)	Limit Range	Test Result
20	93.5	5239.996399	5150~5250	Pass
	110	5240.007159	5150~5250	Pass
	126.5	5240.002235	5150~5250	Pass



**IEEE 802.11n HT 40 mode / 5190 ~ 5230 MHz / Chain 0**

**CH Low**

Operating Frequency: 5190 MHz				
Environment Temperature (°C)	Voltage (V)	Measured Frequency (MHz)	Limit Range	Test Result
50	110	5189.992367	5150~5250	Pass
40	110	5190.003900	5150~5250	Pass
30	110	5190.003175	5150~5250	Pass
20	110	5189.996127	5150~5250	Pass
10	110	5190.005757	5150~5250	Pass
0	110	5190.000998	5150~5250	Pass
-10	110	5189.990791	5150~5250	Pass
-20	110	5189.991742	5150~5250	Pass

Operating Frequency: 5190 MHz				
Environment Temperature (°C)	Voltage (V)	Measured Frequency (MHz)	Limit Range	Test Result
20	93.5	5190.002875	5150~5250	Pass
	110	5189.995508	5150~5250	Pass
	126.5	5189.993467	5150~5250	Pass



**CH High**

Operating Frequency: 5230 MHz				
Environment Temperature (°C)	Voltage (V)	Measured Frequency (MHz)	Limit Range	Test Result
50	110	5229.997716	5150~5250	Pass
40	110	5229.990514	5150~5250	Pass
30	110	5229.995526	5150~5250	Pass
20	110	5230.006877	5150~5250	Pass
10	110	5229.997896	5150~5250	Pass
0	110	5230.008022	5150~5250	Pass
-10	110	5230.005121	5150~5250	Pass
-20	110	5230.007173	5150~5250	Pass

Operating Frequency: 5230 MHz				
Environment Temperature (°C)	Voltage (V)	Measured Frequency (MHz)	Limit Range	Test Result
20	93.5	5230.0015	5150~5250	Pass
	110	5229.992706	5150~5250	Pass
	126.5	5230.006557	5150~5250	Pass



**IEEE 802.11n HT 40 mode / 5190 ~ 5230 MHz / Chain 1**

**CH Low**

Operating Frequency: 5190 MHz				
Environment Temperature (°C)	Voltage (V)	Measured Frequency (MHz)	Limit Range	Test Result
50	110	5189.992399	5150~5250	Pass
40	110	5190.010885	5150~5250	Pass
30	110	5190.000809	5150~5250	Pass
20	110	5189.996278	5150~5250	Pass
10	110	5189.991585	5150~5250	Pass
0	110	5190.007618	5150~5250	Pass
-10	110	5190.008247	5150~5250	Pass
-20	110	5189.996993	5150~5250	Pass

Operating Frequency: 5190 MHz				
Environment Temperature (°C)	Voltage (V)	Measured Frequency (MHz)	Limit Range	Test Result
20	93.5	5190.007774	5150~5250	Pass
	110	5190.002951	5150~5250	Pass
	126.5	5190.004222	5150~5250	Pass





**CH High**

Operating Frequency: 5230 MHz				
Environment Temperature (°C)	Voltage (V)	Measured Frequency (MHz)	Limit Range	Test Result
50	110	5229.995433	5150~5250	Pass
40	110	5230.004964	5150~5250	Pass
30	110	5229.999746	5150~5250	Pass
20	110	5229.994578	5150~5250	Pass
10	110	5229.994606	5150~5250	Pass
0	110	5230.006817	5150~5250	Pass
-10	110	5230.001941	5150~5250	Pass
-20	110	5229.992303	5150~5250	Pass

Operating Frequency: 5230 MHz				
Environment Temperature (°C)	Voltage (V)	Measured Frequency (MHz)	Limit Range	Test Result
20	93.5	5230.00809	5150~5250	Pass
	110	5229.990421	5150~5250	Pass
	126.5	5230.010128	5150~5250	Pass



**IEEE 802.11 ac80 mode / 5210 MHz / Chain 0**

Operating Frequency: 5210 MHz				
Environment Temperature (°C)	Voltage (V)	Measured Frequency (MHz)	Limit Range	Test Result
50	110	5210.003472	5150~5250	Pass
40	110	5210.010052	5150~5250	Pass
30	110	5209.990154	5150~5250	Pass
20	110	5210.009797	5150~5250	Pass
10	110	5209.991046	5150~5250	Pass
0	110	5210.007304	5150~5250	Pass
-10	110	5210.001199	5150~5250	Pass
-20	110	5210.003468	5150~5250	Pass

Operating Frequency: 5210 MHz				
Environment Temperature (°C)	Voltage (V)	Measured Frequency (MHz)	Limit Range	Test Result
20	93.5	5209.995134	5150~5250	Pass
	110	5210.007331	5150~5250	Pass
	126.5	5210.009486	5150~5250	Pass



**IEEE 802.11 ac80 mode / 5210 MHz / Chain 1**

<b>Operating Frequency: 5210 MHz</b>				
<b>Environment Temperature (°C)</b>	<b>Voltage (V)</b>	<b>Measured Frequency (MHz)</b>	<b>Limit Range</b>	<b>Test Result</b>
50	110	5210.007001	5150~5250	Pass
40	110	5210.001894	5150~5250	Pass
30	110	5209.995051	5150~5250	Pass
20	110	5209.991201	5150~5250	Pass
10	110	5210.009468	5150~5250	Pass
0	110	5210.003940	5150~5250	Pass
-10	110	5210.006192	5150~5250	Pass
-20	110	5210.000660	5150~5250	Pass

<b>Operating Frequency: 5210 MHz</b>				
<b>Environment Temperature (°C)</b>	<b>Voltage (V)</b>	<b>Measured Frequency (MHz)</b>	<b>Limit Range</b>	<b>Test Result</b>
20	93.5	5209.998039	5150~5250	Pass
	110	5209.994209	5150~5250	Pass
	126.5	5210.004675	5150~5250	Pass