



A D T

FCC TEST REPORT (PART 24)

REPORT NO.: RF130823C23A-1

MODEL NO.: FJT21

FCC ID: YUW-FJT21

RECEIVED: Aug. 29, 2013

TESTED: Sep. 18 ~ Sep. 19, 2013

ISSUED: Oct. 07, 2013

APPLICANT: Fujitsu Mobile Communications Ltd.

ADDRESS: 1-1, Kamikodanaka 4-chome, Nakahara-ku,
Kawasaki 211-8588, Japan

ISSUED BY: Bureau Veritas Consumer Products Services
(H.K.) Ltd., Taoyuan Branch

LAB ADDRESS: No. 47, 14th Ling, Chia Pau Vil., Lin Kou Dist., New
Taipei City, Taiwan, R.O.C.

TEST LOCATION: No. 19, Hwa Ya 2nd Rd, Wen Hwa Tsuen, Kwei
Shan Hsiang, Taoyuan Hsien 333, Taiwan, R.O.C.

This report should not be used by the client to claim product certification, approval, or endorsement by TAF or any government agencies.



This report is for your exclusive use. Any copying or replication of this report to or for any other person or entity, or use of our name or trademark, is permitted only with our prior written permission. This report sets forth our findings solely with respect to the test samples identified herein. The results set forth in this report are not indicative or representative of the quality or characteristics of the lot from which a test sample was taken or any similar or identical product unless specifically and expressly noted. Our report includes all of the tests requested by you and the results thereof based upon the information that you provided to us. You have 60 days from date of issuance of this report to notify us of any material error or omission caused by our negligence, provided, however, that such notice shall be in writing and shall specifically address the issue you wish to raise. A failure to raise such issue within the prescribed time shall constitute your unqualified acceptance of the completeness of this report, the tests conducted and the correctness of the report contents. Unless specific mention, the uncertainty of measurement has been explicitly taken into account to declare the compliance or non-compliance to the specification.



TABLE OF CONTENTS

RELEASE CONTROL RECORD	3
1 CERTIFICATION	4
2 SUMMARY OF TEST RESULTS	5
2.1 MEASUREMENT UNCERTAINTY	5
2.2 TEST SITE AND INSTRUMENTS	6
3 GENERAL INFORMATION.....	7
3.1 GENERAL DESCRIPTION OF EUT.....	7
3.2 CONFIGURATION OF SYSTEM UNDER TEST.....	8
3.3 DESCRIPTION OF SUPPORT UNITS.....	8
3.4 TEST ITEM AND TEST CONFIGURATION	10
3.5 EUT OPERATING CONDITIONS.....	11
3.6 GENERAL DESCRIPTION OF APPLIED STANDARDS.....	11
4 TEST TYPES AND RESULTS	12
4.1 OUTPUT POWER MEASUREMENT	12
4.1.1 LIMITS OF OUTPUT POWER MEASUREMENT	12
4.1.2 TEST PROCEDURES	12
4.1.3 TEST SETUP.....	13
4.1.4 TEST RESULTS	14
4.2 FREQUENCY STABILITY MEASUREMENT	16
4.2.1 LIMITS OF FREQUENCY STABILITY MEASUREMENT	16
4.2.2 TEST PROCEDURE	16
4.2.3 TEST SETUP.....	16
4.2.4 TEST RESULTS	17
4.3 OCCUPIED BANDWIDTH MEASUREMENT.....	18
4.3.1 TEST PROCEDURES	18
4.3.2 TEST SETUP.....	18
4.3.3 TEST RESULTS	19
4.4 BAND EDGE MEASUREMENT	20
4.4.1 LIMITS OF BAND EDGE MEASUREMENT.....	20
4.4.2 TEST SETUP.....	20
4.4.3 TEST PROCEDURES	20
4.4.4 TEST RESULTS	21
4.5 CONDUCTED SPURIOUS EMISSIONS.....	22
4.5.1 LIMITS OF CONDUCTED SPURIOUS EMISSIONS MEASUREMENT.....	22
4.5.2 TEST PROCEDURE	22
4.5.3 TEST SETUP.....	22
4.5.4 TEST RESULTS	23
4.6 RADIATED EMISSION MEASUREMENT.....	26
4.6.1 LIMITS OF RADIATED EMISSION MEASUREMENT	26
4.6.2 TEST PROCEDURES	26
4.6.3 DEVIATION FROM TEST STANDARD	26
4.6.4 TEST SETUP.....	27
4.6.5 TEST RESULTS	28
5 PHOTOGRAPHS OF THE TEST CONFIGURATION	32
6 INFORMATION ON THE TESTING LABORATORIES.....	33
7 APPENDIX A – MODIFICATIONS RECORDERS FOR ENGINEERING CHANGES TO THE EUT BY THE LAB	34



A D T

RELEASE CONTROL RECORD

ISSUE NO.	REASON FOR CHANGE	DATE ISSUED
RF130823C23A-1	Original release	Oct. 07, 2013



1 CERTIFICATION

PRODUCT: Tablet PC
MODEL: FJT21
BRAND: FUJITSU
APPLICANT: Fujitsu Mobile Communications Ltd.
TESTED: Sep. 18 ~ Sep. 19, 2013
TEST SAMPLE: ENGINEERING SAMPLE
STANDARDS: FCC Part 24, Subpart E

The above equipment (model: FJT21) has been tested by **Bureau Veritas Consumer Products Services (H.K.) Ltd., Taoyuan Branch**, and found compliance with the requirement of the above standards. The test record, data evaluation & Equipment Under Test (EUT) configurations represented herein are true and accurate accounts of the measurements of the sample's EMC characteristics under the conditions specified in this report.

PREPARED BY : Sunt Lee , **DATE :** Oct. 07, 2013
Sunt Lee / Specialist

APPROVED BY : Anderson Chiu , **DATE :** Oct. 07, 2013
Anderson Chiu / Senior Engineer

2 SUMMARY OF TEST RESULTS

The EUT has been tested according to the following specifications:

APPLIED STANDARD: FCC Part 24 & Part 2			
STANDARD SECTION	TEST TYPE	RESULT	REMARK
2.1046 24.232	Equivalent isotropically radiated power	PASS	Meet the requirement of limit.
2.1055 24.235	Frequency Stability	PASS	Meet the requirement of limit.
2.1049 24.238(b)	Occupied Bandwidth	PASS	Meet the requirement of limit.
24.238(b)	Band Edge Measurements	PASS	Meet the requirement of limit.
2.1051 24.238	Conducted Spurious Emissions	PASS	Meet the requirement of limit.
2.1053 24.238	Radiated Spurious Emissions	PASS	Meet the requirement of limit. Minimum passing margin is -19.15dB at 7639.20MHz.

2.1 MEASUREMENT UNCERTAINTY

Where relevant, the following measurement uncertainty levels have been estimated for tests performed on the EUT as specified in CISPR 16-4-2:

MEASUREMENT	FREQUENCY	UNCERTAINTY
Conducted emissions	150kHz~30MHz	2.44 dB
Radiated emissions	30MHz ~ 200MHz	3.34 dB
	200MHz ~1000MHz	3.35 dB
	1GHz ~ 18GHz	2.26 dB
	18GHz ~ 40GHz	1.94 dB

This uncertainty represents an expanded uncertainty expressed at approximately the 95% confidence level using a coverage factor of k=2.



A D T

2.2 TEST SITE AND INSTRUMENTS

DESCRIPTION & MANUFACTURER	MODEL NO.	SERIAL NO.	DATE OF CALIBRATION	DUE DATE OF CALIBRATION
Test Receiver ROHDE & SCHWARZ	ESI7	838496/016	Dec. 25, 2012	Dec. 24, 2013
Spectrum Analyzer ROHDE & SCHWARZ	FSP40	100039	Jan. 31, 2013	Jan. 30, 2014
BILOG Antenna SCHWARZBECK	VULB9168	9168-160	Mar. 20, 2013	Mar. 19, 2014
HORN Antenna SCHWARZBECK	BBHA 9120D	9120D-404	Dec. 22, 2012	Dec. 21, 2013
HORN Antenna SCHWARZBECK	BBHA 9170	148	Jul. 15, 2013	Jul. 14, 2014
Preamplifier Agilent	8447D	2944A10633	Oct. 25, 2012	Oct. 24, 2013
Preamplifier Agilent	8449B	3008A01964	Oct. 25, 2012	Oct. 24, 2013
RF signal cable HUBER+SUHNNER	SUCOFLEX 104	250723/4	Aug. 23, 2013	Aug. 22, 2014
RF signal cable HUBER+SUHNNER	SUCOFLEX 106	12738/6+309224/4	Aug. 23, 2013	Aug. 22, 2014
Software BV ADT	ADT_Radiated_ V7.6.15.9.4	NA	NA	NA
Antenna Tower inn-co GmbH	MA 4000	013303	NA	NA
Antenna Tower Controller inn-co GmbH	CO2000	017303	NA	NA
Turn Table BV ADT	TT100	TT93021703	NA	NA
Turn Table Controller BV ADT	SC100	SC93021703	NA	NA
JFW 20dB attenuation	50HF-020-SMA	NA	NA	NA
Communications Tester-Wireless	E5515C	MY50266653	Oct. 08, 2012	Oct. 09, 2013
JFW 20dB attenuation	50HF-020-SMA	NA	NA	NA
Communications Tester-Wireless	E5515C	MY50266653	Oct. 08, 2012	Oct. 09, 2013

- NOTE:**
1. The calibration interval of the above test instruments is 12 months and the calibrations are traceable to NML/ROC and NIST/USA.
 2. The test was performed in HwaYa Chamber 3.
 3. The horn antenna and HP preamplifier (model: 8449B) are used only for the measurement of emission frequency above 1GHz if tested.
 4. The FCC Site Registration No. is 988962.
 5. The IC Site Registration No. is IC 7450F-3.



3 GENERAL INFORMATION

3.1 GENERAL DESCRIPTION OF EUT

EUT	Tablet PC
MODEL NO.	FJT21
POWER SUPPLY	3.8Vdc (battery) 5Vdc (adapter or host equipment) 12Vdc (cradle)
MODULATION TYPE	GMSK
FREQUENCY RANGE	1850.2MHz ~ 1909.8MHz
MAX. EIRP POWER	427.563mW (26.31dBm)
EMISSION DESIGNATOR	255KGXW
MULTI-SLOTS CLASS	33
ANTENNA TYPE	$\lambda/4$ Monopole antenna with -1.1dBi gain
DATA CABLE	NA
I/O PORTS	Refer to user's manual
ACCESSORY DEVICES	Refer to Note

NOTE:

1. The EUT contains following accessories.

No.	Product	Brand	Model	Description
1	Cradle	KDDI CORPORATION	FJT21PUA	Input: 12.0V, 2000mA Output: 12.0V, 2000mA
2	Cradle's adapter	KDDI CORPORATION	FJL22PQA	Input: 100-240Vac, 1000mA Output: 12.0Vdc, 3000mA 1m non-shielded AC cable without core 1.8m non-shielded DC cable with 1 core
3	Battery	Fujitsu Limited	CA54310-0048	3.8Vdc, 9600mA

2. The EUT uses following support unit.

No.	Product	Brand	Model	Description
1	Adapter	NTT docomo	AC Adaptor 04	Input: 100-240Vac, 0.22A, 50-60Hz Output: 5.0V, 1.8A 1.05m DC cable with 2 cores

3. SW version is R17.1e.
4. HW version is V2.0.0.
5. IMEI code is 357674050003194.
6. The above EUT information is declared by the manufacturer and for more detailed features description, please refer to the manufacturer's specifications or User's Manual.

3.2 CONFIGURATION OF SYSTEM UNDER TEST

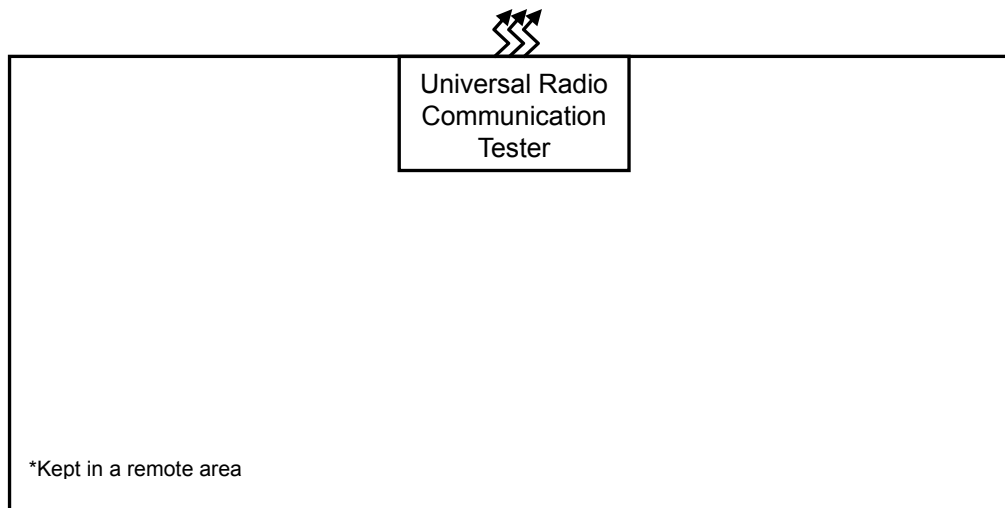
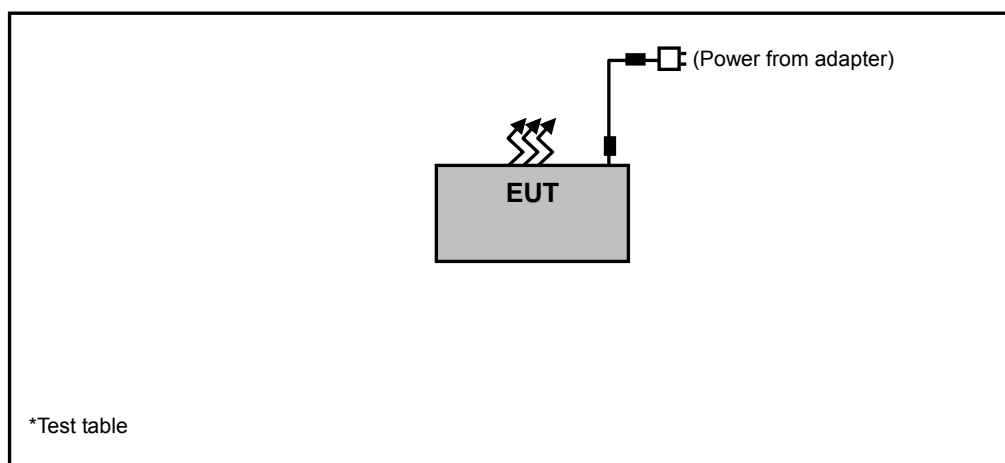



A D T

3.3 DESCRIPTION OF SUPPORT UNITS

The EUT has been tested as an independent unit together with other necessary accessories or support units. The following support units or accessories were used to form a representative test configuration during the tests.

NO.	PRODUCT	BRAND	MODEL NO.	SERIAL NO.	FCC ID
1	Universal Radio Communication Tester	R&S	CMU200	123112	NA

NO.	SIGNAL CABLE DESCRIPTION OF THE ABOVE SUPPORT UNITS
1	NA

NOTE:

1. All power cords of the above support units are non-shielded (1.8m).
2. Item 1 acted as a communication partner to transfer data.

3.4 TEST ITEM AND TEST CONFIGURATION

Pre-Scan has been conducted to determine the worst-case mode from all possible combinations between available modulations, data rates, XYZ axis and antenna ports. The worst case was found when positioned on **Z-plane**. Following channel(s) was (were) selected for the final test as listed below:

Test results are presented in the report as below.

Test Mode	Test Condition
A	Power from adapter
B	Power from battery

GPRS MODE

EUT CONFIGURE MODE	TEST ITEM	AVAILABLE CHANNEL	TESTED CHANNEL	MODE
A	ERP	512 to 810	512, 661, 810	GPRS
B	FREQUENCY STABILITY	512 to 810	661	GPRS
A	OCCUPIED BANDWIDTH	512 to 810	512, 661, 810	GPRS
A	BAND EDGE	512 to 810	512, 810	GPRS
A	CONDCUDED EMISSION	512 to 810	661	GPRS
A	RADIATED EMISSION Below 1GHz	512 to 810	661	GPRS
A	RADIATED EMISSION Above 1GHz	512 to 810	512, 661, 810	GPRS

TEST CONDITION:

TEST ITEM	ENVIRONMENTAL CONDITIONS	INPUT POWER	TESTED BY
EIRP	25deg. C, 65%RH	120Vac, 60Hz	Chris Lin
FREQUENCY STABILITY	24deg. C, 64%RH	3.8Vdc	Match Tsui
OCCUPIED BANDWIDTH	24deg. C, 64%RH	120Vac, 60Hz	Match Tsui
BAND EDGE	24deg. C, 64%RH	120Vac, 60Hz	Match Tsui
CONDCUDED EMISSION	24deg. C, 64%RH	120Vac, 60Hz	Match Tsui
RADIATED EMISSION Below 1GHz	25deg. C, 65%RH	120Vac, 60Hz	Chris Lin
RADIATED EMISSION Above 1GHz	25deg. C, 65%RH	120Vac, 60Hz	Chris Lin

3.5 EUT OPERATING CONDITIONS

The EUT makes a call to the communication simulator. The communication simulator station system controlled a EUT to export maximum output power under transmission mode and specific channel frequency

3.6 GENERAL DESCRIPTION OF APPLIED STANDARDS

The EUT is a RF product. According to the specifications of the manufacturer, it must comply with the requirements of the following standards:

FCC 47 CFR Part 2

FCC 47 CFR Part 24

ANSI/TIA/EIA-603-C 2004

NOTE: All test items have been performed and recorded as per the above standards.

4 TEST TYPES AND RESULTS

4.1 OUTPUT POWER MEASUREMENT

4.1.1 LIMITS OF OUTPUT POWER MEASUREMENT

Mobile and portable stations are limited to 2 watts EIRP

4.1.2 TEST PROCEDURES

EIRP MEASUREMENT:

- a. All measurements were done at low, middle and high operational frequency range. RBW and VBW is 1MHz for GPRS mode.
- b. Substitution method is used for E.I.R.P measurement. In the semi-anechoic chamber, EUT placed on the 0.8m height of Turn Table, rotated the table around 360 degrees to search the maximum radiation power and receiver antenna shall be rotated vertical and horizontal polarization and moved height from 1m to 4m to find the maximum polar radiated power. The “Read Value” is the spectrum reading the maximum power value.
- c. The substitution horn antenna is substituted for EUT at the same position and signals generator export the CW signal to the substitution antenna via a tx cable. Rotated the Turn Table and moved receiving antenna to find the maximum radiation power. Adjust output power level of S.G to get a Value of spectrum reading equal to “Read Value” of step b. Record the power level of S.G
- d. $EIRP = \text{Output power level of S.G} - \text{TX cable loss} + \text{Antenna gain of substitution horn.}$

CONDUCTED POWER MEASUREMENT:

The EUT was set up for the maximum power with GPRS link data modulation and link up with simulator. Set the EUT to transmit under low, middle and high channel and record the power level shown on simulator.

4.1.3 TEST SETUP

EIRP MEASUREMENT:

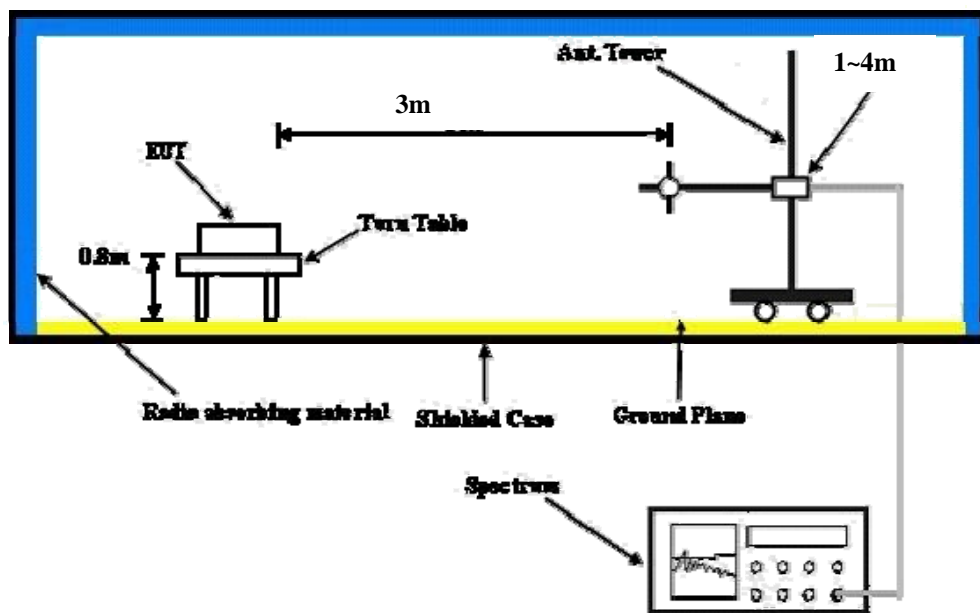

For the actual test configuration, please refer to the attached file (Test Setup Photo).

CONDUCTED POWER MEASUREMENT:

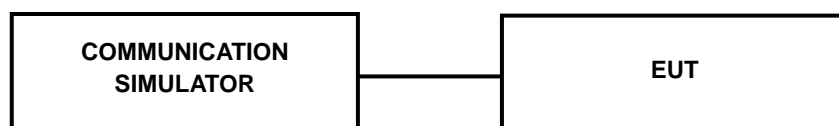

For the actual test configuration, please refer to the attached file (Test Setup Photo).

4.1.4 TEST RESULTS

CONDUCTED OUTPUT POWER (dBm)

Band	GPRS1900		
Channel	512	661	810
Frequency (MHz)	1850.2	1880.0	1909.8
GPRS 8	28.94	28.79	28.95
GPRS 10	26.54	26.39	26.55
GPRS 11	24.94	24.79	24.95
GPRS 12	23.73	23.58	23.74



A D T

EIRP POWER (dBm)

GPRS

MODE		TX channel 512					
ANTENNA POLARITY & TEST DISTANCE: HORIZONTAL AT 3 M							
No.	Freq. (MHz)	Reading (dBm)	S.G Power Value (dBm)	Correction Factor (dB)	EIRP (dBm)	Limit (dBm)	Margin (dB)
1	1850.20	-17.61	18.49	1.07	19.56	33.00	-13.44
ANTENNA POLARITY & TEST DISTANCE: VERTICAL AT 3 M							
No.	Freq. (MHz)	Reading (dBm)	S.G Power Value (dBm)	Correction Factor (dB)	EIRP (dBm)	Limit (dBm)	Margin (dB)
1	1850.20	-9.84	25.13	1.07	26.20	33.00	-6.80

MODE		TX channel 661					
ANTENNA POLARITY & TEST DISTANCE: HORIZONTAL AT 3 M							
No.	Freq. (MHz)	Reading (dBm)	S.G Power Value (dBm)	Correction Factor (dB)	EIRP (dBm)	Limit (dBm)	Margin (dB)
1	1880.00	-16.88	18.62	1.12	19.74	33.00	-13.26
ANTENNA POLARITY & TEST DISTANCE: VERTICAL AT 3 M							
No.	Freq. (MHz)	Reading (dBm)	S.G Power Value (dBm)	Correction Factor (dB)	EIRP (dBm)	Limit (dBm)	Margin (dB)
1	1880.00	-9.18	25.19	1.12	26.31	33.00	-6.69

MODE		TX channel 810					
ANTENNA POLARITY & TEST DISTANCE: HORIZONTAL AT 3 M							
No.	Freq. (MHz)	Reading (dBm)	S.G Power Value (dBm)	Correction Factor (dB)	EIRP (dBm)	Limit (dBm)	Margin (dB)
1	1909.80	-17.38	18.04	1.11	19.15	33.00	-13.85
ANTENNA POLARITY & TEST DISTANCE: VERTICAL AT 3 M							
No.	Freq. (MHz)	Reading (dBm)	S.G Power Value (dBm)	Correction Factor (dB)	EIRP (dBm)	Limit (dBm)	Margin (dB)
1	1909.80	-17.38	18.04	1.11	19.15	33.00	-13.85

NOTE: Power Value (dBm) = S.G Power Value (dBm) + Correction Factor (dB).

4.2 FREQUENCY STABILITY MEASUREMENT

4.2.1 LIMITS OF FREQUENCY STABILITY MEASUREMENT

The frequency stability shall be sufficient to ensure that the fundamental emission stays within the authorized frequency block.

4.2.2 TEST PROCEDURE

- a. Device is placed at the oven room. The oven room could control the temperatures and humidity. Power warm up is at least 15 min and power applied should perform before recording frequency error.
- b. EUT is connected the external power supply to control the DC input power. The test voltage range is from minimum to maximum working voltage. Each step shall be record the frequency error rate.
- c. The temperature range step is 10 degrees in this test items. All temperature levels shall be hold the $\pm 0.5^{\circ}\text{C}$ during the measurement testing. The each temperature step shall be at least 0.5 hours, consider the EUT could be test under the stability condition.

NOTE: The frequency error was recorded frequency error from the communication simulator.

4.2.3 TEST SETUP

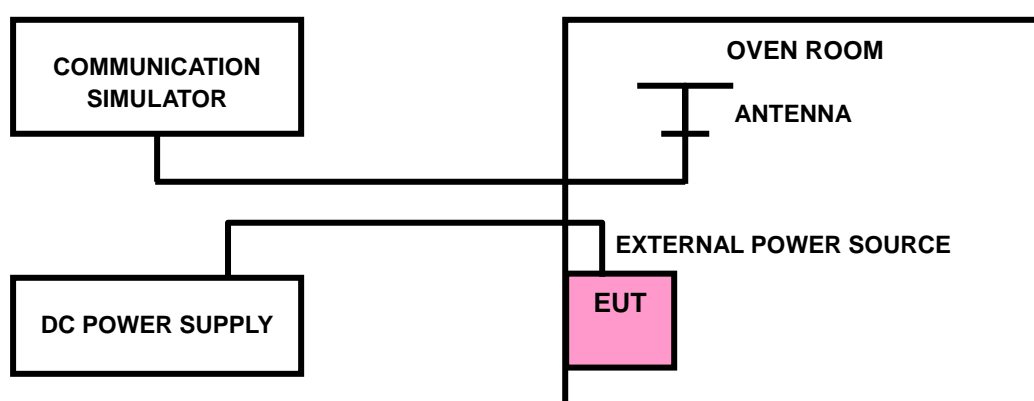

4.2.4 TEST RESULTS

FREQUENCY ERROR VS. VOLTAGE

VOLTAGE (Volts)	FREQUENCY ERROR (ppm)	LIMIT (ppm)
	GPRS	
4.29	-0.010	2.5
3.9	-0.008	2.5
3.51	-0.009	2.5

NOTE: The applicant defined the normal working voltage of the battery is from 3.51Vdc to 4.29Vdc.

FREQUENCY ERROR vs. TEMPERATURE

TEMP. (°C)	FREQUENCY ERROR (ppm)	LIMIT (ppm)
	GPRS	
50	-0.014	2.5
40	-0.012	2.5
30	-0.011	2.5
20	-0.008	2.5
10	-0.010	2.5
0	-0.014	2.5
-10	-0.018	2.5
-20	-0.019	2.5
-30	-0.022	2.5

4.3 OCCUPIED BANDWIDTH MEASUREMENT

4.3.1 TEST PROCEDURES

The EUT makes a call to the communication simulator. All measurements were done at low, middle and high operational frequency range. The communication simulator station system controlled a EUT to export maximum output power under transmission mode and specific channel frequency. Use OBW measurement function of Spectrum analyzer to measure 99 % occupied bandwidth.

4.3.2 TEST SETUP

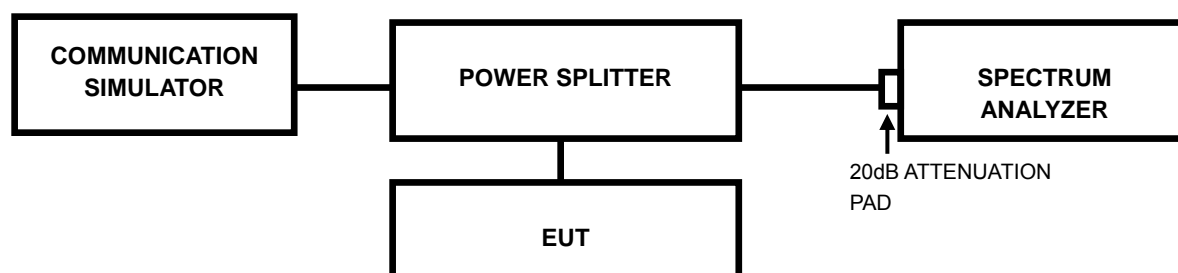



A D T

4.3.3 TEST RESULTS

CHANNEL	FREQUENCY (MHz)	99% OCCUPIED BANDWIDTH (kHz)
		GPRS
512	1850.2	255
661	1880.0	255
810	1909.8	255

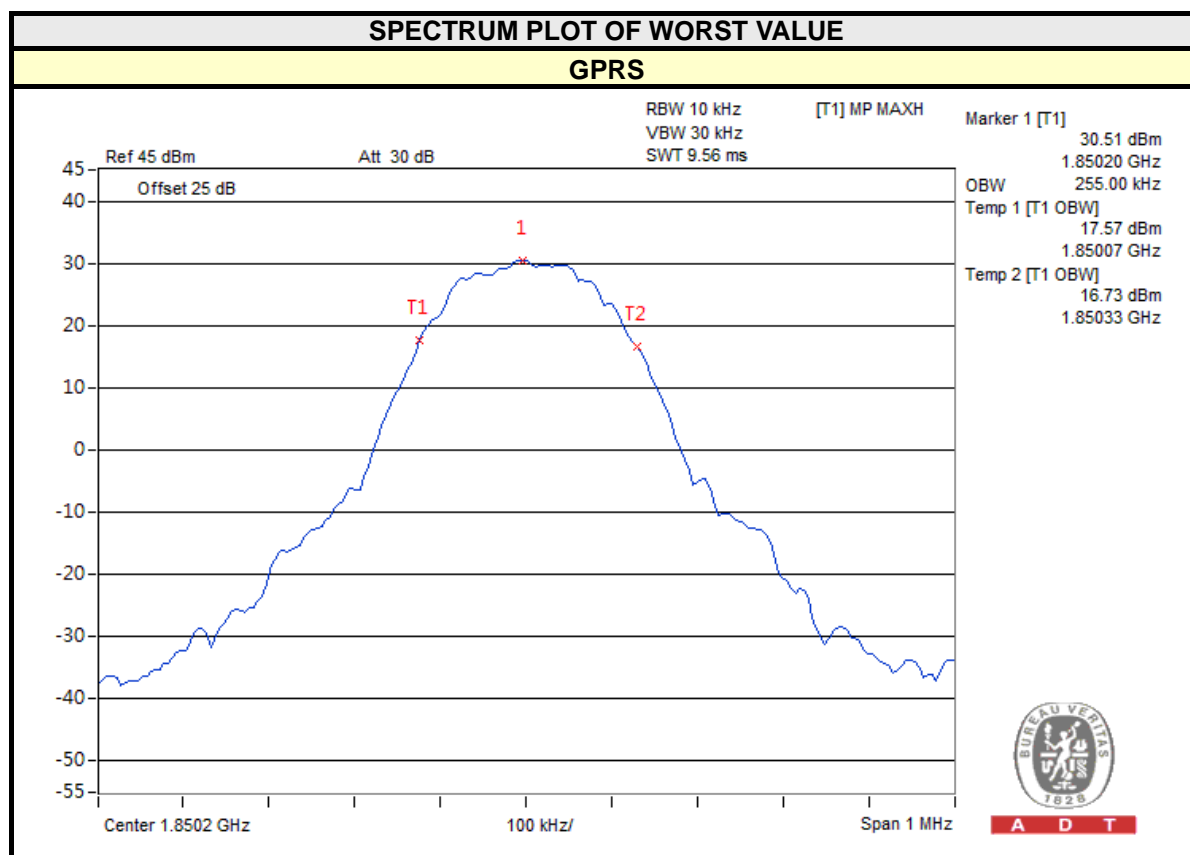

4.4 BAND EDGE MEASUREMENT

4.4.1 LIMITS OF BAND EDGE MEASUREMENT

Power of any emission outside of the authorized operating frequency ranges must be attenuated below the transmitting power (P) by a factor of at least $43 + 10 \log(P)$ dB. In the 1 MHz bands immediately outside and adjacent to the frequency block a resolution bandwidth of at least one percent of the emission bandwidth of the fundamental emission of the transmitter may be employed.

4.4.2 TEST SETUP

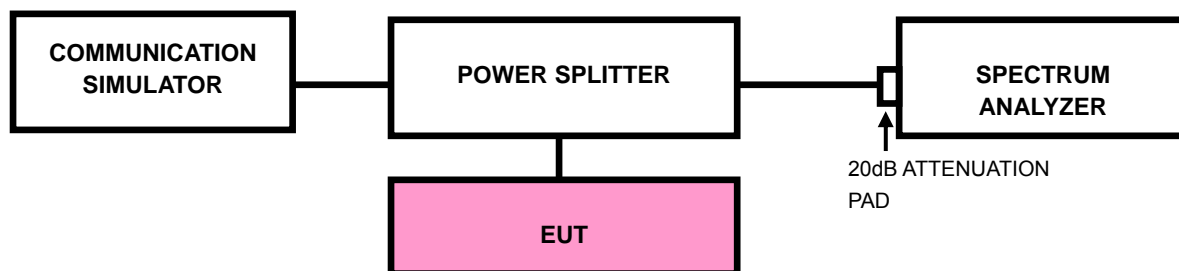

4.4.3 TEST PROCEDURES

- All measurements were done at low and high operational frequency range.
- The center frequency of spectrum is the band edge frequency and span is 1.5MHz. RB of the spectrum is 3kHz and VB of the spectrum is 10kHz (GPRS).
- Record the max trace plot into the test report.



A D T

4.4.4 TEST RESULTS

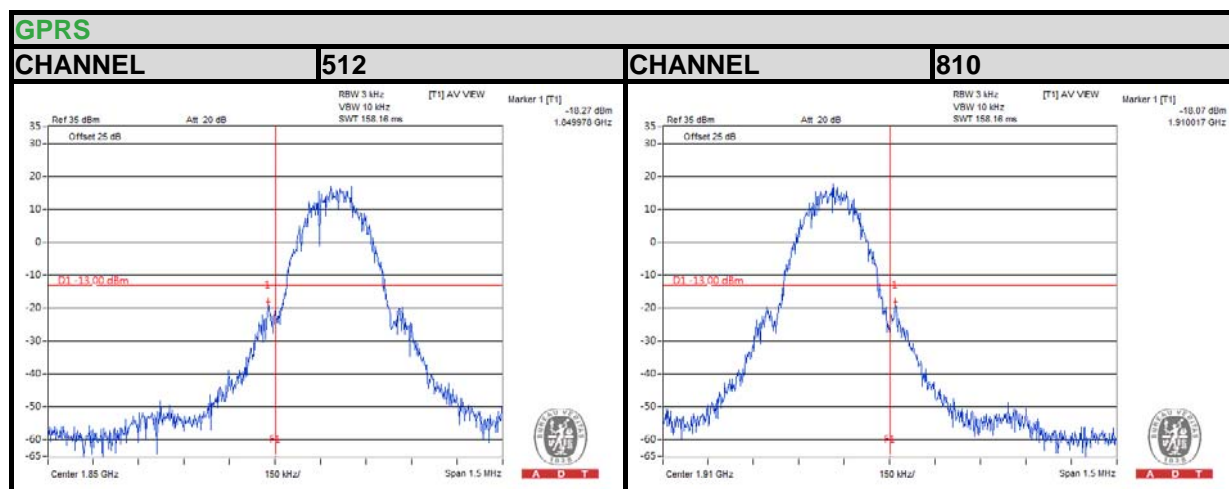

4.5 CONDUCTED SPURIOUS EMISSIONS

4.5.1 LIMITS OF CONDUCTED SPURIOUS EMISSIONS MEASUREMENT

The power of any emission outside of the authorized operating frequency ranges must be attenuated below the transmitting power (P) by a factor of at least $43 + 10 \log(P)$ dB. The emission limit equal to -13dBm .

4.5.2 TEST PROCEDURE

- a. The EUT makes a phone call to the communication simulator. All measurements were done at low, middle and high operational frequency range.
- b. Measuring frequency range is from 9 kHz to 20GHz. 20dB attenuation pad is connected with spectrum. RBW=1MHz and VBW=3MHz is used for conducted emission measurement.

4.5.3 TEST SETUP

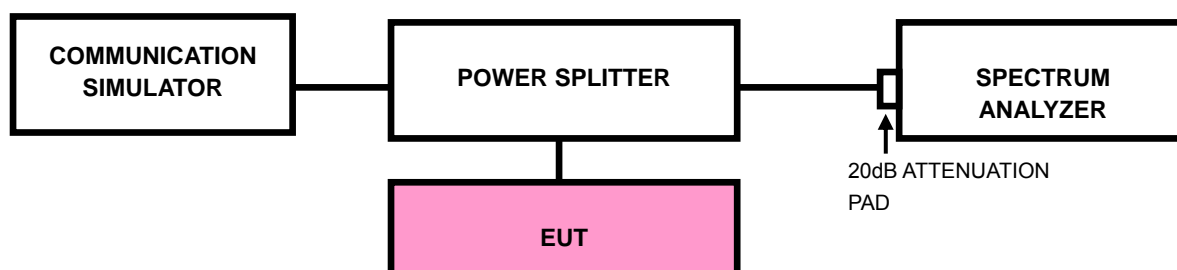

4.5.4 TEST RESULTS





A D T

GPRS

CHANNEL 661

FREQUENCY RANGE : 9kHz~3GHz

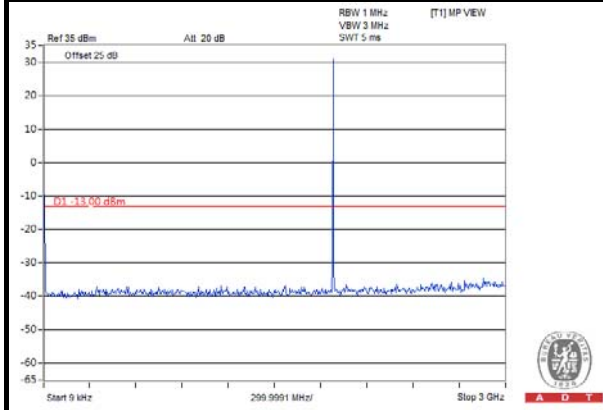

FREQUENCY RANGE : 3GHz~10GHz

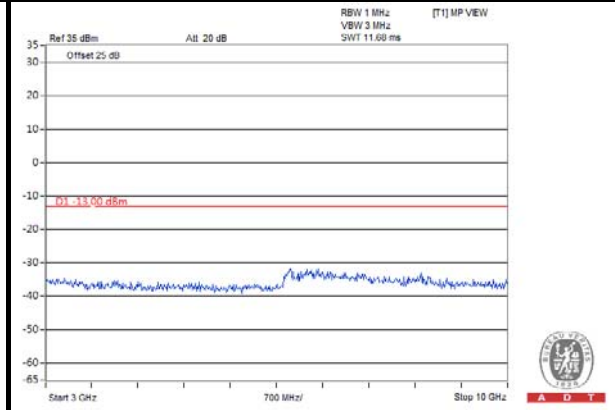

FREQUENCY RANGE : 10GHz~20GHz

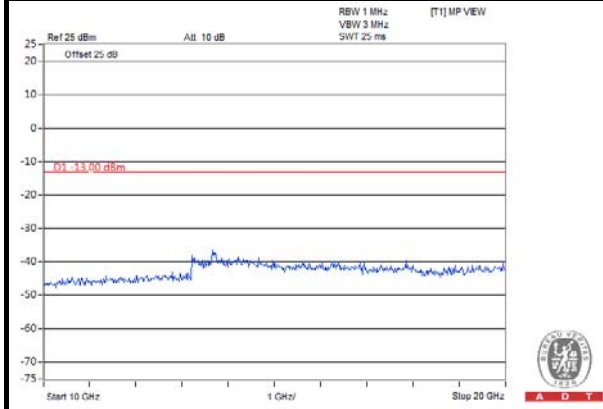



A D T

GPRS

CHANNEL 810

FREQUENCY RANGE : 9kHz~3GHz

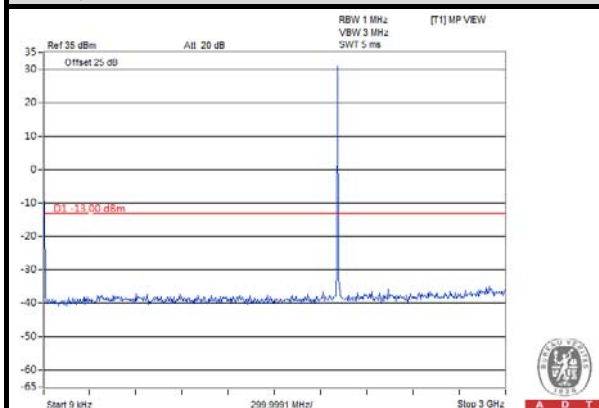

FREQUENCY RANGE : 3GHz~10GHz

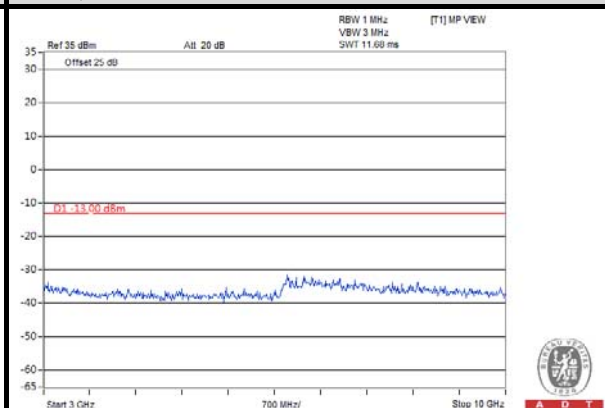

FREQUENCY RANGE : 10GHz~20GHz

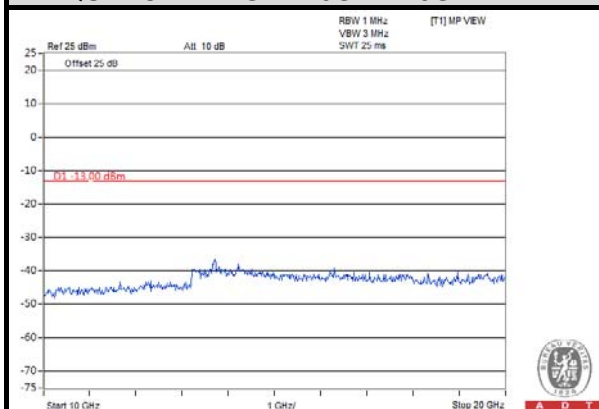

4.6 RADIATED EMISSION MEASUREMENT

4.6.1 LIMITS OF RADIATED EMISSION MEASUREMENT

The power of any emission outside of the authorized operating frequency ranges must be attenuated below the transmitting power (P) by a factor of at least $43 + 10 \log(P)$ dB. The emission limit equal to -13dBm .

4.6.2 TEST PROCEDURES

- a. Substitution method is used for E.I.R.P measurement. In the semi-anechoic chamber, EUT placed on the 0.8m height of Turn Table, rotated the table around 360 degrees to search the maximum radiation power and receiver antenna shall be rotated vertical and horizontal polarization and moved height from 1m to 4m to find the maximum polar radiated power. The “Read Value” is the spectrum reading the maximum power value.
- b. The substitution horn antenna is substituted for EUT at the same position and signals generator export the CW signal to the substitution antenna via a TX cable. Rotated the Turn Table and moved receiving antenna to find the maximum radiation power. Adjust output power level of S.G to get a Value of spectrum reading equal to “Read Value” of step a. Record the power level of S.G
- c. $\text{EIRP} = \text{Output power level of S.G} - \text{TX cable loss} + \text{Antenna gain of substitution horn}$.
- d. E.R.P power can be calculated form E.I.R.P power by subtracting the gain of dipole, $\text{E.R.P power} = \text{E.I.P.R power} - 2.15\text{dBi}$.

NOTE: The resolution bandwidth and video bandwidth of test receiver/spectrum analyzer is 1MHz/3MHz.

4.6.3 DEVIATION FROM TEST STANDARD

No deviation

4.6.4 TEST SETUP

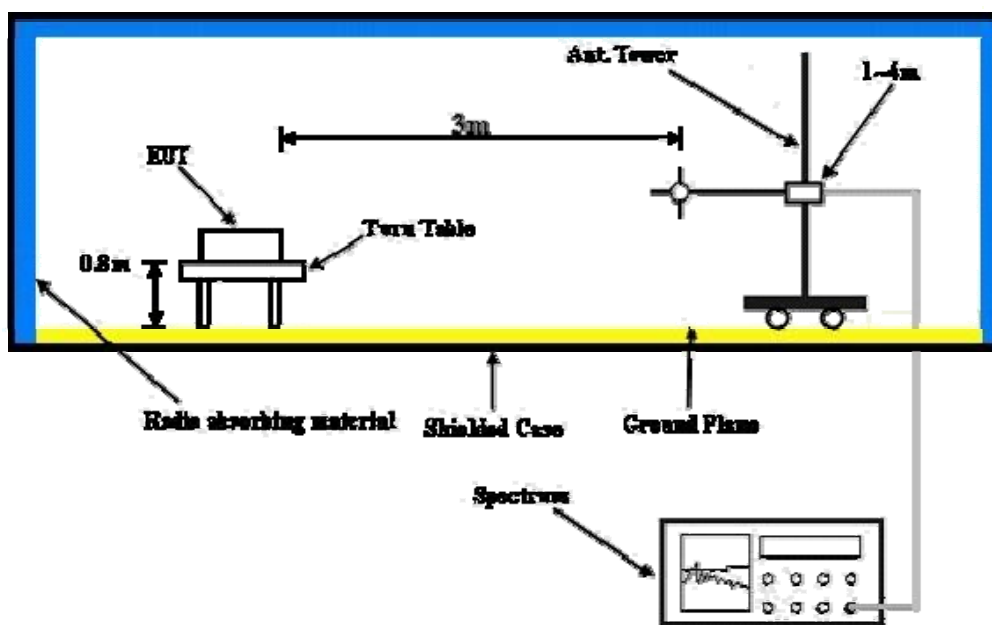

For the actual test configuration, please refer to the attached file (Test Setup Photo).

4.6.5 TEST RESULTS

BELOW 1GHz

GPRS

MODE	TX channel 661	FREQUENCY RANGE	Below 1000MHz
ENVIRONMENTAL CONDITIONS	25deg. C, 65%RH	INPUT POWER	120Vac, 60Hz
TESTED BY	Chris Lin		

ANTENNA POLARITY & TEST DISTANCE: HORIZONTAL AT 3 M							
No.	Freq. (MHz)	Reading (dBm)	S.G Power Value (dBm)	Correction Factor (dB)	EIRP (dBm)	Limit (dBm)	Margin (dB)
1	39.70	-65.85	-50.82	-10.93	-61.75	-13.00	-48.75
2	148.34	-66.00	-70.00	-0.19	-70.19	-13.00	-57.19
3	489.78	-70.72	-75.32	4.92	-70.40	-13.00	-57.40
4	693.48	-71.57	-73.40	5.20	-68.20	-13.00	-55.20
5	825.40	-71.54	-70.18	3.98	-66.20	-13.00	-53.20
6	922.40	-71.57	-69.04	3.91	-65.13	-13.00	-52.13
ANTENNA POLARITY & TEST DISTANCE: VERTICAL AT 3 M							
No.	Freq. (MHz)	Reading (dBm)	S.G Power Value (dBm)	Correction Factor (dB)	EIRP (dBm)	Limit (dBm)	Margin (dB)
1	39.70	-55.65	-50.52	-10.93	-61.45	-13.00	-48.45
2	152.22	-72.10	-71.51	-0.04	-71.55	-13.00	-58.55
3	418.00	-70.45	-74.06	5.21	-68.85	-13.00	-55.85
4	654.68	-72.24	-71.82	4.88	-66.94	-13.00	-53.94
5	753.62	-71.34	-68.43	4.58	-63.85	-13.00	-50.85
6	951.50	-73.02	-66.64	3.90	-62.74	-13.00	-49.74

REMARKS:

1. Power Value (dBm) = S.G Power Value (dBm) + Correction Factor (dB).
2. Correction Factor (dB) = Substitution Antenna Gain (dB) + Cable Loss (dB).



A D T

ABOVE 1GHz

GPRS

MODE	Channel 512	FREQUENCY RANGE	Above 1000MHz
ENVIRONMENTAL CONDITIONS	25deg. C, 65%RH	INPUT POWER	120Vac, 60Hz
TESTED BY	Chris Lin		

ANTENNA POLARITY & TEST DISTANCE: HORIZONTAL AT 3 M							
No.	Freq. (MHz)	Reading (dBm)	S.G Power Value (dBm)	Correction Factor (dB)	EIRP (dBm)	Limit (dBm)	Margin (dB)
1	3700.40	-54.12	-50.03	7.16	-42.87	-13.00	-29.87
2	5550.60	-56.74	-45.79	6.78	-39.01	-13.00	-26.01
3	7400.80	-56.41	-39.25	4.31	-34.94	-13.00	-21.94
ANTENNA POLARITY & TEST DISTANCE: VERTICAL AT 3 M							
No.	Freq. (MHz)	Reading (dBm)	S.G Power Value (dBm)	Correction Factor (dB)	EIRP (dBm)	Limit (dBm)	Margin (dB)
1	3700.40	-56.14	-52.27	7.16	-45.11	-13.00	-32.11
2	5550.60	-53.12	-43.67	6.78	-36.89	-13.00	-23.89
3	7400.80	-56.32	-39.83	4.31	-35.52	-13.00	-22.52

REMARKS:

1. Power Value (dBm) = S.G Power Value (dBm) + Correction Factor (dB).
2. Correction Factor (dB) = Substitution Antenna Gain (dB) + Cable Loss (dB).



A D T

MODE	Channel 661	FREQUENCY RANGE	Above 1000MHz
ENVIRONMENTAL CONDITIONS	25deg. C, 65%RH	INPUT POWER	120Vac, 60Hz
TESTED BY	Chris Lin		

ANTENNA POLARITY & TEST DISTANCE: HORIZONTAL AT 3 M							
No.	Freq. (MHz)	Reading (dBm)	S.G Power Value (dBm)	Correction Factor (dB)	EIRP (dBm)	Limit (dBm)	Margin (dB)
1	3760.00	-54.96	-50.61	7.10	-43.51	-13.00	-30.51
2	5640.00	-56.20	-45.20	6.77	-38.43	-13.00	-25.43
3	7520.00	-56.69	-39.15	4.23	-34.92	-13.00	-21.92

ANTENNA POLARITY & TEST DISTANCE: VERTICAL AT 3 M							
No.	Freq. (MHz)	Reading (dBm)	S.G Power Value (dBm)	Correction Factor (dB)	EIRP (dBm)	Limit (dBm)	Margin (dB)
1	3760.00	-53.35	-49.34	7.10	-42.24	-13.00	-29.24
2	5640.00	-56.26	-46.49	6.77	-39.72	-13.00	-26.72
3	7520.00	-55.37	-38.62	4.23	-34.39	-13.00	-21.39

REMARKS:

1. Power Value (dBm) = S.G Power Value (dBm) + Correction Factor (dB).
2. Correction Factor (dB) = Substitution Antenna Gain (dB) + Cable Loss (dB).



A D T

MODE	Channel 810	FREQUENCY RANGE	Above 1000MHz
ENVIRONMENTAL CONDITIONS	25deg. C, 65%RH	INPUT POWER	120Vac, 60Hz
TESTED BY	Chris Lin		

ANTENNA POLARITY & TEST DISTANCE: HORIZONTAL AT 3 M							
No.	Freq. (MHz)	Reading (dBm)	S.G Power Value (dBm)	Correction Factor (dB)	EIRP (dBm)	Limit (dBm)	Margin (dB)
1	3819.60	-55.43	-50.82	7.05	-43.77	-13.00	-30.77
2	5729.40	-57.63	-46.55	6.74	-39.81	-13.00	-26.81
3	7639.20	-54.12	-36.35	4.20	-32.15	-13.00	-19.15
ANTENNA POLARITY & TEST DISTANCE: VERTICAL AT 3 M							
No.	Freq. (MHz)	Reading (dBm)	S.G Power Value (dBm)	Correction Factor (dB)	EIRP (dBm)	Limit (dBm)	Margin (dB)
1	3819.60	-56.13	-51.99	7.05	-44.94	-13.00	-31.94
2	5729.40	-56.13	-46.01	6.74	-39.27	-13.00	-26.27
3	7639.20	-54.85	-37.93	4.20	-33.73	-13.00	-20.73

REMARKS:

1. Power Value (dBm) = S.G Power Value (dBm) + Correction Factor (dB).
2. Correction Factor (dB) = Substitution Antenna Gain (dB) + Cable Loss (dB).



A D T

5 PHOTOGRAPHS OF THE TEST CONFIGURATION

Please refer to the attached file (Test Setup Photo).



6 INFORMATION ON THE TESTING LABORATORIES

We, Bureau Veritas Consumer Products Services (H.K.) Ltd., Taoyuan Branch, were founded in 1988 to provide our best service in EMC, Radio, Telecom and Safety consultation. Our laboratories are accredited and approved according to ISO/IEC 17025.

If you have any comments, please feel free to contact us at the following:

Linko EMC/RF Lab

Tel: 886-2-26052180

Fax: 886-2-26051924

Hsin Chu EMC/RF Lab

Tel: 886-3-5935343

Fax: 886-3-5935342

Hwa Ya EMC/RF/Safety/Telecom Lab

Tel: 886-3-3183232

Fax: 886-3-3270892

Email: service.adt@tw.bureauveritas.com

Web Site: www.bureauveritas-adt.com

The address and road map of all our labs can be found in our web site also.



A D T

7 APPENDIX A – MODIFICATIONS RECORDERS FOR ENGINEERING CHANGES TO THE EUT BY THE LAB

No any modifications are made to the EUT by the lab during the test.

---END---