

# FCC RF Test Report

APPLICANT : Fujitsu Toshiba Mobile Communications Ltd.  
EQUIPMENT : CDMA FJI11(GSM900/1800/1900,CDMA2000,Bluetooth and Wi-Fi)  
BRAND NAME : Fujitsu Toshiba Mobile Communications Ltd.  
MODEL NAME : FJI11  
FCC ID : YUW-FJI11  
STANDARD : FCC 47 CFR Part 2, 22(H), 24(E)  
CLASSIFICATION : PCS Licensed Transmitter Held to Ear (PCE)  
Tx/Rx FREQUENCY RANGE : GSM1900 : 1850.2 ~ 1909.8 MHz /  
1930.2 ~ 1989.8 MHz  
CDMA2000 BC0 : 824.70 ~ 848.31 MHz /  
869.70 ~ 893.31 MHz  
MAX. ERP/EIRP POWER : GSM1900 (GSM) : 0.20 W  
CDMA2000 BC0 : 0.08 W  
EMISSION DESIGNATOR : GMSK : 242KGXW  
QPSK : 1M27F9W

The product was received on Aug. 19, 2011 and completely tested on Sep. 28, 2011. We, SPORTON INTERNATIONAL INC., would like to declare that the tested sample has been evaluated in accordance with the procedures given in ANSI / TIA / EIA-603-C-2004 and shown compliance with the applicable technical standards.

The test results in this report apply exclusively to the tested model / sample. Without written approval of SPORTON INTERNATIONAL INC., the test report shall not be reproduced except in full.

Reviewed by:



Jones Tsai / Manager



## SPORTON INTERNATIONAL INC.

No. 52, Hwa Ya 1<sup>st</sup> Rd., Hwa Ya Technology Park, Kwei-Shan Hsiang, Tao Yuan Hsien, Taiwan, R.O.C.



# TABLE OF CONTENTS

**REVISION HISTORY..... 3**

**SUMMARY OF TEST RESULT ..... 4**

**1 GENERAL DESCRIPTION ..... 5**

    1.1 Applicant..... 5

    1.2 Manufacturer ..... 5

    1.3 Feature of Equipment Under Test..... 5

    1.4 Testing Site..... 6

    1.5 Applied Standards ..... 6

    1.6 Ancillary Equipment List..... 6

**2 TEST CONFIGURATION OF EQUIPMENT UNDER TEST ..... 7**

    2.1 Test Mode..... 7

    2.2 Connection Diagram of Test System ..... 8

**3 TEST RESULT..... 9**

    3.1 Conducted Output Power Measurement..... 9

    3.2 Effective Radiated Power and Effective Isotropic Radiated Power Measurement ..... 11

    3.3 Occupied Bandwidth Measurement ..... 14

    3.4 Band Edge Measurement..... 17

    3.5 Conducted Emission Measurement ..... 20

    3.6 Field Strength of Spurious Radiation Measurement ..... 26

    3.7 Frequency Stability Measurement..... 32

**4 LIST OF MEASURING EQUIPMENT ..... 36**

**5 UNCERTAINTY OF EVALUATION ..... 37**

**APPENDIX A. PHOTOGRAPHS OF EUT**

**APPENDIX B. SETUP PHOTOGRAPHS**





### SUMMARY OF TEST RESULT

Report Section	FCC Rule	IC Rule	Description	Limit	Result	Remark
3.1	§2.1046	N/A	Conducted Output Power	N/A	PASS	-
3.2	§22.913(a)(2)	RSS-132(4.4) SRSP-503(5.1.3)	Effective Radiated Power	< 7 Watts	PASS	-
3.2	§24.232(c)	RSS-133 (6.4) SRSP-510(5.1.2)	Equivalent Isotropic Radiated Power	< 2 Watts	PASS	-
3.3	§2.1049 §22.917(a) §24.238(a)	N/A	Occupied Bandwidth	N/A	PASS	-
3.4	§2.1051 §22.917(a) §24.238(a)	RSS-132 (4.5.1) RSS-133 (6.5.1)	Band Edge Measurement	< 43+10log <sub>10</sub> (P[Watts])	PASS	-
3.5	§2.1051 §22.917(a) §24.238(a)	RSS-132 (4.5.1) RSS-133 (6.5.1)	Conducted Emission	< 43+10log <sub>10</sub> (P[Watts])	PASS	-
3.6	§2.1053 §22.917(a) §24.238(a)	RSS-132 (4.5.1) RSS-133 (6.5.1)	Field Strength of Spurious Radiation	< 43+10log <sub>10</sub> (P[Watts])	PASS	Under limit 14.94 dB at 4182 MHz
3.7	§2.1055 §22.355 §24.235	RSS-132(4.3) RSS-133(6.3)	Frequency Stability for Temperature & Voltage	< 2.5 ppm	PASS	-

# 1 General Description

## 1.1 Applicant

**Fujitsu Toshiba Mobile Communications Ltd.**

1-1, Kamikodanaka 4-chome, Nakahara-ku Kawasaki 211-8588, Japan

## 1.2 Manufacturer

**Fujitsu Toshiba Mobile Communications Ltd.**

1-1, Kamikodanaka 4-chome, Nakahara-ku Kawasaki 211-8588, Japan

## 1.3 Feature of Equipment Under Test

Product Feature & Specification	
<b>Equipment</b>	CDMA FJI11(GSM900/1800/1900,CDMA2000,Bluetooth and Wi-Fi)
<b>Brand Name</b>	Fujitsu Toshiba Mobile Communications Ltd.
<b>Model Name</b>	FJI11
<b>FCC ID</b>	YUW-FJI11
<b>Tx Frequency</b>	GSM1900 : 1850 MHz ~ 1910 MHz CDMA2000 BC0 : 824 MHz ~ 849 MHz
<b>Rx Frequency</b>	GSM1900 : 1930 MHz ~ 1990 MHz CDMA2000 BC0 : 869 MHz ~ 894 MHz
<b>Maximum Output Power to Antenna</b>	GSM1900 : 30.77 dBm CDMA2000 BC0 : 24.09 dBm
<b>Maximum ERP/EIRP</b>	GSM1900 (GSM) : 0.20 W (23.02 dBm) CDMA2000 BC0 : 0.08 W (19.29 dBm)
<b>Antenna Type</b>	Fixed Internal Antenna
<b>HW Version</b>	CS1.0
<b>SW Version</b>	CS1.0
<b>Type of Modulation</b>	GSM / GPRS: GMSK CDMA: QPSK
<b>Type of Emission</b>	GMSK : 242KGXW QPSK : 1M27F9W
<b>EUT Stage</b>	Identical Prototype

**Remark:**

1. For other wireless features of this EUT, the test report will be issued separately.
2. This test report recorded only product characteristics and test results of PCS Licensed Transmitter Held to Ear (PCE).
3. The above EUT's information was declared by manufacturer. Please refer to the specifications or user's manual for more detailed description.

## 1.4 Testing Site

<b>Test Site</b>	SPORTON INTERNATIONAL INC.		
<b>Test Site Location</b>	No. 52, Hwa Ya 1 <sup>st</sup> Rd., Hwa Ya Technology Park, Kwei-Shan Hsiang, Tao Yuan Hsien, Taiwan, R.O.C. TEL: +886-3-327-3456 FAX: +886-3-328-4978		
<b>Test Site No.</b>	<b>Sporton Site No.</b>		<b>FCC/IC Registration No.</b>
	TH02-HY	03CH06-HY	722060/4086B-1

## 1.5 Applied Standards

According to the specifications of the manufacturer, the EUT must comply with the requirements of the following standards:

- ♦ Preliminary Guidance for Receiving Applications for Certification of 3G Device. May 9, 2006.
- ♦ FCC 47 CFR Part 2, 22(H), 24(E)
- ♦ ANSI / TIA / EIA-603-C-2004
- ♦ IC RSS-132 Issue 2
- ♦ IC RSS-133 Issue 5

**Remark:**

1. All test items were verified and recorded according to the standards and without any deviation during the test.
2. This EUT has also been tested and complied with the requirements of FCC Part 15, Subpart B (DoC), recorded in a separate test report.

## 1.6 Ancillary Equipment List

Item	Equipment	Trade Name	Model No.	FCC ID	Data Cable	Power Cord
1.	System Simulator	R&S	CMU200	N/A	N/A	Unshielded, 1.8 m
2.	AC Adapter	KDDI	0204 PTA	N/A	N/A	Shielded, 1.6m

## 2 Test Configuration of Equipment Under Test

### 2.1 Test Mode

During all testing, EUT is in link mode with base station emulator at maximum power level. The spurious emission measurements were carried out in semi-anechoic chamber with 3-meter test range, and EUT is rotated on three test planes to find out the worst emission.

Frequency range investigated for radiated emission is as follows:

1. 30 MHz to 9000 MHz for CDMA2000 BC0.
2. 30 MHz to 19000 MHz for GSM1900.

Test Modes		
Band	Radiated TCs	Conducted TCs
GSM 1900	■ GSM Link	■ GSM Link
CDMA2000 BC0	■ 1xRTT Link Mode	■ 1xRTT Link Mode

**Note:**

1. The maximum power levels are GSM for GMSK link and 1xRTT RC3+SO32(+SCH) mode for CDMA2000 BC0, only these modes were used for all tests.
2. Because there are individual antennas for each WWAN, WLAN, and Bluetooth, the co-location test modes are not required.

The conducted power tables are as follows:

Conducted Power (*Unit: dBm)			
Band	GSM1900		
Channel	512	661	810
Frequency	1850.2	1880.0	1909.8
GSM	30.77	30.68	30.54
GPRS 8	30.60	30.48	30.35
GPRS 10	29.34	29.36	29.31
GPRS 11	28.00	28.19	28.28
GPRS 12	26.60	26.95	27.25

Conducted Power (*Unit: dBm)			
Band	CDMA2000 BC0		
Channel	1013	384	777
Frequency	824.7	836.52	848.31
1xRTT RC1+SO55	23.95	23.96	23.93
1xRTT RC3+SO55	23.83	23.88	23.92
1xRTT RC3+SO32(+F-SCH)	23.91	23.86	23.92
1xRTT RC3+SO32(+SCH)	23.94	24.09	23.90

## 2.2 Connection Diagram of Test System

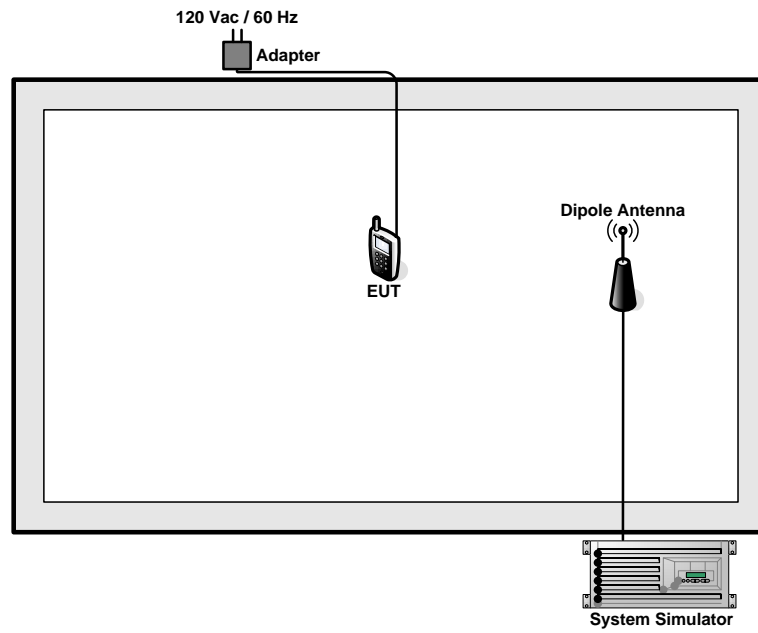



### 3 Test Result

#### 3.1 Conducted Output Power Measurement

##### 3.1.1 Description of the Conducted Output Power Measurement

A base station simulator was used to establish communication with the EUT. Its parameters were set to transmit the maximum power on the EUT. The measured power in the radio frequency on the transmitter output terminals shall be reported.

##### 3.1.2 Measuring Instruments

See list of measuring instruments of this test report.

##### 3.1.3 Test Procedures

1. The transmitter output port was connected to base station.
2. Set EUT at maximum power through base station.
3. Select lowest, middle, and highest channels for each band and different modulation.

##### 3.1.4 Test Setup

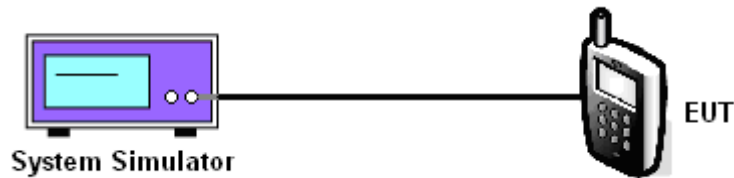



3.1.5 Test Result of Conducted Output Power

CDMA2000 BC0					
Test Mode	Test Status	Channel	Frequency (MHz)	Conducted Power (dBm)	Conducted Power (Watts)
CDMA 2000 1xRTT	RC3+SO32	1013 (Low)	824.70	23.95	0.25
		384 (Mid)	836.52	24.09	0.26
		777 (High)	848.31	23.93	0.25

PCS Band				
Modes	Channel	Frequency (MHz)	Conducted Power (dBm)	Conducted Power (Watts)
GSM1900 (GSM)	512 (Low)	1850.2	30.77	1.19
	661 (Mid)	1880.0	30.68	1.17
	810 (High)	1909.8	30.54	1.13



## **3.2 Effective Radiated Power and Effective Isotropic Radiated Power Measurement**

### **3.2.1 Description of the ERP/EIRP Measurement**

ERP/EIRP is measured by substitution method according to ANSI / TIA / EIA-603-C-2004. The ERP of mobile transmitters must not exceed 7 Watts and the EIRP of mobile transmitters are limited to 2 Watts.

### **3.2.2 Measuring Instruments**

See list of measuring instruments of this test report.

### **3.2.3 Test Procedures**

1. The EUT was placed on a non-conductive rotating platform with 0.8 meter height in a semi-anechoic chamber. The radiated emission at the fundamental frequency was measured at 3 m with a test antenna and a spectrum analyzer with RBW= 3MHz,VBW= 3MHz, and peak detector settings.
2. During the measurement, the EUT was enforced in maximum power and linked with a base station. The highest emission was recorded from analyzer power level (LVL) from the 360 degrees rotation of the turntable and the test antenna raised and lowered over a range from 1 to 4 meters in both horizontally and vertically polarized orientations.
3. Effective Isotropic Radiated Power (EIRP) was measured by substitution method according to TIA/EIA-603-C. The EUT was replaced by dipole antenna (substitution antenna) at same location, and then a known power from S.G. was applied into the dipole antenna through a Tx cable, and then recorded the maximum Analyzer reading through raised and lowered the test antenna. The correction factor (in dB) = S.G. - Tx Cable loss + Substitution antenna gain - Analyzer reading. Then the EUT's EIRP was calculated with the correction factor,  $EIRP = LVL + \text{Correction factor}$  and  $ERP = EIRP - 2.15$ .

### 3.2.4 Test Setup

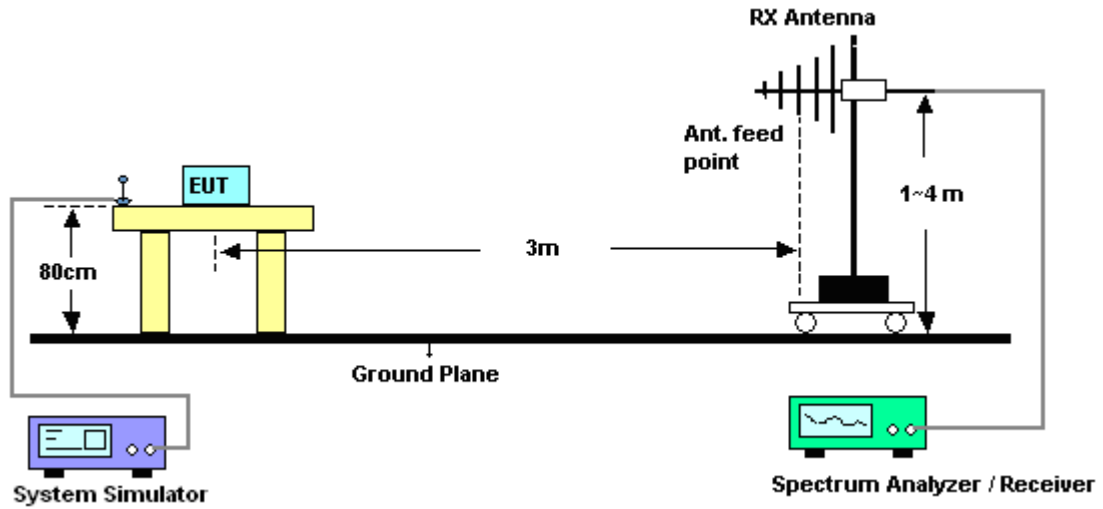

3.2.5 Test Result of ERP

CDMA2000 BC0 1xRTT_RC3+SO32 Radiated Power ERP				
Horizontal Polarization				
Frequency (MHz)	LVL (dBm)	Correction Factor (dB)	ERP (dBm)	ERP (W)
824.70	-7.68	28.19	18.36	0.07
836.52	-8.02	28.22	18.05	0.06
848.31	-6.94	28.38	19.29	0.08
Vertical Polarization				
Frequency (MHz)	LVL (dBm)	Correction Factor (dB)	ERP (dBm)	ERP (W)
824.70	-19.86	31.46	9.45	0.01
836.52	-21.15	31.5	8.20	0.01
848.31	-19.68	31.43	9.60	0.01

\* ERP = LVL (dBm) + Correction Factor (dB) – 2.15

3.2.6 Test Result of EIRP

GSM1900 (GSM) Radiated Power EIRP				
Horizontal Polarization				
Frequency (MHz)	LVL (dBm)	Correction Factor (dB)	EIRP (dBm)	EIRP (W)
1850.2	-19.35	41.93	22.58	0.18
1880.0	-19.94	42.33	22.39	0.17
1909.8	-19.02	42.04	23.02	0.20
Vertical Polarization				
Frequency (MHz)	LVL (dBm)	Correction Factor (dB)	EIRP (dBm)	EIRP (W)
1850.2	-27.14	41.18	14.04	0.03
1880.0	-28.26	42.59	14.33	0.03
1909.8	-27.60	41.92	14.32	0.03

\* EIRP = LVL (dBm) + Correction Factor (dB)

### 3.3 Occupied Bandwidth Measurement

#### 3.3.1 Description of Occupied Bandwidth Measurement

The emission bandwidth is defined as the width of the signal between two points, located at the 2 sides of the carrier frequency, outside of which all emissions are attenuated at least 26 dB below the transmitter power.

#### 3.3.2 Measuring Instruments

See list of measuring instruments of this test report.

#### 3.3.3 Test Procedures

1. The EUT was connected to Spectrum Analyzer and Base Station via power divider.
2. The 99% and 26 dB occupied bandwidth (BW) of the middle channel for the highest RF powers were measured.

#### 3.3.4 Test Setup

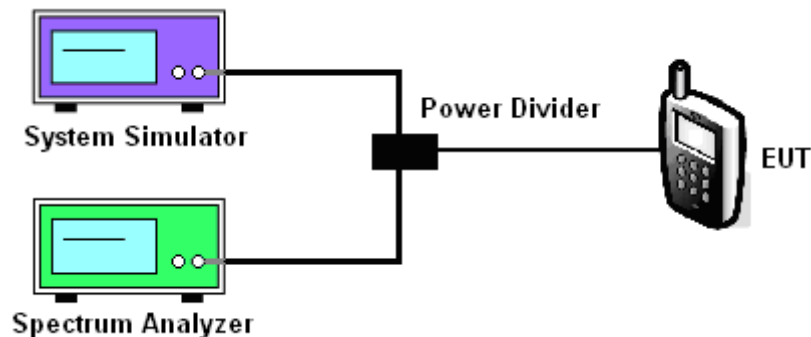



### 3.3.5 Test Result (Plots) of Occupied Bandwidth

<b>Band :</b>	CDMA2000 BC0	<b>Power Stage :</b>	High
<b>Test Mode :</b>	1xRTT_RC3+SO32		

99% Occupied Bandwidth Plot on Channel 384

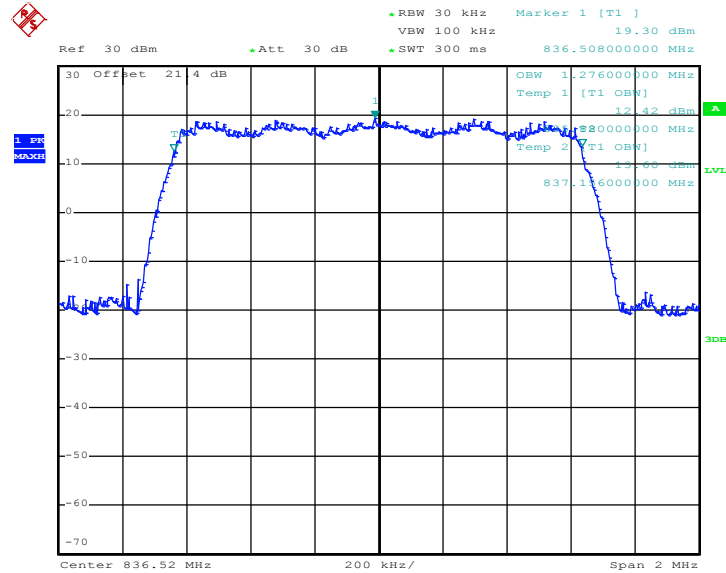

Date: 9.SEP.2011 18:40:09

26dB Bandwidth Plot on Channel 384

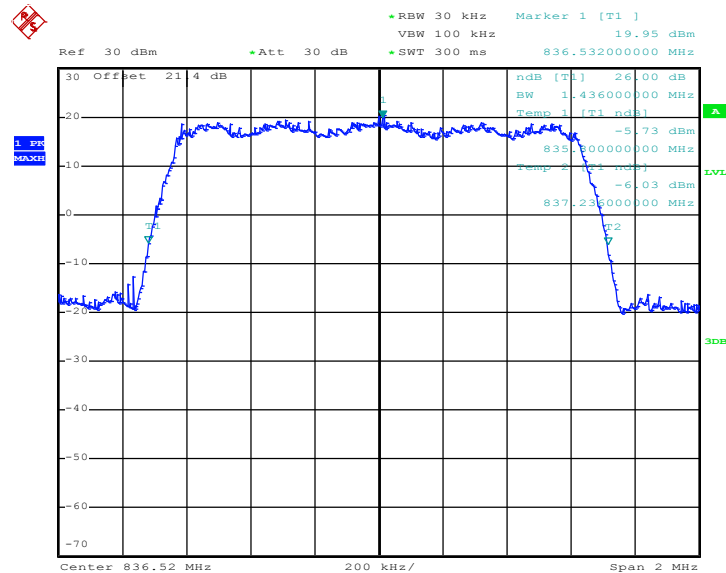

Date: 9.SEP.2011 18:30:18



<b>Band :</b>	GSM 1900	<b>Power Stage :</b>	High
<b>Test Mode :</b>	GSM Link		

99% Occupied Bandwidth Plot on Channel 661

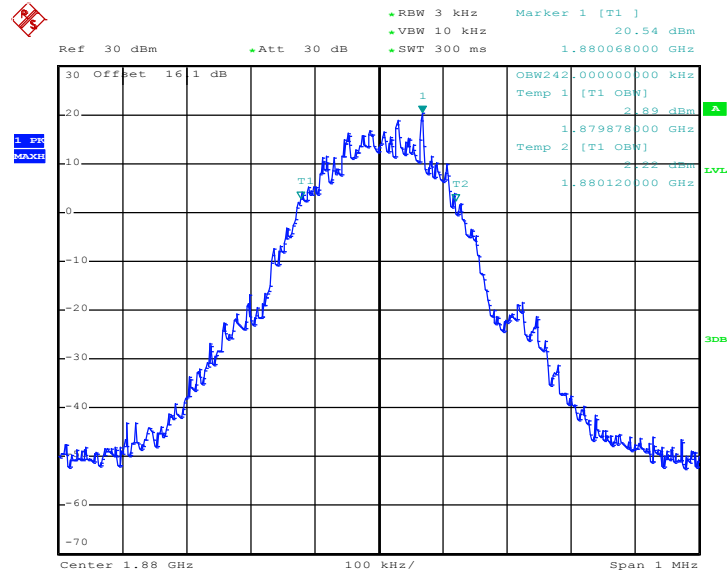

Date: 24.AUG.2011 00:20:51

26dB Bandwidth Plot on Channel 661

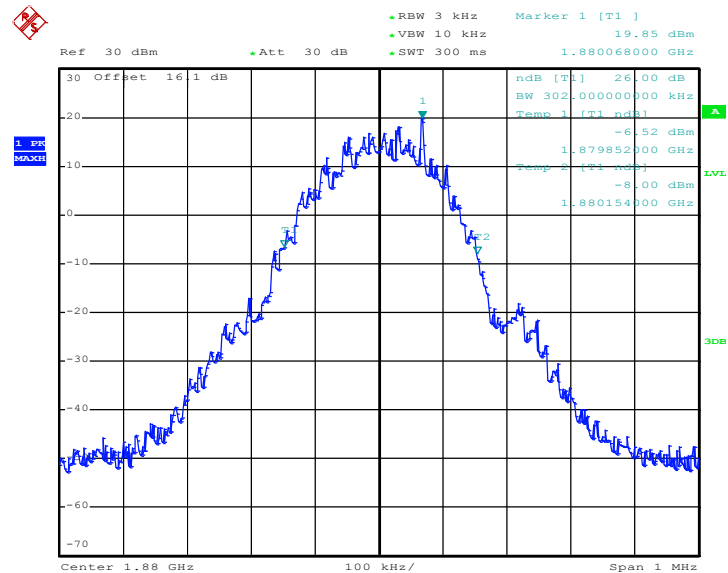

Date: 24.AUG.2011 00:19:32



## 3.4 Band Edge Measurement

### 3.4.1 Description of Band Edge Measurement

The power of any emission outside of the authorized operating frequency ranges must be lower than the transmitter power (P) by a factor of at least  $43 + 10 \log (P)$  dB.

### 3.4.2 Measuring Instruments

See list of measuring instruments of this test report.

### 3.4.3 Test Procedures

1. The EUT was connected to Spectrum Analyzer and Base Station via power divider.
2. The band edges of low and high channels for the highest RF powers were measured. Setting RBW as roughly  $BW/100$ .
3. The RBW was replaced by 10 kHz, due to the spectrum analyzer IF-Filter including an excess of the limit. A worst case correction factor of  $10 \log (1\% BW/\text{measurement RBW})$  was implemented.

### 3.4.4 Test Setup

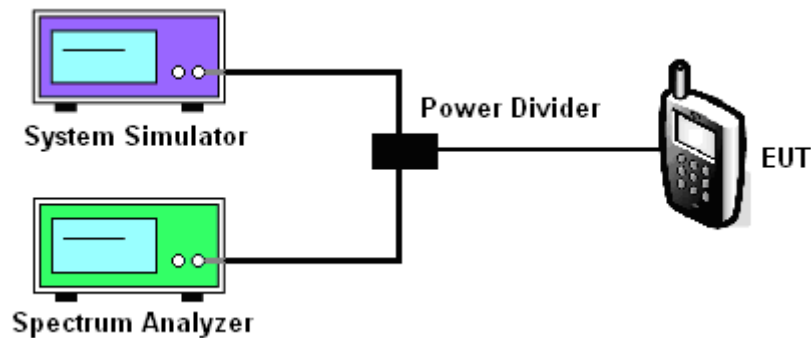



### 3.4.5 Test Result (Plots) of Conducted Band Edge

<b>Band :</b>	CDMA2000 BC0	<b>Power Stage :</b>	High
<b>Test Mode :</b>	1xRTT_RC3+SO32		

Lower Band Edge Plot on Channel 1013

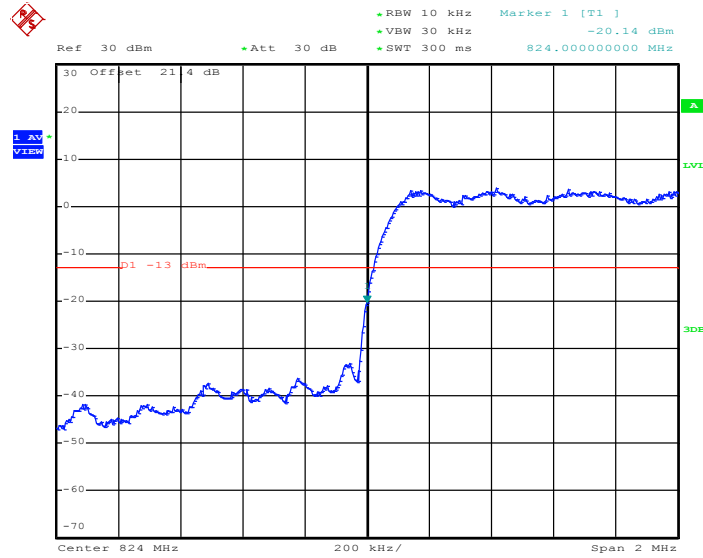

Date: 9.SEP.2011 18:47:21

Higher Band Edge Plot on Channel 777

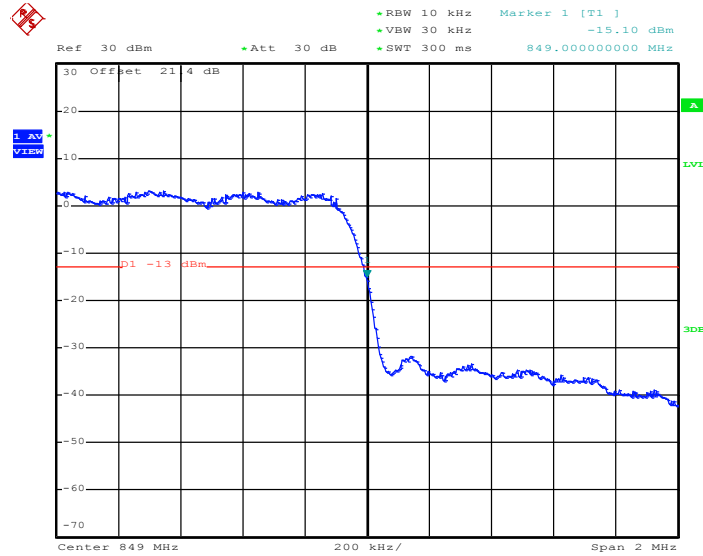

Date: 9.SEP.2011 18:48:42



Band :	GSM1900	Power Stage :	High
Test Mode :	GSM Link		

Lower Band Edge Plot on Channel 512

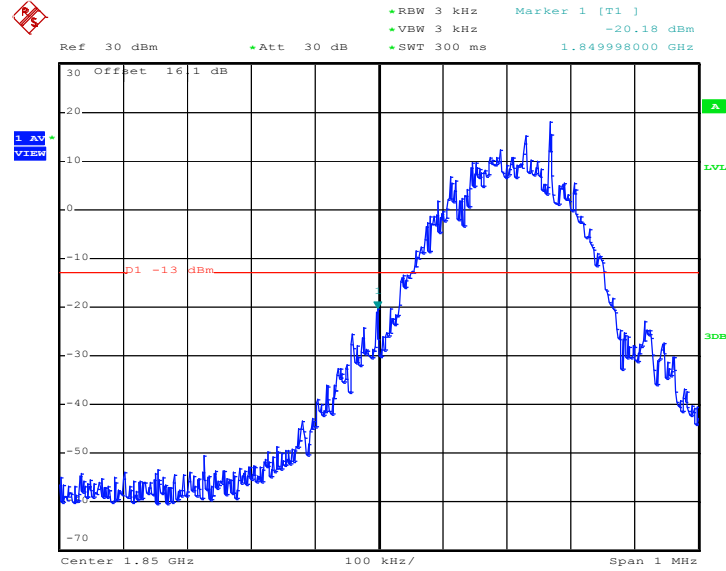

Date: 24.AUG.2011 00:22:43

Higher Band Edge Plot on Channel 810

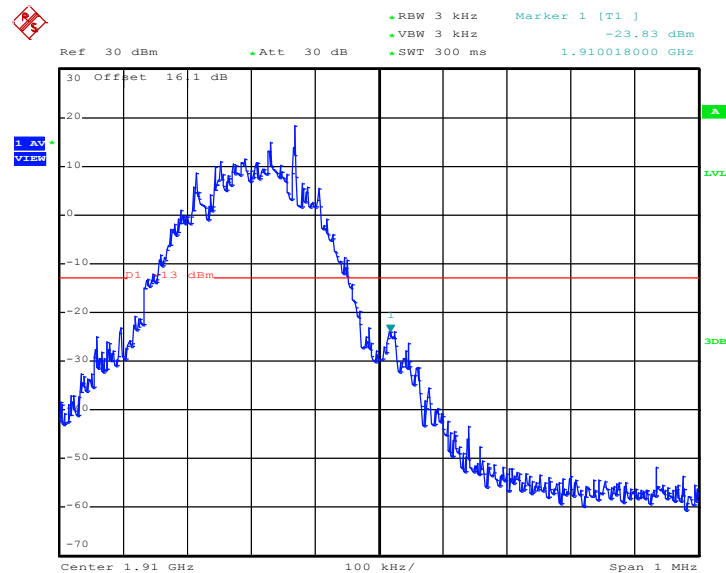

Date: 24.AUG.2011 00:23:09

## 3.5 Conducted Emission Measurement

### 3.5.1 Description of Conducted Emission Measurement

The power of any emission outside of the authorized operating frequency ranges must be lower than the transmitter power (P) by a factor of at least  $43 + 10 \log (P)$  dB.

It is measured by means of a calibrated spectrum analyzer and scanned from 30 MHz up to a frequency including its 10<sup>th</sup> harmonic.

### 3.5.2 Measuring Instruments

See list of measuring instruments of this test report.

### 3.5.3 Test Procedures

1. The EUT was connected to spectrum analyzer and base station via power divider.
2. The middle channel for the highest RF power within the transmitting frequency was measured.
3. The conducted spurious emission for the whole frequency range was taken.

### 3.5.4 Test Setup

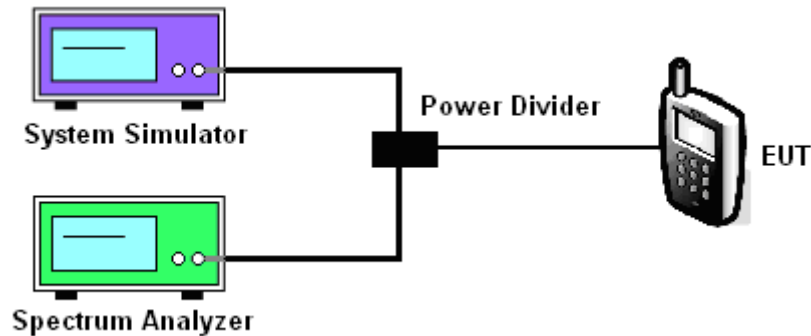

### 3.5.5 Test Result (Plots) of Conducted Emission

<b>Band :</b>	CDMA2000 BC0	<b>Power Stage :</b>	High
<b>Test Mode :</b>	1xRTT_RC3+SO32		

Conducted Emission Plot between 30MHz ~ 1GHz

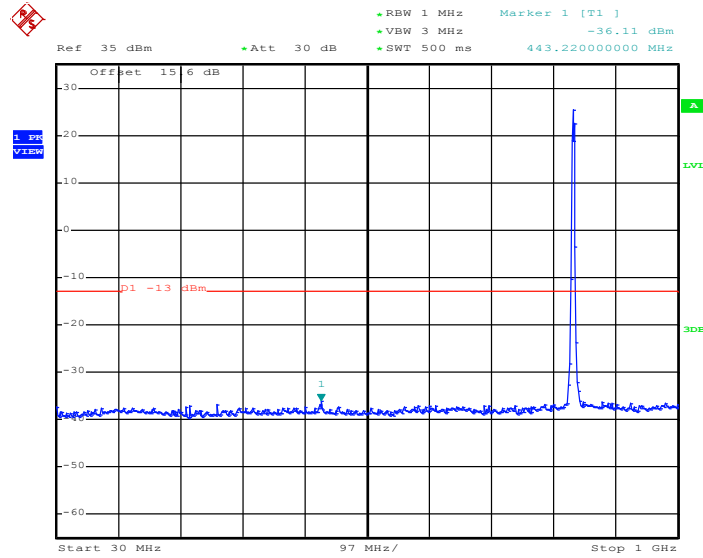

Date: 19.SEP.2011 18:22:00

Conducted Emission Plot between 1GHz ~ 3GHz

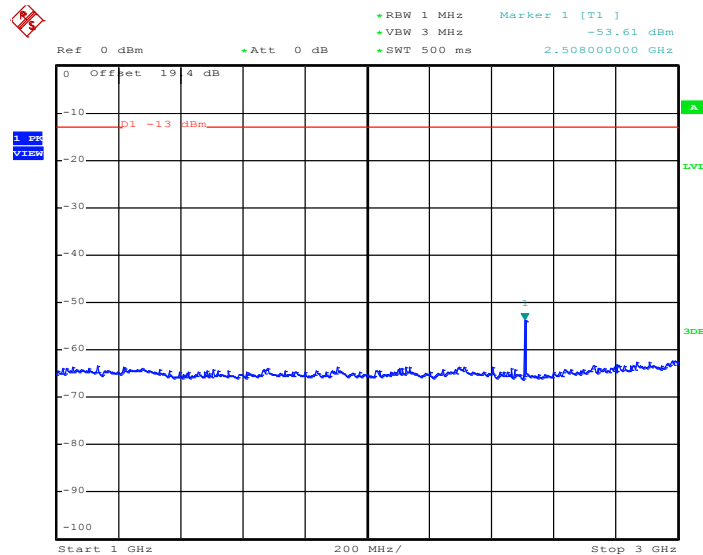

Date: 19.SEP.2011 18:22:21



### Conducted Emission Plot between 3GHz ~ 7GHz

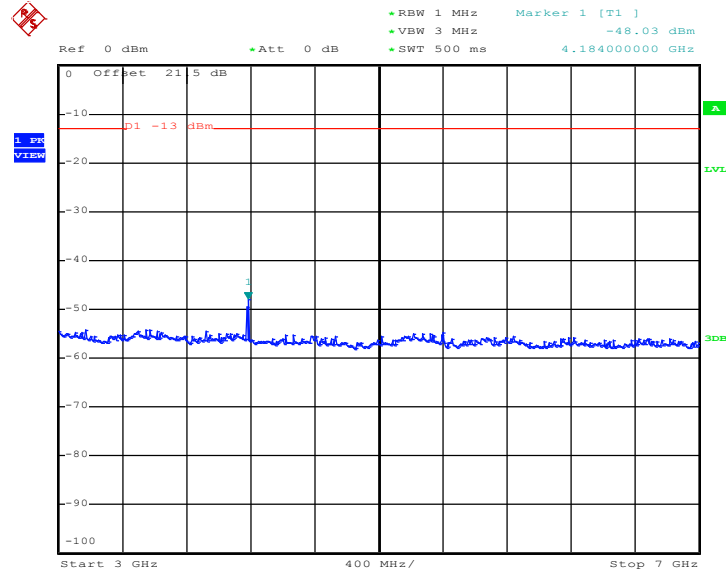

Date: 19.SEP.2011 18:22:34

### Conducted Emission Plot between 7GHz ~ 9GHz

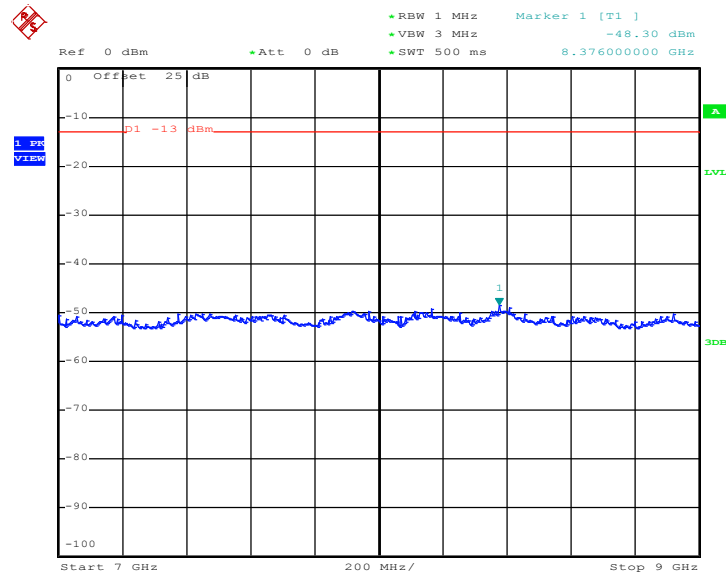

Date: 19.SEP.2011 18:22:47



Band :	GSM1900	Channel :	CH661
Test Mode :	GSM Link		

Conducted Emission Plot between 30MHz ~ 1GHz

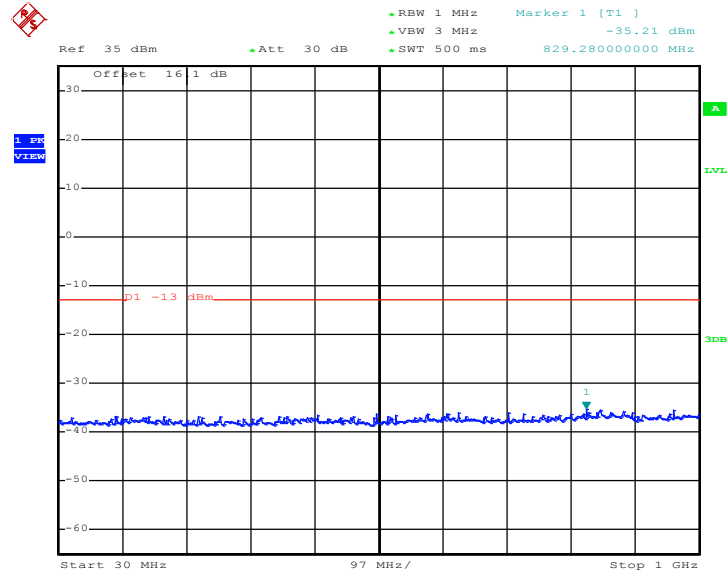

Date: 24.AUG.2011 01:14:08

Conducted Emission Plot between 1GHz ~ 3GHz

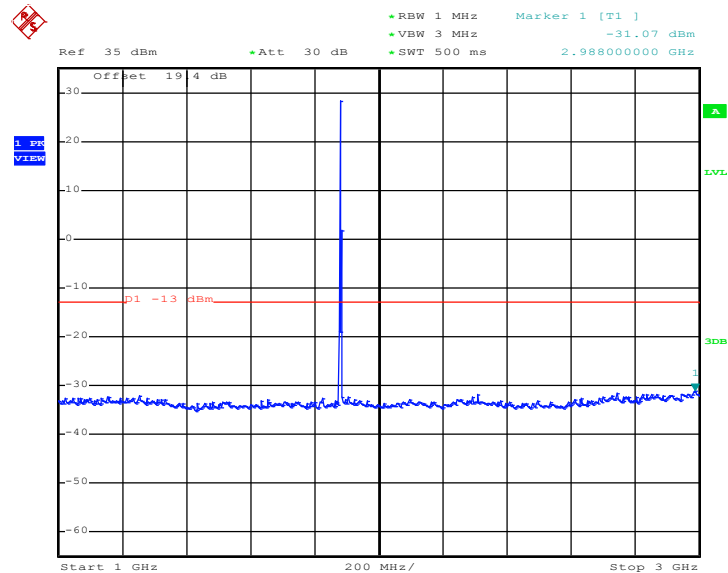

Date: 24.AUG.2011 01:14:20



Conducted Emission Plot between 3GHz ~ 7GHz

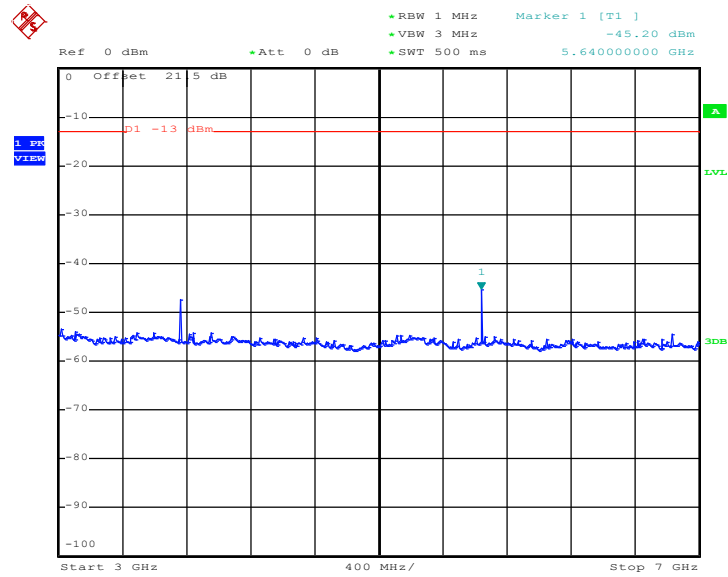

Date: 24.AUG.2011 01:14:36

Conducted Emission Plot between 7GHz ~ 13.6GHz

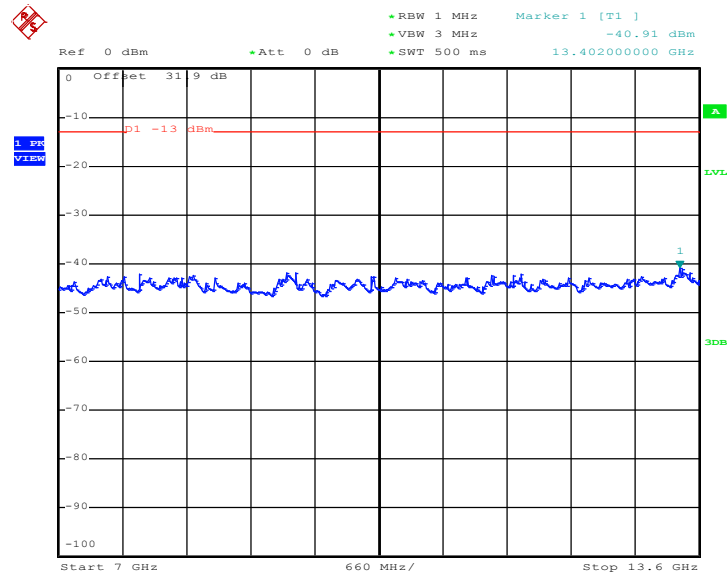

Date: 24.AUG.2011 01:14:48





Conducted Emission Plot between 13.6GHz ~ 19.1GHz

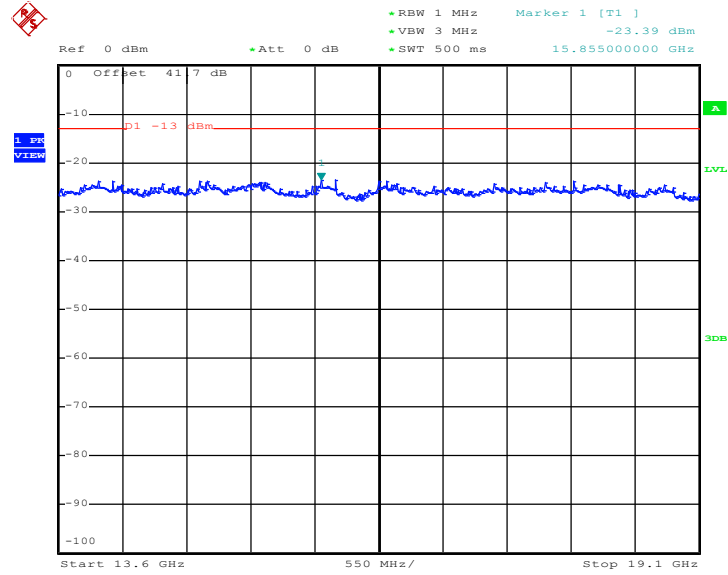

Date: 24.AUG.2011 01:15:01

## 3.6 Field Strength of Spurious Radiation Measurement

### 3.6.1 Description of Field Strength of Spurious Radiated Measurement

The radiated spurious emission was measured by substitution method according to ANSI / TIA / EIA-603-C-2004. The power of any emission outside of the authorized operating frequency ranges must be attenuated below the transmitter power (P) by a factor of at least  $43 + 10 \log (P)$  dB. The spectrum is scanned from 30 MHz up to a frequency including its 10th harmonic.

### 3.6.2 Measuring Instruments

See list of measuring instruments of this test report.

### 3.6.3 Test Procedures

1. The EUT was placed on a rotatable wooden table with 0.8 meter about ground.
2. The EUT was set 3 meters from the receiving antenna, which was mounted on the antenna tower.
3. The table was rotated 360 degrees to determine the position of the highest spurious emission.
4. The height of the receiving antenna is varied between one meter and four meters to search the maximum spurious emission for both horizontal and vertical polarizations.
5. Make the measurement with the spectrum analyzer's RBW = 1MHz, VBW = 3MHz, Sweep = 500ms, Taking the record of maximum spurious emission.
6. A horn antenna was substituted in place of the EUT and was driven by a signal generator.
7. Tune the output power of signal generator to the same emission level with EUT maximum spurious emission.
8. Taking the record of output power at antenna port.
9. Repeat step 7 to step 8 for another polarization.
10.  $EIRP \text{ (dBm)} = S.G. \text{ Power} - Tx \text{ Cable Loss} + Tx \text{ Antenna Gain}$
11.  $ERP \text{ (dBm)} = EIRP - 2.15$

### 3.6.4 Test Setup

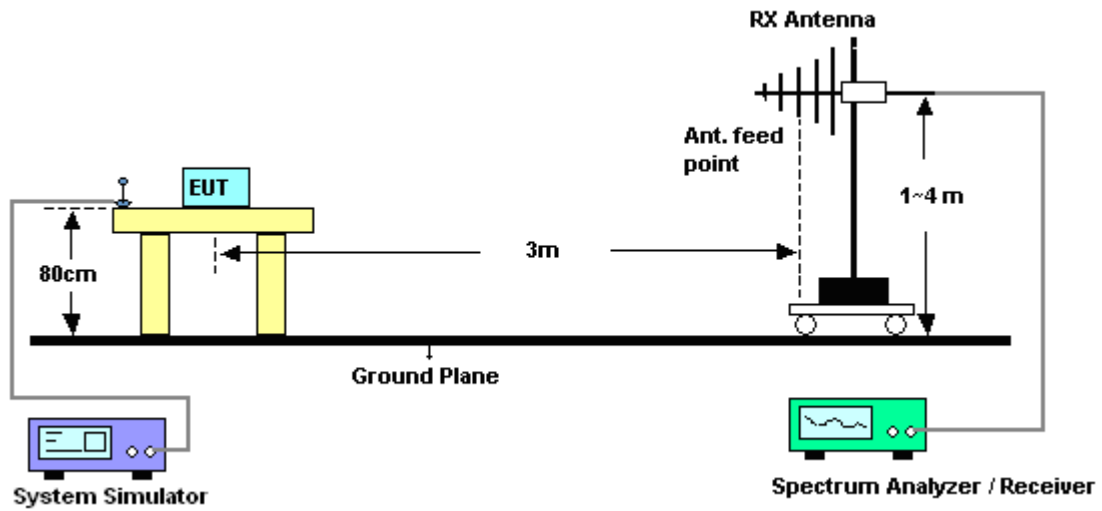



3.6.5 Test Result of Field Strength of Spurious Radiated

Band :	GSM1900	Temperature :	23~24°C
Test Mode :	GSM Link	Relative Humidity :	46~47%
Test Engineer :	Kai Wang	Polarization :	Horizontal
Remark :	Spurious emissions within 30-1000MHz were found more than 20dB below limit line.		

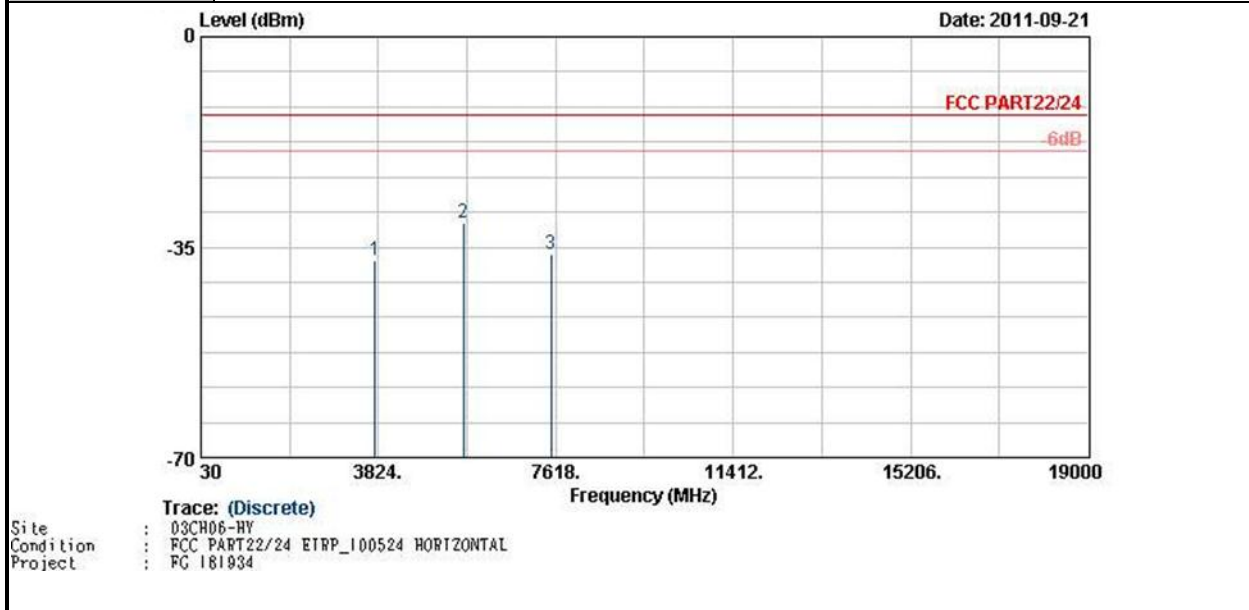

Frequency ( MHz )	ERP ( dBm )	Limit ( dBm )	Over Limit ( dB )	SPA Reading ( dBm )	S.G. Power ( dBm )	TX Cable loss ( dB )	TX Antenna Gain ( dBi )	Polarization ( H/V )	Result
3760	-37.31	-13	-24.31	-54.95	-43.56	2.56	8.81	H	Pass
5636	-30.88	-13	-17.88	-53.59	-38.62	2.96	10.70	H	Pass
7520	-36.12	-13	-23.12	-63.28	-45.02	3.22	12.12	H	Pass



<b>Band :</b>	GSM1900	<b>Temperature :</b>	23~24°C
<b>Test Mode :</b>	GSM Link	<b>Relative Humidity :</b>	46~47%
<b>Test Engineer :</b>	Kai Wang	<b>Polarization :</b>	Vertical
<b>Remark :</b>	Spurious emissions within 30-1000MHz were found more than 20dB below limit line.		

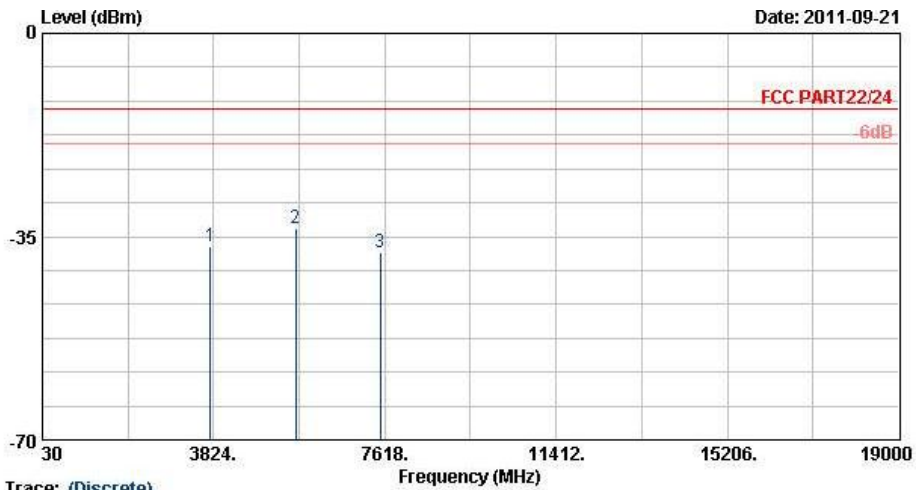

Trace: (Discrete)  
 Site : 03CH06-HY  
 Condition : FCC PART22/24 ETRP\_100524 VERTICAL  
 Project : FG 181934

Frequency (MHz)	ERP (dBm)	Limit (dBm)	Over Limit (dB)	SPA Reading (dBm)	S.G. Power (dBm)	TX Cable loss (dB)	TX Antenna Gain (dBi)	Polarization (H/V)	Result
3760	-36.76	-13	-23.76	-54.09	-43.01	2.56	8.81	V	Pass
5636	-33.49	-13	-20.49	-56.29	-41.23	2.96	10.70	V	Pass
7520	-37.69	-13	-24.69	-64.36	-46.59	3.22	12.12	V	Pass



<b>Band :</b>	CDMA2000 BC0	<b>Temperature :</b>	23~24°C
<b>Test Mode :</b>	1xRTT_RC3+SO32	<b>Relative Humidity :</b>	46~47%
<b>Test Engineer :</b>	Kai Wang	<b>Polarization :</b>	Horizontal
<b>Remark :</b>	Spurious emissions within 30-1000MHz were found more than 20dB below limit line.		

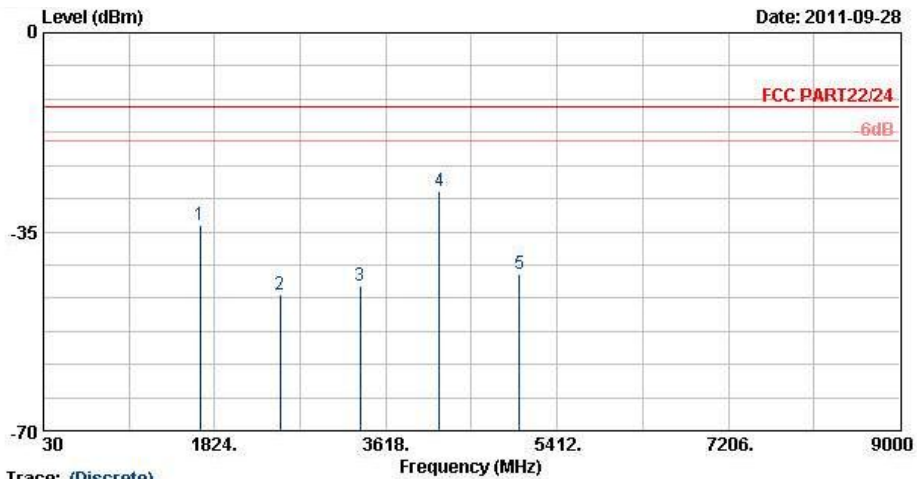

Trace: (Discrete)  
 Site : 03CR06-HY  
 Condition : FCC PART22/24 ETRP\_100524 HORIZONTAL  
 Project : FG 181934

Frequency ( MHz )	ERP ( dBm )	Limit ( dBm )	Over Limit ( dB )	SPA Reading ( dBm )	S.G. Power ( dBm )	TX Cable loss ( dB )	TX Antenna Gain ( dBi )	Polarization ( H/V )	Result
1672	-33.87	-13	-20.87	-44.72	-35.33	1.88	5.49	H	Pass
2509	-46.10	-13	-33.1	-58.70	-47.73	2.44	6.22	H	Pass
3345	-44.56	-13	-31.56	-60.38	-48.01	2.47	8.07	H	Pass
4182	-27.94	-13	-14.94	-47.03	-32.65	2.35	9.21	H	Pass
5018	-42.38	-13	-29.38	-63.62	-47.49	3.05	10.31	H	Pass



<b>Band :</b>	CDMA2000 BC0	<b>Temperature :</b>	23~24°C
<b>Test Mode :</b>	1xRTT_RC3+SO32	<b>Relative Humidity :</b>	46~47%
<b>Test Engineer :</b>	Kai Wang	<b>Polarization :</b>	Vertical
<b>Remark :</b>	Spurious emissions within 30-1000MHz were found more than 20dB below limit line.		

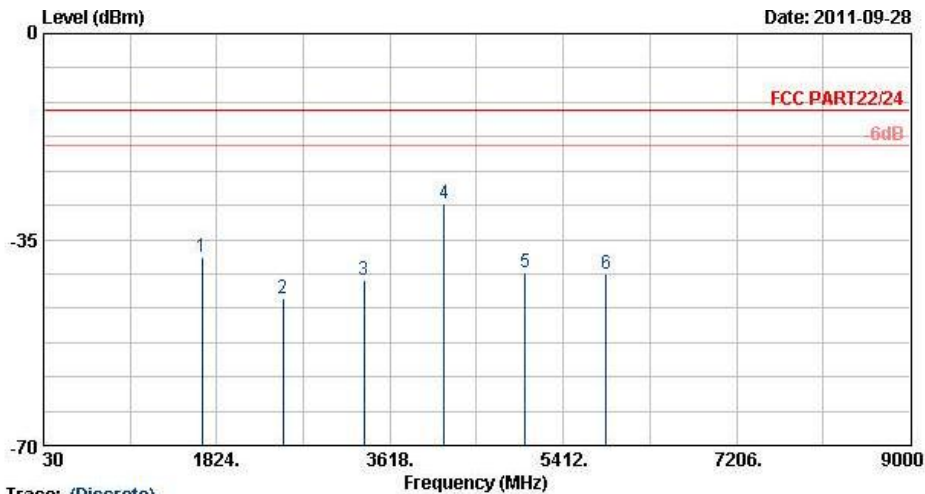

Frequency (MHz)	ERP (dBm)	Limit (dBm)	Over Limit (dB)	SPA Reading (dBm)	S.G. Power (dBm)	TX Cable loss (dB)	TX Antenna Gain (dBi)	Polarization (H/V)	Result
1672	-37.95	-13	-24.95	-48.72	-39.41	1.88	5.49	V	Pass
2509	-44.96	-13	-31.96	-57.49	-46.59	2.44	6.22	V	Pass
3345	-41.89	-13	-28.89	-57.88	-45.34	2.47	8.07	V	Pass
4182	-28.81	-13	-15.81	-47.74	-33.52	2.35	9.21	V	Pass
5018	-40.57	-13	-27.57	-61.64	-45.68	3.05	10.31	V	Pass
5854	-40.95	-13	-27.95	-64.73	-46.45	3.05	10.70	V	Pass

## 3.7 Frequency Stability Measurement

### 3.7.1 Description of Frequency Stability Measurement

The frequency stability shall be measured by variation of ambient temperature and variation of primary supply voltage to ensure that the fundamental emission stays within the authorized frequency block. The frequency stability of the transmitter shall be maintained within  $\pm 0.00025\%$  ( $\pm 2.5\text{ppm}$ ) of the center frequency.

### 3.7.2 Measuring Instruments

See list of measuring instruments of this test report.

### 3.7.3 Test Procedures for Temperature Variation

1. The EUT was set up in the thermal chamber and connected with the base station.
2. With power OFF, the temperature was decreased to  $-30^{\circ}\text{C}$  and the EUT was stabilized for three hours. Power was applied and the maximum change in frequency was recorded within one minute.
3. With power OFF, the temperature was raised in  $10^{\circ}\text{C}$  step up to  $50^{\circ}\text{C}$ . The EUT was stabilized at each step for at least half an hour. Power was applied and the maximum frequency change was recorded within one minute.
4. If the EUT cannot be turned on at  $-30^{\circ}\text{C}$ , the testing lowest temperature will be raised in  $10^{\circ}\text{C}$  step until the EUT can be turned on.

### 3.7.4 Test Procedures for Voltage Variation

1. The EUT was placed in a temperature chamber at  $25\pm 5^{\circ}\text{C}$  and connected with the base station.
2. The power supply voltage to the EUT was varied from BEP to 115% of the nominal value measured at the input to the EUT.
3. The variation in frequency was measured for the worst case.



### 3.7.5 Test Setup

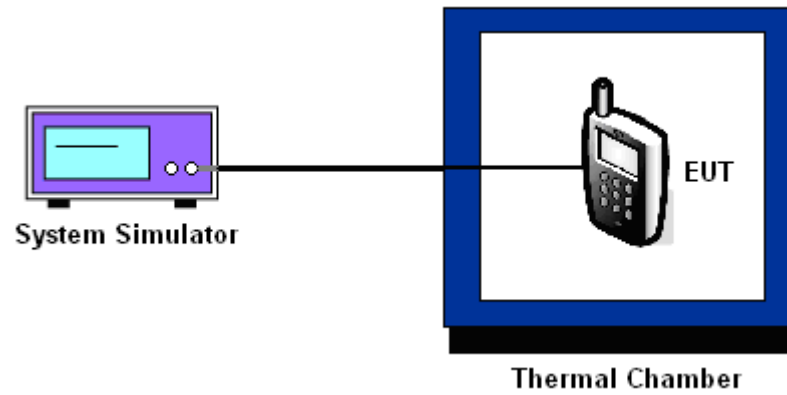



3.7.6 Test Result of Temperature Variation

Band :	CDMA2000 BC0	Channel :	384
Test Mode :	1xRTT_RC3+SO32	Limit (ppm) :	2.5

Temperature (°C)	Freq. Dev. (Hz)	Deviation (ppm)	Result
-20	-36	-0.04	PASS
-10	-34	-0.04	
0	-32	-0.04	
10	-30	-0.04	
20	-28	-0.03	
30	-25	-0.03	
40	-22	-0.03	
50	-20	-0.02	

Note: The EUT stops transmitting at temperatures -20°C and 50°C.

Band :	GSM 1900	Channel :	661
Limit (ppm) :	2.5		

Temperature (°C)	GSM		Result
	Freq. Dev. (Hz)	Deviation (ppm)	
-20	-36	-0.02	PASS
-10	-33	-0.02	
0	-31	-0.02	
10	-28	-0.01	
20	-25	-0.01	
30	-23	-0.01	
40	-20	-0.01	
50	-19	-0.01	

Note: The EUT stops transmitting at temperatures -20°C and 50°C.



3.7.7 Test Result of Voltage Variation

Band & Channel	Mode	Voltage (Volt)	Freq. Dev. (Hz)	Deviation (ppm)	Limit (ppm)	Result
GSM 1900 CH661	GSM	3.9	-26	-0.01	2.5	PASS
		BEP	-17	-0.01		
		4.2	-33	-0.02		
CDMA2000 BC0 CH384	1xRTT RC3+SO32	3.9	-30	-0.04		
		BEP	-20	-0.02		
		4.2	-36	-0.04		

Note:

- 1. Normal Voltage = 3.9V.
- 2. Battery End Point (BEP) = 3.7 V.



## 4 List of Measuring Equipment

Instrument	Manufacturer	Model No.	Serial No.	Characteristics	Calibration Date	Due Date	Remark
System Simulator	R&S	CMU200	117995	N/A	Jul. 28, 2011	Jul. 27, 2012	Conducted (TH02-HY)
Spectrum Analyzer	R&S	FSP40	100055	9kHz~40GHz	Jun. 13, 2011	Jun. 12, 2012	Conducted (TH02-HY)
Power Meter	Agilent	E4416A	GB41292344	N/A	Feb. 18, 2011	Feb. 17, 2012	Conducted (TH02-HY)
Power Sensor	Agilent	E9327A	US40441548	N/A	Feb. 18, 2011	Feb. 17, 2012	Conducted (TH02-HY)
Thermal Chamber	Ten Billion	TTH-D35P	TBN-930701	N/A	Jul. 27, 2011	Jul. 26, 2012	Conducted (TH02-HY)
Spectrum Analyzer	R&S	FSP40	100057	9KHz-40GHz	Oct. 25, 2010	Oct. 24, 2011	Radiation (03CH06-HY)
EMI Test Receiver	R&S	ESVS10	834468/003	20MHz-1000MHz	May 10, 2011	May 09, 2012	Radiation (03CH06-HY)
Bilog Antenna	SCHAFFNER	CBL6112B	2885	30MHz -2GHz	Oct. 31, 2010	Oct. 30, 2011	Radiation (03CH06-HY)
Double Ridge Horn Antenna	EMCO	3117	00066583	1GHz~18GHz	Aug. 01, 2011	Jul. 31, 2012	Radiation (03CH06-HY)
Double Ridge Horn Antenna	Training Research	AH-0801	95119	8GHz~18GHz	Oct. 20, 2010	Oct. 19, 2011	Radiation (03CH06-HY)
SHF-EHF Horn Antenna	SCHWARZBECK	BBHA 9170	BBHA917025 1	15GHz- 40GHz	Oct. 18, 2010	Oct. 17, 2011	Radiation (03CH06-HY)
Pre Amplifier	Agilent	8449B	3008A01917	1GHz- 26.5GHz	Apr. 14, 2011	Apr. 13, 2012	Radiation (03CH06-HY)
Amplifier	Agilent	310N	186713	9KHz~1GHz	Apr. 14, 2011	Apr. 13, 2012	Radiation (03CH06-HY)
System Simulator	R&S	CMU200	117591	N/A	Oct. 18, 2010	Oct. 17, 2011	Radiation (03CH06-HY)

## 5 Uncertainty of Evaluation

### Uncertainty of Radiated Emission Measurement (30 MHz ~ 1000 MHz)

Contribution	Uncertainty of $X_i$		$u(X_i)$
	dB	Probability Distribution	
Receiver Reading	0.41	Normal (k=2)	0.21
Antenna Factor Calibration	0.83	Normal (k=2)	0.42
Cable Loss Calibration	0.25	Normal (k=2)	0.13
Pre-Amplifier Gain Calibration	0.27	Normal (k=2)	0.14
RCV/SPA Specification	2.50	Rectangular	0.72
Antenna Factor Interpolation for Frequency	1.00	Rectangular	0.29
Site Imperfection	1.43	Rectangular	0.83
Mismatch	+0.39 / -0.41	U-Shape	0.28
<b>Combined Standard Uncertainty <math>U_c(y)</math></b>	<b>1.27</b>		
<b>Measuring Uncertainty for a Level of Confidence of 95% (<math>U = 2U_c(y)</math>)</b>	<b>2.54</b>		

### Uncertainty of Radiated Emission Measurement (1 GHz ~ 40 GHz)

Contribution	Uncertainty of $X_i$		$u(X_i)$	$C_i$	$C_i * u(X_i)$
	dB	Probability Distribution			
Receiver Reading	$\pm 0.10$	Normal (k=2)	0.10	1	0.10
Antenna Factor Calibration	$\pm 1.70$	Normal (k=2)	0.85	1	0.85
Cable Loss Calibration	$\pm 0.50$	Normal (k=2)	0.25	1	0.25
Receiver Correction	$\pm 2.00$	Rectangular	1.15	1	1.15
Antenna Factor Directional	$\pm 1.50$	Rectangular	0.87	1	0.87
Site Imperfection	$\pm 2.80$	Triangular	1.14	1	1.14
Mismatch Receiver VSWR $\Gamma_1 = 0.197$ Antenna VSWR $\Gamma_2 = 0.194$ Uncertainty = $20\text{Log}(1-\Gamma_1*\Gamma_2)$	+0.34 / -0.35	U-Shape	0.244	1	0.244
<b>Combined Standard Uncertainty <math>U_c(y)</math></b>	<b>2.36</b>				
<b>Measuring Uncertainty for a Level of Confidence of 95% (<math>U = 2U_c(y)</math>)</b>	<b>4.72</b>				



## **Appendix A. Photographs of EUT**

Please refer to Sporton report number EP181934 as below.