



# OET 65

# TEST REPORT

<b>Product Name</b>	150Mbps Wireless N USB Adapter
<b>Model</b>	PW-DN427
<b>FCC ID</b>	WWMDN427V3
<b>Client</b>	Proware Technologies Co Ltd.

**TA Technology (Shanghai) Co., Ltd.**

**TA Technology (Shanghai) Co., Ltd.**  
**Test Report**

Report No. RXA1206-0418SAR01R1

Page 2 of 63

**GENERAL SUMMARY**

<b>Product Name</b>	150Mbps Wireless N USB Adapter	<b>Model</b>	PW-DN427
<b>FCC ID</b>	WWMDN427V3		
<b>Report No.</b>	RXA1206-0418SAR01R1		
<b>Client</b>	Proware Technologies Co Ltd.		
<b>Manufacturer</b>	Proware Technologies Co Ltd.		
<b>Reference Standard(s)</b>	<p><b>IEEE Std C95.1, 1999:</b> IEEE Standard for Safety Levels with Respect to Human Exposure to Radio Frequency Electromagnetic Fields, 3 kHz to 300 GHz.</p> <p><b>SUPPLEMENT C Edition 01-01 to OET BULLETIN 65 Edition 97-01 June 2001 including DA 02-1438, published June 2002:</b> Evaluating Compliance with FCC Guidelines for Human Exposure to Radio frequency Electromagnetic Fields Additional Information for Evaluation Compliance of Mobile and Portable Devices with FCC Limits for Human Exposure to Radio frequency Emissions.</p> <p><b>KDB 248227 D01 SAR meas for 802 11 a b g v01r02:</b> SAR Measurement Procedures for 802.11a/b/g Transmitters.</p> <p><b>KDB 447498 D02 SAR Procedures for Dongle Xmtr v02:</b> SAR Measurement Procedures for USB Dongle Transmitters.</p>		
<b>Conclusion</b>	<p>This portable wireless equipment has been measured in all cases requested by the relevant standards. Test results in Chapter 7 of this test report are below limits specified in the relevant standards.</p> <p>General Judgment: <b>Pass</b></p> <p style="text-align: right;">(Stamp) <b>Date of issue: August 3<sup>rd</sup>, 2012</b></p>		
<b>Comment</b>	The test result only responds to the measured sample.		

Approved by 初伟中  
Director

Revised by 凌敏宝  
SAR Manager

Performed by 沈辰  
SAR Engineer

## TABLE OF CONTENT

1. General Information .....	4
1.1. Notes of the Test Report.....	4
1.2. Testing Laboratory .....	4
1.3. Applicant Information .....	5
1.4. Manufacturer Information.....	5
1.5. Information of EUT.....	6
1.6. The Maximum SAR <sub>1g</sub> Values .....	7
1.7. Test Date .....	7
2. SAR Measurements System Configuration.....	8
2.1. SAR Measurement Set-up .....	8
2.2. DASY5 E-field Probe System .....	9
2.2.1. EX3DV4 Probe Specification .....	9
2.2.2. E-field Probe Calibration .....	10
2.3. Other Test Equipment .....	10
2.3.1. Device Holder for Transmitters .....	10
2.3.2. Phantom .....	11
2.4. Scanning Procedure .....	11
2.5. Data Storage and Evaluation .....	13
2.5.1. Data Storage.....	13
2.5.2. Data Evaluation by SEMCAD .....	13
3. Laboratory Environment.....	15
4. Tissue-equivalent Liquid .....	16
4.1. Tissue-equivalent Liquid Ingredients.....	16
4.2. Tissue-equivalent Liquid Properties .....	16
5. System Check.....	17
5.1. Description of System Check.....	17
5.2. System Check.....	18
6. Operational Conditions during Test .....	19
6.1. General Description of Test Procedures .....	19
6.2. Position of Module in Portable Devices.....	20
6.3. Picture of Host Product .....	21
7. Test Results .....	22
7.1. Conducted Power Results .....	22
7.2. SAR Test Results .....	25
7.2.1. 802.11b.....	25
8. 300MHz to 3GHz Measurement Uncertainty.....	26
9. Main Test Instruments .....	27
ANNEX A: Test Layout .....	28
ANNEX B: System Check Results .....	29
ANNEX C: Graph Results .....	30
ANNEX D: Probe Calibration Certificate .....	37
ANNEX E: D2450V2 Dipole Calibration Certificate .....	48
ANNEX F: DAE4 Calibration Certificate .....	56
ANNEX G: The EUT Appearances and Test Configuration .....	61

## 1. General Information

### 1.1. Notes of the Test Report

**TA Technology (Shanghai) Co., Ltd.** guarantees the reliability of the data presented in this test report, which is the results of measurements and tests performed for the items under test on the date and under the conditions stated in this test report and is based on the knowledge and technical facilities available at TA Technology (Shanghai) Co., Ltd. at the time of execution of the test.

**TA Technology (Shanghai) Co., Ltd.** is liable to the client for the maintenance by its personnel of the confidentiality of all information related to the items under test and the results of the test. This report only refers to the item that has undergone the test.

This report standalone does not constitute or imply by its own an approval of the product by the certification Bodies or competent Authorities. This report cannot be used partially or in full for publicity and/or promotional purposes without previous written approval of **TA Technology (Shanghai) Co., Ltd.** and the Accreditation Bodies, if it applies.

If the electrical report is inconsistent with the printed one, it should be subject to the latter.

### 1.2. Testing Laboratory

Company: TA Technology (Shanghai) Co., Ltd.  
Address: No.145, Jintang Rd, Tangzhen Industry Park, Pudong  
City: Shanghai  
Post code: 201201  
Country: P. R. China  
Contact: Yang Weizhong  
Telephone: +86-021-50791141/2/3  
Fax: +86-021-50791141/2/3-8000  
Website: <http://www.ta-shanghai.com>  
E-mail: [yangweizhong@ta-shanghai.com](mailto:yangweizhong@ta-shanghai.com)

**TA Technology (Shanghai) Co., Ltd.**  
**Test Report**

Report No. RXA1206-0418SAR01R1

Page 5 of 63

---

**1.3. Applicant Information**

Company: Proware Technologies Co Ltd.  
Address: 2nd F1 East Wing,South Section,Factory Building 24,Science&Technology Park,Shennan Rd,Nanshan District,Shenzhen  
City: Shenzhen  
Postal Code: 518057  
Country: China

**1.4. Manufacturer Information**

Company: Proware Technologies Co Ltd.  
Address: 2nd F1 East Wing,South Section,Factory Building 24,Science&Technology Park,Shennan Rd,Nanshan District,Shenzhen  
City: Shenzhen  
Postal Code: 518057  
Country: China

# TA Technology (Shanghai) Co., Ltd. Test Report

Report No. RXA1206-0418SAR01R1

Page 6 of 63

## 1.5. Information of EUT

### General Information

Device Type:	Portable Device	
Exposure Category:	Uncontrolled Environment / General Population	
State of Sample:	Prototype Unit	
Product Name:	150Mbps Wireless N USB Adapter	
SN:	/	
Hardware Version:	3.0	
Software Version:	/	
Antenna Type:	Internal Antenna	
Device Operating Configurations:		
Supporting Mode(s):	802.11b; (tested) 802.11g/n HT20/HT40; (untested)	
Operating Frequency Range(s):	Mode	Tx (MHz)
	802.11b/g/n HT20	2412 ~ 2462MHz
	802.11n HT40	2422 ~ 2452MHz
Test Channel: (Low - Middle - High)	1-6-11 (802.11b/g/n HT20) 3-6-9 (802.11n HT40)	
Used Host Products:	IBM T61	

# TA Technology (Shanghai) Co., Ltd.

## Test Report

Report No. RXA1206-0418SAR01R1

Page 7 of 63

Equipment Under Test (EUT) is 150Mbps Wireless N USB Adapter. During SAR test of the EUT, it was connected to a portable computer. SAR is tested for 802.11b in this report. SAR is not required for 802.11g/n when the maximum average output power is less than 0.25dB higher than that measured on the corresponding 802.11b channels. The EUT has a WiFi antenna that is used for Tx/Rx.

The sample undergoing test was selected by the Client.

Components list please refer to documents of the manufacturer.

### 1.6. The Maximum SAR<sub>1g</sub> Values

#### Body SAR Configuration

Mode	Channel	Position	Separation distance	SAR <sub>1g</sub> (W/kg)
802.11b	Low/1	Test Position 1	5mm	<b>0.435</b>

### 1.7. Test Date

The test performed on June 21, 2012.

## 2. SAR Measurements System Configuration

### 2.1. SAR Measurement Set-up

The DASY5 system for performing compliance tests consists of the following items:

- A standard high precision 6-axis robot (Stäubli RX family) with controller and software. An arm extension for accommodating the data acquisition electronics (DAE).
- A dosimetric probe, i.e. an isotropic E-field probe optimized and calibrated for usage in tissue simulating liquid. The probe is equipped with an optical surface detector system.
- A data acquisition electronic (DAE) which performs the signal amplification, signal multiplexing, AD-conversion, offset measurements, mechanical surface detection, collision detection, etc. The unit is battery powered with standard or rechargeable batteries. The signal is optically transmitted to the EOC.
- A unit to operate the optical surface detector which is connected to the EOC.
- The Electro-Optical Coupler (EOC) performs the conversion from the optical into a digital electric signal of the DAE. The EOC is connected to the DASY5 measurement server.
- The DASY5 measurement server, which performs all real-time data evaluation for field measurements and surface detection, controls robot movements and handles safety operation. A computer operating Windows 2003
- DASY5 software and SEMCAD data evaluation software.
- Remote control with teach panel and additional circuitry for robot safety such as warning lamps, etc.
- The generic twin phantom enabling the testing of left-hand and right-hand usage.
- The device holder for handheld mobile phones.
- Tissue simulating liquid mixed according to the given recipes.
- System validation dipoles allowing to validate the proper functioning of the system.

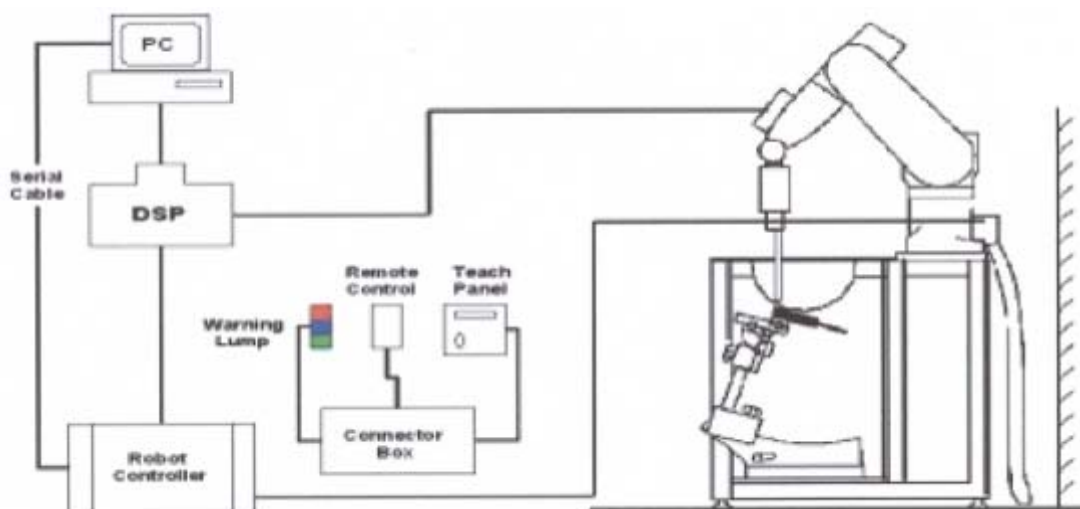

**Figure 1. SAR Lab Test Measurement Set-up**



## 2.2. DASY5 E-field Probe System

The SAR measurements were conducted with the dosimetric probe EX3DV4 (manufactured by SPEAG), designed in the classical triangular configuration and optimized for dosimetric evaluation.

### 2.2.1. EX3DV4 Probe Specification

Construction	Symmetrical design with triangular core Built-in shielding against static charges PEEK enclosure material (resistant to organic solvents, e.g., DGBE)
Calibration	ISO/IEC 17025 calibration service available
Frequency	10 MHz to > 6 GHz Linearity: $\pm 0.2$ dB (30 MHz to 6 GHz)
Directivity	$\pm 0.3$ dB in HSL (rotation around probe axis) $\pm 0.5$ dB in tissue material (rotation normal to probe axis)
Dynamic Range	10 $\mu$ W/g to > 100 mW/g Linearity: $\pm 0.2$ dB (noise: typically < 1 $\mu$ W/g)
Dimensions	Overall length: 330 mm (Tip: 20 mm) Tip diameter: 2.5 mm (Body: 12 mm) Typical distance from probe tip to dipole centers: 1 mm
Application	High precision dosimetric measurements in any exposure scenario (e.g., very strong gradient fields). Only probe which enables compliance testing for frequencies up to 6 GHz with precision of better 30%.



Figure 2. EX3DV4 E-field Probe



Figure 3. EX3DV4 E-field probe

### 2.2.2. E-field Probe Calibration

Each probe is calibrated according to a dosimetric assessment procedure with accuracy better than  $\pm 10\%$ . The spherical isotropy was evaluated and found to be better than  $\pm 0.25\text{dB}$ . The sensitivity parameters (NormX, NormY, NormZ), the diode compression parameter (DCP) and the conversion factor (ConvF) of the probe are tested.

The free space E-field from amplified probe outputs is determined in a test chamber. This is performed in a TEM cell for frequencies below 1 GHz, and in a wave guide above 1 GHz for free space. For the free space calibration, the probe is placed in the volumetric center of the cavity and at the proper orientation with the field. The probe is then rotated 360 degrees.

E-field temperature correlation calibration is performed in a flat phantom filled with the appropriate simulated brain tissue. The measured free space E-field in the medium correlates to temperature rise in a dielectric medium. For temperature correlation calibration a RF transparent thermistor-based temperature probe is used in conjunction with the E-field probe.

$$\text{SAR} = C \frac{\Delta T}{\Delta t}$$

Where:  $\Delta t$  = Exposure time (30 seconds),

C = Heat capacity of tissue (brain or muscle),

$\Delta T$  = Temperature increase due to RF exposure.

Or

$$\text{SAR} = \frac{|E|^2 \sigma}{\rho}$$

Where:

$\sigma$  = Simulated tissue conductivity,

$\rho$  = Tissue density (kg/m<sup>3</sup>).

## 2.3. Other Test Equipment

### 2.3.1. Device Holder for Transmitters

**Construction:** Simple but effective and easy-to-use extension for Mounting Device that facilitates the testing of larger devices according to IEC 62209-2 (e.g., laptops, cameras, etc.) It is lightweight and fits easily on the upper part of the Mounting Device in place of the phone positioner. The extension is fully compatible with the Twin SAM, ELI4 and SAM v6.0 Phantoms.

**Material:** POM, Acrylic glass, Foam

### 2.3.2. Phantom

The Generic Twin Phantom is constructed of a fiberglass shell integrated in a wooden Figure. The shape of the shell is based on data from an anatomical study designed to determine the maximum exposure in at least 90% of all users. It enables the dosimetric evaluation of left and right hand phone usage as well as body mounted usage at the flat phantom region. A cover prevents the evaporation of the liquid. Reference markings on the Phantom allow the complete setup of all predefined phantom positions and measurement grids by manually teaching three points in the robot.

Shell Thickness	2±0.1 mm
Filling Volume	Approx. 20 liters
Dimensions	810 x 1000 x 500 mm (H x L x W)
Available	Special



**Figure 4 Generic Twin Phantom**

### 2.4. Scanning Procedure

The DASY5 installation includes predefined files with recommended procedures for measurements and validation. They are read-only document files and destined as fully defined but unmeasured masks. All test positions (head or body-worn) are tested with the same configuration of test steps differing only in the grid definition for the different test positions.

- The “reference” and “drift” measurements are located at the beginning and end of the batch process. They measure the field drift at one single point in the liquid over the complete procedure. The indicated drift is mainly the variation of the DUT’s output power and should vary max. ± 5 %.
- The “surface check” measurement tests the optical surface detection system of the DASY5 system by repeatedly detecting the surface with the optical and mechanical surface detector and comparing the results. The output gives the detecting heights of both systems, the difference between the two systems and the standard deviation of the detection repeatability. Air bubbles or refraction in the liquid due to separation of the sugar-water mixture gives poor repeatability (above ± 0.1mm). To prevent wrong results tests are only executed when the liquid is free of air bubbles. The difference between the optical surface detection and the actual surface depends on the probe and is specified with each probe. (It does not depend on the surface reflectivity or the probe angle to the surface within ± 30°.)

- Area Scan

The Area Scan is used as a fast scan in two dimensions to find the area of high field values before running a detailed measurement around the hot spot. Before starting the area scan a grid spacing of 10 mm x 10 mm is set. During the scan the distance of the probe to the phantom remains

unchanged.

After finishing area scan, the field maxima within a range of 2 dB will be ascertained.

- **Zoom Scan**

Zoom Scans are used to estimate the peak spatial SAR values within a cubic averaging volume containing 1 g and 10 g of simulated tissue. The default Zoom Scan is done by 7x7x7 points within a cube whose base is centered around the maxima found in the preceding area scan.

- **Spatial Peak Detection**

The procedure for spatial peak SAR evaluation has been implemented and can determine values of masses of 1g and 10g, as well as for user-specific masses. The DASY5 system allows evaluations that combine measured data and robot positions, such as:

- maximum search
- extrapolation
- boundary correction
- peak search for averaged SAR

During a maximum search, global and local maxima searches are automatically performed in 2-D after each Area Scan measurement with at least 6 measurement points. It is based on the evaluation of the local SAR gradient calculated by the Quadratic Shepard's method. The algorithm will find the global maximum and all local maxima within -2 dB of the global maxima for all SAR distributions.

Extrapolation routines are used to obtain SAR values between the lowest measurement points and the inner phantom surface. The extrapolation distance is determined by the surface detection distance and the probe sensor offset. Several measurements at different distances are necessary for the extrapolation. Extrapolation routines require at least 10 measurement points in 3-D space.

They are used in the Zoom Scan to obtain SAR values between the lowest measurement points and the inner phantom surface. The routine uses the modified Quadratic Shepard's method for extrapolation. For a grid using 7x7x7 measurement points with 5mm resolution amounting to 343 measurement points, the uncertainty of the extrapolation routines is less than 1% for 1g and 10g cubes.

- A Z-axis scan measures the total SAR value at the x-and y-position of the maximum SAR value found during the cube 7x7x7 scan. The probe is moved away in z-direction from the bottom of the SAM phantom in 5mm steps.

## 2.5. Data Storage and Evaluation

### 2.5.1. Data Storage

The DASY5 software stores the acquired data from the data acquisition electronics as raw data (in microvolt readings from the probe sensors), together with all necessary software parameters for the data evaluation (probe calibration data, liquid parameters and device frequency and modulation data) in measurement files with the extension “.DAE4”. The software evaluates the desired unit and format for output each time the data is visualized or exported. This allows verification of the complete software setup even after the measurement and allows correction of incorrect parameter settings. For example, if a measurement has been performed with a wrong crest factor parameter in the device setup, the parameter can be corrected afterwards and the data can be re-evaluated.

The measured data can be visualized or exported in different units or formats, depending on the selected probe type ([V/m], [A/m], [°C], [mW/g], [mW/cm<sup>2</sup>], [dBrel], etc.). Some of these units are not available in certain situations or show meaningless results, e.g., a SAR output in a lossless media will always be zero. Raw data can also be exported to perform the evaluation with other software packages.

### 2.5.2. Data Evaluation by SEMCAD

The SEMCAD software automatically executes the following procedures to calculate the field units from the microvolt readings at the probe connector. The parameters used in the evaluation are stored in the configuration modules of the software:

Probe parameters:	- Sensitivity	Normi, a <sub>i0</sub> , a <sub>i1</sub> , a <sub>i2</sub>
	- Conversion factor	ConvF <sub>i</sub>
	- Diode compression point	Dcp <sub>i</sub>
Device parameters:	- Frequency	f
	- Crest factor	cf
Media parameters:	- Conductivity	
	- Density	

These parameters must be set correctly in the software. They can be found in the component documents or they can be imported into the software from the configuration files issued for the DASY5 components. In the direct measuring mode of the multimeter option, the parameters of the actual system setup are used. In the scan visualization and export modes, the parameters stored in the corresponding document files are used.

The first step of the evaluation is a linearization of the filtered input signal to account for the compression characteristics of the detector diode. The compensation depends on the input signal, the diode type and the DC-transmission factor from the diode to the evaluation electronics.

**TA Technology (Shanghai) Co., Ltd.**  
**Test Report**

If the exciting field is pulsed, the crest factor of the signal must be known to correctly compensate for peak power. The formula for each channel can be given as:

$$V_i = U_i + U_i^2 \cdot c f / d c p_i$$

With  $V_i$  = compensated signal of channel i (i = x, y, z)

$U_i$  = input signal of channel i (i = x, y, z)

$cf$  = crest factor of exciting field (DASY parameter)

$dcp_i$  = diode compression point (DASY parameter)

From the compensated input signals the primary field data for each channel can be evaluated:

E-field probes:  $E_i = (V_i / Norm_i \cdot ConvF)^{1/2}$

H-field probes:  $H_i = (V_i)^{1/2} \cdot (a_{i0} + a_{i1} f + a_{i2} f^2) / f$

With  $V_i$  = compensated signal of channel i (i = x, y, z)

$Norm_i$  = sensor sensitivity of channel i (i = x, y, z)  
[mV/(V/m)<sup>2</sup>] for E-field Probes

$ConvF$  = sensitivity enhancement in solution

$a_{ij}$  = sensor sensitivity factors for H-field probes

$f$  = carrier frequency [GHz]

$E_i$  = electric field strength of channel i in V/m

$H_i$  = magnetic field strength of channel i in A/m

The RSS value of the field components gives the total field strength (Hermitian magnitude):

$$E_{tot} = (E_x^2 + E_y^2 + E_z^2)^{1/2}$$

The primary field data are used to calculate the derived field units.

$$SAR = (E_{tot})^2 \cdot \sigma / (\rho \cdot 1000)$$

with  $SAR$  = local specific absorption rate in mW/g

$E_{tot}$  = total field strength in V/m

$\sigma$  = conductivity in [mho/m] or [Siemens/m]

$\rho$  = equivalent tissue density in g/cm<sup>3</sup>

Note that the density is normally set to 1 (or 1.06), to account for actual brain density rather than the density of the simulation liquid. The power flow density is calculated assuming the excitation field to be a free space field.

$$P_{pwe} = E_{tot}^2 / 3770 \quad \text{or} \quad P_{pwe} = H_{tot}^2 \cdot 37.7$$

with  $P_{pwe}$  = equivalent power density of a plane wave in mW/cm<sup>2</sup>

$E_{tot}$  = total electric field strength in V/m

$H_{tot}$  = total magnetic field strength in A/m

### 3. Laboratory Environment

**Table 1: The Requirements of the Ambient Conditions**

Temperature	Min. = 18°C, Max. = 25 °C
Relative humidity	Min. = 30%, Max. = 70%
Ground system resistance	< 0.5 Ω
Ambient noise is checked and found very low and in compliance with requirement of standards.	
Reflection of surrounding objects is minimized and in compliance with requirement of standards.	

## 4. Tissue-equivalent Liquid

### 4.1. Tissue-equivalent Liquid Ingredients

The liquid is consisted of water, sugar, salt, Glycol monobutyl, Preventol and Cellulose. The liquid has previously been proven to be suited for worst-case. The Table 2 shows the detail solution. It's satisfying the latest tissue dielectric parameters requirements proposed by OET 65.

**Table 2: Composition of the Body Tissue Equivalent Matter**

MIXTURE%	FREQUENCY(Body) 2450MHz
Water	73.2
Glycol	26.7
Salt	0.1
Dielectric Parameters Target Value	f=2450MHz $\epsilon=52.70$ $\sigma=1.95$

### 4.2. Tissue-equivalent Liquid Properties

**Table 3: Dielectric Performance of Tissue Simulating Liquid**

Frequency	Description	Dielectric Parameters		Temp °C
		$\epsilon_r$	$\sigma$ (s/m)	
2450MHz (body)	Target value ±5% window	52.70 50.07 — 55.34	1.95 1.85 — 2.05	/
	Measurement value 2011-6-21	51.7	1.9	21.5



## 5. System Check

### 5.1. Description of System Check

The manufacturer calibrates the probes annually. Dielectric parameters of the tissue simulants were measured every day using the dielectric probe kit and the network analyzer. A system check measurement was made following the determination of the dielectric parameters of the simulant, using the dipole validation kit. A power level of 250 mW was supplied to the dipole antenna, which was placed under the flat section of the twin SAM phantom. The system check results (dielectric parameters and SAR values) are given in the Table 4.

System check results have to be equal or near the values determined during dipole calibration with the relevant liquids and test system ( $\pm 10\%$ ).

System check is performed regularly on all frequency bands where tests are performed with the DASY5 system.

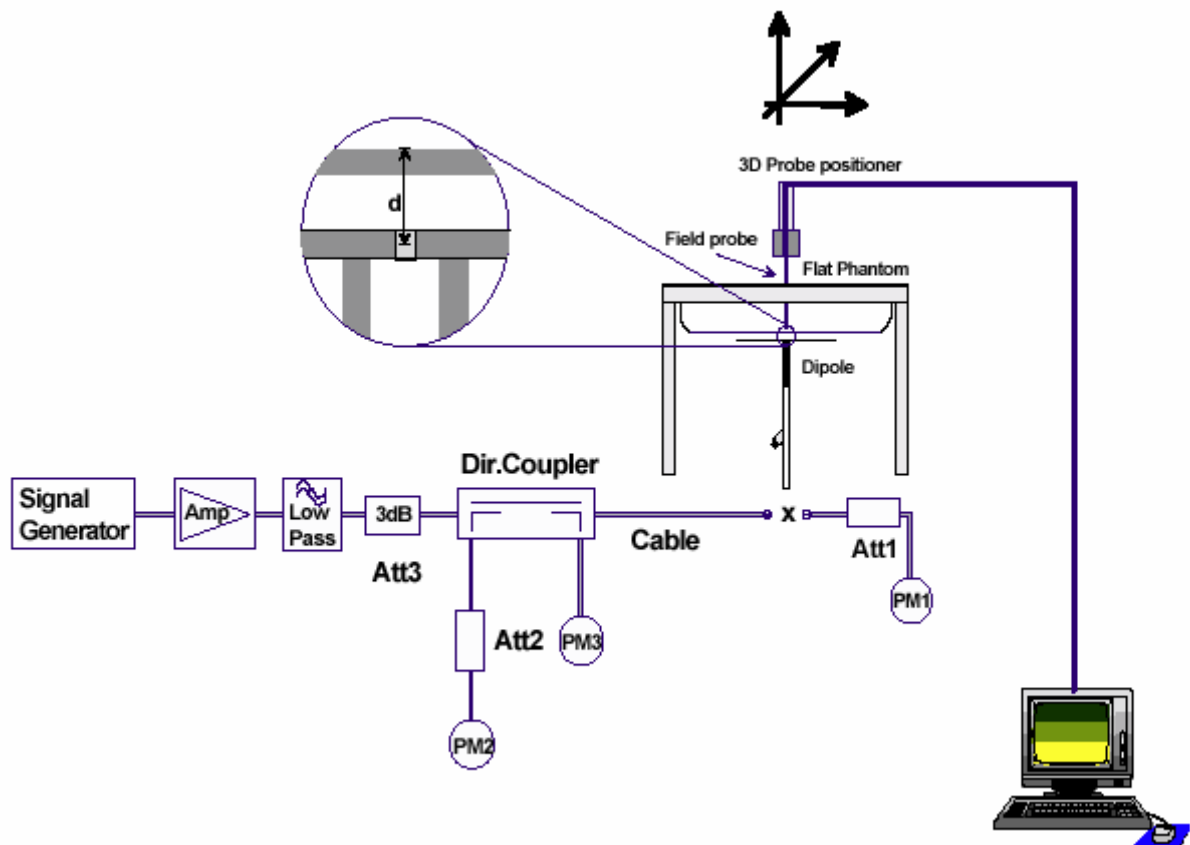

Figure 5. System Check Set-up

**TA Technology (Shanghai) Co., Ltd.**  
**Test Report**

**5.2. System Check**

**Table 4: System Check for Body Tissue Simulating Liquid**

Frequency	Test Date	Dielectric Parameters		Temp	250mW Measured SAR <sub>1g</sub>	1W Normalized SAR <sub>1g</sub>	1W Target SAR <sub>1g</sub> (±10% deviation)
		$\epsilon_r$	$\sigma$ (s/m)	(°C)	(W/kg)		
<b>2450MHz</b>	2012-6-21	51.7	1.9	21.5	12.9	51.6	51.70 (46.53~56.87)

Note: 1. The graph results see ANNEX B.

2. Target Values derive from the calibration certificate

## 6. Operational Conditions during Test

### 6.1. General Description of Test Procedures

For WLAN SAR testing, WLAN engineering testing software installed on the DUT can provide continuous transmitting RF signal. This RF signal utilized in SAR measurement has almost 100% duty cycle and its crest factor is 1.

For the 802.11b/g SAR body tests, a communication link is set up with the test mode software for WIFI mode test. The Absolute Radio Frequency Channel Number (ARFCN) is allocated to 1, 6 and 11 respectively in the case of 2450 MHz. During the test, at the each test frequency channel, the EUT is operated at the RF continuous emission mode. Each channel should be tested at the lowest data rate. Testing at higher data rates is not required when the maximum average output power is less than 0.25dB higher than those measured at the lowest data rate.

802.11b/g operating modes are tested independently according to the service requirements in each frequency band. 802.11b/g modes are tested on channels 1,6 and 11; however, if output power reduction is necessary for channels 1 and /or 11 to meet restricted band requirements the highest output channels closest to each of these channels must be tested instead.

SAR is not required for 802.11g channels when the maximum average output power is less than 0.25dB higher than that measured on the corresponding 802.11b channels. When the maximum average output channel in each frequency band is not included in the “default test channels”, the maximum channel should be tested instead of an adjacent “default test channels”, these are referred to as the “required test channels” and are illustrated in Table 5.

**Table 5: “Default Test Channels”**

Mode	GHz	Channel	Turbo Channel	“Default Test Channels”			
				15.247		UNII	
				802.11b	802.11g		
802.11b/g	2.412	1 <sup>#</sup>		√	*		
	2.437	6	6	√	*		
	2.462	11 <sup>#</sup>		√	*		

Note: <sup>#</sup>=when output power is reduced for channel 1 and /or 11 to meet restricted band requirements the highest out put channels closet to each of these channels should be tested.  
 √= “default test channels”  
 \* =possible 802.11g channels with maximum average output 0.25dB>=the “default test channels”

## **6.2. Position of Module in Portable Devices**

The measurements were performed in combination with a host product (IBM T61). IBM T61 laptop has horizontal USB slot and vertical USB slot.

A test distance of 5mm or less, according to KDB 447498 D02, should be considered for the orientation that can satisfy such requirements.

For each channel, the EUT is tested at the following 4 test positions:

- Test Position 1: The EUT is connected to the portable computer with horizontal USB slot. The back side of the EUT towards the bottom of the flat phantom. The distance from back side of the EUT to the bottom of the flat phantom is 5mm. (ANNEX G Picture 5)
- Test Position 2: The EUT is connected to the portable computer through a 19 cm USB cable. The front side of the EUT towards the bottom of the flat phantom. The distance from front side of the EUT to the bottom of the flat phantom is 5mm. (ANNEX G Picture 6)
- Test Position 3: The EUT is connected to the portable computer through a 19 cm USB cable. The left side of the EUT towards the bottom of the flat phantom. The distance from left side of the EUT to the bottom of the flat phantom is 5mm. (ANNEX G Picture 7)
- Test Position 4: The EUT is connected to the portable computer with vertical USB slot. The right side of the EUT towards the bottom of the flat phantom. The distance from right side of the EUT to the bottom of the flat phantom is 5mm. (ANNEX G Picture 8)

### 6.3. Picture of Host Product

During the test, IBM T61 laptop was used as an assistant to help to setup communication. (See Picture 1)



Picture 1-a: IBM T61 Close



Picture 1-b: IBM T61 Open



Picture 1-e: IBM T61 with horizontal USB slot



Picture 1-f: IBM T61 with Vertical USB slot



Picture 1-g: a 19 cm USB cable

**Picture 1: Computer as a test assistant**

**TA Technology (Shanghai) Co., Ltd.**  
**Test Report**

## 7. Test Results

### 7.1. Conducted Power Results

**Table 6: Conducted Power Measurement Results**

Mode	Channel	Data rate	AV Power (dBm)	PK Power (dBm)
11b	1	1 Mbps	17.23	19.4
		2 Mbps	17.32	19.84
		5.5 Mbps	17.25	19.33
		11 Mbps	17.22	19.48
	6	1 Mbps	17.07	18.47
		2 Mbps	17.06	18.34
		5.5 Mbps	17.10	18.13
		11 Mbps	17.00	18.29
	11	1 Mbps	16.87	18.23
		2 Mbps	16.76	18.30
		5.5 Mbps	16.81	18.20
		11 Mbps	16.73	18.43
11g	1	6 Mbps	16.68	25.12
		9 Mbps	16.61	25.03
		12 Mbps	16.66	25.46
		18 Mbps	16.85	25.10
		24 Mbps	14.81	24.38
		36 Mbps	15.31	24.21
		48 Mbps	13.07	22.86
		54 Mbps	12.94	23.80
	6	6 Mbps	16.72	24.08
		9 Mbps	16.69	23.88
		12 Mbps	16.66	24.54
		18 Mbps	16.79	24.06
		24 Mbps	14.92	23.51
		36 Mbps	14.97	23.17
		48 Mbps	13.09	21.70
11	6 Mbps	16.37	24.53	

# TA Technology (Shanghai) Co., Ltd. Test Report

Report No. RXA1206-0418SAR01R1

Page 23 of 63

		9 Mbps	16.41	23.87
		12 Mbps	16.39	24.43
		18 Mbps	16.55	23.96
		24 Mbps	14.71	23.24
		36 Mbps	14.64	23.15
		48 Mbps	12.71	21.79
		54 Mbps	12.75	22.88
11n HT20	1	13.5 MCS 0	16.94	24.89
		27 MCS 1	16.87	25.12
		40.5 MCS 2	17.14	24.98
		54 MCS 3	17.12	24.83
		81 MCS 4	15.21	24.02
		108 MCS 5	15.33	23.69
		121.5 MCS 6	13.39	23.06
		135 MCS 7	13.28	22.55
	6	13.5 MCS 0	17.36	23.77
		27 MCS 1	16.96	24.19
		40.5 MCS 2	17.05	23.99
		54 MCS 3	17.04	24.01
		81 MCS 4	15.22	22.94
		108 MCS 5	15.29	22.74
		121.5 MCS 6	13.13	22.16
		135 MCS 7	13.32	21.67
	11	13.5 MCS 0	16.82	23.68
		27 MCS 1	16.67	24.14
		40.5 MCS 2	16.78	23.85
		54 MCS 3	16.85	23.99
		81 MCS 4	14.91	23.26
		108 MCS 5	15.05	22.81
		121.5 MCS 6	12.97	22.24
		135 MCS 7	13.10	21.85
11n HT40	3	13.5 MCS 0	16.82	25.54
		27 MCS 1	16.72	24.52
		40.5 MCS 2	16.67	24.16
		54 MCS 3	16.66	24.49

**TA Technology (Shanghai) Co., Ltd.**  
**Test Report**

Report No. RXA1206-0418SAR01R1

Page 24 of 63

		81 MCS 4	14.87	23.65
		108 MCS 5	14.77	23.89
		121.5 MCS 6	12.87	22.76
		135 MCS 7	12.83	22.46
	6	13.5 MCS 0	16.63	24.24
		27 MCS 1	16.62	24.18
		40.5 MCS 2	16.54	23.89
		54 MCS 3	16.62	24.06
		81 MCS 4	14.70	23.02
		108 MCS 5	14.73	23.59
		121.5 MCS 6	12.84	22.97
		135 MCS 7	12.78	22.13
	9	13.5 MCS 0	16.32	24.32
		27 MCS 1	16.3	24.04
		40.5 MCS 2	16.28	23.75
		54 MCS 3	16.34	23.93
		81 MCS 4	14.4	23.04
		108 MCS 5	14.43	23.38
		121.5 MCS 6	12.45	22.46
		135 MCS 7	12.37	22.15

Note: 1. KDB 248227-SAR is not required for 802.11g/n channels when the maximum average output power is less than ¼ dB higher than measured on the corresponding 802.11b channels.



**TA Technology (Shanghai) Co., Ltd.**  
**Test Report**

**7.2. SAR Test Results**

**7.2.1. 802.11b**

**Table 7: SAR Values (802.11b)**

Limit of SAR		10 g Average	1g Average	Power Drift	Graph Results
		2.0 W/kg	1.6 W/kg	± 0.21 dB	
Test Case Of Body		Measurement Result (W/kg)		Power Drift (dB)	
Different Test Position	Channel	10 g Average	1 g Average		
<b>IBM T61</b>					
Test Position 1	High/11	0.125	0.250	-0.146	Figure 7
	Middle/6	0.165	0.325	0.128	Figure 8
	Low/1	0.211	0.435	0.046	Figure 9
Test Position 2	Low/1	0.196	0.371	0.181	Figure 10
Test Position 3	Low/1	0.187	0.351	-0.549	Figure 11
Test Position 4	Low/1	0.071	0.117	0.086	Figure 12

Note: 1. The value with blue color is the maximum SAR Value of each test band.  
2. SAR test at the channel with maximum averaged output power, if the SAR value is at least 3.0 dB lower than the SAR limit (< 0.8W/kg), testing at the other channels is optional.  
3. Other channels were measured at the worst case.  
4. KDB 248227-SAR is not required for 802.11 g/n channels when the maximum average output power is less than ¼ dB higher than measured on the corresponding 802.11b channels.

# TA Technology (Shanghai) Co., Ltd.

## Test Report

Report No. RXA1206-0418SAR01R1

Page 26 of 63

### 8. 300MHz to 3GHz Measurement Uncertainty

No.	source	Type	Uncertainty Value (%)	Probability Distribution	k	$c_i$	Standard uncertainty $u_i$ (%)	Degree of freedom $V_{eff}$ or $V_i$
1	System repetivity	A	0.5	N	1	1	0.5	9
Measurement system								
2	-probe calibration	B	6.0	N	1	1	6.0	$\infty$
3	-axial isotropy of the probe	B	4.7	R	$\sqrt{3}$	$\sqrt{0.5}$	1.9	$\infty$
4	- Hemispherical isotropy of the probe	B	9.4	R	$\sqrt{3}$	$\sqrt{0.5}$	3.9	$\infty$
6	-boundary effect	B	1.9	R	$\sqrt{3}$	1	1.1	$\infty$
7	-probe linearity	B	4.7	R	$\sqrt{3}$	1	2.7	$\infty$
8	- System detection limits	B	1.0	R	$\sqrt{3}$	1	0.6	$\infty$
9	-readout Electronics	B	1.0	N	1	1	1.0	$\infty$
10	-response time	B	0	R	$\sqrt{3}$	1	0	$\infty$
11	-integration time	B	4.32	R	$\sqrt{3}$	1	2.5	$\infty$
12	-noise	B	0	R	$\sqrt{3}$	1	0	$\infty$
13	-RF Ambient Conditions	B	3	R	$\sqrt{3}$	1	1.73	$\infty$
14	-Probe Positioner Mechanical Tolerance	B	0.4	R	$\sqrt{3}$	1	0.2	$\infty$
15	-Probe Positioning with respect to Phantom Shell	B	2.9	R	$\sqrt{3}$	1	1.7	$\infty$
16	-Extrapolation, interpolation and Integration Algorithms for Max. SAR Evaluation	B	3.9	R	$\sqrt{3}$	1	2.3	$\infty$
Test sample Related								
17	-Test Sample Positioning	A	2.9	N	1	1	2.9	71
18	-Device Holder Uncertainty	A	4.1	N	1	1	4.1	5
19	-Output Power Variation - SAR drift measurement	B	5.0	R	$\sqrt{3}$	1	2.9	$\infty$
Physical parameter								
20	-phantom	B	4.0	R	$\sqrt{3}$	1	2.3	$\infty$
21	-liquid conductivity (deviation from target)	B	5.0	R	$\sqrt{3}$	0.64	1.8	$\infty$

**TA Technology (Shanghai) Co., Ltd.**  
**Test Report**

Report No. RXA1206-0418SAR01R1

Page 27 of 63

22	-liquid conductivity (measurement uncertainty)	B	2.5	N	1	0.64	1.6	9	
23	-liquid permittivity (deviation from target)	B	5.0	R	$\sqrt{3}$	0.6	1.7	$\infty$	
24	-liquid permittivity (measurement uncertainty)	B	2.5	N	1	0.6	1.5	9	
Combined standard uncertainty		$u_c = \sqrt{\sum_{i=1}^{21} c_i^2 u_i^2}$						11.50	
Expanded uncertainty (confidence interval of 95 %)		$u_e = 2u_c$		N	k=2		23.00		

## 9. Main Test Instruments

**Table 8: List of Main Instruments**

No.	Name	Type	Serial Number	Calibration Date	Valid Period
01	Network analyzer	Agilent 8753E	US37390326	September 12, 2011	One year
02	Dielectric Probe Kit	Agilent 85070E	US44020115	No Calibration Requested	
03	Power meter	Agilent E4417A	GB41291714	March 11, 2012	One year
04	Power sensor	Agilent N8481H	MY50350004	September 25, 2011	One year
05	Power sensor	E9327A	US40441622	September 24, 2011	One year
06	Signal Generator	HP 8341B	2730A00804	September 12, 2011	One year
07	Dual directional coupler	777D	50146	August 21, 2011	One year
08	Amplifier	IXA-020	0401	No Calibration Requested	
09	E-field Probe	EX3DV4	3753	January 4, 2012	One year
10	DAE	DAE4	1291	October 10, 2011	One year
11	Validation Kit 2450MHz	D2450V2	786	August 29, 2011	One year
12	Temperature Probe	JM222	AA1009129	March 15, 2012	One year
13	Hygrothermograph	WS-1	64591	September 28, 2011	One year

\*\*\*END OF REPORT BODY\*\*\*

## ANNEX A: Test Layout



Picture 2: Specific Absorption Rate Test Layout

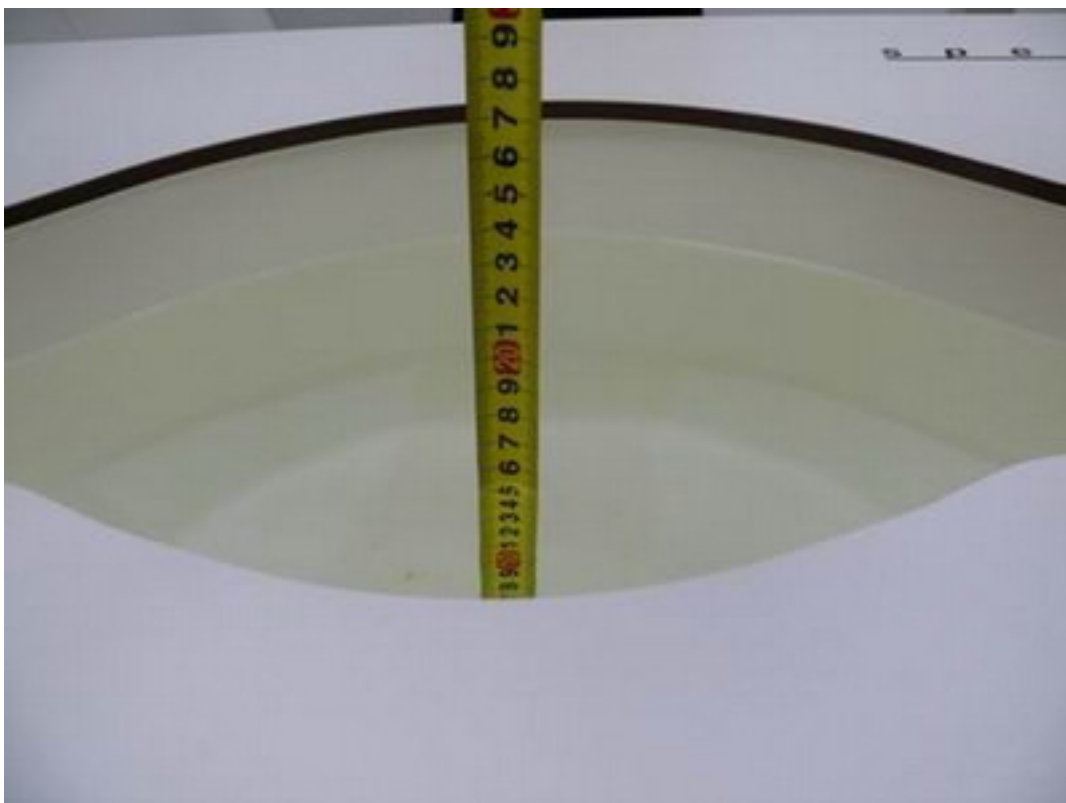

Picture 3: Liquid depth in the flat Phantom (2450 MHz, 15.2cm depth)

## ANNEX B: System Check Results

### System Performance Check at 2450 MHz

DUT: Dipole 2450 MHz; Type: D2450V2; Serial: D2450V2 - SN: 786

Date/Time: 6/21/2012 12:19:59 PM

Communication System: CW; Frequency: 2450 MHz; Duty Cycle: 1:1

Medium parameters used:  $f = 2450$  MHz;  $\sigma = 1.9$  mho/m;  $\epsilon_r = 51.7$ ;  $\rho = 1000$  kg/m<sup>3</sup>

Ambient Temperature: 22.3 °C      Liquid Temperature: 21.5°C

Phantom section: Flat Section

DASY5 Configuration:

Probe: EX3DV4 - SN3753; ConvF(7.03, 7.03, 7.03); Calibrated: 1/4/2012

Electronics: DAE4 Sn1291; Calibrated: 10/10/2011

Phantom: SAM2; Type: SAM; Serial: TP-1524

Measurement SW: DASY5, V5.2 Build 162; SEMCAD X Version 14.0 Build 59

**d=10mm, Pin=250mW/Area Scan (41x71x1):** Measurement grid: dx=15mm, dy=15mm

Maximum value of SAR (interpolated) = 16 mW/g

**d=10mm, Pin=250mW/Zoom Scan (7x7x7) /Cube 0:** Measurement grid: dx=5mm, dy=5mm, dz=5mm

Reference Value = 81.2 V/m; Power Drift = 0.076 dB

Peak SAR (extrapolated) = 25.4 W/kg

**SAR(1 g) = 12.9 mW/g; SAR(10 g) = 6.13 mW/g**

Maximum value of SAR (measured) = 14.9 mW/g

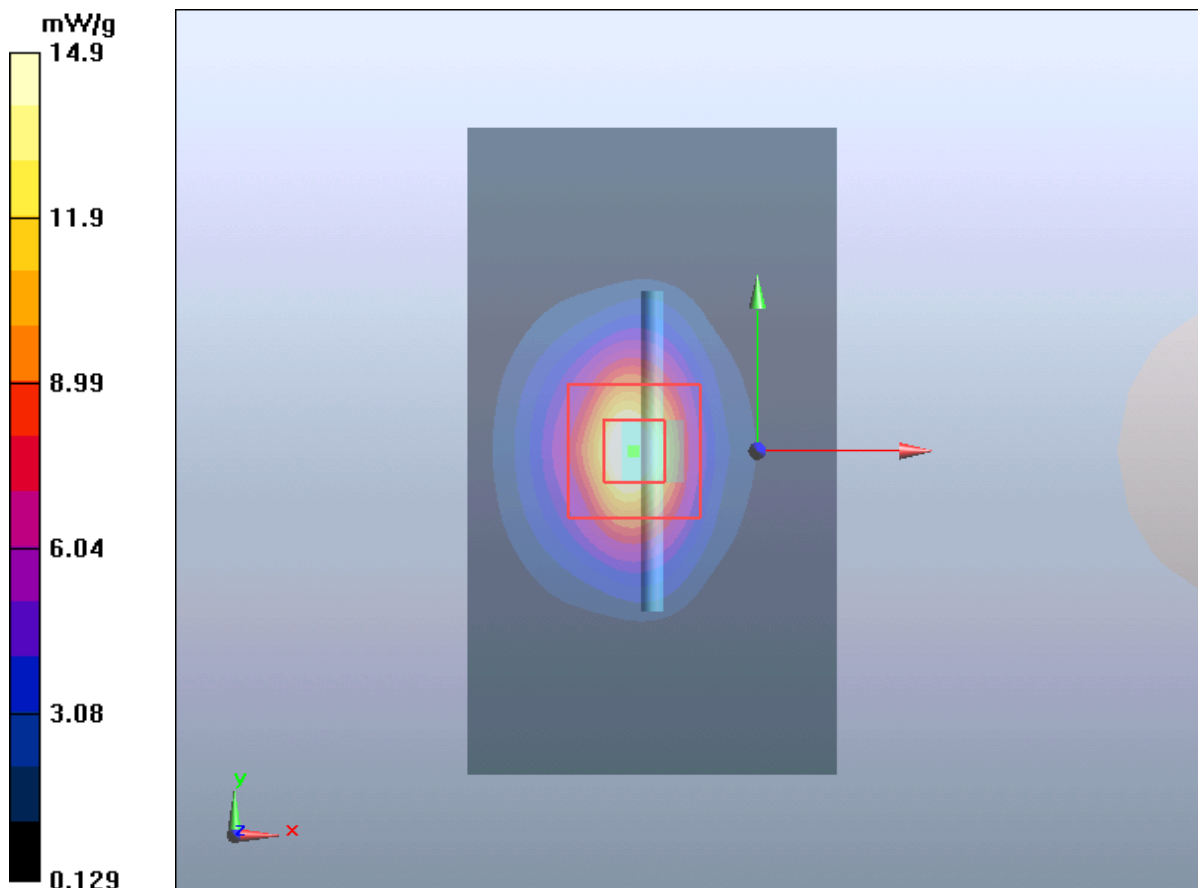

Figure 6 System Performance Check 2450MHz 250mW

## ANNEX C: Graph Results

### 802.11b with IBM T61 Test Position 1 High

Date/Time: 6/21/2012 5:33:24 PM

Communication System: 802.11b; Frequency: 2462 MHz; Duty Cycle: 1:1

Medium parameters used:  $f = 2462$  MHz;  $\sigma = 1.92$  mho/m;  $\epsilon_r = 51.7$ ;  $\rho = 1000$  kg/m<sup>3</sup>

Ambient Temperature: 22.3 °C      Liquid Temperature: 21.5 °C

Phantom section: Flat Section

DASY5 Configuration:

Probe: EX3DV4 - SN3753; ConvF(7.03, 7.03, 7.03); Calibrated: 1/4/2012

Electronics: DAE4 Sn1291; Calibrated: 10/10/2011

Phantom: SAM2; Type: SAM; Serial: TP-1524

Measurement SW: DASY5, V5.2 Build 162; SEMCAD X Version 14.0 Build 59

**Test Position 1 High/Area Scan (31x61x1):** Measurement grid: dx=10mm, dy=10mm

Maximum value of SAR (interpolated) = 0.288 mW/g

**Test Position 1 High/Zoom Scan (7x7x7)/Cube 0:** Measurement grid: dx=5mm, dy=5mm, dz=5mm

Reference Value = 9.66 V/m; Power Drift = -0.146 dB

Peak SAR (extrapolated) = 0.490 W/kg

**SAR(1 g) = 0.250 mW/g; SAR(10 g) = 0.125 mW/g**

Maximum value of SAR (measured) = 0.272 mW/g

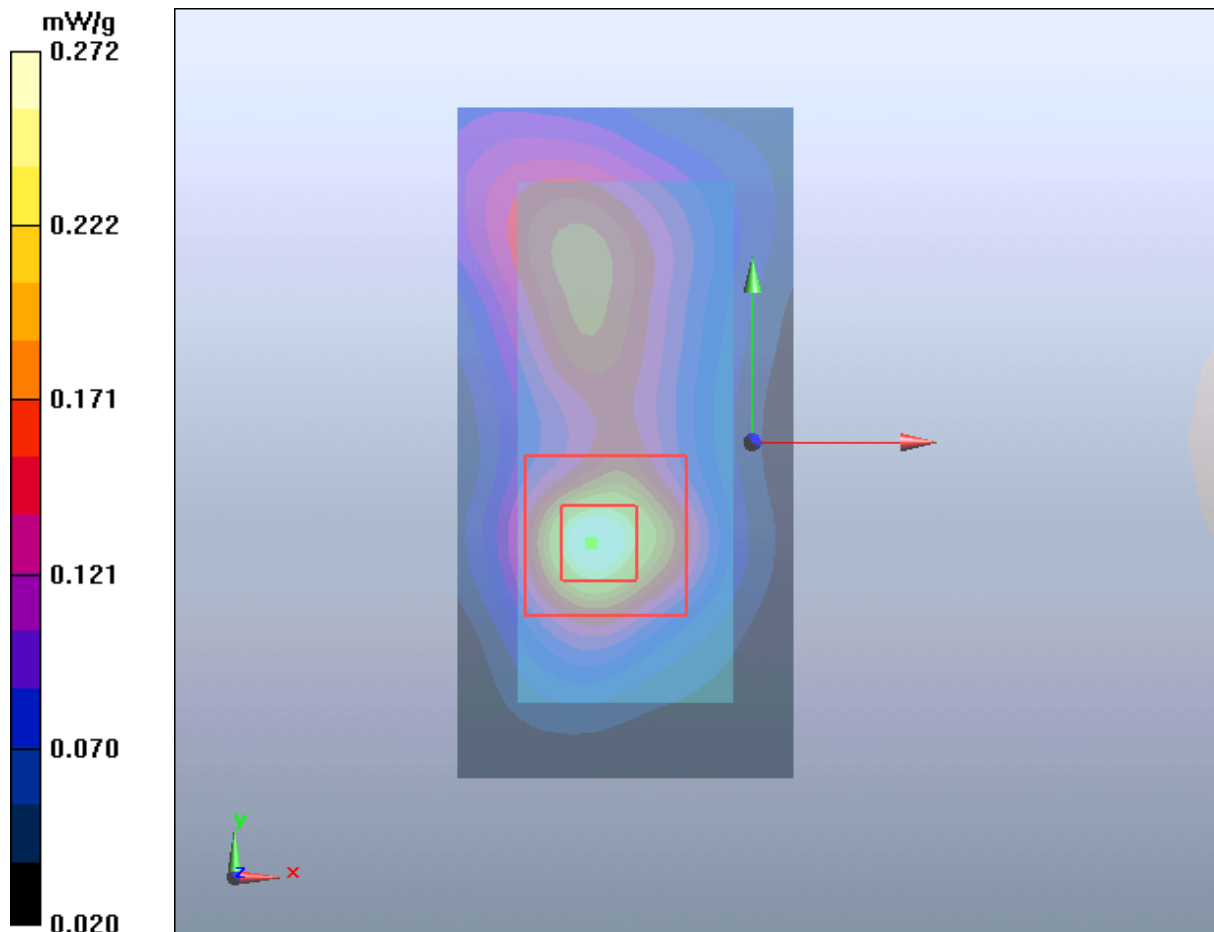

Figure 7 802.11b with IBM T61 Test Position 1 Channel 11

**802.11b with IBM T61 Test Position 1 Middle**

Date/Time: 6/21/2012 5:01:26 PM

Communication System: 802.11b; Frequency: 2437 MHz; Duty Cycle: 1:1

Medium parameters used (interpolated):  $f = 2437$  MHz;  $\sigma = 1.88$  mho/m;  $\epsilon_r = 51.7$ ;  $\rho = 1000$  kg/m<sup>3</sup>

Ambient Temperature: 22.3 °C      Liquid Temperature: 21.5°C

Phantom section: Flat Section

DASY5 Configuration:

Probe: EX3DV4 - SN3753; ConvF(7.03, 7.03, 7.03); Calibrated: 1/4/2012

Electronics: DAE4 Sn1291; Calibrated: 10/10/2011

Phantom: SAM2; Type: SAM; Serial: TP-1524

Measurement SW: DASY5, V5.2 Build 162; SEMCAD X Version 14.0 Build 59

**Test Position 1 Middle/Area Scan (31x61x1):** Measurement grid: dx=10mm, dy=10mm

Maximum value of SAR (interpolated) = 0.419 mW/g

**Test Position 1 Middle/Zoom Scan (7x7x7)/Cube 0:** Measurement grid: dx=5mm, dy=5mm, dz=5mm

Reference Value = 12.1 V/m; Power Drift = 0.128 dB

Peak SAR (extrapolated) = 0.621 W/kg

**SAR(1 g) = 0.325 mW/g; SAR(10 g) = 0.165 mW/g**

Maximum value of SAR (measured) = 0.358 mW/g

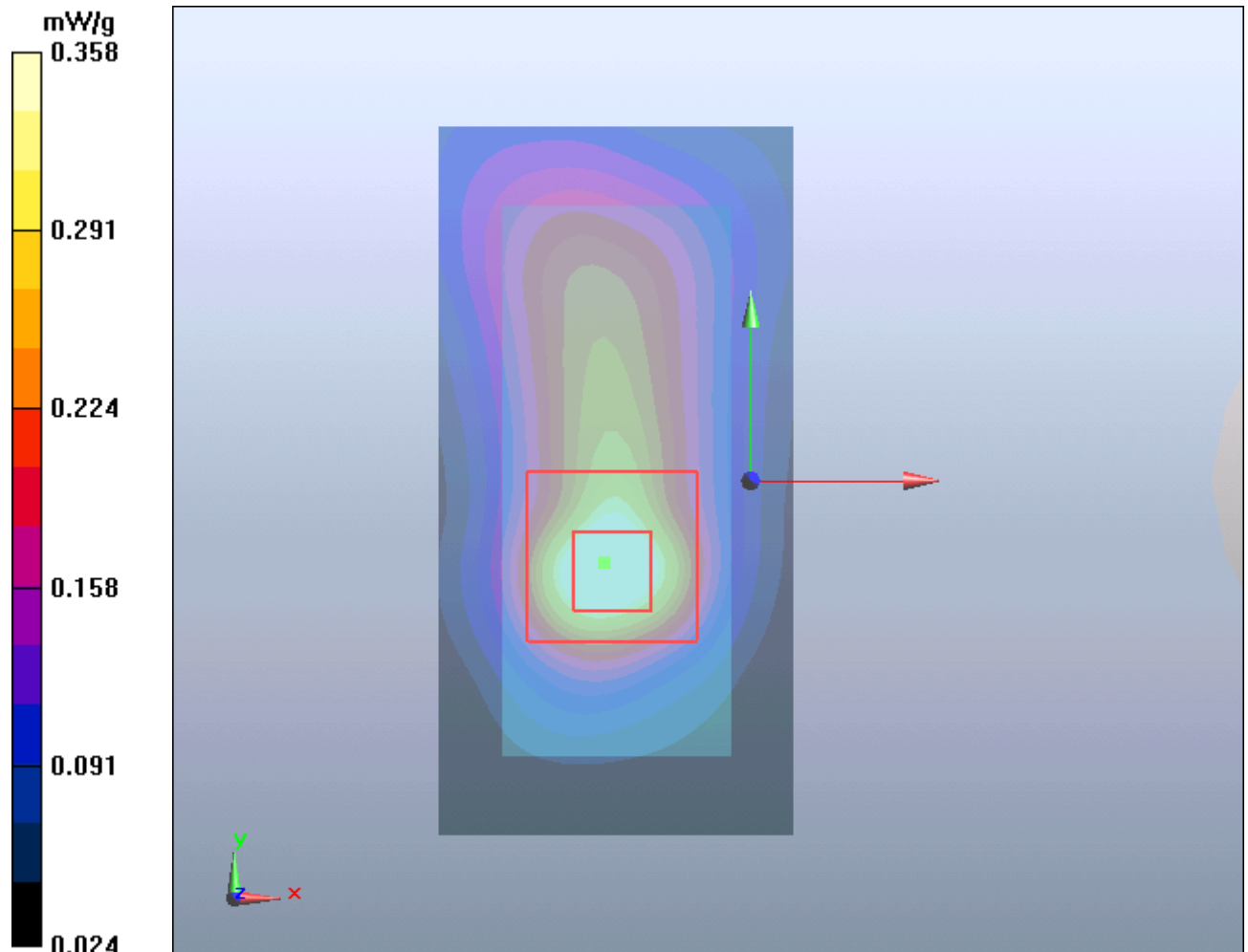

Figure 8 802.11b with IBM T61 Test Position 1 Channel 6

# TA Technology (Shanghai) Co., Ltd. Test Report

Report No. RXA1206-0418SAR01R1

Page 32 of 63

## 802.11b with IBM T61 Test Position 1 Low

Date/Time: 6/21/2012 3:11:36 PM

Communication System: 802.11b; Frequency: 2412 MHz; Duty Cycle: 1:1

Medium parameters used:  $f = 2412$  MHz;  $\sigma = 1.85$  mho/m;  $\epsilon_r = 51.7$ ;  $\rho = 1000$  kg/m<sup>3</sup>

Ambient Temperature: 22.3 °C      Liquid Temperature: 21.5°C

Phantom section: Flat Section

DASY5 Configuration:

Probe: EX3DV4 - SN3753; ConvF(7.03, 7.03, 7.03); Calibrated: 1/4/2012

Electronics: DAE4 Sn1291; Calibrated: 10/10/2011

Phantom: SAM2; Type: SAM; Serial: TP-1524

Measurement SW: DASY5, V5.2 Build 162; SEMCAD X Version 14.0 Build 59

**Test Position 1 Low/Area Scan (31x61x1):** Measurement grid: dx=10mm, dy=10mm

Maximum value of SAR (interpolated) = 0.515 mW/g

**Test Position 1 Low/Zoom Scan (7x7x7)/Cube 0:** Measurement grid: dx=5mm, dy=5mm, dz=5mm

Reference Value = 12.7 V/m; Power Drift = 0.046 dB

Peak SAR (extrapolated) = 0.847 W/kg

**SAR(1 g) = 0.435 mW/g; SAR(10 g) = 0.211 mW/g**

Maximum value of SAR (measured) = 0.472 mW/g

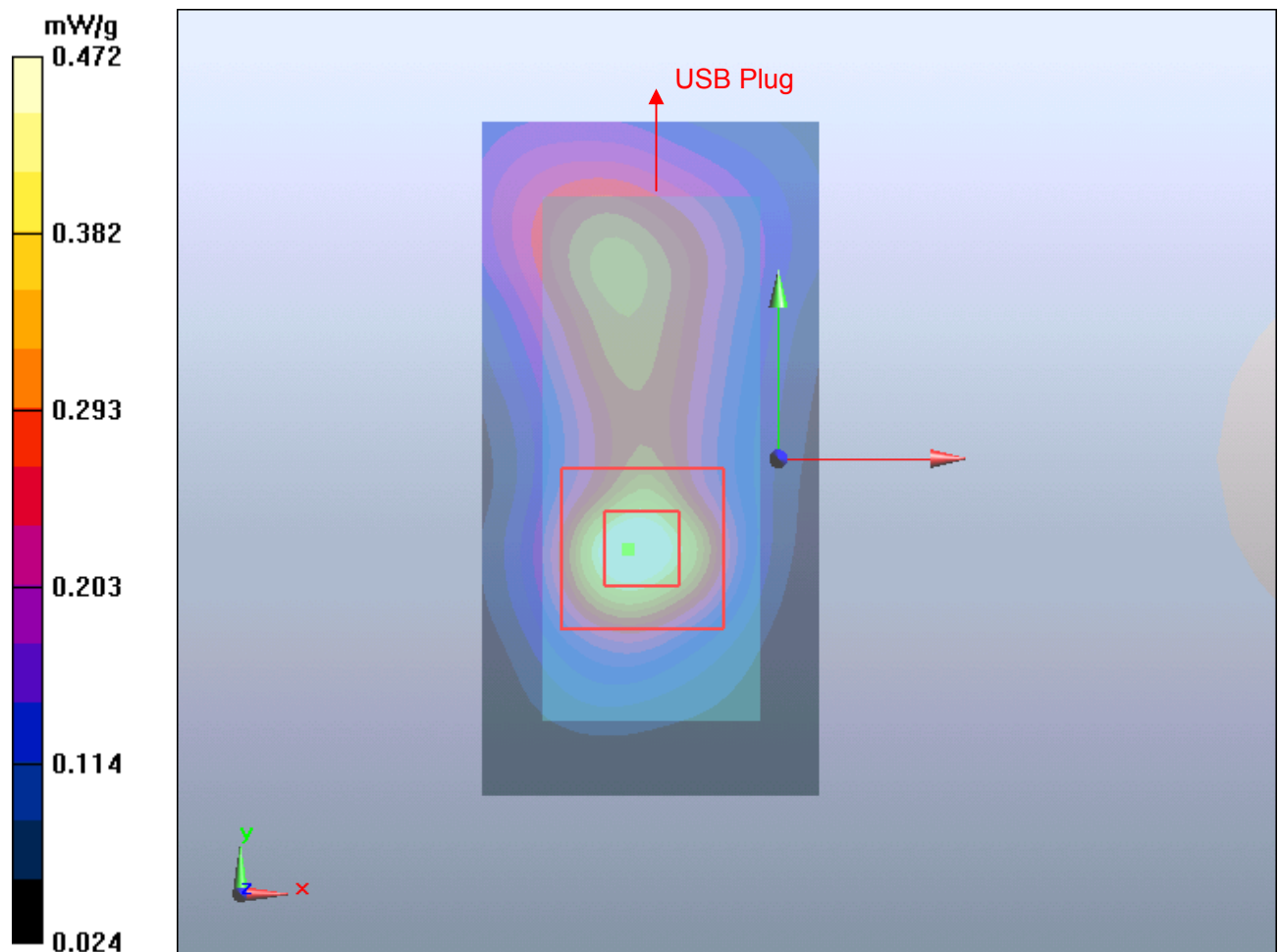



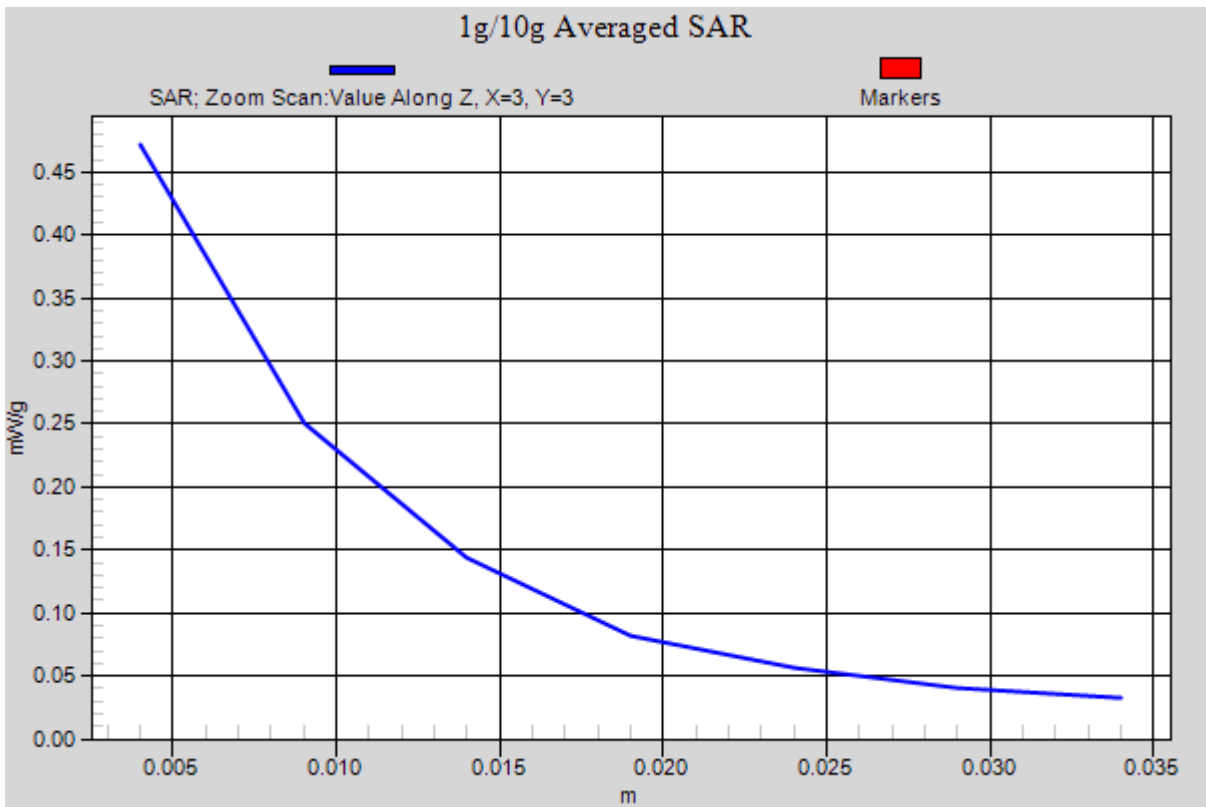

Figure 9 802.11b with IBM T61 Test Position 1 Channel 1

**802.11b with IBM T61 Test Position 2 Low**

Date/Time: 6/21/2012 4:36:13 PM

Communication System: 802.11b; Frequency: 2412 MHz; Duty Cycle: 1:1

Medium parameters used:  $f = 2412$  MHz;  $\sigma = 1.85$  mho/m;  $\epsilon_r = 51.7$ ;  $\rho = 1000$  kg/m<sup>3</sup>

Ambient Temperature: 22.3 °C      Liquid Temperature: 21.5 °C

Phantom section: Flat Section

DASY5 Configuration:

Probe: EX3DV4 - SN3753; ConvF(7.03, 7.03, 7.03); Calibrated: 1/4/2012

Electronics: DAE4 Sn1291; Calibrated: 10/10/2011

Phantom: SAM2; Type: SAM; Serial: TP-1524

Measurement SW: DASY5, V5.2 Build 162; SEMCAD X Version 14.0 Build 59

**Test Position 2 Low/Area Scan (31x61x1):** Measurement grid: dx=10mm, dy=10mm

Maximum value of SAR (interpolated) = 0.439 mW/g

**Test Position 2 Low/Zoom Scan (7x7x7)/Cube 0:** Measurement grid: dx=5mm, dy=5mm, dz=5mm

Reference Value = 10.9 V/m; Power Drift = 0.181 dB

Peak SAR (extrapolated) = 0.642 W/kg

**SAR(1 g) = 0.371 mW/g; SAR(10 g) = 0.196 mW/g**

Maximum value of SAR (measured) = 0.420 mW/g

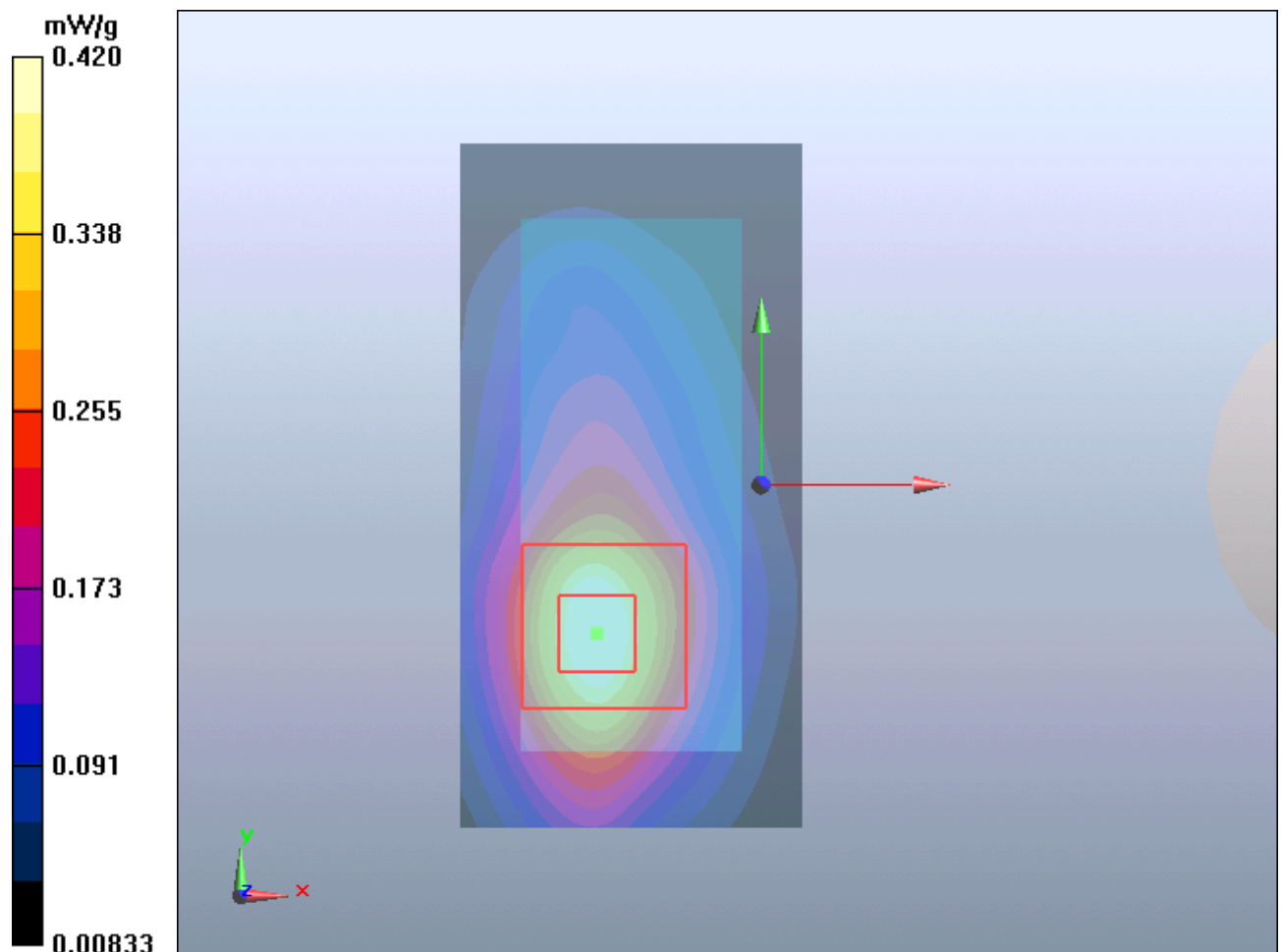

Figure 10 802.11b with IBM T61 Test Position 2 Channel 1

**802.11b with IBM T61 Test Position 3 Low**

Date/Time: 6/21/2012 4:11:27 PM

Communication System: 802.11b; Frequency: 2412 MHz; Duty Cycle: 1:1

Medium parameters used:  $f = 2412$  MHz;  $\sigma = 1.85$  mho/m;  $\epsilon_r = 51.7$ ;  $\rho = 1000$  kg/m<sup>3</sup>

Ambient Temperature: 22.3 °C      Liquid Temperature: 21.5 °C

Phantom section: Flat Section

DASY5 Configuration:

Probe: EX3DV4 - SN3753; ConvF(7.03, 7.03, 7.03); Calibrated: 1/4/2012

Electronics: DAE4 Sn1291; Calibrated: 10/10/2011

Phantom: SAM2; Type: SAM; Serial: TP-1524

Measurement SW: DASY5, V5.2 Build 162; SEMCAD X Version 14.0 Build 59

**Test Position 3 Low/Area Scan (31x61x1):** Measurement grid: dx=10mm, dy=10mm

Maximum value of SAR (interpolated) = 0.483 mW/g

**Test Position 3 Low/Zoom Scan (7x7x7)/Cube 0:** Measurement grid: dx=5mm, dy=5mm, dz=5mm

Reference Value = 12.5 V/m; Power Drift = -0.049 dB

Peak SAR (extrapolated) = 0.619 W/kg

**SAR(1 g) = 0.351 mW/g; SAR(10 g) = 0.187 mW/g**

Maximum value of SAR (measured) = 0.391 mW/g

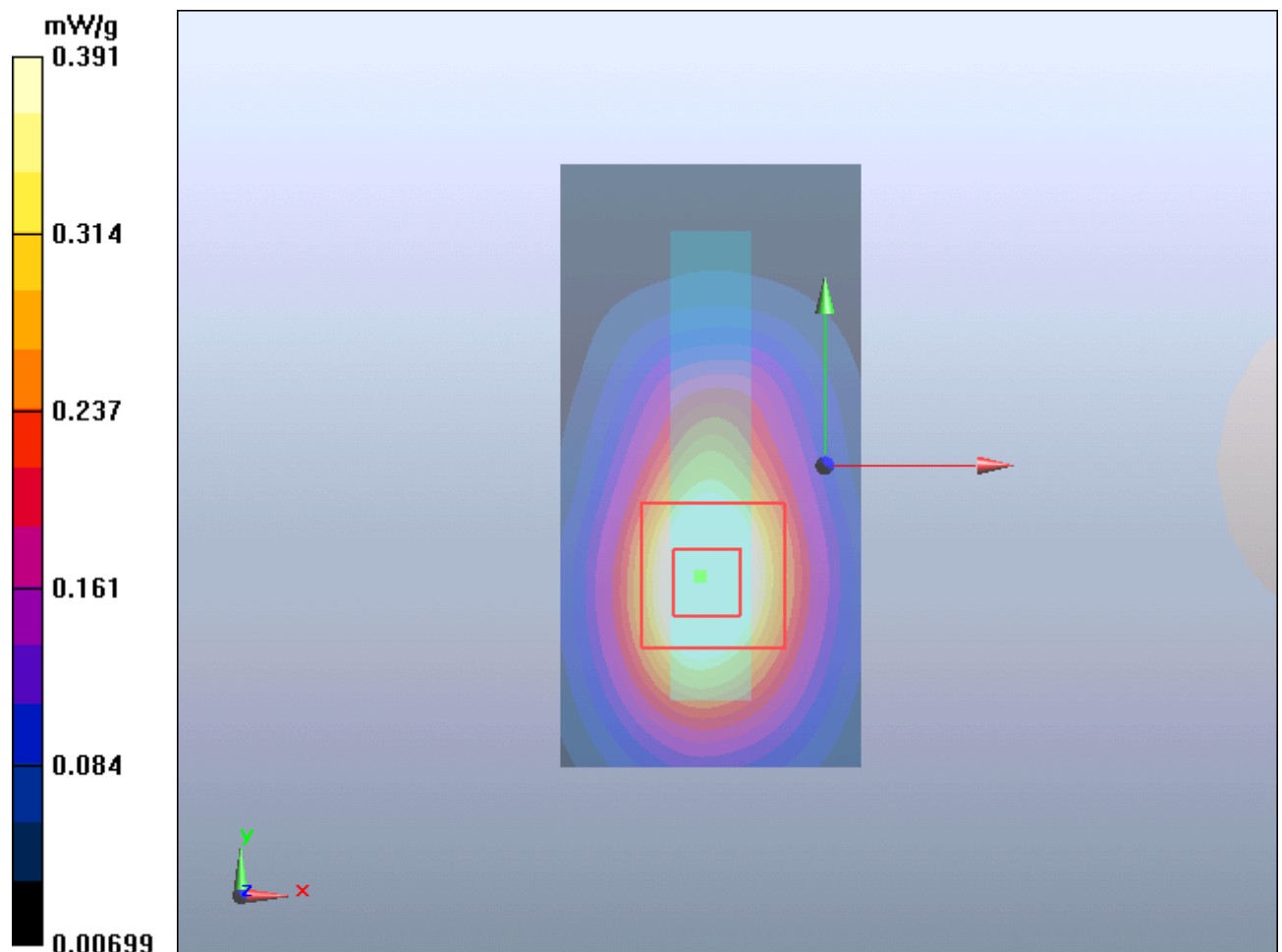

Figure 11 802.11b with IBM T61 Test Position 3 Channel 1

**802.11b with IBM T61 Test Position 4 Low**

Date/Time: 6/21/2012 3:37:36 PM

Communication System: 802.11b; Frequency: 2412 MHz; Duty Cycle: 1:1

Medium parameters used:  $f = 2412$  MHz;  $\sigma = 1.85$  mho/m;  $\epsilon_r = 51.7$ ;  $\rho = 1000$  kg/m<sup>3</sup>

Ambient Temperature: 22.3 °C      Liquid Temperature: 21.5 °C

Phantom section: Flat Section

DASY5 Configuration:

Probe: EX3DV4 - SN3753; ConvF(7.03, 7.03, 7.03); Calibrated: 1/4/2012

Electronics: DAE4 Sn1291; Calibrated: 10/10/2011

Phantom: SAM2; Type: SAM; Serial: TP-1524

Measurement SW: DASY5, V5.2 Build 162; SEMCAD X Version 14.0 Build 59

**Test Position 4 Low/Area Scan (31x61x1):** Measurement grid: dx=10mm, dy=10mm

Maximum value of SAR (interpolated) = 0.166 mW/g

**Test Position 4 Low/Zoom Scan (7x7x7)/Cube 0:** Measurement grid: dx=5mm, dy=5mm, dz=5mm

Reference Value = 7.42 V/m; Power Drift = 0.085 dB

Peak SAR (extrapolated) = 0.187 W/kg

**SAR(1 g) = 0.117 mW/g; SAR(10 g) = 0.071 mW/g**

Maximum value of SAR (measured) = 0.129 mW/g

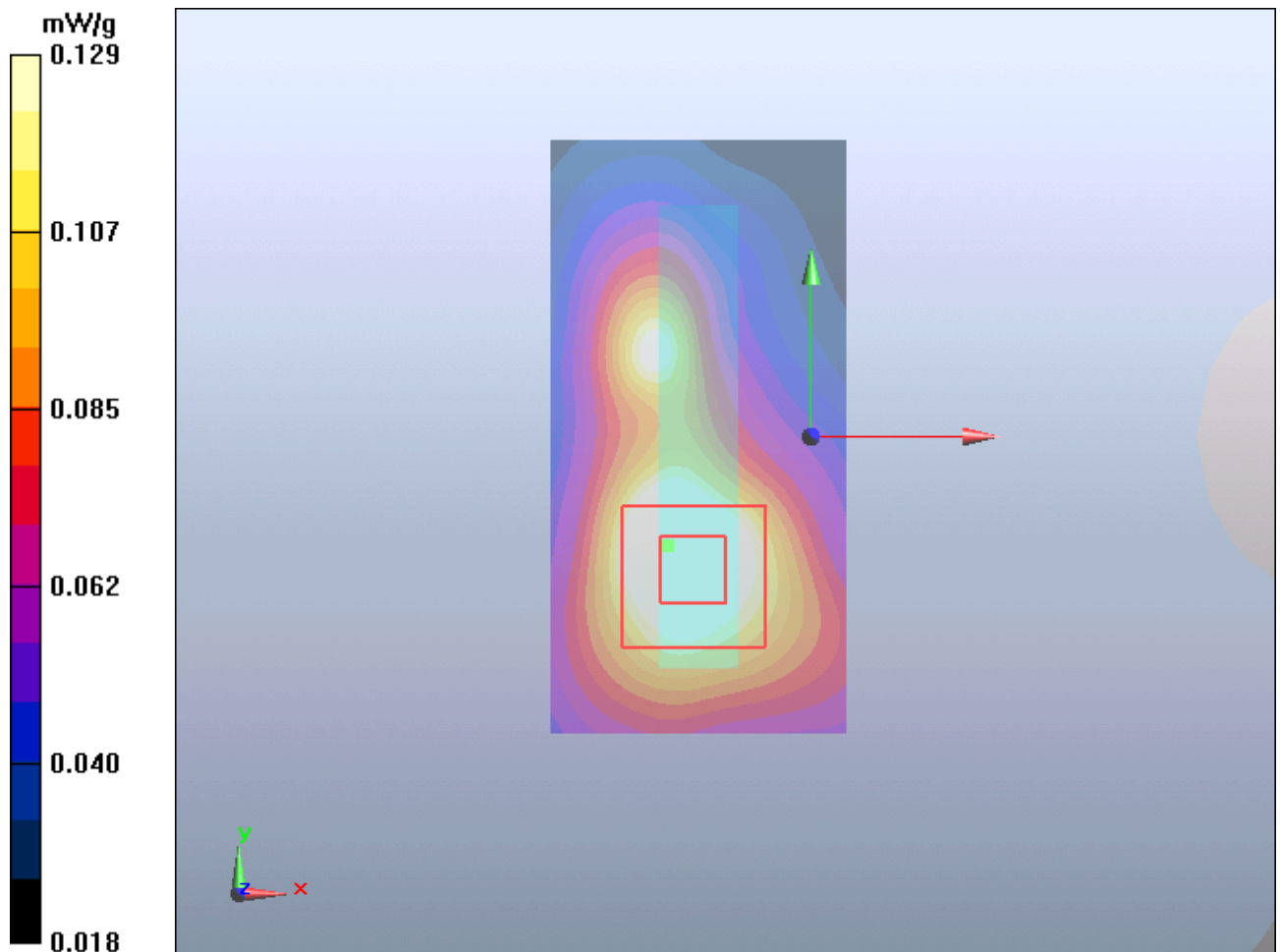

Figure 12 802.11b with IBM T61 Test Position 4 Channel 1

# TA Technology (Shanghai) Co., Ltd. Test Report

Report No. RXA1206-0418SAR01R1

Page 37 of 63

## ANNEX D: Probe Calibration Certificate

**Calibration Laboratory of  
Schmid & Partner  
Engineering AG**  
Zeughausstrasse 43, 8004 Zurich, Switzerland



**S** Schweizerischer Kalibrierdienst  
**C** Service suisse d'étalonnage  
**S** Servizio svizzero di taratura  
**S** Swiss Calibration Service

Accredited by the Swiss Accreditation Service (SAS)  
The Swiss Accreditation Service is one of the signatories to the EA  
Multilateral Agreement for the recognition of calibration certificates

Accreditation No.: **SCS 108**

Client **Auden**

Certificate No: **EX3-3753\_Jan12**

### CALIBRATION CERTIFICATE

Object: **EX3DV4 - SN:3753**

Calibration procedure(s): **QA CAL-01.v8, QA CAL-14.v3, QA CAL-23.v4, QA CAL-25.v4  
Calibration procedure for dosimetric E-field probes**

Calibration date: **January 4, 2012**

This calibration certificate documents the traceability to national standards, which realize the physical units of measurements (SI).  
The measurements and the uncertainties with confidence probability are given on the following pages and are part of the certificate.

All calibrations have been conducted in the closed laboratory facility: environment temperature (22 ± 3)°C and humidity < 70%.

Calibration Equipment used (M&TE critical for calibration)

Primary Standards	ID	Cal Date (Certificate No.)	Scheduled Calibration
Power meter E4419B	GB41293874	31-Mar-11 (No. 217-01372)	Apr-12
Power sensor E4412A	MY41498087	31-Mar-11 (No. 217-01372)	Apr-12
Reference 3 dB Attenuator	SN: S5054 (3c)	29-Mar-11 (No. 217-01369)	Apr-12
Reference 20 dB Attenuator	SN: S5086 (20b)	29-Mar-11 (No. 217-01367)	Apr-12
Reference 30 dB Attenuator	SN: S5129 (30b)	29-Mar-11 (No. 217-01370)	Apr-12
Reference Probe ES3DV2	SN: 3013	29-Dec-11 (No. ES3-3013_Dec11)	Dec-12
DAE4	SN: 654	3-May-11 (No. DAE4-654_May11)	May-12
Secondary Standards	ID	Check Date (in house)	Scheduled Check
RF generator HP 8648C	US3642U01700	4-Aug-99 (in house check Apr-11)	In house check: Apr-13
Network Analyzer HP 8753E	US37390585	18-Oct-01 (in house check Oct-11)	In house check: Oct-12

	Name	Function	Signature
Calibrated by:	Jeton Kastrat	Laboratory Technician	
Approved by:	Katja Pokovic	Technical Manager	

Issued: January 4, 2012

This calibration certificate shall not be reproduced except in full without written approval of the laboratory.



# TA Technology (Shanghai) Co., Ltd.

## Test Report

Report No. RXA1206-0418SAR01R1

Page 38 of 63

**Calibration Laboratory of**  
Schmid & Partner  
Engineering AG  
Zeughausstrasse 43, 8004 Zurich, Switzerland



**S** Schweizerischer Kalibrierdienst  
**C** Service suisse d'étalonnage  
**S** Servizio svizzero di taratura  
**S** Swiss Calibration Service

Accredited by the Swiss Accreditation Service (SAS)  
The Swiss Accreditation Service is one of the signatories to the EA  
Multilateral Agreement for the recognition of calibration certificates

Accreditation No.: **SCS 108**

### Glossary:

TSL	tissue simulating liquid
NORM <sub>x,y,z</sub>	sensitivity in free space
ConvF	sensitivity in TSL / NORM <sub>x,y,z</sub>
DCP	diode compression point
CF	crest factor (1/duty_cycle) of the RF signal
A, B, C	modulation dependent linearization parameters
Polarization $\phi$	$\phi$ rotation around probe axis
Polarization $\vartheta$	$\vartheta$ rotation around an axis that is in the plane normal to probe axis (at measurement center), i.e., $\vartheta = 0$ is normal to probe axis

### Calibration is Performed According to the Following Standards:

- IEEE Std 1528-2003, "IEEE Recommended Practice for Determining the Peak Spatial-Averaged Specific Absorption Rate (SAR) in the Human Head from Wireless Communications Devices: Measurement Techniques", December 2003
- IEC 62209-1, "Procedure to measure the Specific Absorption Rate (SAR) for hand-held devices used in close proximity to the ear (frequency range of 300 MHz to 3 GHz)", February 2005

### Methods Applied and Interpretation of Parameters:

- NORM<sub>x,y,z</sub>**: Assessed for E-field polarization  $\vartheta = 0$  ( $f \leq 900$  MHz in TEM-cell;  $f > 1800$  MHz: R22 waveguide). NORM<sub>x,y,z</sub> are only intermediate values, i.e., the uncertainties of NORM<sub>x,y,z</sub> does not affect the E<sup>2</sup>-field uncertainty inside TSL (see below ConvF).
- NORM(f)<sub>x,y,z</sub> = NORM<sub>x,y,z</sub> \* frequency\_response** (see Frequency Response Chart). This linearization is implemented in DASY4 software versions later than 4.2. The uncertainty of the frequency response is included in the stated uncertainty of ConvF.
- DCP<sub>x,y,z</sub>**: DCP are numerical linearization parameters assessed based on the data of power sweep with CW signal (no uncertainty required). DCP does not depend on frequency nor media.
- PAR**: PAR is the Peak to Average Ratio that is not calibrated but determined based on the signal characteristics
- A<sub>x,y,z</sub>; B<sub>x,y,z</sub>; C<sub>x,y,z</sub>; VR<sub>x,y,z</sub>; A, B, C** are numerical linearization parameters assessed based on the data of power sweep for specific modulation signal. The parameters do not depend on frequency nor media. VR is the maximum calibration range expressed in RMS voltage across the diode.
- ConvF and Boundary Effect Parameters**: Assessed in flat phantom using E-field (or Temperature Transfer Standard for  $f \leq 800$  MHz) and inside waveguide using analytical field distributions based on power measurements for  $f > 800$  MHz. The same setups are used for assessment of the parameters applied for boundary compensation (alpha, depth) of which typical uncertainty values are given. These parameters are used in DASY4 software to improve probe accuracy close to the boundary. The sensitivity in TSL corresponds to NORM<sub>x,y,z</sub> \* ConvF whereby the uncertainty corresponds to that given for ConvF. A frequency dependent ConvF is used in DASY version 4.4 and higher which allows extending the validity from  $\pm 50$  MHz to  $\pm 100$  MHz.
- Spherical isotropy (3D deviation from isotropy)**: in a field of low gradients realized using a flat phantom exposed by a patch antenna.
- Sensor Offset**: The sensor offset corresponds to the offset of virtual measurement center from the probe tip (on probe axis). No tolerance required.

EX3DV4 – SN:3753

January 4, 2012

# Probe EX3DV4

## SN:3753

Manufactured: March 16, 2010  
Calibrated: January 4, 2012

Calibrated for DASY/EASY Systems  
(Note: non-compatible with DASY2 system!)

# TA Technology (Shanghai) Co., Ltd. Test Report

EX3DV4- SN:3753

January 4, 2012

## DASY/EASY - Parameters of Probe: EX3DV4 - SN:3753

### Basic Calibration Parameters

	Sensor X	Sensor Y	Sensor Z	Unc (k=2)
Norm ( $\mu V/(V/m)^2$ ) <sup>A</sup>	0.33	0.49	0.53	$\pm 10.1 \%$
DCP (mV) <sup>B</sup>	103.0	96.0	100.6	

### Modulation Calibration Parameters

UID	Communication System Name	PAR		A dB	B dB	C dB	VR mV	Unc <sup>E</sup> (k=2)
10000	CW	0.00	X	0.00	0.00	1.00	119.0	$\pm 2.7 \%$
			Y	0.00	0.00	1.00	115.7	
			Z	0.00	0.00	1.00	116.2	

The reported uncertainty of measurement is stated as the standard uncertainty of measurement multiplied by the coverage factor k=2, which for a normal distribution corresponds to a coverage probability of approximately 95%.

<sup>A</sup> The uncertainties of NormX,Y,Z do not affect the E<sup>2</sup>-field uncertainty inside TSL (see Pages 5 and 6).

<sup>B</sup> Numerical linearization parameter: uncertainty not required.

<sup>E</sup> Uncertainty is determined using the max. deviation from linear response applying rectangular distribution and is expressed for the square of the field value.



# TA Technology (Shanghai) Co., Ltd. Test Report

Report No. RXA1206-0418SAR01R1

Page 41 of 63

EX3DV4-- SN:3753

January 4, 2012

## DASY/EASY - Parameters of Probe: EX3DV4 - SN:3753

### Calibration Parameter Determined in Head Tissue Simulating Media

f (MHz) <sup>C</sup>	Relative Permittivity <sup>F</sup>	Conductivity (S/m) <sup>F</sup>	ConvF X	ConvF Y	ConvF Z	Alpha	Depth (mm)	Unct. (k=2)
750	41.9	0.89	9.43	9.43	9.43	0.39	0.87	± 12.0 %
835	41.5	0.90	9.02	9.02	9.02	0.39	0.79	± 12.0 %
1750	40.1	1.37	8.37	8.37	8.37	0.10	1.14	± 12.0 %
1900	40.0	1.40	8.05	8.05	8.05	0.54	0.70	± 12.0 %
2000	40.0	1.40	7.94	7.94	7.94	0.10	0.89	± 12.0 %
2450	39.2	1.80	6.89	6.89	6.89	0.34	0.90	± 12.0 %
5200	36.0	4.66	4.83	4.83	4.83	0.36	1.80	± 13.1 %
5300	35.9	4.76	4.58	4.58	4.58	0.40	1.80	± 13.1 %
5500	35.6	4.96	4.63	4.63	4.63	0.40	1.80	± 13.1 %
5600	35.5	5.07	4.23	4.23	4.23	0.50	1.80	± 13.1 %
5800	35.3	5.27	4.26	4.26	4.26	0.50	1.80	± 13.1 %

<sup>C</sup> Frequency validity of ± 100 MHz only applies for DASY v4.4 and higher (see Page 2), else it is restricted to ± 50 MHz. The uncertainty is the RSS of the ConvF uncertainty at calibration frequency and the uncertainty for the indicated frequency band.

<sup>F</sup> At frequencies below 3 GHz, the validity of tissue parameters ( $\epsilon$  and  $\sigma$ ) can be relaxed to ± 10% if liquid compensation formula is applied to measured SAR values. At frequencies above 3 GHz, the validity of tissue parameters ( $\epsilon$  and  $\sigma$ ) is restricted to ± 5%. The uncertainty is the RSS of the ConvF uncertainty for indicated target tissue parameters.

# TA Technology (Shanghai) Co., Ltd. Test Report

EX3DV4- SN:3753

January 4, 2012

## DASY/EASY - Parameters of Probe: EX3DV4 - SN:3753

### Calibration Parameter Determined in Body Tissue Simulating Media

f (MHz) <sup>C</sup>	Relative Permittivity <sup>F</sup>	Conductivity (S/m) <sup>F</sup>	ConvF X	ConvF Y	ConvF Z	Alpha	Depth (mm)	Unct. (k=2)
750	55.5	0.96	9.29	9.29	9.29	0.30	1.11	± 12.0 %
835	55.2	0.97	9.18	9.18	9.18	0.47	0.85	± 12.0 %
1750	53.4	1.49	8.00	8.00	8.00	0.62	0.69	± 12.0 %
1900	53.3	1.52	7.57	7.57	7.57	0.31	0.93	± 12.0 %
2000	53.3	1.52	7.52	7.52	7.52	0.48	0.76	± 12.0 %
2300	52.9	1.81	7.20	7.20	7.20	0.49	0.75	± 12.0 %
2450	52.7	1.95	7.03	7.03	7.03	0.80	0.50	± 12.0 %
2600	52.5	2.16	6.75	6.75	6.75	0.80	0.50	± 12.0 %
3500	51.3	3.31	6.04	6.04	6.04	0.29	1.45	± 13.1 %
5200	49.0	5.30	4.30	4.30	4.30	0.50	1.90	± 13.1 %
5300	48.9	5.42	3.96	3.96	3.96	0.60	1.90	± 13.1 %
5500	48.6	5.65	3.67	3.67	3.67	0.60	1.90	± 13.1 %
5600	48.5	5.77	3.36	3.36	3.36	0.70	1.90	± 13.1 %
5800	48.2	6.00	3.86	3.86	3.86	0.60	1.90	± 13.1 %

<sup>C</sup> Frequency validity of ± 100 MHz only applies for DASY v4.4 and higher (see Page 2), else it is restricted to ± 50 MHz. The uncertainty is the RSS of the ConvF uncertainty at calibration frequency and the uncertainty for the indicated frequency band.

<sup>F</sup> At frequencies below 3 GHz, the validity of tissue parameters ( $\epsilon$  and  $\sigma$ ) can be relaxed to ± 10% if liquid compensation formula is applied to measured SAR values. At frequencies above 3 GHz, the validity of tissue parameters ( $\epsilon$  and  $\sigma$ ) is restricted to ± 5%. The uncertainty is the RSS of the ConvF uncertainty for indicated target tissue parameters.

EX3DV4- SN:3753

January 4, 2012

**Frequency Response of E-Field**  
(TEM-Cell:ifi110 EXX, Waveguide: R22)

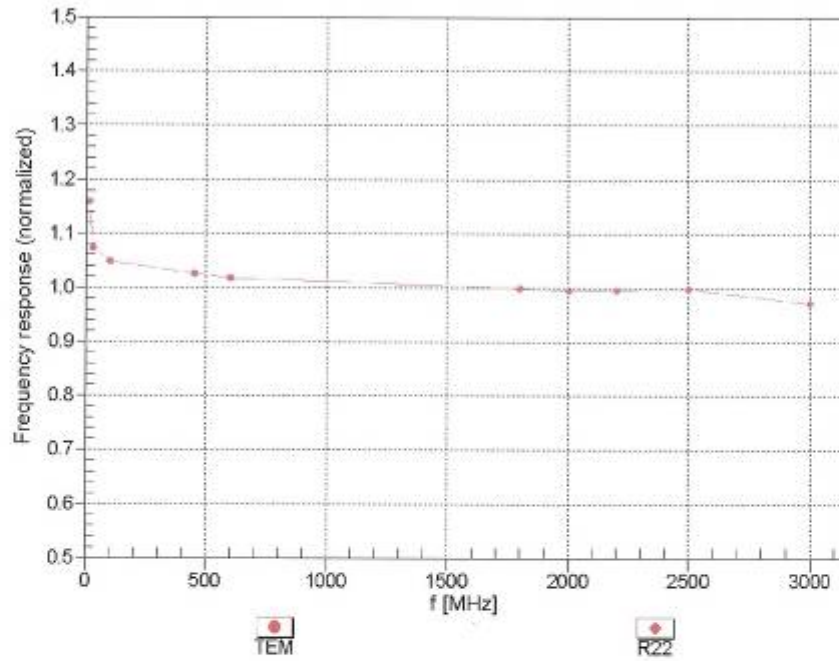

Uncertainty of Frequency Response of E-field:  $\pm 6.3\%$  ( $k=2$ )

EX3DV4- SN:3753

January 4, 2012

### Receiving Pattern ( $\phi$ ), $\theta = 0^\circ$

f=600 MHz, TEM

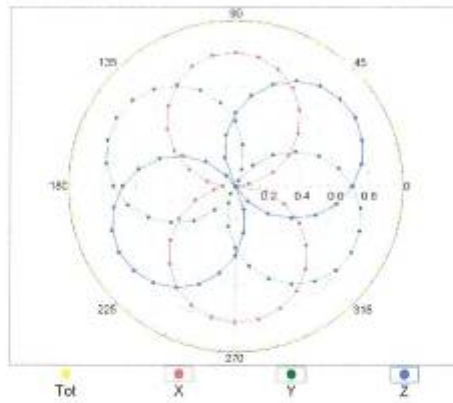

f=1800 MHz, R22

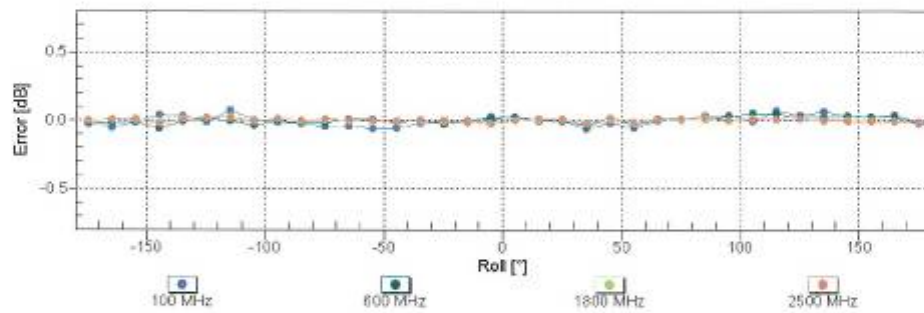
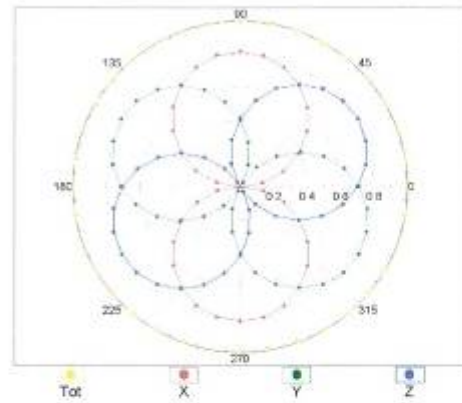

Uncertainty of Axial Isotropy Assessment:  $\pm 0.5\%$  (k=2)

EX3DV4- SN:3753

January 4, 2012

**Dynamic Range f(SAR<sub>head</sub>)**  
(TEM cell , f = 900 MHz)

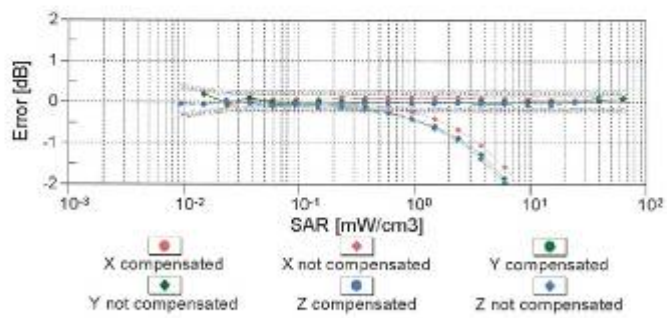
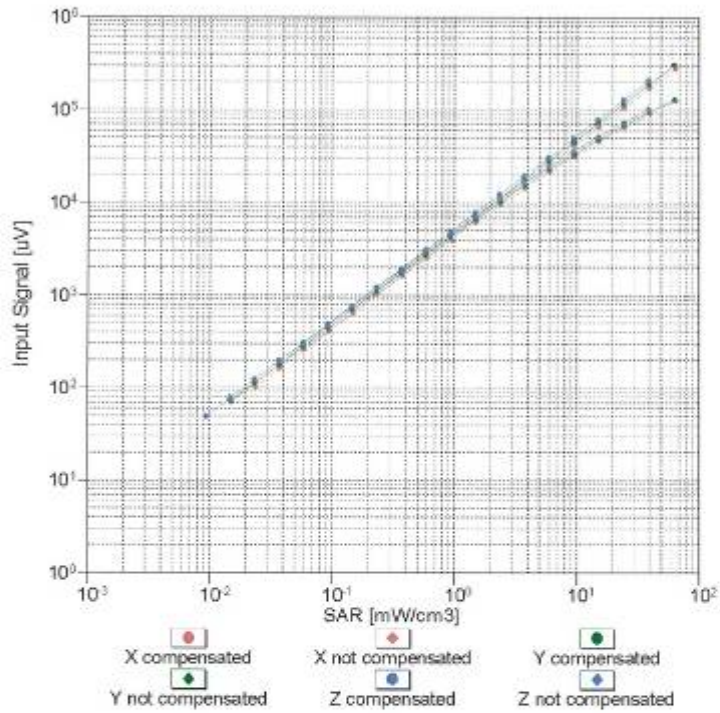

**Uncertainty of Linearity Assessment: ± 0.6% (k=2)**

EX3DV4- SN:3753

January 4, 2012

### Conversion Factor Assessment

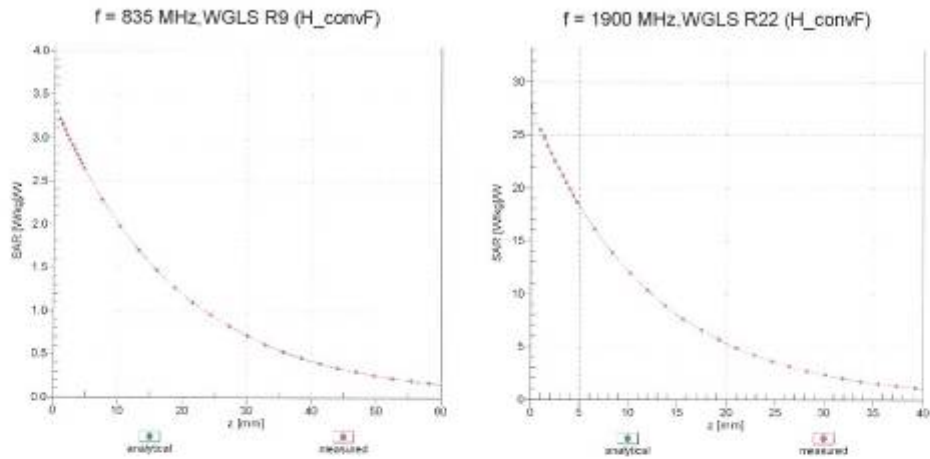

### Deviation from Isotropy in Liquid

Error ( $\phi, \theta$ ), f = 900 MHz

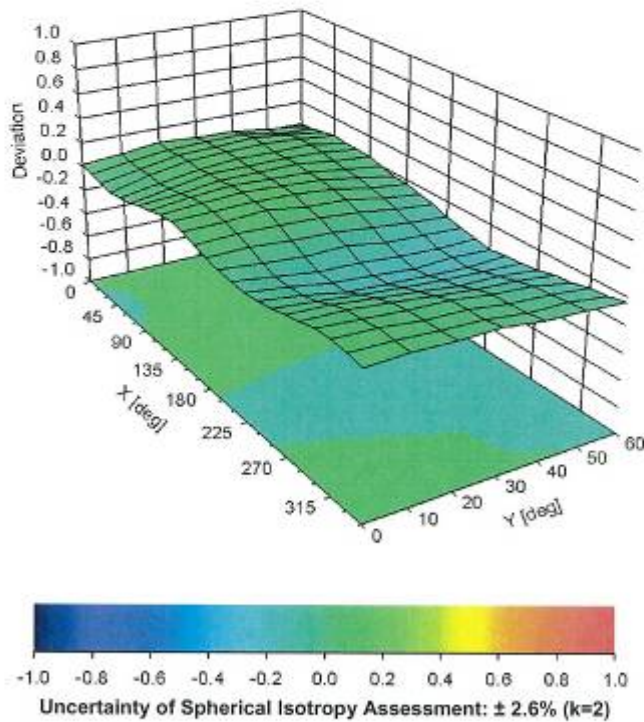



EX3DV4- SN:3753

January 4, 2012

## DASY/EASY - Parameters of Probe: EX3DV4 - SN:3753

### Other Probe Parameters

Sensor Arrangement	Triangular
Connector Angle (°)	Not applicable
Mechanical Surface Detection Mode	enabled
Optical Surface Detection Mode	disabled
Probe Overall Length	337 mm
Probe Body Diameter	10 mm
Tip Length	9 mm
Tip Diameter	2.5 mm
Probe Tip to Sensor X Calibration Point	1 mm
Probe Tip to Sensor Y Calibration Point	1 mm
Probe Tip to Sensor Z Calibration Point	1 mm
Recommended Measurement Distance from Surface	2 mm

# TA Technology (Shanghai) Co., Ltd. Test Report

Report No. RXA1206-0418SAR01R1

Page 48 of 63

## ANNEX E: D2450V2 Dipole Calibration Certificate

**Calibration Laboratory of  
Schmid & Partner  
Engineering AG**  
Zeughausstrasse 43, 8004 Zurich, Switzerland



**S** Schweizerischer Kalibrierdienst  
**C** Service suisse d'étalonnage  
**S** Servizio svizzero di taratura  
**S** Swiss Calibration Service

Accredited by the Swiss Accreditation Service (SAS)  
The Swiss Accreditation Service is one of the signatories to the EA  
Multilateral Agreement for the recognition of calibration certificates

Accreditation No.: **SCS 108**

Client **TA-Shanghai (Auden)**

Certificate No: **D2450V2-786\_Aug11**

### CALIBRATION CERTIFICATE

Object: **D2450V2 - SN: 786**

Calibration procedure(s): **QA CAL-05.v8  
Calibration procedure for dipole validation kits above 700 MHz**

Calibration date: **August 29, 2011**

This calibration certificate documents the traceability to national standards, which realize the physical units of measurements (SI).  
The measurements and the uncertainties with confidence probability are given on the following pages and are part of the certificate.

All calibrations have been conducted in the closed laboratory facility: environment temperature (22 ± 3)°C and humidity < 70%.

Calibration Equipment used (M&TE critical for calibration)

Primary Standards	ID #	Cal Date (Certificate No.)	Scheduled Calibration
Power meter EPM-442A	GB37480704	06-Oct-10 (No. 217-01266)	Oct-11
Power sensor HP 8481A	US37292783	06-Oct-10 (No. 217-01266)	Oct-11
Reference 20 dB Attenuator	SN: S5086 (20b)	29-Mar-11 (No. 217-01367)	Apr-12
Type-N mismatch combination	SN: 5047.2 / 06327	29-Mar-11 (No. 217-01371)	Apr-12
Reference Probe ES3DV3	SN: 3205	29-Apr-11 (No. ES3-3205_Apr11)	Apr-12
DAE4	SN: 601	04-Jul-11 (No. DAE4-601_Jul11)	Jul-12
Secondary Standards	ID #	Check Date (in house)	Scheduled Check
Power sensor HP 8481A	MY41092317	18-Oct-02 (in house check Oct-09)	In house check: Oct-11
RF generator R&S SMT-06	100005	04-Aug-99 (in house check Oct-09)	In house check: Oct-11
Network Analyzer HP 8753E	US37390585 S4206	18-Oct-01 (in house check Oct-10)	In house check: Oct-11

	Name	Function	Signature
Calibrated by:	Dimce Iliev	Laboratory Technician	
Approved by:	Katja Pokovic	Technical Manager	

Issued: August 29, 2011

This calibration certificate shall not be reproduced except in full without written approval of the laboratory.



# TA Technology (Shanghai) Co., Ltd. Test Report

Report No. RXA1206-0418SAR01R1

Page 49 of 63

**Calibration Laboratory of  
Schmid & Partner  
Engineering AG**  
Zeughausstrasse 43, 8004 Zurich, Switzerland



**S** Schweizerischer Kalibrierdienst  
**C** Service suisse d'étalonnage  
**S** Servizio svizzero di taratura  
**S** Swiss Calibration Service

Accredited by the Swiss Accreditation Service (SAS)

The Swiss Accreditation Service is one of the signatories to the EA  
Multilateral Agreement for the recognition of calibration certificates

Accreditation No.: **SCS 108**

## Glossary:

TSL	tissue simulating liquid
ConvF	sensitivity in TSL / NORM x,y,z
N/A	not applicable or not measured

## Calibration is Performed According to the Following Standards:

- IEEE Std 1528-2003, "IEEE Recommended Practice for Determining the Peak Spatial-Averaged Specific Absorption Rate (SAR) in the Human Head from Wireless Communications Devices: Measurement Techniques", December 2003
- IEC 62209-1, "Procedure to measure the Specific Absorption Rate (SAR) for hand-held devices used in close proximity to the ear (frequency range of 300 MHz to 3 GHz)", February 2005
- Federal Communications Commission Office of Engineering & Technology (FCC OET), "Evaluating Compliance with FCC Guidelines for Human Exposure to Radiofrequency Electromagnetic Fields; Additional Information for Evaluating Compliance of Mobile and Portable Devices with FCC Limits for Human Exposure to Radiofrequency Emissions", Supplement C (Edition 01-01) to Bulletin 65

## Additional Documentation:

- DASY4/5 System Handbook

## Methods Applied and Interpretation of Parameters:

- Measurement Conditions:** Further details are available from the Validation Report at the end of the certificate. All figures stated in the certificate are valid at the frequency indicated.
- Antenna Parameters with TSL:** The dipole is mounted with the spacer to position its feed point exactly below the center marking of the flat phantom section, with the arms oriented parallel to the body axis.
- Feed Point Impedance and Return Loss:** These parameters are measured with the dipole positioned under the liquid filled phantom. The impedance stated is transformed from the measurement at the SMA connector to the feed point. The Return Loss ensures low reflected power. No uncertainty required.
- Electrical Delay:** One-way delay between the SMA connector and the antenna feed point. No uncertainty required.
- SAR measured:** SAR measured at the stated antenna input power.
- SAR normalized:** SAR as measured, normalized to an input power of 1 W at the antenna connector.
- SAR for nominal TSL parameters:** The measured TSL parameters are used to calculate the nominal SAR result.

# TA Technology (Shanghai) Co., Ltd.

## Test Report

### Measurement Conditions

DASY system configuration, as far as not given on page 1.

DASY Version	DASY5	V52.6.2
Extrapolation	Advanced Extrapolation	
Phantom	Modular Flat Phantom	
Distance Dipole Center - TSL	10 mm	with Spacer
Zoom Scan Resolution	dx, dy, dz = 5 mm	
Frequency	2450 MHz ± 1 MHz	

### Head TSL parameters

The following parameters and calculations were applied.

	Temperature	Permittivity	Conductivity
Nominal Head TSL parameters	22.0 °C	39.2	1.80 mho/m
Measured Head TSL parameters	(22.0 ± 0.2) °C	38.4 ± 6 %	1.85 mho/m ± 6 %
Head TSL temperature change during test	< 0.5 °C	----	----

### SAR result with Head TSL

SAR averaged over 1 cm <sup>3</sup> (1 g) of Head TSL	Condition	
SAR measured	250 mW input power	13.7 mW / g
SAR for nominal Head TSL parameters	normalized to 1W	<b>53.8 mW / g ± 17.0 % (k=2)</b>

SAR averaged over 10 cm <sup>3</sup> (10 g) of Head TSL	condition	
SAR measured	250 mW input power	6.41 mW / g
SAR for nominal Head TSL parameters	normalized to 1W	<b>25.4 mW / g ± 16.5 % (k=2)</b>

### Body TSL parameters

The following parameters and calculations were applied.

	Temperature	Permittivity	Conductivity
Nominal Body TSL parameters	22.0 °C	52.7	1.95 mho/m
Measured Body TSL parameters	(22.0 ± 0.2) °C	51.8 ± 6 %	2.02 mho/m ± 6 %
Body TSL temperature change during test	< 0.5 °C	----	----

### SAR result with Body TSL

SAR averaged over 1 cm <sup>3</sup> (1 g) of Body TSL	Condition	
SAR measured	250 mW input power	13.2 mW / g
SAR for nominal Body TSL parameters	normalized to 1W	<b>51.7 mW / g ± 17.0 % (k=2)</b>

SAR averaged over 10 cm <sup>3</sup> (10 g) of Body TSL	condition	
SAR measured	250 mW input power	6.10 mW / g
SAR for nominal Body TSL parameters	normalized to 1W	<b>24.2 mW / g ± 16.5 % (k=2)</b>

# TA Technology (Shanghai) Co., Ltd.

## Test Report

### Appendix

#### Antenna Parameters with Head TSL

Impedance, transformed to feed point	$55.0 \Omega + 2.4 j\Omega$
Return Loss	- 25.5 dB

#### Antenna Parameters with Body TSL

Impedance, transformed to feed point	$50.4 \Omega + 3.5 j\Omega$
Return Loss	- 29.0 dB

#### General Antenna Parameters and Design

Electrical Delay (one direction)	1.154 ns
----------------------------------	----------

After long term use with 100W radiated power, only a slight warming of the dipole near the feedpoint can be measured.

The dipole is made of standard semirigid coaxial cable. The center conductor of the feeding line is directly connected to the second arm of the dipole. The antenna is therefore short-circuited for DC-signals.

No excessive force must be applied to the dipole arms, because they might bend or the soldered connections near the feedpoint may be damaged.

#### Additional EUT Data

Manufactured by	SPEAG
Manufactured on	May 06, 2005



**DASY5 Validation Report for Head TSL**

Date: 29.08.2011

Test Laboratory: SPEAG, Zurich, Switzerland

**DUT: Dipole 2450 MHz; Type: D2450V2; Serial: D2450V2 - SN: 786**

Communication System: CW; Frequency: 2450 MHz

Medium parameters used:  $f = 2450$  MHz;  $\sigma = 1.85$  mho/m;  $\epsilon_r = 38.4$ ;  $\rho = 1000$  kg/m<sup>3</sup>

Phantom section: Flat Section

Measurement Standard: DASY5 (IEEE/IEC/ANSI C63.19-2007)

DASY52 Configuration:

- Probe: ES3DV3 - SN3205; ConvF(4.45, 4.45, 4.45); Calibrated: 29.04.2011
- Sensor-Surface: 3mm (Mechanical Surface Detection)
- Electronics: DAE4 Sn601; Calibrated: 04.07.2011
- Phantom: Flat Phantom 5.0 (front); Type: QD000P50AA; Serial: 1001
- DASY52 52.6.2(482); SEMCAD X 14.4.5(3634)

**Dipole Calibration for Head Tissue/Pin=250 mW, d=10mm/Zoom Scan (7x7x7)/Cube 0:**

Measurement grid: dx=5mm, dy=5mm, dz=5mm

Reference Value = 101.5 V/m; Power Drift = 0.06 dB

Peak SAR (extrapolated) = 28.303 W/kg

**SAR(1 g) = 13.7 mW/g; SAR(10 g) = 6.41 mW/g**

Maximum value of SAR (measured) = 17.561 mW/g

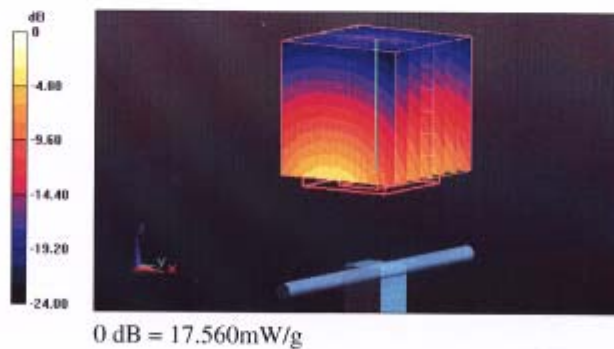

Impedance Measurement Plot for Head TSL

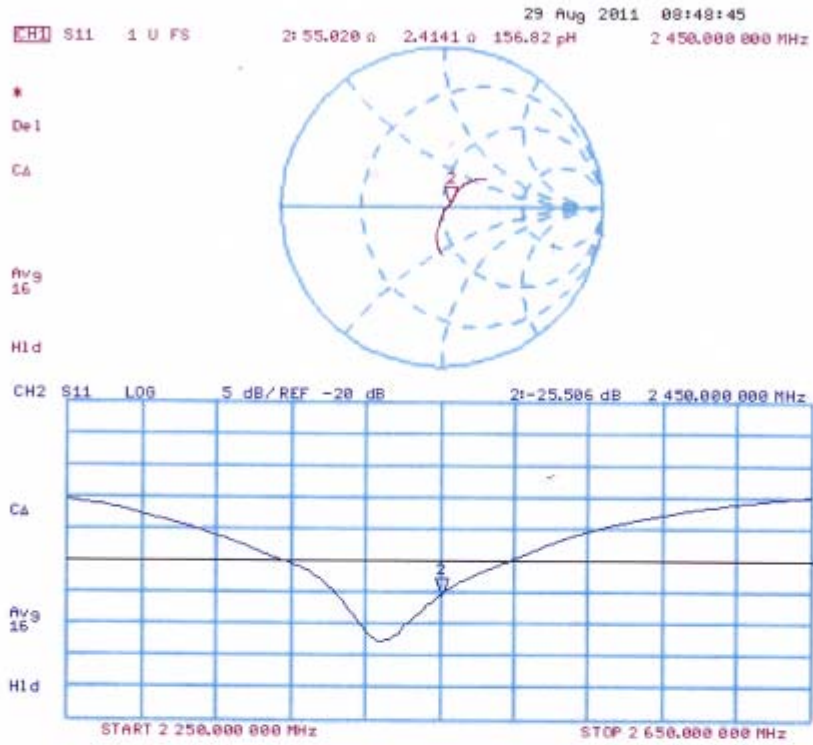

**DASY5 Validation Report for Body TSL**

Date: 29.08.2011

Test Laboratory: SPEAG, Zurich, Switzerland

**DUT: Dipole 2450 MHz; Type: D2450V2; Serial: D2450V2 - SN: 786**

Communication System: CW; Frequency: 2450 MHz

Medium parameters used:  $f = 2450$  MHz;  $\sigma = 2.02$  mho/m;  $\epsilon_r = 51.8$ ;  $\rho = 1000$  kg/m<sup>3</sup>

Phantom section: Flat Section

Measurement Standard: DASY5 (IEEE/IEC/ANSI C63.19-2007)

DASY52 Configuration:

- Probe: ES3DV3 - SN3205; ConvF(4.26, 4.26, 4.26); Calibrated: 29.04.2011
- Sensor-Surface: 3mm (Mechanical Surface Detection)
- Electronics: DAE4 Sn601; Calibrated: 04.07.2011
- Phantom: Flat Phantom 5.0 (back); Type: QD000P50AA; Serial: 1002
- DASY52 52.6.2(482); SEMCAD X 14.4.5(3634)

**Dipole Calibration for Body Tissue/Pin=250 mW, d=10mm/Zoom Scan (7x7x7)/Cube 0:**

Measurement grid: dx=5mm, dy=5mm, dz=5mm

Reference Value = 96.118 V/m; Power Drift = 0.0072 dB

Peak SAR (extrapolated) = 27.129 W/kg

**SAR(1 g) = 13.2 mW/g; SAR(10 g) = 6.1 mW/g**

Maximum value of SAR (measured) = 17.387 mW/g

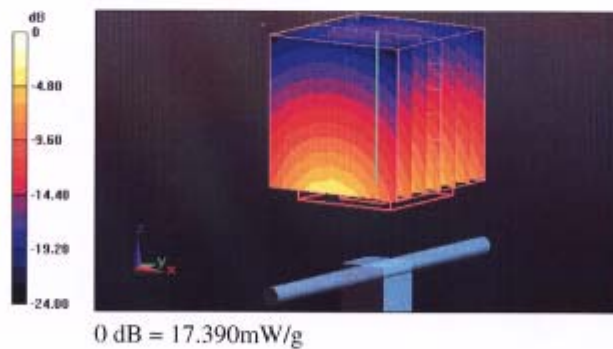

# TA Technology (Shanghai) Co., Ltd. Test Report

Report No. RXA1206-0418SAR01R1

Page 55 of 63

## Impedance Measurement Plot for Body TSL

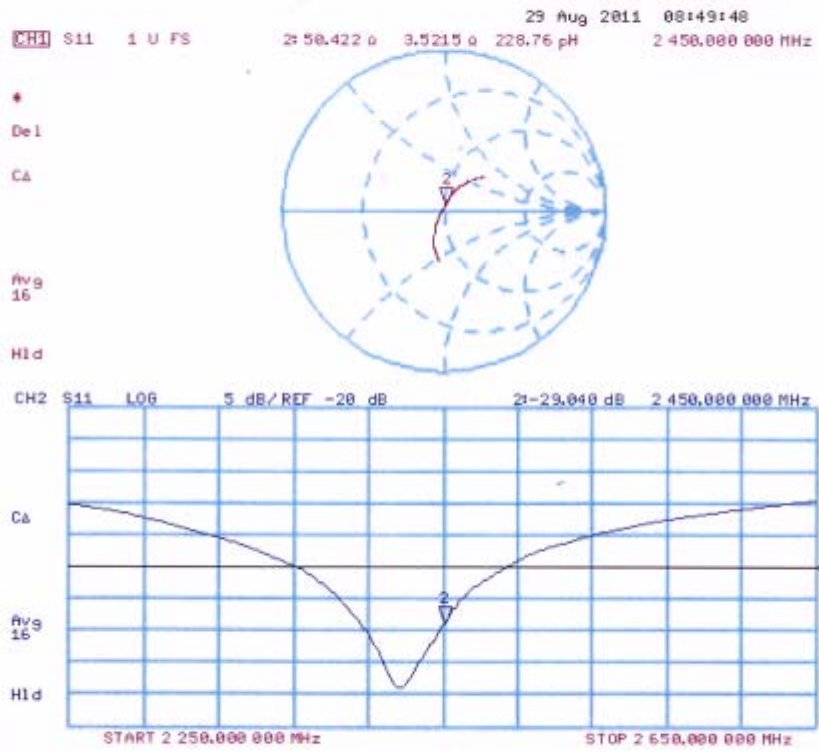

# TA Technology (Shanghai) Co., Ltd.

## Test Report

Report No. RXA1206-0418SAR01R1

Page 56 of 63

### ANNEX F: DAE4 Calibration Certificate

**Calibration Laboratory of  
Schmid & Partner  
Engineering AG**  
Zeughausstrasse 43, 8004 Zurich, Switzerland



**S** Schweizerischer Kalibrierdienst  
**S** Service suisse d'étalonnage  
**C** Servizio svizzero di taratura  
**S** Swiss Calibration Service

Accredited by the Swiss Accreditation Service (SAS)  
The Swiss Accreditation Service is one of the signatories to the EA  
Multilateral Agreement for the recognition of calibration certificates

Accreditation No.: **SCS 108**

Client **TMC Shanghai (Auden)**

Certificate No: **DAE4-1291\_Oct11**

#### CALIBRATION CERTIFICATE

Object: **DAE4 - SD 000 D04 BJ - SN: 1291**

Calibration procedure(s): **QA CAL-06.v23  
Calibration procedure for the data acquisition electronics (DAE)**

Calibration date: **October 10, 2011**

This calibration certificate documents the traceability to national standards, which realize the physical units of measurements (SI).  
The measurements and the uncertainties with confidence probability are given on the following pages and are part of the certificate.

All calibrations have been conducted in the closed laboratory facility: environment temperature (22 ± 3)°C and humidity < 70%.

Calibration Equipment used (M&TE critical for calibration)

Primary Standards	ID #	Cal Date (Certificate No.)	Scheduled Calibration
Keithley Multimeter Type 2001	SN: 0810278	28-Sep-11 (No:11450)	Sep-12
Secondary Standards	ID #	Check Date (In house)	Scheduled Check
Calibrator Box V1.1	SE UMS 006 AB 1004	08-Jun-11 (In house check)	In house check: Jun-12

Calibrated by:	Name <b>Andrea Guntli</b>	Function <b>Technician</b>	Signature 
Approved by:	Name <b>Fin Bomholt</b>	Function <b>R&amp;D Director</b>	Signature 

Issued: October 10, 2011

This calibration certificate shall not be reproduced except in full without written approval of the laboratory.



# TA Technology (Shanghai) Co., Ltd.

## Test Report

Report No. RXA1206-0418SAR01R1

Page 57 of 63

**Calibration Laboratory of  
Schmid & Partner  
Engineering AG**  
Zeughausstrasse 43, 8004 Zurich, Switzerland



**S** Schweizerischer Kalibrierdienst  
**C** Service suisse d'étalonnage  
**S** Servizio svizzero di taratura  
**S** Swiss Calibration Service

Accredited by the Swiss Accreditation Service (SAS)

The Swiss Accreditation Service is one of the signatories to the EA  
Multilateral Agreement for the recognition of calibration certificates

Accreditation No.: **SCS 108**

### Glossary

**DAE** data acquisition electronics  
**Connector angle** information used in DASY system to align probe sensor X to the robot coordinate system.

### Methods Applied and Interpretation of Parameters

- **DC Voltage Measurement:** Calibration Factor assessed for use in DASY system by comparison with a calibrated instrument traceable to national standards. The figure given corresponds to the full scale range of the voltmeter in the respective range.
- **Connector angle:** The angle of the connector is assessed measuring the angle mechanically by a tool inserted. Uncertainty is not required.
- The following parameters as documented in the Appendix contain technical information as a result from the performance test and require no uncertainty.
  - **DC Voltage Measurement Linearity:** Verification of the Linearity at +10% and -10% of the nominal calibration voltage. Influence of offset voltage is included in this measurement.
  - **Common mode sensitivity:** Influence of a positive or negative common mode voltage on the differential measurement.
  - **Channel separation:** Influence of a voltage on the neighbor channels not subject to an input voltage.
  - **AD Converter Values with inputs shorted:** Values on the internal AD converter corresponding to zero input voltage
  - **Input Offset Measurement:** Output voltage and statistical results over a large number of zero voltage measurements.
  - **Input Offset Current:** Typical value for information; Maximum channel input offset current, not considering the input resistance.
  - **Input resistance:** Typical value for information: DAE input resistance at the connector, during internal auto-zeroing and during measurement.
  - **Low Battery Alarm Voltage:** Typical value for information. Below this voltage, a battery alarm signal is generated.
  - **Power consumption:** Typical value for information. Supply currents in various operating modes.

# TA Technology (Shanghai) Co., Ltd.

## Test Report

Report No. RXA1206-0418SAR01R1

Page 58 of 63

### DC Voltage Measurement

A/D - Converter Resolution nominal

High Range: 1LSB = 6.1 $\mu$ V, full range = -100...+300 mV

Low Range: 1LSB = 61nV, full range = -1.....+3mV

DASY measurement parameters: Auto Zero Time: 3 sec; Measuring time: 3 sec

Calibration Factors	X	Y	Z
High Range	402.618 $\pm$ 0.1% (k=2)	403.311 $\pm$ 0.1% (k=2)	403.219 $\pm$ 0.1% (k=2)
Low Range	3.97373 $\pm$ 0.7% (k=2)	3.93305 $\pm$ 0.7% (k=2)	3.99084 $\pm$ 0.7% (k=2)

### Connector Angle

Connector Angle to be used in DASY system	309.0 $^{\circ}$ $\pm$ 1 $^{\circ}$
---	-------------------------------------

# TA Technology (Shanghai) Co., Ltd.

## Test Report

### Appendix

#### 1. DC Voltage Linearity

High Range	Reading ( $\mu\text{V}$ )	Difference ( $\mu\text{V}$ )	Error (%)
Channel X + Input	199992.4	-0.94	-0.00
Channel X + Input	20001.34	2.24	0.01
Channel X - Input	-19997.31	2.39	-0.01
Channel Y + Input	199994.7	2.28	0.00
Channel Y + Input	20000.26	0.46	0.00
Channel Y - Input	-19999.51	0.09	-0.00
Channel Z + Input	200005.6	-0.41	-0.00
Channel Z + Input	20000.09	0.09	0.00
Channel Z - Input	-20000.54	-0.94	0.00

Low Range	Reading ( $\mu\text{V}$ )	Difference ( $\mu\text{V}$ )	Error (%)
Channel X + Input	2000.1	-0.04	-0.00
Channel X + Input	200.47	0.57	0.29
Channel X - Input	-198.59	1.41	-0.70
Channel Y + Input	1999.8	-0.20	-0.01
Channel Y + Input	200.06	-0.04	-0.02
Channel Y - Input	-200.07	-0.07	0.03
Channel Z + Input	2000.0	-0.04	-0.00
Channel Z + Input	199.87	-0.13	-0.07
Channel Z - Input	-200.32	-0.12	0.06

#### 2. Common mode sensitivity

DASY measurement parameters: Auto Zero Time: 3 sec; Measuring time: 3 sec

	Common mode Input Voltage (mV)	High Range Average Reading ( $\mu\text{V}$ )	Low Range Average Reading ( $\mu\text{V}$ )
Channel X	200	9.31	7.38
	-200	-5.70	-7.73
Channel Y	200	13.16	13.22
	-200	-15.11	-15.12
Channel Z	200	-15.99	-16.16
	-200	14.64	14.71

#### 3. Channel separation

DASY measurement parameters: Auto Zero Time: 3 sec; Measuring time: 3 sec

	Input Voltage (mV)	Channel X ( $\mu\text{V}$ )	Channel Y ( $\mu\text{V}$ )	Channel Z ( $\mu\text{V}$ )
Channel X	200	-	3.83	-1.00
Channel Y	200	1.58	-	4.89
Channel Z	200	3.00	1.27	-

# TA Technology (Shanghai) Co., Ltd.

## Test Report

#### 4. AD-Converter Values with inputs shorted

DASY measurement parameters: Auto Zero Time: 3 sec; Measuring time: 3 sec

	High Range (LSB)	Low Range (LSB)
Channel X	16025	15514
Channel Y	15811	15983
Channel Z	16040	14624

#### 5. Input Offset Measurement

DASY measurement parameters: Auto Zero Time: 3 sec; Measuring time: 3 sec

Input 10M $\Omega$

	Average ( $\mu$ V)	min. Offset ( $\mu$ V)	max. Offset ( $\mu$ V)	Std. Deviation ( $\mu$ V)
Channel X	-1.78	-3.14	0.35	0.47
Channel Y	-1.26	-4.20	-0.42	0.45
Channel Z	-1.77	-2.71	-0.62	0.37

#### 6. Input Offset Current

Nominal Input circuitry offset current on all channels: <25fA

#### 7. Input Resistance (Typical values for information)

	Zeroing (kOhm)	Measuring (MOhm)
Channel X	200	200
Channel Y	200	200
Channel Z	200	200

#### 8. Low Battery Alarm Voltage (Typical values for information)

Typical values	Alarm Level (VDC)
Supply (+ Vcc)	+7.9
Supply (- Vcc)	-7.6

#### 9. Power Consumption (Typical values for information)

Typical values	Switched off (mA)	Stand by (mA)	Transmitting (mA)
Supply (+ Vcc)	+0.01	+6	+14
Supply (- Vcc)	-0.01	-8	-9

**ANNEX G: The EUT Appearances and Test Configuration**



**Picture 4: Constituents of the EUT**



Picture 5: Test position 1

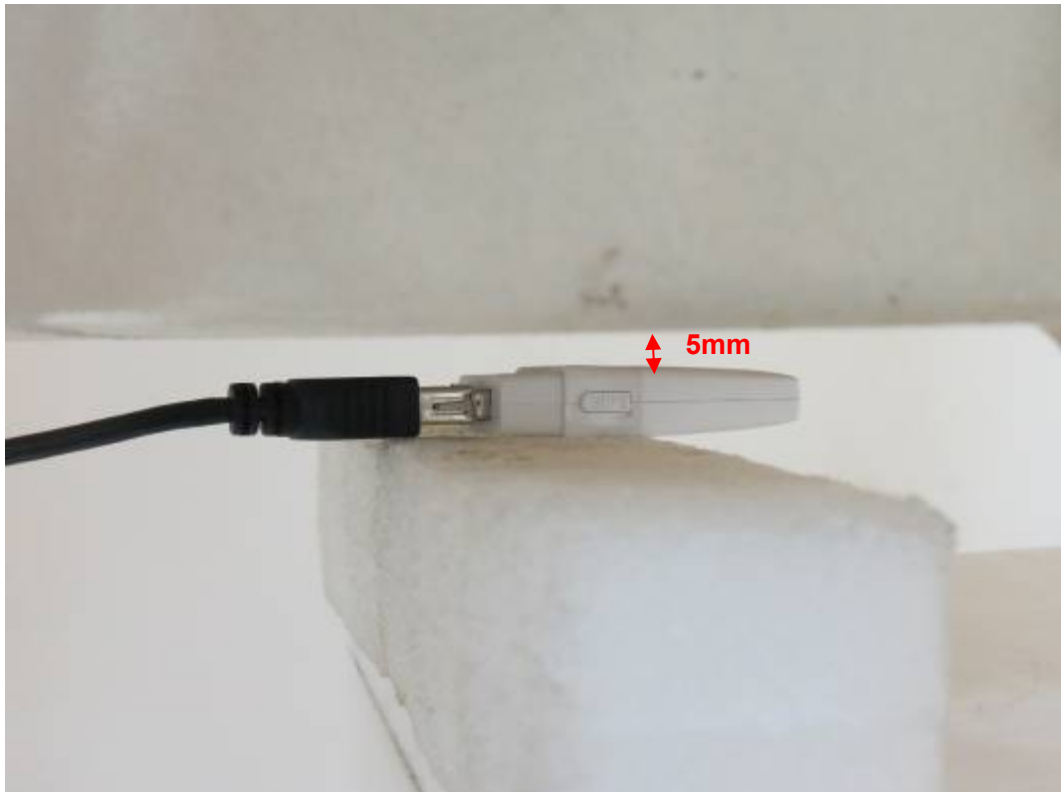

Picture 6: Test position 2

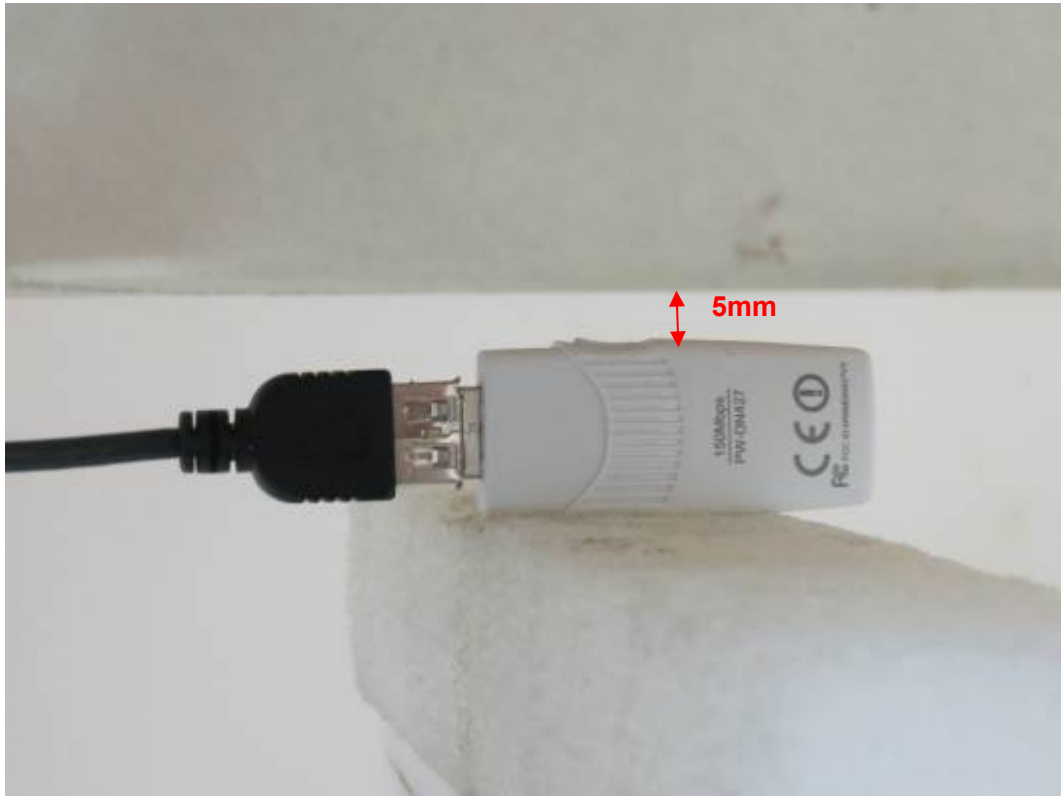

Picture 7: Test Position 3



Picture 8: Test Position 4