

WGI Innovations, Ltd.

Game Trail Camera

Main Model: I8
Serial Model: N/A

November 22, 2012



Report No.: 12020601-FCC-E1

(This report supersedes NONE)



Modifications made to the product : None

This Test Report is Issued Under the Authority of:

		
Alan Lv Compliance Engineer	Alex Liu Technical Manager	

This test report may be reproduced in full only.
Test result presented in this test report is applicable to the representative sample only.

EMC Test Report

To: FCC Part 15 Subpart B Class B: 2012, ANSI C63.4: 2009

SIEMIC, INC.
Accessing global markets



Laboratory Introduction

SIEMIC, headquartered in the heart of Silicon Valley, with superior facilities in US and Asia, is one of the leading independent testing and certification facilities providing customers with one-stop shop services for Compliance Testing and Global Certifications.



In addition to [testing](#) and [certification](#), SIEMIC provides initial design reviews and [compliance management](#) through out a project. Our extensive experience with [China](#), [Asia Pacific](#), [North America](#), [European](#), and [international](#) compliance requirements, assures the fastest, most cost effective way to attain regulatory compliance for the [global markets](#).

Accreditations for Conformity Assessment

**This test report may be reproduced in full only.
All test result in this report is applied specifically to presented test sample only.**

Taiwan	BSMI , NCC , NIST	EMC, RF, Telecom , Safety
Hong Kong	OFTA , NIST	RF/Wireless ,Telecom
Australia	NATA, NIST	EMC, RF, Telecom , Safety
Korea	KCC/RRA, NIST	EMI, EMS, RF , Telecom, Safety
Japan	VCCI, JATE, TELEC, RFT	EMI, RF/Wireless, Telecom
Mexico	NOM, COFETEL, Caniety	Safety, EMC , RF/Wireless, Telecom
Europe	A2LA, NIST	EMC, RF, Telecom , Safety

Accreditations for Product Certifications

Country/Region	Accreditation Body	Scope
USA	FCC TCB, NIST	EMC , RF , Telecom
Canada	IC FCB , NIST	EMC , RF , Telecom
Singapore	iDA, NIST	EMC , RF , Telecom
EU	NB	EMC & R&TTE Directive
Japan	MIC, (RCB 208)	RF , Telecom
Hong Kong	OFTA (US002)	RF , Telecom



SIEMIC, INC.

Accessing global markets

Title: EMC Test Report for Game Trail Camera
Main Model: I8
Serial Model: N/A
To: FCC Part 15 Subpart B Class B: 2012 , ANSI C63.4:2009

Report No.: 12020601-FCC-E1
Issue Date: November 22, 2012
Page: 3 of 32
www.siemic.com

This page has been left blank intentionally.



CONTENTS

1	EXECUTIVE SUMMARY & EUT INFORMATION	5
2	TECHNICAL DETAILS.....	6
3	MODIFICATION.....	7
4	TEST SUMMARY.....	8
5	MEASUREMENTS, EXAMINATION AND DERIVED RESULTS.....	9
	ANNEX A. TEST INSTRUMENTATION & GENERAL PROCEDURES	14
	ANNEX B. EUT AND TEST SETUP PHOTOGRAPHS	18
	ANNEX C. TEST SETUP AND SUPPORTING EQUIPMENT.....	27
	ANNEX D. USER MANUAL / BLOCK DIAGRAM / SCHEMATICS / PART LIST	31
	ANNEX E. DECLARATION OF SIMILARITY	32



SIEMIC, INC.

Accessing global markets

Title: EMC Test Report for Game Trail Camera
Main Model: I8
Serial Model: N/A
To: FCC Part 15 Subpart B Class B: 2012 , ANSI C63.4:2009

Report No.: 12020601-FCC-E1
Issue Date: November 22, 2012
Page: 5 of 32
www.siemic.com

1 EXECUTIVE SUMMARY & EUT INFORMATION

The purpose of this test programme was to demonstrate compliance of the WGI Innovations, Ltd., Game Trail Camera and Model: I8 against the current Stipulated Standards. The Game Trail Camera has demonstrated compliance with the FCC Part 15 Subpart B Class B: 2012, ANSI C63.4:2009.

EUT Information

EUT Description : Game Trail Camera

Main Model : I8

Serial Model : N/A

Input Power : Rating: DC 6V x 300mA=1.8W

Classification Per Stipulated Test Standard : Class B Emission Product Per FCC Part 15 Subpart B Class B: 2012, ANSI C63.4:2009



SIEMIC, INC.

Accessing global markets

Title: EMC Test Report for Game Trail Camera
Main Model: I8
Serial Model: N/A
To: FCC Part 15 Subpart B Class B: 2012 , ANSI C63.4:2009

Report No.: 12020601-FCC-E1
Issue Date: November 22, 2012
Page: 6 of 32
www.siemic.com

2 TECHNICAL DETAILS

Purpose	Compliance testing of Game Trail Camera with stipulated standards
Applicant / Client	WGI Innovations, Ltd. 602 Fountain Parkway Grand Prairie, TX 75050, U.S.A.
Manufacturer	Dongguan Southstar Electronics Ltd. F Building, 3 Chengtian Rd, Mintian, Shatian Town, Dongguan, Guangdong, China
Laboratory performing the tests	SIEMIC Nanjing (China) Laboratories NO.2-1, Longcang Dadao, Yuhua Economic Development Zone, Nanjing, China Tel:+86(25)86730128/86730129 Fax:+86(25)86730127 Email:info@siemic.com
Test report reference number	12020601-FCC-E1
Date EUT received	July 18, 2012
Standard applied	FCC Part 15 Subpart B Class B: 2012, ANSI C63.4:2009
Dates of test (from – to)	July 21, 2012
No of Units	#1
Equipment Category	ITE
Trade Name	Wildgame Innovations
Highest Operated Frequency (ies)	27MHz
Port/Connectors	USB Port, Power Port
FCC ID	YTT-I8



SIEMIC, INC.

Accessing global markets

Title: EMC Test Report for Game Trail Camera
Main Model: I8
Serial Model: N/A
To: FCC Part 15 Subpart B Class B: 2012 , ANSI C63.4:2009

Report No.: 12020601-FCC-E1
Issue Date: November 22, 2012
Page: 7 of 32
www.siemic.com

3 MODIFICATION

NONE

4 TEST SUMMARY

The product was tested in accordance with the following specifications.
All testing has been performed according to below product classification:

Class B Emission Product

Test Results Summary

Emissions			
Test Standard	Description	Product Class	Pass / Fail
FCC Part 15 Subpart B Class B: 2012	Conducted Emissions	See Above	Pass
FCC Part 15 Subpart B Class B: 2012	Radiated Emissions	See Above	Pass

All measurement uncertainty is not taken into consideration for all presented test result.



5 MEASUREMENTS, EXAMINATION AND DERIVED RESULTS

5.1 Conducted Emissions Test Result

Note:

1. All possible modes of operation were investigated. Only the several worst case emissions measured, using the correct CISPR and Average detectors, are reported. All other emissions were relatively insignificant.
2. A "-ve" margin indicates a PASS as it refers to the margin present below the limit line at the particular frequency.
3. Conducted Emissions Measurement Uncertainty
All test measurements carried out are traceable to national standards. The uncertainty of the measurement at a confidence level of approximately 95% (in the case where distributions are normal), with a coverage factor of 2, in the range 9kHz – 30MHz (Average & Quasi-peak) is $\pm 3.86\text{dB}$.
4. Environmental Conditions

Temperature	25°C
Relative Humidity	50%
Atmospheric Pressure	1009mbar
5. Test date : July 21, 2012
Tested By : Alan Lv

Test Result: Pass

Test Mode:	Transfer data
-------------------	----------------------

Peak Detector  **Quasi Peak Limit** 
Average Detector  **Average Limit** 

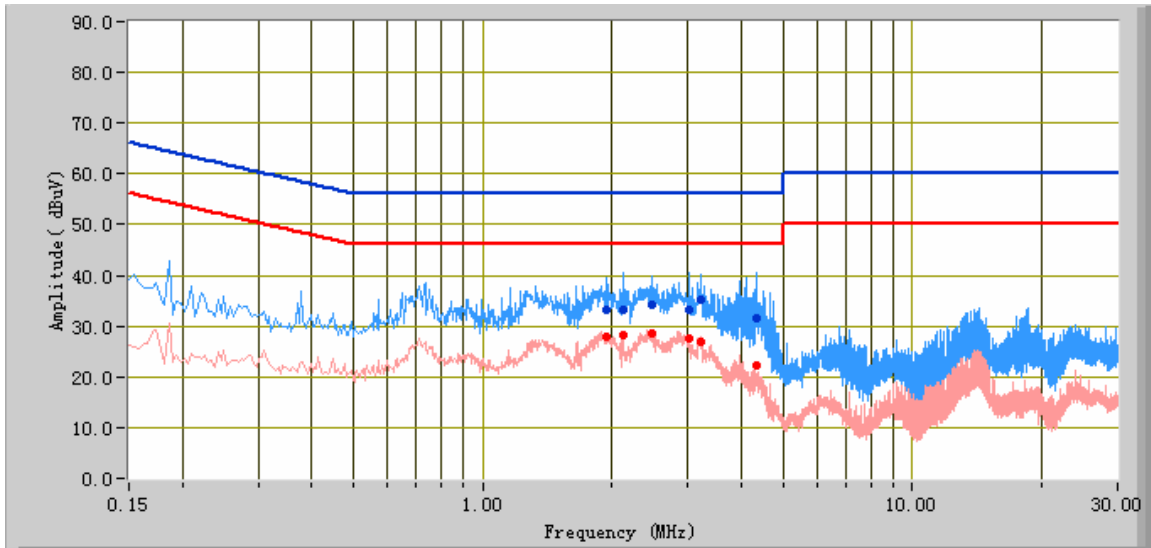

Test Data

Phase Neutral Plot at 120V AC, 60Hz

Frequency (MHz)	Quasi Peak (dBµV)	Limit (dBµV)	Margin (dB)	Average (dBµV)	Limit (dBµV)	Margin (dB)	Factors (dB)
3.01	33.15	56.00	-22.85	27.45	46.00	-18.55	10.20
4.32	31.66	56.00	-24.34	22.35	46.00	-23.65	10.45
2.12	33.14	56.00	-22.86	28.08	46.00	-17.92	10.20
3.22	35.19	56.00	-20.81	27.04	46.00	-18.96	10.27
2.47	34.36	56.00	-21.64	28.47	46.00	-17.53	10.20
1.95	33.24	56.00	-22.76	27.88	46.00	-18.12	10.20

Test Mode:	Transfer data
-------------------	----------------------

Peak Detector		Quasi Peak Limit	
Average Detector		Average Limit	

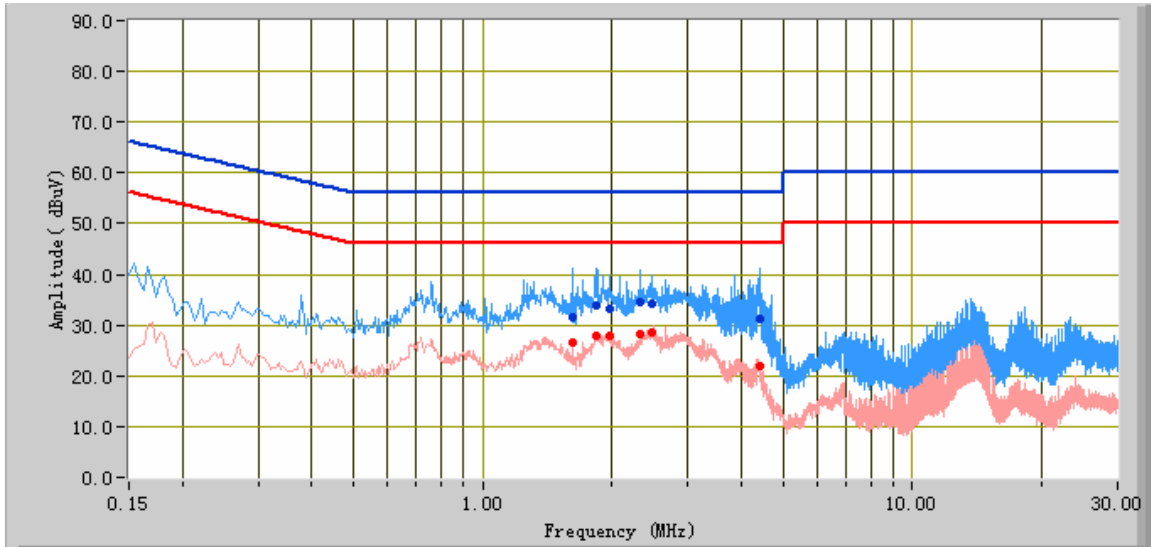

Test Data

Phase Line Plot at 120V AC, 60Hz

Frequency (MHz)	Quasi Peak (dBµV)	Limit (dBµV)	Margin (dB)	Average (dBµV)	Limit (dBµV)	Margin (dB)	Factors (dB)
4.41	31.20	56.00	-24.80	21.93	46.00	-24.07	10.44
1.83	33.90	56.00	-22.10	27.98	46.00	-18.02	10.19
1.62	31.58	56.00	-24.42	26.54	46.00	-19.46	10.19
2.32	34.42	56.00	-21.58	28.20	46.00	-17.80	10.20
2.47	34.25	56.00	-21.75	28.55	46.00	-17.45	10.20
1.97	33.29	56.00	-22.71	27.79	46.00	-18.21	10.20

5.2 Radiated Emissions Test Results

Note:



1. All possible modes of operation were investigated. Only the several worst case emissions measured, using the correct CISPR detectors, are reported. All other emissions were relatively insignificant.
2. A "-ve" margin indicates a PASS as it refers to the margin present below the limit line at the particular frequency.
3. Radiated Emissions Measurement Uncertainty
All test measurements carried out are traceable to national standards. The uncertainty of the measurement at a confidence level of approximately 95% (in the case where distributions are normal), with a coverage factor of 2, in the range 30MHz – 1GHz (QP only @ 3m & 10m) is +6dB/-6dB (for EUTs < 0.5m X 0.5m X 0.5m).
4. Environmental Conditions

Temperature	25°C
Relative Humidity	50%
Atmospheric Pressure	1011mbar
5. Test date : July 21, 2012
Tested By : Alan Lv

Test Result: Pass

Test Mode:	Transfer data
-------------------	----------------------

Below 1GHz

Peak Detector 
 Quasi Peak Limit 

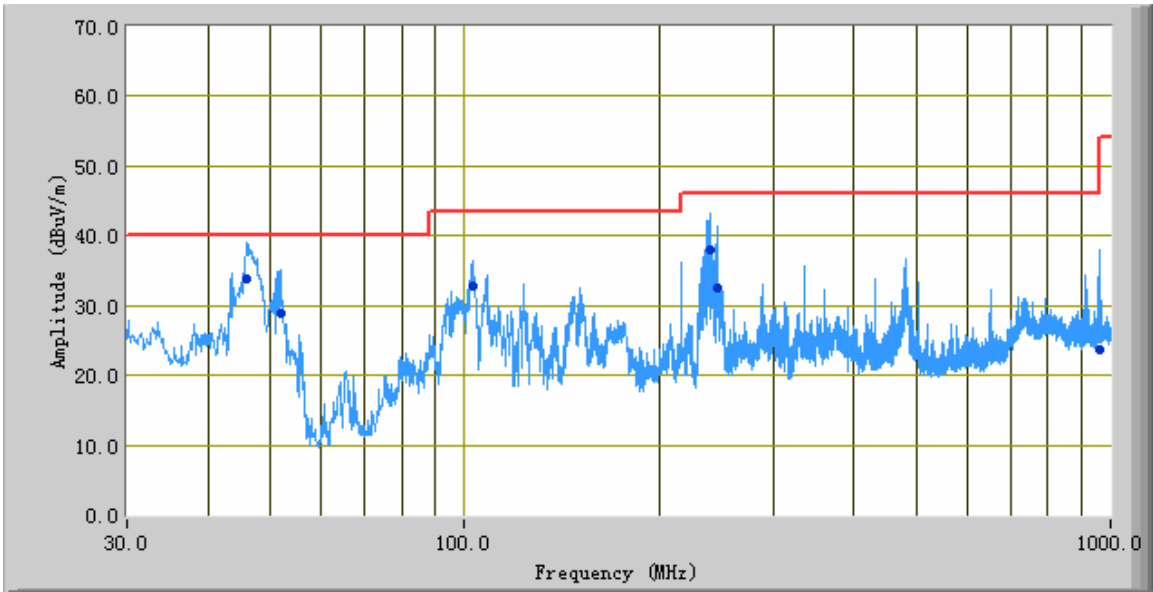

Test Data

Horizontal & Vertical Polarity Plot at 3m

Frequency (MHz)	Quasi Peak (dBµV/m)	Azimuth	Polarity(H/V)	Height (cm)	Factors (dB)	Limit (dBµV/m)	Margin (dB)
46.02	33.85	304.00	V	119.00	-30.13	40.00	-6.15
240.04	38.01	238.00	V	102.00	-33.05	46.00	-7.99
245.71	32.62	204.00	V	101.00	-32.66	46.00	-13.38
51.84	28.98	197.00	V	147.00	-33.64	40.00	-11.02
102.88	32.77	157.00	V	100.00	-32.91	43.50	-10.73
959.98	23.63	50.00	H	118.00	-19.96	46.00	-22.37

Note: The above 1GHz testing is not necessary due to the operating frequency below 108MHz.

Annex A. TEST INSTRUMENTATION & GENERAL PROCEDURES

Annex A.i. TEST INSTRUMENTATION

Instrument	Model	Serial #	Calibration Date	Calibration Due Date
AC Line Conducted Emissions				
R&S EMI Test Receiver	ESPI3	101216	10/27/2012	10/26/2013
V-LISN	ESH3-Z5	838979/005	10/27/2012	10/26/2013
Com-Power Transient Limiter	LIT-153	531021	11/03/2012	11/02/2013
SIEMIC Labview Conducted Emissions software V1.0	N/A	N/A	N/A	N/A
Radiated Emissions				
Hp Spectrum Analyzer	8563E	3821A09023	01/10/2012	01/09/2013
R&S EMI Receiver	ESPI3	101216	10/27/2012	10/26/2013
Antenna (30MHz~6GHz)	JB6	A121411	12/28/2011	12/27/2012
ETS-Lindgren Antenna (1 ~18GHz)	3115	N/A	10/29/2012	10/28/2013
A-INFOMW Antenna (1 ~18GHz)	JXTXLB-10180	J2031081120092	06/25/2012	06/24/2013
Horn Antenna (18~40GHz)	AH-840	101013	04/22/2012	04/22/2013
Microwave Pre-Amp (18~40GHz)	PA-840	181250	05/30/2012	05/29/2013
Hp Agilent Pre-Amplifier	8447F	1937A01160	11/03/2012	11/02/2013
MITEQ Pre-Amplifier (0.1 ~ 18GHz)	AMF-7D-00101800-30-10P	1451709	11/03/2012	11/02/2013
Chamber	3m	N/A	04/13/2012	04/12/2013
SIEMIC Labview Radiated Emissions software V1.0	N/A	N/A	N/A	N/A

Annex A.ii. CONDUCTED EMISSIONS TEST DESCRIPTION

Test Set-up

1. The EUT and supporting equipment were set up in accordance with the requirements of the standard on top of a 1.5m x 1m x 0.8m high, non-metallic table, as shown in Annex B.
2. The power supply for the EUT was fed through a 50Ω/50μH EUT LISN, connected to filtered mains.
3. The RF OUT of the EUT LISN was connected to the EMI test receiver via a low-loss coaxial cable.
4. All other supporting equipments were powered separately from another main supply.

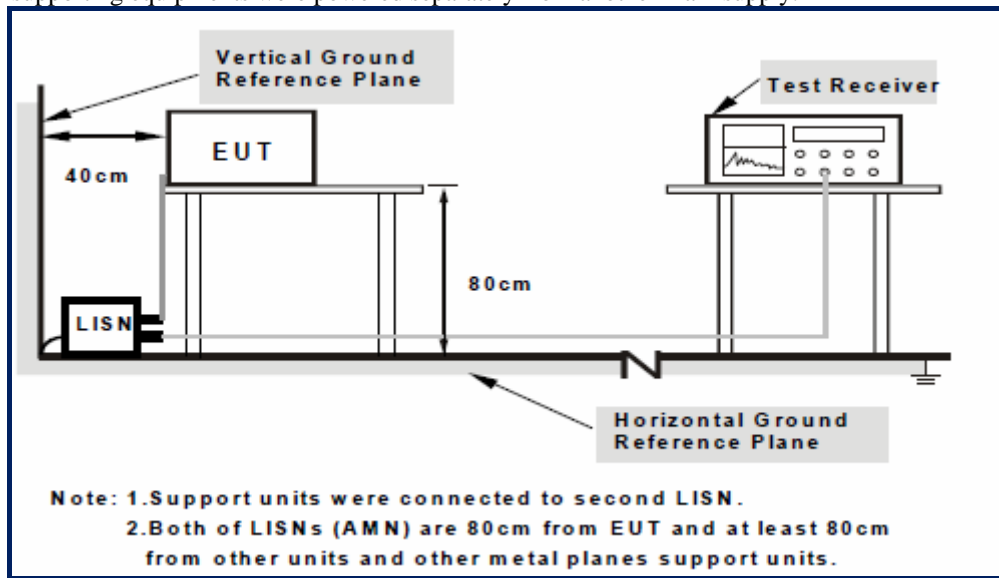

For the actual test configuration, please refer to the related item – Photographs of the Test Configuration1

Test Method

1. The EUT was switched on and allowed to warm up to its normal operating condition.
2. A scan was made on the NEUTRAL line (for AC mains) or Earth line (for DC power) over the required frequency range using an EMI test receiver.
3. High peaks, relative to the limit line, were then selected.
4. The EMI test receiver was then tuned to the selected frequencies and the necessary measurements made with a receiver bandwidth setting of 10kHz. For FCC tests, only Quasi-peak measurements were made; while for CISPR/EN tests, both Quasi-peak and Average measurements were made.
5. Steps 2 to 4 were then repeated for the LIVE line (for AC mains) or DC line (for DC power).

Sample Calculation Example

At 20MHz	limit = 250μV = 47.96dBμV
Transducer factor of LISN, pulse limiter & cable loss at 20MHz = 11.20dB	
Q-P reading obtained directly from EMI Receiver = 40.00dBμV (Calibrated for system losses)	
Therefore, Q-P margin = 40.00-47.96 = -7.96	i.e. 7.96 dB below limit

Annex A. iii. RADIATED EMISSIONS TEST DESCRIPTION

EUT Characterisation

EUT characterisation, over the frequency range from 30MHz to 10th Harmonic, was done in order to minimise radiated emissions testing time while still maintaining high confidence in the test results.

The EUT was placed in the chamber, at a height of about 0.8 m on a turntable. Its radiated emissions frequency profile was observed, using a spectrum analyzer /receiver with the appropriate broadband antenna placed 3m away from the EUT. Radiated emissions from the EUT were maximised by rotating the turntable manually, changing the antenna polarisation and manipulating the EUT cables while observing the frequency profile on the spectrum analyzer / receiver. Frequency points at which maximum emissions occurred; clock frequencies and operating frequencies were then noted for the formal radiated emissions test at the Open Area Test Site (OATS) or 3m EMC chamber.

Test Set-up

1. The EUT and supporting equipment were set up in accordance with the requirements of the standard on top of a 1.5mX1.0mX0.8m high, non-metallic table.
2. The filtered power supply for the EUT and supporting equipment were tapped from the appropriate power sockets located on the turntable.
3. The relevant broadband antenna was set at the required test distance away from the EUT and supporting equipment boundary.

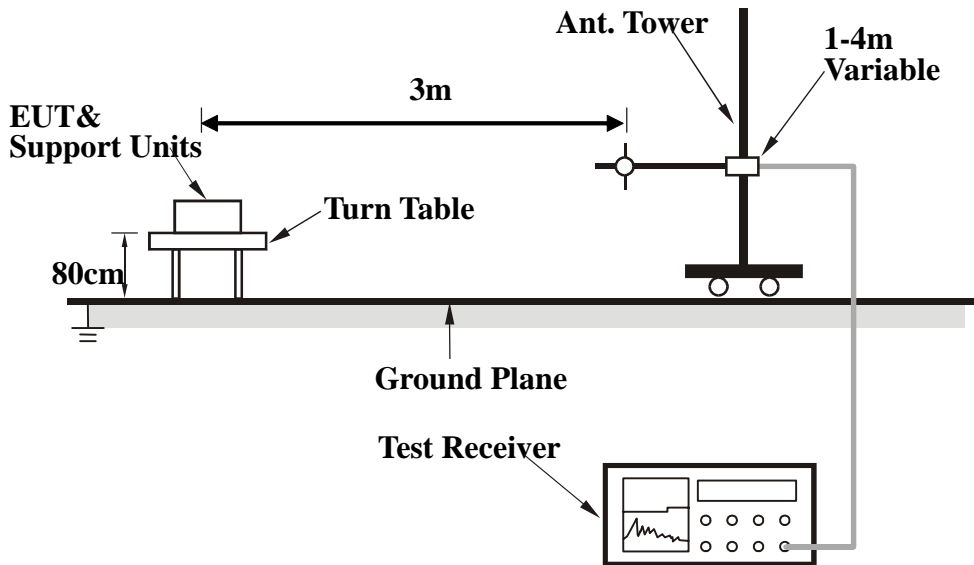

For the actual test configuration, please refer to the related item – Photographs of the Test Configuration2

Test Method

The following procedure was performed to determine the maximum emission axis of EUT:

1. With the receiving antenna is H polarization, rotate the EUT in turns with three orthogonal axes to determine the axis of maximum emission.
2. With the receiving antenna is V polarization, rotate the EUT in turns with three orthogonal axes to determine the axis of maximum emission.
3. Compare the results derived from above two steps. So, the axis of maximum emission from EUT was determined and the configuration was used to perform the final measurement.

Final Radiated Emission Measurement

1. Setup the configuration according to figure 1. Turn on EUT and make sure that it is in normal function.
2. For emission frequencies measured below 1GHz, a pre-scan is performed in a shielded chamber to determine the accurate frequencies of higher emissions will be checked on an open test site. As the same purpose, for emission frequencies measured above 1GHz, a pre-scan also be performed with a 1 meter measuring distance before final test.
3. For emission frequencies measured below and above 1GHz, set the spectrum analyzer on a 100kHz and 1MHz resolution bandwidth respectively for each frequency measured in step 2.
4. The search antenna is to be raised and lowered over a range from 1 to 4 meters in horizontally polarized orientation. Position the highness when the highest value is indicated on spectrum analyzer, then change the orientation of EUT on test table over a range from 0° to 360° with a speed as slow as possible, and keep the azimuth that highest emission is indicated on the spectrum analyzer. Vary the antenna position again and record the highest value as a final reading.
5. Repeat step 4 until all frequencies need to be measured was complete.
6. Repeat step 5 with search antenna in vertical polarized orientations.

During the radiated emission test, the Spectrum Analyzer was set with the following configurations:

Frequency Band (MHz)	Function	Resolution bandwidth	Video Bandwidth
30 to 1000	Peak	100kHz	100kHz
Above 1000	Peak	1MHz	1MHz
	Average	1MHz	10Hz

Sample Calculation Example

The field strength is calculated by adding the Antenna Factor and Cable Factor, and subtracting the Amplifier Gain (if any) from the measured reading. For the limit is employed average value, therefore the peak value can be transferred to average value by subtracting the duty factor. The basic equation with a sample calculation is as follows:

$$\text{Peak} = \text{Reading} + \text{Corrected Factor}$$

where

$$\text{Corr. Factor} = \text{Antenna Factor} + \text{Cable Factor} - \text{Amplifier Gain (if any)}$$

And the average value is

$$\text{Average} = \text{Peak Value} + \text{Duty Factor or}$$

$$\text{Set RBW} = 1\text{MHz, VBW} = 10\text{Hz.}$$

Note:

If the measured frequencies are fall in the restricted frequency band, the limit employed must be quasi peak value when frequencies are below or equal to 1GHz. And the measuring instrument is set to quasi peak detector function.



SIEMIC, INC.

Accessing global markets

Title: EMC Test Report for Game Trail Camera
Main Model: 18
Serial Model: N/A
To: FCC Part 15 Subpart B Class B: 2012 , ANSI C63.4:2009

Report No.: 12020601-FCC-E1
Issue Date: November 22, 2012
Page: 18 of 32
www.siemic.com

Annex B. EUT AND TEST SETUP PHOTOGRAPHS

Annex B.i. Photograph 1: EUT External Photo



EUT – Front View



EUT – Rear View



SIEMIC, INC.

Accessing global markets

Title: EMC Test Report for Game Trail Camera
Main Model: I8
Serial Model: N/A
To: FCC Part 15 Subpart B Class B: 2012 , ANSI C63.4:2009

Report No.: 12020601-FCC-E1
Issue Date: November 22, 2012
Page: 19 of 32
www.siemic.com



EUT – Top View



EUT – Bottom View



SIEMIC, INC.

Accessing global markets

Title: EMC Test Report for Game Trail Camera
Main Model: I8
Serial Model: N/A
To: FCC Part 15 Subpart B Class B: 2012 , ANSI C63.4:2009

Report No.: 12020601-FCC-E1
Issue Date: November 22, 2012
Page: 20 of 32
www.siemic.com



EUT – Left View



EUT – Right View

Annex B.ii. Photograph 2: EUT Internal Photo



EUT – Uncover View 1

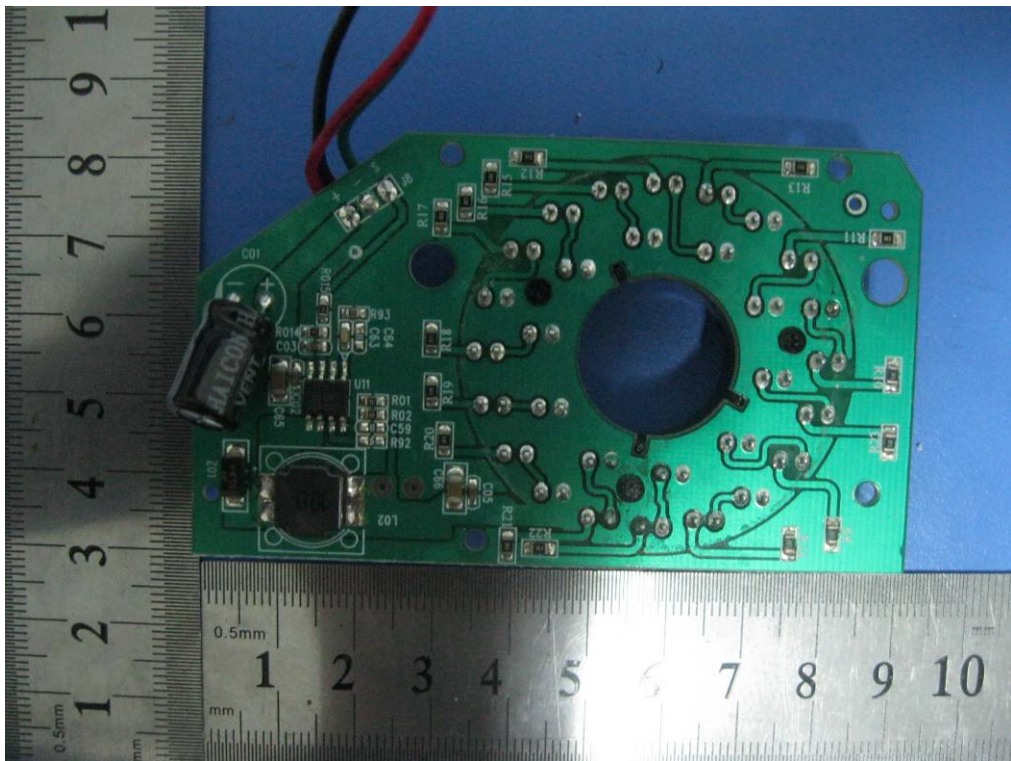

EUT – Uncover View 2

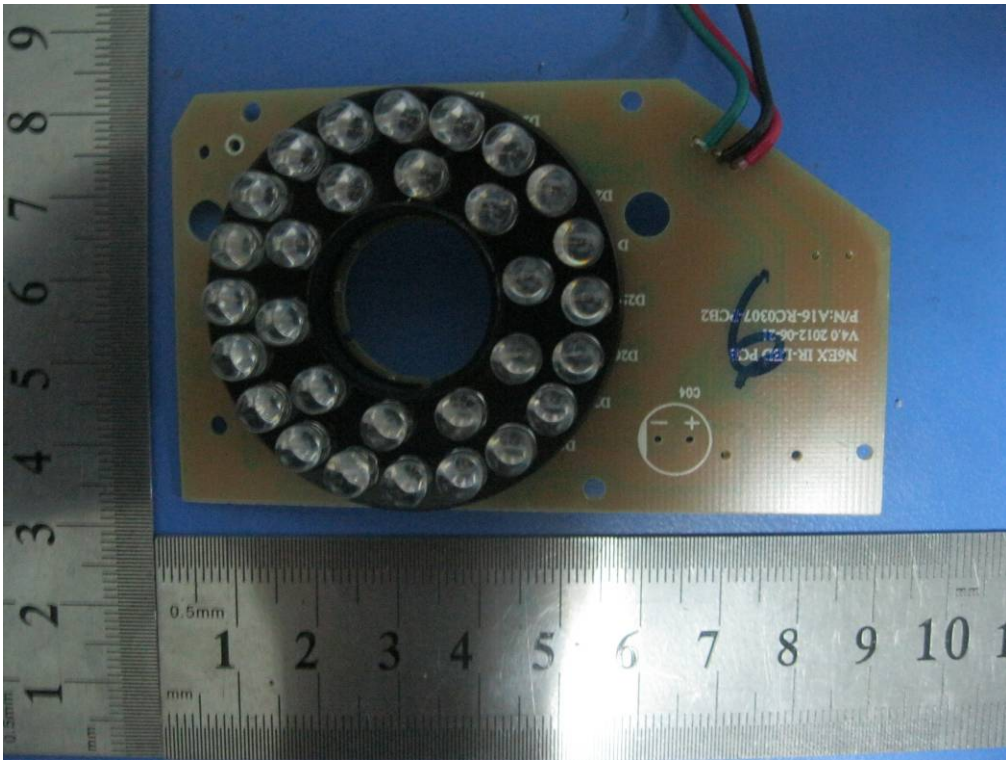

EUT – Uncover View 3

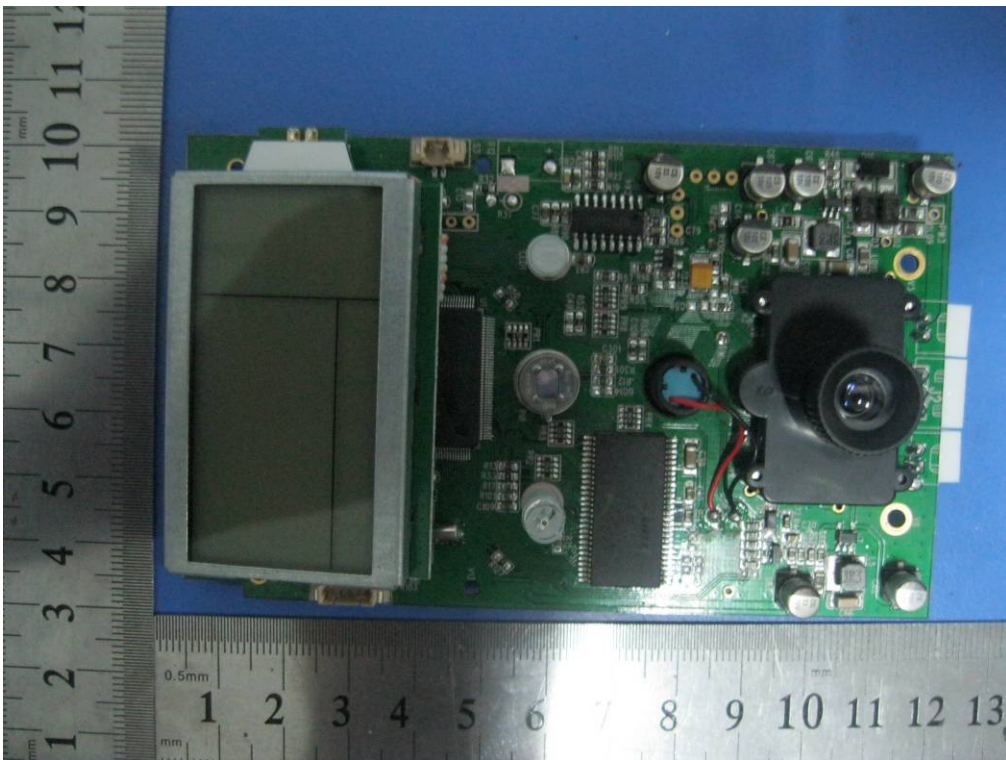

EUT – Main PCB Board View 1

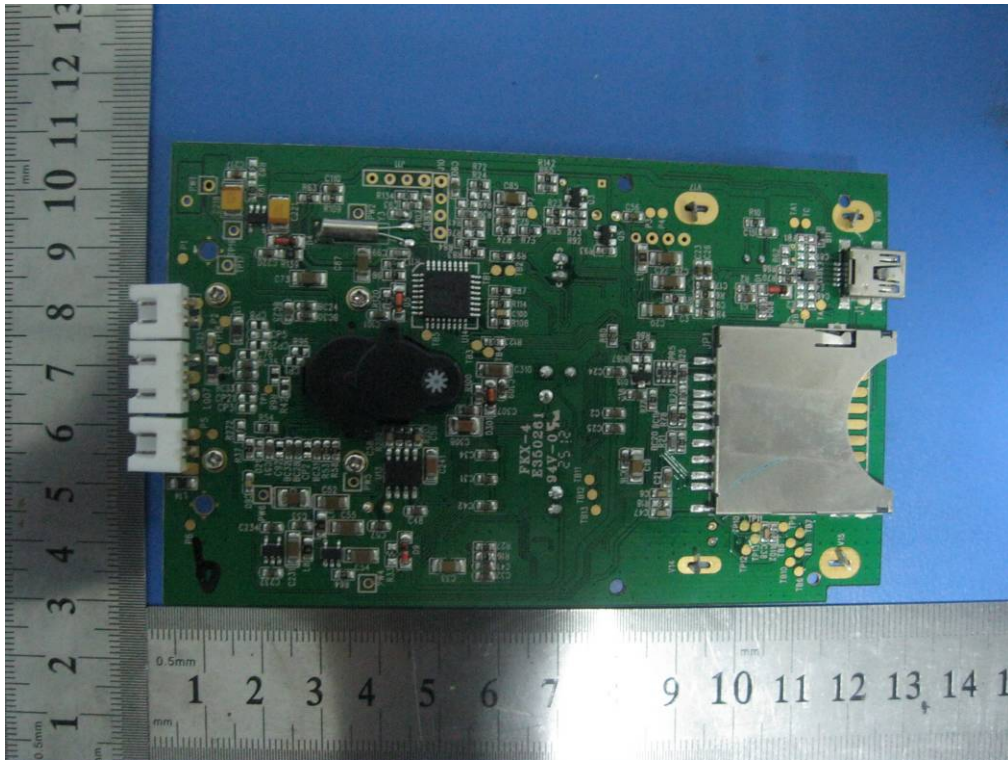

EUT – Main PCB Board View 2

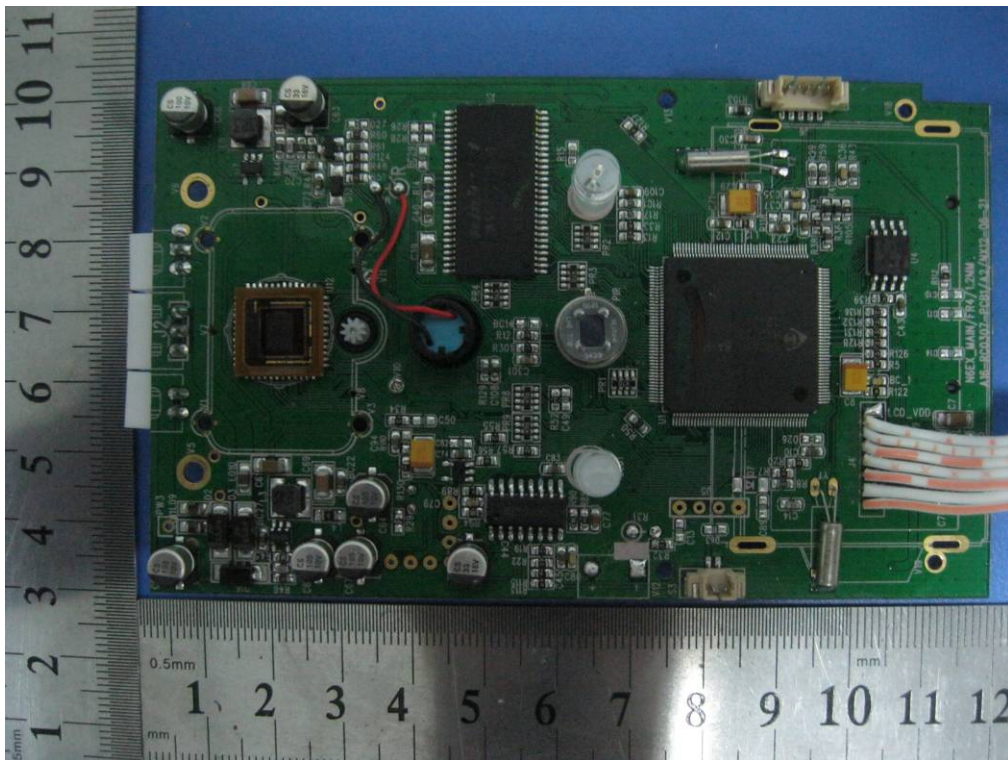

EUT – Main PCB Board View 3



SIEMIC, INC.

Accessing global markets

Title: EMC Test Report for Game Trail Camera
Main Model: I8
Serial Model: N/A
To: FCC Part 15 Subpart B Class B: 2012 , ANSI C63.4:2009

Report No.: 12020601-FCC-E1
Issue Date: November 22, 2012
Page: 24 of 32
www.siemic.com



LCD - Top View



LCD - Bottom View



SIEMIC, INC.

Accessing global markets

Title: EMC Test Report for Game Trail Camera
Main Model: I8
Serial Model: N/A
To: FCC Part 15 Subpart B Class B: 2012 , ANSI C63.4:2009

Report No.: 12020601-FCC-E1
Issue Date: November 22, 2012
Page: 25 of 32
www.siemic.com

Annex B.iii. Photograph 3: Test Setup Photo



Conducted Emissions Setup Front View



Conducted Emissions Setup Side View



SIEMIC, INC.

Accessing global markets

Title: EMC Test Report for Game Trail Camera
Main Model: I8
Serial Model: N/A
To: FCC Part 15 Subpart B Class B: 2012 , ANSI C63.4:2009

Report No.: 12020601-FCC-E1
Issue Date: November 22, 2012
Page: 26 of 32
www.siemic.com

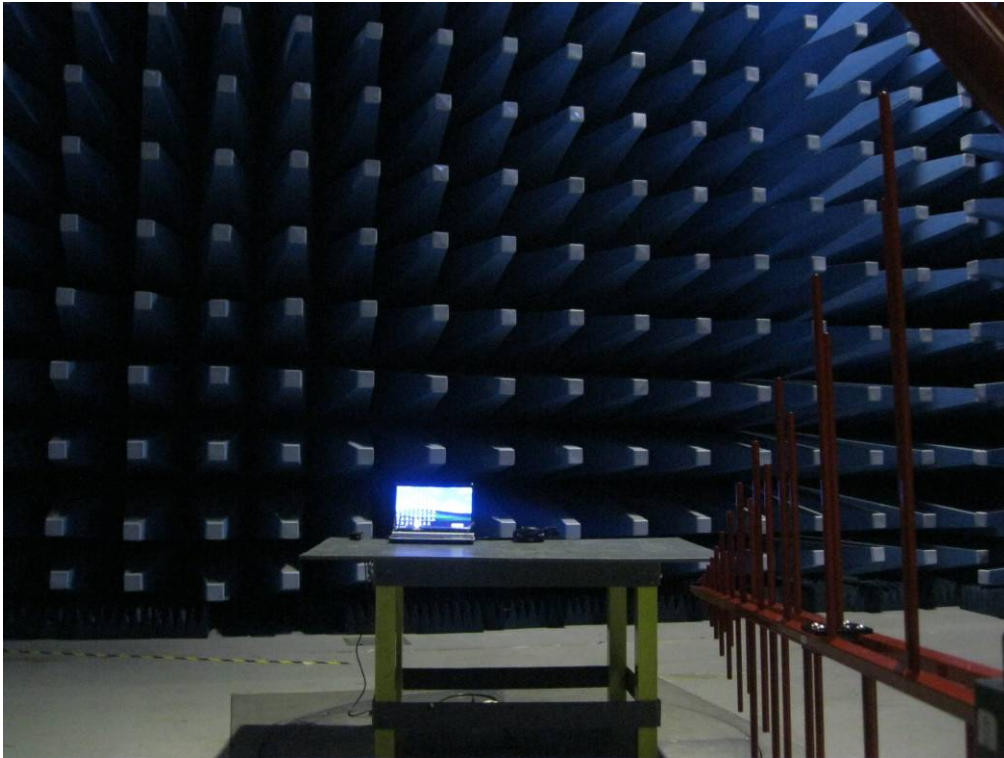

Radiated Emissions Setup Front View

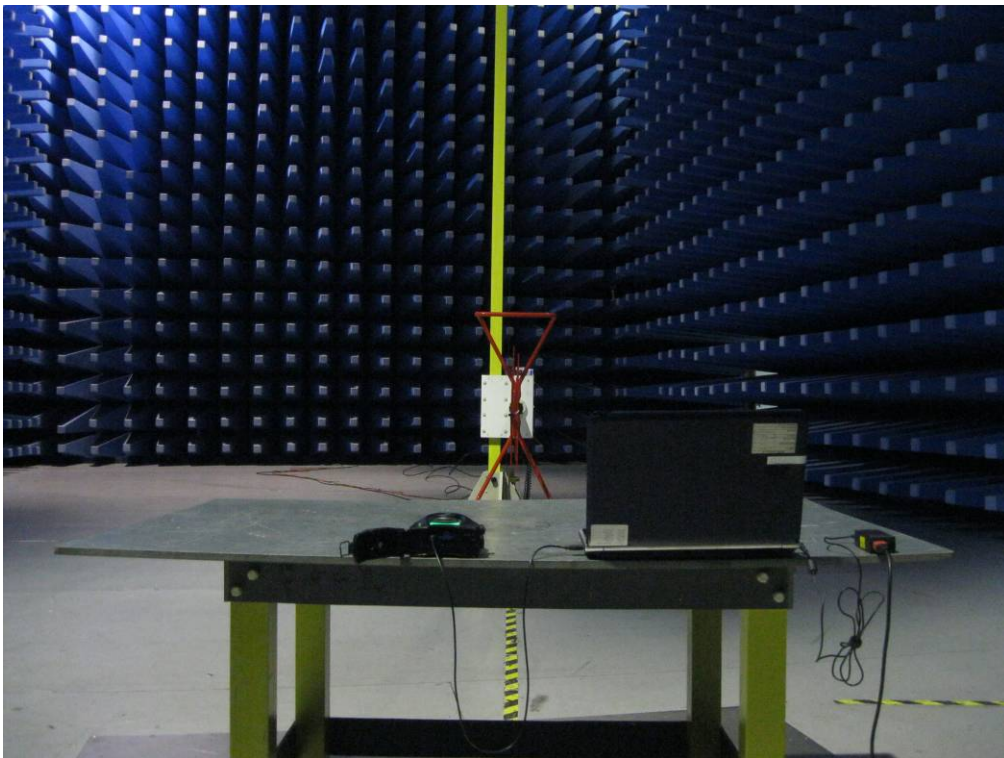

Radiated Emissions Setup Rear View



SIEMIC, INC.

Accessing global markets

Title: EMC Test Report for Game Trail Camera
Main Model: I8
Serial Model: N/A
To: FCC Part 15 Subpart B Class B: 2012 , ANSI C63.4:2009

Report No.: 12020601-FCC-E1
Issue Date: November 22, 2012
Page: 27 of 32
www.siemic.com

Annex C. TEST SETUP AND SUPPORTING EQUIPMENT

EUT TEST CONDITIONS

Annex C. i. SUPPORTING EQUIPMENT DESCRIPTION

The following is a description of supporting equipment and details of cables used with the EUT.

Equipment Description (Including Brand Name)	Model & Serial Number	Cable Description (List Length, Type & Purpose)
Gateway Laptop	MS2288 & LXWHF02013951C3CA92200	N/A



Block Configuration Diagram for Conducted Emissions

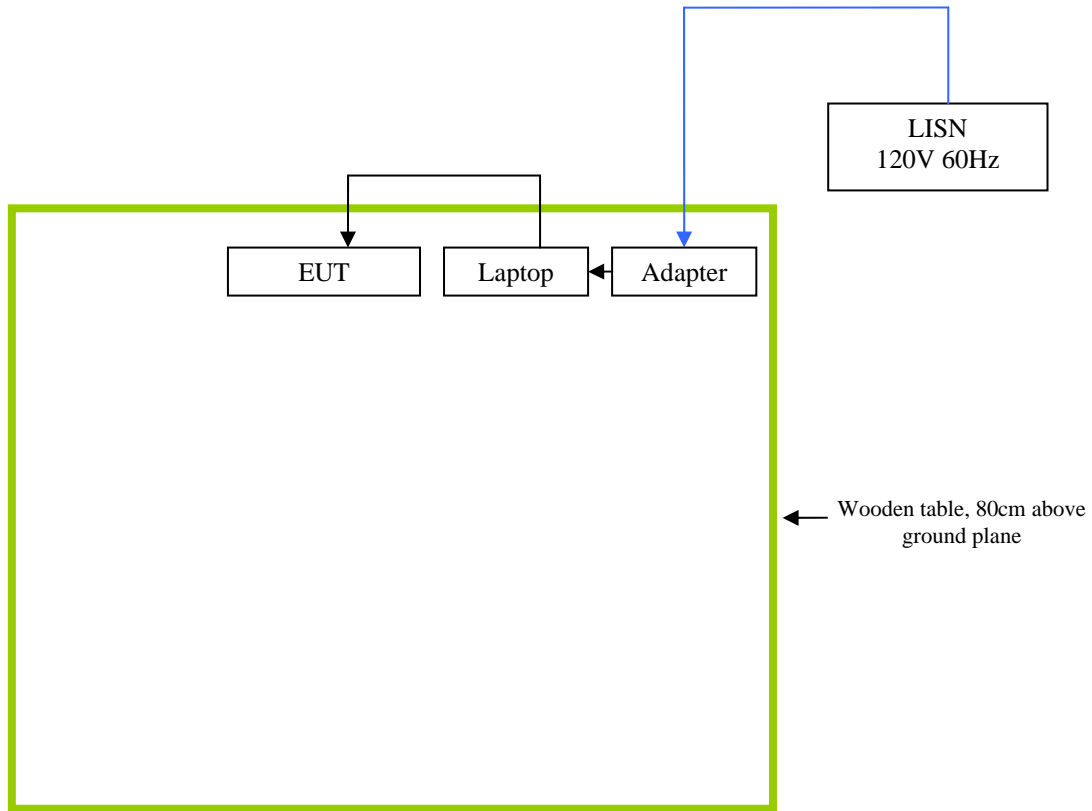



Block Configuration Diagram for Radiated Emissions

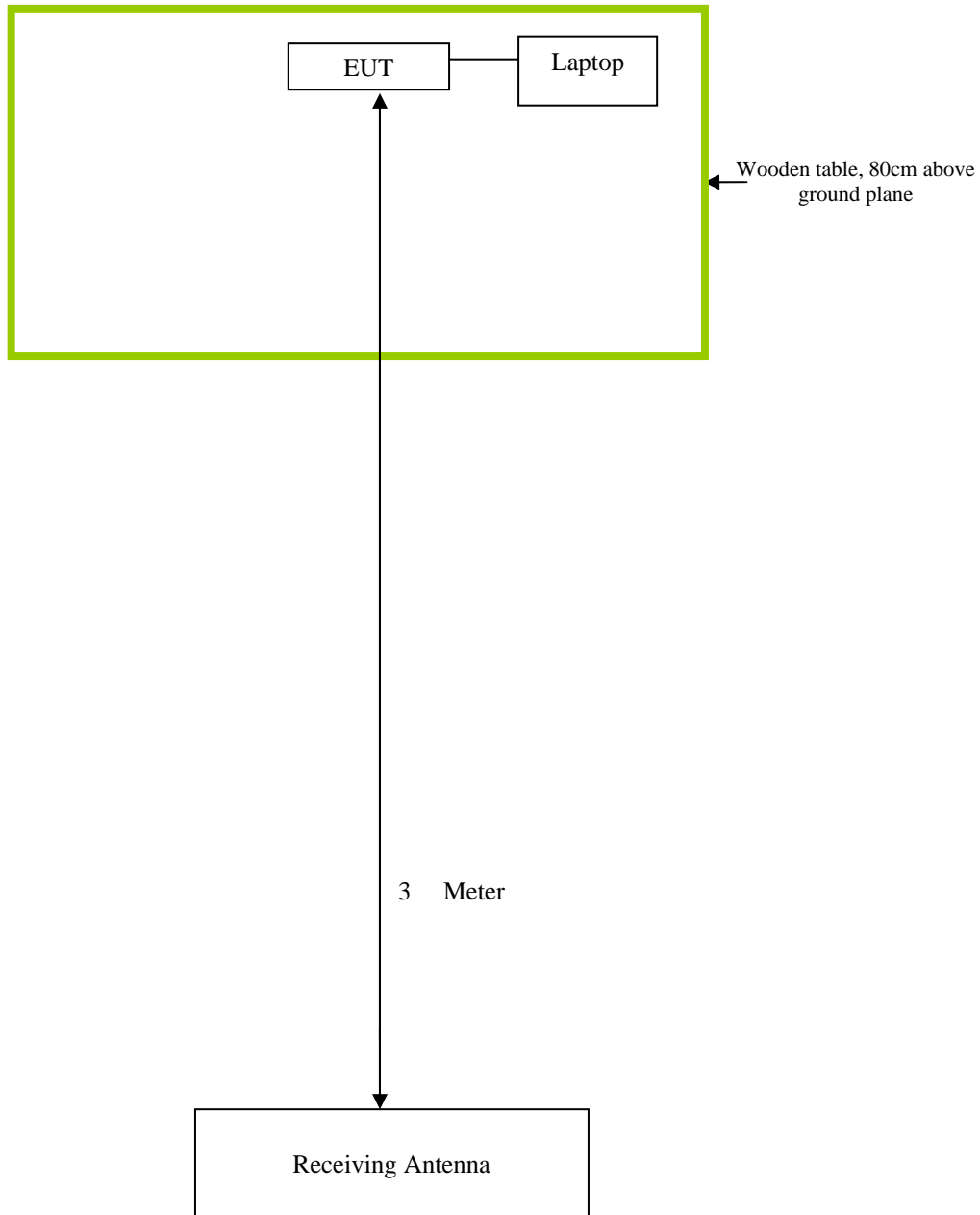



SIEMIC, INC.

Accessing global markets

Title: EMC Test Report for Game Trail Camera
Main Model: I8
Serial Model: N/A
To: FCC Part 15 Subpart B Class B: 2012 , ANSI C63.4:2009

Report No.: 12020601-FCC-E1
Issue Date: November 22, 2012
Page: 30 of 32
www.siemic.com

Annex C.ii. EUT OPERATING CONDITIONS

The following is the description of how the EUT is exercised during testing.

Test	Description Of Operation
Emissions	Transfer data



SIEMIC, INC.

Accessing global markets

Title: EMC Test Report for Game Trail Camera
Main Model: I8
Serial Model: N/A
To: FCC Part 15 Subpart B Class B: 2012 , ANSI C63.4:2009

Report No.: 12020601-FCC-E1
Issue Date: November 22, 2012
Page: 31 of 32
www.siemic.com

Annex D. USER MANUAL / BLOCK DIAGRAM / SCHEMATICS / PART LIST

Please see attachment



SIEMIC, INC.

Accessing global markets

Title: EMC Test Report for Game Trail Camera
Main Model: I8
Serial Model: N/A
To: FCC Part 15 Subpart B Class B: 2012 , ANSI C63.4:2009

Report No.: 12020601-FCC-E1
Issue Date: November 22, 2012
Page: 32 of 32
www.siemic.com

Annex E. DECLARATION OF SIMILARITY

Statement

I8 has the same design as N6EX. Its PCB layout and function are the same as N6EX, In order to meet customer requirement , now we cancel the N6EX and their SMU, change the model number from N serial to I serial. I8 is the same as the N6EX complete.

Company Name: WGI Innovations, Ltd.

Address: 602 Fountain Parkway Grand Prairie, TX 75050, U.S.A.

Tel: 18603012905

Contact Person & Position: Jin Tan, Manager of Quality, Louisz@synergyOD.com

Signature: